

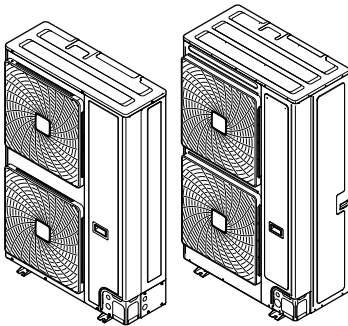

Installation and operation manual

VRV IV-S system air conditioner



RXYSQ8TMY1B

RXYSQ10TMY1B
RXYSQ12TMY1B

Installation and operation manual
VRV IV-S system air conditioner

English

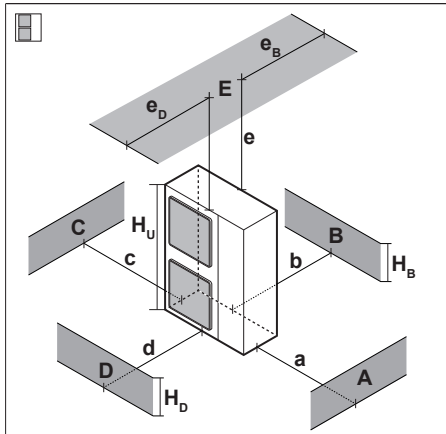

A~E	H _B H _D H _U	(mm)							
		a	b	c	d	e	e _B	e _D	
B	—		≥100						
A, B, C	—	≥100	≥100	≥100					
B, E	—		≥100			≥1000		≤500	
A, B, C, E	—	≥150	≥150	≥150		≥1000		≤500	
D	—				≥500				
D, E	—				≥1000	≥1000		≤500	
B, D	—		≥100		≥1000				
B, D, E	H _B < H _D	H _B ≤ ½ H _U	≥250		≥1000	≥1000		≤500	
		½ H _U < H _B ≤ H _U	≥250		≥1250	≥1000		≤500	
	H _B > H _D	H _D ≤ ½ H _U		≥100		≥1000	≥1000		≤500
		½ H _U < H _D ≤ H _U		≥200		≥1000	≥1000		≤500
	H _D > H _U		≥200		≥1700	≥1000		≤500	

1

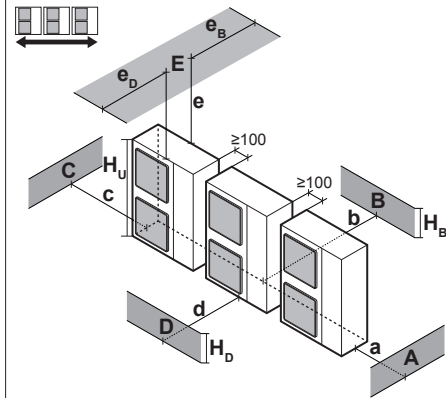

A, B, C	—	≥200	≥300	≥1000					
A, B, C, E	—	≥200	≥300	≥1000		≥1000		≤500	
D	—				≥1000				
D, E	—				≥1000	≥1000		≤500	
B, D	H _D > H _U		≥300		≥1000				
		H _D ≤ ½ H _U	≥250		≥1500				
		½ H _U < H _D ≤ H _U	≥300		≥1500				
B, D, E	H _B < H _D	H _B ≤ ½ H _U	≥300		≥1000	≥1000		≤500	
		½ H _U < H _B ≤ H _U	≥300		≥1250	≥1000		≤500	
	H _B > H _D	H _D ≤ ½ H _U		≥250		≥1500	≥1000		≤500
		½ H _U < H _D ≤ H _U		≥300		≥1500	≥1000		≤500
	H _D > H _U		≥300		≥2200	≥1000		≤500	

1+2

1

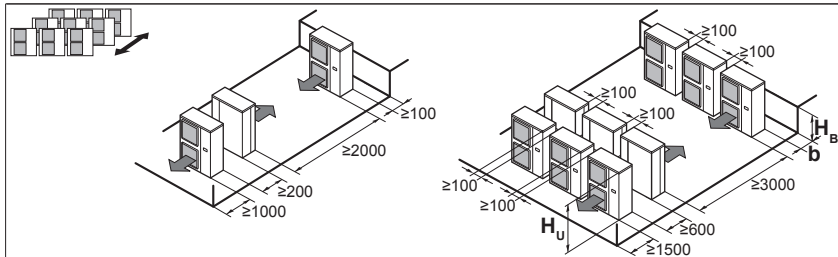

H _B H _U	b (mm)
H _B ≤ ½ H _U	b ≥ 250
½ H _U < H _B ≤ H _U	b ≥ 300
H _B > H _U	∅

2

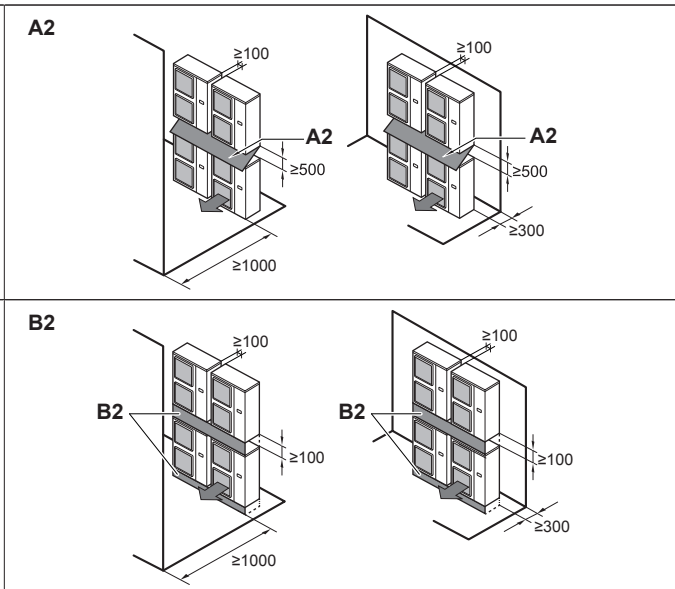
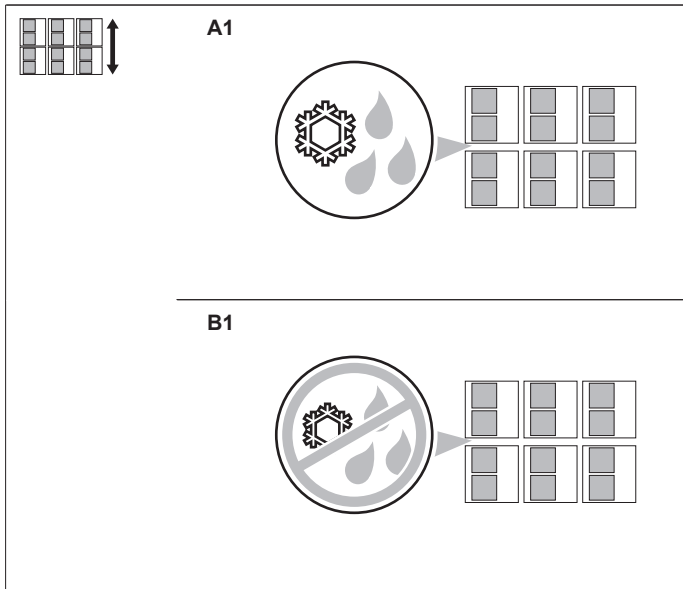

3

Table of Contents

1	About the documentation	6			
1.1	About this document.....	6			
For the installer			6		
2	About the box	6			
2.1	Outdoor unit.....	6			
2.1.1	To remove the accessories from the outdoor unit.....	6			
2.1.2	To remove the transportation stay.....	6			
3	About the units and options	7			
3.1	About the outdoor unit.....	7			
3.2	System layout.....	7			
4	Preparation	7			
4.1	Preparing installation site.....	7			
4.1.1	Installation site requirements of the outdoor unit.....	7			
4.1.2	Additional installation site requirements of the outdoor unit in cold climates.....	7			
4.2	Preparing refrigerant piping.....	7			
4.2.1	Refrigerant piping requirements.....	7			
4.2.2	Refrigerant piping material.....	7			
4.2.3	To select the piping size.....	8			
4.2.4	To select refrigerant branch kits.....	9			
4.3	Preparing electrical wiring.....	9			
4.3.1	Safety device requirements.....	9			
5	Installation	9			
5.1	Opening the units.....	9			
5.1.1	To open the outdoor unit.....	9			
5.2	Mounting the outdoor unit.....	9			
5.2.1	To provide the installation structure.....	9			
5.2.2	To install the outdoor unit.....	10			
5.2.3	To provide drainage.....	10			
5.2.4	To prevent the outdoor unit from falling over.....	10			
5.3	Connecting the refrigerant piping.....	11			
5.3.1	Using the stop valve and service port.....	11			
5.3.2	To remove the pinched pipes.....	11			
5.3.3	To connect the refrigerant piping to the outdoor unit.....	12			
5.4	Checking the refrigerant piping.....	13			
5.4.1	About checking the refrigerant piping.....	13			
5.4.2	Checking refrigerant piping: General guidelines.....	14			
5.4.3	Checking refrigerant piping: Setup.....	14			
5.4.4	To perform a leak test.....	14			
5.4.5	To perform vacuum drying.....	14			
5.5	To insulate the refrigerant piping.....	14			
5.6	Charging refrigerant.....	15			
5.6.1	Precautions when charging refrigerant.....	15			
5.6.2	To determine the additional refrigerant amount.....	15			
5.6.3	To charge refrigerant.....	15			
5.6.4	Error codes when charging refrigerant.....	16			
5.6.5	To fix the fluorinated greenhouse gases label.....	16			
5.7	Connecting the electrical wiring.....	17			
5.7.1	Field wiring: Overview.....	17			
5.7.2	Guidelines when knocking out knockout holes.....	17			
5.7.3	Guidelines when connecting the electrical wiring.....	17			
5.7.4	To connect the electrical wiring on the outdoor unit.....	17			
5.8	Finishing the outdoor unit installation.....	18			
5.8.1	To finish the transmission wiring.....	18			
6	Configuration	18			
6.1	Making field settings.....	19			
6.1.1	About making field settings.....	19			
6.1.2	To access the field setting components.....	19			
6.1.3	Field setting components.....	19			
6.1.4	To access mode 1 or 2.....	20			
6.1.5	To use mode 1.....	21			
6.1.6	To use mode 2.....	21			
6.1.7	Mode 1 (and default situation): Monitoring settings.....	21			
6.1.8	Mode 2: Field settings.....	23			
6.1.9	To connect the PC configurator to the outdoor unit.....	25			
7	Commissioning	25			
7.1	Precautions when commissioning.....	25			
7.2	Checklist before commissioning.....	26			
7.3	Checklist during commissioning.....	26			
7.3.1	About test run.....	26			
7.3.2	To perform a test run (7-LEDs display).....	26			
7.3.3	To perform a test run (7-segments display).....	27			
7.3.4	Correcting after abnormal completion of the test run.....	27			
7.3.5	Operating the unit.....	27			
8	Troubleshooting	27			
8.1	Solving problems based on error codes.....	27			
8.1.1	Error codes: Overview.....	28			
9	Technical data	30			
9.1	Service space: Outdoor unit.....	31			
9.2	Piping diagram: Outdoor unit.....	32			
9.3	Wiring diagram: Outdoor unit.....	33			
For the user			35		
10	About the system	35			
10.1	System layout.....	35			
11	User interface	35			
12	Operation	35			
12.1	Operation range.....	35			
12.2	Operating the system.....	36			
12.2.1	About operating the system.....	36			
12.2.2	About cooling, heating, fan only, and automatic operation.....	36			
12.2.3	About the heating operation.....	36			
12.2.4	To operate the system.....	36			
12.3	Using the dry program.....	36			
12.3.1	About the dry program.....	36			
12.3.2	To use the dry program.....	36			
12.4	Adjusting the air flow direction.....	36			
12.4.1	About the air flow flap.....	36			
12.5	Setting the master user interface.....	37			
12.5.1	About setting the master user interface.....	37			
12.5.2	To designate the master user interface (VRV DX).....	37			
12.5.3	To designate the master user interface (RA DX).....	37			
13	Maintenance and service	37			
13.1	About the refrigerant.....	37			
13.2	After-sales service and warranty.....	38			
13.2.1	Warranty period.....	38			
13.2.2	Recommended maintenance and inspection.....	38			
14	Troubleshooting	38			
14.1	Error codes: Overview.....	39			
14.2	Symptoms that are not air conditioner troubles.....	39			
14.2.1	Symptom: The system does not operate.....	40			
14.2.2	Symptom: Fan operation is possible, but cooling and heating do not work.....	40			
14.2.3	Symptom: The fan strength does not correspond to the setting.....	40			
14.2.4	Symptom: The fan direction does not correspond to the setting.....	40			
14.2.5	Symptom: White mist comes out of a unit (Indoor unit).....	40			
14.2.6	Symptom: White mist comes out of a unit (Indoor unit, outdoor unit).....	40			

1 About the documentation

14.2.7	Symptom: The user interface display reads "U4" or "U5" and stops, but then restarts after a few minutes.	40
14.2.8	Symptom: Noise of air conditioners (Indoor unit).....	40
14.2.9	Symptom: Noise of air conditioners (Indoor unit, outdoor unit).....	40
14.2.10	Symptom: Noise of air conditioners (Outdoor unit).....	40
14.2.11	Symptom: Dust comes out of the unit.....	40
14.2.12	Symptom: The units can give off odours.....	40
14.2.13	Symptom: The outdoor unit fan does not spin.....	40
14.2.14	Symptom: The display shows "88".....	40
14.2.15	Symptom: The compressor in the outdoor unit does not stop after a short heating operation.....	41
14.2.16	Symptom: The inside of an outdoor unit is warm even when the unit has stopped.....	41
14.2.17	Symptom: Hot air can be felt when the indoor unit is stopped.....	41

15 Relocation **41**

16 Disposal **41**

1 About the documentation

1.1 About this document

Target audience

Authorised installers + end users

INFORMATION

This appliance is intended to be used by expert or trained users in shops, in light industry and on farms, or for commercial use by lay persons.

Documentation set

This document is part of a documentation set. The complete set consists of:

- **General safety precautions:**
 - Safety instructions that you must read before installing
 - Format: Paper (in the box of the outdoor unit)
- **Outdoor unit installation and operation manual:**
 - Installation and operation instructions
 - Format: Paper (in the box of the outdoor unit)
- **Installer and user reference guide:**
 - Preparation of the installation, technical specifications, reference data,...
 - Detailed step-by-step instructions and background information for basic and advanced usage
 - Format: Digital files on <http://www.daikineurope.com/support-and-manuals/product-information/>

Latest revisions of the supplied documentation may be available on the regional Daikin website or via your dealer.

The original documentation is written in English. All other languages are translations.

For the installer

2 About the box

2.1 Outdoor unit

2.1.1 To remove the accessories from the outdoor unit

- 1 Remove the service cover. See "5.1.1 To open the outdoor unit" on page 9.
- 2 Remove the accessories.

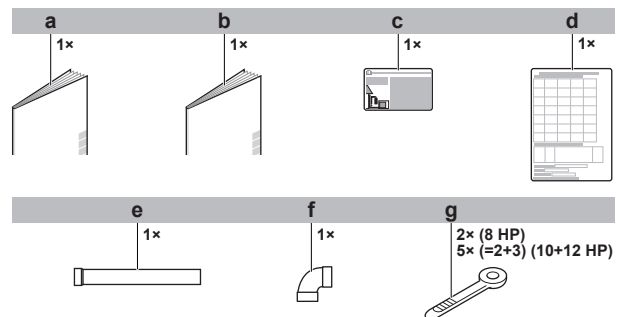
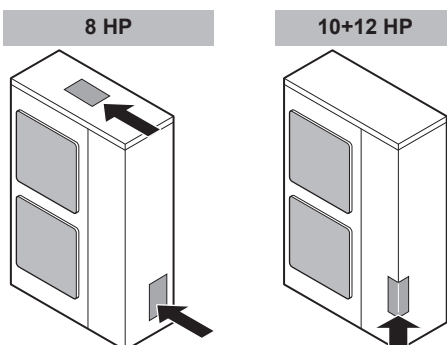

- a General safety precautions
- b Outdoor unit installation and operation manual
- c Fluorinated greenhouse gases label
- d Installation information sticker
- e Gas piping accessory 1 (8 HP: Ø19.1 mm; 10 HP: Ø22.2 mm; 12 HP: Ø25.4 mm)
- f Gas piping accessory 2 (8 HP: Ø19.1 mm; 10 HP: Ø22.2 mm; 12 HP: Ø25.4 mm)
- g Cable tie

2.1.2 To remove the transportation stay

Only for RXYSQ10+12.

NOTICE

If the unit is operated with the transportation stay attached, abnormal vibration or noise may be generated.

The transportation stay installed over the compressor leg for protecting the unit during transport must be removed. Proceed as shown in the figure and procedure below.

- 1 Slightly loosen the fixing nut (a).
- 2 Remove the transportation stay (b) as shown in the figure below.

- 3 Tighten the fixing nut (a) again.

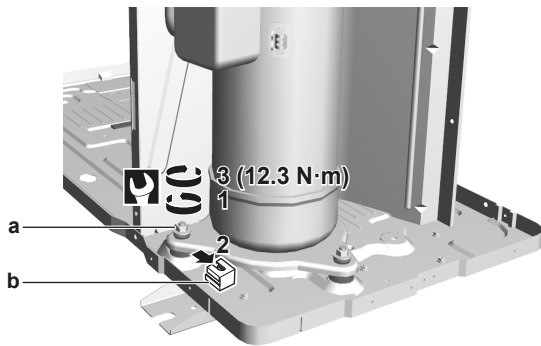

3 About the units and options

3.1 About the outdoor unit

This installation manual concerns the VRV IV-S, full inverter driven, heat pump system.

These units are intended for outdoor installation and aimed for air to air heat pump applications.

Specification		RXYSQ8~12
Capacity	Heating	25.0~37.5 kW
	Cooling	22.4~33.5 kW
Ambient design temperature	Heating	-20~15.5°C WB
	Cooling	-5~52°C DB

3.2 System layout



NOTICE

Design of the system must not be done at temperatures below -15°C.

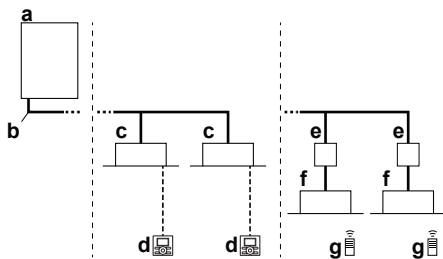

- a VRV IV-S Heat pump outdoor unit
- b Refrigerant piping
- c VRV direct expansion (DX) indoor unit
- d User interface (dedicated depending on indoor unit type)
- e BP box (required to connect Residential Air (RA) or Sky Air (SA) direct expansion (DX) indoor units)
- f Residential Air (RA) direct expansion (DX) indoor units
- g User interface (wireless, dedicated depending on indoor unit type)

4 Preparation

4.1 Preparing installation site

4.1.1 Installation site requirements of the outdoor unit

Mind the spacing guidelines. See the "Technical data" chapter, and the figures on the inside of the front cover.



NOTICE

This is a class A product. In a domestic environment this product may cause radio interference in which case the user may be required to take adequate measures.

4.1.2 Additional installation site requirements of the outdoor unit in cold climates



NOTICE

When operating the unit in heating in a low outdoor ambient temperature with high humidity conditions, make sure to take precautions to keep the drain holes of the unit free by using proper equipment.

In heating:

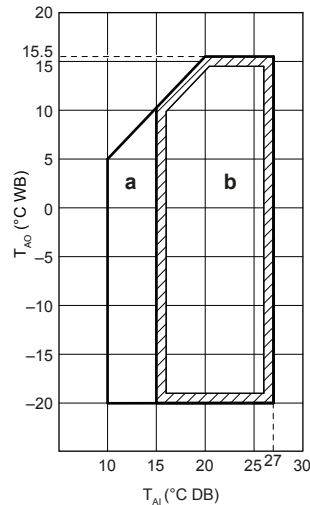

a Warming up operation range

b Operation range

T_{Ai} Ambient indoor temperature

T_{Ao} Ambient outdoor temperature

If the unit is selected to operate at ambient temperatures lower than -5°C for 5 days or longer, with relative humidity levels exceeding 95%, we recommend to apply a Daikin range specifically designed for such application and/or to contact your dealer for further advice.

4.2 Preparing refrigerant piping

4.2.1 Refrigerant piping requirements



NOTICE

Refrigerant R410A requires strict cautions for keeping the system clean and dry. Foreign materials (including mineral oils or moisture) should be prevented from getting mixed into the system.



NOTICE

The piping and other pressure-containing parts shall be suitable for refrigerant. Use phosphoric acid deoxidised seamless copper for refrigerant.

- Foreign materials inside pipes (including oils for fabrication) must be ≤ 30 mg/10 m.

4.2.2 Refrigerant piping material

- **Piping material:** Phosphoric acid deoxidised seamless copper.
- **Piping temper grade and thickness:**

4 Preparation

Outer diameter (Ø)	Temper grade	Thickness (t) ^(a)	
6.4 mm (1/4")	Annealed (O)	≥0.80 mm	
9.5 mm (3/8")			
12.7 mm (1/2")			
15.9 mm (5/8")	Annealed (O)	≥0.99 mm	
19.1 mm (3/4")	Half hard (1/2H)	≥0.80 mm	
22.2 mm (7/8")			
25.4 mm (1")	Half hard (1/2H)	≥0.88 mm	
28.6 mm (1-1/8")	Half hard (1/2H)	≥0.99 mm	

(a) Depending on the applicable legislation and the unit's maximum working pressure (see "PS High" on the unit name plate), larger piping thickness might be required.

4.2.3 To select the piping size

Determine the proper size referring to following tables and reference figure (only for indication).



INFORMATION

- Combination of VRV DX and RA DX indoor units is not allowed.
- Combination of RA DX and AHU indoor units is not allowed.
- Combination of RA DX and aircurtain indoor units is not allowed.



INFORMATION

In case of RXYSQ8: If you install RA DX indoor units, you have to configure field setting [2-41] (= type of installed indoor units). See "6.1.8 Mode 2: Field settings" on page 23.

In case of RXYSQ10+12: The type of indoor units is detected automatically.

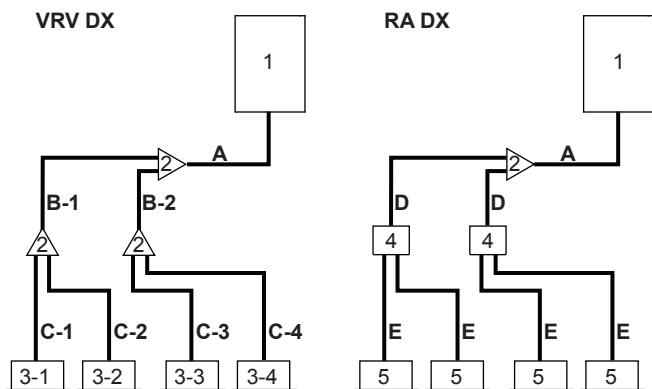

- 1 Outdoor unit
- 2 Refrigerant branch kits
- 3-1~3-4 VRV DX indoor units
- 4 BP units
- 5 RA DX indoor units
- A Piping between outdoor unit and (first) refrigerant branch kit
- B-1 B-2 Piping between refrigerant branch kits
- C-1~C-4 Piping between refrigerant branch kit and indoor unit
- D Piping between refrigerant branch kit and BP unit
- E Piping between BP unit and RA DX indoor unit

In case the required pipe sizes (inch sizes) are not available, it is also allowed to use other diameters (mm sizes), taken the following into account:

- Select the pipe size nearest to the required size.
- Use the suitable adapters for the change-over from inch to mm pipes (field supply).

- The additional refrigerant calculation has to be adjusted as mentioned in "5.6.2 To determine the additional refrigerant amount" on page 15.

A: Piping between outdoor unit and (first) refrigerant branch kit

When the equivalent pipe length between outdoor and indoor units is 90 m or more, the size of the main pipes (both gas side and liquid side) must be increased. Depending on the length of the piping, the capacity may drop, but even in such a case the size of the main pipes has to be increased. More specifications can be found in the technical engineering data book.

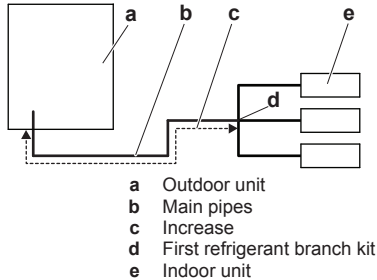

Outdoor unit capacity type (HP)	Piping outer diameter size (mm)			
	Gas pipe		Liquid pipe	
	Standard	Size-up	Standard	Size-up
8	19.1	22.2	9.5	12.7
10	22.2	25.4 ^(a)		
12	25.4 ^(b)	28.6	12.7	15.9

- (a) If size is NOT available, increase is NOT allowed.
- (b) If size is NOT available, increase to 28.6 mm is allowed.

B: Piping between refrigerant branch kits

Choose from the following table in accordance with the indoor unit total capacity type, connected downstream. Do not let the connection piping exceed the refrigerant piping size chosen by the general system model name.

Indoor unit capacity index	Piping outer diameter size (mm)	
	Gas pipe	Liquid pipe
<150	15.9	9.5
150≤x<200	19.1	
200≤x<290	22.2	
290≤x<390	28.6	12.7

Example: Downstream capacity for B-1 = capacity index of unit 3-1 + capacity index of unit 3-2

C: Piping between refrigerant branch kit and indoor unit

Use the same diameters as the connections (liquid, gas) on the indoor units. The diameters of the indoor units are as follows:

Indoor unit capacity index	Piping outer diameter size (mm)	
	Gas pipe	Liquid pipe
15~50	12.7	6.4
63~140	15.9	9.5
200	19.1	
250	22.2	

D: Piping between refrigerant branch kit and BP unit

Total capacity index of connected indoor units	Piping outer diameter size (mm)	
	Gas pipe	Liquid pipe
15~62	12.7	6.4
63~149	15.9	9.5
150~208	19.1	

E: Piping between BP unit and RA DX indoor unit

Indoor unit capacity index	Piping outer diameter size (mm)	
	Gas pipe	Liquid pipe
15~42	9.5	6.4
50		
60	15.9	9.5
71		

4.2.4 To select refrigerant branch kits

For piping example, refer to "4.2.3 To select the piping size" on page 8.

Refnet joint at first branch (counting from outdoor unit)

When using refnet joints at the first branch counted from the outdoor unit side, choose from the following table in accordance with the capacity of the outdoor unit. **Example:** Refnet joint A→B-1.

Outdoor unit capacity type (HP)	Refrigerant branch kit
8+10	KHRQ22M29T9
12	KHRQ22M64T

Refnet joints at other branches

For refnet joints other than the first branch, select the proper branch kit model based on the total capacity index of all indoor units connected after the refrigerant branch. **Example:** Refnet joint B-1→C-1.

Indoor unit capacity index	Refrigerant branch kit
<200	KHRQ22M20T
200≤x<290	KHRQ22M29T9
290≤x<390	KHRQ22M64T

Refnet headers

Concerning refnet headers, choose from the following table in accordance with the total capacity of all the indoor units connected below the refnet header.

Indoor unit capacity index	Refrigerant branch kit
<200	KHRQ22M29H
200≤x<290	
290≤x<390	KHRQ22M64H



INFORMATION

Maximum 8 branches can be connected to a header.

4.3 Preparing electrical wiring

4.3.1 Safety device requirements

The power supply must be protected with the required safety devices, i.e. a main switch, a slow blow fuse on each phase and an earth leakage protector in accordance with the applicable legislation.

Selection and sizing of the wiring should be done in accordance with the applicable legislation based on the information mentioned in the table below.

Model	Minimum circuit ampacity	Recommended fuses
RXYSQ8	18.5 A	25 A
RXYSQ10	22 A	25 A
RXYSQ12	24 A	32 A

For all models:

- Phase and frequency: 3N~ 50 Hz
- Voltage: 380-415 V
- Transmission line section:

Transmission wiring	Vinyl cords with 0.75 to 1.25 mm ² sheath or cables (2-core wires)
Maximum wiring length (= distance between outdoor and furthest indoor unit)	300 m
Total wiring length (= distance between outdoor and all indoors)	600 m

If the total transmission wiring exceeds these limits, it may result in communication error.

5 Installation

5.1 Opening the units

5.1.1 To open the outdoor unit



DANGER: RISK OF ELECTROCUTION



DANGER: RISK OF BURNING

8 HP

10+12 HP

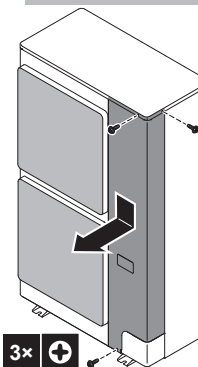
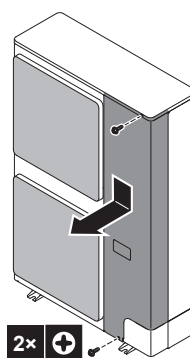

5.2 Mounting the outdoor unit

5.2.1 To provide the installation structure

Prepare 4 sets of anchor bolts, nuts and washers (field supply) as follows:

5 Installation

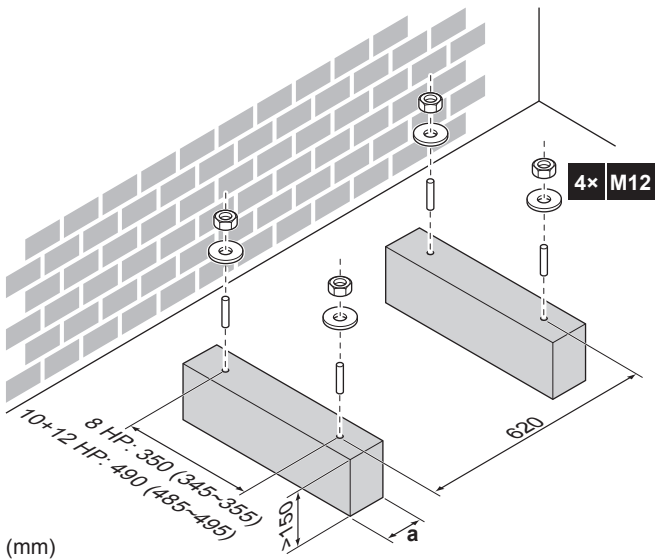

a Make sure not to cover the drain holes.

INFORMATION

The recommended height of the upper protruding part of the bolts is 20 mm.

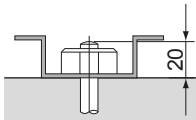

NOTICE

Fix the outdoor unit to the foundation bolts using nuts with resin washers (a). If the coating on the fastening area is stripped off, the nuts rust easily.



5.2.2 To install the outdoor unit

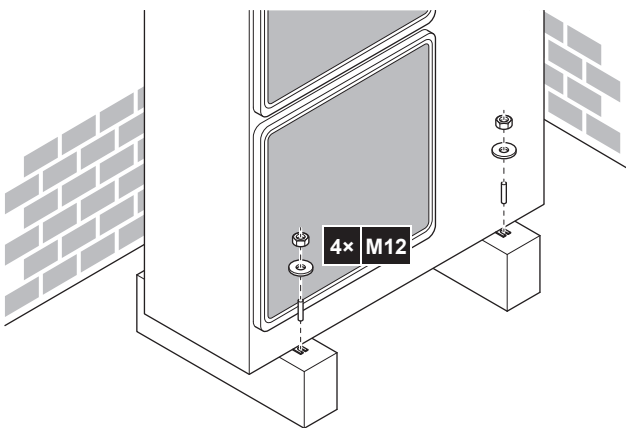

5.2.3 To provide drainage

- Make sure that condensation water can be evacuated properly.
- Install the unit on a base to make sure that there is a proper drainage in order to avoid ice accumulation.
- Prepare a water drainage channel around the foundation to drain waste water surrounding the unit.
- Avoid drain water flowing over the footpath, so that it does not become slippery in case of ambient freezing temperatures.

- If you install the unit on a frame, install a waterproof plate within 150 mm of the bottom side of the unit in order to prevent the invasion of water in the unit and to avoid the drain water dripping (see the following illustration).



NOTICE

If drain holes of the outdoor unit are covered by a mounting base or by floor surface, raise the unit to provide a free space of more than 150 mm under the outdoor unit.

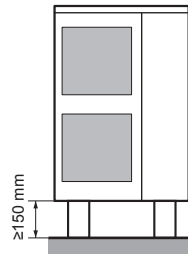

Drain holes (dimensions in mm)

Model	Bottom view (mm)
RXYSQ8	
RXYSQ10+12	

a Drain holes

5.2.4 To prevent the outdoor unit from falling over

- 1 Prepare 2 cables as indicated in the following illustration (field supply).
- 2 Place the 2 cables over the outdoor unit.
- 3 Insert a rubber sheet between the cables and the outdoor unit to prevent the cable from scratching the paint (field supply).
- 4 Attach the cable's ends. Tighten those ends.

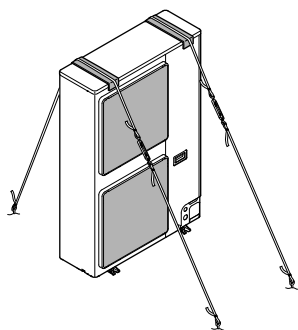

5.3 Connecting the refrigerant piping

⚠ DANGER: RISK OF BURNING

5.3.1 Using the stop valve and service port

To handle the stop valve

- Make sure to keep all stop valves open during operation.
- The stop valve is factory closed.

To open the stop valve

- 1 Remove the stop valve cover.
- 2 Insert a hexagon wrench into the stop valve and turn the stop valve counterclockwise.
- 3 When the stop valve cannot be turned any further, stop turning.

Result: The valve is now open.

To fully open the $\varnothing 19.1$ mm~ $\varnothing 25.4$ mm stop valve, turn the hexagonal wrench until a torque between 27 and 33 N·m is achieved.

Inadequate torque may cause leakage of refrigerant and breakage of the stop valve cap.

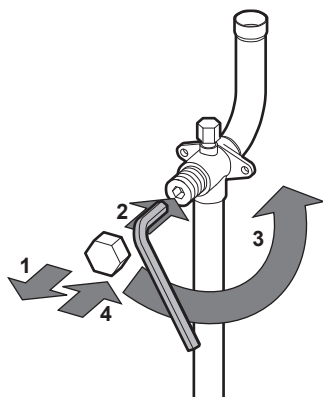

NOTICE

Pay attention that mentioned torque range is applicable for opening $\varnothing 19.1$ ~ $\varnothing 25.4$ mm stop valves only.

To close the stop valve

- 1 Remove the stop valve cover.
- 2 Insert a hexagon wrench into the stop valve and turn the stop valve clockwise.
- 3 When the stop valve cannot be turned any further, stop turning.

Result: The valve is now closed.

Closing direction:

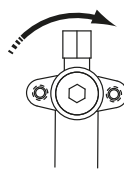

To handle the stop valve cover

- The stop valve cover is sealed where indicated by the arrow. Take care not to damage it.
- After handling the stop valve, make sure to tighten the stop valve cover securely. For the tightening torque, refer to the table below.
- Check for refrigerant leaks after tightening the stop valve cover.

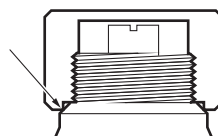

To handle the service port

- Always use a charge hose equipped with a valve depressor pin, since the service port is a Schrader type valve.
- After handling the service port, make sure to tighten the service port cover securely. For the tightening torque, refer to the table below.
- Check for refrigerant leaks after tightening the service port cover.

Tightening torques

Stop valve size (mm)	Tightening torque N·m (turn clockwise to close)			
	Shaft			
	Valve body	Hexagonal wrench	Cap (valve lid)	Service port
$\varnothing 9.5$	5.4~6.6	4 mm	13.5~16.5	11.5~13.9
$\varnothing 12.7$	8.1~9.9		18.0~22.0	
$\varnothing 19.1$	27.0~33.0	8 mm	22.5~27.5	
$\varnothing 25.4$				

5.3.2 To remove the pinched pipes



WARNING

Any gas or oil remaining inside the stop valve may blow off the pinched piping.

Failure to observe the instructions in procedure below properly may result in property damage or personal injury, which may be serious depending on the circumstances.

Use the following procedure to remove the pinched piping:

- 1 Remove the valve cover and make sure that the stop valves are fully closed.

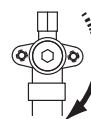
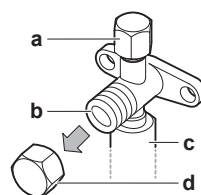

- a Service port and service port cover
- b Stop valve
- c Field piping connection
- d Stop valve cover

- 2 Connect the vacuuming/recovery unit through a manifold to the service port of all stop valves.

5 Installation

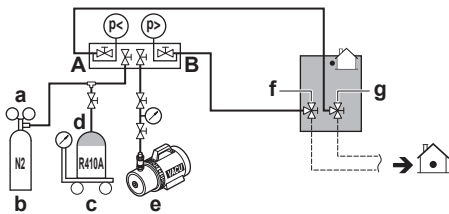

- a Pressure reducing valve
- b Nitrogen
- c Weighing scales
- d Refrigerant R410A tank (siphon system)
- e Vacuum pump
- f Liquid line stop valve
- g Gas line stop valve
- A Valve A
- B Valve B

- 3 Recover gas and oil from the pinched piping by using a recovery unit.

CAUTION

Do not vent gases into the atmosphere.

- 4 When all gas and oil is recovered from the pinched piping, disconnect the charge hose and close the service ports.
- 5 Cut off the lower part of the gas and liquid stop valve pipes along the black line. Use an appropriate tool (e.g. a pipe cutter, a pair of nippers).

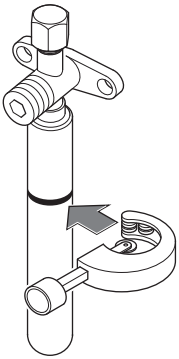

WARNING



Never remove the pinched piping by brazing.

Any gas or oil remaining inside the stop valve may blow off the pinched piping.

- 6 Wait until all oil is dripped out before continuing with the connection of the field piping in case the recovery was not complete.

5.3.3 To connect the refrigerant piping to the outdoor unit

NOTICE

Be sure that the field installed piping does not touch other pipes, the bottom panel or side panel. Especially for the bottom and side connection, be sure to protect the piping with suitable insulation, to prevent it from coming into contact with the casing.

- 1 Do the following:
 - Remove the service cover. See "5.1.1 To open the outdoor unit" on page 9.
 - Remove the piping intake plate (a) with screw (b).

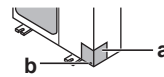

- 2 Choose a piping route (a, b, c or d).

8 HP

10+12 HP

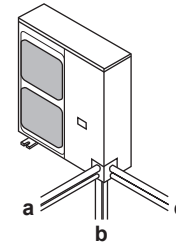
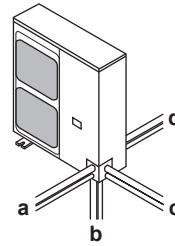

- 3 If you have chosen the downwards piping route:
 - Drill (a, 4×) and remove the knockout hole (b).
 - Cut out the slits (c) with a metal saw.

4× Ø6 mm

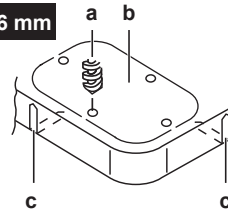

- 4 Do the following:
 - Connect the liquid pipe (a) to the liquid stop valve. (brazing)
 - Connect the gas pipe (b) to the gas stop valve. (brazing)

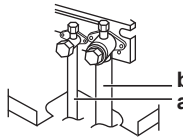

NOTICE

When brazing: First braze the liquid side piping, then the gas side piping. Enter the electrode from the front of the unit and the welding torch from the right side to braze with the flames facing outside and avoid the compressor sound insulation and other piping.

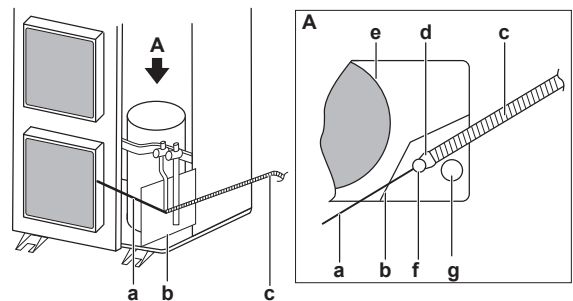

- a Electrode
- b Burning-resistant plate
- c Welding torch
- d Flames
- e Compressor sound insulation
- f Liquid side piping
- g Gas side piping

- Connect the gas piping accessories (c, d), and cut them to the required length (d1).

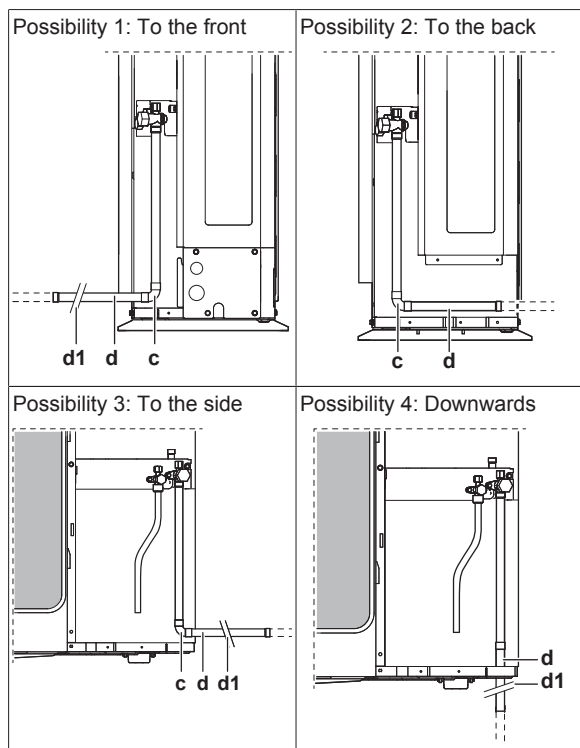

- 5 Reattach the service cover and the piping intake plate.
- 6 Seal all gaps (example: a) to prevent snow and small animals from entering the system.

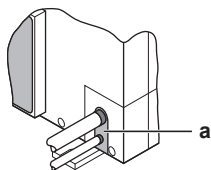

WARNING
 Provide adequate measures to prevent that the unit can be used as a shelter by small animals. Small animals that make contact with electrical parts can cause malfunctions, smoke or fire.

NOTICE
 Make sure to open the stop valves after installing the refrigerant piping and performing vacuum drying. Running the system with the stop valves closed may break the compressor.

5.4 Checking the refrigerant piping

5.4.1 About checking the refrigerant piping

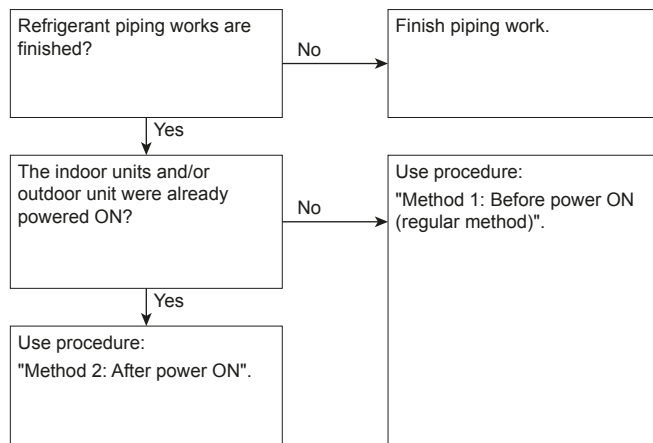

It is very important that all refrigerant piping work is done before the units (outdoor or indoor) are powered on.

When the units are powered on, the expansion valves will initialise. This means that they will close. Leak test and vacuum drying of field piping and indoor units is impossible when this happens.

Therefore, there will be explained 2 methods for initial installation, leak test and vacuum drying.

Method 1: Before power ON

If the system has not yet been powered on, no special action is required to perform the leak test and the vacuum drying.

Method 2: After power ON

If the system has already been powered on, activate setting [2-21] (refer to "6.1.4 To access mode 1 or 2" on page 20). This setting will open field expansion valves to guarantee a R410A piping pathway and make it possible to perform the leak test and the vacuum drying.

NOTICE
 Make sure that all indoor units connected to the outdoor unit are powered on.

NOTICE
 Wait until the outdoor unit has finished the initialisation to apply setting [2-21].

Leak test and vacuum drying

Checking the refrigerant piping involves:

- Checking for any leakages in the refrigerant piping.
- Performing vacuum drying to remove all moisture, air or nitrogen in the refrigerant piping.

If there is a possibility of moisture being present in the refrigerant piping (for example, water may have entered the piping), first carry out the vacuum drying procedure below until all moisture has been removed.

All piping inside the unit has been factory tested for leaks.

Only field installed refrigerant piping needs to be checked. Therefore, make sure that all the outdoor unit stop valves are firmly closed before performing leak test or vacuum drying.

NOTICE
 Make sure that all (field supplied) field piping valves are OPEN (not outdoor unit stop valves!) before you start leak test and vacuuming.

5 Installation

For more information on the state of the valves, refer to "5.4.3 Checking refrigerant piping: Setup" on page 14.

5.4.2 Checking refrigerant piping: General guidelines

Connect the vacuum pump through a manifold to the service port of all stop valves to increase efficiency (refer to "5.4.3 Checking refrigerant piping: Setup" on page 14).



NOTICE

Use a 2-stage vacuum pump with a non-return valve or a solenoid valve that can evacuate to a gauge pressure of -100.7 kPa (5 Torr absolute).



NOTICE

Make sure the pump oil does not flow oppositely into the system while the pump is not working.



NOTICE

Do not purge the air with refrigerants. Use a vacuum pump to evacuate the installation.

5.4.3 Checking refrigerant piping: Setup

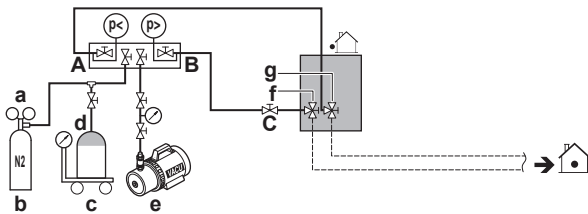

- a Pressure reducing valve
- b Nitrogen
- c Weighing scales
- d Refrigerant R410A tank (siphon system)
- e Vacuum pump
- f Liquid line stop valve
- g Gas line stop valve
- A Valve A
- B Valve B
- C Valve C

Valve	State of valve
Valve A	Open
Valve B	Open
Valve C	Open
Liquid line stop valve	Close
Gas line stop valve	Close



NOTICE

The connections to the indoor units and all indoor units should also be leak and vacuum tested. Keep any possible (field supplied) field piping valves open as well.

Refer to the indoor unit installation manual for more details. Leak test and vacuum drying should be done before the power supply is set to the unit. If not, see also the flow chart earlier described in this chapter (see "5.4.1 About checking the refrigerant piping" on page 13).

5.4.4 To perform a leak test

The leak test must satisfy the specifications of EN378-2.

To check for leaks: Vacuum leak test

- 1 Evacuate the system from the liquid and gas piping to -100.7 kPa (-1.007 bar/5 Torr) for more than 2 hours.
- 2 Once reached, turn off the vacuum pump and check that the pressure does not rise for at least 1 minute.

- 3 Should the pressure rise, the system may either contain moisture (see vacuum drying below) or have leaks.

To check for leaks: Pressure leak test

- 1 Break the vacuum by pressurising with nitrogen gas to a minimum gauge pressure of 0.2 MPa (2 bar). Never set the gauge pressure higher than the maximum operation pressure of the unit, i.e. 4.0 MPa (40 bar).
- 2 Test for leaks by applying a bubble test solution to all piping connections.
- 3 Discharge all nitrogen gas.



NOTICE

Make sure to use a recommended bubble test solution from your wholesaler. Do not use soap water, which may cause cracking of flare nuts (soap water may contain salt, which absorbs moisture that will freeze when the piping gets cold), and/or lead to corrosion of flared joints (soap water may contain ammonia which causes a corrosive effect between the brass flare nut and the copper flare).

5.4.5 To perform vacuum drying

To remove all moisture from the system, proceed as follows:

- 1 Evacuate the system for at least 2 hours to a target vacuum of -100.7 kPa (-1.007 bar/5 Torr).
- 2 Check that, with the vacuum pump turned off, the target vacuum is maintained for at least 1 hour.
- 3 Should you fail to reach the target vacuum within 2 hours or maintain the vacuum for 1 hour, the system may contain too much moisture. In that case, break the vacuum by pressurising with nitrogen gas to a gauge pressure of 0.05 MPa (0.5 bar) and repeat steps 1 to 3 until all moisture has been removed.
- 4 Depending on whether you want to immediately charge refrigerant through the refrigerant charge port or first pre-charge a portion of refrigerant through the liquid line, either open the outdoor unit stop valves, or keep them closed. See "5.6.3 To charge refrigerant" on page 15 for more information.

5.5 To insulate the refrigerant piping

After finishing the leak test and vacuum drying, the piping must be insulated. Take into account the following points:

- Make sure to insulate the connection piping and refrigerant branch kits entirely.
- Be sure to insulate the liquid and gas piping (for all units).
- Use heat resistant polyethylene foam which can withstand a temperature of 70°C for liquid piping and polyethylene foam which can withstand a temperature of 120°C for gas piping.
- Reinforce the insulation on the refrigerant piping according to the installation environment.

Ambient temperature	Humidity	Minimum thickness
$\leq 30^{\circ}\text{C}$	75% to 80% RH	15 mm
$> 30^{\circ}\text{C}$	$\geq 80\%$ RH	20 mm

Condensation might form on the surface of the insulation.

- If there is a possibility that condensation on the stop valve might drip down into the indoor unit through gaps in the insulation and piping because the outdoor unit is located higher than the indoor unit, this must be prevented by sealing up the connections. See below figure.

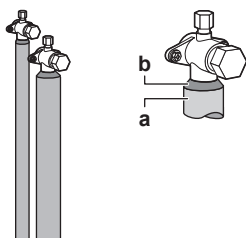

- a Insulation material
b Caulking etc.

5.6 Charging refrigerant

5.6.1 Precautions when charging refrigerant



WARNING

- Only use R410A as refrigerant. Other substances may cause explosions and accidents.
- R410A contains fluorinated greenhouse gases. Its global warming potential (GWP) value is 2087.5. Do NOT vent these gases into the atmosphere.
- When charging refrigerant, always use protective gloves and safety glasses.



NOTICE

If the power of some units is turned off, the charging procedure cannot be finished properly.



NOTICE

Be sure to turn on the power 6 hours before operation in order to have power running to the crankcase heater and to protect the compressor.



NOTICE

If operation is performed within 12 minutes after the indoor and outdoor units are turned on, the compressor will not operate before the communication is established in a correct way between outdoor unit(s) and indoor units.



NOTICE

Before starting charging procedures:

- In case of RXYSQ8: Check if the 7-LEDs display is as normal (see "6.1.4 To access mode 1 or 2" on page 20), and there is no malfunction code on the user interface of the indoor unit. If a malfunction code is present, see "8.1 Solving problems based on error codes" on page 27.
- In case of RXYSQ10+12: Check if the 7-segment display indication of the outdoor unit A1P PCB is as normal (see "6.1.4 To access mode 1 or 2" on page 20). If a malfunction code is present, see "8.1 Solving problems based on error codes" on page 27.



NOTICE

Make sure all connected indoor units are recognised (in case of RXYSQ8: setting [1-5]; in case of RXYSQ10+12: setting [1-10]).



NOTICE

Close the front panel before any refrigerant charge operation is executed. Without the front panel attached the unit cannot judge correctly whether it is operating properly or not.



NOTICE

In case of maintenance and the system (outdoor unit+field piping+indoor units) does not contain any refrigerant any more (e.g., after refrigerant reclaim operation), the unit has to be charged with its original amount of refrigerant (refer to the nameplate on the unit) and the determined additional refrigerant amount.

5.6.2 To determine the additional refrigerant amount



INFORMATION

For final charge adjustment in a test laboratory, contact your dealer.

Additional refrigerant to be charged=R (kg). R should be rounded off in units of 0.1 kg.

$$R=[(X_1 \times \text{Ø}15.9) \times 0.18 + (X_2 \times \text{Ø}12.7) \times 0.12 + (X_3 \times \text{Ø}9.5) \times 0.059 + (X_4 \times \text{Ø}6.4) \times 0.022]$$

$X_{1...4}$ = Total length (m) of liquid piping size at Øa



INFORMATION

Piping length is considered the distance from the outdoor unit to the farthest indoor unit.

When using metric piping, please take into account following table concerning the weight factor to be allocated. It should be substituted in the formula for R.

Inch piping		Metric piping	
Size (Ø) (mm)	Weight factor	Size (Ø) (mm)	Weight factor
6.4	0.022	6	0.018
9.5	0.059	10	0.065
12.7	0.12	12	0.097
15.9	0.18	15	0.16

5.6.3 To charge refrigerant

To speed up the refrigerant charging process, it is in case of larger systems recommended to first pre-charge a portion of refrigerant through the liquid line before proceeding with the manual charging. It can be skipped, but charging will take longer then.

Pre-charging refrigerant

Pre-charging can be done without compressor operation, by connecting the refrigerant bottle to the service port of the liquid stop valve.

- Connect as shown. Make sure that all outdoor unit stop valves, as well as valve A are closed.

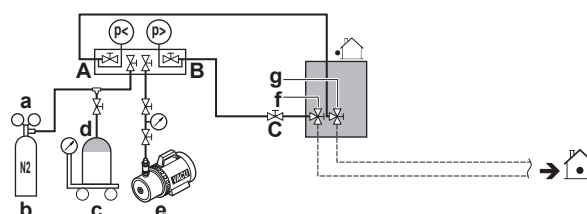

- a Pressure reducing valve
b Nitrogen
c Weighing scales
d Refrigerant R410A tank (siphon system)
e Vacuum pump
f Liquid line stop valve
g Gas line stop valve
A Valve A
B Valve B
C Valve C

- Open valves C and B.

5 Installation

- Pre-charge refrigerant until the determined additional refrigerant amount is reached or pre-charging is not possible anymore, and then close valves C and B.
- Do one of the following:

If	Then
The determined additional refrigerant amount is reached	Disconnect the manifold from the liquid line. You do not have to perform the "Charging refrigerant (in manual additional refrigerant charge mode)" instructions.
Too much refrigerant is charged	Recover refrigerant. Disconnect the manifold from the liquid line. You do not have to perform the "Charging refrigerant (in manual additional refrigerant charge mode)" instructions.
The determined additional refrigerant amount is not reached yet	Disconnect the manifold from the liquid line. Continue with the "Charging refrigerant (in manual additional refrigerant charge mode)" instructions.

Charging refrigerant (in manual additional refrigerant charge mode)

The remaining additional refrigerant charge can be charged by operating the outdoor unit by means of the manual additional refrigerant charge mode.

- Connect as shown. Make sure valve A is closed.

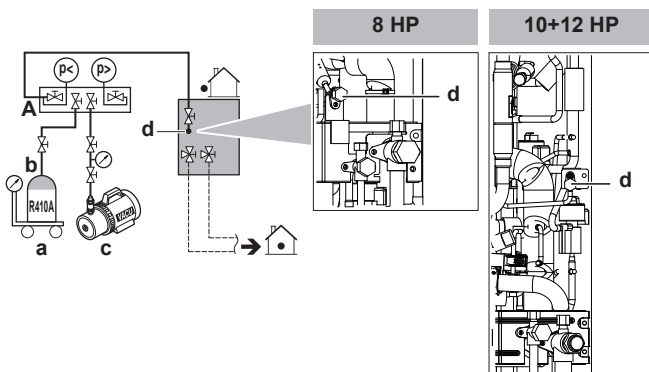

- a Weighing scales
- b Refrigerant R410A tank (siphon system)
- c Vacuum pump
- d Refrigerant charge port
- A Valve A

NOTICE

The refrigerant charging port is connected to the piping inside the unit. The unit's internal piping is already factory charged with refrigerant, so be careful when connecting the charge hose.

- Open all outdoor unit stop valves. At this point, valve A must remain closed!
- Take all the precautions mentioned in "6 Configuration" on page 18 and "7 Commissioning" on page 25 into account.
- Turn on the power of the indoor units and outdoor unit.
- Activate setting [2-20] to start the manual additional refrigerant charge mode. For details, see "6.1.8 Mode 2: Field settings" on page 23.

Result: The unit will start operation.

INFORMATION

The manual refrigerant charge operation will automatically stop within 30 minutes. If charging is not completed after 30 minutes, perform the additional refrigerant charging operation again.

INFORMATION

- When a malfunction is detected during the procedure (e.g., in case of closed stop valve), a malfunction code will be displayed. In that case, refer to "5.6.4 Error codes when charging refrigerant" on page 16 and solve the malfunction accordingly. Resetting the malfunction can be done by pushing BS3. You can restart the "Charging" instructions.
- Aborting the manual refrigerant charge is possible by pushing BS3. The unit will stop and return to idle condition.

- Open valve A.

- Charge refrigerant until the remaining determined additional refrigerant amount is added, and then close valve A.

- Press BS3 to stop the manual additional refrigerant charge mode.

NOTICE

Make sure to open all stop valves after (pre-) charging the refrigerant.

Operating with the stop valves closed will damage the compressor.

NOTICE

After adding the refrigerant, do not forget to close the lid of the refrigerant charging port. The tightening torque for the lid is 11.5 to 13.9 N·m.

5.6.4 Error codes when charging refrigerant

INFORMATION

If a malfunction occurs:

- In case of RXYSQ8: The error code is displayed on the user interface of the indoor unit.
- In case of RXYSQ10+12: The error code is displayed on the outdoor unit's 7-segments display and on the user interface of the indoor unit.

If a malfunction occurs, close valve A immediately. Confirm the malfunction code and take corresponding action, "8.1 Solving problems based on error codes" on page 27.

5.6.5 To fix the fluorinated greenhouse gases label

- Fill in the label as follows:

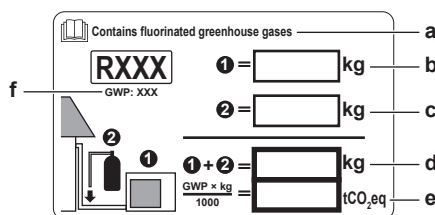

- If a multilingual fluorinated greenhouse gases label is delivered with the unit (see accessories), peel off the applicable language and stick it on top of a.
- Factory refrigerant charge: see unit name plate
- Additional refrigerant amount charged
- Total refrigerant charge
- Greenhouse gas emissions** of the total refrigerant charge expressed as tonnes CO₂-equivalent

f GWP = Global warming potential



NOTICE

In Europe, the **greenhouse gas emissions** of the total refrigerant charge in the system (expressed as tonnes CO₂-equivalent) is used to determine the maintenance intervals. Follow the applicable legislation.

Formula to calculate the greenhouse gas emissions:
 GWP value of the refrigerant × Total refrigerant charge [in kg] / 1000

- Fix the label on the inside of the outdoor unit. There is a dedicated place for it on the wiring diagram label.

5.7 Connecting the electrical wiring

5.7.1 Field wiring: Overview

Field wiring consists of power supply (always including earth) and indoor-outdoor communication (= transmission) wiring.

Example:

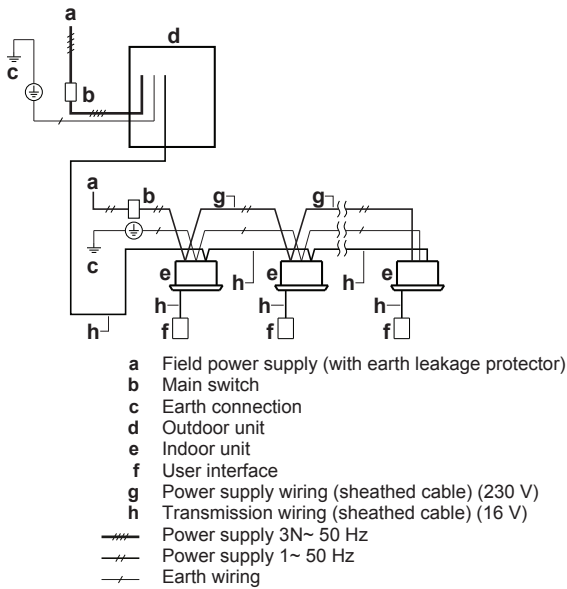

5.7.2 Guidelines when knocking out knockout holes



NOTICE

Precautions when making knockout holes:

- Avoid damaging the casing.
- After making the knockout holes, we recommend you remove the burrs and paint the edges and areas around the edges using repair paint to prevent rusting.
- When passing electrical wiring through the knockout holes, wrap the wiring with protective tape to prevent damage.

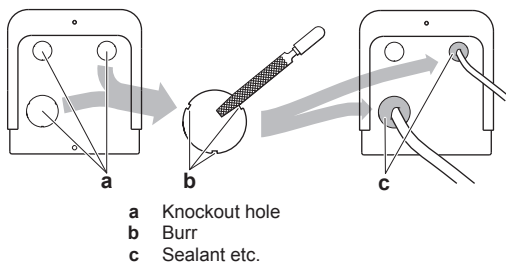

5.7.3 Guidelines when connecting the electrical wiring

Tightening torques

In case of RXYSQ8:

Wiring	Screw size	Tightening torque (N•m)
Power supply wiring (power supply + shielded ground)	M5	2.2~2.7
Transmission wiring	M3	0.8~0.97

In case of RXYSQ10+12:

Wiring	Screw size	Tightening torque (N•m)
Power supply wiring (power supply + shielded ground)	M8	5.5~7.3
Transmission wiring	M3.5	0.8~0.97

5.7.4 To connect the electrical wiring on the outdoor unit



NOTICE

- Follow the wiring diagram (delivered with the unit, located at the inside of the service cover).
- Make sure the electrical wiring does NOT obstruct proper reattachment of the service cover.

- Remove the service cover.
- Connect the transmission wiring as follows:

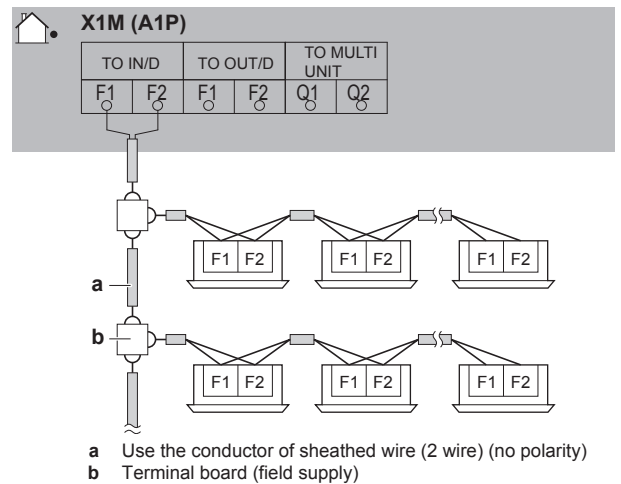

- Connect the power supply as follows:

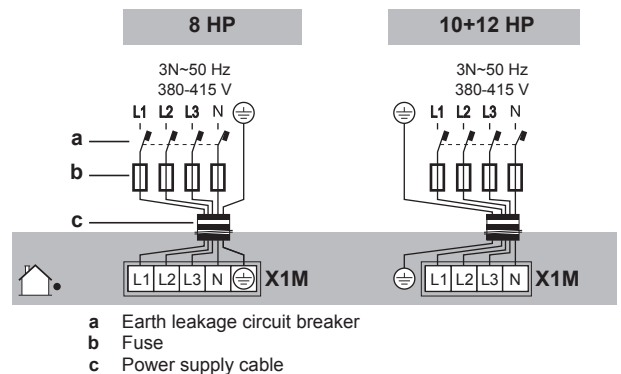

- Fix the cables (power supply and transmission wiring) with cable ties.

6 Configuration

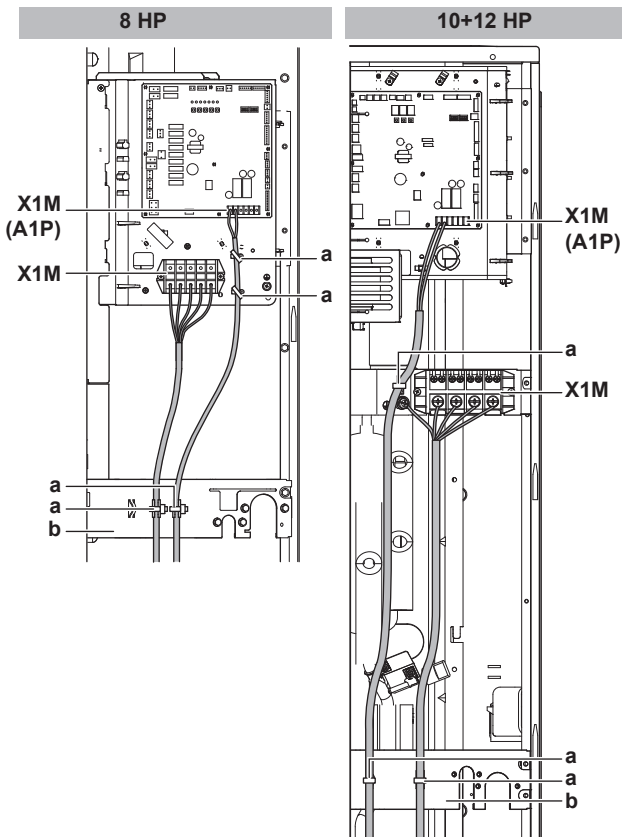

- a Cable tie
- b Attachment plate
- X1M Power supply
- X1M (A1P) Transmission wiring

5 Route the wiring through the frame and connect it to it.

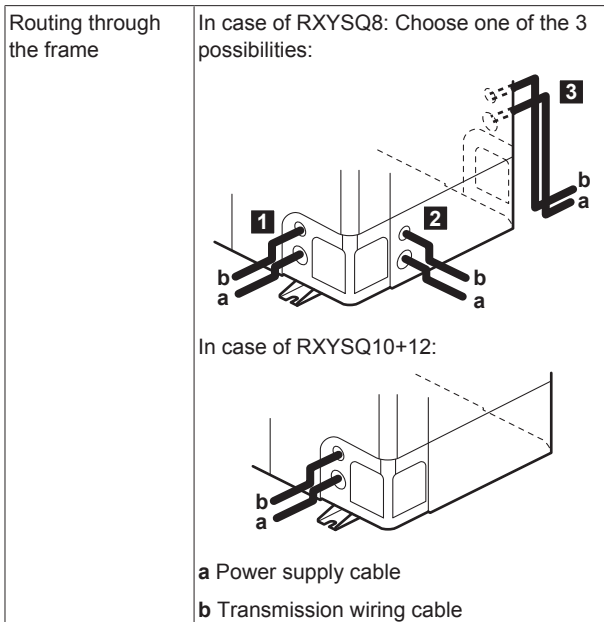

Connecting to the frame

When cables are routed from the unit, a protection sleeve for the conduits (PG insertions) can be inserted at the knockout hole.

When you do not use a wire conduit, protect the wires with vinyl tubes to prevent the edge of the knockout hole from cutting the wires.

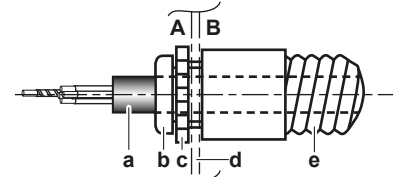

- A Inside of the outdoor unit
- B Outside of the outdoor unit
- a Wire
- b Bush
- c Nut
- d Frame
- e Hose

- 6 Reattach the service cover.
- 7 Connect an earth leakage circuit breaker and fuse to the power supply line.

5.8 Finishing the outdoor unit installation

5.8.1 To finish the transmission wiring

After installing the transmission wires inside the unit, wrap them along with the on-site refrigerant pipes using finishing tape, as shown in figure below.

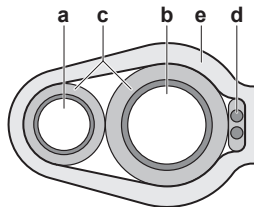

- a Liquid pipe
- b Gas pipe
- c Insulator
- d Transmission wiring (F1/F2)
- e Finishing tape

6 Configuration



INFORMATION

It is important that all information in this chapter is read sequentially by the installer and that the system is configured as applicable.



DANGER: RISK OF ELECTROCUTION

6.1 Making field settings

6.1.1 About making field settings

To configure the heat pump system, you must give input to the outdoor unit's main PCB (A1P). This involves the following field setting components:

- Push buttons to give input to the PCB
- A display to read feedback from the PCB

Field settings are defined by their mode, setting and value. Example: [2-8]=4.

PC configurator

For VRV IV-S heat pump system it is alternatively possible to make several commissioning field settings through a personal computer interface (for this, option EKPCAB is required). The installer can prepare the configuration (off-site) on PC and afterwards upload the configuration to the system.

See also: "6.1.9 To connect the PC configurator to the outdoor unit" on page 25.

Mode 1 and 2

Mode	Description
Mode 1 (monitoring settings)	Mode 1 can be used to monitor the current situation of the outdoor unit. Some field setting contents can be monitored as well.
Mode 2 (field settings)	Mode 2 is used to change the field settings of the system. Consulting the current field setting value and changing the current field setting value is possible. In general, normal operation can be resumed without special intervention after changing field settings. Some field settings are used for special operation (e.g., 1 time operation, recovery/vacuuming setting, manual adding refrigerant setting, etc.). In such a case, it is required to abort the special operation before normal operation can restart. It will be indicated in below explanations.

6.1.2 To access the field setting components

See "5.1.1 To open the outdoor unit" on page 9.

6.1.3 Field setting components



NOTICE

The DIP switches (DS1 and/or DS2 on A1P) are not used. Do NOT change the factory setting.

The components to make field settings differ depending on the model.

Model	Field setting components
RXYSQ8	<ul style="list-style-type: none"> • Push buttons (BS1~BS5) • 7-LEDs display (H1P~H7P) • H8P: LED for indication during initialisation
RXYSQ10+12	<ul style="list-style-type: none"> • Push buttons (BS1~BS3) • 7-segments display (888)

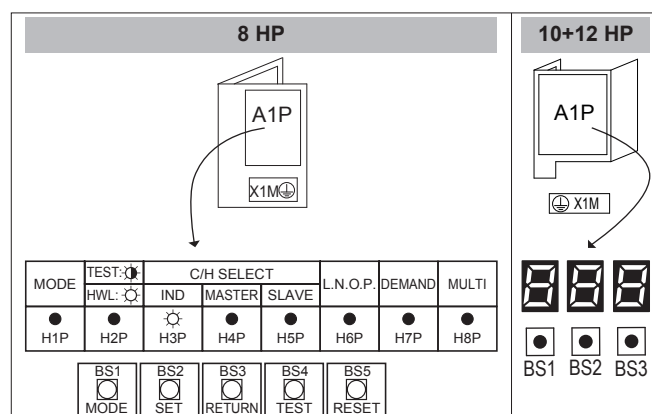

ON (☀) OFF (●) Flashing (⚡)
ON (📄) OFF (📄) Flashing (⚡)

Push buttons

Use the push buttons to make the field settings. Operate the push buttons with an insulated stick (such as a closed ball-point pen) to avoid touching of live parts.



The push buttons differ depending on the model.

Model	Push buttons
RXYSQ8	BS1: MODE: For changing the set mode BS2: SET: For field setting BS3: RETURN: For field setting BS4: TEST: For test operation BS5: RESET: For resetting the address when the wiring is changed or when an additional indoor unit is installed
RXYSQ10+12	BS1: MODE: For changing the set mode BS2: SET: For field setting BS3: RETURN: For field setting

Display

The display gives feedback about the field settings, which are defined as [Mode-Setting]=Value.

The display differs depending on the model.

Model	Display
RXYSQ8	7-LEDs display H1P: Shows the mode H2P~H7P: Shows the settings and values, represented in binary code
RXYSQ10+12	7-segments display (888)

Example:

[H1P- 32 + 16 + 8 + 4 + 2 + 1] H1P H2P H3P H4P H5P H6P H7P	Display	Description
● ● ☀ ● ● ● ●	888	Default situation
(H1P OFF)	↓ [][]	
☀ ● ● ● ● ● ●	↓ [][]	Mode 1
(H1P flashing)	↓ [][]	
☀ ● ● ● ● ● ●	↓ [][]	Mode 2
(H1P ON)	↓ [][]	

6 Configuration

[H1P- 32 + 16 + 8 + 4 + 2 + 1] H1P H2P H3P H4P H5P H6P H7P	888	Description
 (H2P~H7P = binary 8)		Setting 8 (in mode 2)
 (H2P~H7P = binary 4)		Value 4 (in mode 2)

6.1.4 To access mode 1 or 2

After the units are turned ON, the display goes to its default situation. From there, you can access mode 1 and mode 2.

Initialisation: default situation

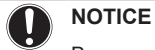

NOTICE

Be sure to turn on the power 6 hours before operation in order to have power running to the crankcase heater and to protect the compressor.

Turn on the power supply of the outdoor unit and all indoor units. When the communication between indoor units and outdoor unit is established and normal, the display indication state will be as below (default situation when shipped from factory).

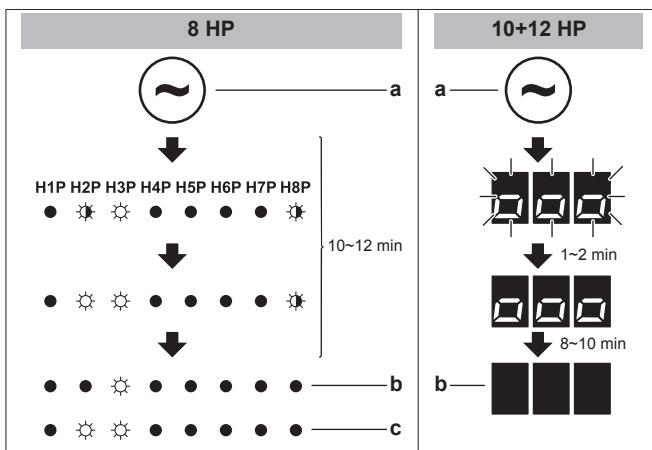

- a Power ON
- b Default situation
- c LED indication when there is a malfunction

If the default situation is not displayed after 10~12 minutes, check the malfunction code on the indoor unit user interface (and in case of RXYSQ10+12 on the outdoor unit 7-segment display). Solve the malfunction code accordingly. First, check the communication wiring.

Switching between modes

Use BS1 to switch between the default situation, mode 1 and mode 2.

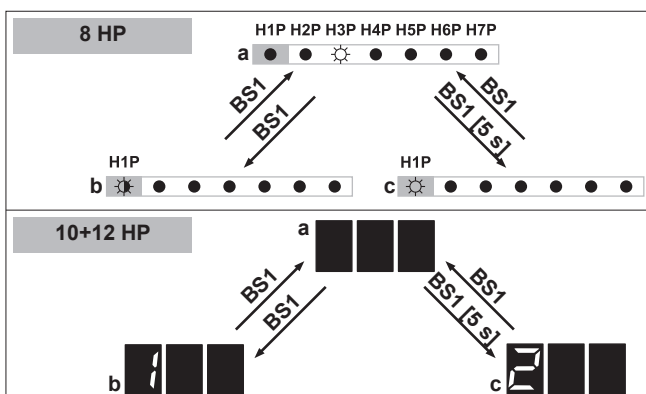

- a Default situation (H1P OFF)
- b Mode 1 (H1P flashing)
- c Mode 2 (H1P ON)
- BS1 Press BS1.

BS1 [5 s] Press BS1 for at least 5 s.



INFORMATION

If you get confused in the middle of the process, press BS1 to return to the default situation.

6.1.5 To use mode 1

In mode 1 (and in default situation) you can read out some information. How to do this differs depending on the model.

Example: 7-LEDs display – Default situation

(in case of RXYSQ8)

You can read out the status of low noise operation as follows:

#	Action	Button/display
1	Make sure the LEDs are showing the default situation.	H1P H2P H3P H4P H5P H6P H7P
2	Check the status of LED H6P.	

Example: 7-LEDs display – Mode 1

(in case of RXYSQ8)

You can read out setting [1-5] (= the total number of connected indoor units) as follows:

#	Action	Button/display
1	Start from the default situation.	H1P H2P H3P H4P H5P H6P H7P
2	Select mode 1.	BS1 [1×]
3	Select setting 5. ("X" depends on the setting that you want to select.)	BS2 [X×]
4	Display the value of setting 5. (there are 8 indoor units connected)	BS3 [1×]
5	Quit mode 1.	BS1 [1×]

Example: 7-segments display – Mode 1

(in case of RXYSQ10+12)

You can read out setting [1-10] (= the total number of connected indoor units) as follows:

#	Action	Button/display
1	Start from the default situation.	
2	Select mode 1.	BS1 [1×]
3	Select setting 10. ("X" depends on the setting that you want to select.)	BS2 [X×]

#	Action	Button/display
4	Display the value of setting 10. (there are 8 indoor units connected)	↓BS3 [1×]
5	Quit mode 1.	↓BS1 [1×]

6.1.6 To use mode 2

In mode 2 you can make field settings to configure the system. How to do this differs slightly depending on the model.

Example: 7-LEDs display – Mode 2

(in case of RXYSQ8)

You can change the value of setting [2-8] (= T_e target temperature during cooling operation) to 4 (= 8°C) as follows:

#	Action	Button/display
1	Start from the default situation.	H1P H2P H3P H4P H5P H6P H7P
2	Select mode 2.	↓BS1 [5 s]
3	Select setting 8. ("X" depends on the setting that you want to select.)	↓BS2 [X×] (= binary 8)
4	Select value 4 (= 8°C). a: Display the current value. b: Change to 4. ("X" depends on the current value, and the value that you want to select.) c: Enter the value in the system. d: Confirm. The system starts operating according to the setting.	a ↓BS3 [1×] b ↓BS2 [X×] c ↓BS3 [1×] d ↓BS3 [1×]
5	Quit mode 2.	↓BS1 [1×]

Example: 7-segments display – Mode 2

(in case of RXYSQ10+12)

You can change the value of setting [2-8] (= T_e target temperature during cooling operation) to 4 (= 8°C) as follows:

#	Action	Button/display
1	Start from the default situation.	
2	Select mode 2.	↓BS1 [5 s]
3	Select setting 8. ("X" depends on the setting that you want to select.)	↓BS2 [X×]

#	Action	Button/display
4	Select value 4 (= 8°C). a: Display the current value. b: Change to 4. ("X" depends on the current value, and the value that you want to select.) c: Enter the value in the system. d: Confirm. The system starts operating according to the setting.	a ↓BS3 [1×] b BS2 [X×] c BS3 [1×] d BS3 [1×]
5	Quit mode 2.	↓BS1 [1×]

6.1.7 Mode 1 (and default situation): Monitoring settings

In mode 1 (and in default situation) you can read out some information. What you can read out differs depending on the model.



7-LEDs display – Default situation (H1P OFF)

(in case of RXYSQ8)

You can read out the following information:

Value / Description	
H6P	Shows the status of low noise operation.
OFF	 Unit is currently not operating under low noise restrictions.
ON	 Unit is currently operating under low noise restrictions.
<p>Low noise operation reduces the sound generated by the unit compared to nominal operating conditions.</p> <p>Low noise operation can be set in mode 2. There are two methods to activate low noise operation of the outdoor unit system.</p> <ul style="list-style-type: none"> The first method is to enable an automatic low noise operation during night time by field setting. The unit will operate at the selected low noise level during the selected time frames. The second method is to enable low noise operation based on an external input. For this operation an optional accessory is required. 	





6 Configuration

	Value / Description
H7P	Shows the status of power consumption limitation operation.
OFF	 Unit is currently not operating under power consumption limitations.
ON	 Unit is currently operating under power consumption limitation.
	<p>Power consumption limitation reduces the power consumption of the unit compared to nominal operating conditions.</p> <p>Power consumption limitation can be set in mode 2. There are two methods to activate power consumption limitation of the outdoor unit system.</p> <ul style="list-style-type: none"> The first method is to enable a forced power consumption limitation by field setting. The unit will always operate at the selected power consumption limitation. The second method is to enable power consumption limitation based on an external input. For this operation an optional accessory is required.

7-LEDs display – Mode 1 (H1P flashing)

(in case of RXYSQ8)

You can read out the following information:

Setting (H1P H2P H3P H4P H5P H6P H7P)	Value / Description
[1-5] 	It can be convenient to check if the total number of indoor units which are installed match the total number of indoor units which are recognised by the system. In case there is a mismatch, it is advised to check the communication wiring path between outdoor and indoor units (F1/F2 communication line).
[1-14] 	When the latest malfunction codes were reset by accident on an indoor unit user interface, they can be checked again through this monitoring settings.
[1-15] 	For the content or reason behind the malfunction code see "8.1 Solving problems based on error codes" on page 27 , where most relevant malfunction codes are explained. Detailed information about malfunction codes can be consulted in the service manual of this unit.
[1-16] 	To obtain more detailed information about the malfunction code, press BS2 up to 3 times.

7-segments display – Mode 1

(in case of RXYSQ10+12)

You can read out the following information:

Setting	Value / Description				
[1-1]	<table border="1"> <tr> <td>0</td> <td>Unit is currently not operating under low noise restrictions.</td> </tr> <tr> <td>1</td> <td>Unit is currently operating under low noise restrictions.</td> </tr> </table> <p>Shows the status of low noise operation.</p> <p>Low noise operation reduces the sound generated by the unit compared to nominal operating conditions.</p> <p>Low noise operation can be set in mode 2. There are two methods to activate low noise operation of the outdoor unit system.</p> <ul style="list-style-type: none"> The first method is to enable an automatic low noise operation during night time by field setting. The unit will operate at the selected low noise level during the selected time frames. The second method is to enable low noise operation based on an external input. For this operation an optional accessory is required. 	0	Unit is currently not operating under low noise restrictions.	1	Unit is currently operating under low noise restrictions.
0	Unit is currently not operating under low noise restrictions.				
1	Unit is currently operating under low noise restrictions.				
[1-2]	<table border="1"> <tr> <td>0</td> <td>Unit is currently not operating under power consumption limitations.</td> </tr> <tr> <td>1</td> <td>Unit is currently operating under power consumption limitation.</td> </tr> </table> <p>Shows the status of power consumption limitation operation.</p> <p>Power consumption limitation reduces the power consumption of the unit compared to nominal operating conditions.</p> <p>Power consumption limitation can be set in mode 2. There are two methods to activate power consumption limitation of the outdoor unit system.</p> <ul style="list-style-type: none"> The first method is to enable a forced power consumption limitation by field setting. The unit will always operate at the selected power consumption limitation. The second method is to enable power consumption limitation based on an external input. For this operation an optional accessory is required. 	0	Unit is currently not operating under power consumption limitations.	1	Unit is currently operating under power consumption limitation.
0	Unit is currently not operating under power consumption limitations.				
1	Unit is currently operating under power consumption limitation.				
[1-5]	For more information, see setting [2-8].				
[1-6]	For more information, see setting [2-9].				
[1-10]	It can be convenient to check if the total number of indoor units which are installed match the total number of indoor units which are recognised by the system. In case there is a mismatch, it is advised to check the communication wiring path between outdoor and indoor units (F1/F2 communication line).				

Setting	Value / Description
[1-17] Shows the latest malfunction code.	When the latest malfunction codes were reset by accident on an indoor unit user interface, they can be checked again through this monitoring settings.
[1-18] Shows the 2nd last malfunction code.	For the content or reason behind the malfunction code see "8.1 Solving problems based on error codes" on page 27, where most relevant malfunction codes are explained. Detailed information about malfunction codes can be consulted in the service manual of this unit.
[1-19] Shows the 3rd last malfunction code.	

Setting	Value / Description
[1-40] Shows the current cooling comfort setting.	For more information, see setting [2-81].
[1-41] Shows the current heating comfort setting.	For more information, see setting [2-82].



























































6.1.8 Mode 2: Field settings

In mode 2 you can make field settings to configure the system. The settings differ slightly depending on the model.

- : When using the 7-segments display (RXYSQ10+12)
- **H1P H2P H3P H4P H5P H6P H7P**: When using the 7-LEDs display (RXYSQ8) (the LEDs give a binary representation of the setting/value number)

Setting H1P H2P H3P H4P H5P H6P H7P (= binary)	Value		Description
		H1P H2P H3P H4P H5P H6P H7P	
[2-8] T _e target temperature during cooling operation.	0 (default)	 (= binary 3) (default)	Auto
	2		6°C
	4		8°C
	5		9°C
	6		10°C
	7		11°C
[2-9] T _e target temperature during heating operation.	0 (default)	 (= binary 1) (default)	Auto
	3	 (= binary 4)	43°C
	6	 (= binary 2)	46°C
[2-12] Enable the low noise function and/or power consumption limitation via external control adaptor (DTA104A61/62). If the system needs to be running under low noise operation or under power consumption limitation conditions when an external signal is sent to the unit, this setting should be changed. This setting will only be effective when the optional external control adaptor (DTA104A61/62) is installed in the indoor unit.	0 (default)	 (= binary 1) (default)	Deactivated.
	1	 (= binary 2)	Activated.
[2-18] Fan high static pressure setting. In order to increase the static pressure the outdoor unit fan is delivering, this setting should be activated. For details about this setting, see technical specifications.	0 (default)	 (= binary 1) (default)	Deactivated.
	1	 (= binary 2)	Activated.

6 Configuration

Setting  H1P H2P H3P H4P H5P H6P H7P (= binary)	Value			
		H1P H2P H3P H4P H5P H6P H7P	Description	
<p>[2-20]  ●  ●  ●  ●</p> <p>Manual additional refrigerant charge.</p> <p>In order to add the additional refrigerant charge amount in a manual way (without automatic refrigerant charging functionality), following setting should be applied.</p>	0 (default)	 ● ● ● ● ● ● ● 	Deactivated.	
	1	 ● ● ● ● ● ● ● ●	Activated. To stop the manual additional refrigerant charge operation (when the required additional refrigerant amount is charged), push BS3. If this function was not aborted by pushing BS3, the unit will stop its operation after 30 minutes. If 30 minutes was not sufficient to add the needed refrigerant amount, the function can be reactivated by changing the field setting again.	
<p>[2-21]  ●  ●  ●  ●</p> <p>Refrigerant recovery/vacuumping mode.</p> <p>In order to achieve a free pathway to reclaim refrigerant out of the system or to remove residual substances or to vacuum the system it is necessary to apply a setting which will open required valves in the refrigerant circuit so the reclaim of refrigerant or vacuuming process can be done properly.</p>	0 (default)	 ● ● ● ● ● ● ● 	Deactivated.	
	1	 ● ● ● ● ● ● ● ●	Activated. To stop the refrigerant recovery/vacuumping mode, push BS1 (in case of RXYSQ8) or BS3 (in case of RXYSQ10+12). If it is not pushed, the system will remain in refrigerant recovery/vacuumping mode.	
<p>[2-22]  ●  ●  ●  ●</p> <p>Automatic low noise setting and level during night time.</p> <p>By changing this setting, you activate the automatic low noise operation function of the unit and define the level of operation. Depending on the chosen level, the noise level will be lowered. The start and stop moments for this function are defined under setting [2-26] and [2-27].</p>	0 (default)	 ● ● ● ● ● ● ●	Deactivated	
	1	 ● ● ● ● ● ● ● 	Level 1	Level 3<Level 2<Level 1
	2	 ● ● ● ● ● ● ● ●	Level 2	
	3	 ● ● ● ● ● ● ● 	Level 3	
<p>[2-25]  ●  ●  ●  ●</p> <p>Low noise operation level via the external control adaptor.</p> <p>If the system needs to be running under low noise operation conditions when an external signal is sent to the unit, this setting defines the level of low noise that will be applied.</p> <p>This setting will only be effective when the optional external control adaptor (DTA104A61/62) is installed and the setting [2-12] was activated.</p>	1	 ● ● ● ● ● ● ● 	Level 1	Level 3<Level 2<Level 1
	2 (default)	 ● ● ● ● ● ● ● ●	Level 2	
	3	 ● ● ● ● ● ● ● ●	Level 3	
<p>[2-26]  ●  ●  ●  ●</p> <p>Low noise operation start time.</p> <p>This setting is used in conjunction with setting [2-22].</p>	1	 ● ● ● ● ● ● ● 	20h00	
	2 (default)	 ● ● ● ● ● ● ● ●	22h00	
	3	 ● ● ● ● ● ● ● ●	24h00	
<p>[2-27]  ●  ●  ●  ●</p> <p>Low noise operation stop time.</p> <p>This setting is used in conjunction with setting [2-22].</p>	1	 ● ● ● ● ● ● ● 	6h00	
	2	 ● ● ● ● ● ● ● ●	7h00	
	3 (default)	 ● ● ● ● ● ● ● ●	8h00	
<p>[2-30]  ●  ●  ●  ●</p> <p>Power consumption limitation level (step 1) via the external control adaptor (DTA104A61/62).</p> <p>If the system needs to be running under power consumption limitation conditions when an external signal is sent to the unit, this setting defines the level power consumption limitation that will be applied for step 1. The level is according to the table.</p>	1	 ● ● ● ● ● ● ● 	60%	
	2	—	65%	
	3 (default)	 ● ● ● ● ● ● ● ●	70%	
	4	—	75%	
	5	 ● ● ● ● ● ● ● ●	80%	
	6	—	85%	
	7	—	90%	
	8	—	95%	

Setting	Value		
	888	H1P H2P H3P H4P H5P H6P H7P	Description
[2-31] ☀ ● ☀ ☀ ☀ ☀ ☀ Power consumption limitation level (step 2) via the external control adaptor (DTA104A61/62). If the system needs to be running under power consumption limitation conditions when an external signal is sent to the unit, this setting defines the level power consumption limitation that will be applied for step 2. The level is according to the table.	—	☀ ● ● ● ● ● ● ● ☀ (= binary 1)	30%
	1 (default)	☀ ● ● ● ● ● ● ● ☀ (= binary 2) (default)	40%
	2	☀ ● ● ● ● ● ● ● ☀ (= binary 4)	50%
	3	—	55%
[2-32] ☀ ☀ ● ● ● ● ● ● ● Forced, all time, power consumption limitation operation (no external control adaptor is required to perform power consumption limitation). If the system always needs to be running under power consumption limitation conditions, this setting activates and defines the level power consumption limitation that will be applied continuously. The level is according to the table.	0 (default)	☀ ● ● ● ● ● ● ● ☀ (= binary 1) (default)	Function not active.
	1	☀ ● ● ● ● ● ● ● ☀ (= binary 2)	Follows [2-30] setting.
	2	☀ ● ● ● ● ● ● ● ☀ (= binary 4)	Follows [2-31] setting.
[2-41] ☀ ☀ ● ● ● ● ● ● ● Type of indoor units After changing this setting, you have to power OFF the system, wait for 20 s, and then power ON again. If not, the setting will not be processed and malfunction codes might occur. This setting is only applicable in case of RXYSQ8. In case of RXYSQ10+12, the type of indoor units is detected automatically.	—	☀ ● ● ● ● ● ● ● ☀ (= binary 1) (default)	VRV DX indoor units installed
	—	☀ ● ● ● ● ● ● ● ☀ (= binary 2)	RA DX indoor units installed
[2-81] (in case of 888) ☀ ☀ ● ● ● ● ● ● ● ☀ (= binary [2-39]) (in case of H1P H2P H3P H4P H5P H6P H7P) Cooling comfort setting. This setting is used in conjunction with setting [2-8].	0	☀ ● ● ● ● ● ● ● ●	Eco
	1 (default)	☀ ● ● ● ● ● ● ● ☀ (default)	Mild
	2	☀ ● ● ● ● ● ● ● ☀	Quick
	3	☀ ● ● ● ● ● ● ● ☀	Powerful
[2-82] (in case of 888) ☀ ☀ ● ● ● ● ● ● ● ☀ (= binary [2-43]) (in case of H1P H2P H3P H4P H5P H6P H7P) Heating comfort setting. This setting is used in conjunction with setting [2-9].	0	☀ ● ● ● ● ● ● ● ●	Eco
	1 (default)	☀ ● ● ● ● ● ● ● ☀ (default)	Mild
	2	☀ ● ● ● ● ● ● ● ☀	Quick
	3	☀ ● ● ● ● ● ● ● ☀	Powerful

6.1.9 To connect the PC configurator to the outdoor unit

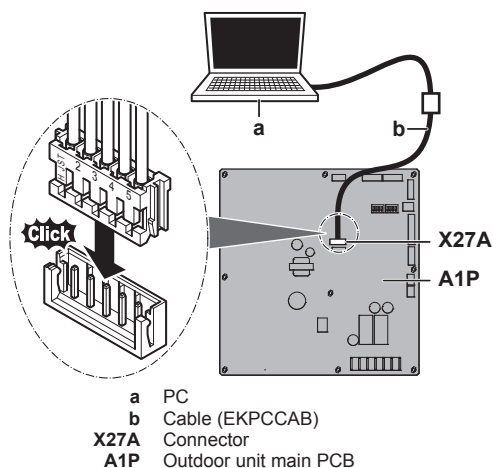

7 Commissioning

After installation and once the field settings are defined, the installer is obliged to verify correct operation. Therefore a test run must be performed according to the procedures described below.

7.1 Precautions when commissioning



CAUTION

Do not perform the test operation while working on the indoor units.

When performing the test operation, not only the outdoor unit, but the connected indoor unit will operate as well. Working on an indoor unit while performing a test operation is dangerous.



NOTICE

Be sure to turn on the power 6 hours before operation in order to have power running to the crankcase heater and to protect the compressor.

7 Commissioning

During test operation, the outdoor unit and the indoor units will start up. Make sure that the preparations of all indoor units are finished (field piping, electrical wiring, air purge, ...). See installation manual of the indoor units for details.

7.2 Checklist before commissioning

After the installation of the unit, first check the following items. Once all below checks are fulfilled, the unit must be closed, only then can the unit be powered up.

<input type="checkbox"/>	You read the complete installation and operation instructions, as described in the installer and user reference guide .
<input type="checkbox"/>	Installation Check that the unit is properly installed, to avoid abnormal noises and vibrations when starting up the unit.
<input type="checkbox"/>	Field wiring Be sure that the field wiring has been carried out according to the instructions described in the chapter "5.7 Connecting the electrical wiring" on page 17, according to the wiring diagrams and according to the applicable legislation.
<input type="checkbox"/>	Power supply voltage Check the power supply voltage on the local supply panel. The voltage must correspond to the voltage on the identification label of the unit.
<input type="checkbox"/>	Earth wiring Be sure that the earth wires have been connected properly and that the earth terminals are tightened.
<input type="checkbox"/>	Insulation test of the main power circuit Using a megatester for 500 V, check that the insulation resistance of 2 MΩ or more is attained by applying a voltage of 500 V DC between power terminals and earth. Never use the megatester for the transmission wiring.
<input type="checkbox"/>	Fuses, circuit breakers, or protection devices Check that the fuses, circuit breakers, or the locally installed protection devices are of the size and type specified in the chapter "4.3.1 Safety device requirements" on page 9. Be sure that neither a fuse nor a protection device has been bypassed.
<input type="checkbox"/>	Internal wiring Visually check the electrical component box and the inside of the unit on loose connections or damaged electrical components.
<input type="checkbox"/>	Pipe size and pipe insulation Be sure that correct pipe sizes are installed and that the insulation work is properly executed.
<input type="checkbox"/>	Stop valves Be sure that the stop valves are open on both liquid and gas side.
<input type="checkbox"/>	Damaged equipment Check the inside of the unit on damaged components or squeezed pipes.
<input type="checkbox"/>	Refrigerant leak Check the inside of the unit on refrigerant leakage. If there is a refrigerant leak, try to repair the leak. If the repair is unsuccessful, call your local dealer. Do not touch any refrigerant which has leaked out from refrigerant piping connections. This may result in frostbite.
<input type="checkbox"/>	Oil leak Check the compressor for oil leakage. If there is an oil leak, try to repair the leak. If the repairing is unsuccessful, call your local dealer.

<input type="checkbox"/>	Air inlet/outlet Check that the air inlet and outlet of the unit is not obstructed by paper sheets, cardboard, or any other material.
<input type="checkbox"/>	Additional refrigerant charge The amount of refrigerant to be added to the unit shall be written on the included "Added refrigerant" plate and attached to the rear side of the front cover.
<input type="checkbox"/>	Installation date and field setting Be sure to keep record of the installation date on the sticker on the rear of the front panel according to EN60335-2-40 and keep record of the contents of the field setting(s).

7.3 Checklist during commissioning

<input type="checkbox"/>	To perform a test run .
--------------------------	--------------------------------

7.3.1 About test run

The procedure below describes the test operation of the complete system. This operation checks and judges following items:

- Check of wrong wiring (communication check with indoor units).
- Check of the stop valves opening.
- Judgement of piping length.

Make sure to carry out the system test operation after the first installation. Otherwise, the malfunction code *UE* will be displayed on the user interface and normal operation or individual indoor unit test run cannot be carried out.

Abnormalities on indoor units cannot be checked for each unit separately. After the test operation is finished, check the indoor units one by one by performing a normal operation using the user interface. Refer to the indoor unit installation manual for more details concerning the individual test run.



INFORMATION

- It may take 10 minutes to achieve a uniform refrigerant state before the compressor starts.
- During the test operation, the refrigerant running sound or the magnetic sound of a solenoid valve may become loud and the display indication may change. These are not malfunctions.

7.3.2 To perform a test run (7-LEDs display)

Use this procedure in case of RXYSQ8.

- 1 Make sure all field settings you want are set; see ["6.1 Making field settings"](#) on page 19.
- 2 Turn ON the power to the outdoor unit and the connected indoor units.



NOTICE

Be sure to turn on the power 6 hours before operation in order to have power running to the crankcase heater and to protect the compressor.

- 3 Make sure the default (idle) situation is existing (H1P is OFF); see ["6.1.4 To access mode 1 or 2"](#) on page 20. Push BS4 for 5 seconds or more. The unit will start test operation.

Result: The test operation is automatically carried out, the outdoor unit H2P flashes and the indication "Test operation" and "Under centralised control" will display on the user interface of indoor units.

Steps during the automatic system test run procedure:

8 Troubleshooting

In case of RXYSQ10+12: The error code on the outdoor unit will indicate a main malfunction code and a sub code. The sub code indicates more detailed information about the malfunction code. The main code and sub code will be displayed intermittent (with an interval of 1 second). **Example:**

- Main code: **E3**
- Sub code: **-01**

8.1.1 Error codes: Overview

In case of RXYSQ8:

Main code	Cause	Solution
E3	<ul style="list-style-type: none"> ▪ The stop valve of an outdoor unit is left closed. ▪ Refrigerant overcharge 	<ul style="list-style-type: none"> ▪ Open the stop valve on both the gas and liquid side. ▪ Recalculate the required amount of refrigerant from the piping length and correct the refrigerant charge level by recovering any excessive refrigerant with a refrigerant recovery machine.
E4	<ul style="list-style-type: none"> ▪ The stop valve of an outdoor unit is left closed. ▪ Insufficient refrigerant 	<ul style="list-style-type: none"> ▪ Open the stop valve on both the gas and liquid side. ▪ Check if the additional refrigerant charge has been finished correctly. Recalculate the required amount of refrigerant from the piping length and add an adequate amount of refrigerant.
E9	Electronic expansion valve malfunction (Y1E) - A1P (X21A) (Y2E) - A1P (X23A)	Check connection on PCB or actuator.
F3	<ul style="list-style-type: none"> ▪ The stop valve of an outdoor unit is left closed. ▪ Insufficient refrigerant 	<ul style="list-style-type: none"> ▪ Open the stop valve on both the gas and liquid side. ▪ Check if the additional refrigerant charge has been finished correctly. Recalculate the required amount of refrigerant from the piping length and add an adequate amount of refrigerant.
Fb	Refrigerant overcharge	Recalculate the required amount of refrigerant from the piping length and correct the refrigerant charge level by recovering any excessive refrigerant with a refrigerant recovery machine.
H9	Ambient temperature sensor malfunction (R1T) - A1P (X18A)	Check connection on PCB or actuator.
J3	Discharge temperature sensor malfunction (R3T): open circuit / short circuit - A1P (X29A)	Check connection on PCB or actuator.
J5	Suction temperature sensor malfunction (R2T) - A1P (X30A) (R7T) - A1P (X30A)	Check connection on PCB or actuator.
J7	Liquid temperature sensor (after subcool HE) malfunction (R6T) - A1P (X30A)	Check connection on PCB or actuator.
J8	Liquid temperature sensor (coil) malfunction (R4T) - A1P (X30A)	Check connection on PCB or actuator.
J9	Gas temperature sensor (after subcool HE) malfunction (R5T) - A1P (X30A)	Check connection on PCB or actuator.
JA	High pressure sensor malfunction (S1NPH): open circuit / short circuit - A1P (X32A)	Check connection on PCB or actuator.
JC	Low pressure sensor malfunction (S1NPL): open circuit / short circuit - A1P (X31A)	Check connection on PCB or actuator.
LC	Transmission outdoor unit - inverter: INV1 / FAN1 / FAN2 transmission trouble - A1P (X20A, X28A)	Check connection.
P1	INV1 unbalanced power supply voltage	Check if power supply is within range.
U1	Reversed power supply phase malfunction	Correct phase order.
U2	Insufficient supply voltage	Check if the supply voltage is supplied properly.
U3	Malfunction code: System test run not yet executed (system operation not possible)	Execute system test run.
U4	No power is supplied to the outdoor unit.	Check if the power wiring for the outdoor unit is connected correctly.
U7	Faulty wiring to Q1/Q2	Check Q1/Q2 wiring.

Main code	Cause	Solution
U9	System mismatch. Wrong type of indoor units combined (R410A, R407C, RA, etc) Indoor unit malfunction	Check if other indoor units have malfunction and confirm indoor unit mix is allowed.
UR	Improper type of indoor units are connected.	Check the type of indoor units that are currently connected. If they are not proper, replace them with proper ones.
UH	Incorrect interconnections between units.	Connect interconnections F1 and F2 of the connected BP unit correctly to the outdoor unit's PCB (TO BP UNIT). Make sure that the communication with the BP unit is enabled.
UF	<ul style="list-style-type: none"> ▪ The stop valve of an outdoor unit is left closed. ▪ The piping and wiring of the specified indoor unit are not connected correctly to the outdoor unit. 	<ul style="list-style-type: none"> ▪ Open the stop valve on both the gas and liquid side. ▪ Confirm that the piping and wiring of the specified indoor unit are connected correctly to the outdoor unit.

In case of RXYSQ10+12:

Main code	Sub code	Cause	Solution
E2	-06	Earth leakage detector activated	Restart the unit. If problem reoccurs, contact your dealer.
E3	-01	High pressure switch was activated (S1PH) - A1P (X4A)	Check stop valve situation or abnormalities in (field) piping or airflow over air cooled coil.
	-02	<ul style="list-style-type: none"> ▪ Refrigerant overcharge ▪ Stop valve closed 	<ul style="list-style-type: none"> ▪ Check refrigerant amount+recharge unit. ▪ Open stop valves
	-13	Stop valve closed (liquid)	Open liquid stop valve.
	-18	<ul style="list-style-type: none"> ▪ Refrigerant overcharge ▪ Stop valve closed 	<ul style="list-style-type: none"> ▪ Check refrigerant amount+recharge unit. ▪ Open stop valves.
E4	-01	Low pressure malfunction: <ul style="list-style-type: none"> ▪ Stop valve closed ▪ Refrigerant shortage ▪ Indoor unit malfunction 	<ul style="list-style-type: none"> ▪ Open stop valves. ▪ Check refrigerant amount+recharge unit. ▪ Check the user interface's display or transmission wiring between the outdoor unit and the indoor unit.
E9	-01	Electronic expansion valve malfunction (subcool) (Y2E) - A1P (X21A)	Check connection on PCB or actuator.
	-04	Electronic expansion valve malfunction (main) (Y1E) - A1P (X23A)	Check connection on PCB or actuator.
F3	-01	Discharge temperature too high (R21T): <ul style="list-style-type: none"> ▪ Stop valve closed ▪ Refrigerant shortage 	<ul style="list-style-type: none"> ▪ Open stop valves. ▪ Check refrigerant amount+recharge unit.
	-20	Compressor casing temperature too high (R8T): <ul style="list-style-type: none"> ▪ Stop valve closed ▪ Refrigerant shortage 	<ul style="list-style-type: none"> ▪ Open stop valves. ▪ Check refrigerant amount+recharge unit.
F6	-02	<ul style="list-style-type: none"> ▪ Refrigerant overcharge ▪ Stop valve closed 	<ul style="list-style-type: none"> ▪ Check refrigerant amount+recharge unit. ▪ Open stop valves.
H9	-01	Ambient temperature sensor malfunction (R1T) - A1P (X18A)	Check connection on PCB or actuator.
J3	-16	Discharge temperature sensor malfunction (R21T): open circuit - A1P (X29A)	Check connection on PCB or actuator.
	-17	Discharge temperature sensor malfunction (R21T): short circuit - A1P (X29A)	Check connection on PCB or actuator.
	-47	Compressor casing temperature sensor malfunction (R8T): open circuit - A1P (X29A)	Check connection on PCB or actuator.
	-48	Compressor casing temperature sensor malfunction (R8T): short circuit - A1P (X29A)	Check connection on PCB or actuator.
J5	-01	Suction temperature sensor malfunction (R3T) - A1P (X30A)	Check connection on PCB or actuator.
J6	-01	De-icing temperature sensor malfunction (R7T) - A1P (X30A)	Check connection on PCB or actuator
J7	-06	Liquid temperature sensor (after subcool HE) malfunction (R5T) - A1P (X30A)	Check connection on PCB or actuator.
J8	-01	Liquid temperature sensor (coil) malfunction (R4T) - A1P (X30A)	Check connection on PCB or actuator.

9 Technical data

Main code	Sub code	Cause	Solution
JQ	-01	Gas temperature sensor (after subcool HE) malfunction (R6T) - A1P (X30A)	Check connection on PCB or actuator.
JR	-06	High pressure sensor malfunction (S1NPH): open circuit - A1P (X32A)	Check connection on PCB or actuator.
	-07	High pressure sensor malfunction (S1NPH): short circuit - A1P (X32A)	Check connection on PCB or actuator.
JC	-06	Low pressure sensor malfunction (S1NPL): open circuit - A1P (X31A)	Check connection on PCB or actuator.
	-07	Low pressure sensor malfunction (S1NPL): short circuit - A1P (X31A)	Check connection on PCB or actuator.
LC	-14	Transmission outdoor unit - inverter: INV1 transmission trouble - A1P (X20A, X28A, X42A)	Check connection.
	-19	Transmission outdoor unit - inverter: FAN1 transmission trouble - A1P (X20A, X28A, X42A)	Check connection.
	-24	Transmission outdoor unit - inverter: FAN2 transmission trouble - A1P (X20A, X28A, X42A)	Check connection.
PI	-01	INV1 unbalanced power supply voltage	Check if power supply is within range.
U1	-01	Reversed power supply phase malfunction	Correct phase order.
	-04	Reversed power supply phase malfunction	Correct phase order.
U2	-01	INV1 voltage power shortage	Check if power supply is within range.
	-02	INV1 power phase loss	Check if power supply is within range.
U3	-03	Malfunction code: System test run not yet executed (system operation not possible)	Execute system test run.
U4	-01	Faulty wiring to Q1/Q2 or indoor - outdoor	Check (Q1/Q2) wiring.
	-03	Faulty wiring to Q1/Q2 or indoor - outdoor	Check (Q1/Q2) wiring.
	-04	System test run abnormal ending	Execute test run again.
U7	-01	Warning: faulty wiring to Q1/Q2	Check Q1/Q2 wiring.
	-02	Malfunction code: faulty wiring to Q1/Q2	Check Q1/Q2 wiring.
	-11	<ul style="list-style-type: none"> ▪ Too many indoor units are connected to F1/F2 line ▪ Bad wiring between outdoor and indoor units 	Check indoor unit amount and total capacity connected.
U9	-01	System mismatch. Wrong type of indoor units combined (R410A, R407C, RA, etc)	Check if other indoor units have malfunction and confirm indoor unit mix is allowed.
		Indoor unit malfunction	
UR	-03	Connection malfunction over indoor units or type mismatch (R410A, R407C, RA, etc)	Check if other indoor units have malfunction and confirm indoor unit mix is allowed.
	-18	Connection malfunction over indoor units or type mismatch (R410A, R407C, RA, etc)	Check if other indoor units have malfunction and confirm indoor unit mix is allowed.
UH	-01	Auto address malfunction (inconsistency)	Check if transmission wired unit amount matches with powered unit amount (by monitor mode) or wait till initialisation is finished.
UF	-01	Auto address malfunction (inconsistency)	Check if transmission wired unit amount matches with powered unit amount (by monitor mode) or wait till initialisation is finished.
	-05	Stop valve closed or wrong (during system test run)	Open stop valves.

9 Technical data

Latest information can be found in the technical engineering data.

9.1 Service space: Outdoor unit

In case of RXYSQ8:

- When mounting units side by side, the piping route must be to the front, to the back or downwards. In this case the piping route to the side is not possible.
- When mounting the units side by side and routing the piping to the back, you must keep a distance of ≥ 250 mm between the units (instead of ≥ 100 mm as shown on the figures below).

In case of RXYSQ10+12: When mounting units side by side, the piping route must be to the front or downwards. In this case the piping route to the side is not possible.

Single unit | Single row of units

See figure 1 on the inside of the front cover.

- A,B,C,D** Obstacles (walls/baffle plates)
- E** Obstacle (roof)
- a,b,c,d,e** Minimum service space between the unit and obstacles A, B, C, D and E
- e_B** Maximum distance between the unit and the edge of obstacle E, in the direction of obstacle B
- e_D** Maximum distance between the unit and the edge of obstacle E, in the direction of obstacle D
- H_U** Height of the unit
- H_B,H_D** Height of obstacles B and D
- 1** Seal the bottom of the installation frame to prevent discharged air from flowing back to the suction side through the bottom of the unit.
- 2** Maximum two units can be installed.
-  Not allowed

Multiple rows of units

See figure 2 on the inside of the front cover.

Stacked units (max. 2 levels)

See figure 3 on the inside of the front cover.

- A1=>A2** (A1) If there is danger of drainage dripping and freezing between the upper and lower units...
(A2) Then install a **roof** between the upper and lower units. Install the upper unit high enough above the lower unit to prevent ice buildup at the upper unit's bottom plate.
- B1=>B2** (B1) If there is no danger of drainage dripping and freezing between the upper and lower units...
(B2) Then it is not required to install a roof, but **seal the gap** between the upper and lower units to prevent discharged air from flowing back to the suction side through the bottom of the unit.

9 Technical data

9.2 Piping diagram: Outdoor unit

RXYSQ8

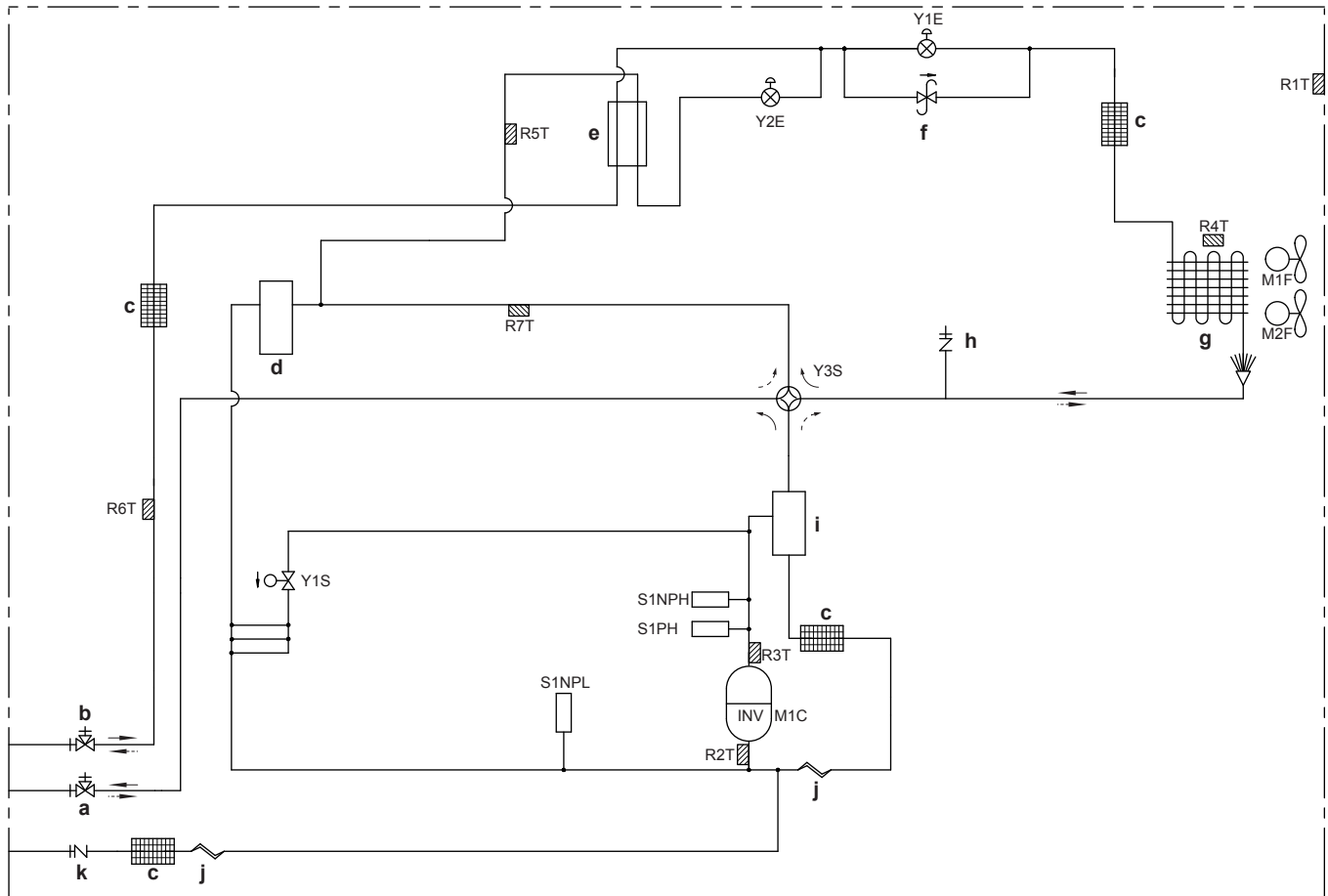

- | | |
|--|--|
| a Stop valve (gas) | R3T Thermistor (discharge) |
| b Stop valve (liquid) | R4T Thermistor (heat exchanger de-icer) |
| c Filter (4×) | R5T Thermistor (subcool heat exchanger) |
| d Accumulator | R6T Thermistor (liquid pipe) |
| e Subcool tube heat exchanger | R7T Thermistor (suction 2) |
| f Pressure regulating valve | S1NPH High pressure sensor |
| g Heat exchanger | S1NPL Low pressure sensor |
| h Service port (high pressure) | S1PH High pressure switch |
| i Oil separator | Y1E Electronic expansion valve (main) |
| j Capillary tube (2×) | Y2E Electronic expansion valve (subcool heat exchanger) |
| k Service port (refrigerant charge) | Y1S Solenoid valve |
| M1C Compressor | Y3S Solenoid valve (4-way valve) |
| M1F-M2F Fan motor | → Heating |
| R1T Thermistor (air) | ⇄ Cooling |
| R2T Thermistor (suction 1) | |

RXYSQ10+12

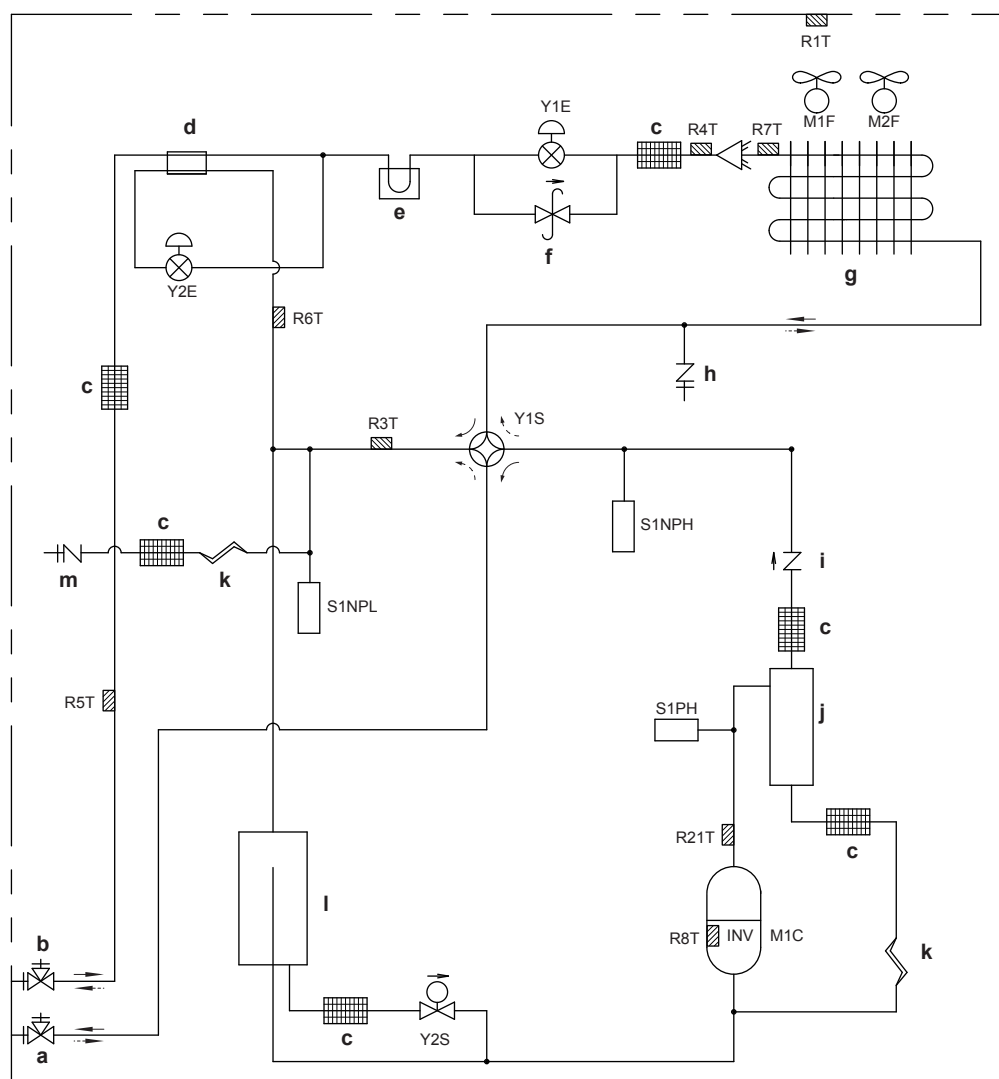

- | | |
|---|--|
| <p>a Stop valve (gas)
 b Stop valve (liquid)
 c Filter (6×)
 d Subcool heat exchanger
 e Heat sink PCB
 f Pressure regulating valve
 g Heat exchanger
 h Service port (high pressure)
 i Check valve
 j Oil separator
 k Capillary tube (2×)
 l Accumulator
 m Service port (refrigerant charge)
 M1C Compressor
 M1F-M2F Fan motor
 R1T Thermistor (air)</p> | <p>R21T Thermistor (discharge)
 R3T Thermistor (suction)
 R4T Thermistor (heat exchanger liquid pipe)
 R5T Thermistor (liquid pipe)
 R6T Thermistor (subcool heat exchanger)
 R7T Thermistor (heat exchanger de-icer)
 R8T Thermistor (M1C body)
 S1NPH High pressure sensor
 S1NPL Low pressure sensor
 S1PH High pressure switch
 Y1E Electronic expansion valve (main)
 Y2E Electronic expansion valve (subcool heat exchanger)
 Y1S Solenoid valve (4-way valve)
 Y2S Solenoid valve
 Heating
 Cooling</p> |
|---|--|

9.3 Wiring diagram: Outdoor unit

The wiring diagram is delivered with the unit, located at the inside of the service cover.

Notes for RXYSQ8:

- 1 This wiring diagram applies only to the outdoor unit.
- 2 Symbols (see below).
- 3 Symbols (see below).
- 4 Refer to the installation manual for connection wiring to INDOOR-OUTDOOR transmission F1-F2 and OUTDOOR-OUTDOOR transmission F1-F2.

- 5 Refer to the installation manual for how to use the BS1-BS5 and DS1 switches.
- 6 When operating, do not short-circuit protective device S1PH.
- 7 Colours (see below).

Notes for RXYSQ10+12:

- 1 This wiring diagram applies only to the outdoor unit.
- 2 Symbols (see below).
- 3 Refer to the installation manual for connection wiring to INDOOR-OUTDOOR transmission F1-F2 and OUTDOOR-OUTDOOR transmission F1-F2.

9 Technical data

- 4 Refer to the installation manual for how to use the BS1~BS3 switches.
- 5 When operating, do not short-circuit protective device S1PH.
- 6 Colours (see below).

Symbols:

L	Live
N	Neutral
⋮■□■⋮	Field wiring
□□□□	Terminal strip
⊞	Connector
⊞	Fixed connector
⊞	Movable connector
⊞	Protective earth (screw)
⊞	Noiseless earth
⊞	Terminal

Colours:

BLK	Black
BLU	Blue
BRN	Brown
GRN	Green
ORG	Orange
RED	Red
WHT	White
YLW	Yellow

Legend for wiring diagram RXYSQ8:

A1P	Printed circuit board (main)
A2P	Printed circuit board (noise filter)
A3P	Printed circuit board (inverter)
A4P	Printed circuit board (fan 1)
A5P	Printed circuit board (fan 2)
BS1~BS5	Push button switch
C32, C67	Capacitor
DS1	DIP switch
E1HC	Crankcase heater
F1U, F2U	Fuse (T 3.15 A / 250 V) (A1P)
F101U	Fuse (5 A, DC650 V) (A4P) (A5P)
F400U	Fuse (T 6.3 A / 250 V) (A2P)
H1P~H8P	Light-emitting diode (service monitor orange)
H2P:	
	▪ Prepare, test: Flickering
	▪ Malfunction detection: Light up
HAP	Light-emitting diode (service monitor is green)
K1R	Magnetic relay (A3P)
K2M	Magnetic contactor (M1C) (A3P)
K3R	Magnetic relay (A2P)
K3R	Magnetic relay (Y1S)
K5R	Magnetic relay (Y3S)
K7R	Magnetic relay (E1HC)
L1R	Reactor
M1C	Motor (compressor)
M1F, M2F	Motor (upper and lower fan)
PS	Switching power supply (A1P) (A3P)

Q1RP	Reverse phase protector
R2, R3	Resistor
R24	Resistor (current sensor) (A4P) (A5P)
R95	Resistor (current limiting)
R1T	Thermistor (air)
R2T	Thermistor (suction 1)
R3T	Thermistor (discharge)
R4T	Thermistor (heat exchanger de-icer)
R5T	Thermistor (subcool heat exchanger)
R6T	Thermistor (liquid pipe)
R7T	Thermistor (suction 2)
S1NPH	High pressure sensor
S1NPL	Low pressure sensor
S1PH	High pressure switch
V1CP	Safety devices input
V1R	IGBT module (A4P) (A5P)
V1R	Diode bridge IGBT module (A3P)
X1A, X2A	Connector (M1F)
X3A, X4A	Connector (M2F)
X1M	Terminal strip (power supply)
X1M	Terminal strip (control) (A1P)
Y1E	Electronic expansion valve (main)
Y2E	Electronic expansion valve (subcool heat exchanger)
Y1S	Solenoid valve
Y3S	Solenoid valve (4-way valve)
Z1C~Z8C	Noise filter (ferrite core)
Z1F	Noise filter (with surge absorber)

Legend for wiring diagram RXYSQ10+12:

A1P	Printed circuit board (main)
A2P	Printed circuit board (noise filter)
A3P	Printed circuit board (inverter)
A4P	Printed circuit board (fan 1)
A5P	Printed circuit board (fan 2)
BS1~BS3	Push button switch (A1P)
C47, C48	Capacitor
DS1, DS2	DIP switch (A1P)
E1HC	Crankcase heater
F1U, F2U	Fuse (T 3.15 A / 250 V) (A1P)
F101U	Fuse (A4P) (A5P)
F411U, F412U	Fuse (A2P)
F601U	Fuse (A3P)
HAP	Light-emitting diode (service monitor is green) (A1P) (A3P) (A4P) (A5P)
K1M	Magnetic contactor (A3P)
K1R	Magnetic relay (A3P)
K3R	Magnetic relay (A3P)
K4R	Magnetic relay (Y2S) (A1P)
K7R	Magnetic relay (E1HC) (A1P)
K11R	Magnetic relay (Y1S) (A1P)
L1R	Reactor
M1C	Motor (compressor)
M1F, M2F	Motor (upper and lower fan)
PS	Switching power supply (A1P) (A3P)

Q1LD	Leakage detection circuit (A1P)	S1PH	High pressure switch
Q1RP	Phase reversal detect circuit (A1P)	SEG1~SEG3	7-segment display (A1P)
R1T	Thermistor (air)	T1A	Current sensor
R21T	Thermistor (discharge)	V1R	Power module (A3P) (A4P) (A5P)
R3T	Thermistor (suction)	V2R	Power module (A3P)
R4T	Thermistor (heat exchanger liquid pipe)	X1A, X2A	Connector (M1F)
R5T	Thermistor (liquid pipe)	X3A, X4A	Connector (M2F)
R6T	Thermistor (subcool heat exchanger)	X1M	Terminal strip (power supply)
R7T	Thermistor (heat exchanger de-icer)	X1M	Terminal strip (control) (A1P)
R8T	Thermistor (M1C body)	Y1E	Electronic expansion valve (main)
R1	Resistor (current limiting) (A3P)	Y2E	Electronic expansion valve (subcool heat exchanger)
R24	Resistor (current sensor) (A4P)	Y1S	Solenoid valve (4-way valve)
R313	Resistor (current sensor) (A3P)	Y2S	Solenoid valve
R865, R867	Resistor (A3P)	Z1C~Z4C	Noise filter (ferrite core)
S1NPH	High pressure sensor	Z1F	Noise filter (with surge absorber) (A2P)
S1NPL	Low pressure sensor		

For the user

10 About the system

The indoor unit part of VRV IV-S heat pump system can be used for heating/cooling applications. The type of indoor unit which can be used depends on the outdoor units series.



NOTICE

Do not use the air conditioner for other purposes. In order to avoid any quality deterioration, do not use the unit for cooling precision instruments, food, plants, animals or works of art.



NOTICE

For future modifications or expansions of your system:

A full overview of allowable combinations (for future system extensions) is available in technical engineering data and should be consulted. Contact your installer to receive more information and professional advice.



INFORMATION

- Combination of VRV DX and RA DX indoor units is not allowed.
- Combination of RA DX and AHU indoor units is not allowed.
- Combination of RA DX and aircurtain indoor units is not allowed.

10.1 System layout

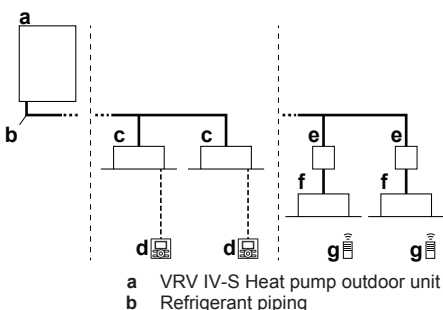

- c VRV direct expansion (DX) indoor unit
- d User interface (dedicated depending on indoor unit type)
- e BP box (required to connect Residential Air (RA) or Sky Air (SA) direct expansion (DX) indoor units)
- f Residential Air (RA) direct expansion (DX) indoor units
- g User interface (wireless, dedicated depending on indoor unit type)

11 User interface



CAUTION

Never touch the internal parts of the controller.

Do not remove the front panel. Some parts inside are dangerous to touch and appliance problems may happen. For checking and adjusting the internal parts, contact your dealer.

This operation manual will give a non-exhaustive overview of the main functions of the system.

Detailed information on required actions to achieve certain functions can be found in the dedicated installation and operation manual of the indoor unit.

Refer to the operation manual of the installed user interface.

12 Operation

12.1 Operation range

Use the system in the following temperature and humidity ranges for safe and effective operation.

	Cooling	Heating
Outdoor temperature	-5~52°C DB	-20~21°C DB -20~15.5°C WB
Indoor temperature	21~32°C DB 14~25°C WB	15~27°C DB
Indoor humidity	≤80% ^(a)	

12 Operation

- (a) To avoid condensation and water dripping out of the unit. If the temperature or the humidity is beyond these conditions, safety devices may be put in action and the air conditioner may not operate.

Above operation range is only valid in case direct expansion indoor units are connected to the VRV IV-S system.



Special operation ranges are valid in case of using AHU. They can be found in the installation/operation manual of the dedicated unit. Latest information can be found in the technical engineering data.

12.2 Operating the system

12.2.1 About operating the system

- Operation procedure varies according to the combination of outdoor unit and user interface.
- To protect the unit, turn on the main power switch 6 hours before operation.
- If the main power supply is turned off during operation, operation will restart automatically after the power turns back on again.

12.2.2 About cooling, heating, fan only, and automatic operation

- Changeover cannot be made with a user interface whose display shows  "change-over under centralised control" (refer to installation and operation manual of the user interface).
- When the display  "change-over under centralised control" flashes, refer to ["12.5.1 About setting the master user interface" on page 37](#).
- The fan may keep on running for about 1 minute after the heating operation stops.
- The air flow rate may adjust itself depending on the room temperature or the fan may stop immediately. This is not a malfunction.

12.2.3 About the heating operation

It may take longer to reach the set temperature for general heating operation than for cooling operation.

The following operation is performed in order to prevent the heating capacity from dropping or cold air from blowing.

Defrost operation

In heating operation, freezing of the outdoor unit's air cooled coil increases over time, restricting the energy transfer to the outdoor unit's coil. Heating capability decreases and the system needs to go into defrost operation to be able to deliver enough heat to the indoor units.

The indoor unit will stop fan operation, the refrigerant cycle will reverse and energy from inside the building will be used to defrost the outdoor unit coil.

The indoor unit will indicate defrost operation on the displays .

Hot start

In order to prevent cold air from blowing out of an indoor unit at the start of heating operation, the indoor fan is automatically stopped. The display of the user interface shows . It may take some time before the fan starts. This is not a malfunction.

12.2.4 To operate the system

- Press the operation mode selector button on the user interface several times and select the operation mode of your choice.

 Cooling operation

 Heating operation

 Fan only operation

- Press the ON/OFF button on the user interface.

Result: The operation lamp lights up and the system starts operating.

12.3 Using the dry program

12.3.1 About the dry program

- The function of this program is to decrease the humidity in your room with minimal temperature decrease (minimal room cooling).
- The micro computer automatically determines temperature and fan speed (cannot be set by the user interface).
- The system does not go into operation if the room temperature is low (<20°C).

12.3.2 To use the dry program

To start

- Press the operation mode selector button on the user interface several times and select  (program dry operation).

- Press the ON/OFF button of the user interface.

Result: The operation lamp lights up and the system starts operating.

- Press the air flow direction adjust button (only for double-flow, multi-flow, corner, ceiling-suspended and wall-mounted). Refer to ["12.4 Adjusting the air flow direction" on page 36](#) for details.

To stop

- Press the ON/OFF button on the user interface once again.

Result: The operation lamp goes out and the system stops operating.



NOTICE

Do not turn off power immediately after the unit stops, but wait for at least 5 minutes.

12.4 Adjusting the air flow direction

Refer to the operation manual of the user interface.

12.4.1 About the air flow flap

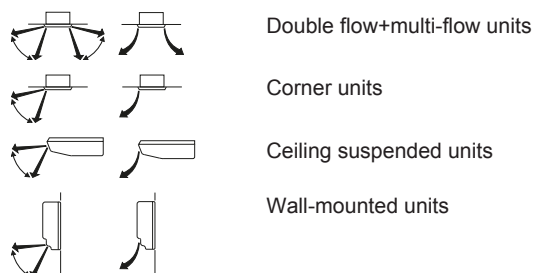



For the following conditions, a micro computer controls the air flow direction which may be different from the display.

Cooling	Heating
<ul style="list-style-type: none"> When the room temperature is lower than the set temperature. 	<ul style="list-style-type: none"> When starting operation. When the room temperature is higher than the set temperature. At defrost operation.

Cooling	Heating
<ul style="list-style-type: none"> When operating continuously at horizontal air flow direction. When continuous operation with downward air flow is performed at the time of cooling with a ceiling-suspended or a wall-mounted unit, the micro computer may control the flow direction, and then the user interface indication will also change. 	

The air flow direction can be adjusted in one of the following ways:

- The air flow flap itself adjusts its position.
- The air flow direction can be fixed by the user.
- Automatic  and desired position .



WARNING

Never touch the air outlet or the horizontal blades while the swing flap is in operation. Fingers may become caught or the unit may break down.



NOTICE

- The movable limit of the flap is changeable. Contact your dealer for details. (only for double-flow, multi-flow, corner, ceiling-suspended and wall-mounted).
- Avoid operating in the horizontal direction . It may cause dew or dust to settle on the ceiling or flap.

12.5 Setting the master user interface

12.5.1 About setting the master user interface

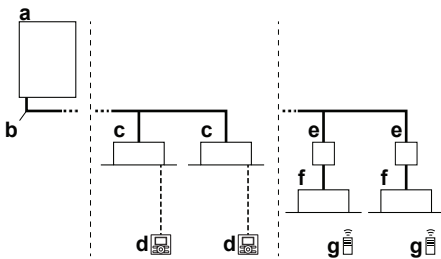

- a VRV IV-S Heat pump outdoor unit
- b Refrigerant piping
- c VRV direct expansion (DX) indoor unit
- d User interface (dedicated depending on indoor unit type)
- e BP box (required to connect Residential Air (RA) or Sky Air (SA) direct expansion (DX) indoor units)
- f Residential Air (RA) direct expansion (DX) indoor units
- g User interface (wireless, dedicated depending on indoor unit type)

When the system is installed as shown in the figure above, it is necessary to designate one of the user interfaces as the master user interface.

The displays of slave user interfaces show  (change-over under centralised control) and slave user interfaces automatically follow the operation mode directed by the master user interface.

Only the master user interface can select heating or cooling mode.



12.5.2 To designate the master user interface (VRV DX)

In case only VRV DX indoor units are connected to the VRV IV-S system:

- Press the operation mode selector button of the current master user interface for 4 seconds. In case this procedure was not yet performed, the procedure can be executed on the first user interface operated.

Result: The display showing  (change-over under centralised control) of all slave user interfaces connected to the same outdoor unit flashes.

- Press the operation mode selector button of the controller that you wish to designate as the master user interface.

Result: Designation is completed. This user interface is designated as the master user interface and the display showing  (change-over under centralised control) vanishes. The displays of other user interfaces show  (change-over under centralised control).

12.5.3 To designate the master user interface (RA DX)

In case only RA DX indoor units are connected to the VRV IV-S system:

- Stop all indoor units.
- When the system is not operating (all indoor units thermo OFF), you can define the master RA DX indoor unit by addressing that unit with infrared user interface (instruct thermo ON in desired mode).

The only way to change the master unit is by repeating the previous procedure. A cool/heat switchover (or opposite) is only possible by changing the operation mode of the defined master indoor unit.

13 Maintenance and service



NOTICE

Never inspect or service the unit by yourself. Ask a qualified service person to perform this work.



WARNING

Never replace a fuse with a fuse of a wrong ampere ratings or other wires when a fuse blows out. Use of wire or copper wire may cause the unit to break down or cause a fire.



CAUTION

Do not insert fingers, rods or other objects into the air inlet or outlet. Do not remove the fan guard. When the fan is rotating at high speed, it will cause injury.



CAUTION

After a long use, check the unit stand and fitting for damage. If damaged, the unit may fall and result in injury.



NOTICE

Do not wipe the controller operation panel with benzine, thinner, chemical dust cloth, etc. The panel may get discoloured or the coating peeled off. If it is heavily dirty, soak a cloth in water-diluted neutral detergent, squeeze it well and wipe the panel clean. Wipe it with another dry cloth.

13.1 About the refrigerant

This product contains fluorinated greenhouse gases. Do NOT vent gases into the atmosphere.

Refrigerant type: R410A

Global warming potential (GWP) value: 2087.5

14 Troubleshooting



NOTICE

In Europe, the **greenhouse gas emissions** of the total refrigerant charge in the system (expressed as tonnes CO₂-equivalent) is used to determine the maintenance intervals. Follow the applicable legislation.

Formula to calculate the greenhouse gas emissions:
GWP value of the refrigerant × Total refrigerant charge [in kg] / 1000

Please contact your installer for more information.



WARNING

The refrigerant in the air conditioner is safe and normally does not leak. If the refrigerant leaks in the room, contact with a fire of a burner, a heater or a cooker may result in a harmful gas.

Turn off any combustible heating devices, ventilate the room and contact the dealer where you purchased the unit.

Do not use the air conditioner until a service person confirms that the portion where the refrigerant leaks is repaired.

13.2 After-sales service and warranty

13.2.1 Warranty period

- This product includes a warranty card that was filled in by the dealer at the time of installation. The completed card has to be checked by the customer and stored carefully.
- If repairs to the air conditioner are necessary within the warranty period, contact your dealer and keep the warranty card at hand.

13.2.2 Recommended maintenance and inspection

Since dust collects when using the unit for several years, performance of the unit will deteriorate to some extent. As taking apart and cleaning interiors of units requires technical expertise and in order to ensure the best possible maintenance of your units, we recommend to enter into a maintenance and inspection contract on top of normal maintenance activities. Our network of dealers has access to a permanent stock of essential components in order to keep your air conditioner in operation as long as possible. Contact your dealer for more information.

When asking your dealer for an intervention, always state:

- The complete model name of the air conditioner.
- The manufacturing number (stated on the nameplate of the unit).
- The installation date.
- The symptoms or malfunction, and details of the defect.



WARNING

- Do not modify, disassemble, remove, reinstall or repair the unit yourself as incorrect dismantling or installation may cause an electric shock or fire. Contact your dealer.
- In case of accidental refrigerant leaks, make sure there are no naked flames. The refrigerant itself is entirely safe, non-toxic and non-combustible, but it will generate toxic gas when it accidentally leaks into a room where combustible air from fan heaters, gas cookers, etc. is present. Always have qualified service personnel confirm that the point of leakage has been repaired or corrected before resuming operation.

14 Troubleshooting

If one of the following malfunctions occur, take the measures shown below and contact your dealer.



WARNING

Stop operation and shut off the power if anything unusual occurs (burning smells etc.).

Leaving the unit running under such circumstances may cause breakage, electric shock or fire. Contact your dealer.

The system must be repaired by a qualified service person:

Malfunction	Measure
If a safety device such as a fuse, a breaker or an earth leakage breaker frequently actuates or the ON/OFF switch does not properly work.	Turn off the main power switch.
If water leaks from the unit.	Stop the operation.
The operation switch does not work well.	Turn off the power.
If the user interface display indicates the unit number, the operation lamp flashes and the malfunction code appears.	Notify your installer and report the malfunction code.

If the system does not properly operate except for the above mentioned cases and none of the above mentioned malfunctions is evident, investigate the system according to the following procedures.

Malfunction	Measure
If the system does not operate at all.	<ul style="list-style-type: none"> • Check if there is no power failure. Wait until power is restored. If power failure occurs during operation, the system automatically restarts immediately after the power supply is recovered. • Check if no fuse has blown or breaker has worked. Change the fuse or reset the breaker if necessary.
If the system goes into fan only operation, but as soon as it goes into heating or cooling operation, the system stops.	<ul style="list-style-type: none"> • Check if air inlet or outlet of outdoor or indoor unit is not blocked by obstacles. Remove any obstacle and make it well-ventilated. • Check if the user interface display shows  (time to clean the air filter). (Refer to "13 Maintenance and service" on page 37 and "Maintenance" in the indoor unit manual.)

Malfunction	Measure
The system operates but cooling or heating is insufficient.	<ul style="list-style-type: none"> ▪ Check if air inlet or outlet of outdoor or indoor unit is not blocked by obstacles. Remove any obstacle and make it well-ventilated. ▪ Check if the air filter is not clogged (refer to "Maintenance" in the indoor unit manual). ▪ Check the temperature setting. ▪ Check the fan speed setting on your user interface. ▪ Check for open doors or windows. Shut doors and windows to prevent wind from coming in. ▪ Check if there are too many occupants in the room during cooling operation. Check if the heat source of the room is excessive. ▪ Check if direct sunlight enters the room. Use curtains or blinds. ▪ Check if the air flow angle is proper.

If after checking all above items, it is impossible to fix the problem yourself, contact your installer and state the symptoms, the complete model name of the air conditioner (with manufacturing number if possible) and the installation date (possibly listed on the warranty card).

14.1 Error codes: Overview

In case a malfunction code appears on the indoor unit user interface display, contact your installer and inform the malfunction code, the unit type, and serial number (you can find this information on the nameplate of the unit).

For your reference, a list with malfunction codes is provided. You can, depending on the level of the malfunction code, reset the code by pushing the ON/OFF button. If not, ask your installer for advice.

Main code	Contents
<i>R0</i>	External protection device was activated
<i>R1</i>	EEPROM failure (indoor)
<i>R3</i>	Drain system malfunction (indoor)
<i>Rb</i>	Fan motor malfunction (indoor)
<i>R7</i>	Swing flap motor malfunction (indoor)
<i>R9</i>	Expansion valve malfunction (indoor)
<i>RF</i>	Drain malfunction (indoor unit)
<i>RH</i>	Filter dust chamber malfunction (indoor)
<i>RJ</i>	Capacity setting malfunction (indoor)
<i>C1</i>	Transmission malfunction between main PCB and sub PCB (indoor)
<i>C4</i>	Heat exchanger thermistor malfunction (indoor; liquid)
<i>C5</i>	Heat exchanger thermistor malfunction (indoor; gas)
<i>C9</i>	Suction air thermistor malfunction (indoor)
<i>CR</i>	Discharge air thermistor malfunction (indoor)
<i>CE</i>	Movement detector or floor temperature sensor malfunction (indoor)
<i>CJ</i>	User interface thermistor malfunction (indoor)
<i>E1</i>	PCB malfunction (outdoor)
<i>E2</i>	Current leakage detector was activated (outdoor)
<i>E3</i>	High pressure switch was activated
<i>E4</i>	Low pressure malfunction (outdoor)
<i>E5</i>	Compressor lock detection (outdoor)

Main code	Contents
<i>E7</i>	Fan motor malfunction (outdoor)
<i>E9</i>	Electronic expansion valve malfunction (outdoor)
<i>F3</i>	Discharge temperature malfunction (outdoor)
<i>F4</i>	Abnormal suction temperature (outdoor)
<i>Fb</i>	Refrigerant overcharge detection
<i>H3</i>	High pressure switch malfunction
<i>H4</i>	Low pressure switch malfunction
<i>H7</i>	Fan motor trouble (outdoor)
<i>H9</i>	Ambient temperature sensor malfunction (outdoor)
<i>J1</i>	Pressure sensor malfunction
<i>J2</i>	Current sensor malfunction
<i>J3</i>	Discharge temperature sensor malfunction (outdoor)
<i>J4</i>	Heat exchanger gas temperature sensor malfunction (outdoor)
<i>J5</i>	Suction temperature sensor malfunction (outdoor)
<i>Jb</i>	De-icing temperature sensor malfunction (outdoor)
<i>J7</i>	Liquid temperature sensor (after subcool HE) malfunction (outdoor)
<i>J8</i>	Liquid temperature sensor (coil) malfunction (outdoor)
<i>J9</i>	Gas temperature sensor (after subcool HE) malfunction (outdoor)
<i>JR</i>	High pressure sensor malfunction (S1NPH)
<i>JL</i>	Low pressure sensor malfunction (S1NPL)
<i>L1</i>	INV PCB abnormal
<i>L4</i>	Fin temperature abnormal
<i>L5</i>	Inverter PCB faulty
<i>LB</i>	Compressor over current detected
<i>L9</i>	Compressor lock (startup)
<i>LC</i>	Transmission outdoor unit - inverter: INV transmission trouble
<i>P1</i>	INV unbalanced power supply voltage
<i>P4</i>	Fin thermistor malfunction
<i>PJ</i>	Capacity setting malfunction (outdoor)
<i>U0</i>	Abnormal low pressure drop, faulty expansion valve
<i>U1</i>	Reversed power supply phase malfunction
<i>U2</i>	INV voltage power shortage
<i>U3</i>	System test run not yet executed
<i>U4</i>	Faulty wiring indoor/outdoor
<i>U5</i>	Abnormal user interface - indoor communication
<i>U7</i>	Faulty wiring to outdoor/outdoor
<i>UB</i>	Abnormal main-sub user interface communication
<i>U9</i>	System mismatch. Wrong type of indoor units combined. Indoor unit malfunction.
<i>UR</i>	Connection malfunction over indoor units or type mismatch
<i>UC</i>	Centralised address duplication
<i>UE</i>	Malfunction in communication centralised control device - indoor unit
<i>UF</i>	Auto address malfunction (inconsistency)
<i>UH</i>	Auto address malfunction (inconsistency)

14.2 Symptoms that are not air conditioner troubles

Following symptoms are not air conditioner troubles:

14 Troubleshooting

14.2.1 Symptom: The system does not operate

- The air conditioner does not start immediately after the ON/OFF button on the user interface is pressed. If the operation lamp lights, the system is in normal condition. To prevent overloading of the compressor motor, the air conditioner starts 5 minutes after it is turned ON again in case it was turned OFF just before. The same starting delay occurs after the operation mode selector button was used.
- If "Under Centralized Control" is displayed on the user interface, pressing the operation button causes the display to blink for a few seconds. The blinking display indicates that the user interface cannot be used.
- The system does not start immediately after the power supply is turned on. Wait one minute until the micro computer is prepared for operation.

14.2.2 Symptom: Fan operation is possible, but cooling and heating do not work

Immediately after the power is turned on. The micro computer is getting ready to operate and is performing a communication check with all indoor units. Please wait 12 minutes (max.) till this process is finished.

14.2.3 Symptom: The fan strength does not correspond to the setting

The fan speed does not change even if the fan speed adjustment button is pressed. During heating operation, when the room temperature reaches the set temperature, the outdoor unit goes off and the indoor unit changes to whisper fan speed. This is to prevent cold air blowing directly on occupants of the room. The fan speed will not change even when another indoor unit is in heating operation, if the button is pressed.

14.2.4 Symptom: The fan direction does not correspond to the setting

The fan direction does not correspond with the user interface display. The fan direction does not swing. This is because the unit is being controlled by the micro computer.

14.2.5 Symptom: White mist comes out of a unit (Indoor unit)

- When humidity is high during cooling operation. If the interior of an indoor unit is extremely contaminated, the temperature distribution inside a room becomes uneven. It is necessary to clean the interior of the indoor unit. Ask your dealer for details on cleaning the unit. This operation requires a qualified service person.
- Immediately after the cooling operation stops and if the room temperature and humidity are low. This is because warm refrigerant gas flows back into the indoor unit and generates steam.

14.2.6 Symptom: White mist comes out of a unit (Indoor unit, outdoor unit)

When the system is changed over to heating operation after defrost operation. Moisture generated by defrost becomes steam and is exhausted.

14.2.7 Symptom: The user interface display reads "U4" or "U5" and stops, but then restarts after a few minutes

This is because the user interface is intercepting noise from electric appliances other than the air conditioner. The noise prevents communication between the units, causing them to stop. Operation automatically restarts when the noise ceases.

14.2.8 Symptom: Noise of air conditioners (Indoor unit)

- A "zeen" sound is heard immediately after the power supply is turned on. The electronic expansion valve inside an indoor unit starts working and makes the noise. Its volume will reduce in about one minute.
- A continuous low "shah" sound is heard when the system is in cooling operation or at a stop. When the drain pump (optional accessories) is in operation, this noise is heard.
- A "pishi-pishi" squeaking sound is heard when the system stops after heating operation. Expansion and contraction of plastic parts caused by temperature change make this noise.
- A low "sah", "choro-choro" sound is heard while the indoor unit is stopped. When another indoor unit is in operation, this noise is heard. In order to prevent oil and refrigerant from remaining in the system, a small amount of refrigerant is kept flowing.

14.2.9 Symptom: Noise of air conditioners (Indoor unit, outdoor unit)

- A continuous low hissing sound is heard when the system is in cooling or defrost operation. This is the sound of refrigerant gas flowing through both indoor and outdoor units.
- A hissing sound which is heard at the start or immediately after stopping operation or defrost operation. This is the noise of refrigerant caused by flow stop or flow change.

14.2.10 Symptom: Noise of air conditioners (Outdoor unit)

When the tone of operating noise changes. This noise is caused by the change of frequency.

14.2.11 Symptom: Dust comes out of the unit

When the unit is used for the first time in a long time. This is because dust has gotten into the unit.

14.2.12 Symptom: The units can give off odours

The unit can absorb the smell of rooms, furniture, cigarettes, etc., and then emit it again.

14.2.13 Symptom: The outdoor unit fan does not spin

During operation. The speed of the fan is controlled in order to optimise product operation.

14.2.14 Symptom: The display shows "88"

This is the case immediately after the main power supply switch is turned on and means that the user interface is in normal condition. This continues for one minute.

14.2.15 Symptom: The compressor in the outdoor unit does not stop after a short heating operation

This is to prevent refrigerant from remaining in the compressor. The unit will stop after 5 to 10 minutes.

14.2.16 Symptom: The inside of an outdoor unit is warm even when the unit has stopped

This is because the crankcase heater is warming the compressor so that the compressor can start smoothly.

14.2.17 Symptom: Hot air can be felt when the indoor unit is stopped

Several different indoor units are being run on the same system. When another unit is running, some refrigerant will still flow through the unit.

15 Relocation

Contact your dealer for removing and reinstalling the total unit. Moving units requires technical expertise.

16 Disposal

This unit uses hydrofluorocarbon. Contact your dealer when discarding this unit. It is required by law to collect, transport and discard the refrigerant in accordance with the "hydrofluorocarbon collection and destruction" regulations.

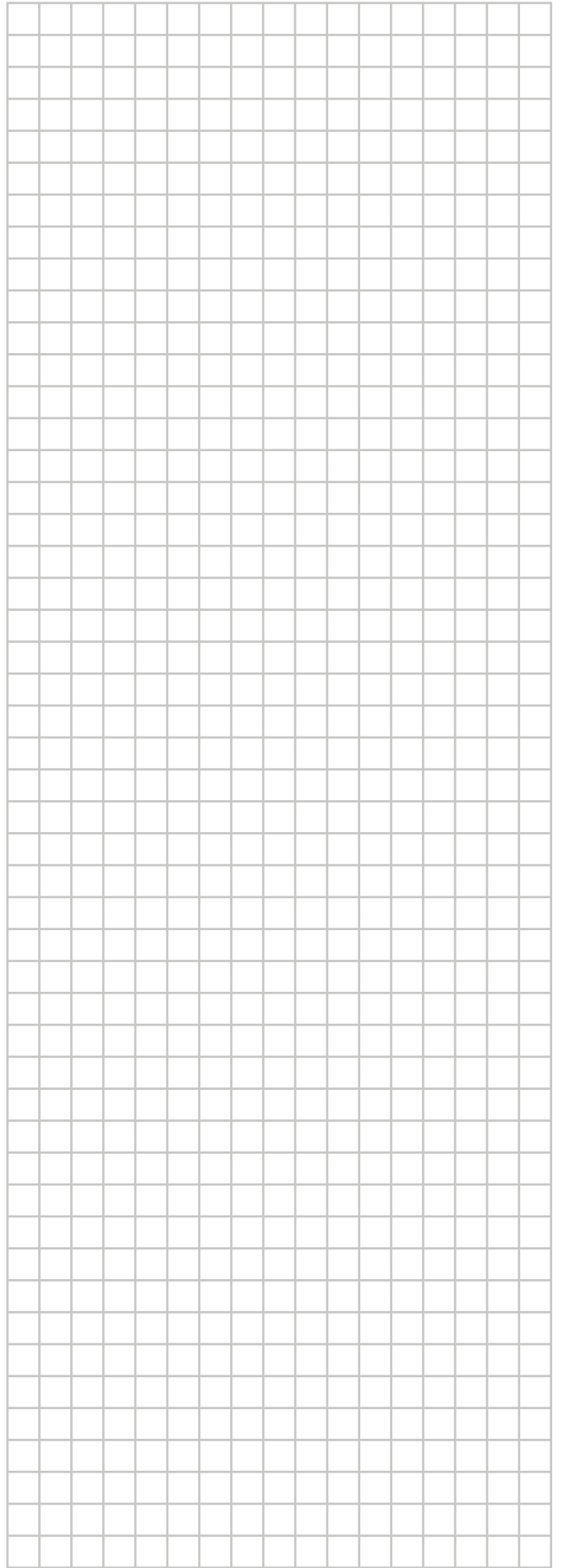
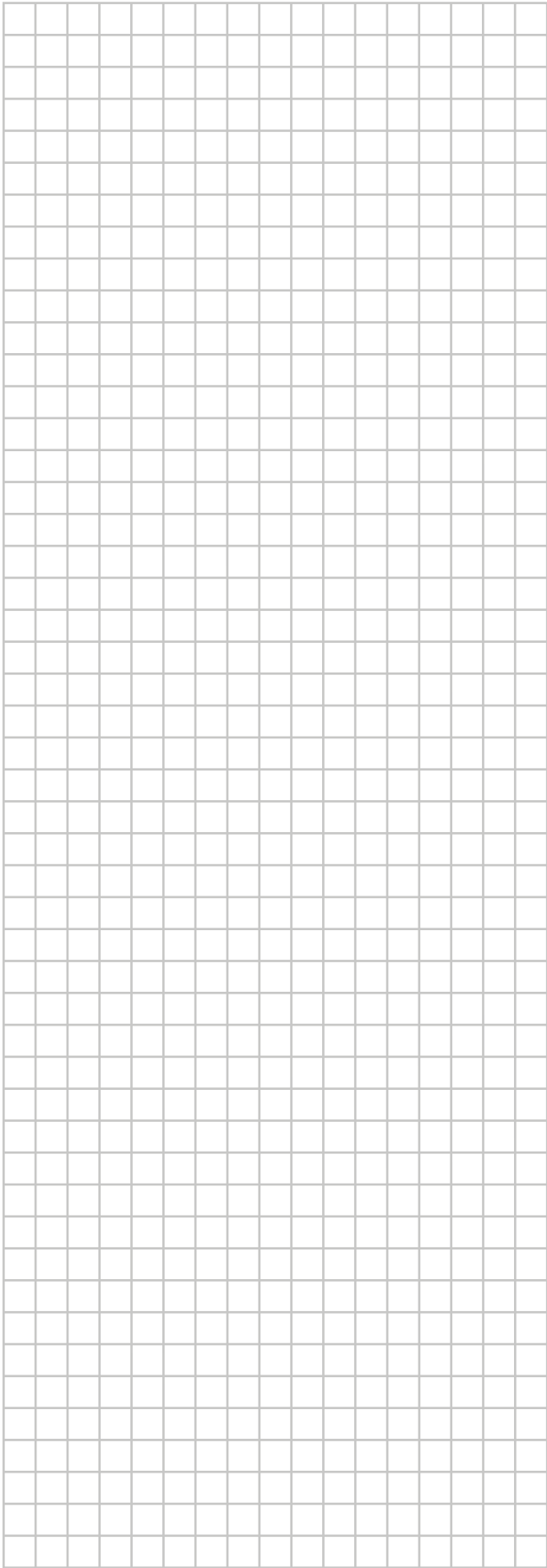

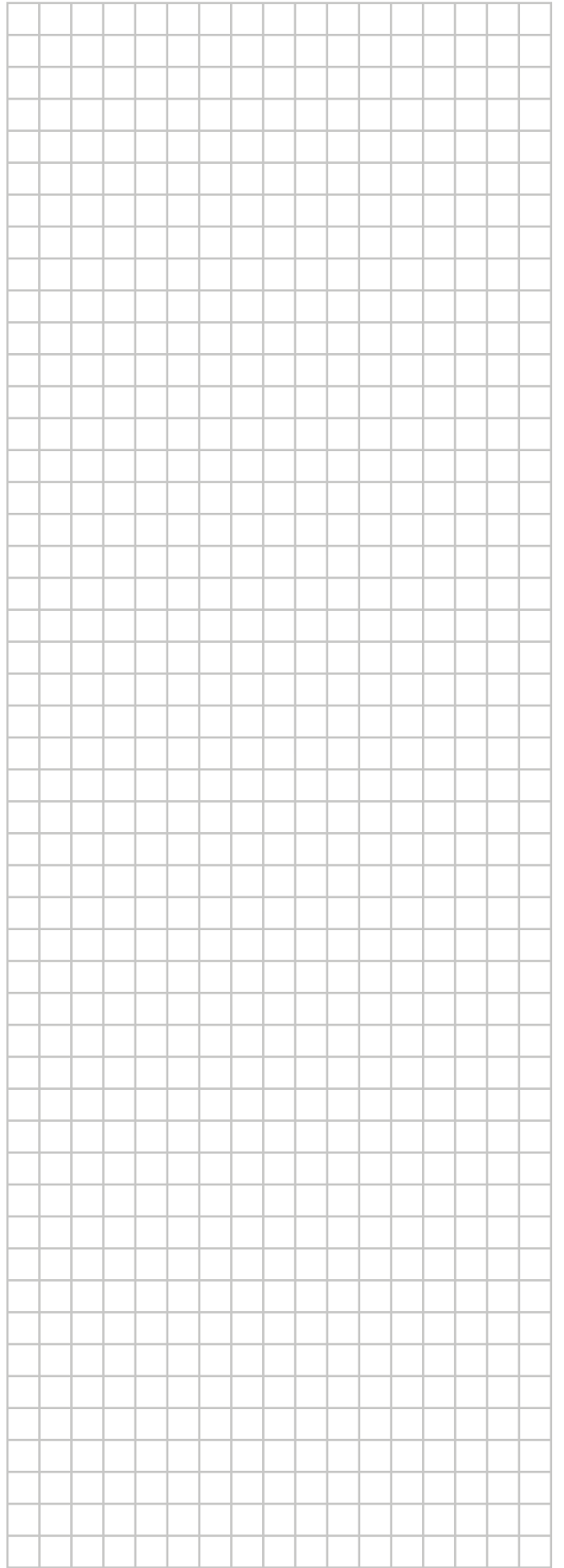
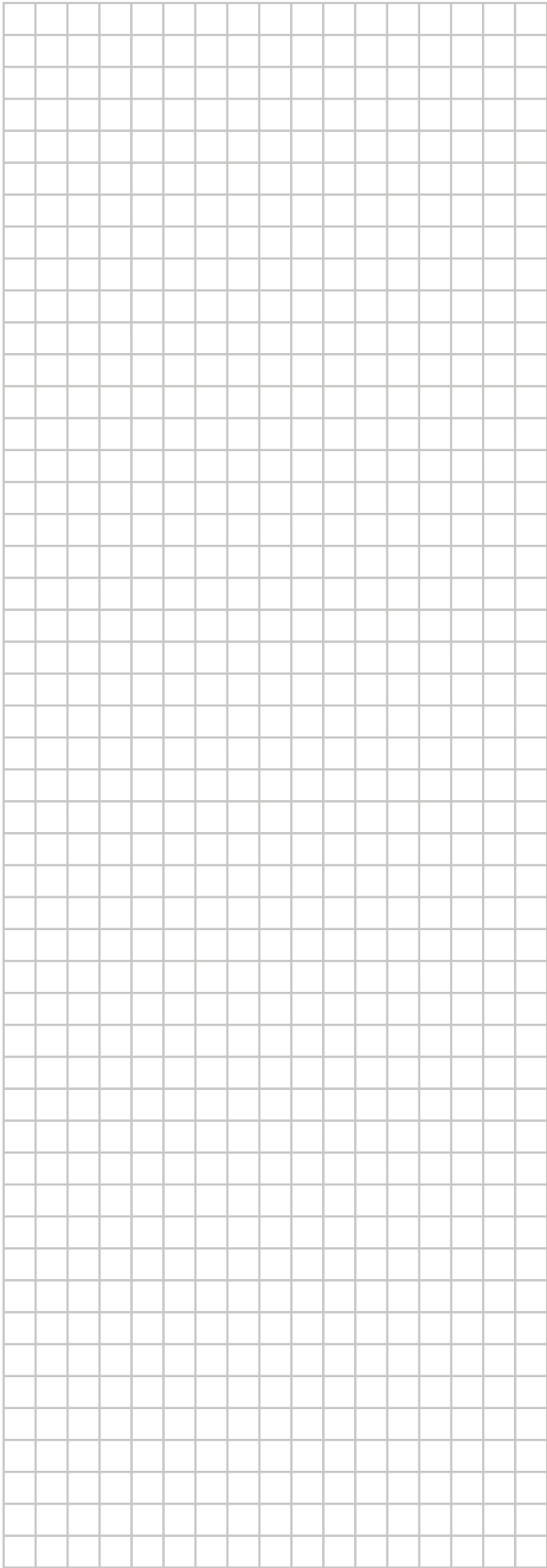

ERC

Copyright 2015 Daikin