

DAIKIN



INSTALLATION MANUAL

VRV III-S System air conditioner

RXYSQ4PA7V1B
RXYSQ5PA7V1B
RXYSQ6PA7V1B

RXYSQ4PA7Y1B
RXYSQ5PA7Y1B
RXYSQ6PA7Y1B

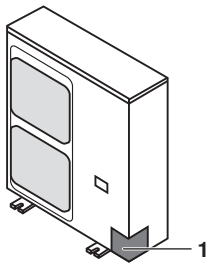

1

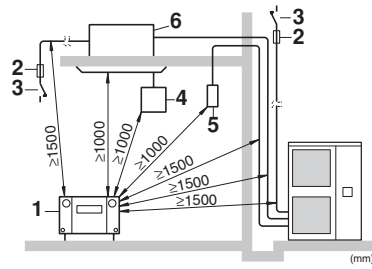

2

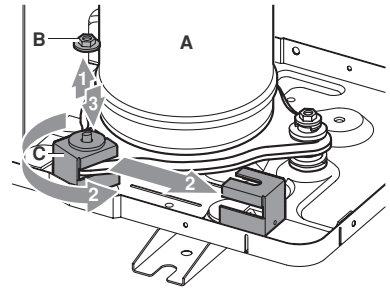

3

	↖	↗	↘	↙	↕	A	B1	B2	C	D1	D2	E	L1/L2		
	✓						≥100								
	✓		✓	✓		≥100	≥100		≥100						
	✓				✓		≥100				≤500	≥1000			
	✓		✓	✓	✓	≥150	≥150		≥150		≤500	≥1000			
		✓									≥500				
			✓								≤500	≥500	≥1000		
	✓	✓					L2>H	≥100			≥500				3
							L2<H	≥100			≥500				
						L2>H	L1≤H	≥250	≤500		≥750		≥1000	0<L1≤1/2 H	1
							H<L1	L1≤H							
						L2<H	L2≤H	≥100			≥1000	≤500	≥1000	0<L2≤1/2 H	3
							H<L2	≥200						1/2 H<L2≤H	
	✓		✓	✓		≥200	≥300		≥1000						
	✓		✓	✓	✓	≥200	≥300		≥1000		≤500	≥1000			
		✓									≥1000				
			✓						≤500	≥1000		≥1000			
	✓	✓					L2>H	≥300			≥1000				
							L2<H	≥250			≥1500			0<L2≤1/2 H	3
								≥300						1/2 H<L2≤H	
						L2>H	L1≤H	≥300	≤500		≥1000		≥1000	0<L1≤1/2 H	1+2
							H<L1	L1≤H							
						L2<H	L2≤H	≥250			≥1500	≤500	≥1000	0<L2≤1/2 H	3
							H<L2	≥300						1/2 H<L2≤H	

4

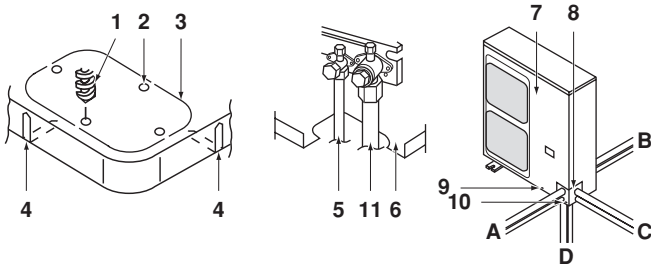

5

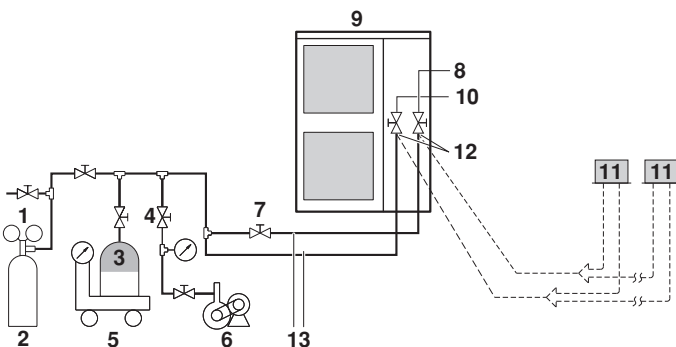

6

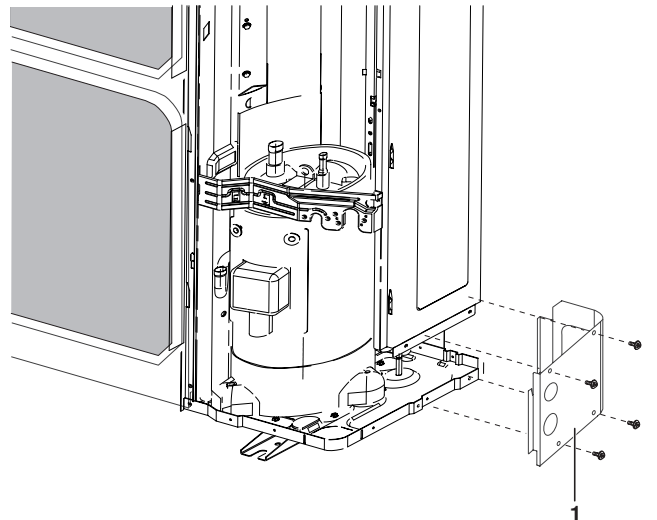

7

CE - DECLARATION-OF-CONFORMITY
CE - KONFORMITÄTSPRÄKLÄRUNG
CE - DECLARATION-DE-CONFORMITE
CE - CONFORMITEITS/VERKLARING

Daikin Europe N.V.

- 01 (en) déclare under its sole responsibility that the air conditioning models to which this declaration relates:
02 (E) erklärt auf seine alleinige Verantwortung die Modelle der Klimageräte für die diese Erklärung bestimmt ist:
03 (E) déclare sous sa seule responsabilité que les appareils d'air conditionné visés par la présente déclaration:
04 (NL) verklaart hierbij op eigen exclusieve verantwoordelijkheid dat de airconditioning units waarop deze verklaring betrekking heeft:
05 (E) declara bajo su única responsabilidad que los modelos de aire acondicionado a los cuales hace referencia la declaración:
06 (E) δηλώνει υπό την αποκλειστική της ευθύνη ότι τα μοντέλα των κλιματιστικών συσκευών στα οποία αναφέρεται η παρούσα δήλωση:
07 (GR) δηλώνει υπό την αποκλειστική της ευθύνη ότι τα μοντέλα των κλιματιστικών συσκευών στα οποία αναφέρεται η παρούσα δήλωση:
08 (P) declara sob sua exclusiva responsabilidade que os modelos de ar condicionado a que esta declaração se refere:

RXYSQ4PA7Y1B*, RXYSQ5P A7Y1B*, RXYSQ6PA7Y1B*,
RXYSQ4PA7Y1B*, RXYSQ5P A7Y1B*, RXYSQ6PA7Y1B*,
*, **, 1, 1.2, 3, ..., 9

01 are in conformity with the following standard(s) or other normative document(s), provided that these are used in accordance with our instructions:
02 der/den folgenden Norm(en) oder einem anderen Normdokument oder Dokumenten entsprechend entsprechen, unter der Voraussetzung,

daß sie gemäß unseren Anweisungen eingesetzt werden:

03 sont conformes à l(au)x norm(e)l(s) ou autre(s) document(s) normatif(s), pour autant qu'ils soient utilisés conformément à nos instructions:
04 conform de volgen de norm(en) of één of meer andere bindende documenten zijn, op voorwaarde dat ze worden gebruikt overeenkomstig onze instructies:

05 están en conformidad con la(s) siguiente(s) norma(s) u otro(s) documento(s) normativo(s), siempre que sean utilizados de acuerdo con nuestras instrucciones:
06 sono conformi all(elle) standard(i) o altro(i) document(o)l(i) a carattere normativo, a patto che vengano usati in conformità alle nostre istruzioni:

07 είναι σύμφωνα με το(ι) ακόλουθ(ο)l(α) πρότυπο(α) ή άλλο(α) έγγραφο(α) κανονιστικό, υπό την προϋπόθεση ότι χρησιμοποιείται σύμφωνα με τις οδηγίες μας:

EN60335-2-40,

- 10 under kapitajelse af bestemmelserne i:
11 enligt vilkåren i:
12 gilt i henhold til bestemmelserne i:
03 conformément aux stipulations des:
04 overeenkomstig de bepalingen van:
06 siguiendo las disposiciones de:
06 secondo le prescrizioni per:
07 με τηρών των διατάξεων των:
08 de acordo com o previsto em:
09 в соответствии с положениями:

19 o upoštevanju določb:

20 vestrašči navedbe:

21 czechajki krajare na:

22 latkans nuostai, patikiam:

14 za doozren ustanoveni priedpis:

15 prema odredbama:

16 követi a(z):

17 zgodnie z postanowieniami Dyrekty:

18 in urma prevederilor:

CE - DECLARAÇÃO-DE-CONFORMIDADE
CE - ЗАРЯВЛЕНИЕ-О-СООТВЕТСТВИИ
CE - OPEYDELSERKLERING
CE - FÖRSÄKRAN-OM-ÖVERENSSTÄMMELSE

CE - IZJAVA-O-USKLABENOSTI
CE - MEGFELELŐSÉG-NYILATKOZAT
CE - DEKLARACJA-ZGODNOSCI
CE - DECLARAȚIE-DE-CONFORMITATE

CE - IZJAVA-O SKLADNOSTI
CE - VASTAVUSDEKLARACIJA
CE - VYHLÁSENIE-ZHODY
CE - UYUMLUKULUK-BİLDİRİSİ

CE - IZJAVA O SKLADNOSTI
CE - VASTAVUSDEKLARACIJA
CE - VYHLÁSENIE-ZHODY
CE - UYUMLUKULUK-BİLDİRİSİ

09 (en) заявляет, исключив только само ответственность, что модели кондиционеров воздуха, к которым относится настоящая заявка:

10 (en) erklærer under enansvar, at klimaanlægsmodelerne, som denne deklaration vedrører:

11 (S) deklarerar i egeniska av huvudsaklig, att luftkonditioneringsmodellerna som berörs av denna deklaration innebär att:

12 (N) erklærer et fuldstændigt ansvar for at de luftkonditioneringsmodeller som berøres af denne deklaration indebærer at:

13 (en) ilmoittaa yksinomaan omalla vastuullaan, että tämän ilmoituksen tarkoituksena ilmoitettuihin malliin:

14 (S) förklarar i sigt ansvar för att de luftkonditioneringsmodeller som omfattas av denna deklaration innebär att:

15 (en) déclare sous sa seule responsabilité que les modèles de climatiseurs, à l'exception de ceux qui sont visés par la présente déclaration:

16 (P) deklaara sob sua exclusiva responsabilidade que os modelos de ar condicionado a que esta declaração se refere:

17 (E) deklaruje na własną odpowiedzialność, że modele klimatyzatorów, których dotyczy niniejsza deklaracja:

18 (E) declara pe proprie răspundere că aparatele de aer condiționat la care se referă această declarație:

19 (S) i svo odgovornosti izjavlja, da so modeli klimatskih naprav, na katere se izjva nanaša:

20 (E) kinnitab oma läbikui vastutuse, et kaasaõva deklaratsiooni alla kuuluvad klimaseadmete mudelid:

21 (E) deklaruje na svo otvorenosti, che modelne klimatizatsionni prielazni modeli, kuriimi se otnoas sazi deklaratsiji:

22 (E) viskaje savo atsakomybe skelbia, kad oro kondicionavimo prietaisai, kuriems yra taikoma ši deklaracija:

23 (E) ar plinu atbildību apliecina, ka tālāk uzskaitīto modeļu gaisa kondicionēļāji, uz kuriem attiecas šī deklarācija:

24 (E) vyhlásuje na vlastní zodpovednost, že leto klimatizačné modely, na ktoré sa vzťahuje toto vyhlásenie:

25 (E) lamamen kendi sorumluluğunda otmak üzere bu bildirimli oluğu klima modellerinin aşağıdaki gibi olduğunu beyan eder:

08 estão em conformidade com as) seguinte(s) norma(s) ou outro(s) documento(s) normativo(s), desde que estes sejam utilizados de acordo com as nossas instruções:

09 соответствуют следующим стандартам или другим нормативным документам, при условии их использования согласно нашим инструкциям:

10 overholder følgende standard(er) eller andre andre retningsgivende dokument(er), brudsat at disse anvendes i henhold til vore instruks:

11 respektive utrustning är tillförd i överensstämmelse med och följer följande standard(er) eller andra normgivande dokument, under förutsättning att användning sker i överensstämmelse med våra instruktioner:

12 respektive utstyr er i overensstemmelse med følgende standard(er) eller andre normgivende dokument(er), under forudsætning av at disse brukes i henhold til våre instruks:

13 nastavaq seuraavien standardien ja muiden ohjeellisten dokumenttien vaatimuksissa edellytäten, että niitä käytetään ohjeidemme mukaisesti:

14 za předpokladu, že jsou využívány v souladu s našimi pokyny, odpovídají následujícím normám nebo normativním dokumentům:

15 i skladu sa stajędzim standardom(i)mi) ii drugim normativnim dokumentom(i)mi), uz vjezt da se oni koriste u skladu s našim uputama:

16 megfelelnek az alábbi szabvány(ok)nak egy egyébké irányadó dokumentum(ok)nak, ha azokat előírás szerinti használat:

17 megfelel a következő szabvány(ok) vagy egyéb irányadó dokumentum(ok)nak, ha azokat előírás szerinti használat:

18 sunt în conformitate cu următor(ormătoare)le standarde(e) sau alte(e) documente(e) normative), cu condiția ca acestea să fie utilizate în conformitate cu instrucțiunile noastre:

19 skladu naslednjih standardi in drugim normativi, pod pogojem, da se uporabljajo v skladu z našimi navodili:

20 u skladu sa našim uslovima, koji se odnose na sledeće standarde ili druge normativne dokumente, uz pretpostavku, da se koriste u skladu sa našim uslovima:

21 съответстват на следните стандарти или други нормативни документи, при условие, че се използват съгласно нашите инструкции:

22 atitinka žemiau nurodytus standartus ir (arba) kitus norminius dokumentus su sąlyga, kad yra naudojami pagal mūsų nurodymus:

23 tad, ja leibti atitiktisi razloža nortudjema, abisi se kojostojen standardim in oitem normativnim dokumentim:

24 sú v zhode s nasledovnými normami) alebo inými) normatívnymi() dokumentom(i)mi), za predpokladu, že sa používajú v súlade s našimi návodmi:

25 inünün, talimatlarına göre kullanımınıza yardımcı olacak standartlar ve norm belirlen belgelerle ilgiliymi:

19 Direktiver, med senere ændringer.

12 Direktiv, med foretagne ændringer.

21 Direktiv, с текними изменения.

22 Direktivose su paplytimais.

13 Direktiveja, seriasini kun te ovat muutetulla.

14 platenen zneni.

15 Smernice, kako je izmjenjeno.

16 irányelvek és módosítások rendelkezéseit.

17 z późniejszych poprawkami.

18 Directivelor, cu amendamentele respective.

16 Megjegyzés* a(z) <A> alapján, a(z) igazolta a megfelelést, a(z) <C> tanúsítvány szerinti.

17 Uwaga* zgodnie z dokumentacją <A> pozytywną opinią jedkome Swiadectwem <C>

18 Nota* asa cum este stabilit in <A> si anexat pozitiv hysăsiy/Sertificatul <C> măsăsi.

19 Opomba* koji je dobiven u <A> in odobren s strani v skladu s osvedečenim <C>

20 Märkus* kako je izobeno u <A> pozitivno odobreno od strane prema Certificatu <C>

19 Direktiver, med senere ændringer.

12 Direktiv, med foretagne ændringer.

21 Direktiv, с текними изменения.

22 Direktivose su paplytimais.

13 Direktiveja, seriasini kun te ovat muutetulla.

14 platenen zneni.

15 Smernice, kako je izmjenjeno.

16 irányelvek és módosítások rendelkezéseit.

17 z późniejszych poprawkami.

18 Directivelor, cu amendamentele respective.



3PW40544-1A

DAIKIN EUROPE N.V.
Zandvoordestraat 300, B-8400 Oostende, Belgium

<A>	DAIKIN.TCF.024C1/05-2007
	TNO
<C>	0510260101

CONTENTS

	Page
1. Safety considerations	1
2. Introduction	2
2.1. Combination	2
2.2. Standard supplied accessories	2
2.3. Optional accessories	2
2.4. Technical and electrical specifications	3
3. Before installation	3
3.1. Precautions for R410A	3
3.2. Installation	3
3.3. Handling	3
4. Selecting installation site	3
5. Precautions on installation	4
5.1. Installation method for prevention of falling over	4
5.2. Method for removing transportation stay	4
5.3. Method for installing drain piping	4
6. Installation servicing space	5
7. Refrigerant pipe size and allowable pipe length	5
7.1. Selection of piping material	6
8. Precautions on refrigerant piping	6
8.1. Cautions for brazing	6
8.2. Cautions for flare connection	6
9. Refrigerant piping	7
9.1. Preventing foreign objects from entering	7
9.2. Cautions for handling stop valve	7
9.3. How to use the stop valve	8
9.4. Cautions for handling the valve cover	8
9.5. Cautions for handling service port	8
9.6. Precautions when connecting field piping and regarding insulation	8
9.7. Leak test and vacuum drying	10
10. Additional refrigerant charge	10
10.1. Important information regarding the refrigerant used	10
10.2. 3 procedures for adding refrigerant	11
11. Electrical wiring work	13
11.1. Internal wiring – Parts table	13
11.2. Precautions on electrical wiring work	14
11.3. Connection example of total system wiring	14
11.4. Connecting power wire and transmission wires	15
11.5. Power circuit and cable requirements	15
12. Before operation	17
12.1. Service precautions	17
12.2. Checks before initial start-up	17
12.3. Field setting	17
12.4. Test operation	19
12.5. Checks in normal operation	20
12.6. Temperature adjustment operation confirmation	20
13. Service mode operation	21
14. Caution for refrigerant leaks	21
14.1. Introduction	21
14.2. Maximum concentration level	21
14.3. Procedure for checking maximum concentration	21
15. Disposal requirements	22



READ THESE INSTRUCTIONS CAREFULLY BEFORE INSTALLATION. KEEP THIS MANUAL IN A HANDY PLACE FOR FUTURE REFERENCE.

IMPROPER INSTALLATION OR ATTACHMENT OF EQUIPMENT OR ACCESSORIES COULD RESULT IN ELECTRIC SHOCK, SHORT-CIRCUIT, LEAKS, FIRE OR OTHER DAMAGE TO THE EQUIPMENT. BE SURE ONLY TO USE ACCESSORIES MADE BY DAIKIN WHICH ARE SPECIFICALLY DESIGNED FOR USE WITH THE EQUIPMENT AND HAVE THEM INSTALLED BY A PROFESSIONAL.

DAIKIN EQUIPMENT IS DESIGNED FOR COMFORT APPLICATIONS. FOR USE IN OTHER APPLICATIONS, PLEASE CONTACT YOUR LOCAL DAIKIN DEALER.

IF UNSURE OF INSTALLATION PROCEDURES OR USE, ALWAYS CONTACT YOUR DEALER FOR ADVICE AND INFORMATION.

THIS AIR CONDITIONER COMES UNDER THE TERM "APPLIANCES NOT ACCESSIBLE TO THE GENERAL PUBLIC".

1. SAFETY CONSIDERATIONS

The precautions listed here are divided into the following two types. Both cover very important topics, so be sure to follow them carefully.



WARNING

If the warning is not observed, it may cause serious casualties.

CAUTION

If the caution is not observed, it may cause injury or damage to the equipment.

Warning

- Ask your dealer or qualified personnel to carry out installation work. Do not install the machine by yourself. Improper installation may result in water leakage, electric shocks or fire.
- Perform installation work in accordance with this installation manual. Improper installation may lead to water leakage, electric shocks or fire.
- When a unit is installed in a small room, it is necessary to take measures so that the leaked refrigerant amount does not exceed the limit even if it leaks. As for the measures to prevent the leak from not exceeding the limit, please consult with your distributor. If the leaked amount exceeds the limit, it may cause an oxygen deficiency accident.
- Be sure to use only the specified accessories and parts for installation work. Failure to use the specified parts may result in water leakage, electric shocks, fire, or the unit falling.
- Install the air conditioner on a foundation that can withstand its weight. Insufficient strength may result in the fall of equipment and causing injury.
- Carry out the specified installation work in consideration of strong winds, typhoons, or earthquakes. Improper installation work may result in accidents due to fall of equipment.

- Make certain that all electrical work is carried out by qualified personnel according to the local laws and regulations and this installation manual, using a separate circuit. Insufficient capacity of the power supply circuit or improper electrical construction may lead to electric shocks or fire.
- Make sure that all wiring is secure, using the specified wires and ensuring that external forces do not act on the terminal connections or wires. Incomplete connection or fixing may cause a fire.
- When wiring between the indoor and outdoor units, and wiring the power supply, form the wires so that the frontside panel can be securely fastened. If the frontside panel is not in place, the terminals may overheat and electric shocks or a fire may be caused.
- If refrigerant gas leaks during installation work, ventilate the area immediately. Toxic gas may be produced if refrigerant gas comes into contact with fire.
- After completing the installation work, check to make sure that there is no leakage of refrigerant gas. Toxic gas may be produced if refrigerant gas leaks into the room and comes into contact with a source of fire, such as a fan heater, stove or cooker.
- Before touching electric terminal parts, turn off power switch.

Caution

- Ground the air conditioner. Grounding resistance should be according to national regulations. Do not connect the earth wire to gas or water pipes, lightning conductor or telephone earth wire. Incomplete grounding may cause electric shocks. 
 - Gas pipe. Ignition or explosion may occur if the gas leaks.
 - Water pipe. Hard vinyl tubes are not effective grounds.
 - Lightning conductor or telephone ground wire. Electric potential may rise abnormally if struck by a lightning bolt.
- Be sure to install an earth leakage breaker. Failure to install an earth leakage breaker may cause electric shocks or fire.
- Install drain piping according to this installation manual to ensure good drainage, and insulate the pipe to prevent condensation. Improper drain piping may cause water leakage, and make the furniture get wet.
- Install the indoor and outdoor units, power wire and connecting wire at least 1 meter away from televisions or radios to prevent image interference or noise. (Depending on the radio waves, a distance of 1 meter may not be sufficient to eliminate the noise.)
- Do not rinse the outdoor unit. This may cause electric shocks or fire.
- Do not install the air conditioner in places such as the following:
 - Where there is mist of mineral oil, oil spray or vapour for example a kitchen. Plastic parts may deteriorate, and cause them to fall out or water to leak.
 - Where corrosive gas, such as sulfurous acid gas, is produced. Corrosion of copper pipes or soldered parts may cause the refrigerant to leak.
 - Where there is machinery which emits electromagnetic waves. Electromagnetic waves may disturb the control system, and cause malfunction of the equipment.

- Where flammable gases may leak, where carbon fiber or ignitable dust is suspended in the air or where volatile flammables, such as thinner or gasoline, are handled. Such gases may cause a fire.
- Where the air contains high levels of salt such as that near the ocean.
- Where voltage fluctuates a lot, such as that in factories.
- In vehicles or vessels.
- Where acidic or alkaline vapour is present.
- Do not allow a child to mount on the outdoor unit or avoid placing any object on the unit. Falling or tumbling may result in injury.
- Do not touch any refrigerant which has leaked out of refrigerant piping connections. This may result in frostbite.

2. INTRODUCTION





2.1. Combination

The indoor units can be installed in the following range.

- Always use appropriate indoor units compatible with R410A. To learn which models of indoor units are compatible with R410A, refer to the product catalogs.
- Total capacity/number of indoor units

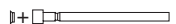
Outdoor unit	Total capacity of indoor units	Total number of indoor units
RXYSQ4	50~130	6
RXYSQ5	62.5~162.5	8
RXYSQ6	70~182	9

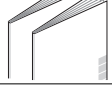
2.2. Standard supplied accessories

Gas line piping (1) ^(*) + copper gasket	1	
Gas line piping (2) ^(*)	1	
Gas line piping (3) ^(*)	1	
Installation manual Operation manual	1 1	
Fluorinated greenhouse gases label	1	
Multilingual fluorinated greenhouse gases label	1	

(*) Only for RXYSQ6.

Location of accessories: refer to [figure 1](#).

1 Accessories

2.3. Optional accessories

To install the above outdoor units, the following optional parts are also required.

- Refrigerant branching kit (for R410A only: Always use an appropriate kit dedicated for your system.)

Refnet header	Refnet joint
KHRQ22M29H	KHRQ22M20T

To select an optimum refrigerant branching kit, refer to "[Refrigerant branch kit selection](#)" on page 9.

2.4. Technical and electrical specifications

Refer to the Engineering Data Book for the complete list of specifications.

3. BEFORE INSTALLATION



Since design pressure is 4.0 MPa or 40 bar, pipes of larger wall thickness may be required. Refer to paragraph "7.1. Selection of piping material" on page 6.

3.1. Precautions for R410A

- The refrigerant requires strict cautions for keeping the system clean, dry and tight.
 - Clean and dryForeign materials (including mineral oils or moisture) should be prevented from getting mixed into the system.
 - TightRead "8. Precautions on refrigerant piping" on page 6 carefully and follow these procedures correctly.
- Since R410A is a mixed refrigerant, the required additional refrigerant must be charged in its liquid state. (If the refrigerant is in state of gas, its composition changes and the system will not work properly).
- The connected indoor units must be indoor units designed exclusively for R410A.

3.2. Installation

- For installation of the indoor unit(s), refer to the indoor unit installation manual.
- Never operate the air conditioner with the discharge pipe thermistor (R2T), suction pipe thermistor (R3T) and pressure sensors (S1NPH, S1NPL) removed. Such operation may burn out the compressor.
- Be sure to confirm the model name and the serial no. of the outer (front) plates when attaching/detaching the plates to avoid mistakes.
- When closing the service panels, take care that the tightening torque does not exceed 4.1 N·m.

3.3. Handling

As shown in the figure, bring the unit slowly by grabbing the left and right grips.

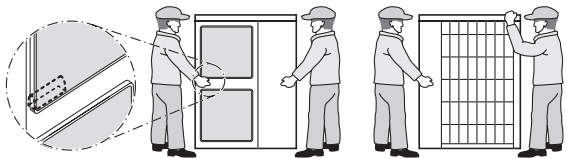

Place your hands on the corner instead of holding the suction inlet in the side of the casing, otherwise the casing could be deformed.



Take care not to let hands or objects come in contact with rear fins.

4. SELECTING INSTALLATION SITE

This is a class A product. In a domestic environment this product may cause radio interference in which case the user may be required to take adequate measures.



- Make sure to provide for adequate measures in order to prevent that the outdoor unit be used as a shelter by small animals.
- Small animals making contact with electrical parts can cause malfunctions, smoke or fire. Please instruct the customer to keep the area around the unit clean.

- 1 Select an installation site where the following conditions are satisfied and that meets with your customer's approval.
 - Places which are well-ventilated.
 - Places where the unit does not bother next-door neighbours.
 - Safe places which can withstand the unit's weight and vibration and where the unit can be installed level.
 - Places where there is no possibility of flammable gas or product leak.
 - Places where servicing space can be well ensured.
 - Places where the indoor and outdoor units' piping and wiring lengths come within the allowable ranges.
 - Places where water leaking from the unit cannot cause damage to the location (e.g. in case of a blocked drain pipe).
 - Places where the rain can be avoided as much as possible.

- 2 When installing the unit in a place exposed to strong wind, pay special attention to the following.

Strong winds of 5 m/sec or more blowing against the outdoor unit's air outlet causes short circuit (suction of discharge air), and this may have the following consequences:

- Deterioration of the operational capacity.
 - Frequent frost acceleration in heating operation.
 - Disruption of operation due to rise of high pressure.
 - When a strong wind blows continuously on the face of the unit, the fan can start rotating very fast until it breaks.
- Refer to the figures for installation of this unit in a place where the wind direction can be foreseen.

- Turn the air outlet side toward the building's wall, fence or screen.

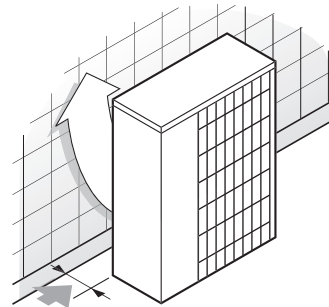

➔ Make sure there is enough room to do the installation

- Set the outlet side at a right angle to the direction of the wind.

Strong wind

Blown air

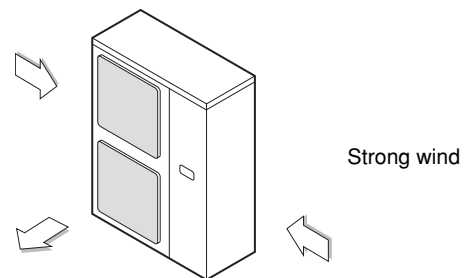

- 3 Prepare a water drainage channel around the foundation, to drain waste water from around the unit.

- 4 If the water drainage of the unit is not easy, please build up the unit on a foundation of concrete blocks, etc. (the height of the foundation should be maximum 150 mm).
- 5 If you install the unit on a frame, please install a waterproof plate within 150 mm of the underside of the unit in order to prevent the invasion of water from the lower direction.
- 6 When installing the unit in a place frequently exposed to snow, pay special attention to the following:
 - Elevate the foundation as high as possible.
 - Construct a large canopy (field supply).
 - Remove the rear suction grille to prevent snow from accumulating on the rear fins.
- 7 The outdoor unit may short circuit depending on its environment, so use the louvers (field supply).
- 8 If you install the unit on a building frame, please install a waterproof plate (within 150 mm of the underside of the unit) or use a drain plug kit (option) in order to avoid the drain water dripping.

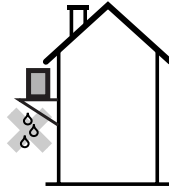

The equipment described in this manual may cause electronic noise generated from radio-frequency energy. The equipment complies to specifications that are designed to provide reasonable protection against such interference. However, there is no guarantee that interference will not occur in a particular installation.

It is therefore recommended to install the equipment and electric wires keeping proper distances away from stereo equipment, personal computers, etc... (See figure 2)

- 1 Personal computer or radio
- 2 Fuse
- 3 Earth leakage breaker
- 4 Remote controller
- 5 Cool/heat selector
- 6 Indoor unit

In extreme circumstances you should keep distances of 3 m or more and use conduit tubes for power and transmission lines.

5. PRECAUTIONS ON INSTALLATION

- Check the strength and level of the installation ground so that the unit will not cause any operating vibration or noise after installation.
- In accordance with the foundation drawing in the figure, fix the unit securely by means of the foundation bolts. (Prepare four sets of M12 foundation bolts, nuts and washers each which are available on the market.)
- It is best to screw in the foundation bolts until their length are 20 mm from the foundation surface.

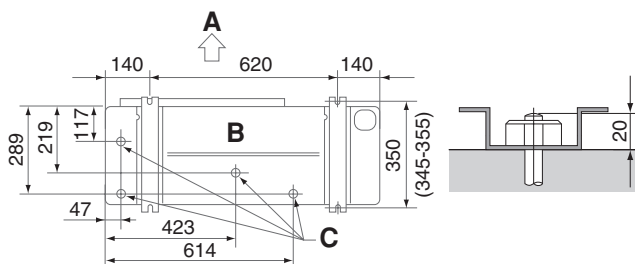

- A Discharge side
- B Bottom view (mm)
- C Drain hole

5.1. Installation method for prevention of falling over

If it is necessary to prevent the unit from falling over, install as shown in the figure.

- prepare all 4 wires as indicated in the drawing
- unscrew the top plate at the 4 locations indicated A and B
- put the screws through the nooses and screw them back tight

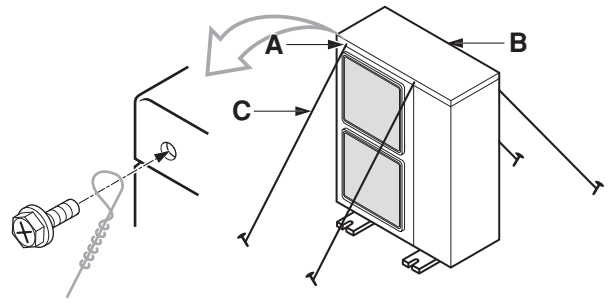

- A location of the 2 fixation holes on the front side of the unit
- B location of the 2 fixation holes on the rear side of the unit
- C wires: field supply

5.2. Method for removing transportation stay

The yellow transportation stay installed over the compressor leg for protecting the unit during transport must be removed. Proceed as shown in figure 3 and described below.

- A Compressor
- B Fixing nut
- C Transportation stay

- 1 Slightly loosen the fixing nut (B).
- 2 Remove the transportation stay (C) as shown in figure 3.
- 3 Tighten the fixing nut (B) again.



CAUTION

If the unit is operated with the transportation stay attached, abnormal vibration or noise may be generated.

5.3. Method for installing drain piping

Depending on installation site, it may be required to install drain plug for drainage (option kit).

In cold areas, do not use a drain hose with the outdoor unit. Otherwise, drain water may freeze, impairing the heating performance.

- 1 See figure below for installation of the drain plug.

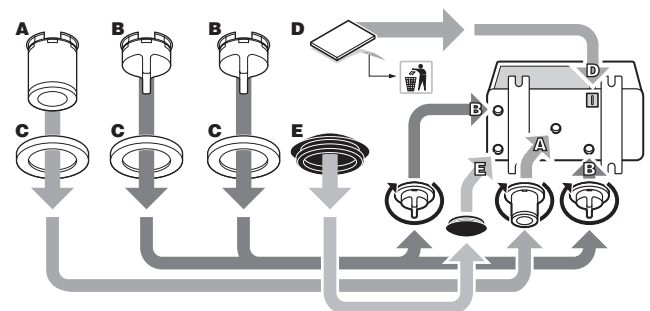

- A Drain socket
- B Drain cap
- C Drain receiver
- D Insulation tape
- E Drain stop

- 2 Connect a field supplied vinyl hose (internal diameter of 25 mm) to the drain socket (A).
If the hose is too long and hangs down, fix it carefully to prevent kinks.



NOTE If drain holes of the outdoor unit are covered by a mounting base or by floor surface, raise the unit in order to provide a free space of more than 100 mm under the outdoor unit.

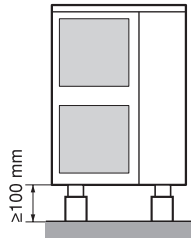

6. INSTALLATION SERVICING SPACE

- The connection piping outlet direction in the installation shown in figure 4 is frontward or downward. The unit of numeric values is mm.
- When routing the piping backward, secure space of ≥ 250 mm on the right side of the unit.

(A) In case of non-stacked installation (See figure 4)

- | | | | |
|--|-------------------------|---|--|
| | Suction side obstacle | 1 | In these cases, close the bottom of the installation frame to prevent the discharged air from being bypassed |
| | Discharge side obstacle | | |
| | Left side obstacle | 2 | In these cases, only 2 units can be installed. |
| | Right side obstacle | 3 | In these cases, no restriction of height L1. |
| | Top side obstacle | | This situation is not allowed |
| | Obstacle is present | | |

(B) In case of stacked installation

1. In case obstacles exist in front of the outlet side.

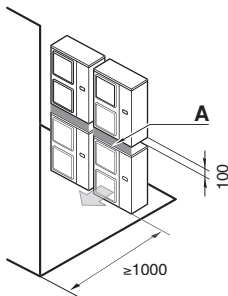

2. In case obstacles exist in front of the air inlet.

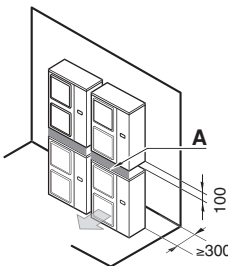

NOTE



- Do not stack more than one unit.
- About 100 mm is required as the dimension for laying the upper outdoor unit's drain pipe.
- Get the portion A sealed so that air from the outlet does not bypass.

(C) In case of multiple-row installation (for roof top use, etc.)

1. In case of installing one unit per row.

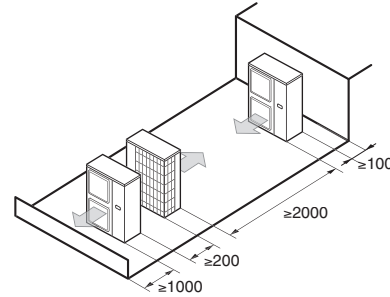

2. In case of installing multiple units (2 units or more) in lateral connection per row.

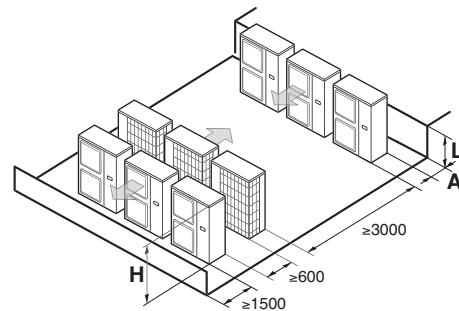

Relation of dimensions between H, A and L is shown in the table below.

	L	A
L ≤ H	0 < L ≤ 1/2H	250
	1/2H < L ≤ H	300
H < L	Installation impossible	

7. REFRIGERANT PIPE SIZE AND ALLOWABLE PIPE LENGTH



All field piping must be installed by a licensed refrigeration technician and must comply with relevant local and national regulations.



To persons in charge of piping work:

- Be sure to open the stop valve after piping installing and vacuuming is complete. (Running the system with the valve closed may break the compressor.)
- It is forbidden to discharge refrigerant into the atmosphere. Collect the refrigerant in accordance with the freon collection and destruction law.
- Do not use flux when brazing the refrigerant piping. For brazing, use phosphor copper brazing filler metal (BCuP) which does not require a flux. (If a chlorine flux is used, the piping will corrode, and if the flux contains fluoride, it will cause the coolant oil to deteriorate, adversely affecting the coolant piping system.)

7.1. Selection of piping material

- Foreign materials inside pipes (including oils for fabrication) must be ≤ 30 mg/10 m.
- Construction material: phosphoric acid deoxidized seamless copper for refrigerant.
- Temper grade: use piping with temper grade in function of the pipe diameter as listed in table below.
- The pipe thickness of the refrigerant piping should comply with relevant local and national regulations. The minimal pipe thickness for R410A piping must be in accordance with the table below.

Pipe Ø	Temper grade of piping material	Minimal thickness t (mm)
6.4 / 9.5 / 12.7	O	0.80
15.9	O	1
19.1	1/2H	1

O = Annealed
1/2H = Half hard

- Make sure to use the particular branches of piping that have been selected.
- In case the required pipe sizes (inch sizes) are not available, it is also allowed to use other diameters (mm sizes), taken the following into account:
 - select the pipe size nearest to the required size.
 - use the suitable adapters for the change-over from inch to mm pipes (field supply).

8. PRECAUTIONS ON REFRIGERANT PIPING

- Do not allow anything other than the designated refrigerant to get mixed into the freezing cycle, such as air, etc. If any refrigerant gas leaks while working on the unit, ventilate the room thoroughly right away.
- Use R410A only when adding refrigerant
Installation tools:
Make sure to use installation tools (gauge manifold charge hose, etc.) that are exclusively used for R410A installations to withstand the pressure and to prevent foreign materials (e.g. mineral oils and moisture) from mixing into the system.
Vacuum pump:
Use a 2-stage vacuum pump with a non-return valve
Make sure the pump oil does not flow oppositely into the system while the pump is not working.
Use a vacuum pump which can evacuate to -100.7 kPa (5 Torr, -755 mm Hg).
- In order to prevent dirt, liquid or dust from entering the piping, cure the piping with a pinch or taping.

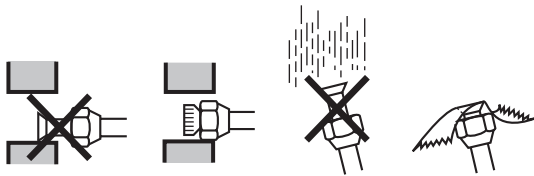

	Installation period	Protection method
	More than a month	Pinch the pipe
	Less than a month	Pinch or tape the pipe
	Regardless of the period	

Great caution is needed when passing copper tubes through walls.

- For handling of stop valves, refer to "9.3. How to use the stop valve" on page 8.
- Only use the flare nuts included with the unit. Using different flare nuts may cause the refrigerant to leak.

- Always use the supplied copper gasket when connecting the gas pipe supplied with the unit. See "9. Refrigerant piping" on page 7.

8.1. Cautions for brazing

- Be sure to carry out a nitrogen blow when brazing. Brazing without carrying out nitrogen replacement or releasing nitrogen into the piping will create large quantities of oxidized film on the inside of the pipes, adversely affecting valves and compressors in the refrigerating system and preventing normal operation.
- When brazing while inserting nitrogen into the piping, nitrogen must be set to 0.02 MPa with a pressure-reducing valve (=just enough so that it can be felt on the skin).

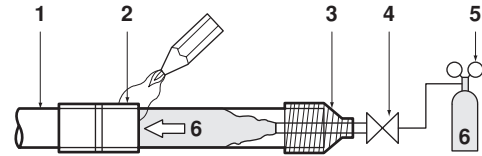

- Refrigerant piping
- Part to be brazed
- Taping
- Hand valve
- Pressure-reducing valve
- Nitrogen

8.2. Cautions for flare connection

- See the following table for flare part machining dimensions.
- When connecting the flare nuts, apply refrigerant ether or ester oil to the inside and outside of the flares and turn them three or four times at first.

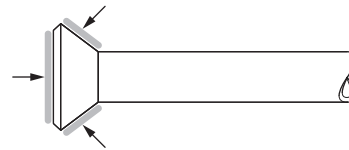

- When loosening a flare nut, always use two wrenches in combination. When connecting the piping, always use a spanner and torque wrench in combination to tighten the flare nut.

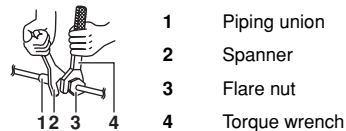

- See the following table for tightening torque. (Applying too much torque may cause the flares to crack.)

Pipe size	Tightening torque (N·m)	A (mm)	Flare shape
Ø9.5	32.7~39.9	12.8~13.2	
Ø15.9	61.8~75.4	19.3~19.7	
Ø19.1	97.2~118.6	12.3~23.7	

- After all the piping has been connected, use nitrogen to perform a gas leak check.

NOTE

You must use a torque wrench but if you are obliged to install the unit without a torque wrench, you may follow the installation method mentioned below.

After the work is finished, make sure to check that there is no gas leak.

When you keep on tightening the flare nut with a spanner, there is a point where the tightening torque suddenly increases. From that position, further tighten the flare nut within the angle shown below:

Pipe size	Further tightening angle	Recommended arm length of tool
Ø9.5 (3/8")	60~90°	±200 mm
Ø15.9 (5/8")	30~60°	±300 mm
Ø19.1 (5/8")	20~35°	±450 mm

9. REFRIGERANT PIPING

- Field pipes can be installed in four directions.

Figure - Field pipes in four directions (See figure 5)

- 1 Drill
 - 2 Center area around knockout hole
 - 3 Knockout hole
 - 4 Slit
 - 5 Connecting pipe liquid (field supply)
 - 6 Bottom frame
 - 7 Front plate
 - 8 Pipe outlet plate
 - 9 Screw front plate
 - 10 Pipe outlet plate screw
 - 11 Connecting pipe gas (field supply, except RXYSQ6)
- A Forward
B Backward
C Sideways
D Downward

When connecting the piping in the lateral direction (on the rear), remove the piping cover (rear) in reference to figure 7.

- 1 Piping cover (rear)

- To install the connecting pipe to the unit in a downward direction, make a knockout hole by penetrating the center area around the knockout hole using a Ø6 mm drill. (See figure 5).
- Cutting out the two slits makes it possible to install as shown in figure 5. (Use a metal saw to cut out the slits.)
- After knocking out the knock-out, it is recommended to apply repair paint to the edge and the surrounding end surfaces to prevent rusting.

For RXYSQ6 only

The size of the gas side stop valve is Ø15.9 while the inter-unit piping is Ø19.1. Use the standard supplied accessory piping to make the connection. See figure 15.

- A Front connection
B Rear connection
C Side connection
D Bottom connection
- 1 Gas line piping + copper gasket supplied with the unit (make sure to always use the copper gasket).
 - 2 Gas line piping supplied with the unit
 - 3 Gas piping (field supply)
 - 4 Cut to the appropriate length.
 - 5 Gas line piping supplied with the unit

9.1. Preventing foreign objects from entering

Plug the pipe through-holes with putty or insulating material (field supply) to stop up all gaps, as shown in the figure.

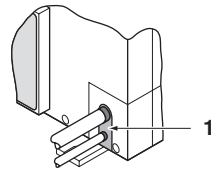

- 1 Putty or insulating material (field supply)

Insects or small animals entering the outdoor unit may cause a short circuit in the electrical box.

9.2. Cautions for handling stop valve

- The stop valves for indoor-outdoor connecting piping are closed at shipment from the factory.



Make sure to keep the valve open during operation.

The names of parts of the stop valve are shown in the figure.

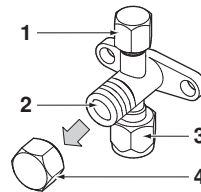

- 1 Service port
- 2 Stop valve
- 3 Field piping connection
- 4 Valve cover

- Since the side boards may be deformed if only a torque wrench is used when loosening or tightening flare nuts, always lock the stop valve with a wrench and then use a torque wrench. Do not place wrenches on the valve cover.

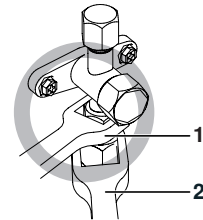
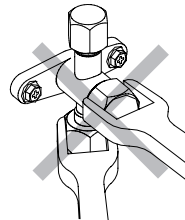

- 1 Spanner
- 2 Torque wrench

Do not apply force on the valve cover, this may result in a refrigerant leak.

- For cooling operation under low ambient temperature or any other operation under low pressure, apply silicon pad or similar to prevent freezing of the gas stop valve flare nut (see figure). Freezing of the flare nut may cause refrigerant leak.

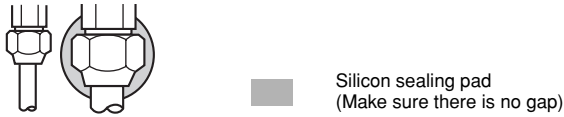

9.3. How to use the stop valve

Use hexagonal wrenches 4 mm and 6 mm.

- Opening the valve
 - Place the hex wrench on the valve bar and turn counter-clockwise.
 - Stop when the valve bar no longer turns. It is now open.
- Closing the valve
 - Place the hex wrench on the valve bar and turn clockwise.
 - Stop when the valve bar no longer turns. It is now closed.

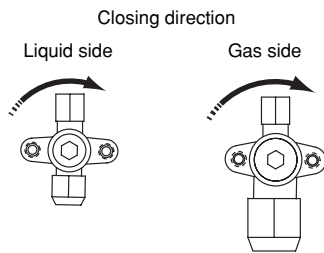

9.4. Cautions for handling the valve cover

- The valve cover is sealed where indicated by the arrow. Take care not to damage it.
- After operating the valve, be sure to tighten the valve cover properly.

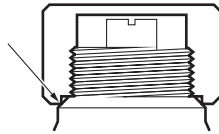

Tightening torque	
Liquid pipe	13.5~16.5 N•m
Gas pipe	22.5~27.5 N•m

- Check for refrigerant leakage after tightening the cap.

9.5. Cautions for handling service port

After the work, tighten the valve cover in place.

Tightening torque: 11.5~13.9 N•m

9.6. Precautions when connecting field piping and regarding insulation

- Be careful not to let the indoor and outdoor branch piping come into contact with the compressor terminal cover. If the liquid-side piping insulation might come into contact with it, adjust the height as shown in the figure below. Also, make sure the field piping does not touch the bolts or outer panels of the compressor.
- When the outdoor unit is installed above the indoor unit the following can occur:
 - The condensated water on the stop valve can move to the indoor unit. To avoid this, please cover the stop valve with sealing material.
- If the temperature is higher than 30°C and the humidity is higher than RH 80%, then the thickness of the sealing materials should be at least 20 mm in order to avoid condensation on the surface of the sealing.
- Be sure to insulate the liquid and gas-side field piping and the refrigerant branch kit.

Any exposed piping may cause condensation or burns if touched.

(The highest temperature that the gas-side piping can reach is around 120°C, so be sure to use insulating material which is very resistant.)

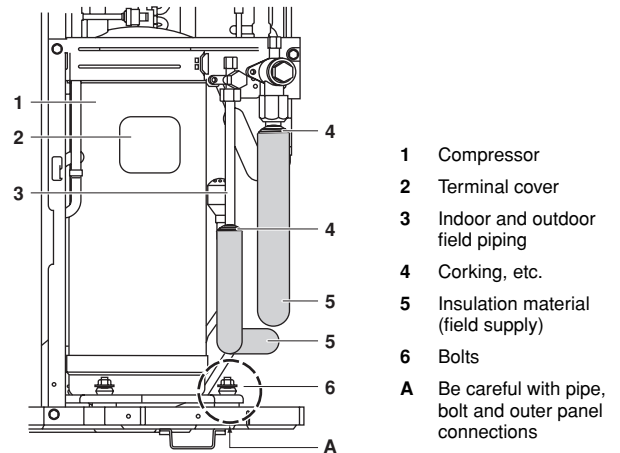

- 1 Compressor
- 2 Terminal cover
- 3 Indoor and outdoor field piping
- 4 Corking, etc.
- 5 Insulation material (field supply)
- 6 Bolts
- A Be careful with pipe, bolt and outer panel connections

Example of connection (Connection of 8 indoor units Heat pump system)		Branch with refnet joint	Branch with refnet joint and refnet header	Branch with refnet header																						
<p>□ indoor unit</p> <p>◁ refnet joint</p> <p>— refnet header</p>	<p>Actual pipe length</p> <p>Between outdoor and indoor units</p>																									
	<p>Maximum allowable length</p>	<p>Pipe length between outdoor and indoor units ≤150 m</p> <p>[Example] unit 8: a+b+c+d+e+f+g+p≤150 m</p> <p>Equivalent pipe length between outdoor and indoor units ≤175 m (Assume equivalent pipe length of refnet joint to be 1.0 m. (for calculation purposes))</p> <p>Total piping length from outdoor unit to all indoor units between 10 m and 300 m</p>	<p>Pipe length between outdoor and indoor units ≤150 m</p> <p>[Example] unit 8: a+b-hs+150 m, unit 8: a+i+ks+150 m</p> <p>Equivalent pipe length between outdoor and indoor units ≤175 m (Assume equivalent pipe length of refnet joint to be 0.5 m and of the refnet header to be 1.0 m. (for calculation purposes))</p>	<p>Pipe length between outdoor and indoor units (H1)≤50 m (≤40 m if outdoor unit is located in a lower position).</p> <p>Difference in height between adjacent indoor units (H2)≤15 m</p> <p>Pipe length from first refrigerant branch kit (either refnet joint or refnet header) to indoor unit ≤40 m</p> <p>[Example] unit 8: b+c+d+e+f+g+p≤40 m</p>	<p>Pipe length between refrigerant branch kit and indoor unit</p> <p>[Example] unit 8: i≤40 m</p>																					
<p>Allowable height</p>	<p>Difference in height between outdoor and indoor units</p> <p>Difference in height between indoor and indoor units</p>	<p>Difference in height between outdoor and indoor units (H1)≤50 m (≤40 m if outdoor unit is located in a lower position).</p> <p>Difference in height between adjacent indoor units (H2)≤15 m</p>	<p>Difference in height between outdoor and indoor units (H1)≤50 m (≤40 m if outdoor unit is located in a lower position).</p> <p>Difference in height between adjacent indoor units (H2)≤15 m</p>	<p>Difference in height between outdoor and indoor units (H1)≤50 m (≤40 m if outdoor unit is located in a lower position).</p> <p>Difference in height between adjacent indoor units (H2)≤15 m</p>																						
<p>Allowable length after the branch</p>	<p>Actual pipe length</p>	<p>Pipe length from first refrigerant branch kit (either refnet joint or refnet header) to indoor unit ≤40 m</p> <p>[Example] unit 8: b+c+d+e+f+g+p≤40 m</p>	<p>Pipe length from first refrigerant branch kit (either refnet joint or refnet header) to indoor unit ≤40 m</p> <p>[Example] unit 8: b+h≤40 m, unit 8: i+k≤40 m</p>	<p>Pipe length from first refrigerant branch kit and indoor unit</p> <p>[Example] unit 8: i≤40 m</p>																						
<p>Refrigerant branch kit selection</p> <p>Refrigerant branch kits can only be used with R410A.</p>	<p>Outdoor unit capacity type</p> <p>RXYSQ4~6</p>	<p>Refrigerant branch kit name</p> <p>KHRO22ME20T</p>	<p>Outdoor unit capacity type</p> <p>RXYSQ4~6</p>	<p>Refrigerant branch kit name</p> <p>KHRO22M29H</p>																						
<p>Pipe size selection</p> <p>Caution on selecting connection pipes</p> <p>If the overall equivalent piping length is >90 m, be sure to enlarge the pipe diameter of the gas-side main piping. If the recommended pipe size is not available, stick to the original pipe diameter (which may result in a small capacity decrease).</p> <p>[Gas side]</p> <p>RXYSQ4+5: Ø15.9 → Ø19.1</p> <p>RXYSQ6: Ø19.1 → Ø22.2</p>	<p>Outdoor unit capacity type</p> <p>RXYSQ4+5</p> <p>RXYSQ6</p>	<p>Refrigerant branch kit name</p> <p>KHRO22ME20T</p>	<p>Outdoor unit capacity type</p> <p>RXYSQ4~6</p>	<p>Refrigerant branch kit name</p> <p>KHRO22M29H</p>																						
<p>How to calculate the additional refrigerant to be charged</p> <p>Additional refrigerant to be charged R (kg)</p> <p>R should be rounded off in units of 0.1 kg</p>	<p>1 Main pipe (enlarge)</p> <p>2 First refrigerant branch kit</p> <p>3 Indoor unit</p>	<p>A. Piping between outdoor unit and refrigerant branch kit</p> <ul style="list-style-type: none"> Match to the size of the connection piping on the outdoor unit. <p>Outdoor unit connection piping size</p> <table border="1"> <thead> <tr> <th>Outdoor unit capacity type</th> <th>Gas pipe</th> <th>Liquid pipe</th> </tr> </thead> <tbody> <tr> <td>RXYSQ4+5</td> <td>Ø15.9x1.0 (Ø19.1x1.0)</td> <td>Ø9.5x0.8</td> </tr> <tr> <td>RXYSQ6</td> <td>Ø19.1x1.0 (Ø22.2x1.0)</td> <td>Ø9.5x0.8</td> </tr> </tbody> </table>	Outdoor unit capacity type	Gas pipe	Liquid pipe	RXYSQ4+5	Ø15.9x1.0 (Ø19.1x1.0)	Ø9.5x0.8	RXYSQ6	Ø19.1x1.0 (Ø22.2x1.0)	Ø9.5x0.8	<p>B. Piping between refrigerant branch kits</p> <ul style="list-style-type: none"> Use the pipe size from the following table. <p>Piping size (outer diameter x minimum thickness)</p> <table border="1"> <thead> <tr> <th>Gas pipe</th> <th>Liquid pipe</th> </tr> </thead> <tbody> <tr> <td>Ø15.9x1.0</td> <td>Ø9.5x0.8</td> </tr> </tbody> </table>	Gas pipe	Liquid pipe	Ø15.9x1.0	Ø9.5x0.8	<p>C. Piping between refrigerant branch kit and indoor unit</p> <ul style="list-style-type: none"> Pipe size for direct connection to indoor unit must be the same as the connection size of indoor unit. <p>Piping size (outer diameter x minimum thickness)</p> <table border="1"> <thead> <tr> <th>Indoor capacity index</th> <th>Gas pipe</th> <th>Liquid pipe</th> </tr> </thead> <tbody> <tr> <td>20+25+32+40+50</td> <td>Ø12.7x0.8</td> <td>Ø6.4x0.8</td> </tr> <tr> <td>63+80+100+125</td> <td>Ø15.9x1.0</td> <td>Ø9.5x0.8</td> </tr> </tbody> </table>	Indoor capacity index	Gas pipe	Liquid pipe	20+25+32+40+50	Ø12.7x0.8	Ø6.4x0.8	63+80+100+125	Ø15.9x1.0	Ø9.5x0.8
Outdoor unit capacity type	Gas pipe	Liquid pipe																								
RXYSQ4+5	Ø15.9x1.0 (Ø19.1x1.0)	Ø9.5x0.8																								
RXYSQ6	Ø19.1x1.0 (Ø22.2x1.0)	Ø9.5x0.8																								
Gas pipe	Liquid pipe																									
Ø15.9x1.0	Ø9.5x0.8																									
Indoor capacity index	Gas pipe	Liquid pipe																								
20+25+32+40+50	Ø12.7x0.8	Ø6.4x0.8																								
63+80+100+125	Ø15.9x1.0	Ø9.5x0.8																								
<p>R = (Total length (m) of liquid piping size at Ø6.4) x 0.054 + (Total length (m) of liquid piping size at Ø6.4) x 0.022</p> <p>R = [73 x 0.054] + [69 x 0.022] = 5.46 ⇒ 5.5 kg</p>	<p>Example for refrigerant branch using refnet joint and refnet header</p> <table border="1"> <thead> <tr> <th>a: Ø9.5x30 m</th> <th>d: Ø9.5x13 m</th> <th>g: Ø6.4x10 m</th> <th>j: Ø6.4x10 m</th> </tr> </thead> <tbody> <tr> <td>b: Ø9.5x10 m</td> <td>e: Ø6.4x10 m</td> <td>h: Ø6.4x20 m</td> <td>k: Ø6.4x9 m</td> </tr> <tr> <td>c: Ø9.5x10 m</td> <td>f: Ø6.4x10 m</td> <td>i: Ø9.5x10 m</td> <td></td> </tr> </tbody> </table>	a: Ø9.5x30 m	d: Ø9.5x13 m	g: Ø6.4x10 m	j: Ø6.4x10 m	b: Ø9.5x10 m	e: Ø6.4x10 m	h: Ø6.4x20 m	k: Ø6.4x9 m	c: Ø9.5x10 m	f: Ø6.4x10 m	i: Ø9.5x10 m														
a: Ø9.5x30 m	d: Ø9.5x13 m	g: Ø6.4x10 m	j: Ø6.4x10 m																							
b: Ø9.5x10 m	e: Ø6.4x10 m	h: Ø6.4x20 m	k: Ø6.4x9 m																							
c: Ø9.5x10 m	f: Ø6.4x10 m	i: Ø9.5x10 m																								

9.7. Leak test and vacuum drying

The units were checked for leaks by the manufacturer.

See figure 6 and refer to "Additional refrigerant charge" on page 10 for nomenclature of the parts in figure 6.

- Confirm that the gas and liquid line stop valves are firmly closed before pressure test or vacuuming.
- Make sure that valve A is completely open.

Air tight test and vacuum drying

- Air tight test: Make sure to use nitrogen gas. (For the service port position, refer to "9.2. Cautions for handling stop valve" on page 7.
- Pressurize the liquid and gas pipes to 4.0 MPa (40 bar) (do not pressurize more than 4.0 MPa (40 bar)). If the pressure does not drop within 24 hours, the system passes the test. If the pressure drops, check where the nitrogen leaks from.
- Vacuum drying: Use a vacuum pump which can evacuate to -100.7 kPa (5 Torr, -755 mm Hg)
 1. Evacuate the system from the liquid and gas pipes by using a vacuum pump for more than 2 hours and bring the system to -100.7 kPa. After keeping the system under that condition for more than 1 hour, check if the vacuum gauge rises or not. If it rises, the system may either contain moisture inside or have leaks.
 2. Following should be executed if there is a possibility of moisture remaining inside the pipe (if piping work is carried out during the raining season or over a long period of time, rainwater may enter the pipe during work).

After evacuating the system for 2 hours, pressurize the system to 0.05 MPa (vacuum break) with nitrogen gas and evacuate the system again using the vacuum pump for 1 hour to -100.7 kPa (vacuum drying). If the system cannot be evacuated to -100.7 kPa within 2 hours, repeat the operation of vacuum break and vacuum drying.

Then, after leaving the system in vacuum for 1 hour, confirm that the vacuum gauge does not rise.

- 4 Siphon system
- 5 Measuring instrument
- 6 Vacuum pump
- 7 Valve A
- 8 Gas line stop valve
- 9 Outdoor unit
- 10 Liquid line stop valve
- 11 Indoor unit
- 12 Stop valve service port
- 13 Charge hose

To avoid compressor breakdown. Do not charge the refrigerant more than the specified amount.

- This outdoor unit is factory charged with refrigerant and depending on pipe sizes and pipe lengths some systems require additional charging of refrigerant. See "How to calculate the additional refrigerant to be charged" on page 9.
- In case re-charge is required, refer to the nameplate of the unit. The nameplate states the type of refrigerant and necessary amount.

Precautions when adding R410A

Be sure to charge the specified amount of refrigerant in liquid state to the liquid pipe.

Since this refrigerant is a mixed refrigerant, adding it in gas form may cause the refrigerant composition to change, preventing normal operation.

- Before charging, check whether the refrigerant cylinder is equipped with a siphon tube or not.

Charge the liquid refrigerant with the cylinder in upright position.

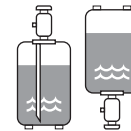

Charge the liquid refrigerant with the cylinder in up-side-down position.

10. ADDITIONAL REFRIGERANT CHARGE



- Refrigerant cannot be charged until field wiring has been completed.
- Refrigerant may only be charged after performing the leak test and the vacuum drying (see above).
- When charging a system, care shall be taken that its maximum permissible charge is never exceeded, in view of the danger of liquid hammer.
- Charging with an unsuitable substance may cause explosions and accidents, so always ensure that the appropriate refrigerant (R410A) is charged.
- Refrigerant containers shall be opened slowly.
- Always use protective gloves and protect your eyes when charging refrigerant.
- When performing service on the unit requiring the refrigerant system to be opened, refrigerant must be evacuated according to local regulations.
- Do not use the automatic refrigerant charging function while working on the indoor units. When using the automatic refrigerant charging function, the indoor units operate automatically as well as the outdoor unit.
- When the power is on, please close the front panel when leaving the unit.



See figure 6.

- 1 Pressure reducing valve
- 2 Nitrogen
- 3 Tank

10.1. Important information regarding the refrigerant used

This product contains fluorinated greenhouse gases covered by the Kyoto Protocol. Do not vent gases into the atmosphere.

Refrigerant type: R410A

GWP⁽¹⁾ value: 1975

⁽¹⁾ GWP = global warming potential

Please fill in with indelible ink,

- ① the factory refrigerant charge of the product,
- ② the additional refrigerant amount charged in the field and
- ①+② the total refrigerant charge

on the fluorinated greenhouse gases label supplied with the product.

The filled out label must be adhered on the inside of the product and in the proximity of the product charging port (e.g. on the inside of the service cover).

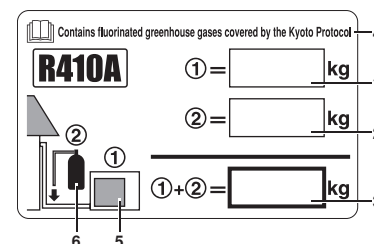

- 1 factory refrigerant charge of the product: see unit name plate
- 2 additional refrigerant amount charged in the field
- 3 total refrigerant charge
- 4 Contains fluorinated greenhouse gases covered by the Kyoto Protocol
- 5 outdoor unit
- 6 refrigerant cylinder and manifold for charging

NOTE



National implementation of EU regulation on certain fluorinated greenhouse gases may require to provide the appropriate official national language on the unit. Therefore, an additional multilingual fluorinated greenhouse gases label is supplied with the unit.

Sticking instructions are illustrated on the backside of that label.

10.2. 3 procedures for adding refrigerant

Procedure 1: Adding refrigerant by using the automatic refrigerant charging function (recommended)

How to connect the tank?

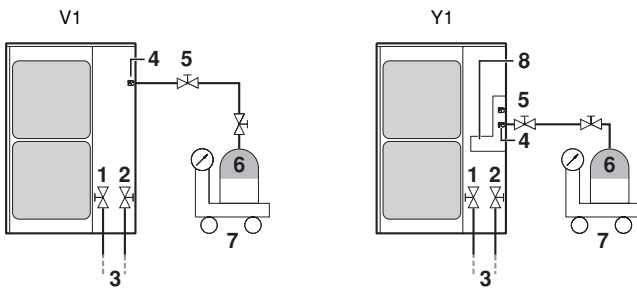

- 1 Liquid line stop valve
- 2 Gas line stop valve
- 3 To indoor unit
- 4 Service port for adding refrigerant
- 5 Valve A
- 6 R410A tank
- 7 Measuring instrument
- 8 Pipe fixing plate

When the refrigerant tank is connected and the specified operation is performed, the appropriate amount of refrigerant will be charged into the system. After charging, the system will stop automatically. The refrigerant must be charged according to the procedure described below.



CAUTION

- Make sure to turn ON the power 6 hours before starting the operation. This is necessary to warm the crankcase by the electric heater.
- Automatic charging is able to charge 6 kg/hour refrigerant at an outside temperature of 0°C to 24 kg/hour refrigerant at an outside temperature of 35°C. The charging time depends on the amount of charged refrigerant and on the outside temperature.
- Automatic refrigerant charging is **NOT** possible if the following restrictions are exceeded:
 - Outside temperature: 0°C DB~43°C DB
 - Indoor temperature: 0°C DB~32°C DB
 - Indoor unit connection capacity: 50%~130%

Automatic refrigerant charging procedure

- 1 Open the liquid and gas side stop valves completely.



Note that valve A must be closed!

- 2 Turn on the power of the outdoor unit and indoor units.

NOTE



When an indoor unit is connected to the refrigerant system and the indoor unit is turned off, automatic charging will fail.

- 3 Make sure that the led on the PCB on the outdoor unit are as shown in the table below. This indicates that the system is operating normally.

MODE	TEST/HWL	IND	MASTER	SLAVE	L.N.O.P.	DEMAND
H1P	H2P	H3P	H4P	H5P	H6P	H7P
●	●	☀	●	●	●	●

Led state

Throughout the manual the state of the leds is indicated as follows:

- OFF
- ☀ ON
- ☀ (with dots) blinking
- * ON or OFF

If H2P is lit up, check the type of error based on the error code in the remote controller and correct the error in accordance with "12.4. Test operation" on page 19.

- 4 Automatically charge the refrigerant according to the procedure described below.



WARNING

Do not touch anything else than the push-buttons (BS1~5) on the PCB when making the settings. These settings must be done with the power on



- 4.1 Press BS4 TEST once.

H1P	H2P	H3P	H4P	H5P	H6P	H7P
☀	☀	☀	☀	☀	☀	☀

- 4.2 Press BS4 TEST for 5 seconds. The unit will start running.

H1P	H2P	H3P	H4P	H5P	H6P	H7P
●	☀	●	●	●	*	*

If the led display below appears, the automatic refrigerant charging restriction has been exceeded. Additional refrigerant must be charged by calculating the additional refrigerant charging amount.

H1P	H2P	H3P	H4P	H5P	H6P	H7P
☀	☀	☀	☀	☀	●	●

Description of error
Inappropriate outdoor temperature

or

H1P	H2P	H3P	H4P	H5P	H6P	H7P
☀	☀	☀	☀	●	☀	●

Description of error
Inappropriate indoor temperature

If the led display below appears, check the indoor unit connection capacity.

H1P	H2P	H3P	H4P	H5P	H6P	H7P
☀	☀	☀	☀	☀	●	☀

Description of error
Inappropriate indoor unit connection capacity

If the led display below appears, the liquid and gas side stop valves may be closed.

H1P	H2P	H3P	H4P	H5P	H6P	H7P
☀	●	*	*	*	*	*

Description of error
Stop valve is closed

NOTE



If you want to repeat the automatic refrigerant charging operation from step 4.2, fully open the liquid and gas side stop valves and press the BS1 MODE button once.

- 4.3 When the led indication becomes as shown in the table below in about 15 to 30 minutes after start of operation, open valve A at once to start charging of the refrigerant.

Immediately after starting charging of the refrigerant by opening valve A, press **BS4 TEST** once. When **BS4 TEST** is not pressed within 10 minutes after the led indication is shown, charging is stopped.

H1P	H2P	H3P	H4P	H5P	H6P	H7P	Code on remote controller
☀	☀	☀	●	☀	●	☀	PR

- 4.4 The led indication becomes as shown in the table below during automatic refrigerant charging.

During automatic refrigerant charging, the remote controller indicates **TEST** (test operation) and  (external control).

H1P	H2P	H3P	H4P	H5P	H6P	H7P
☀	☀	*	*	*	*	*

NOTE



If the led display below appears, the refrigerant tank is empty. Replace the refrigerant tank, open valve A and re-charge.

H1P	H2P	H3P	H4P	H5P	H6P	H7P	Code on remote controller
☀	☀	☀	●	●	☀	●	PR

The led indication becomes as shown in the table below when automatic refrigerant charging is about to end. Prepare to close the valve on the refrigerant tank.

H1P	H2P	H3P	H4P	H5P	H6P	H7P	Code on remote controller
☀	☀	☀	☀	☀	☀	☀	PE

NOTE



It is possible that the code PE is not shown on the remote controller but this does not indicate a malfunction. The led indication can immediately shift to the situation as shown in "Case 1: Charging complete" on page 12.

- 4.5 When the led indication becomes as shown in the table below, quickly close valve A and follow instructions as described below.



CAUTION

- When adding refrigerant is done or when pausing, close the valve on the refrigerant tank immediately. More refrigerant might be charged by any remaining pressure after the machine is stopped.
- The outdoor fan may keep rotating a little bit more, but this does not indicate a malfunction.

Case 1: Charging complete

H1P	H2P	H3P	H4P	H5P	H6P	H7P	Code on remote controller
☀	☀	☀	☀	☀	☀	☀	P9

Charging of the refrigerant is complete. Press **BS1 MODE** button once and go to step 5.

Case 2: Recharging operation

H1P	H2P	H3P	H4P	H5P	H6P	H7P	Code on remote controller
☀	☀	☀	●	☀	☀	☀	P8

Press **BS1 MODE** button once and perform automatic refrigerant charging again starting from Step 4.2.

Case 3: Charging interrupted

H1P	H2P	H3P	H4P	H5P	H6P	H7P	Code on remote controller
☀	☀	☀	●	●	●	☀	P2

Something is preventing normal operation:

- Is the gas side stop valve completely open?

- Are the valve on the refrigerant tank and valve A open?
Check if the **BS4 TEST** button was pressed within 10 minutes after the valves were opened.
- Is the indoor unit air intake vent or outlet vent blocked?

After correcting the problem, press **BS1 MODE** button once and perform automatic refrigerant charging again starting from step 4.2.

Case 4: Failure

H1P	H2P	H3P	H4P	H5P	H6P	H7P	Error code on remote controller
●	☀	☀	●	●	●	●	See footnote(*)

(*) An error in the system interrupted the operation of the unit. Check the error by using the error code displayed on the remote controller. For an explanation of the error codes, see "Error codes on the remote controller" on page 20 and solve the problem.

After correcting the problem, press **BS1 MODE** button once and perform automatic refrigerant charging again starting from step 4.2.

- When charging is complete, determine the weight of refrigerant that was added and fill in the amount in the "Additional refrigerant charge label" attached to service precautions plate on the unit.
- After adding the refrigerant, do not forget to close the lid of the service port. The tightening torque for the lid is 11.5~13.9 N·m.

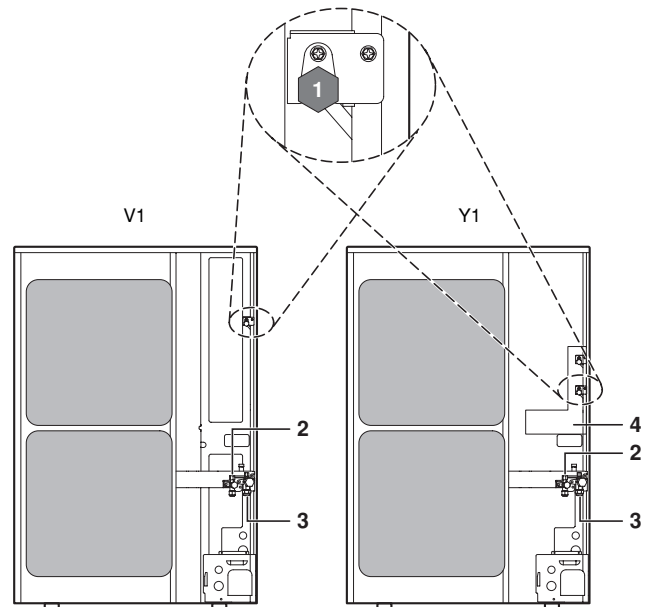

- Service port for adding refrigerant
- Liquid line stop valve
- Gas line stop valve
- Pipe fixing plate

Procedure 2: Charging while the outdoor unit is at a standstill

See figure 6.

- Determine the weight of refrigerant to be charged additionally referring to the item "Additional refrigerant charge" in "How to calculate the additional refrigerant to be charged" on page 9 and fill in the amount in the "Additional refrigerant charge label" attached to the unit.
- After the vacuum drying is finished, open valve A and charge the additional refrigerant in its liquid state through the service port on the liquid stop valve taking into account following instructions:
 - Turn on the power of the outdoor unit and indoor units.
 - Check that gas and liquid stop valves are closed.
 - Stop the compressor and charge the specified weight of refrigerant.

- To avoid compressor breakdown. Do not charge the refrigerant more than the specified amount.
- If the total refrigerant cannot be charged while the outdoor unit is at a standstill, it is possible to charge the refrigerant by operating the outdoor unit using the refrigerant charge function (refer to "Setting mode 2" on page 18) and follow "Procedure 3: Charging while the outdoor unit is operating" on page 13.

Procedure 3: Charging while the outdoor unit is operating

See the figure in "How to connect the tank?" on page 11.

- 1 Completely open the gas side stop valve and liquid side stop valve. Valve A must be left fully closed.
- 2 Close the front panel and turn on the power to all indoor units and the outdoor unit.
- 3 Open valve A immediately after starting of the compressor.
- 4 Charge the additional refrigerant in its liquid state through the service port of the liquid line stop valve.
- 5 While the unit is at a standstill and under setting mode 2 (refer to Checks before initial start-up, "Setting the mode" on page 18), set the required function A (additional refrigerant charging operation) to **ON** (ON). Then operation starts. The blinking H2P led indicates test operation and the remote controller indicates **TEST** (test operation) and  (external control).
- 6 When the specified amount of refrigerant is charged, push the **BS3 RETURN** button. Then operation stops.
 - The operation automatically stops within 30 minutes.
 - If the refrigerant charge cannot be finished within 30 minutes, repeat step 5.
 - If the operation stops immediately after restart, there is a possibility that the system is overcharged. The refrigerant cannot be charged more than this amount.
- 7 After the refrigerant charge hose is removed, make sure to close valve A.







11. ELECTRICAL WIRING WORK





- All wiring must be performed by an authorized electrician.
- All field supplied components and all electric construction should comply with the applicable local and national codes.

To persons in charge of electrical wiring work:

Do not operate the unit until the refrigerant piping is complete. (Running it before the piping is ready will break the compressor.)

11.1. Internal wiring – Parts table

L	Live
N	Neutral
	Field wiring
	Terminal strip
	Connector
	Protective earth (screw)
	Connection
	Relay connector

	Functional earthing
	Terminal
	Movable connector
	Fixed connector
BLU	Blue
BRN	Brown
GRN	Green
RED	Red
WHT	White
YLW	Yellow
ORG	Orange
BLK	Black
A1P	Printed circuit board (main)
A2P	Printed circuit board (inverter)
A3P *	Printed circuit board (noise filter)
A4P *	Printed circuit board (C/H selector)
BS1~BS5	Push button switch (mode, set, return, test, reset)
C1~C3	Capacitor
C4 *	Capacitor
DS1	DIP switch
E1HC	Crankcase heater
F1U, F4U *	Fuse (T 6.3 A/250 V)
F1U (A1P) #	Fuse (T 6.3 A/250 V)
F3U (A1P) #	Fuse (T 6.3 A/250 V)
F4U (A1P) #	Fuse (T 6.3 A/250 V)
F6U *	Fuse (T 5.0 A/250 V)
FINTH *	Thermistor (fin)
H1P~H8P	Light emitting diode (service monitor orange) Prepare, test: blinking
H2P	Malfunction detection: light up
HAP *	Light emitting diode (service monitor green)
HAP (A1P) #	Light emitting diode (service monitor green)
HAP (A2P) #	Light emitting diode (service monitor green)
K1M *	Magnetic contactor (M1C)
K1M (A1P) #	Magnetic contactor
K1R	Magnetic relay (Y1S)
K2R	Magnetic relay (Y2S)
K3R	Magnetic relay (Y3S)
K4R	Magnetic relay (E1HC)
K5R	Magnetic relay
K6R #	Magnetic relay
L1R	Reactor
M1C	Motor (compressor)
M1F	Motor (fan) (upper)
M2F	Motor (fan) (lower)
PS	Switching power supply
Q1DI	Field earth leakage breaker (300 mA)
R1 *	Resistor (current limiting)
R1 (A1P) #	Resistor
R1 (A2P) #	Resistor
R2 *	Resistor (current sensor)
R2 (A2P) #	Resistor
R1T	Thermistor (air)

R2T.....*	Thermistor (discharge)
R2T.....#	Thermistor (M1C discharge)
R3T.....	Thermistor (suction 1)
R4T.....*	Thermistor (heat exchanger)
R4T.....#	Thermistor (subcool)
R5T.....	Thermistor (suction 2)
R6T.....*	Thermistor (subcooling heat exchanger)
R6T.....#	Thermistor (heat exchanger)
R7T.....*	Thermistor (liquid pipe)
R7T.....#	Thermistor (liquid pipe 1)
R8T.....	Thermistor (liquid pipe 2)
R9T.....#	Thermistor (power module)
S1NPH.....	Pressure sensor (high)
S1NPL.....	Pressure sensor (low)
S1PH.....	Pressure switch (high)
V1R.....	Power module
V2R, V3R.....	Diode module
V1T.....*	IGBT (Insulated Gate Bipolar Transistor)
X1M.....	Terminal strip (power supply)
X1M.....*	Terminal strip (C/H selector) (A4P)
X2M.....*	Terminal strip (control)
X2M.....#	Terminal strip (control) (cool/heat selector)
Y1E.....	Electronic expansion valve (main)
Y3E.....	Electronic expansion valve (subcool)
Y1S.....	Solenoid valve (4 way valve)
Y2S.....	Solenoid valve (hot gas)
Y3S.....	Solenoid valve (unload circuit)
Z1C~Z8C.....*	Noise filter (ferrite core)
Z1C~Z4C.....#	Noise filter (ferrite core)
Z1F~Z4F.....*	Noise filter
Z1F.....#	Noise filter (with surge absorber)
Z2F.....#	Noise filter

Cool/heat selector

S1S.....	Selector switch (fan/cool – heat)
S2S.....	Selector switch (cool – heat)

Connector of option adaptor

X37A.....	Connector (option adaptor power supply)
*.....	For RXYSQ4~6PA7V1B only
#.....	For RXYSQ4~6PA7Y1B only

Notes

- 1 This wiring diagram only applies to the outdoor unit.
- 4 When using the option adaptor, refer to the installation manual.
- 5 Refer to the wiring diagram sticker (on the back of the front plate) for instructions on how to use BS1~BS5 and DS1-1, DS1-2 switches.
- 6 Do not operate the unit by short-circuiting protection device S1PH.
- 8 Refer to the installation manual for connection wiring to indoor-outdoor transmission F1-F2.
- 9 When using the central control system, connect outdoor-outdoor transmission F1-F2.

11.2. Precautions on electrical wiring work

- Before obtaining access to terminal devices, all supply circuits must be interrupted.
- Use only copper wires.
- Do not turn on the main switch until all the wiring is completed. Make sure that the main switch has a contact separation of at least 3 mm in all poles.
- Never squeeze bundled cables into a unit.
- Secure the electrical wiring with clamping material as shown in figure 9 so that it does not come in contact with the piping, particularly on the high-pressure side. Make sure no external pressure is applied to the terminal connectors.
- When installing the earth leakage breaker make sure that it is compatible with the inverter (resistant to high frequency electrical noise) to avoid unnecessary opening of the earth leakage breaker.
- As this unit is equipped with an inverter, installing a phase advancing capacitor not only will deteriorate power factor improvement effect, but also may cause capacitor abnormal heating accident due to high-frequency waves. Therefore, never install a phase advancing capacitor.
- Follow the "electrical wiring diagram" when carrying out any electrical wiring.
- Always ground wires. (In accordance with national regulations of the pertinent country.)
- Do not connect the ground wire to gas pipes, sewage pipes, lightning rods, or telephone ground wires.
 - Combustion gas pipes: can explode or catch fire if there is a gas leak.
 - Sewage pipes: no grounding effect is possible if hard plastic piping is used.
 - Telephone ground wires and lightning rods: dangerous when struck by lightning due to abnormal rise in electrical potential in the grounding.
- This unit uses an inverter, and therefore generates noise, which will have to be reduced to avoid interfering with other devices. The outer casing of the product may take on an electrical charge due to leaked electrical current, which will have to be discharged with the grounding.
- RXYSQ_PA7Y1B: Make sure to connect power supply cables in normal phase. If connected in reverse phase, the remote controller of the indoor unit indicates "L1" and the equipment cannot operate. Change any two of the three power supply cables (L1, L2, L3) to correct phase.

11.3. Connection example of total system wiring

(See figure 8)

- 1 Power
- 2 Earth leakage breaker
- 3 Branch switch overcurrent breaker (fuse)
- 4 Ground
- 5 Remote controller

11.4. Connecting power wire and transmission wires

- Let the power wire (including ground wire) go through the power outlet port on either the front, side or back of the outdoor unit.
- Let the transmission wires go through the cable outlet port, pipe outlet port or knock out hole on either the front, side or back of the outdoor unit. (See figure 9).

- A Rear direction
- B Lateral direction
- C Front direction
- 1 Power terminal block (X1M)
- 2 Control wiring between units
- 3 Power cable with ground wire. (Keep proper distance between power cable and control wiring).
- 4 Clamp (field supply)
- 5 Stop valve mounting plate
- 6 Power cable
- 7 Ground cable (yellow/green)
- 8 Fix the control wiring with the clamp
- 9 Control terminal block (X2M)

Precautions when knocking out knockout holes

- To punch a knock hole, hit on it with a hammer.
- After knocking out the holes, we recommend you paint the edges and areas around the edges using the repair paint to prevent rusting.
- When passing electrical wiring through the knock holes, remove any burrs from the knock holes and wrap the wiring with protective tape to prevent damage.
- If there is any possibility that small animals enter the system through the knock holes, plug the holes with packing materials (to be prepared on-site).

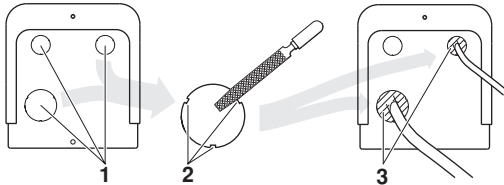

- 1 Knockout hole
- 2 Burr
- 3 Packing materials

- Use a power wire pipe for the power wiring.
- Outside the unit, make sure the low voltage electric wiring (i.e. for the remote control, between units, etc.) and the high voltage electric wiring do not pass near each other, keeping them at least 50 mm apart. Proximity may cause electrical interference, malfunctions, and breakage.
- Be sure to connect the power wiring to the power wiring terminal block and secure it as described under "11.4. Connecting power wire and transmission wires" on page 15.
- Inter-unit wiring should be secured as described in "11.4. Connecting power wire and transmission wires" on page 15.
 - Secure the wiring with clamps so that it does not touch the piping.
 - Make sure the wiring and the electric box lid do not stick up above the structure, and close the cover firmly.

11.5. Power circuit and cable requirements

A power circuit (see table below) must be provided for connection of the unit. This circuit must be protected with the required safety devices, i.e. a main switch, a slow blow fuse on each phase and an earth leakage breaker.

	RXYSQ4-6PA7V1B	RXYSQ4-6PA7Y1B
Phase and frequency	1 N~50 Hz	3 N~50 Hz
Voltage	220-240 V	380-415 V
Recommended field fuse	32 A	16 A
Minimum circuit amps (MCA) ^(*)	27	13.5
Transmission line section	0.75~1.25 mm ²	
Wire type ^(†)	H05VV	

(*) Stated values are maximum values (see electrical data of combination with indoor units for exact values).

(†) Only in protected pipes, use H07RN-F when protected pipes are not used.

NOTE



- Select the power supply cable in accordance with relevant local and national regulations.
- Wire size must comply with the applicable local and national code.
- Specifications for local wiring power cord and branch wiring are in compliance with IEC60245.

- In connecting the power cable to the power terminal block, securely clamp the cable as shown in figure 9.



After finishing the electric work, confirm that each electric part and terminal inside the electric parts box is connected securely.

RXYSQ4-6PA7V1B: Equipment complying with EN/IEC 61000-3-12⁽¹⁾.

(1) European/International Technical Standard setting the limits for harmonic currents produced by equipment connected to public low-voltage systems with input current >16 A and ≤75 A per phase.



Precautions when laying power wiring

Use round pressure terminals for connections to the power terminal block.

When none are available, follow the instructions below.

- Do not connect wiring of different thicknesses to the power terminal block. (Slack in the power wiring may cause abnormal heat.)
- When connecting wiring which is the same thickness, do as shown in the figure below.

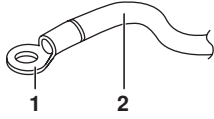

- 1 Round pressure terminal
- 2 Power wire

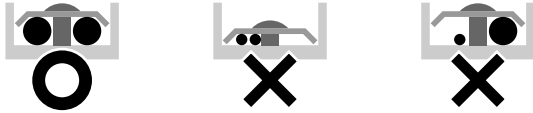

- For wiring, use the designated power wire and connect firmly, then secure to prevent outside pressure being exerted on the terminal board.
- Use an appropriate screwdriver for tightening the terminal screws. A screwdriver with a small head will strip the head and make proper tightening impossible.
- Over-tightening the terminal screws may break them.
- See the table below for tightening torque for the terminal screws.

Tightening torque (N·m)	
M5 (Power terminal block/ground wire)	2.39~2.92
M4 (Shielded ground)	1.18~1.44
M3.5 (Control wiring block)	0.79~0.97



For low-noise operation or demand operation, it is necessary to get the optional 'External control adaptor for outdoor unit' (DTA104A61/62).

For details, see the installation manual attached to the adaptor.



- Be sure to follow the limits below. If the unit-to-unit cables are beyond these limits, it may result in malfunction of transmission.
Maximum wiring length: 300 m
Total wiring length: 600 m
Maximum No. of branches: 9
- Up to 9 branches are possible for unit-to-unit cabling. No branching is allowed after branching. (See figure 13).

- 1 Branch
- 2 Subbranching

- Never connect the power supply to unit-to-unit cabling terminal block. Otherwise the entire system may break down.

- The wiring from the indoor units must be connected to the F1/F2 (In-Out) terminals on the PC board in the outdoor unit.

- After installing the interconnecting wires inside the unit, wrap them along with the on-site refrigerant pipes using finishing tape, as shown in figure 14.

- 1 Liquid pipe
- 2 Gas pipe
- 3 Interconnecting wiring
- 4 Insulator
- 5 Finishing tape

For the above wiring, always use vinyl cords with 0.75 to 1.25 mm² sheath or cables (2-core wires). (3-core wire cables are allowable for the cooler/heater changeover remote controller only.)

Field line connection: Control wiring and cool/heat selection



If an excessive force is applied while connecting a cable to the terminal block on the PC board, the PC board may be damaged.

See figure 10.

- 1 Cool/heat selector
- 2 Outdoor unit PC board
- 3 Take care of the polarity
- 4 Use the conductor of sheathed wire (2 wire) (no polarity)
- 5 Terminal board (field supply)

Setting the cool/heat operation

- 1 Performing cool/heat setting with the remote controller connected to the indoor unit.

Keep the cool/heat selector switch (DS1-1) on the outdoor unit PC board at the factory setting position IN/D UNIT. (See figure 11).

- 1 Remote controller

- 2 Performing cool/heat setting with the cool/heat selector.

Connect the cool/heat selector remote controller (optional) to the A/B/C terminals and set the cool/heat selector switch (DS1-1) on the outdoor unit PC board to OUT/D UNIT. (See figure 12).

- 1 Cool/heat selector

NOTE



When the cool/heat selector is set to heat, you cannot select cooling with the remote controller.

12. BEFORE OPERATION

12.1. Service precautions



Caution when performing service to inverter equipment

- Do not touch live parts for 10 minutes after the power supply is turned off because of high voltage risk.
- Additionally, measure the points as shown in the figure with a tester and confirm that the voltage of the capacitor in the main circuit is no more than 50 V DC.

V1

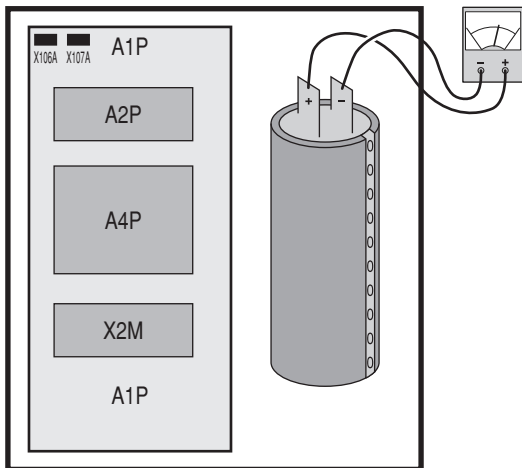

Y1

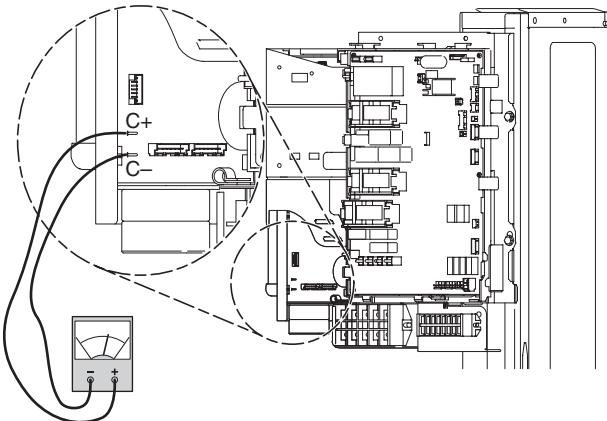

- Make sure that the power supply is turned off before performing the maintenance work. The heater of the compressor may operate even in stop mode.
- Please note that some sections of the electric component box are extremely hot.
- In order to prevent damage to the PCB, first eliminate static electricity by touching a metal part (e.g. stop valve) with your hand. Then pull out the connector.
- After measuring the residual voltage, pull out the outdoor fan connector.
- Make sure you do not touch a conductive section.
- The outdoor fan may rotate due to strong backblow wind, causing the capacitor to charge. This may result in an electric shock.

After maintenance, make sure the outdoor fan connector is connected again. Otherwise, the unit may break down.

Play it safe!

Touch a metal part by hand (such as the stop valve) in order to eliminate static electricity and to protect the PCB before performing service.

12.2. Checks before initial start-up

NOTE



Note that during the first running period of the unit, required power input may be higher than stated on the nameplate of the unit. This phenomenon originates from the compressor that needs elapse of a 50 hours run in period before reaching smooth operation and stable power consumption.



- Make sure that the circuit breaker on the power supply panel of the installation is switched off.
- Attach the power wire securely.
- Introducing power with a missing N-phase or with a mistaken N-phase will break the equipment.

After the installation, check the following before switching on the circuit breaker:

- 1 Transportation stay
Be sure that the transportation stay is removed from the compressor.
- 2 The position of the switches that require an initial setting
Make sure that switches are set according to your application needs before turning the power supply on.
- 3 Power supply wiring and transmission wiring
Use a designated power supply and transmission wiring and make sure that it has been carried out according to the instructions described in this manual, according to the wiring diagrams and according to local and national regulations.
- 4 Pipe sizes and pipe insulation
Make sure that correct pipe sizes are installed and that the insulation work is properly executed.
- 5 Additional refrigerant charge
The amount of refrigerant to be added to the unit should be written on the included "Added Refrigerant" plate and attached to the rear side of the front cover.
- 6 Insulation test of the main power circuit
Using a megatester for 500 V, check that the insulation resistance of 2 MΩ or more is attained by applying a voltage of 500 V DC between power terminals and earth. Never use the megatester for the transmission wiring.
- 7 Stop valves
Be sure that the stop valves are open on both liquid and gas side.
- 8 Drain pipe installation
Make sure that the drain piping is installed properly.

12.3. Field setting

If required, carry out any field setting according to the following instructions. Refer to the service manual for more details.

Handling the switches

When carrying out field settings, operate the switches with an insulated stick (such as a ball-point pen) to avoid touching of live parts.



Location of the DIP switches, leds and buttons

- 1 Led H1P~H8P
- 2 Push button switches BS1~BS5
- 3 DIP switches 2 (DS1-1, DS1-2)

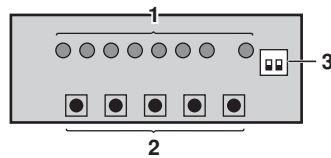

Led state

Throughout the manual the state of the leds is indicated as follows:

- OFF
- ☀ ON
- ☀ (with a star) blinking

Setting the push button switch (BS1~5)

Function of the push button switch which is located on the outdoor unit PCB:

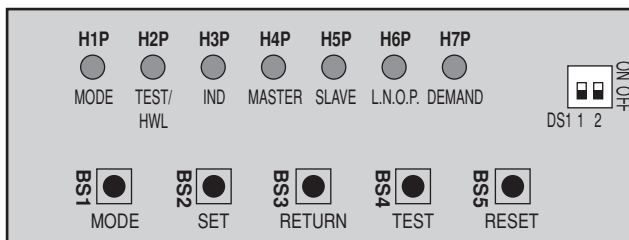

- BS1 MODE** For changing the set mode
- BS2 SET** For field setting
- BS3 RETURN** For field setting
- BS4 TEST** For test operation
- BS5 RESET** For resetting the address when the wiring is changed or when an additional indoor unit is installed

The figure shows state of the led indications when the unit is shipped from the factory.

Setting the mode

The set mode can be changed with the **BS1 MODE** button according to the following procedure:

- **For setting mode 1:** Press the **BS1 MODE** button once, the led is off ●.
- **For setting mode 2:** Press the **BS1 MODE** button for 5 seconds, the H1P led is on ☀.

If the H1P led is blinking ☀ (with a star) and the **BS1 MODE** button is pushed once, it will change to setting mode 1.

NOTE If you get confused in the middle of the setting process, push the **BS1 MODE** button. Then it returns to setting mode 1 (H1P led is off).

Setting mode 1

The H1P led is off (COOL/HEAT selection setting).

Setting procedure

- 1 Push the **BS2 SET** button and adjust the led indication to either one of the possible settings as shown below in the field marked :

- 1 In case of COOL/HEAT setting by each individual outdoor unit circuit.
- 2 In case of COOL/HEAT setting by the master unit when outdoor units are connected in multiple-system combination^(*).
- 3 In case of COOL/HEAT setting by the slave unit when outdoor units are connected in multiple-system combination^(*).

	H1P	H2P	H3P	H4P	H5P	H6P	H7P
1	●	●	☀	●	●	●	●
2	●	●	●	☀	●	●	●
3	●	●	●	●	☀	●	●

(*) It is necessary to use the optional external control adapter for outdoor unit (DTA104A61/62). See the instruction delivered with the adapter.

- 2 Push the **BS3 RETURN** button and the setting is defined.

Setting mode 2

The H1P led is on.

Setting procedure

- 1 Push the **BS2 SET** button according to the required function (A~F). The led indication that matches the required function is shown below in the field marked :

Possible functions

- A** additional refrigerant charging operation.
- B** refrigerant recovery operation/vacuuming operation.
- C** automatic low noise operation setting at nighttime.
- D** low noise operation level setting (L.N.O.P.) via the external control adapter.
- E** power consumption limitation setting (DEMAND) via the external control adapter.
- F** enabling function of the low noise operation level setting (L.N.O.P.) and/or power consumption limitation setting (DEMAND) via the external control adapter (DTA104A61/62).

	H1P	H2P	H3P	H4P	H5P	H6P	H7P
A	☀	●	☀	●	☀	●	●
B	☀	●	☀	●	☀	●	☀
C	☀	●	☀	●	☀	☀	●
D	☀	●	☀	☀	●	●	☀
E	☀	●	☀	☀	☀	☀	●
F	☀	●	●	☀	☀	●	●

- 2 When the **BS3 RETURN** button is pushed, it indicates the current setting.
- 3 Push the **BS2 SET** button according to the required setting possibility as shown below in the field marked .
- 3.1 Possible settings for function A, B and F are **ON** (ON) or **OFF** (OFF).

	H1P	H2P	H3P	H4P	H5P	H6P	H7P
ON	☀	●	●	●	●	☀	●
OFF ^(*)	☀	●	●	●	●	●	☀

(*) This setting = factory setting.

3.2 Possible settings for function C

The noise of level 3 < level 2 < level 1 (▲ 1).

	H1P	H2P	H3P	H4P	H5P	H6P	H7P
OFF(*)	☀	●	●	●	●	●	●
▲ 1	☀	●	●	●	●	●	☀
▲ 2	☀	●	●	●	●	☀	●
▲ 3	☀	●	●	●	●	☀	☀

(*) This setting = factory setting.

3.3 Possible settings for function D and E

For function D (L.N.O.P) only: the noise of level 3 < level 2 < level 1 (▲ 1).

For function E (DEMAND) only: the power consumption of level 1 < level 2 < level 3 (▲ 3).

	H1P	H2P	H3P	H4P	H5P	H6P	H7P
▲ 1	☀	●	●	●	●	●	☀
▲ 2(*)	☀	●	●	●	●	☀	●
▲ 3	☀	●	●	●	☀	●	●

(*) This setting = factory setting.

4 Push the **BS3 RETURN** button and the setting is defined.

5 When the **BS3 RETURN** button is pushed again, the operation starts according to the setting.

Refer to the service manual for more details and for other settings.

NOTE When finished, please mark the settings of function C, D and E in the "Records" part of the label on the backside of the front plate.

Confirmation of the set mode

The following items can be confirmed by setting mode 1 (H1P led is off)

Check the led indication in the field marked .

1 Indication of the present operation state

- normal
- ☀ abnormal
- ☀ under preparation or under test operation

H1P	H2P	H3P	H4P	H5P	H6P	H7P
●	●	☀	●	●	●	●

2 Indication of COOL/HEAT selection setting

- 1 When set to COOL/HEAT change-over by each individual outdoor unit circuit (= factory setting).
- 2 Indication on master unit when COOL/HEAT change-over is carried out by outdoor units connected in multiple system-combination.
- 3 Indication on slave unit when COOL/HEAT change-over is carried out by outdoor units connected in multiple system-combination

	H1P	H2P	H3P	H4P	H5P	H6P	H7P
1(*)	●	●	☀	●	●	●	●
2	●	●	●	☀	●	●	●
3	●	●	●	●	☀	●	●

(*) This setting = factory setting.

3 Indication of low noise operation state L.N.O.P

- standard operation (= factory setting)
- ☀ L.N.O.P operation

H1P	H2P	H3P	H4P	H5P	H6P	H7P
●	●	☀	●	●	●	●

4 Indication of power consumption limitation setting DEMAND

- standard operation (= factory setting)
- ☀ DEMAND operation

H1P	H2P	H3P	H4P	H5P	H6P	H7P
●	●	☀	●	●	●	●

12.4. Test operation

NOTE After turning on the power supply, the unit can not be started until the H2P initialisation led goes off (maximum 12 minutes).

- Check the stop valves
Make sure to open the gas and liquid line stop valves.
- After installation, perform the test operation.
Unless the test operation is performed, the error code "U3" is shown on the remote controller and the unit cannot be operated.

Performing the test operation

- 1 To protect the compressor, make sure to turn on the power supply 6 hours before starting operation.
- 2 Set to setting mode 1 (H1P led is off) (refer to "Setting mode 1" on page 18).
- 3 Press the **BS4 TEST** button for 5 seconds when the unit is at a standstill. The test operation starts when the H2P led blinks and the remote controller indicates **TEST** (test operation) and (external control).

It may take 10 minutes to bring the state of refrigerant uniform before the compressor starts, but that is not a malfunction. The test operation is automatically carried out in cooling mode during 15~30 minutes.

Depending on the situation, the refrigerant running sound or the sound of a magnetic solenoid valve may rise during this operation.

The following items are automatically checked:

- Check for incorrect wiring
- Check if stop valves are open
- Check of refrigerant charge
- Automatic judgement of piping length

NOTE When you want to terminate the test operation, press the **BS3 RETURN** button. The unit will keep running for 30 seconds and then stops. During test operation it is impossible to stop the unit with the remote controller.

- 4 After the test operation (maximum 30 minutes), the unit automatically stops. Check the operation results by the outdoor unit led indication.

normal
abnormal

H1P	H2P	H3P	H4P	H5P	H6P	H7P
●	●	☀	●	●	●	●
●	☀	●	●	●	●	●



- Indoor units cannot be checked individually. After the test operation is finished, check the indoor units individually via the remote controller.
- The led indication changes during this operation, but that is not abnormal.
- Please attach the front plate of the outdoor unit in order to prevent electric shocks.

- 5 Measure to be taken when operation finishes abnormally
1. Confirm the error code on the remote controller.
 2. Correct what is abnormal.
(See the installation manual and operation manual or contact your dealer.)
 3. After the abnormality is corrected, press the **BS3 RETURN** button and reset the error code.
 4. Start the unit again to confirm that the problem is properly solved.
 5. If no error code is indicated on the remote controller, it is possible to start operation after 5 minutes.

Error codes on the remote controller

Installation error	Malfunction code	Remedial action
The stop valve of an outdoor unit is left closed.	E3	Open the stop valve on both the gas and liquid side.
The stop valve of an outdoor unit is left closed.	E4 F3	Open the stop valve on both the gas and liquid side.
Insufficient refrigerant		Check if the additional refrigerant charge has been finished correctly. Recalculate the required amount of refrigerant from the piping length and add an adequate amount of refrigerant.
Refrigerant overcharge	E3 F6	Recalculate the required amount of refrigerant from the piping length and correct the refrigerant charge level by recovering any excessive refrigerant with a refrigerant recovery machine.
Insufficient supply voltage	U2	Check if the supply voltage is supplied properly.
The check operation is not performed.	U3	Perform the check operation.
No power is supplied to the outdoor unit.	U4	Check if the power wiring for the outdoor unit is connected correctly.
Improper type of indoor units are connected.	UR	Check the type of indoor units that are currently connected. If they are not proper, replace them with proper ones.
The stop valve of an outdoor unit is left closed.	UF	Open the stop valve on both the gas and liquid side.
The piping and wiring of the specified indoor unit are not connected correctly to the outdoor unit.		Confirm that the piping and wiring of the specified indoor unit are connected correctly to the outdoor unit.
Incorrect interconnections between units.	UH	Connect correctly the interconnections between units to the F1 and F2 (TO IN/D UNIT) terminals on the PC board in the outdoor unit.
Power supply cables are connected in the reverse phase instead of the normal phase.	UI	Connect the power supply cables in normal phase. Change any two of the three power supply cables (L1, L2, L3) to correct phase.

12.5. Checks in normal operation

Set the master unit (= indoor unit having the right to select the cooling/heating operation mode).

In case of wired remote controllers

- After the check operation, "CHANGEOVER UNDER CONTROL" is blinking in all connected remote controllers.
- Select an indoor unit to be used as the master unit in accordance with the request from the customer.
(It is recommended to select an indoor unit which will be used most often as the master unit.)
- Press the operation mode selector button in the remote controller of the indoor unit selected as the master unit.
- In that remote controller, "CHANGEOVER UNDER CONTROL" disappears. That remote controller will control changeover of the cooling/heating operation mode.
- In other remote controllers, "CHANGEOVER UNDER CONTROL" lights up.

In case of wireless remote controllers

- After the check operation, the timer lamp is blinking in all connected indoor units.
- Select an indoor unit to be used as the master unit in accordance with the request from the customer.
(It is recommended to select an indoor unit which will be used most often as the master unit.)
- Press the operation selector mode button in the remote controller of the indoor unit selected as the master unit. A "peep" sound is issued, and the timer lamp turns off in all indoor units.
- That indoor unit will control changeover of the cooling/heating operation mode.

For the details, refer to the instruction manual supplied together with the indoor unit.

12.6. Temperature adjustment operation confirmation

After the test run is over, operate the unit normally. (Heating is not possible if the outdoor temperature is 24°C or higher.)

- Make sure the indoor and outdoor units are operating normally
(If a knocking sound can be heard in the liquid compression of the compressor, stop the unit immediately and then energize the heater for a sufficient length of time before restarting the operation.)
- Run each indoor unit one at a time and make sure the corresponding outdoor unit is also running.
- Check to see if cold (or hot) air is coming out of the indoor unit.
- Press the fan direction and fan strength buttons on the indoor unit to see if they operate properly.



Cautions for normal operation check

- Once stopping, the compressor will not restart in about 5 minutes even if the Run/Stop button of an indoor unit in the same system is pressed.
- When the system operation is stopped by the remote controller, the outdoor units may continue operating for a further 1 minute maximum.
- After the test run, when handing the unit over to the customer, make sure the electric box lid, the service lid and the unit casing are all attached properly.

13. SERVICE MODE OPERATION

After turning on the power supply, the unit can not be started until the H2P initialisation led, indicating that the unit is still under preparation, goes off (maximum 12 minutes).

Vacuumping method

At the first installation, this vacuuming is not required. It is required only for repair purposes.

- When the unit is at a standstill and under the setting mode 2, set the required function B (refrigerant recovery operation/vacuumping operation) to ON (ON).
 - After this is set, do not reset the setting mode 2 until the vacuuming is finished.
 - The H1P led is on and the remote controller indicates TEST (test operation) and  (external control) and the operation will be prohibited.
- Vacuum the system with a vacuum pump.
- Press the BS1 MODE button and reset the setting mode 2.

Refrigerant recovery operation method by a refrigerant reclaimier.

- When the unit is at a standstill and in setting mode 2, set the required function B (refrigerant recovery operation/vacuumping operation) to ON (ON).
 - The indoor unit and the outdoor unit expansion valves will fully open and some solenoid valves will open.
 - The H1P led is on and the remote controller indicates TEST (test operation) and  (external control) and the operation will be prohibited.
- Recover the refrigerant using a refrigerant reclaimier. For details, see the operation manual delivered with the refrigerant reclaimier.
- Press the BS1 MODE button and reset the setting mode 2.



CAUTION

Never turn the power of the outdoor unit OFF while the refrigerant is being recovered.

If the power is turned OFF, the solenoid valves are closed and the refrigerant cannot be recovered from the outdoor unit.

14. CAUTION FOR REFRIGERANT LEAKS

(Points to note in connection with refrigerant leaks.)

14.1. Introduction

The installer and system specialist shall secure safety against leakage according to local regulations or standards. The following standards may be applicable if local regulations are not available.

The VRV, like other air conditioning systems, uses R410A as refrigerant. R410A itself is an entirely safe non-toxic, non-combustible refrigerant. Nevertheless care must be taken to ensure that air conditioning facilities are installed in a room which is sufficiently large. This assures that the maximum concentration level of refrigerant gas is not exceeded, in the unlikely event of major leak in the system and this in accordance to the local applicable regulations and standards.

14.2. Maximum concentration level

The maximum charge of refrigerant and the calculation of the maximum concentration of refrigerant is directly related to the humanly occupied space in to which it could leak.

The unit of measurement of the concentration is kg/m³ (the weight in kg of the refrigerant gas in 1 m³ volume of the occupied space).

Compliance to the local applicable regulations and standards for the maximum allowable concentration level is required.

According to the appropriate European Standard, the maximum allowed concentration level of refrigerant to a humanly space for R410A is limited to 0.44 kg/m³.

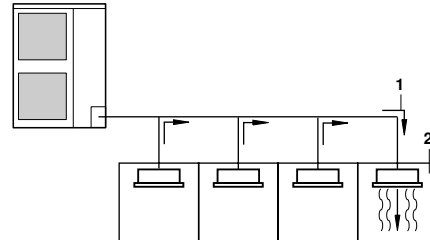

- direction of the refrigerant flow
- room where refrigerant leak has occurred (outflow of all the refrigerant from the system)

Pay special attention to places, such as a basements, etc. where refrigerant can stay, since refrigerant is heavier than air.

14.3. Procedure for checking maximum concentration

Check the maximum concentration level in accordance with steps 1 to 4 below and take whatever action is necessary to comply.

- Calculate the amount of refrigerant (kg) charged to each system separately.

amount of refrigerant in a single unit system (amount of refrigerant with which the system is charged before leaving the factory)	+	additional charging amount (amount of refrigerant added locally in accordance with the length or diameter of the refrigerant piping)	=	total amount of refrigerant (kg) in the system
---	---	--	---	--

NOTE



Where a single refrigerant facility is divided into 2 entirely independent refrigerant systems, use the amount of refrigerant with which each separate system is charged.

NOTES



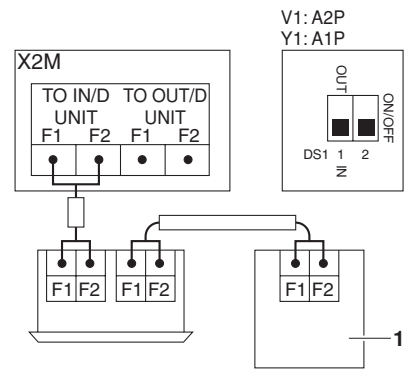
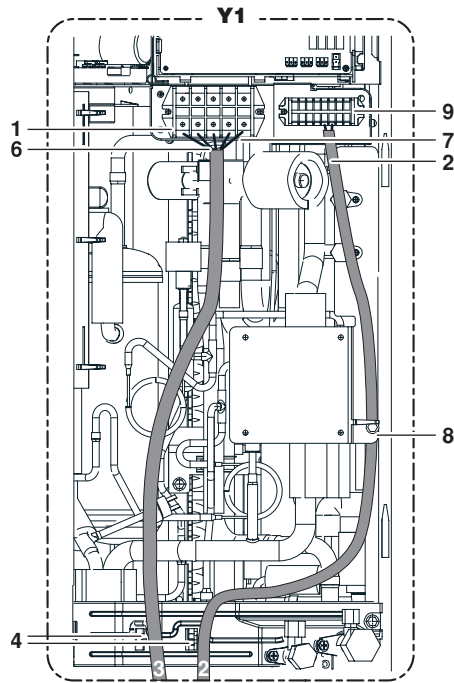
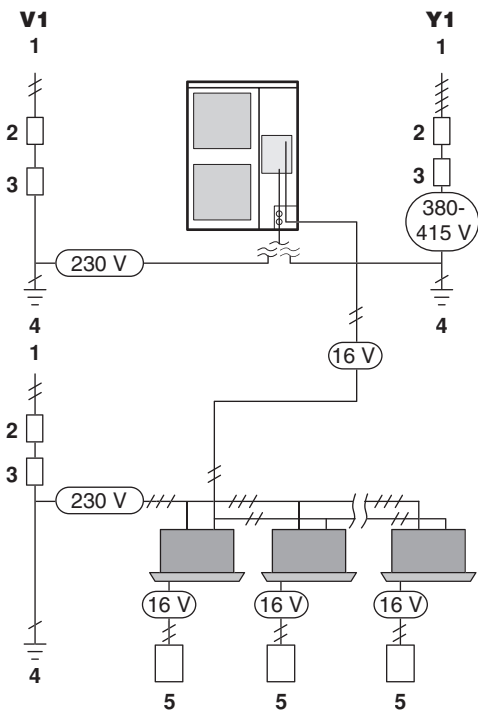

11

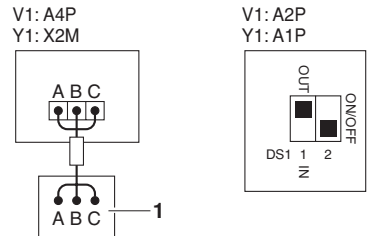

12

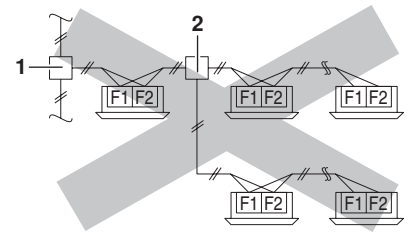

13

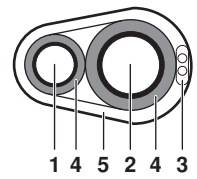

14

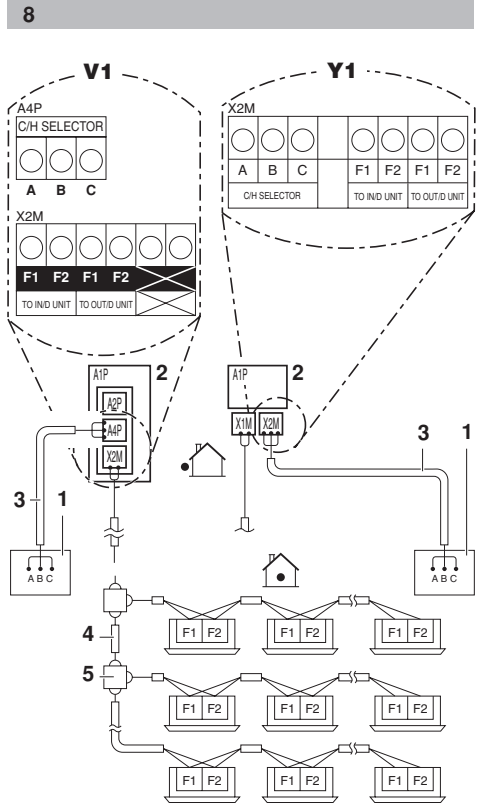

10

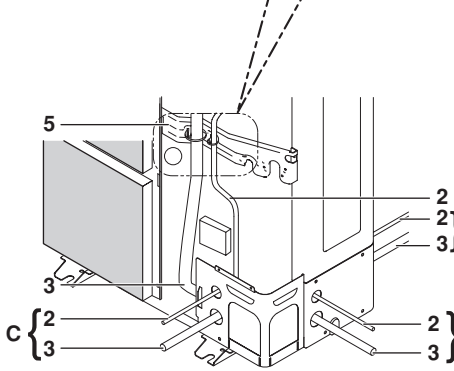
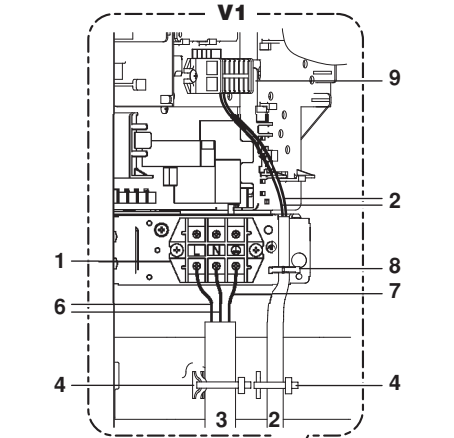

9

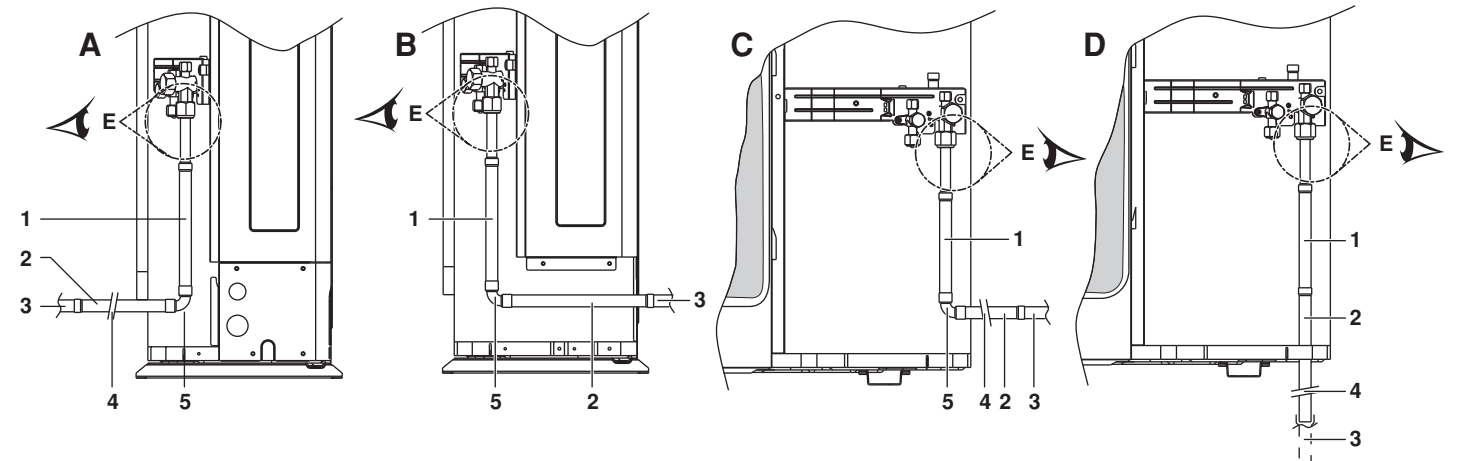
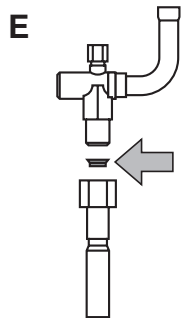

15



4PW40730-1 A 000000G

Copyright © Daikin

DAIKIN EUROPE N.V.

Zandvoordestraat 300, B-8400 Oostende, Belgium

4PW40730-1A