

**DAIKIN**



# INSTALLATION MANUAL

## ***VRV III*** System air conditioner

RXQ5P7W1B  
RXQ8P7W1B  
RXQ10P7W1B  
RXQ12P7W1B

RXQ14P7W1BA  
RXQ16P7W1BA  
RXQ18P7W1BA

RXYQ5P7W1B  
RXYQ8P8W1B  
RXYQ10P7W1B  
RXYQ12P7W1B  
RXYHQ12P8W1B

RXYQ14P7W1BA  
RXYQ16P7W1BA  
RXYQ18P7W1BA

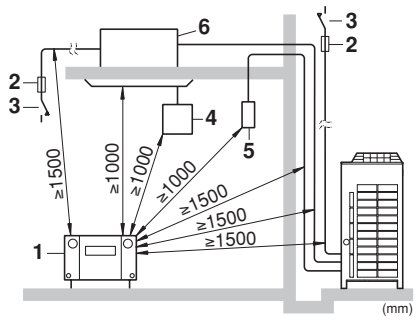
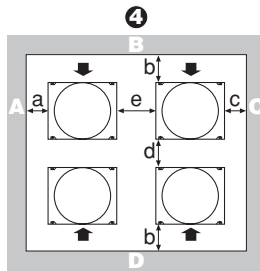
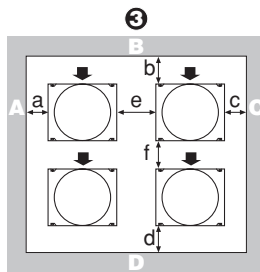
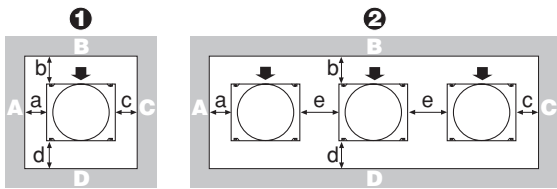

	A+B+C+D		A+B
①	a ≥ 10 mm b ≥ 300 mm c ≥ 10 mm d ≥ 500 mm	a ≥ 50 mm b ≥ 100 mm c ≥ 50 mm d ≥ 500 mm	a ≥ 200 mm b ≥ 300 mm
②	a ≥ 10 mm b ≥ 300 mm c ≥ 10 mm d ≥ 500 mm e ≥ 20 mm	a ≥ 50 mm b ≥ 100 mm c ≥ 50 mm d ≥ 500 mm e ≥ 100 mm	a ≥ 200 mm b ≥ 300 mm e ≥ 400 mm
③	a ≥ 10 mm b ≥ 300 mm c ≥ 10 mm d ≥ 500 mm e ≥ 20 mm f ≥ 600 mm	a ≥ 50 mm b ≥ 100 mm c ≥ 50 mm d ≥ 500 mm e ≥ 100 mm f ≥ 500 mm	
④	a ≥ 10 mm b ≥ 300 mm c ≥ 10 mm d ≥ 500 mm e ≥ 20 mm	a ≥ 50 mm b ≥ 100 mm c ≥ 50 mm d ≥ 500 mm e ≥ 100 mm	

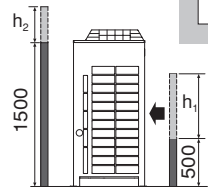

$h_1 > 0 \rightarrow b \geq b + \frac{h_1}{2}$   
 $h_2 > 0 \rightarrow d \geq d + \frac{h_2}{2}$

2

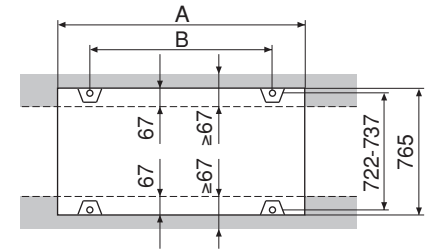

1

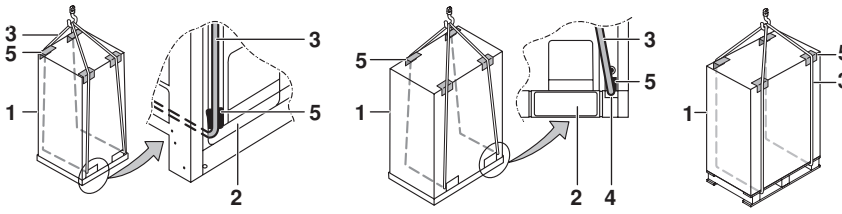

3

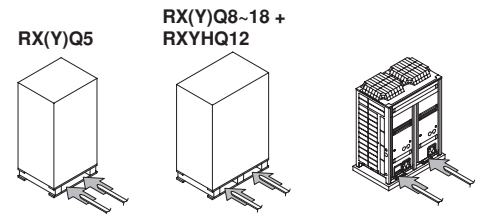

4

RX(Y)Q5-18 + RXYHQ12

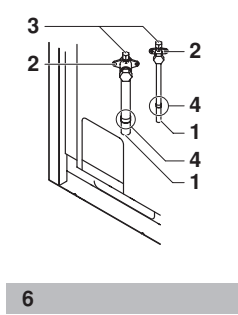
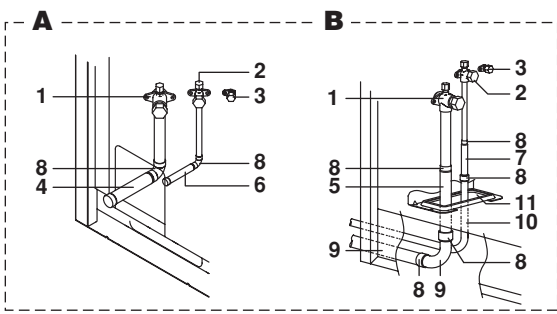

5

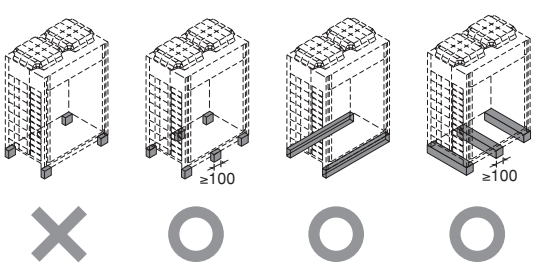

RXYQ20-54 + RXYHQ16-36

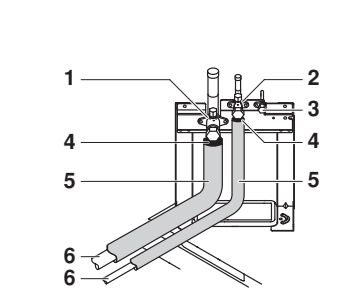
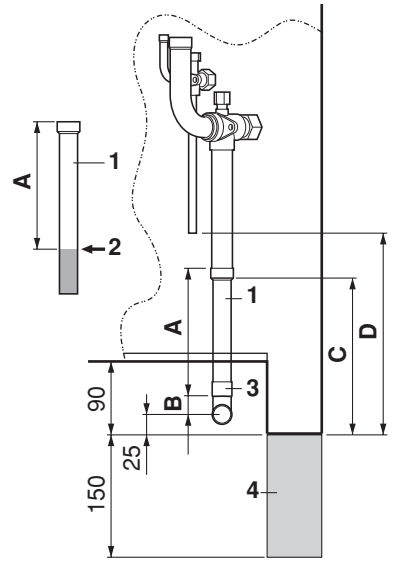
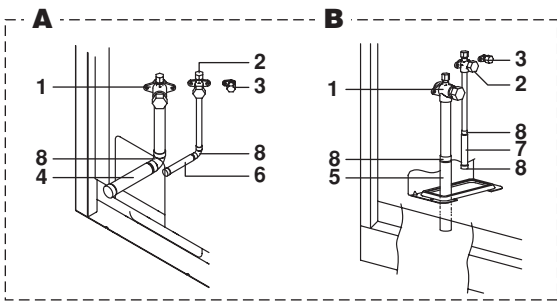

8

9

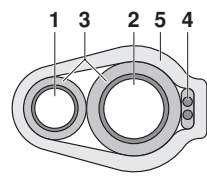
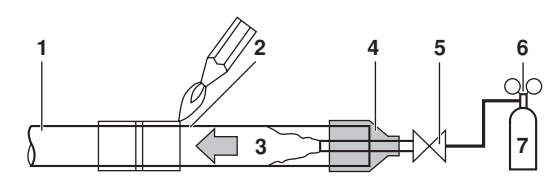

10

11

12

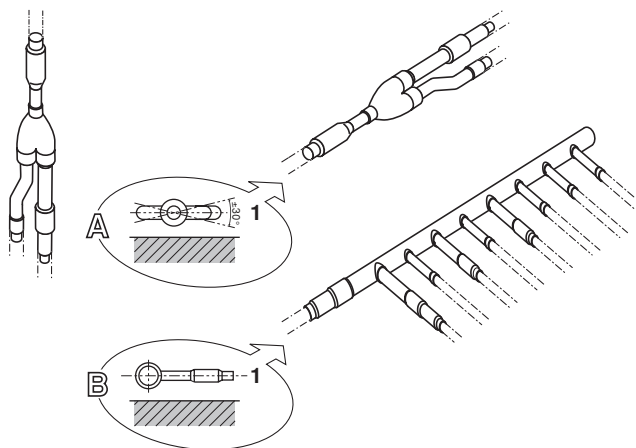

13

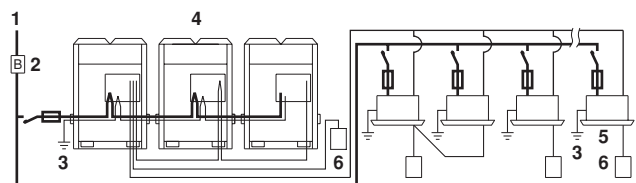

15

14

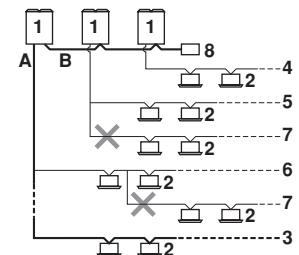

16

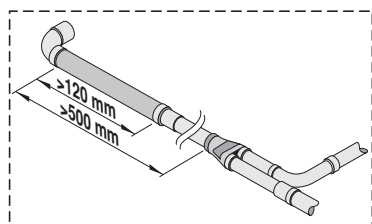
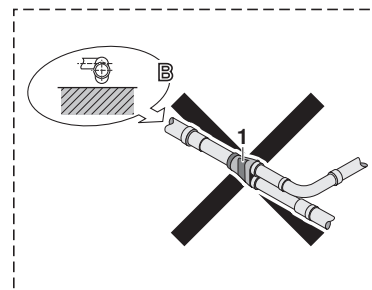
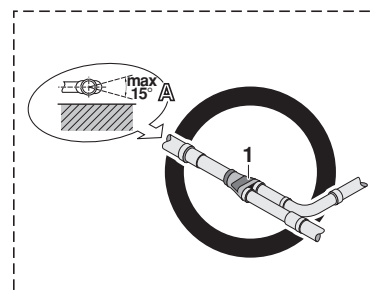

17

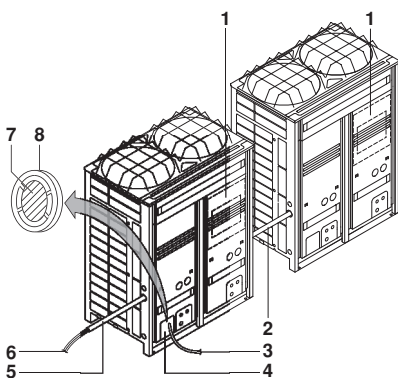

18

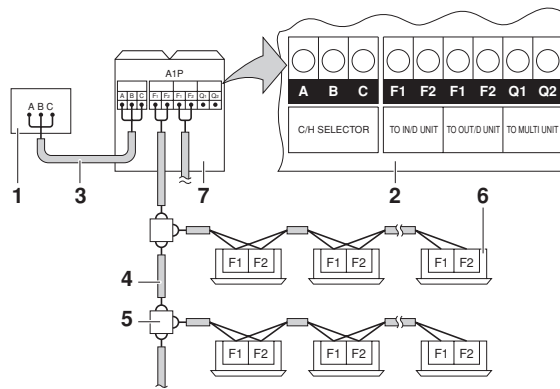

19

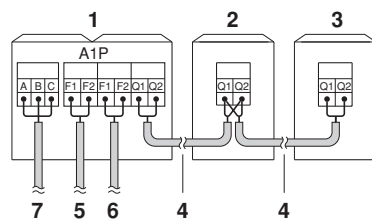

20

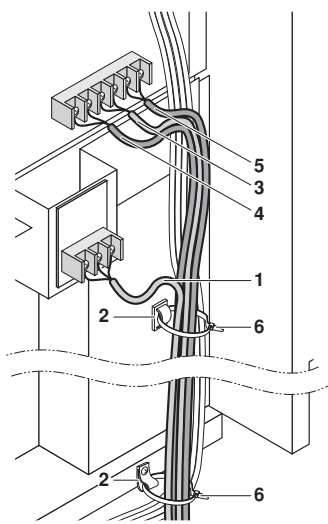

23

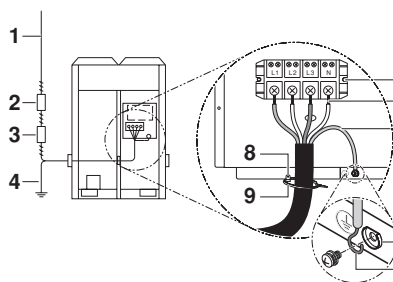

21

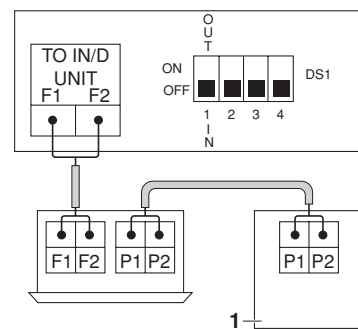

22

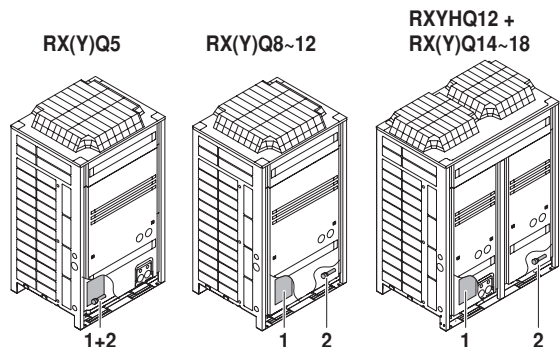

24

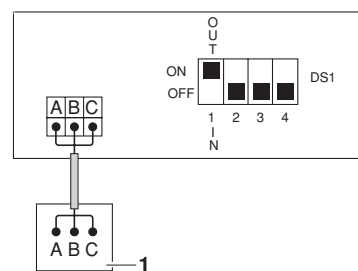

25





## CONTENTS

	Page
1. Introduction.....	1
1.1. Combination.....	2
1.2. Standard supplied accessories.....	2
1.3. Optional accessories.....	3
1.4. Technical and Electrical specifications.....	3
2. Main components.....	3
3. Selection of location.....	3
4. Inspecting and handling the unit.....	4
5. Unpacking and placing the unit.....	4
6. Refrigerant piping.....	5
6.1. Installation tools.....	5
6.2. Selection of piping material.....	5
6.3. Pipe connection.....	6
6.4. Connecting the refrigerant piping.....	6
6.5. Protection against contamination when installing pipes.....	8
6.6. Example of connection.....	9
7. Leak test and vacuum drying.....	11
8. Field wiring.....	12
8.1. Internal wiring – Parts table.....	12
8.2. Optional parts cool/heat selector.....	13
8.3. Power circuit and cable requirements.....	13
8.4. General cautions.....	14
8.5. System examples.....	15
8.6. Leading power line and transmission line.....	15
8.7. Field line connection: transmission wiring and cool/heat selection.....	16
8.8. Field line connection: power wiring.....	17
8.9. Wiring example for wiring inside unit.....	17
9. Pipe insulation.....	18
10. Checking of unit and installation conditions.....	18
11. Charging refrigerant.....	18
11.1. Important information regarding the refrigerant used.....	18
11.2. Precautions when adding R410A.....	19
11.3. Stop valve operation procedure.....	19
11.4. How to check how many units are connected.....	19
11.5. Additional refrigerant charge.....	20
11.6. Checks after adding refrigerant.....	24
12. Before operation.....	25
12.1. Service precautions.....	25
12.2. Checks before initial start-up.....	25
12.3. Field setting.....	25
12.4. Test operation.....	27
13. Service mode operation.....	29
14. Caution for refrigerant leaks.....	29
15. Disposal requirements.....	30



READ THIS MANUAL ATTENTIVELY BEFORE STARTING UP THE UNIT. DO NOT THROW IT AWAY. KEEP IT IN YOUR FILES FOR FUTURE REFERENCE.

IMPROPER INSTALLATION OR ATTACHMENT OF EQUIPMENT OR ACCESSORIES COULD RESULT IN ELECTRIC SHOCK, SHORT-CIRCUIT, LEAKS, FIRE OR OTHER DAMAGE TO THE EQUIPMENT. BE SURE ONLY TO USE ACCESSORIES MADE BY DAIKIN WHICH ARE SPECIFICALLY DESIGNED FOR USE WITH THE EQUIPMENT AND HAVE THEM INSTALLED BY A PROFESSIONAL.

DAIKIN EQUIPMENT IS DESIGNED FOR COMFORT APPLICATIONS. FOR USE IN OTHER APPLICATIONS, PLEASE CONTACT YOUR LOCAL DAIKIN DEALER.

IF UNSURE OF INSTALLATION PROCEDURES OR USE, ALWAYS CONTACT YOUR DEALER FOR ADVICE AND INFORMATION.

THIS AIR CONDITIONER COMES UNDER THE TERM "APPLIANCES NOT ACCESSIBLE TO THE GENERAL PUBLIC".



The refrigerant charge of the system must be less than 100 kg. This means that in case the calculated refrigerant charge is equal to or more than 95 kg you must divide your multiple outdoor system into smaller independent systems, each containing less than 95 kg refrigerant charge.

For factory charge, refer to the unit name plate.



The refrigerant R410A requires strict cautions for keeping the system clean, dry and tight.

- Clean and dry  
Foreign materials (including mineral oils such as SUNISO oil or moisture) should be prevented from getting mixed into the system.
- Tight  
R410A does not contain any chlorine, does not destroy the ozone layer, and does not reduce the earth's protection against harmful ultraviolet radiation. R410A can contribute slightly to the greenhouse effect if it is released. Therefore we should take special attention to check the tightness of the installation.

Read "6. Refrigerant piping" on page 5 carefully and follow these procedures correctly.



Since design pressure is 4.0 MPa or 40 bar (for R407C units: 3.3 MPa or 33 bar), pipes of larger wall thickness may be required. The wall thickness of piping must be carefully selected, refer to paragraph "6.2. Selection of piping material" on page 5 for more details.

## 1. INTRODUCTION

This installation manual concerns VRV inverters of the Daikin RX(Y)Q-P + RXYHQ series. These units are designed for outdoor installation and used for cooling and heat pump applications. The RXQ-P7 cooling only series consist of 7 main stand-alone units and has nominal cooling capacities ranging from 14.0 to 49.0 kW. The RXY(H)Q-P series can be combined from 8 main units and has nominal cooling capacities ranging from 14.0 to 147 kW and nominal heating capacities ranging from 16.0 to 170 kW.

The RX(Y)Q-P + RXYHQ units can be combined with Daikin VRV indoor units for air conditioning purposes, and suitable for R410A.

The present installation manual describes the procedures for unpacking, installing and connecting the RX(Y)Q-P + RXYHQ units. Installation of the indoor units is not described in this manual. Always refer to the installation manual supplied with these units for their installation.

## 1.1. Combination

The indoor units can be installed in the following range.

- Always use appropriate indoor units compatible with R410A. To learn which models of indoor units are compatible with R410A, refer to the product catalogs.
- Pay attention when connecting outdoor units in multi combination. RXYQ-M units are NOT compatible with RXY(H)Q-P units.
- Total capacity/quantity of indoor units

Standard combination of outdoor units	Total capacity of indoor units	Total quantity of indoor units
RX(Y)Q5 (a)	62.5~162.5	12
RX(Y)Q8 (a)	100~260	20
RX(Y)Q10 (a)	125~325	25
RX(Y)Q12 (a)	150~390	30
RX(Y)Q14 (a)	175~455	35
RX(Y)Q16 (a)	200~520	40
RX(Y)Q18 (a)	225~585	45
RXYQ20 = RXYQ8 + RXYQ12	250~650	40
RXYQ22 = RXYQ10 + RXYQ12	275~715	44
RXYQ24 = RXYQ12 + RXYQ12	300~780	48
RXYQ26 = RXYQ8 + RXYQ18	325~845	52
RXYQ28 = RXYQ10 + RXYQ18	350~910	56
RXYQ30 = RXYQ12 + RXYQ18	375~975	60
RXYQ32 = RXYQ14 + RXYQ18	400~1040	64
RXYQ34 = RXYQ16 + RXYQ18	425~1105	64
RXYQ36 = RXYQ18 + RXYQ18	450~1170	64
RXYQ38 = RXYQ8 + RXYQ12 + RXYQ18	475~1235	61
RXYQ40 = RXYQ10 + RXYQ12 + RXYQ18	500~1300	64
RXYQ42 = RXYQ12 + RXYQ12 + RXYQ18	525~1365	64
RXYQ44 = RXYQ8 + RXYQ18 + RXYQ18	550~1430	64
RXYQ46 = RXYQ10 + RXYQ18 + RXYQ18	575~1495	64
RXYQ48 = RXYQ12 + RXYQ18 + RXYQ18	600~1560	64
RXYQ50 = RXYQ14 + RXYQ18 + RXYQ18	625~1625	64
RXYQ52 = RXYQ16 + RXYQ18 + RXYQ18	650~1690	64
RXYQ54 = RXYQ18 + RXYQ18 + RXYQ18	675~1755	64

(a) = main unit

Standard combination of outdoor units	Total capacity of indoor units	Total quantity of indoor units
RXYHQ12 (a)	150~390	30
RXYHQ16 = RXYQ8 + RXYQ8	200~520	32
RXYHQ18 = RXYQ8 + RXYQ10	225~585	36
RXYHQ20 = RXYQ8 + RXYHQ12	250~650	40
RXYHQ22 = RXYQ10 + RXYHQ12	275~715	44
RXYHQ24 = RXYQ8 + RXYQ8 + RXYQ8	300~780	39
RXYHQ26 = RXYQ8 + RXYQ8 + RXYQ10	325~845	42
RXYHQ28 = RXYQ8 + RXYQ10 + RXYQ10	350~910	45
RXYHQ30 = RXYQ8 + RXYQ10 + RXYHQ12	375~975	48
RXYHQ32 = RXYQ8 + RXYHQ12 + RXYHQ12	400~1040	52
RXYHQ34 = RXYQ10 + RXYHQ12 + RXYHQ12	425~1105	55
RXYHQ36 = RXYHQ12 + RXYHQ12 + RXYHQ12	450~1170	58

(a) = main unit

### NOTE



- The table above shows the possible total capacity and number of possible indoor units when configured in a standard combination. Refer to the service manual for more details when using a configuration other than a standard combination.
- If the total capacity of the connected indoor units exceeds the capacity of the outdoor unit, cooling and heating performance may drop when running the indoor units. Refer to the section on performance characteristics in the Engineering Data Book for details.
- There are restrictions on the refrigerant pipe connection order between outdoor units during installation in case of a multiple outdoor unit system. Install according to the following restrictions. The capacities of outdoor units A, B, and C must fulfill the following restriction conditions:  $A \geq B \geq C$ .

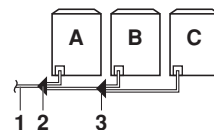

- To indoor units
- Outdoor unit multi connection piping kit (first branch)
- Outdoor unit multi connection piping kit (second branch)

## 1.2. Standard supplied accessories

See location 1 in figure 24 for reference to where following accessories are supplied with the unit.

Installation manual	1
Operation manual	1
Fluorinated greenhouse gases label	1
Multilingual fluorinated greenhouse gases label	1

See location 2 in figure 24 for reference to where following accessories are supplied with the unit.

Gas side accessory pipe <sup>(a)</sup>		
Unit type	Item	Quantity
5~18 Hp		1
5~10 Hp		1
12~18 Hp		1
Liquid side accessory pipe <sup>(a)</sup>		
Unit type	Item	Quantity
5~18 Hp		1
5~10, 14, 16 Hp		1
12, 18 Hp		1

(a) = main unit

### 1.3. Optional accessories

To install the above outdoor units, the following optional parts are also required.

- Refrigerant branching kit (for R410A only: Always use an appropriate kit dedicated for your system.)

Refnet header	Refnet joint
KHRQ22M29H	KHRQ22M20T
KHRQ22M64H	KHRQ22M29T9
KHRQ22M75H	KHRQ22M64T
	KHRQ22M75T

- Outdoor unit multi connection piping kit (For R410A only: Always use an appropriate kit dedicated for your system.)

Number of outdoor units connected	
2	3
BHFQ22P1007	BHFQ22P1517

- Pipe size reducer (For R410A only: Always use an appropriate kit dedicated for your system.)

RXY(H)Q24~36 + RXYQ38~54	
KHRQ22M75T	KHRQ22M75H

To select an optimum refrigerant branching kit, refer to "6. Refrigerant piping" on page 5.

### 1.4. Technical and Electrical specifications

Refer to the Engineering Data Book for the complete list of specifications.

## 2. MAIN COMPONENTS

For main components and function of the main components, refer to the Engineering Data Book.

## 3. SELECTION OF LOCATION

This unit, both indoor and outdoor, is suitable for installation in a commercial and light industrial environment. If installed as a household appliance it could cause electromagnetic interference, in which case the user may be required to take adequate measures.



- Make sure to provide for adequate measures in order to prevent that the outdoor unit be used as a shelter by small animals.
- Small animals making contact with electrical parts can cause malfunctions, smoke or fire. Please instruct the customer to keep the area around the unit clean.

Obtain the customer's permission before installing.

The inverter units should be installed in a location that meets the following requirements:

- 1 The foundation is strong enough to support the weight of the unit and the floor is flat to prevent vibration and noise generation.



If not, the unit may fall over and cause damage or injury.

- 2 The space around the unit is adequate for servicing and the minimum space for air inlet and air outlet is available. (Refer to figure 1 and choose one of the possibilities).

**A B C D** Sides along the installation site with obstacles  
 Suction side

- In case of an installation site where sides **A+B+C+D** have obstacles, the wall heights of sides **A+C** have no impact on service space dimensions. Refer to figure 1 for impact of wall heights of sides **B+D** on service space dimensions.
- In case of an installation site where only the sides **A+B** have obstacles, the wall heights have no influence on any indicated service space dimensions.

**NOTE**



The service space dimensions in figure 1 are based on cooling operation at 35°C.

- 3 Make sure that there is no danger of fire due to leakage of inflammable gas.
- 4 Ensure that water can not cause any damage to the location in case it drips out the unit (e.g. in case of a blocked drain pipe).
- 5 The piping length between the outdoor unit and the indoor unit may not exceed the allowable piping length. (Refer to "6.6. Example of connection" on page 9)
- 6 Select the location of the unit in such a way that neither the discharged air nor the sound generated by the unit disturbs anyone.
- 7 Make sure that the air inlet and outlet of the unit are not positioned towards the main wind direction. Frontal wind will disturb the operation of the unit. If necessary, use a windscreen to block the wind.
- 8 Do not install or operate the unit on locations where air contains high levels of salt, like e.g. in the vicinity of oceans. (Refer for further information to the engineering databook).
- 9 During installation, avoid the possibility that anybody can climb on the unit or place objects on the unit.  
Falls may result in injury.
- 10 When installing the unit in a small room, take measures in order to keep the refrigerant concentration from exceeding allowable safety limits in the event of a refrigerant leak.



Excessive refrigerant concentrations in a closed room can lead to oxygen deficiency.





- The equipment described in this manual may cause electronic noise generated from radio-frequency energy. The equipment complies to specifications that are designed to provide reasonable protection against such interference. However, there is no guarantee that interference will not occur in a particular installation. It is therefore recommended to install the equipment and electric wires keeping proper distances away from stereo equipment, personal computers, etc... (See figure 2).

- 1 Personal computer or radio
- 2 Fuse
- 3 Earth leakage breaker
- 4 Remote controller
- 5 Cool/heat selector
- 6 Indoor unit



In places with weak reception, keep distances of 3 m or more to avoid electromagnetic disturbance of other equipment and use conduit tubes for power and transmission lines.

- In heavy snowfall areas, select an installation site where snow will not affect the operation of the unit.
- The refrigerant R410A itself is nontoxic, nonflammable and is safe. If the refrigerant should leak however, its concentration may exceed the allowable limit depending on room size. Due to this, it could be necessary to take measures against leakage. Refer to the chapter "14. Caution for refrigerant leaks" on page 29.
- Do not install in the following locations.
  - Locations where sulfurous acids and other corrosive gases may be present in the atmosphere. Copper piping and soldered joints may corrode, causing refrigerant to leak.
  - Locations where a mineral oil mist, spray or vapour may be present in the atmosphere. Plastic parts may deteriorate and fall off or causing water leakage.
  - Locations where equipment that produces electromagnetic waves is found. The electromagnetic waves may cause the control system to malfunction, preventing normal operation.
  - Locations where flammable gases may leak, where thinner, gasoline, and other volatile substances are handled, or where carbon dust and other incendiary substances are found in the atmosphere. Leaked gas may accumulate around the unit, causing an explosion.
- When installing, take strong winds, typhoons or earthquakes into account. Improper installation may result in fall over of the unit.

## 4. INSPECTING AND HANDLING THE UNIT

At delivery, the package should be checked and any damage should be reported immediately to the carrier claims agent.

When handling the unit, take into account the following:

- 1  Fragile, handle the unit with care.
- 1  Keep the unit upright in order to avoid compressor damage.
- 2 Choose on beforehand the path along which the unit is to be brought in.
- 3 Bring the unit as close as possible to its final installation position in its original package to prevent damage during transport. (See figure 4)
  - 1 Packaging material
  - 2 Opening (large)
  - 3 Belt sling
  - 4 Opening (small) (40x45)
  - 5 Protector
- 4 Lift the unit preferably with a crane and 2 belts of at least 8 m long. (See figure 4)

Always use protectors to prevent belt damage and pay attention to the position of the unit's centre of gravity.

**NOTE**  Use a belt sling of  $\leq 20$  mm wide that adequately bears the weight of the unit.

- 5 If a forklift is to be used, preferably transport the unit with pallet first, then pass the forklift arms through the large rectangular openings on the bottom of the unit. (See figure 5)
  - 5.1 From the moment you use a forklift to move the unit to its final position, lift the unit under the pallet.
  - 5.2 Once at final position, unpack the unit and pass the forklift arms through the large rectangular openings on the bottom of the unit.

**NOTE**  Use filler cloth on the forklift arms to prevent damaging the unit. If the paint on the bottom frame peels off, the anti corrosion effect may decrease.

## 5. UNPACKING AND PLACING THE UNIT

- Remove the four screws fixing the unit to the pallet.
- Make sure the unit is installed level on a sufficiently strong base to prevent vibration and noise.



Do not use stands to only support the corners. (See figure 7)

- X Not allowed (except for RX(Y)Q5)
- O Allowed (units: mm)

- Make sure the base under the unit is larger than the 765 mm of the unit depth. (See figure 3)
- The height of the foundation must at least be 150 mm from the floor.
- The unit must be installed on a solid longitudinal foundation (steelbeam frame or concrete) as indicated in figure 3.

Model	A	B
RX(Y)Q5	635	497
RX(Y)Q8~12	930	792
RX(Y)Q14~18 + RXYHQ12	1240	1102

- Support the unit with a foundation of 67 mm wide or more. (The support leg of the unit is 67 mm wide, see [figure 3](#)).

- Fasten the unit in place using four foundation bolts M12. It is best to screw in the foundation bolts until their length remains 20 mm above the foundation surface.

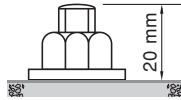

- Prepare a water drainage channel around the foundation to drain waste water from around the unit.
- If the unit is to be installed on a roof, check the strength of the roof and its drainage facilities first.
- If the unit is to be installed on a frame, install the waterproofing board within a distance of 150 mm under the unit in order to prevent infiltration of water coming from under the unit.
- When installed in a corrosive environment, use a nut with plastic washer (1) to protect the nut tightening part from rust.

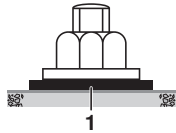

## Method for removing transportation stays

(only for RXYHQ12 units)

The 4 yellow transportation stays installed over the compressor legs for protecting the unit during transport must be removed. Proceed as shown in [figure 30](#) and described below.

- A Compressor
- B Fixing nut
- C Transportation stay

- 1 Slightly loosen the fixing nut (B).
- 2 Remove the transportation stay (C).
- 3 Tighten the fixing nut (B) again.



### CAUTION

If the unit is operated with the transportation stays still in place, abnormal vibration or noise may be generated.

## 6. REFRIGERANT PIPING



**Do not insert fingers, rods or other objects into the air inlet or outlet. When the fan is rotating at high speed, it will cause injury.**



Use R410A to add refrigerant.

All field piping must be installed by a licensed refrigeration technician and must comply with relevant local and national regulations.

### Caution to be taken when brazing refrigerant piping

Do not use flux when brazing copper-to-copper refrigerant piping. (Particularly for the HFC refrigerant piping) Therefore, use the phosphor copper brazing filler metal (BCuP) which does not require flux.

Flux has extremely harmful influence on refrigerant piping systems. For instance, if the chlorine based flux is used, it will cause pipe corrosion or, in particular, if the flux contains fluorine, it will damage the refrigerant oil.

Be sure to perform a nitrogen blow when brazing. Brazing without performing nitrogen replacement or releasing nitrogen into the piping will create large quantities of oxidized film on the inside of the pipes, adversely affecting valves and compressors in the refrigerating system and preventing normal operation.

After completing the installation work, check that the refrigerant gas does not leak.

Toxic gas may be produced if the refrigerant gas leaks into the room and comes in contact with a source of fire.

Ventilate the area immediately in the event of a leak.

In the event of a leak, do not touch the leaked refrigerant directly. Frostbite may be caused.

### 6.1. Installation tools

Make sure to use installation tools (gauge manifold charge hose, etc.) that are exclusively used for R410A installations to withstand the pressure and to prevent foreign materials (e.g. mineral oils such as SUNISO and moisture) from mixing into the system. (The screw specifications differ for R410A and R407C.)

Use a 2-stage vacuum pump with a non-return valve which can evacuate to  $-100.7$  kPa (5 Torr,  $-755$  mm Hg).

#### NOTE



Make sure the pump oil does not flow oppositely into the system while the pump is not working.

### 6.2. Selection of piping material

1. Foreign materials inside pipes (including oils for fabrication) must be 30 mg/10 m or less.
2. Use the following material specification for refrigerant piping:
  - Size: determine the proper size referring to chapter "6.6. Example of connection" on page 9.
  - Construction material: phosphoric acid deoxidized seamless copper for refrigerant.
  - Temper grade: use piping with temper grade in function of the pipe diameter as listed in the table below.

Pipe Ø	Temper grade of piping material
≤15.9	O
≥19.1	1/2H

O = Annealed  
1/2H = Half hard

- The pipe thickness of the refrigerant piping should comply with relevant local and national regulations. The minimal pipe thickness for R410A piping must be in accordance with the table below.

Pipe Ø	Minimal thickness t (mm)
6.4	0.80
9.5	0.80
12.7	0.80
15.9	0.99
19.1	0.80

Pipe Ø	Minimal thickness t (mm)
22.2	0.80
28.6	0.99
34.9	1.21
41.3	1.43

3. Make sure to use the particular branches of piping that have been selected referring to chapter "6.6. Example of connection" on page 9.
4. In case the required pipe sizes (inch sizes) are not available, it is also allowed to use other diameters (mm sizes), taken the following into account:
  - select the pipe size nearest to the required size.
  - use the suitable adapters for the change-over from inch to mm pipes (field supply).
5. Precautions when selecting branch piping  
When the equivalent pipe length between outdoor and indoor units is 90 m or more, the size of the main pipes (both gas side and liquid side) must be increased. Depending on the length of the piping, the capacity may drop, but even in such a case it is possible to increase the size of the main pipes. Refer to page 10. If the recommended pipe size is not available, stick to the original pipe diameter (which may result in a small capacity decrease).

### 6.3. Pipe connection

Be sure to perform a nitrogen blow when brazing and to read the paragraph "Caution to be taken when brazing refrigerant piping" on page 5 first.

**NOTE** The pressure regulator for the nitrogen released when doing the brazing should be set to 0.02 MPa or less. (See figure 10)

- 1 Refrigerant piping
- 2 Location to be brazed
- 3 Nitrogen
- 4 Taping
- 5 Manual valve
- 6 Regulator
- 7 Nitrogen

**!** Do not use anti-oxidants when brazing the pipe joints. Residue can clog pipes and break equipment.

### 6.4. Connecting the refrigerant piping

#### 1 Front connection or side connection

Installation of refrigerant piping is possible as front connection or side connection (when taken out from the bottom) as shown in the figure.

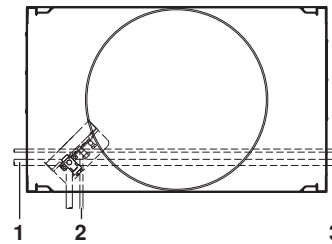

- 1 Left-side connection
- 2 Front connection
- 3 Right-side connection

**NOTE** Precautions when knocking out knock holes

- Be sure to avoid damaging the casing
- After knocking out the holes, we recommend you remove the burrs and paint the edges and areas around the edges using the repair paint to prevent rusting.
- When passing electrical wiring through the knock holes, wrap the wiring with protective tape to prevent damage.

#### 2 Removing the pinched piping

When connecting refrigerant piping to the outdoor unit, first remove the pinched piping. Do not vent gases into the atmosphere.

Removing of the pinched piping must be carried out according to the following procedure:

1. Make sure the stop valves are closed.
2. Connect a charge hose to the service ports of all stop valves.
3. Recover the gas from the pinched piping.
4. When all the gas is recovered from the pinched piping, dissolve the brazing using a burner and remove the pinched piping.

**!** Any gas remaining inside the stop valve may blow off the pinched piping, causing damage or injury.

See figure 6.

- 1 Pinched piping
- 2 Stop valve
- 3 Service port
- 4 Point of melting the brazing metal

**!** Precautions when connecting field piping.

- Perform brazing at the gas stop valve before brazing at the liquid stop valve.
- Add brazing material as shown in the figure.

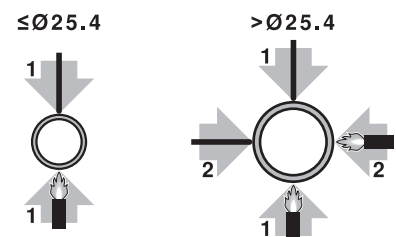



- Be sure to use the supplied accessory pipes when carrying out piping work in the field.
- Be sure that the field installed piping does not touch other pipes, the bottom panel or side panel. Especially for the bottom and side connection, be sure to protect the piping with suitable insulation, to prevent it from coming into contact with the casing.

### 3 One outdoor unit installed: In case of RX(Y)Q5~18 + RXYHQ12

(See figure 8)

- Front connection:  
Remove the stop valve cover to connect.
- Bottom connection:  
Remove the knock holes on the bottom frame and route the piping under the bottom frame.

- A** Front connection  
Remove the stop valve cover to connect.
- B** Bottom connection:  
Remove the knock holes on the bottom frame and route the piping under the bottom frame
- 1 Gas pipe stop valve
  - 2 Liquid pipe stop valve
  - 3 Service port for adding refrigerant
  - 4 Gas side accessory pipe (1)
  - 5 Gas side accessory pipe (2)
  - 6 Liquid side accessory pipe (1)
  - 7 Liquid side accessory pipe (2)
  - 8 Brazing
  - 9 Gas side piping (field supply)
  - 10 Liquid side piping (field supply)
  - 11 Punch the knockout holes (use a hammer)

- Processing the gas side accessory pipe (2)  
Only in case of connecting at lateral side, cut the gas side accessory pipe (2) as shown in figure 11.

- 1 Gas side accessory pipe
- 2 Cutting location
- 3 Gas side piping (field supply)
- 4 Base

Model		A	B	C	D
RX(Y)Q5	(mm)	166	16	199	246
RX(Y)Q8	(mm)	156	17	188	247
RX(Y)Q10	(mm)	156	23	192	247
RX(Y)Q12	(mm)	150	29	192	247
RX(Y)Q14~18 + RXYHQ12	(mm)	150	29	192	251



- NOTE**
- When connecting the piping on site, be sure to use the accessory piping.
  - Make sure the onsite piping does not come into contact with other piping, the bottom frame or side panels of the unit.

### 4 Outdoor units installed in a multiple outdoor unit system: RXYQ20~54 + RXYHQ16~36

- Front connection:  
Remove the stop valve cover to connect. (See figure 8)
- Bottom connection:  
Remove the knock holes on the bottom frame and route the piping under the bottom frame. (See figure 8)

### 4.1 Precautions when connecting piping between outdoor units (multiple outdoor unit system)

- The 5 Hp unit type can not be used as an independent unit in a multi system.
- To connect the piping between outdoor units, an optional multi connection piping kit BHFQ22P1007/1517 is always required. When installing the piping, follow the instructions in the installation manual that comes with the kit.
- Only proceed with piping work after considering the limitations on installing listed here and in the chapter "6.4. Connecting the refrigerant piping" on page 6, always referring to the installation manual delivered with the kit.

### 4.2 Possible installation patterns and configurations

- The piping between the outdoor units must be routed level or slightly upward to avoid the risk of oil retention into the piping side.

#### Pattern 1



- 1 To indoor unit

#### Pattern 2



- 1 To indoor unit

**Prohibited patterns:** change to pattern 1 or 2.

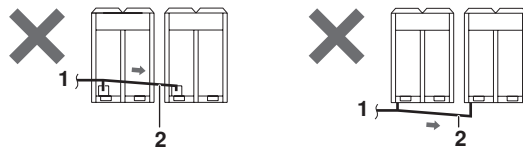

- 1 To indoor unit
- 2 Piping between outdoor units

- To avoid the risk of oil retention to the outmost outdoor unit, always connect the stop valve and the piping between outdoor units as shown in the 4 correct possibilities of the figure below.

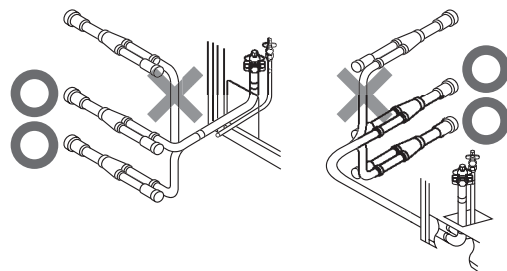

**Prohibited patterns:** change to pattern 1 or 2.

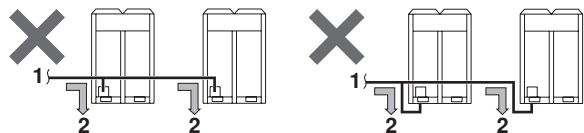

- 1 To indoor unit
- 2 Oil collects to the outmost outdoor unit.

**Change to configuration as in figures below**

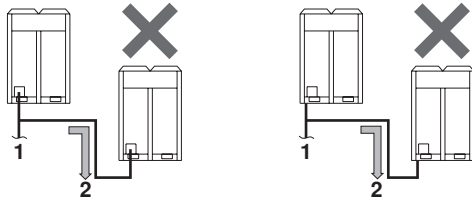

- 1 To indoor unit
- 2 Oil collects to the outmost outdoor unit when the system stops.

**Correct configuration**

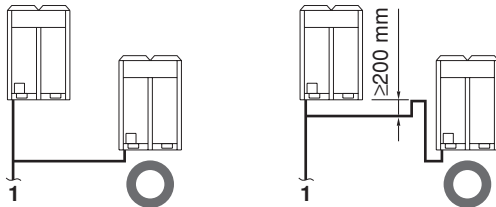

- 1 To indoor unit

- If the piping length between the outdoor units exceeds 2 m, create a rise of 200 mm or more in the gas line within a length of 2 m from the kit.

**- If  $\leq 2$  m**

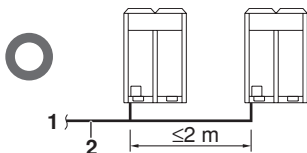

- 1 To indoor unit
- 2 Piping between outdoor units

**- If  $\geq 2$  m**

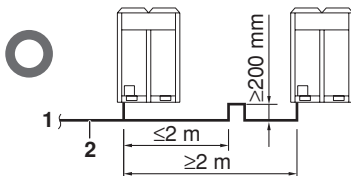

- 1 To indoor unit
- 2 Piping between outdoor units

**5 Branching the refrigerant piping**

- For installation of the refrigerant branching kit, refer to the installation manual delivered with the kit. (See figure 13)

- 1 Horizontal surface

Follow the conditions listed below:

- Mount the renet joint so that it branches either horizontally or vertically.
- Mount the renet header so that it branches horizontally.

■ Installation of the multi connection piping kit

(See figure 17)

- Install the joints horizontally, so that the caution label (1) attached to the joint comes to the top. Do not tilt the joint more than 15° (see view A). Do not install the joint vertically (see view B).
- Make sure that the total length of the piping connected to the joint is absolute straight for more than 500 mm. Only if a straight field piping of more than 120 mm is connected, more than 500 mm of straight section can be ensured.
- Improper installation may lead to malfunction of the outdoor unit.

**6 Piping length restrictions**

Make sure to perform the piping installation within the range of the maximum allowable pipe length, allowable level difference and allowable length after branching as indicated in "6.6. Example of connection" on page 9.

**6.5. Protection against contamination when installing pipes**

- Take measures to prevent foreign materials like moisture and contamination from mixing into the system.

	Installation period	Protection method
🏠	More than a month	Pinch the pipe
	Less than a month	Pinch or tape the pipe
🏠	Regardless of the period	

- Great caution is needed when passing copper tubes through walls.
- Block all gaps in the holes for passing out piping and wiring using sealing material (field supply). (The capacity of the unit will drop and small animals may enter the machine.)

Example: passing piping out through the front

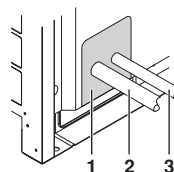

- 1 Plug the areas marked with " " (When the piping is routed from the front panel.)
- 2 Gas side piping
- 3 Liquid side piping



After all the piping has been connected, make sure there is no gas leak. Use nitrogen to perform a gas leak check.

## 6.6. Example of connection

Example of connection (Connection of 8 indoor units Heat pump system)		Branch with refnet joint		Branch with refnet joint and refnet header		Branch with refnet header																																		
<p><b>▲</b> Use the outdoor unit multi connection piping kit that is sold separately as an option (BHFQ22P1007+1517) for the multi installation of outdoor units. Selection method is as shown in the right table.</p> <p>• Do not use the outdoor unit multi connection piping kit (BHFQ22M909+1359) that are sold separately as an option of the M-type series and do not use T-joints.</p> <p>□ indoor unit   refnet joint   refnet header   outdoor multi connection piping kit</p> <p>Install the joint part (▲ part in the figure) of the outdoor unit multi connection piping kit horizontally with attention to the installation restrictions described in "connecting the refrigerant piping".            (*) If the system capacity is RXY(H)Q20 or more, re-read to the first outdoor branch as seen from the indoor unit.</p>	One outdoor unit installed (RXY)Q5-18 + RXYHQ12)	Outdoor units installed in a multiple outdoor unit system (RXY)Q20-54 + RXYHQ16-36)	<p>Pipe length between outdoor(*) and indoor units ≤165 m            [Example] unit 8: a+b+c+d+e+f+g+p≤165 m</p> <p>Equivalent pipe length between outdoor(*) and indoor units ≤190 m (Assume equivalent pipe length of refnet joint to be 1.0 m. (for calculation purposes))</p> <p>Total piping length from outdoor unit* to all indoor units ≤1000 m</p>	<p>Pipe length between outdoor(*) and indoor units ≤165 m            [Example] unit 8: a+b+c+d+e+f+g+p≤165 m</p> <p>Equivalent pipe length between outdoor(*) and indoor units ≤190 m (Assume equivalent pipe length of refnet joint to be 1.0 m. (for calculation purposes))</p>	<p>Pipe length between outdoor(*) and indoor units ≤165 m            [Example] unit 8: a+b+c+d+e+f+g+p≤165 m</p> <p>Equivalent pipe length between outdoor(*) and indoor units ≤190 m (Assume equivalent pipe length of refnet joint to be 1.0 m. (for calculation purposes))</p>	<p>Actual pipe length</p> <p>Between outdoor and indoor units</p>	<p>Actual pipe length</p> <p>Between outdoor and indoor units</p>																																	
	<p>Maximum allowable length</p> <p>Between outdoor branch and outdoor unit (Only for RXY(H)Q20 or more)</p> <p>Between outdoor and indoor units</p> <p>Between indoor and indoor units</p> <p>Between outdoor and outdoor units</p>	<p>Actual pipe length</p> <p>Difference in height</p> <p>Difference in height</p> <p>Difference in height</p>	<p>Actual pipe length</p> <p>Difference in height</p> <p>Difference in height</p> <p>Difference in height</p>	<p>Actual pipe length</p> <p>Difference in height</p> <p>Difference in height</p> <p>Difference in height</p>	<p>Actual pipe length</p> <p>Difference in height</p> <p>Difference in height</p> <p>Difference in height</p>	<p>Actual pipe length</p> <p>Difference in height</p> <p>Difference in height</p> <p>Difference in height</p>	<p>Actual pipe length</p> <p>Difference in height</p> <p>Difference in height</p> <p>Difference in height</p>																																	
<p>Allowable height</p> <p>Between outdoor and indoor units</p> <p>Between indoor and indoor units</p> <p>Between outdoor and outdoor units</p>	<p>Actual pipe length</p> <p>Difference in height</p> <p>Difference in height</p> <p>Difference in height</p>	<p>Actual pipe length</p> <p>Difference in height</p> <p>Difference in height</p> <p>Difference in height</p>	<p>Actual pipe length</p> <p>Difference in height</p> <p>Difference in height</p> <p>Difference in height</p>	<p>Actual pipe length</p> <p>Difference in height</p> <p>Difference in height</p> <p>Difference in height</p>	<p>Actual pipe length</p> <p>Difference in height</p> <p>Difference in height</p> <p>Difference in height</p>	<p>Actual pipe length</p> <p>Difference in height</p> <p>Difference in height</p> <p>Difference in height</p>																																		
<p>Allowable length after the branch</p> <p>Refrigerant branch kit selection</p> <p>Refrigerant branch kits can only be used with R410A.</p>	<p>Outdoor unit capacity type</p> <table border="1"> <thead> <tr> <th>Outdoor unit capacity type</th> <th>Refrigerant branch kit name</th> </tr> </thead> <tbody> <tr> <td>RX(Y)Q5</td> <td>KHRQ22M20T</td> </tr> <tr> <td>RX(Y)Q8+10</td> <td>KHRQ22M29T9</td> </tr> <tr> <td>RX(Y)Q12-18 + RXYQ20+22 + RXYHQ12 + RXYHQ16-22</td> <td>KHRQ22M64T</td> </tr> <tr> <td>RXYQ24-54 + RXYHQ24-36</td> <td>KHRQ22M75T</td> </tr> </tbody> </table> <p>• For refnet joints other than the first branch, select the proper branch kit model based on the total capacity index.</p>	Outdoor unit capacity type	Refrigerant branch kit name	RX(Y)Q5	KHRQ22M20T	RX(Y)Q8+10	KHRQ22M29T9	RX(Y)Q12-18 + RXYQ20+22 + RXYHQ12 + RXYHQ16-22	KHRQ22M64T	RXYQ24-54 + RXYHQ24-36	KHRQ22M75T	<p>Indoor capacity type</p> <table border="1"> <thead> <tr> <th>Indoor capacity type</th> <th>Refrigerant branch kit name</th> </tr> </thead> <tbody> <tr> <td>&lt;200</td> <td>KHRQ22M20T</td> </tr> <tr> <td>200×&lt;290</td> <td>KHRQ22M29T9</td> </tr> <tr> <td>290×&lt;640</td> <td>KHRQ22M64T</td> </tr> <tr> <td>≥640</td> <td>KHRQ22M75T</td> </tr> </tbody> </table> <p>(a) See note 2 on next page</p>	Indoor capacity type	Refrigerant branch kit name	<200	KHRQ22M20T	200×<290	KHRQ22M29T9	290×<640	KHRQ22M64T	≥640	KHRQ22M75T	<p>Indoor capacity type</p> <table border="1"> <thead> <tr> <th>Indoor capacity type</th> <th>Refrigerant branch kit name</th> </tr> </thead> <tbody> <tr> <td>&lt;290</td> <td>KHRQ22M29H (Max. 8 branch)</td> </tr> <tr> <td>290×&lt;640</td> <td>KHRQ22M64H (Max. 8 branch)(a)</td> </tr> <tr> <td>≥640</td> <td>KHRQ22M75H (Max. 8 branch)</td> </tr> </tbody> </table> <p>(a) See note 2 on next page</p>	Indoor capacity type	Refrigerant branch kit name	<290	KHRQ22M29H (Max. 8 branch)	290×<640	KHRQ22M64H (Max. 8 branch)(a)	≥640	KHRQ22M75H (Max. 8 branch)	<p>Number of outdoor units</p> <table border="1"> <thead> <tr> <th>Number of outdoor units</th> <th>Branch kit name</th> </tr> </thead> <tbody> <tr> <td>2</td> <td>BHFQ22P1007</td> </tr> <tr> <td>3</td> <td>BHFQ22P1517</td> </tr> </tbody> </table>	Number of outdoor units	Branch kit name	2	BHFQ22P1007	3	BHFQ22P1517	<p>How to select the refnet joint</p> <ul style="list-style-type: none"> <li>When using refnet joints at the first branch counted from the outdoor unit side. Choose from the following table in accordance with the capacity of the outdoor unit.</li> </ul> <p>How to select the refnet header</p> <ul style="list-style-type: none"> <li>Choose from the following table in accordance with the total capacity of all the indoor units connected below the refnet header.</li> <li>Note: 250 type cannot be connected below the refnet header.</li> </ul>	<p>How to choose an outdoor multi connection piping kit (needed if the outdoor unit capacity type is RXY(H)Q20 or more)</p> <ul style="list-style-type: none"> <li>Choose from the following table in accordance with the number of outdoor units.</li> </ul>
Outdoor unit capacity type	Refrigerant branch kit name																																							
RX(Y)Q5	KHRQ22M20T																																							
RX(Y)Q8+10	KHRQ22M29T9																																							
RX(Y)Q12-18 + RXYQ20+22 + RXYHQ12 + RXYHQ16-22	KHRQ22M64T																																							
RXYQ24-54 + RXYHQ24-36	KHRQ22M75T																																							
Indoor capacity type	Refrigerant branch kit name																																							
<200	KHRQ22M20T																																							
200×<290	KHRQ22M29T9																																							
290×<640	KHRQ22M64T																																							
≥640	KHRQ22M75T																																							
Indoor capacity type	Refrigerant branch kit name																																							
<290	KHRQ22M29H (Max. 8 branch)																																							
290×<640	KHRQ22M64H (Max. 8 branch)(a)																																							
≥640	KHRQ22M75H (Max. 8 branch)																																							
Number of outdoor units	Branch kit name																																							
2	BHFQ22P1007																																							
3	BHFQ22P1517																																							
<p>Example of downstream indoor units</p> <p>Example) in case of refnet joint C; indoor units 3+4+5+6+7+8</p>	<p>Example) in case of refnet joint B; indoor units 7+8, in case of refnet header; indoor units 1+2+3+4+5+6</p>	<p>Example) in case of refnet joint A; indoor units 7+8, in case of refnet header; indoor units 1+2+3+4+5+6+7+8</p>																																						

**Pipe size selection**

For an outdoor unit multi installation (RXYQ20-54P + RXYHQ16-36), select the pipe size in accordance with the following figure.

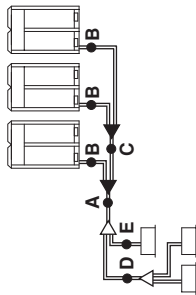

**A, B, C. Piping between outdoor unit and refrigerant branch kit**

• Choose from the following table in accordance with the total capacity of capacity type, connected downstream.

**Outdoor unit connection piping size**

Outdoor unit capacity type	Piping size (outer diameter) (mm)	
	Gas pipe	Liquid pipe
RX(Y)Q5	Ø15.9	
RX(Y)Q8	Ø19.1	Ø9.5
RX(Y)Q10	Ø22.2	
RX(Y)Q12-16 + RXYHQ12-16		Ø12.7
RX(Y)Q18 + RXYQ20+22 + RXYHQ18-22	Ø28.6	
RXY(H)Q24		Ø15.9
RXY(H)Q26-34	Ø34.9	
RXYQ36-54 + RXYHQ36	Ø41.3	Ø19.1

**D. Piping between refrigerant branch kits**

• Choose from the following table in accordance with the total capacity of all the indoor units connected below this.  
• Do not let the connection piping exceed the refrigerant piping size chosen by general system model name.

Indoor or outdoor unit total capacity	Piping size (outer diameter) (mm)	
	Gas pipe	Liquid pipe
<150	Ø15.9	
150≤x<200	Ø19.1	Ø9.5
200≤x<290	Ø22.2	
290≤x<420		Ø12.7
420≤x<640	Ø28.6	Ø15.9
640≤x<920	Ø34.9	
≥920	Ø41.3	Ø19.1

**E. Piping between refrigerant branch kit and indoor unit**

• Pipe size for direct connection to indoor unit must be the same as the connection size of indoor unit.

Indoor capacity type	Piping size (outer diameter) (mm)	
	Gas pipe	Liquid pipe
20-50	Ø12.7	Ø6.4
63-125	Ø15.9	
200	Ø19.1	Ø9.5
250	Ø22.2	

When the equivalent pipe length between outdoor and indoor units is 90 m or more, the size of the main pipes (both gas side and liquid side) must be increased. Depending on the length of the piping, the capacity may drop, but even in such a case it is possible to increase the size of the main pipes.

	Gas side	Liquid side
RX(Y)Q5	Ø15.9 → Ø19.1	Ø9.5 —
RX(Y)Q8	Ø19.1 → Ø22.2	Ø9.5 → Ø12.7
RX(Y)Q10	Ø22.2 → Ø25.4 <sup>(a)</sup>	Ø12.7 → Ø15.9
RX(Y)Q12+14 + RXYHQ12	Ø28.6 —	Ø15.9 → Ø19.1
RX(Y)Q16+18 + RXYQ20+22 + RXYHQ16-22	Ø28.6 → Ø31.8 <sup>(a)</sup>	Ø19.1 → Ø22.2
RXYQ24 + RXYHQ24	Ø34.9 —	
RXYQ26-34 + RXYHQ26-34	Ø34.9 → Ø38.1 <sup>(a)</sup>	
RXYQ36-54 + RXYHQ36	Ø41.3 —	

— Increase is not allowed

(a) If not available, increase is not allowed

	Gas pipe	Liquid pipe
RX(Y)Q5	Ø15.9	Ø9.5
RX(Y)Q8+10	Ø19.1	Ø9.5 → Ø12.7
RX(Y)Q12-16 + RXYHQ12-16	Ø22.2	Ø12.7 → Ø15.9
RX(Y)Q18 + RXYQ20-24 + RXYHQ18-24	Ø28.6	Ø15.9 → Ø19.1
RXYQ26-54 + RXYHQ26-36	Ø34.9	Ø19.1 → Ø22.2

— Increase is not allowed

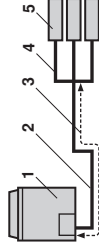

- 1 Outdoor unit
- 2 Main pipes
- 3 Increase
- 4 First refrigerant branch kit
- 5 Indoor unit

**How to calculate the additional refrigerant to be charged**

Additional refrigerant to be charged R (kg)  
R should be rounded off in units of 0.1 kg



The refrigerant charge of the system must be less than 100 kg. This means that in case the calculated refrigerant charge is equal to or more than 100 kg you must divide your multiple outdoor system into smaller independent systems, each containing less than 100 kg refrigerant charge.  
For factory charge, refer to the unit name plate.

$$R = [(X1 \times \mathbf{Ø22.2}) \times 0.37] + [(X2 \times \mathbf{Ø19.1}) \times 0.26] + [(X3 \times \mathbf{Ø15.9}) \times 0.18] + [(X4 \times \mathbf{Ø12.7}) \times 0.12] + [(X5 \times \mathbf{Ø9.5}) \times 0.059] + [(X6 \times \mathbf{Ø6.4}) \times 0.022] + \mathbf{A}$$

X<sub>1-6</sub> = Total length (m) of liquid piping size at Øa  
A = Weight according to table

	A	
<b>1x</b>	5-12	0 kg
	14-18	1 kg
<b>2x</b>	2 x (8-12)	0 kg
	(8-12) + (14-18)	1 kg
<b>3x</b>	3 x (8-12)	0 kg
	[2 x (8-12)] + (14-18)	1 kg
	(8-12) + [2 x (14-18)]	2 kg
	3 x (14-18)	3 kg



**Example for refrigerant branch using refnet joint and refnet header for RXYQ34P (1x 16) + (1x 18)**

If the outdoor unit is RXYQ34P and the piping lengths are as below

a: Ø19.1x30 m	d: Ø9.5x10 m	g: Ø6.4x10 m	j: Ø6.4x10 m
b: Ø15.9x10 m	e: Ø9.5x10 m	h: Ø6.4x20 m	k: Ø6.4x9 m
c: Ø9.5x10 m	f: Ø9.5x10 m	i: Ø12.7x10 m	

$$R = [30 \times 0.26] + [10 \times 0.18] + [10 \times 0.12] + [40 \times 0.059] + [49 \times 0.022] + 2 = 16.238$$

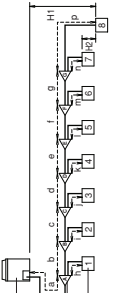
⇒ **R = 16.2 kg**

<p><b>Note 1</b></p> 	<p>Allowable length after the first refrigerant branch kit to indoor units is 40 m or less, however it can be extended up to 90 m if all the following conditions are fulfilled.</p>	<p><b>Example drawings</b></p> <p>Increase the pipe size as follows  <math>\varnothing 9.5 \rightarrow \varnothing 12.7</math>   <math>\varnothing 15.9 \rightarrow \varnothing 19.1</math>   <math>\varnothing 22.2 \rightarrow \varnothing 25.4^*</math>  <math>\varnothing 12.7 \rightarrow \varnothing 15.9</math>   <math>\varnothing 19.1 \rightarrow \varnothing 22.2</math>   <math>\varnothing 28.6 \rightarrow \varnothing 31.8^*</math>  <math>\varnothing 34.9 \rightarrow \varnothing 38.1^*</math></p> <p>* If available on the site. Otherwise it can not be increased.</p>	<p>1 Outdoor unit  2 Refnet joints (a~g)  3 Indoor units (1~8)</p> 
	<p><b>Required conditions</b></p> <p>It is necessary to increase the pipe size of the liquid and the gas pipe if the pipe length between the first and the final branch kit is over 40 m (reducers must be procured on site). If the increased pipe size is larger than the pipe size of the main pipe, then the pipe size of the main pipe needs to be increased as well.</p> <p>For calculation of total extension length, the actual length of above pipes must be doubled. (except main pipe and the pipes that not increase the pipe size)</p> <p>Indoor unit to the nearest branch kit <math>\leq 40</math> m</p> <p>The difference between the distance of the outdoor unit to the farthest indoor unit and the distance of the outdoor unit to the nearest indoor unit <math>\leq 40</math> m</p>	<p>Indoor unit 8:  <math>b-c+d+e+f+g+p \leq 90</math> m  increase the pipe size of b, c, d, e, f, g</p> <p><math>a+b^2+c^2+d^2+e^2+f^2+g^2+h^2+i^2+j^2+k^2+l^2+m^2+n^2+p^2 \leq 1000</math> m  h, i, j, ..... p <math>\leq 40</math> m</p> <p>The farthest indoor unit 8  The nearest indoor unit 1  <math>(a+b+c+d+e+f+g+p) - (a+h) \leq 40</math> m</p>	
<p><b>Note 2</b></p> 	<p>If the pipe size above the refnet header is <math>\varnothing 34.9</math> or more, KHRQ2M75H is required.</p>		

## 7. LEAK TEST AND VACUUM DRYING

The units were checked for leaks by the manufacturer.

After connecting the field piping, perform the following inspections.

### 1 Preparations

Referring to [figure 27](#), connect a nitrogen tank, a cooling tank, and a vacuum pump to the outdoor unit and perform the airtightness test and the vacuum drying. The stop valve and valves A and B in [figure 27](#) should be open and closed as shown in the table below when performing the airtightness test and vacuum drying.

- 1 Pressure reducing valve
- 2 Nitrogen
- 3 Measuring instrument
- 4 Tank (siphon system)
- 5 Vacuum pump
- 6 Charge hose
- 7 Service port for adding refrigerant
- 8 Liquid line stop valve
- 9 Gas line stop valve
- 10 Outdoor unit
- 11 To indoor unit
- 12 Stop valve service port
- 13 Dotted lines represent on site piping
- 14 Valve B
- 15 Valve C
- 16 Valve A

State of the valves A and B and the stop valve	Valve A	Valve B	Valve C	Liquid side stop valve	Gas side stop valve
Performing the airtightness test and vacuum drying (Valve A must always be shut. Otherwise the refrigerant in the unit will pour out.)	Close	Open	Open	Close	Close

### 2 Airtightness test and vacuum drying



NOTE Make sure to perform airtightness test and vacuum drying using the service ports of the stop valves of the liquid side and of the gas side. (For the service port location, refer to the "Caution" label attached on the front panel of the outdoor unit.)

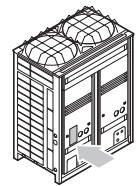

- See "11.3. Stop valve operation procedure" on page 19 for details on handling the stop valve.
- To prevent entry of any contamination and to prevent insufficient pressure resistance, always use the special tools dedicated for working with R410A refrigerant.

#### ■ Airtightness test:



NOTE Make sure to use nitrogen gas.

Pressurize the liquid and gas pipes to 4.0 MPa (40 bar) (do not pressurize more than 4.0 MPa (40 bar)). If the pressure does not drop within 24 hours, the system passes the test. If the pressure drops, check where the nitrogen leaks from.



- Vacuum drying: Use a vacuum pump which can evacuate to –100.7 kPa (5 Torr, –755 mm Hg)
- 1. Evacuate the system from the liquid and gas pipes by using a vacuum pump for more than 2 hours and bring the system to –100.7 kPa. After keeping the system under that condition for more than 1 hour, check if the vacuum gauge rises or not. If it rises, the system may either contain moisture inside or have leaks.
- 2. Following should be executed if there is a possibility of moisture remaining inside the pipe (if piping work is carried out during the raining season or over a long period of time, rainwater may enter the pipe during work).  
After evacuating the system for 2 hours, pressurize the system to 0.05 MPa (vacuum break) with nitrogen gas and evacuate the system again using the vacuum pump for 1 hour to –100.7 kPa (vacuum drying). If the system can not be evacuated to –100.7 kPa within 2 hours, repeat the operation of vacuum break and vacuum drying.  
Then, after leaving the system in vacuum for 1 hour, confirm that the vacuum gauge does not rise.

## 8. FIELD WIRING



All field wiring and components must be installed by a licensed electrician and must comply with relevant local and national regulations.

The field wiring must be carried out in accordance with the wiring diagrams and the instructions given below.

Be sure to use a dedicated power circuit. Never use a power supply shared by another appliance. This can lead to electric shock or fire.

Be sure to install an earth leakage circuit breaker.

(Because this unit uses an inverter, install an earth leakage circuit breaker that is capable of handling high harmonics in order to prevent malfunctioning of the earth leakage breaker itself.)

Do not operate until refrigerant piping work is completed.  
(If operated before completion of the piping work, the compressor may break down.)

Never remove a thermistor, sensor, etc., when connecting power wiring and transmission wiring.  
(If operated without thermistor, sensor, etc., the compressor may break down.)

The reversed phase protection detector of this product only functions when the product starts up. Consequently, reversed phase detection is not performed during normal operation of the product.

The reversed phase protection detector is designed to stop the product in the event of an abnormality when the product is started up.

Replace two of the three phases (L1, L2, and L3) during reverse-phase protection circuit operation.

If the possibility of reversed phase exists after a momentary blackout and the power goes on and off while the product is operating, attach a reversed phase protection circuit locally. Running the product in reversed phase can break the compressor and other parts.

Means for disconnection must be incorporated in the field wiring in accordance with the wiring rules.  
(An all-pole disconnection switch must be available on the unit.)

### 8.1. Internal wiring – Parts table

Refer to the wiring diagram sticker on the unit. The abbreviations used are listed below:

A1P~A7P	Printed circuit board
BS1~BS5	Push button switch (mode, set, return, test, reset)
C1,C63,C66	Capacitor
DS1,2	Dip switch
E1HC~E3HC	Crankcase heater
F1U	Fuse (650 V, 8 A, B) (A4P) (A8P)
F1U,2U	Fuse (250 V, 3.15 A, T) (A1P)
F5U	Field fuse
F400U	Fuse (250 V, 6.3 A, T) (A2P)
H1P~8P	Pilot lamp (service monitor - orange)
	H2P: Under preparation or in test operation when blinking
	H2P: Malfunction detection when light up
HAP	Pilot lamp (service monitor - green)
K1	Magnetic relay
K2	Magnetic contactor (MIC)
K2M,3M	* Magnetic contactor (M2C,M3C)
K1R,2R	Magnetic relay (K2M,K3M)
K3R~5R	Magnetic relay (Y1S~Y3S)
K6R~9R	Magnetic relay (E1HC~E3HC)
L1R	Reactor
M1C~3C	Motor (compressor)
M1F,2F	Motor (fan)
PS	Switching power supply (A1P,A3P)
Q1DI	Earth leakage breaker (field supply)
Q1RP	Phase reversal detection circuit
R1T	Thermistor (fin) (A2P)
R1T	Thermistor (air) (A1P)
R2T	Thermistor (suction)
R4T	Thermistor (coil-deicer)
R5T	Thermistor (coil-outlet)
R6T	Thermistor (liquid-pipe receiver)
R7T	Thermistor (accumulator)
R10	Resistor (current sensor) (A4P) (A8P)
R31T~33T	Thermistor (discharge) (M1C~M3C)
R50,59	Resistor
R95	Resistor (current limiting)
S1NPH	Pressure sensor (high)
S1NPL	Pressure sensor (low)
S1PH,3PH	Pressure switch (high)
T1A	Current sensor (A6P,A7P)
SD1	Safety devices input
V1R	Power module (A4P,A8P)
V1R,V2R	Power module (A3P)
X1A,X4A	Connector (M1F,M2F)
X1M	Terminal strip (power supply)
X1M	Terminal strip (control) (A1P)
X1M	Terminal strip (A5P)
Y1E,2E	Expansion valve (electronic type) (main, subcool)
Y1S	Solenoid valve (hotgas bypass)
Y2S	Solenoid valve (oil return)
Y3S	Solenoid valve (4 way valve)
Y4S	Solenoid valve (injection)
Z1C-7C	Noise filter (ferrite core)
Z1F	Noise filter (with surge absorber)

L1,L2,L3	..... Live
N	..... Neutral
■ ■ ■ ■	..... Field wiring
□ □ □ □	..... Terminal strip
□ □	..... Connector
○	..... Terminal
⊕	..... Protective earth (screw)
BLK	..... Black
BLU	..... Blue
BRN	..... Brown
GRN	..... Green
GRY	..... Grey
ORG	..... Orange
PNK	..... Pink
RED	..... Red
WHT	..... White
YLW	..... Yellow

- NOTE**
- (1) This wiring diagram only applies to the outdoor unit.
  - (4) When using the option adaptor, refer to the installation manual.
  - (5) Refer to the installation manual, for connection wiring to indoor-outdoor transmission F1-F2, outdoor-multi transmission Q1-Q2 and on how to use BS1~BS5 and DS1, DS2 switch.
  - (6) Do not operate the unit by short-circuiting protection device S1PH.

## 8.2. Optional parts cool/heat selector

S1S	..... Selector switch (fan, cool/heat)
S2S	..... Selector switch (cool/heat)

- NOTE**
- Use copper conductors only.
  - For connection wiring to the central remote controller, refer to the installation manual of the central remote controller.
  - Use insulated wire for the power cord.

\* = Only for unit of class 10~18 hp

## 8.3. Power circuit and cable requirements

A power circuit (see table below) must be provided for connection of the unit. This circuit must be protected with the required safety devices, i.e. a main switch, a slow blow fuse on each phase and an earth leakage breaker.

	Phase and frequency	Voltage	Minimum circuit ampere	Recommended fuses	Transmission line section
RX(Y)Q5	3 N~50 Hz	400 V	11.9 A	16 A	0.75~1.25 mm <sup>2</sup>
RX(Y)Q8	3 N~50 Hz	400 V	18.5 A	25 A	0.75~1.25 mm <sup>2</sup>
RX(Y)Q10	3 N~50 Hz	400 V	21.6 A	25 A	0.75~1.25 mm <sup>2</sup>
RX(Y)Q12	3 N~50 Hz	400 V	22.7 A	25 A	0.75~1.25 mm <sup>2</sup>
RX(Y)Q14	3 N~50 Hz	400 V	31.5 A	40 A	0.75~1.25 mm <sup>2</sup>
RX(Y)Q16	3 N~50 Hz	400 V	31.5 A	40 A	0.75~1.25 mm <sup>2</sup>
RX(Y)Q18	3 N~50 Hz	400 V	32.5 A	40 A	0.75~1.25 mm <sup>2</sup>
RXYQ20	3 N~50 Hz	400 V	41.2 A	50 A	0.75~1.25 mm <sup>2</sup>
RXYQ22	3 N~50 Hz	400 V	44.3 A	50 A	0.75~1.25 mm <sup>2</sup>
RXYQ24	3 N~50 Hz	400 V	50.4 A	50 A	0.75~1.25 mm <sup>2</sup>
RXYQ26	3 N~50 Hz	400 V	51.0 A	63 A	0.75~1.25 mm <sup>2</sup>
RXYQ28	3 N~50 Hz	400 V	54.1 A	63 A	0.75~1.25 mm <sup>2</sup>
RXYQ30	3 N~50 Hz	400 V	55.2 A	63 A	0.75~1.25 mm <sup>2</sup>
RXYQ32	3 N~50 Hz	400 V	63.0 A	80 A	0.75~1.25 mm <sup>2</sup>
RXYQ34	3 N~50 Hz	400 V	64.0 A	80 A	0.75~1.25 mm <sup>2</sup>
RXYQ36	3 N~50 Hz	400 V	65.0 A	80 A	0.75~1.25 mm <sup>2</sup>
RXYQ38	3 N~50 Hz	400 V	73.7 A	100 A	0.75~1.25 mm <sup>2</sup>
RXYQ40	3 N~50 Hz	400 V	81.5 A	100 A	0.75~1.25 mm <sup>2</sup>
RXYQ42	3 N~50 Hz	400 V	82.5 A	100 A	0.75~1.25 mm <sup>2</sup>
RXYQ44	3 N~50 Hz	400 V	83.5 A	100 A	0.75~1.25 mm <sup>2</sup>
RXYQ46	3 N~50 Hz	400 V	86.6 A	100 A	0.75~1.25 mm <sup>2</sup>
RXYQ48	3 N~50 Hz	400 V	87.7 A	100 A	0.75~1.25 mm <sup>2</sup>
RXYQ50	3 N~50 Hz	400 V	96.5 A	125 A	0.75~1.25 mm <sup>2</sup>
RXYQ52	3 N~50 Hz	400 V	96.5 A	125 A	0.75~1.25 mm <sup>2</sup>
RXYQ54	3 N~50 Hz	400 V	97.5 A	125 A	0.75~1.25 mm <sup>2</sup>

	Phase and frequency	Voltage	Minimum circuit ampere	Recommended fuses	Transmission line section
RXYHQ12	3 N~50 Hz	400 V	22.5 A	25 A	0.75~1.25 mm <sup>2</sup>
RXYHQ16	3 N~50 Hz	400 V	37.0 A	50 A	0.75~1.25 mm <sup>2</sup>
RXYHQ18	3 N~50 Hz	400 V	40.1 A	50 A	0.75~1.25 mm <sup>2</sup>
RXYHQ20	3 N~50 Hz	400 V	41.2 A	50 A	0.75~1.25 mm <sup>2</sup>
RXYHQ22	3 N~50 Hz	400 V	44.3 A	50 A	0.75~1.25 mm <sup>2</sup>
RXYHQ24	3 N~50 Hz	400 V	55.5 A	63 A	0.75~1.25 mm <sup>2</sup>
RXYHQ26	3 N~50 Hz	400 V	58.6 A	80 A	0.75~1.25 mm <sup>2</sup>
RXYHQ28	3 N~50 Hz	400 V	61.7 A	80 A	0.75~1.25 mm <sup>2</sup>
RXYHQ30	3 N~50 Hz	400 V	62.8 A	80 A	0.75~1.25 mm <sup>2</sup>
RXYHQ32	3 N~50 Hz	400 V	63.9 A	80 A	0.75~1.25 mm <sup>2</sup>
RXYHQ34	3 N~50 Hz	400 V	67.0 A	80 A	0.75~1.25 mm <sup>2</sup>
RXYHQ36	3 N~50 Hz	400 V	68.1 A	80 A	0.75~1.25 mm <sup>2</sup>

**NOTE**



The above table indicates power specifications for standard combinations. See "1. Introduction" on page 1.

If using anything other than the above combinations in a multiple outdoor unit system, calculate using the following procedure.

### Calculate the recommended fuse capacity

Calculate, by adding the minimum circuit ampere of each used unit (according to the table above), multiply the result by 1.1 and select the next higher recommended fuse capacity.

#### Example

Combining the RXYQ30 by using the RXYQ8, RXYQ10, and RXYQ12.

Minimum circuit ampere of the RXYQ8 = 18.5 A

Minimum circuit ampere of the RXYQ10 = 21.6 A

Minimum circuit ampere of the RXYQ12 = 22.7 A

Accordingly, the minimum circuit ampere of the RXYQ30=18.5+21.6+22.7= 62.8 A

Multiplying the above result by 1.1 (62.8 x 1.1)=69.08 A, so the recommended fuse capacity would be 80 A.

When using residual current operated circuit breakers, be sure to use a high-speed type 300 mA rated residual operating current.

**Point for attention regarding quality of the public electric power supply**

This equipment complies with respectively:

- EN/IEC 61000-3-11<sup>(1)</sup> provided that the system impedance  $Z_{sys}$  is less than or equal to  $Z_{max}$  and
- EN/IEC 61000-3-12<sup>(2)</sup> provided that the short-circuit power  $S_{sc}$  is greater than or equal to the minimum  $S_{sc}$  value

at the interface point between the user's supply and the public system. It is the responsibility of the installer or user of the equipment to ensure, by consultation with the distribution network operator if necessary, that the equipment is connected only to a supply with respectively:

- $Z_{sys}$  less than or equal to  $Z_{max}$  and
- $S_{sc}$  greater than or equal to the minimum  $S_{sc}$  value.

	$Z_{max}$ (Ω)	Minimum $S_{sc}$ value
RX(Y)Q5	—	—
RX(Y)Q8	—	1218 kVA
RX(Y)Q10	0.27	928 kVA
RX(Y)Q12	0.27	944 kVA
RX(Y)Q14	0.24	1114 kVA
RX(Y)Q16	0.24	1114 kVA
RX(Y)Q18	0.24	1171 kVA
RXYQ20 = RXYQ8 + RXYQ12	0.27	2162 kVA
RXYQ22 = RXYQ10 + RXYQ12	0.25	1872 kVA
RXYQ24 = RXYQ12 + RXYQ12	0.25	1888 kVA
RXYQ26 = RXYQ8 + RXYQ18	0.24	2389 kVA
RXYQ28 = RXYQ10 + RXYQ18	0.23	2099 kVA
RXYQ30 = RXYQ12 + RXYQ18	0.23	2115 kVA
RXYQ32 = RXYQ14 + RXYQ18	0.22	2284 kVA
RXYQ34 = RXYQ16 + RXYQ18	0.22	2284 kVA
RXYQ36 = RXYQ18 + RXYQ18	0.22	2342 kVA
RXYQ38 = RXYQ8 + RXYQ12 + RXYQ18	0.23	3333 kVA
RXYQ40 = RXYQ10 + RXYQ12 + RXYQ18	0.22	3043 kVA
RXYQ42 = RXYQ12 + RXYQ12 + RXYQ18	0.22	3059 kVA
RXYQ44 = RXYQ8 + RXYQ18 + RXYQ18	0.22	3560 kVA
RXYQ46 = RXYQ10 + RXYQ18 + RXYQ18	0.22	3270 kVA
RXYQ48 = RXYQ12 + RXYQ18 + RXYQ18	0.22	3286 kVA
RXYQ50 = RXYQ14 + RXYQ18 + RXYQ18	0.22	3455 kVA
RXYQ52 = RXYQ16 + RXYQ18 + RXYQ18	0.22	3455 kVA
RXYQ54 = RXYQ18 + RXYQ18 + RXYQ18	0.22	3513 kVA

	$Z_{max}$ (Ω)	Minimum $S_{sc}$ value
RXYHQ12	0.27	1114 kVA
RXYHQ16 = RXYQ8 + RXYQ8	—	2436 kVA
RXYHQ18 = RXYQ8 + RXYQ10	0.27	2146 kVA
RXYHQ20 = RXYQ8 + RXYHQ12	0.27	2332 kVA
RXYHQ22 = RXYQ10 + RXYHQ12	0.25	2042 kVA
RXYHQ24 = RXYQ8 + RXYQ8 + RXYQ8	—	3654 kVA
RXYHQ26 = RXYQ8 + RXYQ8 + RXYQ10	0.27	3364 kVA
RXYHQ28 = RXYQ8 + RXYQ10 + RXYQ10	0.25	3074 kVA
RXYHQ30 = RXYQ8 + RXYQ10 + RXYHQ12	0.25	3260 kVA
RXYHQ32 = RXYQ8 + RXYHQ12 + RXYHQ12	0.25	3446 kVA
RXYHQ34 = RXYQ10 + RXYHQ12 + RXYHQ12	0.24	3156 kVA
RXYHQ36 = RXYHQ12 + RXYHQ12 + RXYHQ12	0.24	3342 kVA

(1) European/International Technical Standard setting the limits for voltage changes, voltage fluctuations and flicker in public low-voltage supply systems for equipment with rated current  $\leq 75$  A.  
(2) European/International Technical Standard setting the limits for harmonic currents produced by equipment connected to public low-voltage systems with input current  $> 16$  A and  $\leq 75$  A per phase.

Be sure to install a main switch for the complete system.

**NOTE**



- Select the power supply cable in accordance with relevant local and national regulations.
- Wire size must comply with the applicable local and national code.
- Specifications for local wiring power cord and branch wiring are in compliance with IEC60245.
- WIRE TYPE H05VV(\*)  
\*Only in protected pipes (use H07RN-F when protected pipes are not used).

**8.4. General cautions** ⚠

- Up to 3 units can be connected by crossover power source wiring between outdoor units. However, units of smaller capacity must be connected downstream. For details, refer to the technical data.
- When connecting several units in VRV combination, the power supply of each outdoor unit can also be connected separately. Refer to the field wiring on the engineering data book for further details.
- Make sure to connect the power source wire to the power source terminal block and to clamp it as shown in figure 21 and described in chapter "8.8. Field line connection: power wiring" on page 17.
- For conditional connections, refer to the Technical Data.
- As this unit is equipped with an inverter, installing a phase advancing capacitor not only will deteriorate power factor improvement effect, but also may cause capacitor abnormal heating accident due to high-frequency waves. Therefore, never install a phase advancing capacitor.
- Keep power imbalance within 2% of the supply rating.
  - Large imbalance will shorten the life of the smoothing capacitor.
  - As a protective measure, the product will stop operating and an error indication will be made, when power imbalance exceeds 4% of the supply rating.
- Follow the "electrical wiring diagram" supplied with the unit when carrying out any electrical wiring.
- Only proceed with wiring work after all power is shut off.
- Always ground wires. (In accordance with national regulations of the pertinent country.)
- Do not connect the ground wire to gas pipes, sewage pipes, lightning rods, or telephone ground wires. This may cause electric shock.
  - Combustion gas pipes: can explode or catch fire if there is a gas leak.
  - Sewage pipes: no grounding effect is possible if hard plastic piping is used.
  - Telephone ground wires and lightning rods: dangerous when struck by lightning due to abnormal rise in electrical potential in the grounding.
- This unit uses an inverter, and therefore generates noise, which will have to be reduced to avoid interfering with other devices. The outer casing of the product may take on an electrical charge due to leaked electrical current, which will have to be discharged with the grounding.
- Be sure to install an earth leakage breaker. (One that can handle high-frequency electrical noise.) (This unit uses an inverter, which means that an earth leakage breaker capable of handling high-frequency electrical noise must be used in order to prevent malfunctioning of the earth leakage breaker itself.)
- Earth leakage breakers that are especially designed for protecting ground-faults must be used in conjunction with main switch and fuse for use with wiring.
- Never connect the power supply in reversed phase. The unit can not operate normally in reversed phase. If you connect in reversed phase, replace two of the three phases.

- This unit has a reverse phase detection circuit. (If it is activated, only operate the unit after correcting the wiring.)
- Power supply wires must be attached securely.
- If the power supply has a missing or wrong N-phase, equipment will break down.
- Make sure that all wiring is secure, the specified wires are used, and no external forces act on the terminal connection or wires.
- Improper connections or installation may result in fire.
- When wiring the power supply and connecting the remote controller wiring and transmission wiring, position the wires so that the control box lid can be securely fastened. Improper positioning of the control box lid may result in electric shocks, fire, or overheating of the terminals.

## 8.5. System examples

(See figure 15)

- 1 Field power supply
  - 2 Main switch
  - 3 Earth leakage breaker
  - 4 Outdoor unit
  - 5 Indoor unit
  - 6 Remote controller
- Power supply wiring (sheathed cable) (230 V)
- Transmission wiring (sheathed cable) (16 V)

## 8.6. Leading power line and transmission line

- Be sure to let the power line and the transmission line pass through a conduit hole.
  - Lead the power line from the upper hole on the left side plate, from the front position of the main unit (through the conduit hole of the wiring mounting plate) or from a knock out hole to be made in the unit's bottom plate. (See figure 18)
- 1 Electric wiring diagram. Printed on the back of the electric box lid.
  - 2 Power wiring and ground wiring between outdoor units (inside conduit)  
(When the wiring is routed out through the lateral panel.)
  - 3 Transmission wiring
  - 4 Pipe opening
  - 5 Conduit
  - 6 Power wiring and ground wiring
  - 7 Cut off the shaded zones before use.
  - 8 Through cover

## Precautions when knocking out knockout holes

- To punch a knockout hole, hit on it with a hammer.
- After knocking out the holes, we recommend you paint the edges and areas around the edges using the repair paint to prevent rusting.
- When passing electrical wiring through the knockout holes, remove any burrs from the knockout hole edges. Wrap the wiring with protective tape in order to prevent damage to the wires, put the wires through field supplied protective wire conduits at that location, or install suitable field supplied wire nipples or rubber bushings into the knockout holes.

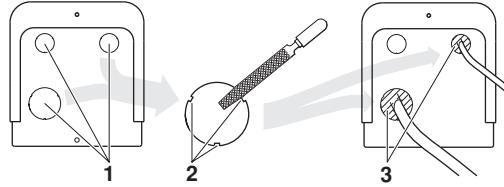

- 1 Knockout hole
- 2 Burr
- 3 If there are any possibilities that small animals enter the system through the knockout holes, plug the holes with packing materials (to be prepared on-site).



- Use a power wire pipe for the power wiring.
- Outside the unit, make sure the weak low voltage electric wiring (i.e. for the remote control, between units, etc.) and the high voltage electric wiring do not pass near each other, keeping them at least 50 mm apart. Proximity may cause electrical interference, malfunctions, and breakage.
- Be sure to connect the power wiring to the power wiring terminal block and secure it as described under "8.8. Field line connection: power wiring" on page 17.
- Inter-unit wiring should be secured as described in "8.7. Field line connection: transmission wiring and cool/heat selection" on page 16.
  - Secure the wiring with the accessory clamps so that it does not touch the piping and no external force can be applied to the terminal.
  - Make sure the wiring and the electric box lid do not stick up above the structure, and close the cover firmly.

## 8.7. Field line connection: transmission wiring and cool/heat selection

### In case of RX(Y)Q5~18 + RXYHQ12 (See figure 19)

- 1 Cool/heat selector (not required for cooling only units)
- 2 Outdoor unit PC board (A1P)
- 3 Take care of the polarity (not required for cooling only units)
- 4 Use the conductor of sheathed wire (2 wire) (no polarity)
- 5 Terminal board (field supply)
- 6 Indoor unit
- 7 Outdoor unit

### In case of RXYQ20~54 + RXYHQ16~36 (See figure 20)

- 1 Unit A (Master unit)
- 2 Unit B (Slave unit)
- 3 Unit C (Slave unit)
- 4 To slave unit(s)
- 5 To indoor unit
- 6 To outdoor unit
- 7 To cool/heat selector

**NOTE**  RXYQ5 can not install the multi unit transmission wiring. Run will not be successful if the wiring is connected to Q1-Q2 (TO MULTI UNIT) terminal.

- The interconnecting wiring between the outdoor units in the same piping system must be connected to the Q1/Q2 (Out Multi) terminals. Connecting the wires to the F1/F2 (Out-Out) terminals results in system malfunction.
- The wiring for the other systems must be connected to the F1/F2 (Out-Out) terminals of the P-board in the outdoor unit to which the interconnecting wiring for the indoor units is connected.
- The base unit is the outdoor unit to which the interconnecting wiring for the indoor units is connected.

### Fixing transmission wiring (See figure 23)

#### Inside switchbox

- 1 Heating/cooling switching remote control cord (when a heating/cooling switch remote control (optional) is connected) (ABC) (not for RXQ5~18)
- 2 Fix to the indicated plastic brackets using field supplied clamping material.
- 3 Wiring between the units (Outdoor - outdoor) (F1+F2 right)
- 4 Wiring between the units (Indoor - outdoor) (F1+F2 left)
- 5 Wiring for multi connection (only for RXYQ20~54 + RXYHQ16~36) (Q1+Q2)
- 6 Plastic bracket

#### Outside unit



- Be sure to follow the limits below. If the unit-to-unit cables are beyond these limits, it may result in malfunction of transmission.
  - Maximum wiring length: 1000 m
  - Total wiring length: 2000 m
  - Maximum interunit wiring length between outdoor units: 30 m
  - Transmission wiring to cool/heat selector: 500 m
  - Maximum number of branches: 16

- Maximum number of independent interconnectable systems (TO OUT/D UNIT F1-F2): 10.

- Up to 16 branches are possible for unit-to unit cabling. No branching is allowed after branching. (See figure 16)

- 1 Outdoor unit
- 2 Indoor unit
- 3 Main line
- 4 Branch line 1
- 5 Branch line 2
- 6 Branch line 3
- 7 No branch is allowed after branch
- 8 Central remote controller (etc...)
- A Transmission wiring between outdoor unit and indoor unit(s)
- B Transmission wiring between outdoor units

- Never connect the power supply to transmission wiring terminal block. Otherwise the entire system may break down.
- Never connect 400 V to the terminal block of the interconnecting wiring. Doing so will break the entire system.
  - The wiring from the indoor units must be connected to the F1/F2 (In-Out) terminals on the PC board in the outdoor unit.
  - After installing the interconnecting wires inside the unit, wrap them along with the on-site refrigerant pipes using finishing tape, as shown in figure 12.

- 1 Liquid pipe
- 2 Gas pipe
- 3 Insulator
- 4 Interconnecting wiring
- 5 Finishing tape

For the above wiring, always use vinyl cords with 0.75 to 1.25 mm<sup>2</sup> sheath or cables (2-core wires). (3-core wire cables are allowable for the cooler/heater changeover remote controller only.)



- Be sure to keep the power line and transmission line apart from each other.
- Be careful about polarity of the transmission line.
- Make sure that the transmission line is clamped as shown in figure 23.
- Check that wiring lines do not make contact with refrigerant piping.
- Firmly close the lid and arrange the electrical wires so as to prevent the lid or other parts from coming loose.
- When you do not use a wire conduit, be sure to protect the wires with vinyl tubes etc, to prevent the edge of the knock-out hole from cutting the wires.

## Sequential start

The outdoor unit PC board (A1P) is factory set at "Sequential start available".

## Setting the cool/heat operation (heat pump unit only)

- 1 Performing cool/heat setting with the remote controller connected to the indoor unit.

Keep the cool/heat selector switch (DS1) on the outdoor unit PC board at the factory setting position IN/D UNIT. (See figure 22)

- 1 Remote controller

- 2 Performing cool/heat setting with the cool/heat selector.

Connect the cool/heat selector remote controller (optional) to the A/B/C terminals and set the cool/heat selector switch (DS1) on the outdoor unit PC board (A1P) to OUT/D UNIT. (See figure 25)

- 1 Cool/heat selector



For low-noise operation, it is necessary to get the optional 'External control adaptor for outdoor unit' (DTA104A61/62).

For details, see the installation manual attached to the adaptor.

## 8.8. Field line connection: power wiring

The power cord must be clamped to the plastic bracket using field supplied clamp material.

The green and yellow striped wrapped wires must be used for grounding. (See figure 21)

- 1 Power supply (400 V, 3 N~50 Hz)
- 2 Fuse
- 3 Earth leakage breaker
- 4 Grounding wire
- 5 Power supply terminal block
- 6 Connect each power wire  
RED to L1, WHT to L2, BLK to L3 and BLU to N
- 7 Ground wire (GRN/YLW)
- 8 Clamp the power wire to the plastic bracket using a field supplied clamp to prevent external force being applied to the terminal.
- 9 Clamp (field supply)
- 10 Cup washer
- 11 When connecting the earth wire, it is recommended to perform curling.



- When routing ground wires, secure clearance of 50 mm or more away from compressor lead wires. Failure to observe this instruction properly may adversely effect correct operation of other units connected to the same ground.
- When connecting the power supply cord, the earth connection must be made before the current-carrying connections are established. When disconnecting the power supply cord, the current-carrying connections must be separated before the earth connection is. Length of the conductors between the power supply cord anchorage and the terminal block itself must be such that the current-carrying conductors are tautened before the earthing conductor is in case the power supply cord is pulled loose from the cord anchorage.



## Precautions when laying power wiring

- Do not connect wiring of different thicknesses to the power terminal block. (Slack in the power wiring may cause abnormal heat.)
- When connecting wiring which is the same thickness, do as shown in the figure below.

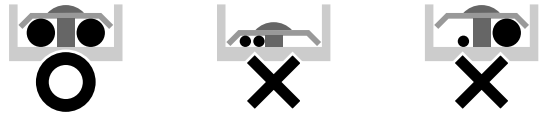

- For wiring, use the designated power wire and connect firmly, then secure to prevent outside pressure being exerted on the terminal board.
- Use an appropriate screwdriver for tightening the terminal screws. A screwdriver with a small head will strip the head and make proper tightening impossible.
- Over-tightening the terminal screws may break them.
- See the table below for tightening torque for the terminal screws.

Tightening torque (N·m)	
M8 (Power terminal block)	5.5~7.3
M8 (Ground)	
M3 (Inter-unit wiring terminal block)	0.8~0.97



## Recommendations when connecting the ground

When pulling the ground wire out, wire it so that it comes through the cut out section of the cup washer. (An improper ground connection may prevent a good ground from being achieved.) (See figure 21)

## 8.9. Wiring example for wiring inside unit

See figure 26.

- 1 Electric wiring
- 2 Wiring between units
- 3 Clamp to the electric box with field supplied clamps.
- 4 When routing out the power/ground wires from the right side:
- 5 When routing the remote control cord and inter-unit wiring, secure clearance of 50 mm or more from the power wiring. Ensure that the power wiring does not contact any heated sections (  ).
- 6 Clamp to the back of the column support with field supplied clamps.
- 7 When routing out the inter-unit wirings from the opening for piping:
- 8 When routing out the power/ground wires from the front:
- 9 When routing out the ground wires from the left side:
- 10 Grounding wire
- 11 When wiring, pay attention not to detach the acoustic insulators from the compressor.
- 12 Power supply
- 13 Fuse
- 14 Earth leakage breaker
- 15 Ground wire
- 16 Unit A
- 17 Unit B
- 18 Unit C

## 9. PIPE INSULATION

After finishing the leak test and vacuum drying, the piping must be insulated. Take into account the following points:

- Make sure to insulate the connection piping and refrigerant branch kits entirely.
- Be sure to insulate liquid and gas piping (for all units).
- Use heat resistant polyethylene foam which can withstand a temperature of 70°C for liquid side piping and polyethylene foam which can withstand a temperature of 120°C for gas side piping.
- Reinforce the insulation on the refrigerant piping according to the installation environment.

Ambient temperature	Humidity	Minimum thickness
≤30°C	75% to 80% RH	15 mm
>30°C	≥80 RH	20 mm

Condensation might form on the surface of the insulation.

- If there is a possibility that condensation on the stop valve might drip down into the indoor unit through gaps in the insulation and piping because the outdoor unit is located higher than the indoor unit this must be prevented by sealing up the connections. See figure 9.

- 1 Gas line stop valve
- 2 Liquid line stop valve
- 3 Service port for adding refrigerant
- 4 Sealing up treatment
- 5 Insulation
- 6 Indoor -outdoor interconnection piping

- For cooling only units, insulation which can withstand 70°C is also sufficient for gas side piping.



Be sure to insulate local pipes, as touching them can cause burns.

## 10. CHECKING OF UNIT AND INSTALLATION CONDITIONS

Be sure to check the following:

### The piping work

- 1 Make sure piping size is correct.  
See "6.2. Selection of piping material" on page 5.
- 2 Make sure insulation work is done.  
See "9. Pipe insulation" on page 18.
- 3 Make sure there is no faulty refrigerant piping.  
See "6. Refrigerant piping" on page 5.

### The electrical work

- 1 Make sure there is no faulty power wiring or loose nuts.  
See "8. Field wiring" on page 12.
- 2 Make sure there is no faulty transmission wiring or loose nuts.  
See "8. Field wiring" on page 12.
- 3 Make sure the insulation resistance of the main power circuit is not deteriorated.

Using a megatester for 500 V, check that the insulation resistance of 2 MΩ or more is attained by applying a voltage of 500 V DC between the power terminals and earth. Never use the megatester for the transmission wiring (between outdoor and indoor unit, outdoor and COOL/HEAT selector, etc.).

## 11. CHARGING REFRIGERANT

The outdoor unit is factory charged, but depending on the length of the piping when installed, the outdoor unit may require additional charging.

For charging the additional refrigerant follow the procedure as described in this chapter.



Refrigerant can not be charged until all field wiring and field piping has been completed.

Refrigerant may only be charged after performing the leak test and the vacuum drying.



The refrigerant charge of the system must be less than 100 kg. This means that in case the calculated refrigerant charge is equal to or more than 95 kg you must divide your multiple outdoor system into smaller independent systems, each containing less than 95 kg refrigerant charge.

For factory charge, refer to the unit name plate.

### 11.1. Important information regarding the refrigerant used

This product contains fluorinated greenhouse gases covered by the Kyoto Protocol. Do not vent gases into the atmosphere.

Refrigerant type: R410A

GWP<sup>(1)</sup> value: 1975

<sup>(1)</sup> GWP = global warming potential

Please fill in with indelible ink,

- ① the factory refrigerant charge of the product,
- ② the additional refrigerant amount charged in the field and
- ①+② the total refrigerant charge

on the fluorinated greenhouse gases label supplied with the product.

The filled out label must be adhered on the inside of the product and in the proximity of the product charging port (e.g. on the inside of the service cover).

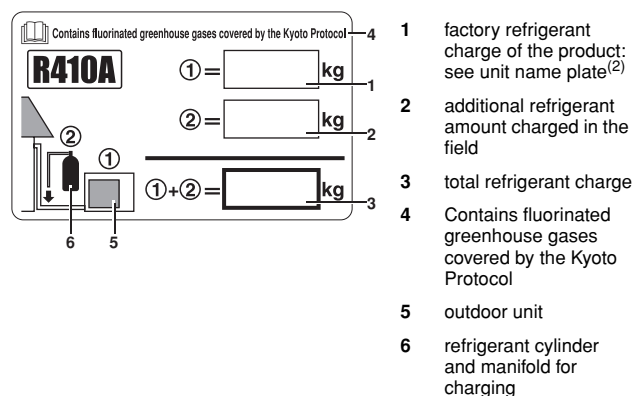

<sup>(2)</sup> In case of multiple outdoor systems, only 1 label must be adhered, mentioning the total factory refrigerant charge of all outdoor units connected on the refrigerant system.

#### NOTE



National implementation of EU regulation on certain fluorinated greenhouse gases may require to provide the appropriate official national language on the unit. Therefore, an additional multilingual fluorinated greenhouse gases label is supplied with the unit.

Sticking instructions are illustrated on the backside of that label.

## 11.2. Precautions when adding R410A

Be sure to charge the specified amount of refrigerant in liquid state to the liquid pipe.

Since this refrigerant is a mixed refrigerant, adding it in gas form may cause the refrigerant composition to change, preventing normal operation.

- Before charging, check whether the refrigerant cylinder is equipped with a siphon tube or not.

Charge the liquid refrigerant with the cylinder in upright position.

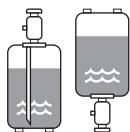

Charge the liquid refrigerant with the cylinder in up-side-down position.

- Be sure to use tools exclusively for R410A to ensure required pressure resistance and to prevent foreign materials from mixing into the system.



Charging with an unsuitable substance may cause explosions and accidents, so always make sure that the appropriate refrigerant (R410A) is charged.

Refrigerant containers must be opened slowly.

## 11.3. Stop valve operation procedure



- Do not open the stop valve until all piping and electrical steps of "10. Checking of unit and installation conditions" on page 18 are completed. If the stop valve is left open without turning on the power, it may cause refrigerant to build up in the compressor, leading to insulation degradation.

- Always use a charge hose for service port connection.
- After tightening the cap, check that no refrigerant leaks are present.

### Size of stop valve

The sizes of the stop valves connected to the system are as listed in the table below.

Type	5	8	10	12	14	16	18
Liquid line stop valve	Ø9.5 <sup>(a)</sup>			Ø12.7 <sup>(b)</sup>			
Gas line stop valve	Ø15.9	Ø19.1	Ø25.4 <sup>(c)</sup>				

(a) The model RX(Y)Q12 + RXYHQ12 supports field piping of Ø12.7 on the accessory pipe supplied with the unit.

(b) The model RX(Y)Q18 supports field piping of Ø15.9 on the accessory pipe supplied with the unit.

(c) The model RX(Y)Q10 supports field piping of Ø22.2 on the accessory pipe supplied with the unit.  
The model RX(Y)Q12~18 + RXYHQ12 supports field piping of Ø28.6 on the accessory pipe supplied with the unit.

### Opening stop valve (See figure 14)

- Service port
- Cap
- Hexagon hole
- Shaft
- Seal

- Remove the cap and turn the valve counterclockwise with the hexagon wrench.
- Turn it until the shaft stops.



Do not apply excessive force to the stop valve. Doing so may break the valve body, as the valve is not a backseat type. Always use the special tool.

- Make sure to tighten the cap securely. Refer to the table below

Stop valve size	Tightening torque N·m (Turn clockwise to close)			
	Shaft		Cap (valve lid)	Service port
	Valve body	Hexagonal wrench		
Ø9.5	5.4~6.6	4 mm	13.5~16.5	11.5~13.9
Ø12.7	8.1~9.9		18.0~22.0	
Ø15.9	13.5~16.5	6 mm	23.0~27.0	
Ø19.1	27.0~33.0	8 mm	22.5~27.5	
Ø25.4				

### Closing stop valve (See figure 14)

- Remove the cap and turn the valve clockwise with the hexagon wrench.
- Securely tighten the valve until the shaft contacts the main body seal.
- Make sure to tighten the cap securely.  
For the tightening torque, refer to the table above.

## 11.4. How to check how many units are connected

It is possible to find out how many indoor units are active and connected by operating the push-button switch on the printed circuit board (A1P) of the working outdoor unit. In a multiple outdoor unit system, you can find out how many outdoor units are connected to the system by using the same procedure.

Make sure that all the indoor units connected to the outdoor unit are active.

Follow the 5-step procedure as explained below.

- The LEDs on the A1P shows the operating status of the outdoor unit and the number of indoor units that are active.

● OFF      ☀ ON      ⚡ Blinking

- The number of units that are active can be read from the LED display in the "Monitor Mode" procedure below.

**Example:** in the following procedure there are 22 units active:



Wherever during this procedure, press the **BS1 MODE** button if something becomes unclear.

You will return to setting mode 1 (H1P= ● "OFF").

### 1 Setting mode 1 (default system status)

H1P	H2P	H3P	H4P	H5P	H6P	H7P
●	●	☀	●	●	●	●

Default status (normal)

Press the **BS1 MODE** button to switch from setting mode 1 to monitor mode.

### 2 Monitor mode

H1P	H2P	H3P	H4P	H5P	H6P	H7P
☀	●	●	●	●	●	●

Default status display

To check the number of indoor units, press the **BS2 SET** button 5 times

To check the number of outdoor units, press the **BS2 SET** button 8 times



### 3 Monitor mode

Selection status of how many connected indoor units to display.

OR

Selection status of how many connected outdoor units to display.

Pressing the **BS3 RETURN** button causes the LED display to show the data on the number of indoor units that are connected or how many outdoor units that are connected in a multiple outdoor unit system.

H1P	H2P	H3P	H4P	H5P	H6P	H7P
H1P	H2P	H3P	H4P	H5P	H6P	H7P

### 4 Monitor mode

Displaying the number of connected indoor units

H1P	H2P	H3P	H4P	H5P	H6P	H7P
	32	16	8	4	2	1

Calculate the number of connected indoor units by adding the values of all (H2P~H7P) blinking (※) LEDs together.  
In this example: 16+4+2=22 units

Press the **BS1 MODE** button to return to step 1, setting mode 1 (H1P= ● "OFF").

## 11.5. Additional refrigerant charge

There are two ways to charge refrigerant. Use the selected method following the described procedure below.

- Adding refrigerant using leak detection function.  
Refer to "1 Adding refrigerant using leak detection function" on page 20
- Adding refrigerant without using leak detection function.  
Refer to "2 Adding refrigerant without using leak detection function" on page 22



Adding refrigerant using the automatic refrigerant charging function is recommended.

If refrigerant is added manually, without using the automatic refrigerant charging function, the refrigerant leak detection function can not be used.

Follow the procedures below.



- When charging a system, charging over the permissible quantity can cause liquid hammer.
- Always use protective gloves and protect your eyes when charging refrigerant.
- When the refrigerant charging procedure is done or when pausing, close the valve of the refrigerant tank immediately. If the tank is left with the valve open, the amount of refrigerant which is properly charged may get off point. More refrigerant may be charged by any remaining pressure after the unit has stopped.



#### Electric shock warning

- Close the electric box lid before turning on the main power.
- Perform the settings on the circuit board (A1P) of the outdoor unit and check the LED display after the power is on via the service lid which is in the lid of the electric box.  
Operate switches with an insulated stick (such as a ball-point pen) to avoid touching the life parts.  
Make sure to re-attach the inspection cover into the switch box cover after the job is finished.



- If the power of some units is turned off, the charging procedure can not be finished properly.
- In case of a multiple outdoor system, turn on the power of all outdoor units.
- Make sure to turn ON the power 6 hours before starting the operation. This is necessary to warm the crankcase by the electric heater.
- If operation is performed within 12 minutes after the indoor and outdoor units are turned on, the H2P-LED will be lit and the compressor will not operate.

#### NOTE



- See "11.3. Stop valve operation procedure" on page 19 for details on how to handle stop valves.
- The refrigerant charging port is connected to the piping inside the unit. The unit's internal piping is already factory charged with refrigerant, so be careful when connecting the charge hose.
- After adding the refrigerant, do not forget to close the lid of the refrigerant charging port. The tightening torque for the lid is 11.5 to 13.9 N·m.
- In order to ensure uniform refrigerant distribution, it may take the compressor ±10 minutes to start up after the unit has started operation. This is not a malfunction.

### 1 Adding refrigerant using leak detection function

The automatic refrigerant charging has limits as described below.

At out of limit, the system can not operate the automatic refrigerant charging.

Outdoor temperature	: 0°C DB~43°C DB
Indoor temperature	: 20°C DB~32°C DB
Total indoor unit capacity	: ≥80%

To speed up the proces of charging refrigerant for large systems, it is recommended to first manually charge a portion of the refrigerant first before performing automatic charging.

- 1 Calculate how much refrigerant to be added using the formula explained in the chapter "How to calculate the additional refrigerant to be charged" on page 10.
- 2 The amount of pre-charging is 10 kg less than the calculated amount.
- 3 Open valve C (valves A and B and the stop valves must be left closed) and charge the refrigerant in liquid form via the liquid side stop valve service port.  
(See figure 28)

- 1 Measuring instrument
- 2 Tank (siphon system)
- 3 Charge hose
- 4 Liquid line stop valve
- 5 Gas line stop valve
- 6 Stop valve service port
- 7 Valve B
- 8 Valve C
- 9 Valve A
- 10 Outdoor unit
- 11 Refrigerant charge port
- 12 To indoor unit
- 13 Interunit piping
- 14 Refrigerant flow

- If the calculated amount of pre-charging is reached, close valve C.



At least the unit should be charged with its original amount of refrigerant (refer to the nameplate on the unit), before starting the automatic charging.

- After pre-charging, perform the refrigerant charge operation as shown below and charge the remaining refrigerant of the additional charging amount through valve A.

(See figure 29)

- Measuring instrument
- Tank (siphon system)
- Charge hose
- Liquid line stop valve
- Gas line stop valve
- Stop valve service port
- Valve B
- Valve C
- Valve A
- Outdoor unit
- Refrigerant charge port
- Field piping
- Refrigerant flow
- Indoor unit

**NOTE**



For a multi outdoor unit system, it is not required to connect all charge ports to a refrigerant tank.

The refrigerant will be charged with  $\pm 22$  kg in 1 hour time at an outdoor temperature of 30°C DB or with  $\pm 6$  kg at an outdoor temperature of 0°C DB.

If you need to speed up in case of a multiple outdoor system, connect the refrigerant tanks to each outdoor unit as shown in figure 29.

**1. Start of automatic charging refrigerant**

- Open the liquid and gas side stop valves and the service port stop valve. (Valves A, B and C must be closed.)
- Close all frontpanels except the electric box frontpanel and turn the power ON.
- Make sure all indoor units are connected, refer to "11.4. How to check how many units are connected" on page 19.
- If the H2P LED is not flashing (in 12 minutes time after turning on the power), make sure it is displayed as shown in the "3 Normal system display" on page 24.

If the H2P LED is flashing, check the malfunction code on the remote controller "4 Remote controller malfunction code display" on page 24.

- Press the BS1 MODE button once if the LEDs combination is not as in the figure below.



- Press the BS4 TEST button once.



- Hold the BS4 TEST button down for 5 seconds or more.

**5. Charging mode judgement**

For automatic charging, the charging must be done in cooling mode.

However, if the indoor temperature is 20°C DB or lower, in some cases the unit will first charge in heating mode to increase the indoor temperature.

The unit will automatically select the cooling mode or heating mode for charging.



During charging in heating mode, a person must manually close valve A before complete charging is finished. The required amount is the the calculated amount (see "6.6. Example of connection" on page 9) minus 10 kg, therefore, the weight must be monitored constantly.



For the cooling only models, heating mode can not be selected. In this case, the LED display will indicate out of range. Refer to the procedure as described in "5 Final adjustment of the amount of refrigerant" on page 24.

**Continue with the automatic charging in cooling mode OR in heating mode.**

**■ Charging in heating mode (not for cooling only models)**

- Start up  
Wait while the unit is preparing for charging in heating mode.

	H1P	H2P	H3P	H4P	H5P	H6P	H7P
Pressure control (for the first minute)	●	☀	●	●	●	●	☀
Start up control (for the next 2 minutes)	☀	☀	●	●	●	☀	●
Waiting for stable heating conditions (for the next ±15 minutes (according to the system))	☀	☀	●	●	●	☀	☀

- Ready



Press the BS4 TEST button once within 5 minutes.

If the BS4 TEST button is not pushed within 5 minutes, P2 will be displayed on the remote controller. Refer to "4 Remote controller malfunction code display" on page 24.

- Operation

When the following LED display is shown, open valve A and close the frontpanel. If the frontpanel is left open, the system can not operate properly during the refrigerant charging.



\* = The state of this LED is not important.



When a malfunction occurs, check the display of the remote controller and refer to "4 Remote controller malfunction code display" on page 24.

- Complete

If the calculated amount of refrigerant minus 10 kg is reached, close valve A and press the BS3 RETURN button once.



As long as the BS3 RETURN button is not pressed, the system will remain in heating mode. This can be required to increase the indoor temperature.

- Press the BS4 TEST button to perform the temperature range check

**Out of range:**

	H1P	H2P	H3P	H4P	H5P	H6P	H7P
Out of outdoor temperature range	☀	☀	☀	☀	☀	●	●
Out of indoor temperature range	☀	☀	☀	☀	●	☀	●

In these cases, press the BS1 MODE button once and follow the procedure as "5 Final adjustment of the amount of refrigerant" on page 24.

**In range:**

The unit will restart from the charging mode judgement onwards and the cooling mode will be selected. However, if in the mean time the temperature has become out of range, heating mode will be selected again, this is required to increase the indoor temperature.

## ■ Charging in cooling mode

### 6. Start up

Wait while the unit is preparing for charging in cooling mode.

	H1P	H2P	H3P	H4P	H5P	H6P	H7P
Pressure control (for the first minute)	●	☀	●	●	●	●	☀
Start up control (for the next 2 minutes)	●	☀	●	●	●	☀	●
Waiting for stable heating conditions (for the next ±15 minutes (according to the system))	●	☀	●	●	●	☀	☀

### 7. Ready

H1P	H2P	H3P	H4P	H5P	H6P	H7P
☀	☀	☀	●	☀	●	☀

Press the **BS4 TEST** button once within 5 minutes.

If the **BS4 TEST** button is not pushed within 5 minutes, P2 will be displayed on the remote controller. Refer to "4 Remote controller malfunction code display" on page 24.

### 8. Operation

When the following LED display is shown, open valve A and close the frontpanel. If the frontpanel is left open, the system can not operate properly during the refrigerant charging.

H1P	H2P	H3P	H4P	H5P	H6P	H7P
☀	☀	*	*	*	*	*

\* = The state of this LED is not important.



When a malfunction occurs, check the display of the remote controller and refer to "4 Remote controller malfunction code display" on page 24.

### 9. Complete

If the display on the remote controller shows a flashing PE code, charging is almost finished.

When the unit stops operating, close valve A immediately and check the LEDs and check if the P9 code is displayed on the remote controller. When the charging amount is little, the PE code may not be displayed, but instead the P9 code will be displayed immediately.

H1P	H2P	H3P	H4P	H5P	H6P	H7P
☀	☀	☀	☀	☀	☀	☀

If it is not as shown above, correct the malfunction (as indicated in the display of the remote controller) and restart the complete charging procedure.

### 10. Press the **BS4 TEST** button to perform the temperature range check

#### Out of range:

	H1P	H2P	H3P	H4P	H5P	H6P	H7P
Out of outdoor temperature range	☀	☀	☀	☀	☀	●	●
Out of indoor temperature range	☀	☀	☀	☀	●	☀	●

In these cases, press the **BS1 MODE** button once and follow the procedure as described in "5 Final adjustment of the amount of refrigerant" on page 24.

#### In range:

The state of the LEDs will show:

H1P	H2P	H3P	H4P	H5P	H6P	H7P
☀	☀	☀	☀	☀	☀	☀

Press the **BS1 MODE** button once. The procedure is completed. Record the amount that was added on the additional refrigerant charge label provided with the unit and attach it on the back side of the front panel.

Perform the test procedure as described in "In case refrigerant was added by using the leak detection function" on page 28.

## 2 Adding refrigerant without using leak detection function

### ■ Charge with the outdoor unit at standstill

1. Calculate how much refrigerant to be added using the formula explained in the chapter "How to calculate the additional refrigerant to be charged" on page 10.

2. Open valve C (valves A and B and the stop valves must be left closed) and charge the required amount of refrigerant through the liquid side stop valve service port.

■ When the required amount of refrigerant is fully charged, close valve C. Record the amount of refrigerant that was added on the additional refrigerant charge label provided with the unit and attach it on the back side of the front panel. Perform the test procedure as described in "In case refrigerant was added without using the leak detection function (pre-charging, charging in heating mode)" on page 28.

■ When the additional charging is not complete, perform the procedure explained in the chapter "Charge with operating outdoor unit" on page 22.

### ■ Charge with operating outdoor unit

Charge the refrigerant through valve A.

#### 1. Start of charging refrigerant manually

- Open the liquid and gas side stop valves and the service port stop valve. (Valves A, B and C must be closed.)
- Close all frontpanels except the electric box frontpanel and turn the power ON.
- Make sure all indoor units are connected, refer to "11.4. How to check how many units are connected" on page 19.
- If the H2P LED is not flashing (in 12 minutes time after turning on the power), make sure it is displayed as shown below.

If the H2P LED is flashing, check the malfunction on the remote controller "4 Remote controller malfunction code display" on page 24.

2. Press the **BS1 MODE** button once if the LEDs combination is not as in the figure below.

H1P	H2P	H3P	H4P	H5P	H6P	H7P
●	●	☀	●	●	●	●

3. Press the **BS4 TEST** button once.

H1P	H2P	H3P	H4P	H5P	H6P	H7P
☀	☀	☀	☀	☀	☀	☀

4. Hold the **BS4 TEST** button down for 5 seconds or more.

#### 5. Charging mode judgement

If the indoor temperature is 20°C DB or lower, charging in cooling mode is not possible in some cases. The unit will automatically select the cooling mode or heating mode for charging.



When charging in cooling mode, the unit will stop operating when the required amount of refrigerant is charged.

During charging in heating mode, a person must manually close valve A when complete charging is finished. Calculate how much refrigerant to be added using the formula explained in the chapter "How to calculate the additional refrigerant to be charged" on page 10.



For the cooling only models, heating mode can not be selected. In this case, the LED display will indicate out of range. Refer to the procedure as described in "5 Final adjustment of the amount of refrigerant" on page 24.

## Continue with the manually charging in cooling mode OR in heating mode.

### ■ Charging in heating mode (not for cooling only models)

- Start up  
Wait while the unit is preparing for charging in heating mode.

	H1P	H2P	H3P	H4P	H5P	H6P	H7P
Pressure control (for the first minute)	●	☀	●	●	●	●	☀
Start up control (for the next 2 minutes)	☀	☀	●	●	●	☀	●
Waiting for stable heating conditions (for the next ±15 minutes (according to the system))	☀	☀	●	●	●	☀	☀

- Ready

H1P	H2P	H3P	H4P	H5P	H6P	H7P
☀	☀	●	●	☀	●	☀

Press the **BS4 TEST** button once within 5 minutes.  
If the **BS4 TEST** button is not pushed within 5 minutes, P2 will be displayed on the remote controller. Refer to "4 Remote controller malfunction code display" on page 24.

- Operation  
When the following LED display is shown, open valve A and close the frontpanel. If the frontpanel is left open, the system can not operate properly during the refrigerant charging.

H1P	H2P	H3P	H4P	H5P	H6P	H7P
☀	☀	*	*	*	*	*

\* = The state of this LED is not important.



When a malfunction occurs, check the display of the remote controller and refer to "4 Remote controller malfunction code display" on page 24.

- Complete  
If the calculated amount of refrigerant minus 10 kg is reached, close valve A and press the **BS3 RETURN** button once.

H1P	H2P	H3P	H4P	H5P	H6P	H7P
☀	☀	☀	☀	☀	☀	☀

- Press the **BS1 MODE** button once and the charging is complete. Record the amount that was added on the additional refrigerant charge label provided with the unit and attach it on the back side of the front panel.  
Perform the test procedure as described in "In case refrigerant was added without using the leak detection function (pre-charging, charging in heating mode)" on page 28.

### ■ Charging in cooling mode

- Start up  
Wait while the unit is preparing for charging in cooling mode.

	H1P	H2P	H3P	H4P	H5P	H6P	H7P
Pressure control (for the first minute)	●	☀	●	●	●	●	☀
Start up control (for the next 2 minutes)	●	☀	●	●	●	☀	●
Waiting for stable heating conditions (for the next ±15 minutes (according to the system))	●	☀	●	●	●	☀	☀

- Ready

H1P	H2P	H3P	H4P	H5P	H6P	H7P
☀	☀	☀	●	☀	●	☀

Press the **BS4 TEST** button once within 5 minutes.  
If the **BS4 TEST** button is not pushed within 5 minutes, P2 will be displayed on the remote controller. Refer to "4 Remote controller malfunction code display" on page 24.

- Operation  
When the following LED display is shown, open valve A and close the frontpanel. If the frontpanel is left open, the system can not operate properly during the refrigerant charging.

H1P	H2P	H3P	H4P	H5P	H6P	H7P
☀	☀	*	*	*	*	*

\* = The state of this LED is not important.



When a malfunction occurs, check the display of the remote controller and refer to "4 Remote controller malfunction code display" on page 24.

- Complete  
If the display on the remote controller shows a flashing PE code, charging is almost finished.  
When the unit stops operating, close valve A immediately and check the LEDs and check if the P3 code is displayed on the remote controller.

H1P	H2P	H3P	H4P	H5P	H6P	H7P
☀	☀	☀	☀	☀	☀	☀

If it is not as shown above, correct the malfunction (as indicated in the display of the remote controller) and restart the complete charging procedure. When the charging amount is little, the PE code may not be displayed, but instead the P3 code will be displayed immediately.

- Press the **BS1 MODE** button once and the charging is complete. Record the amount that was added on the additional refrigerant charge label provided with the unit and attach it on the back side of the front panel.  
Perform the test procedure as described in "In case refrigerant was added without using the leak detection function (charging in cooling mode)" on page 28.

### 3 Normal system display

LED display (Default status before delivery)	Micro-computer operation monitor	Mode	Ready/Error	Cooling/Heating changeover			Low noise	Demand	Multi
				Individual	Bulk (master)	Bulk (slave)			
	HAP	H1P	H2P	H3P	H4P	H5P	H6P	H7P	H8P
Single outdoor unit system	☀	●	●	☀	●	●	●	●	●
Multiple outdoor unit system	Master unit <sup>(a)</sup>	☀	●	☀	●	●	●	●	☀
	Slave unit 1 <sup>(a)</sup>	☀	●	●	●	●	●	●	☀
	Slave unit 2 <sup>(a)</sup>	☀	●	●	●	●	●	●	●

(a) The state of the H8P (multi) LED in a multi-system shows which unit is the master unit (☀), slave 1 unit (☀) or slave 2 unit (●). Only the master unit is connected to the indoor units with interunit wiring.

### 4 Remote controller malfunction code display

#### Remote controller heating mode malfunction codes

Error code	
PB recharge operation	Close valve A immediately and press the TEST OPERATION button once. The operation will restart from the charging mode judgement onwards.
P2 charge hold	Close valve A immediately. Check following items: - Check if the gas side stop valve is opened correctly - Check if the valve of the refrigerant cylinder is opened - Check if the air inlet and outlet of the indoor unit are not obstructed After correcting the abnormality, restart the automatic charging procedure again.

#### Remote controller cooling mode malfunction codes

Error code	
PR, PH, PC replace cylinder	Close valve A and replace the empty cylinder. When renewed, open valve A (the outdoor unit will not stop operating). The code on the display shows the unit where a cylinder is to be renewed: PR = master unit, PH = slave unit 1, PC = slave unit 2, flashing PR, PH and PC = all units After replacing the cylinder, open valve A again and continue the work.
PB recharge operation	Close valve A immediately. Restart the automatic charging procedure again.
P2 charge hold	Close valve A immediately. Check following items: - Check if the gas side stop valve is opened correctly - Check if the valve of the refrigerant cylinder is opened - Check if the air inlet and outlet of the indoor unit are not obstructed - Check if the indoor temperature is not lower than 20°C DB After correcting the abnormality, restart the automatic charging procedure again.
* abnormal stop	Close valve A immediately. Confirm the malfunction code by the remote controller and correct the abnormality by following the "Correcting after abnormal completion of the test operation" on page 29.

### 5 Final adjustment of the amount of refrigerant

- When the unit displays an out of temperature range, the automatic charging of refrigerant can not be completed.

#### Out of outdoor temperature range

H1P	H2P	H3P	H4P	H5P	H6P	H7P
☀	☀	☀	☀	☀	●	●

Complete the charging of refrigerant on another time when the outdoor temperature is warmer than 0°C DB and colder than 43°C DB.

#### Out of indoor temperature range

H1P	H2P	H3P	H4P	H5P	H6P	H7P
☀	☀	☀	☀	●	☀	●

Complete the charging of refrigerant on another time when the indoor temperature is warmer than 20°C DB and colder than 32°C DB.

In this case, perform a test operation (as explained in the chapter "12.4. Test operation" on page 27) and the unit will work properly. (The malfunction code E3 will be displayed on the indoor unit.)

However, the refrigerant leak detection function can not be used before completing the refrigerant charging operation and the judgement of the initial amount of refrigerant by performing the test operation again.

- When the temperature has come in range (outdoor = 0~43°C, indoor = 20~32°C), perform the overcharging judgement procedure for completion of the refrigerant charging operation.

#### Overcharging judgement procedure

- Close all the front panels except the electric box front panel and the lid on the side of the electric box.
  - Turn on the power to the outdoor unit and all the connected indoor units.
  - Press the BS1 MODE button once and set the setting model H1P = OFF.
  - Press and hold the BS4 TEST button down for 5 seconds. The system will start operating.
  - Close all the front panels. After operating for 40 minutes, the operation will stop automatically.
  - After the system has stopped operating, check the display on the remote controller.
  - If E3, F5 or UF is displayed on the remote controller as a result of the overcharge judging operation, recover 20% of the charged amount of refrigerant and perform the overcharge judgement procedure again.
- When there is no more overcharging of refrigerant detected, restart the automatic refrigerant charging from "1. Start of automatic charging refrigerant" as explained on page 21 again.

#### 11.6. Checks after adding refrigerant

- Are the stop valves for both liquid and gas open?
- Is the amount of refrigerant, that has been added, recorded?



Make sure to open the stop valves after charging the refrigerant.

Operating with the stop valves closed will damage the compressor.

## 12. BEFORE OPERATION

### 12.1. Service precautions



#### WARNING: ELECTRIC SHOCK

##### Caution when performing service to inverter equipment

- 1 Do not open the electric box cover for 10 minutes after the power supply is turned off.
- 2 Measure the voltage between terminals on the terminal block for power supply with a tester and confirm that the power supply is shut off.

In addition, measure the points, as shown in the figure below, with a tester and confirm that the voltage of the capacitor in the main circuit is less than 50 V DC.

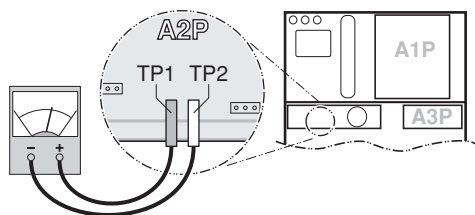

- 3 To prevent damaging the PC-board, touch a noncoated metal part to eliminate static electricity before pulling out or plugging in connectors.
- 4 The performing of the service to the inverter equipment must be started after the junction connectors X1A, X2A, X3A, X4A (X3A and X4A are for RXYHQ12 + RX(Y)Q14~18 unit type only) for the fan motors in the outdoor unit are been pulled out. Be careful not to touch the live parts.  
(If a fan rotates due to strong wind, it may store electricity in the capacitor or in the main circuit and cause electric shock.)
- 5 After the service is finished, plug the junction connector back in. Otherwise the error code E7 will be displayed on the remote controller and normal operation will not be performed.

For details refer to the wiring diagram labeled on the back of the electric box cover.

**Pay attention to the fan.** It is dangerous to inspect the unit while the fan is running. Be sure to turn off the main switch and to remove the fuses from the control circuit located in the outdoor unit.

#### NOTE **Play it safe!**

 For protection of the PCB, touch the switch box casing by hand in order to eliminate static electricity from your body before performing service.

### 12.2. Checks before initial start-up

**NOTE**  
 Remark that during the first running period of the unit, required power input may be higher than stated on the nameplate of the unit. This phenomenon originates from the compressor that needs elapse of a 50 hours run in period before reaching smooth operation and stable power consumption.

- Make sure that the circuit breaker on the power supply panel of the installation is switched off.
- Attach the power wire securely.
- Introducing power with a missing N-phase or with a mistaken N-phase will break the equipment.

After the installation, check the following before switching on the circuit breaker:

- 1 The position of the switches that require an initial setting  
Make sure that switches are set according to your application needs before turning the power supply on.
- 2 Power supply wiring and transmission wiring  
Use a designated power supply and transmission wiring and make sure that it has been carried out according to the instructions described in this manual, according to the wiring diagrams and according to local and national regulations.
- 3 Pipe sizes and pipe insulation  
Make sure that correct pipe sizes are installed and that the insulation work is properly executed.
- 4 Air tight test and vacuum drying  
Make sure the air tight test and vacuum drying were completed.
- 5 Additional refrigerant charge  
The amount of refrigerant to be added to the unit should be written on the included "Added Refrigerant" plate and attached to the rear side of the front cover.
- 6 Insulation test of the main power circuit  
Using a megatester for 500 V, check that the insulation resistance of 2 MΩ or more is attained by applying a voltage of 500 V DC between power terminals and earth. Never use the megatester for the transmission wiring.
- 7 Installation date and field setting  
Be sure to keep record of the installation date on the sticker on the rear of the upper front panel according to EN60335-2-40. and keep record of the contents of the field setting.

### 12.3. Field setting

If required, carry out field settings according to the following instructions. Refer to the service manual for more details.

#### Opening the switch box and handling the switches

When carrying out field settings, remove the inspection cover (1).

Operate the switches with an insulated stick (such as a ball-point pen) to avoid touching live parts.

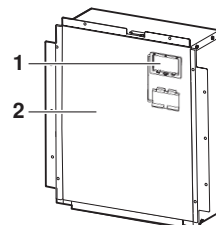

Make sure to re-attach the inspection cover (1) into the switch box cover (2) after the job is finished.

**NOTE**  
 Make sure that all outside panels, except for the panel on the electric box, are closed while working.  
Close the lid of the electric box firmly before turning on the power.

## Location of the dip switches, LEDs and buttons

- 1 LED H1~8P
- 2 Push button switches BS1~BS5
- 3 Dip switch 1 (DS1: 1~4)
- 4 Dip switch 2 (DS2: 1~4)
- 5 Dip switch 3 (DS3: 1~2)

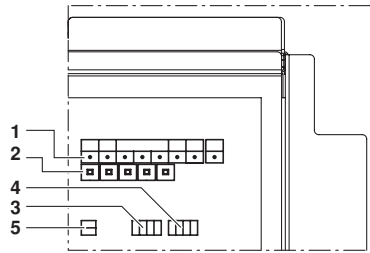

## LED state

Throughout the manual the state of the LEDs is indicated as follows:

- OFF
- ☀ ON
- ⚡ Blinking

## Setting the dip switches (only in case of a heat pump unit)

What to set with dip switch DS1	
1	COOL/HEAT selector (refer to "8.7. Field line connection: transmission wiring and cool/heat selection" on page 16) (OFF = not installed = factory setting)
2~4	NOT USED DO NOT CHANGE THE FACTORY SETTING.
What to set with dip switch DS2	
1~4	NOT USED DO NOT CHANGE THE FACTORY SETTING.
What to set with dip switch DS3	
1+2	NOT USED DO NOT CHANGE THE FACTORY SETTING.

## Setting the push button switch (BS1~5)

Function of the push button switch which is located on the outdoor unit PCB (A1P):

MODE	TEST: ⚡	C/H SELECT			L.N.O.P	DEMAND	MULTI
	HWL: ☀	IND	MASTER	SLAVE			
● H1P	● H2P	☀ H3P	● H4P	● H5P	● H6P	● H7P	● H8P

BS1 MODE	BS2 SET	BS3 RETURN	BS4 TEST	BS5 RESET
-------------	------------	---------------	-------------	--------------

- BS1 MODE** For changing the set mode
- BS2 SET** For field setting
- BS3 RETURN** For field setting
- BS4 TEST** For test operation
- BS5 RESET** For resetting the address when the wiring is changed or when an additional indoor unit is installed

The figure shows state of the LED indications when the unit is shipped from the factory.

	H1P	H2P	H3P	H4P	H5P	H6P	H7P
1	●	●	⚡	●	●	●	●
2	●	●	●	⚡	●	●	●
3	●	●	●	●	⚡	●	●

(a) It is necessary to use the optional external control adapter for outdoor unit (DTA104A61/62). See the instruction delivered with the adapter.

## Check operation procedure

- 1 Turn the power on for the outdoor unit and the indoor unit.  
Be sure to turn the power on at least 6 hours before operation in order to have power running to the crank case heater.
- 2 Make sure that transmission is normal by checking the LED display on the outdoor unit circuit board (A1P). (If transmission is normal, each LED will be displayed as shown below.)

LED display (Default status before delivery)	Micro-computer operation monitor HAP	Mode H1P	Ready/Error H2P	Cooling/Heating changeover			Low noise H6P	Demand H7P	Multi H8P
				Individual H3P	Bulk (master) H4P	Bulk (slave) H5P			
Single outdoor unit system	☀	●	●	☀	●	●	●	●	●
Multiple outdoor unit system	Master unit <sup>(a)</sup>	●	●	☀	●	●	●	●	☀
	Slave unit 1 <sup>(a)</sup>	☀	●	●	●	●	●	●	⚡
	Slave unit 2 <sup>(a)</sup>	☀	●	●	●	●	●	●	●

(a) The state of the H8P (multi) LED in a multi-system shows which unit is the master unit (☀), slave 1 unit (⚡) or slave 2 unit (●).  
Only the master unit is connected to the indoor units with interunit wiring.

## Setting the mode

The set mode can be changed with the BS1 MODE button according to the following procedure:

- For setting mode 1: Press the BS1 MODE button once, the H1P LED is off ●.
- For setting mode 2: Press the BS1 MODE button for 5 seconds, the H1P LED is on ☀.

If the H1P LED is blinking ⚡ and the BS1 MODE button is pushed once, the setting mode will change to setting mode 1.

**NOTE** If you get confused in the middle of the setting process, push the BS1 MODE button. Then it returns to setting mode 1 (H1P LED is off).

## Setting mode 1

(not in case of cooling only unit)

The H1P LED is off (COOL/HEAT selection setting).

## Setting procedure

- 1 Push the BS2 SET button and adjust the LED indication to either one of the possible settings as shown below in the field marked :
  - 1 In case of COOL/HEAT setting by each individual outdoor unit circuit.
  - 2 In case of COOL/HEAT setting by the master unit when outdoor units are connected in multiple system-combination<sup>(a)</sup>.
  - 3 In case of COOL/HEAT setting by the slave unit when outdoor units connected in multiple system-combination<sup>(a)</sup>.

- 2 Push the BS3 RETURN button and the setting is defined.

## Setting mode 2

The H1P LED is on.

### Setting procedure

- 1 Push the **BS2 SET** button according to the required function (A~H). The LED indication that matches the required function is shown below in the field marked :

#### Possible functions

- A additional refrigerant charging operation.
- B refrigerant recovery operation/vacuumping operation.
- C setting of high static pressure.
- D automatic low noise operation setting at nighttime.
- E low noise operation level setting (L.N.O.P) via the external control adapter.
- F power consumption limitation setting (DEMAND) via the external control adapter.
- G enabling function of the low noise operation level setting (L.N.O.P) and/or power consumption limitation setting (DEMAND) via the external control adapter (DTA104A61/62).
- H check operation (without initial refrigerant decision)

	H1P	H2P	H3P	H4P	H5P	H6P	H7P
A	☀	●	☀	●	☀	●	●
B	☀	●	☀	●	☀	●	☀
C	☀	●	☀	●	●	☀	●
D	☀	●	☀	●	☀	☀	●
E	☀	●	☀	☀	●	●	☀
F	☀	●	☀	☀	☀	☀	●
G	☀	●	●	☀	☀	●	●
H	☀	●	●	●	☀	☀	☀

- 2 When the **BS3 RETURN** button is pushed, the current setting is defined.

- 3 Push the **BS2 SET** button according to the required setting possibility as shown below in the field marked .

- 3.1 Possible settings for function A, B, C, G and H are ON (ON) or OFF (OFF).

	H1P	H2P	H3P	H4P	H5P	H6P	H7P
ON	☀	●	●	●	●	☀	●
OFF	☀	●	●	●	●	●	☀

(a) This setting = factory setting

- 3.2 Possible settings for function D

The noise of level 3 < level 2 < level 1 (▲ 1).

	H1P	H2P	H3P	H4P	H5P	H6P	H7P
OFF (a)	☀	●	●	●	●	●	●
▲ 1	☀	●	●	●	●	●	☀
▲ 2	☀	●	●	●	●	☀	●
▲ 3	☀	●	●	●	●	☀	☀

(a) This setting = factory setting

- 3.3 Possible settings for function E and F

For function E (L.N.O.P) only: the noise of level 3 < level 2 < level 1 (▲ 1).

For function F (DEMAND) only: the power consumption of level 1 < level 2 < level 3 (▲ 3).

	H1P	H2P	H3P	H4P	H5P	H6P	H7P
▲ 1	☀	●	●	●	●	●	☀
▲ 2 (a)	☀	●	●	●	●	☀	●
▲ 3	☀	●	●	●	☀	●	●

(a) This setting = factory setting

- 4 Push the **BS3 RETURN** button and the setting is defined.

- 5 When the **BS3 RETURN** button is pushed again, the operation starts according to the setting.

Refer to the service manual for more details and for other settings.

### Confirmation of the set mode

**The following items can be confirmed by setting mode 1 (H1P LED is off)**

Check the LED indication in the field marked .

- 1 Indication of the present operation state

- ●, normal
- ☀, abnormal
- ☀, under preparation or under test operation

H1P	H2P	H3P	H4P	H5P	H6P	H7P
●	●	☀	●	●	●	●

- 2 Indication of COOL/HEAT selection setting

- 1 When set to COOL/HEAT change-over by each individual outdoor unit circuit (= factory setting).
- 2 Indication on master unit when COOL/HEAT change-over is carried out by outdoor system connected in multiple system-combination.
- 3 Indication on slave unit when COOL/HEAT change-over is carried out by outdoor system connected in multiple system-combination.

	H1P	H2P	H3P	H4P	H5P	H6P	H7P
1(a)	●	●	☀	●	●	●	●
2	●	●	●	☀	●	●	●
3	●	●	●	●	☀	●	●

(a) This setting = factory setting.

- 3 Indication of low noise operation state L.N.O.P

- ● standard operation (= factory setting)
- ☀ L.N.O.P operation

H1P	H2P	H3P	H4P	H5P	H6P	H7P
●	●	☀	●	●	●	●

- 4 Indication of power consumption limitation setting DEMAND

- ● standard operation (= factory setting)
- ☀ DEMAND operation

H1P	H2P	H3P	H4P	H5P	H6P	H7P
●	●	☀	●	●	●	●

## 12.4. Test operation



**Do not insert fingers, rods or other objects into the air inlet or outlet. When the fan is rotating at high speed, it will cause injury.**



**Do not perform the test operation while working on the indoor units.**

When performing the test operation, not only the outdoor unit, but the connected indoor unit will operate as well. Working on a indoor unit while performing a test operation is dangerous.



**In case refrigerant was added by using the leak detection function**

- In the check operation, the following checks and judgements will be performed:
  - Check of the stop valve opening
  - Check for wrong wiring
  - Judgement of piping length
  - Judgement of initial refrigerant state
- It takes ±3 hours (if the outdoor temperature is low, it takes ±4 hours) to complete the check operation.
- The system can not perform the judgement of initial refrigerant state in the following cases:
  - The outdoor temperature is out of range (<0°C DB or >43°C DB)
  - The indoor temperature is out of range (<20°C DB or >32°C DB)
  - A forced OFF during the test operation

In this case, after performing the check operation, normal operation is possible although the abnormality code U3 is displayed on the indoor remote controller and the refrigerant leakage detection function can not be used.

Perform the check operation again and complete the judgement of initial refrigerant state.

Perform the test operation as described in the paragraph "Test operation procedure" on page 28.

**In case refrigerant was added without using the leak detection function (charging in cooling mode)**

- In the check operation, the following checks and judgement will be performed:
  - Check of the stop valve opening
  - Check for wrong wiring
  - Judgement of piping length
- It takes ±30 minutes to complete the check operation.

**Check operation procedure**

- 1 Close the electric box lid and all front panels except the one on the side of the electric box.
- 2 Turn on the power to the outdoor unit and all connected indoor units. Be sure to turn the power ON at least 6 hours before operation in order to have power running to the crank case heater.
- 3 Make the field setting as needed using the push buttons on the PCB (A1P) of the outdoor unit. Refer to "12.3. Field setting" on page 25.
- 4 Set the check operation (without initial refrigerant decision) following setting mode 2 in the field setting and perform the check operation.
 

The system operates for ±30 minutes and automatically stops the check operation.

  - If no malfunction code is displayed on the remote controller after the system has stopped, check if the operation is completed. Normal operation will be possible after 5 minutes.
  - If a malfunction code is displayed on the remote controller, correct the malfunction and perform the check operation again as described in "Correcting after abnormal completion of the test operation" on page 29

**In case refrigerant was added without using the leak detection function (pre-charging, charging in heating mode)**

- In the check operation, the following checks and judgement will be performed:
  - Check of the stop valve opening
  - Check for wrong wiring
  - Check of refrigerant overcharge
  - Judgement of piping length
- It takes ±40 minutes to complete the check operation.

Perform the test operation as described in the paragraph "Test operation procedure" on page 28.

**Test operation procedure**

- 1 Close all front panels except the front panel of the electric box.
- 2 Turn ON the power to all outdoor units and the connected indoor units.
 

Be sure to turn on the power 6 hours before operation in order to have power running to the crank case heater and to protect the compressor.
- 3 Make the field setting as described in the paragraph "12.3. Field setting" on page 25.
- 4 Press the **BS1 MODE** button once, and set to the SETTING MODE (H1P LED = OFF).
- 5 Press and hold the **BS4 TEST** button down for 5 seconds or more. The unit will start the test operation.
  - The test operation is automatically carried out in cooling mode, the H2P LED will light up and the messages "Test operation" and "Under centralized control" will display on the remote controller.
  - It may take 10 minutes to bring the state of the refrigerant uniform before the compressor starts.
  - During the test operation, the refrigerant running sound or the magnetic sound of a solenoid valve may become loud and the LED display may change, but these are not malfunctions.
  - During the test operation, it is not possible to stop the unit operation from a remote controller. To abort the operation, press the **BS3 RETURN** button. The unit will stop after ±30 seconds.
- 6 Close the front panel in order to let it not be the cause of misjudgement.
- 7 Check the test operation results by the LED display on the outdoor unit.

	H1P	H2P	H3P	H4P	H5P	H6P	H7P
Normal completion	●	●	☀	●	●	●	●
Abnormal completion	●	☀	☀	●	●	●	●

- 8 When the test operation is fully completed, normal operation will be possible after 5 minutes.
 

Otherwise, refer to "Correcting after abnormal completion of the test operation" on page 29 to take actions for correcting the abnormality.

### Correcting after abnormal completion of the test operation

The test operation is only completed if there is no malfunction code displayed on the remote controller. In case of a displayed malfunction code, perform the following actions to correct the abnormality:

- Confirm the malfunction code on the remote controller

Installation error	Error code	Remedial action
The stop valve of an outdoor unit is left closed.	E3 E4 F3 UF	Check referring to the table in "11.5. Additional refrigerant charge" on page 20
The phases of the power to the outdoor units are reversed.	U1	Exchange two of the three phases (L1, L2, L3) to make a positive phase connection.
No power is supplied to an outdoor or indoor unit (including phase interruption).	U1 U4	Check if the power wiring for the outdoor units are connected correctly. (If the power wire is not connected to L2 phase, no malfunction display will appear and the compressor will not work.)
Incorrect interconnections between units	UF	Check if the refrigerant line piping and the unit wiring are consistent with each other.
Refrigerant overcharge	E3 F6 UF	Recalculate the required amount of refrigerant from the piping length and correct the refrigerant charge level by recovering any excessive refrigerant with a refrigerant recovery machine.
For the RX(Y)Q5~18 + RXYHQ12, the wiring is connected to the Q1/Q2 (Out Multi)	U7 UF	Remove the wiring from the Q1/Q2 (Out Multi).
Insufficient refrigerant	E4 F3	Check if the additional refrigerant charge has been finished correctly. Recalculate the required amount of refrigerant from the piping length and add an adequate amount of refrigerant.

- After correcting the abnormality, press the **BS3 RETURN** button and reset the malfunction code.
- Carry out the test operation again and confirm that the abnormality is properly corrected.

## 13. SERVICE MODE OPERATION

### Vacuating method

At the first installation, this vacuuing is not required. It is required only for repair purposes.

- When the unit is at standstill and under the setting mode 2, set the required function B (refrigerant recovery operation/vacuuing operation) to **ON (ON)**.
  - After this is set, do not reset the setting mode 2 until the vacuuing is finished.
  - The H1P LED is on and the remote controller indicates **TEST** (test operation) and  (external control) and the operation will be prohibited.
- Evacuate the system with a vacuum pump.
- Press the **BS1 MODE** button and reset the setting mode 2.

### Refrigerant recovery operation method

by a refrigerant reclaiming

- When the unit is at standstill and under the setting mode 2, set the required function B (refrigerant recovery operation/vacuuing operation) to **ON (ON)**.
  - The indoor unit and the outdoor unit expansion valves will fully open and some solenoid valves will be turned on.
  - The H1P LED is on and the remote controller indicates **TEST** (test operation) and  (external control) and the operation will be prohibited.

- Cut off the power supply to the indoor units and the outdoor unit with the circuit breaker. After the power supply to one side is cut off, cut off the power supply to the other side within 10 minutes. Otherwise, the communication between the indoor and outdoor unit may become abnormal and the expansion valves will be completely closed again.
- Recover the refrigerant by a refrigerant reclaiming. For details, see the operation manual delivered with the refrigerant reclaiming.

## 14. CAUTION FOR REFRIGERANT LEAKS

### Introduction

The installer and system specialist shall secure safety against leakage according to local regulations or standards. The following standards may be applicable if local regulations are not available.

This system uses R410A as refrigerant. R410A itself is an entirely safe non-toxic, non-combustible refrigerant. Nevertheless care must be taken to ensure that air conditioning facilities are installed in a room which is sufficiently large. This assures that the maximum concentration level of refrigerant gas is not exceeded, in the unlikely event of major leak in the system and this in accordance to the local applicable regulations and standards.

### Maximum concentration level

The maximum charge of refrigerant and the calculation of the maximum concentration of refrigerant is directly related to the humanly occupied space in to which it could leak.

The unit of measurement of the concentration is  $\text{kg/m}^3$  (the weight in kg of the refrigerant gas in  $1 \text{ m}^3$  volume of the occupied space).

Compliance to the local applicable regulations and standards for the maximum allowable concentration level is required.

According to the appropriate European Standard, the maximum allowed concentration level of refrigerant to a humanly space for R410A is limited to  $0.44 \text{ kg/m}^3$ .

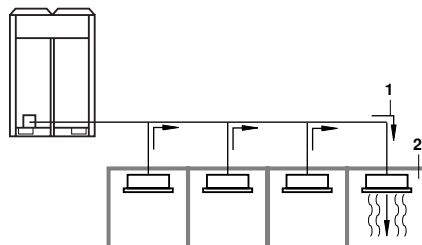

- direction of the refrigerant flow
- room where refrigerant leak has occurred (outflow of all the refrigerant from the system)

Pay special attention to places, such as a basements, etc. where refrigerant can stay, since refrigerant is heavier than air.

### Procedure for checking maximum concentration

Check the maximum concentration level in accordance with steps 1 to 4 below and take whatever action is necessary to comply.

- Calculate the amount of refrigerant (kg) charged to each system separately.

$$\begin{array}{l}
 \text{amount of refrigerant in a} \\
 \text{single unit system} \\
 \text{(amount of refrigerant with} \\
 \text{which the system is charged before} \\
 \text{leaving the factory)} \\
 + \\
 \text{additional charging} \\
 \text{amount (amount of} \\
 \text{refrigerant added} \\
 \text{locally in} \\
 \text{accordance with} \\
 \text{the length or} \\
 \text{diameter of the} \\
 \text{refrigerant piping)} \\
 = \\
 \text{total amount of} \\
 \text{refrigerant (kg) in} \\
 \text{the system}
 \end{array}$$

**NOTE**



Where a single refrigerant facility is divided into 2 entirely independent refrigerant systems, use the amount of refrigerant with which each separate system is charged.

**2 Calculate the smallest room volume (m<sup>3</sup>)**

In a case such as the following, calculate the volume of (A), (B) as a single room or as the smallest room.

A. Where there are no smaller room divisions

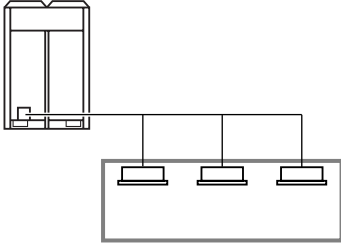

B. Where there is a room division but there is an opening between the rooms sufficiently large to permit a free flow of air back and forth.

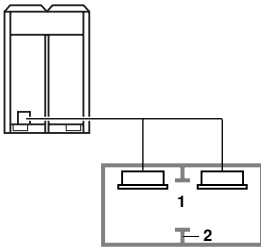

- 1 opening between rooms
- 2 partition  
(Where there is an opening without a door or where there are openings above and below the door which are each equivalent in size to 0.15% or more of the floor area.)

**3 Calculating the refrigerant density using the results of the calculations in steps 1 and 2 above.**

$$\frac{\text{total volume of refrigerant in the refrigerant system}}{\text{size (m}^3\text{) of smallest room in which there is an indoor unit installed}} \leq \text{maximum concentration level (kg/m}^3\text{)}$$

If the result of the above calculation exceeds the maximum concentration level then make similar calculations for the second then third smallest room and so until the result falls short of the maximum concentration.

**4 Dealing with the situations where the result exceeds the maximum concentration level.**

Where the installation of a facility results in a concentration in excess of the maximum concentration level then it will be necessary to revise the system. Please consult your supplier.

## 15. DISPOSAL REQUIREMENTS

Dismantling of the unit, treatment of the refrigerant, of oil and of other parts must be done in accordance with relevant local and national legislation.

## NOTES

# NOTES



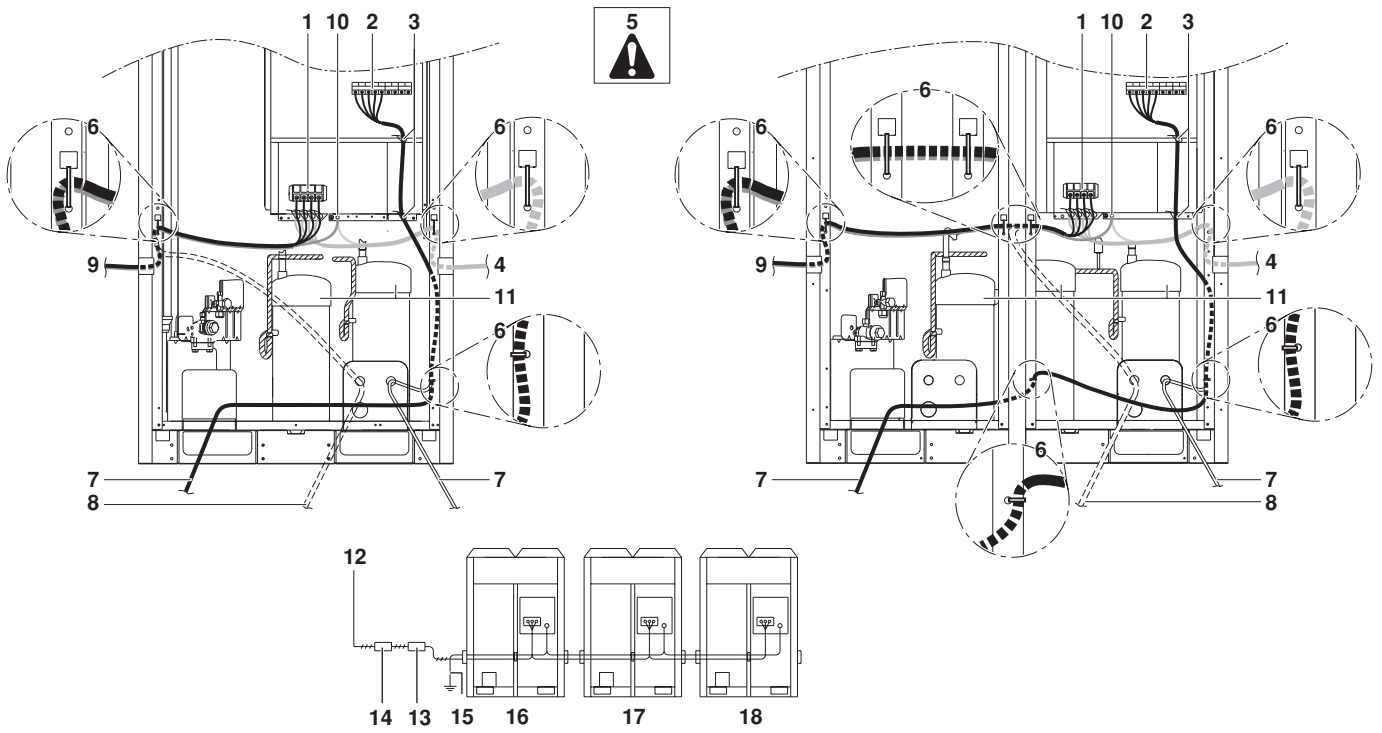

26

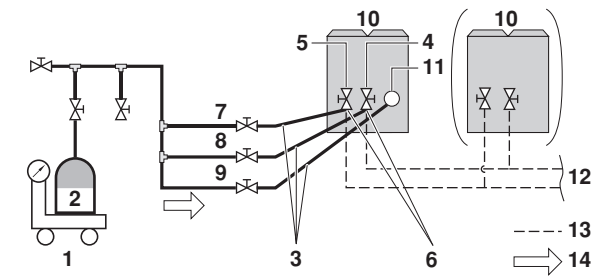
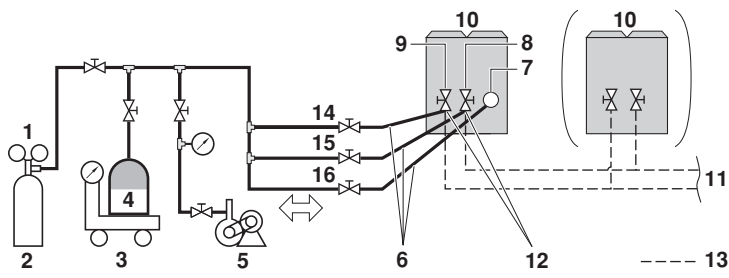

27

28

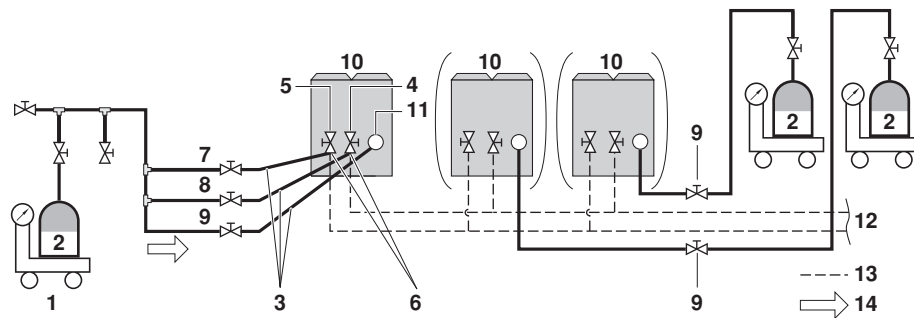

29

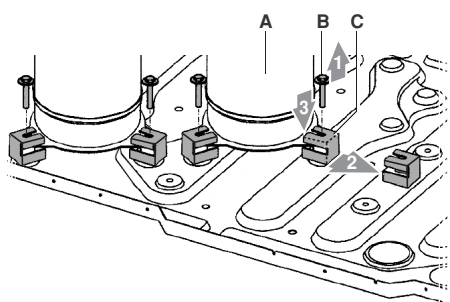

30



\*4PW48461-1 000000A\*

Copyright © Daikin

**DAIKIN EUROPE N.V.**

Zandvoordestraat 300, B-8400 Oostende, Belgium

4PW48461-1