



INSTALLATION MANUAL

VRV III System air conditioner

RXQ5P7W1B
RXQ8P7W1B
RXQ10P7W1B
RXQ12P7W1B
RXQ14P7W1B
RXQ16P7W1B
RXQ18P7W1B

RXYQ5P7W1B
RXYQ8P7W1B
RXYQ10P7W1B
RXYQ12P7W1B
RXYQ14P7W1B
RXYQ16P7W1B
RXYQ18P7W1B

Installation manual
VRV III System air conditioner

English

Installation manual
VRV III System air conditioner

Deutsch

Installation manual
VRV III System air conditioner

Français

Installation manual
VRV III System air conditioner

Nederlands

Installation manual
VRV III System air conditioner

Español

Installation manual
VRV III System air conditioner

Italiano

Εγχειρίδιο εγκατάστασης
Σύστημα Κλιματισμού VRV III

Ελληνικά

Installation manual
VRV III System air conditioner

Portugues

Инструкция по монтажу
Система кондиционирования VRV III

русский

Installation manual
VRV III System air conditioner

Türkçe

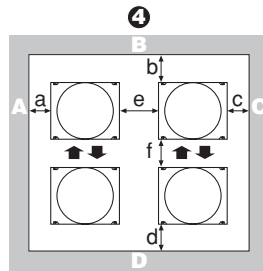
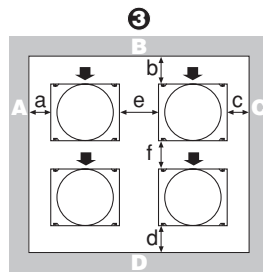
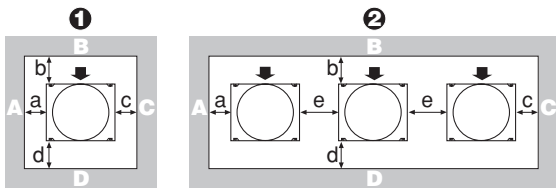

	A+B+C+D		A+B
①	a ≥ 10 mm b ≥ 300 mm c ≥ 10 mm d ≥ 500 mm	a ≥ 50 mm b ≥ 100 mm c ≥ 50 mm d ≥ 500 mm	a ≥ 200 mm b ≥ 300 mm
②	a ≥ 10 mm b ≥ 300 mm c ≥ 10 mm d ≥ 500 mm e ≥ 20 mm	a ≥ 50 mm b ≥ 100 mm c ≥ 50 mm d ≥ 500 mm e ≥ 100 mm	a ≥ 200 mm b ≥ 300 mm e ≥ 400 mm
③	a ≥ 10 mm b ≥ 300 mm c ≥ 10 mm d ≥ 500 mm e ≥ 20 mm f ≥ 600 mm	a ≥ 50 mm b ≥ 100 mm c ≥ 50 mm d ≥ 500 mm e ≥ 100 mm f ≥ 500 mm	
④	a ≥ 10 mm b ≥ 300 mm c ≥ 10 mm d ≥ 300 mm e ≥ 20 mm f ≥ 500 mm	a ≥ 50 mm b ≥ 100 mm c ≥ 50 mm d ≥ 100 mm e ≥ 100 mm f ≥ 500 mm	

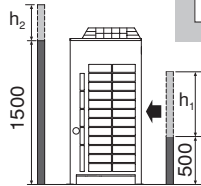

$$h_1 > 0 \rightarrow b \geq b + \frac{h_1}{2}$$

$$h_2 > 0 \rightarrow d \geq d + \frac{h_2}{2}$$

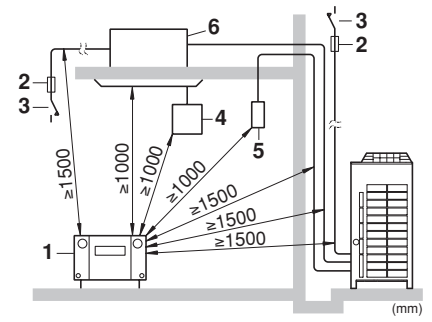

2

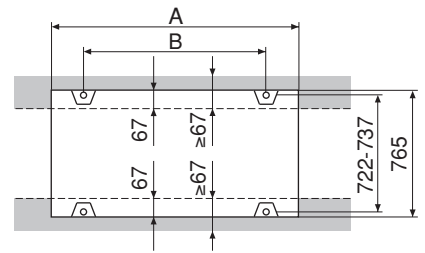

1

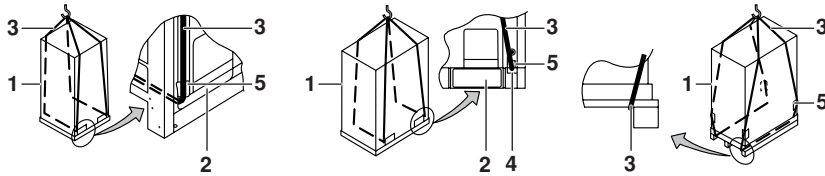

3



4

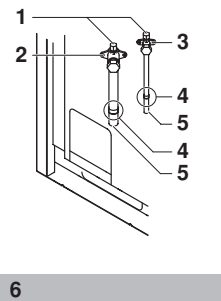
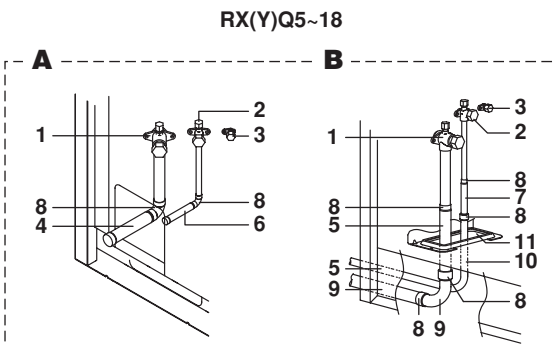

5

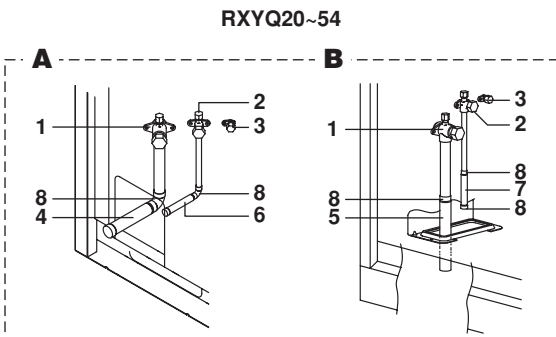
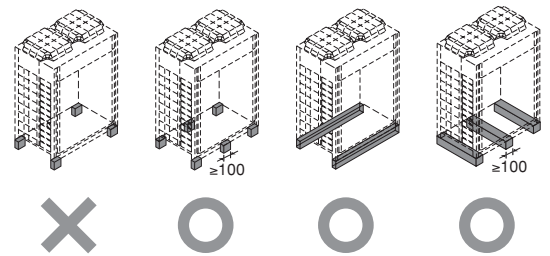

8

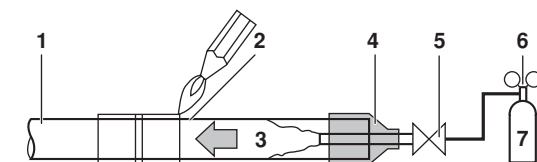

10

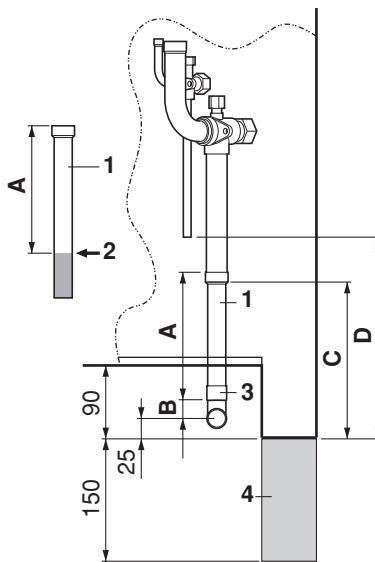

11

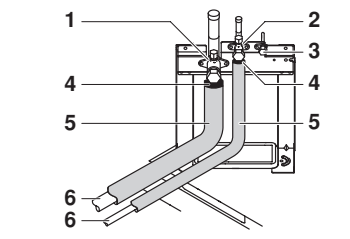

9

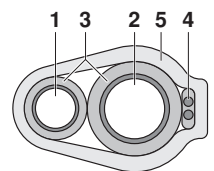

12

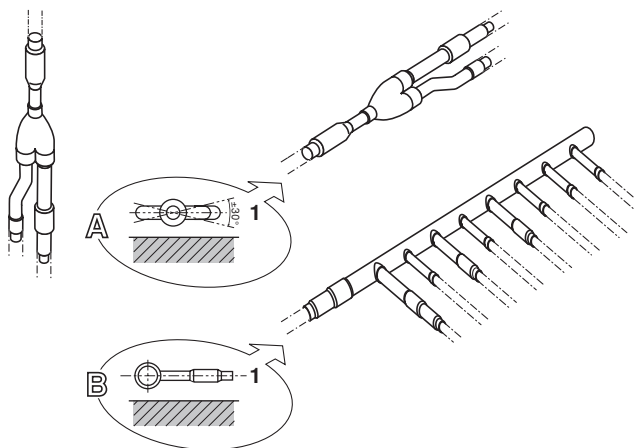

13

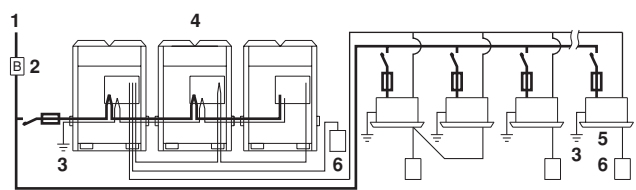

15

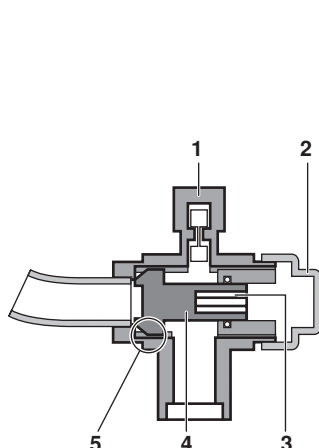

14

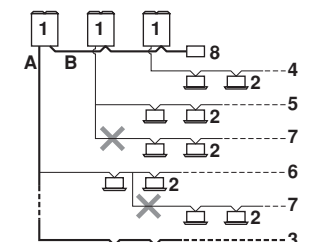

16

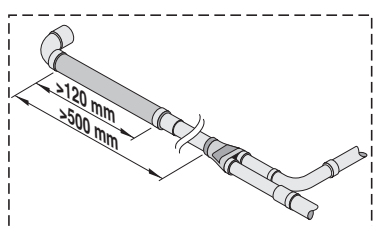
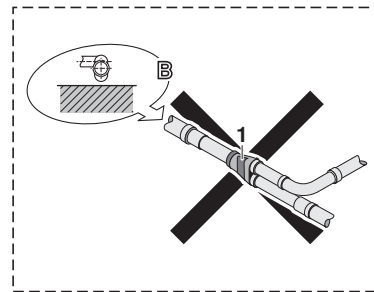
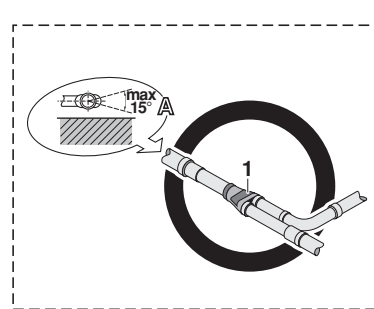

17

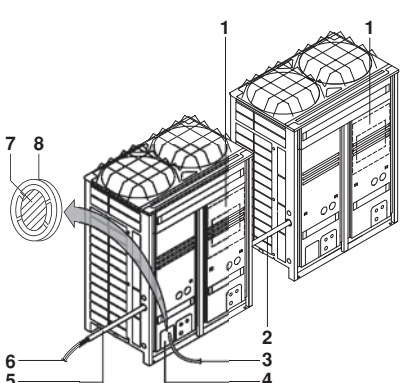

18

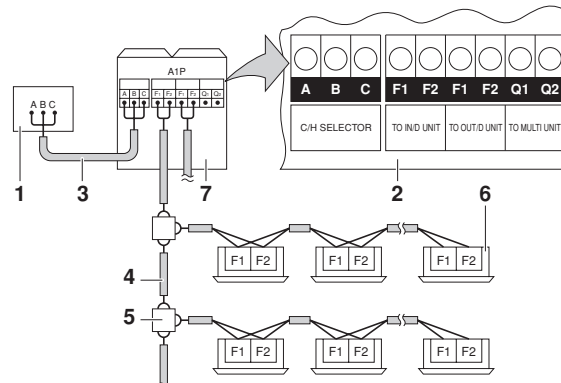

19

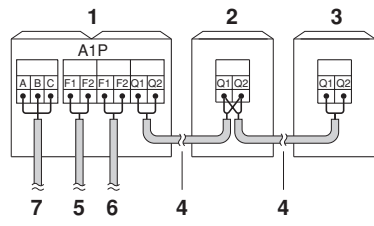

20

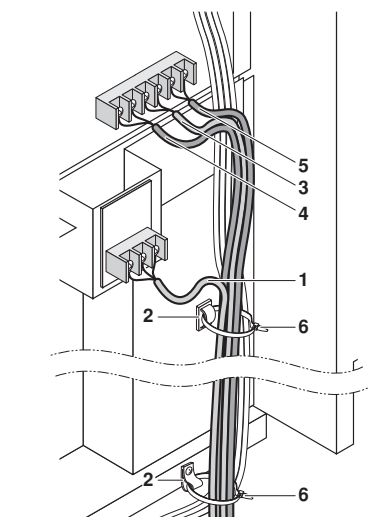

23

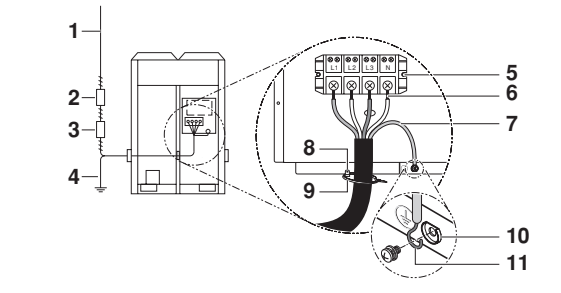

21

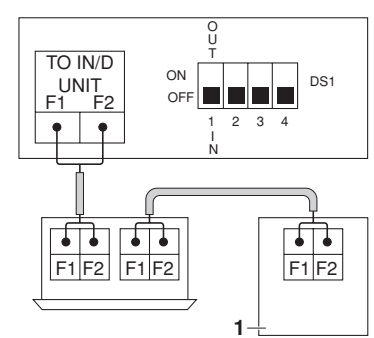

22

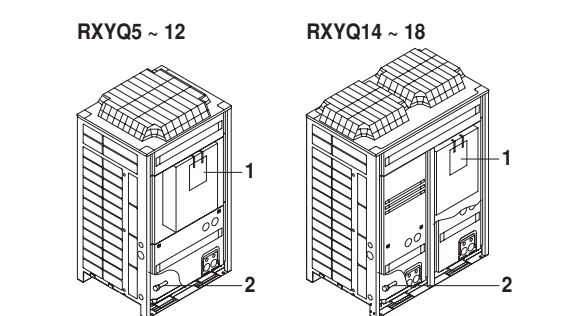

24

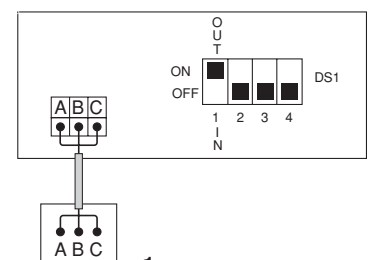

25

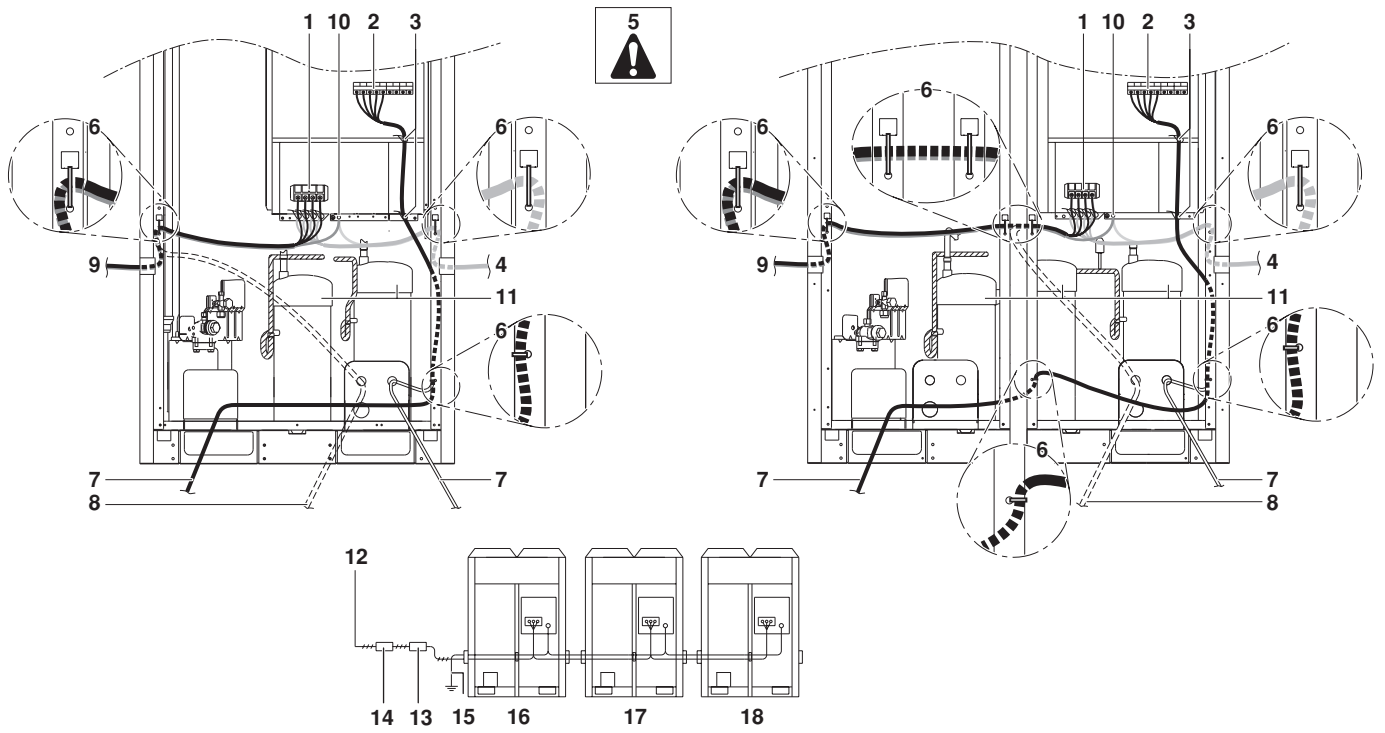

26

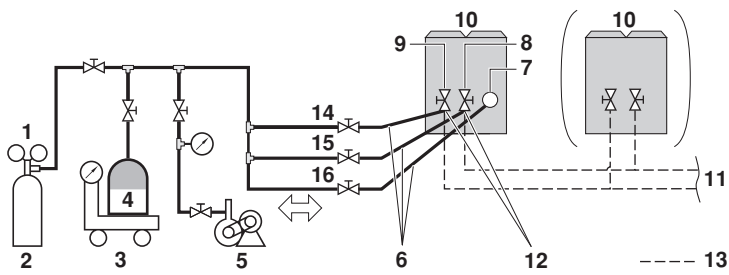

27

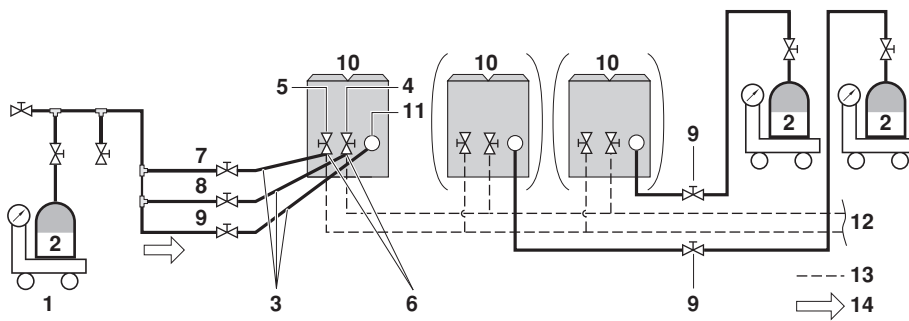

28

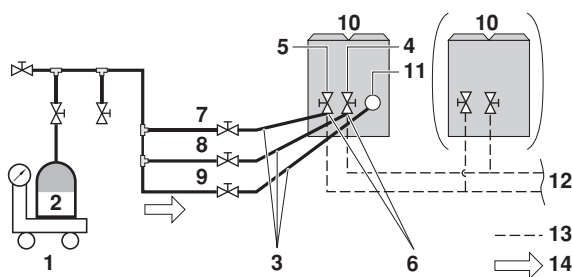

29

CONTENTS

	Page
1. Introduction.....	1
1.1. Combination.....	1
1.2. Standard supplied accessories.....	2
1.3. Optional accessories.....	2
1.4. Technical and Electrical specifications.....	2
2. Main components.....	2
3. Selection of location.....	3
4. Inspecting and handling the unit.....	4
5. Unpacking and placing the unit.....	4
6. Refrigerant piping.....	4
6.1. Installation tools.....	5
6.2. Selection of piping material.....	5
6.3. Pipe connection.....	5
6.4. Connecting the refrigerant piping.....	5
6.5. Protection against contamination when installing pipes.....	7
6.6. Example of connection.....	8
7. Leak test and vacuum drying.....	10
8. Field wiring.....	10
8.1. Internal wiring – Parts table.....	11
8.2. Optional parts cool/heat selector.....	11
8.3. Power circuit and cable requirements.....	12
8.4. General cautions.....	12
8.5. System examples.....	13
8.6. Leading power line and transmission line.....	13
8.7. Field line connection: transmission wiring and cool/heat selection.....	13
8.8. Field line connection: power wiring.....	14
8.9. Wiring example for wiring inside unit.....	15
9. Pipe insulation.....	15
10. Checking of unit and installation conditions.....	15
11. Charging refrigerant.....	16
11.1. Stop valve operation procedure.....	16
11.2. Additional refrigerant charge.....	16
12. Before operation.....	19
12.1. Service precautions.....	19
12.2. Checks before initial start-up.....	19
12.3. Field setting.....	19
12.4. Test operation.....	22
12.5. Temperature adjustment operation confirmation.....	22
13. Service mode operation.....	23
14. Caution for refrigerant leaks.....	23
15. Disposal requirements.....	24
Annex I.....	24
Annex II.....	25



The refrigerant R410A requires strict cautions for keeping the system clean, dry and tight.

- Clean and dry
Foreign materials (including mineral oils such as SUNISO oil or moisture) should be prevented from getting mixed into the system.
- Tight
R410A does not contain any chlorine, does not destroy the ozone layer, and does not reduce the earth's protection against harmful ultraviolet radiation. R410A can contribute slightly to the greenhouse effect if it is released. Therefore we should take special attention to check the tightness of the installation.

Read "6. Refrigerant piping" on page 4 carefully and follow these procedures correctly.



Since design pressure is 4.0 MPa or 40 bar (for R407C units: 3.3 MPa or 33 bar), pipes of larger wall thickness may be required. The wall thickness of piping must be carefully selected, refer to paragraph "6.2. Selection of piping material" on page 5 for more details.

1. INTRODUCTION

This installation manual concerns VRV inverters of the Daikin RX(Y)Q-P7 series. These units are designed for outdoor installation and used for cooling and heatpump applications. The RXQ-P7 cooling only series consist of 7 main stand-alone units and has nominal cooling capacities ranging from 14.0 to 49.0 kW. The RXYQ-P7 series can be combined from 7 main units and has nominal cooling capacities ranging from 14.0 to 147 kW and nominal heating capacities ranging from 16.0 to 170 kW.

The RX(Y)Q-P7 units can be combined with Daikin VRV indoor units for air conditioning purposes, and suitable for R410A.

The present installation manual describes the procedures for unpacking, installing and connecting the RX(Y)Q-P7 units. Installation of the indoor units is not described in this manual. Always refer to the installation manual supplied with these units for their installation.

1.1. Combination

The indoor units can be installed in the following range.

- Always use appropriate indoor units compatible with R410A. To learn which models of indoor units are compatible with R410A, refer to the product catalogs.
- Pay attention when connecting outdoor units in multi combination. RXYQ-M units are NOT compatible with RXYQ-P units.



READ THIS MANUAL ATTENTIVELY BEFORE STARTING UP THE UNIT. DO NOT THROW IT AWAY. KEEP IT IN YOUR FILES FOR FUTURE REFERENCE.

IMPROPER INSTALLATION OR ATTACHMENT OF EQUIPMENT OR ACCESSORIES COULD RESULT IN ELECTRIC SHOCK, SHORT-CIRCUIT, LEAKS, FIRE OR OTHER DAMAGE TO THE EQUIPMENT. BE SURE ONLY TO USE ACCESSORIES MADE BY DAIKIN WHICH ARE SPECIFICALLY DESIGNED FOR USE WITH THE EQUIPMENT AND HAVE THEM INSTALLED BY A PROFESSIONAL.

DAIKIN EQUIPMENT IS DESIGNED FOR COMFORT APPLICATIONS. FOR USE IN OTHER APPLICATIONS, PLEASE CONTACT YOUR LOCAL DAIKIN DEALER.

IF UNSURE OF INSTALLATION PROCEDURES OR USE, ALWAYS CONTACT YOUR DEALER FOR ADVICE AND INFORMATION.

THIS AIR CONDITIONER COMES UNDER THE TERM "APPLIANCES NOT ACCESSIBLE TO THE GENERAL PUBLIC".

■ Total capacity/quantity of indoor units

Standard combination of outdoor units	Total capacity of indoor units (kW)	Total quantity of indoor units
RX(Y)Q5 (*)	62.5~250	12
RX(Y)Q8 (*)	100~400	20
RX(Y)Q10 (*)	125~500	25
RX(Y)Q12 (*)	150~600	30
RX(Y)Q14 (*)	175~700	35
RX(Y)Q16 (*)	200~800	40
RX(Y)Q18 (*)	225~900	45
RXYQ20 = RXYQ8 + RXYQ12	250~800	40
RXYQ22 = RXYQ10 + RXYQ12	275~880	44
RXYQ24 = RXYQ12 + RXYQ12	300~960	48
RXYQ26 = RXYQ8 + RXYQ18	325~1040	52
RXYQ28 = RXYQ10 + RXYQ18	350~1120	56
RXYQ30 = RXYQ12 + RXYQ18	375~1200	60
RXYQ32 = RXYQ14 + RXYQ18	400~1280	64
RXYQ34 = RXYQ16 + RXYQ18	425~1360	64
RXYQ36 = RXYQ18 + RXYQ18	450~1440	64
RXYQ38 = RXYQ8 + RXYQ12 + RXYQ18	475~1235	61
RXYQ40 = RXYQ10 + RXYQ12 + RXYQ18	500~1300	64
RXYQ42 = RXYQ12 + RXYQ12 + RXYQ18	525~1365	64
RXYQ44 = RXYQ8 + RXYQ18 + RXYQ18	550~1430	64
RXYQ46 = RXYQ10 + RXYQ18 + RXYQ18	575~1495	64
RXYQ48 = RXYQ12 + RXYQ18 + RXYQ18	600~1560	64
RXYQ50 = RXYQ14 + RXYQ18 + RXYQ18	625~1625	64
RXYQ52 = RXYQ16 + RXYQ18 + RXYQ18	650~1690	64
RXYQ54 = RXYQ18 + RXYQ18 + RXYQ18	675~1755	64

(*) = main unit

NOTE



- The table above shows the possible total capacity and number of possible indoor units when configured in a standard combination. Refer to the service manual for more details when using a configuration other than a standard combination.
- If the total capacity of the connected indoor units exceeds the capacity of the outdoor unit, cooling and heating performance may drop when running the indoor units. Refer to the section on performance characteristics in the Engineering Data Book for details.
- There are restrictions on the refrigerant pipe connection order between outdoor units during installation in case of a multiple outdoor unit system. Install according to the following restrictions. The capacities of outdoor units A, B, and C must fulfill the following restriction conditions: $A \geq B \geq C$.

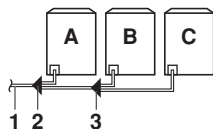

- 1 To indoor units
- 2 Outdoor unit multi connection piping kit (first branch)
- 3 Outdoor unit multi connection piping kit (second branch)

1.2. Standard supplied accessories

See location 1 in figure 24 for reference to where following accessories are supplied with the unit.

Installation manual	1
Operation manual	1
Additional refrigerant charge label	1

See location 2 in figure 24 for reference to where following accessories are supplied with the unit.

Gas side accessory pipe		
Unit type	Item	Quantity
5~18 Hp		1
5~10 Hp		1
12~18 Hp		1
Liquid side accessory pipe		
Unit type	Item	Quantity
5~18 Hp		1
5~10, 14, 16 Hp		1
12, 18 Hp		1

1.3. Optional accessories

To install the above outdoor units, the following optional parts are also required.

- Refrigerant branching kit (for R410A only: Always use an appropriate kit dedicated for your system.)

Refnet header	Refnet joint
KHRQ22M29H	KHRQ22M20T
KHRQ22M64H	KHRQ22M29T
KHRQ22M75H	KHRQ22M64T
	KHRQ22M75T

- Outdoor unit multi connection piping kit (For R410A only: Always use an appropriate kit dedicated for your system.)

Number of outdoor units connected	
2	3
BHFQ22P100	BHFQ22P151

- Pipe size reducer (For R410A only: Always use an appropriate kit dedicated for your system.)

RXYQ24~54	
KHRQ22M75T	KHRQ22M75H

To select an optimum refrigerant branching kit, refer to "6. Refrigerant piping" on page 4.

1.4. Technical and Electrical specifications

Refer to the Engineering Data Book for the complete list of specifications.

2. MAIN COMPONENTS

For main components and function of the main components, refer to the Engineering Data Book.

3. SELECTION OF LOCATION

This is a class A product. In a domestic environment this product may cause radio interference in which case the user may be required to take adequate measures.

This unit, both indoor and outdoor, is suitable for installation in a commercial and light industrial environment. If installed as a household appliance it could cause electromagnetic interference.



- Make sure to provide for adequate measures in order to prevent that the outdoor unit be used as a shelter by small animals.
- Small animals making contact with electrical parts can cause malfunctions, smoke or fire. Please instruct the customer to keep the area around the unit clean.

Get the customer's permission before installing.

The inverter units should be installed in a location that meets the following requirements:

- 1 The foundation is strong enough to support the weight of the unit and the floor is flat to prevent vibration and noise generation.



If not, the unit may fall over and cause damage or injury.

- 2 The space around the unit is adequate for servicing and the minimum space for air inlet and air outlet is available. (Refer to [figure 1](#) and choose one of the possibilities).

A B C D Sides along the installation site with obstacles
➔ Suction side

- In case of an installation site where sides **A+B+C+D** have obstacles, the wall heights of sides **A+C** have no impact on service space dimensions. Refer to [figure 1](#) for impact of wall heights of sides **B+D** on service space dimensions.
- In case of an installation site where only the sides **A+B** have obstacles, the wall heights have no influence on any indicated service space dimensions.

NOTE The service space dimensions in [figure 1](#) are based on cooling operation at 35°C.



- 3 Make sure that there is no danger of fire due to leakage of inflammable gas.
- 4 Ensure that water cannot cause any damage to the location in case it drips out the unit (e.g. in case of a blocked drain pipe).
- 5 The piping length between the outdoor unit and the indoor unit may not exceed the allowable piping length. (Refer to "6.6. Example of connection" on page 8)
- 6 Select the location of the unit in such a way that neither the discharged air nor the sound generated by the unit disturbs anyone.
- 7 Make sure that the air inlet and outlet of the unit are not positioned towards the main wind direction. Frontal wind will disturb the operation of the unit. If necessary, use a windscreen to block the wind.
- 8 Do not install or operate the unit on locations where air contains high levels of salt, like e.g. in the vicinity of oceans. (Refer for further information to the engineering databook).
- 9 During installation, avoid the possibility that anybody can climb on the unit or place objects on the unit.
Falls may result in injury.
- 10 When installing the unit in a small room, take measures in order to keep the refrigerant concentration from exceeding allowable safety limits in the event of a refrigerant leak.



Excessive refrigerant concentrations in a closed room can lead to oxygen deficiency.



- The equipment described in this manual may cause electronic noise generated from radio-frequency energy. The equipment complies to specifications that are designed to provide reasonable protection against such interference. However, there is no guarantee that interference will not occur in a particular installation. It is therefore recommended to install the equipment and electric wires keeping proper distances away from stereo equipment, personal computers, etc... (See [figure 2](#)).

- 1 Personal computer or radio
- 2 Fuse
- 3 Earth leakage breaker
- 4 Remote controller
- 5 Cool/heat selector
- 6 Indoor unit



In places with weak reception, keep distances of 3 m or more to avoid electro-magnetic disturbance of other equipment and use conduit tubes for power and transmission lines.

- In heavy snowfall areas, select an installation site where snow will not affect the operation of the unit.
- The refrigerant R410A itself is nontoxic, nonflammable and is safe. If the refrigerant should leak however, its concentration may exceed the allowable limit depending on room size. Due to this, it could be necessary to take measures against leakage. Refer to the chapter "14. Caution for refrigerant leaks" on page 23.
- Do not install in the following locations.
 - Locations where sulfurous acids and other corrosive gases may be present in the atmosphere. Copper piping and soldered joints may corrode, causing refrigerant to leak.
 - Locations where a mineral oil mist, spray or vapour may be present in the atmosphere. Plastic parts may deteriorate and fall off or causing water leakage.
 - Locations where equipment that produces electromagnetic waves is found. The electromagnetic waves may cause the control system to malfunction, preventing normal operation.
 - Locations where flammable gases may leak, where thinner, gasoline, and other volatile substances are handled, or where carbon dust and other incendiary substances are found in the atmosphere. Leaked gas may accumulate around the unit, causing an explosion.
- When installing, take strong winds, typhoons or earthquakes into account. Improper installation may result in fall over of the unit.

4. INSPECTING AND HANDLING THE UNIT

At delivery, the package should be checked and any damage should be reported immediately to the carrier claims agent.

When handling the unit, take into account the following:

- 1  Fragile, handle the unit with care.
- 1  Keep the unit upright in order to avoid compressor damage.
- 2 Choose on beforehand the path along which the unit is to be brought in.
- 3 Bring the unit as close as possible to its final installation position in its original package to prevent damage during transport. (See figure 4)
 - 1 Packaging material
 - 2 Opening (large)
 - 3 Belt sling
 - 4 Opening (small)(40x45)
 - 5 Protector
- 4 Lift the unit preferably with a crane and 2 belts of at least 8 m long. (See figure 4)

Always use protectors to prevent belt damage and pay attention to the position of the unit's centre of gravity.

NOTE  Use a belt sling of ≤ 20 mm wide that adequately bears the weight of the unit.

- 5 If a forklift is to be used, preferably transport the unit with pallet first, then pass the forklift arms through the large rectangular openings on the bottom of the unit. (See figure 5)
 - 5.1 From the moment you use a forklift to move the unit to its final position, lift the unit under the pallet.
 - 5.2 Once at final position, unpack the the unit and pass the forklift arms through the large rectangular openings on the bottom of the unit.

NOTE  Use filler cloth on the forklift arms to prevent damaging the unit. If the paint on the bottom frame peels off, the anti corrosion effect may decrease.

5. UNPACKING AND PLACING THE UNIT

- Remove the four screws fixing the unit to the pallet.
- Make sure the unit is installed level on a sufficiently strong base to prevent vibration and noise.

 Do not use stands to only support the corners. (See figure 7)

- X Not allowed (except for RX(Y)Q5)
- O Allowed (units: mm)

- Make sure the base under the unit is larger than the 765 mm of the unit depth. (See figure 3)
- The height of the foundation must at least be 150 mm from the floor.
- The unit must be installed on a solid longitudinal foundation (steelbeam frame or concrete) as indicated in figure 3.

Model	A	B
RX(Y)Q5	635	497
RX(Y)Q8+10	930	792
RX(Y)Q12~18	1240	1102

- Support the unit with a foundation of 67 mm wide or more. (The support leg of the unit is 67 mm wide, see figure 3).

- Fasten the unit in place using four foundation bolts M12. It is best to screw in the foundation bolts until their length remains 20 mm above the foundation surface.

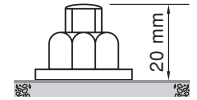

- Prepare a water drainage channel around the foundation to drain waste water from around the unit.
- If the unit is to be installed on a roof, check the strength of the roof and its drainage facilities first.
- If the unit is to be installed on a frame, install the waterproofing board within a distance of 150 mm under the unit in order to prevent infiltration of water coming from under the unit.
- When installed in a corrosive environment, use a nut with plastic washer (1) to protect the nut tightening part from rust.

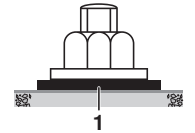

6. REFRIGERANT PIPING



Do not insert fingers, rods or other objects into the air inlet or outlet. When the fan is rotating at high speed, it will cause injury.



Use R410A to add refrigerant.

All field piping must be installed by a licensed refrigeration technician and must comply with relevant local and national regulations.

Caution to be taken when brazing refrigerant piping

Do not use flux when brazing copper-to-copper refrigerant piping. (Particularly for the HFC refrigerant piping) Therefore, use the phosphor copper brazing filler metal (BCuP) which does not require flux.

Flux has extremely harmful influence on refrigerant piping systems. For instance, if the chlorine based flux is used, it will cause pipe corrosion or, in particular, if the flux contains fluorine, it will damage the refrigerant oil.

Be sure to perform a nitrogen blow when brazing. Brazing without performing nitrogen replacement or releasing nitrogen into the piping will create large quantities of oxidised film on the inside of the pipes, adversely affecting valves and compressors in the refrigerating system and preventing normal operation.

After completing the installation work, check that the refrigerant gas does not leak.

Toxic gas may be produced if the refrigerant gas leaks into the room and comes in contact with a source of fire.

Ventilate the area immediately in the event of a leak.

In the event of a leak, do not touch the leaked refrigerant directly. Frostbite may be caused.

6.1. Installation tools

Make sure to use installation tools (gauge manifold charge hose, etc.) that are exclusively used for R410A installations to withstand the pressure and to prevent foreign materials (e.g. mineral oils such as SUNISO and moisture) from mixing into the system.
(The screw specifications differ for R410A and R407C.)

Use a 2-stage vacuum pump with a non-return valve which can evacuate to -100.7 kPa (5 Torr, -755 mm Hg).

NOTE  Make sure the pump oil does not flow oppositely into the system while the pump is not working.

6.2. Selection of piping material

- Foreign materials inside pipes (including oils for fabrication) must be 30 mg/10 m or less.
- Use the following material specification for refrigerant piping:
 - Size: determine the proper size referring to chapter "6.6. Example of connection" on page 8.
 - Construction material: phosphoric acid deoxidized seamless copper for refrigerant.
 - Temper grade: use piping with temper grade in function of the pipe diameter as listed in the table below.

Pipe Ø	Temper grade of piping material
≤ 15.9	O
≥ 19.1	1/2H

O = Annealed
1/2H = Half hard

- The pipe thickness of the refrigerant piping should comply with relevant local and national regulations. The minimal pipe thickness for R410A piping must be in accordance with the table below.

Pipe Ø	Minimal thickness t (mm)
6.4	0.80
9.5	0.80
12.7	0.80
15.9	0.99
19.1	0.80

Pipe Ø	Minimal thickness t (mm)
22.2	0.80
28.6	0.99
34.9	1.21
41.3	1.43

- Make sure to use the particular branches of piping that have been selected referring to chapter "6.6. Example of connection" on page 8.
- In case the required pipe sizes (inch sizes) are not available, it is also allowed to use other diameters (mm sizes), taken the following into account:
 - select the pipe size nearest to the required size.
 - use the suitable adapters for the change-over from inch to mm pipes (field supply).
- Precautions when selecting branch piping
When the equivalent pipe length between outdoor and indoor units is 90 m or more, the size of the main pipes (both gas side and liquid side) must be increased.
Depending on the length of the piping, the capacity may drop, but even in such a case it is possible to increase the size of the main pipes. Refer to "Increasing the pipe length" on page 9.
If the recommended pipe size is not available, stick to the original pipe diameter (which may result in a small capacity decrease).

6.3. Pipe connection

Be sure to perform a nitrogen blow when brazing and to read the paragraph "Caution to be taken when brazing refrigerant piping" on page 4 first.

NOTE  The pressure regulator for the nitrogen released when doing the brazing should be set to 0.02 MPa or less. (See figure 10)

- Refrigerant piping
- Location to be brazed
- Nitrogen
- Taping
- Manual valve
- Regulator
- Nitrogen



Do not use anti-oxidants when brazing the pipe joints.
Residue can clog pipes and break equipment.

6.4. Connecting the refrigerant piping

1 Front connection or side connection

Installation of refrigerant piping is possible as front connection or side connection (when taken out from the bottom) as shown in the figure.

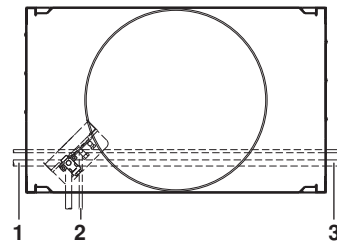

- Left-side connection
- Front connection
- Right-side connection

NOTE Precautions when knocking out knock holes



- Be sure to avoid damaging the casing
- After knocking out the holes, we recommend you remove the burrs and paint the edges and areas around the edges using the repair paint to prevent rusting.
- When passing electrical wiring through the knock holes, wrap the wiring with protective tape to prevent damage.

2 Removing the pinched piping

When connecting refrigerant piping to the outdoor unit, first remove the pinched piping.

Removing of the pinched piping must be carried out according to the following procedure:

1. Connect a charge hose to the service port of the liquid side stop valve and to the service port of the gas side stop valve.
2. Remove the gas from the pinched piping.
3. When all the gas is removed from the pinched piping, dissolve the brazing using a burner and remove the pinched piping.



Any gas remaining inside the stop valve may blow off the pinched piping, causing damage or injury.

See figure 6.

- 1 Service port
- 2 Gas side stop valve
- 3 Liquid side stop valve
- 4 Point of melting the brazing metal
- 5 Pinched piping



Precautions when connecting field piping.

- Perform brazing at the gas stop valve before brazing at the liquid stop valve.
- Add brazing material as shown in the figure.

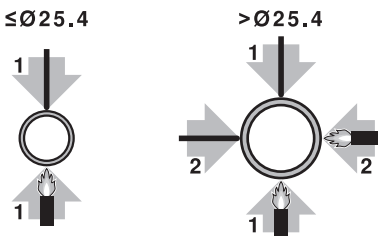

- Be sure to use the supplied accessory pipes when carrying out piping work in the field.
- Be sure that the field installed piping does not touch other pipes, the bottom panel or side panel. Especially for the bottom and side connection, be sure to protect the piping with suitable insulation, to prevent it from coming into contact with the casing.

3 One outdoor unit installed: In case of RX(Y)Q5~18

(See figure 8)

- Front connection:
Remove the stop valve cover to connect.
- Bottom connection:
Remove the knock holes on the bottom frame and route the piping under the bottom frame.

- A Front connection
Remove the stop valve cover to connect.
- B Bottom connection:
Remove the knock holes on the bottom frame and route the piping under the bottom frame
- 1 Gas side stop valve
- 2 Liquid side stop valve
- 3 Service port for adding refrigerant
- 4 Gas side accessory pipe (1)
- 5 Gas side accessory pipe (2)
- 6 Liquid side accessory pipe (1)
- 7 Liquid side accessory pipe (2)
- 8 Brazing
- 9 Gas side piping (field supply)
- 10 Liquid side piping (field supply)
- 11 Punch the knockout holes (use a hammer)

- Processing the gas side accessory pipe (2)
Only in case of connecting at lateral side, cut the gas side accessory pipe (2) as shown in figure 11.

- 1 Gas side accessory pipe
- 2 Cutting location
- 3 Gas side piping (field supply)
- 4 Base

Unit type		A	B	C	D
5 HP	(mm)	166	16	199	246
8 HP	(mm)	156	17	188	247
10 HP	(mm)	156	23	192	247
12 HP	(mm)	150	29	192	247
14~18 HP	(mm)	150	29	192	251

NOTE



- When connecting the piping on site, be sure to use the accessory piping.
- Make sure the onsite piping does not come into contact with other piping, the bottom frame or side panels of the unit.

4 Outdoor units installed in a multiple outdoor unit system: RXYQ20~54

- Front connection:
Remove the stop valve cover to connect. (See figure 8)
- Bottom connection:
Remove the knock holes on the bottom frame and route the piping under the bottom frame. (See figure 8)

4.1 Precautions when connecting piping between outdoor units (multiple outdoor unit system)

- The 5 HP unit type cannot be used as an independent unit in a multi system.
- To connect the piping between outdoor units, an optional multi connection piping kit BHFQ22P100/151 is always required. When installing the piping, follow the instructions in the installation manual that comes with the kit.
- Only proceed with piping work after considering the limitations on installing listed here and in the chapter "6.4. Connecting the refrigerant piping" on page 5, always referring to the installation manual delivered with the kit.

4.2 Possible installation patterns and configurations

- The piping between the outdoor units must be routed level or slightly upward to avoid the risk of oil detention into the piping side.

Pattern 1



- 1 To indoor unit

Pattern 2



- 1 To indoor unit

Prohibited patterns : change to pattern 1 or 2.

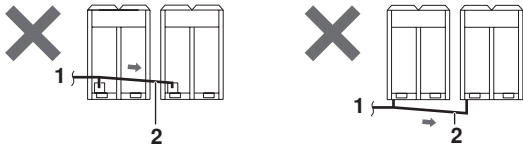

- 1 To indoor unit
- 2 Piping between outdoor units

■ To avoid the risk of oil retention to the outmost outdoor unit, always connect the stop valve and the piping between outdoor units as shown in the 4 correct possibilities of the figure below.

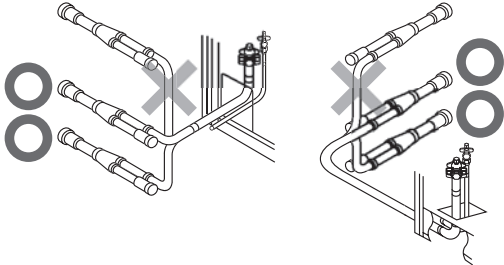

Prohibited patterns change to pattern 1 or 2.

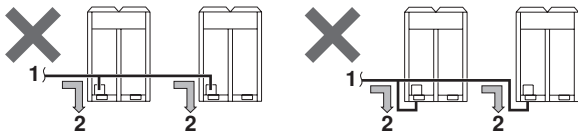

- 1 To indoor unit
- 2 Oil collects to the outmost outdoor unit.

Change to configuration as in figures below

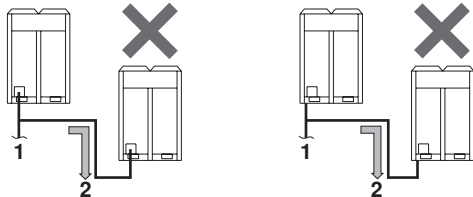

- 1 To indoor unit
- 2 Oil collects to the outmost outdoor unit when the system stops.

Correct configuration

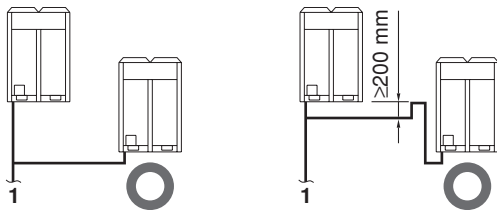

- 1 To indoor unit

■ If the piping length between the outdoor units exceeds 2 m, create a rise of 200 mm or more in the gas line within a length of 2 m from the kit.

- If ≤ 2 m

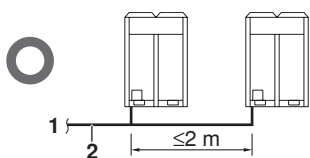

- 1 To indoor unit
- 2 Piping between outdoor units

- If ≥ 2 m

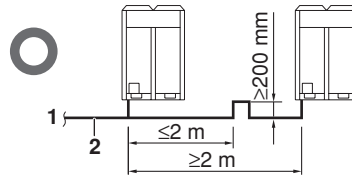

- 1 To indoor unit
- 2 Piping between outdoor units

5 Branching the refrigerant piping

■ For installation of the refrigerant branching kit, refer to the installation manual delivered with the kit.

(See figure 13)

- 1 Horizontal surface

Follow the conditions listed below:

- Mount the refnet joint so that it branches either horizontally or vertically.
- Mount the refnet header so that it branches horizontally.

■ Installation of the multi connection piping kit

(See figure 17)

- Install the joints horizontally, so that the caution label (1) attached to the joint comes to the top. Do not tilt the joint more than 15° (see view A). Do not install the joint vertically (see view B).
- Make sure that the total length of the piping connected to the joint is absolute straight for more than 500 mm. Only if a straight field piping of more than 120 mm is connected, more than 500 mm of straight section can be ensured.
- Improper installation may lead to malfunction of the outdoor unit.

6 Piping length restrictions

Make sure to perform the piping installation within the range of the maximum allowable pipe length, allowable level difference and allowable length after branching as indicated in "6.6. Example of connection" on page 8.

6.5. Protection against contamination when installing pipes

- Take measures to prevent foreign materials like moisture and contamination from mixing into the system.

	Installation period	Protection method
	More than a month	Pinch the pipe
	Less than a month	Pinch or tape the pipe
	Regardless of the period	

- Great caution is needed when passing copper tubes through walls.
- Block all gaps in the holes for passing out piping and wiring using sealing material (field supply). (The capacity of the unit will drop and small animals may enter the machine.)

Example: passing piping out through the front

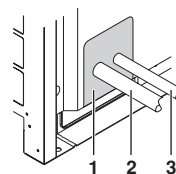

- 1 Plug the areas marked with "■". (When the piping is routed from the front panel.)
- 2 Gas side piping
- 3 Liquid side piping



After all the piping has been connected, make sure there is no gas leak. Use nitrogen to perform a gas leak check.

6.6. Example of connection

Example of connection (Connection of 8 indoor units Heat pump system)		Branch with refnet joint	Branch with refnet joint and refnet header	Branch with refnet header																						
<p>One outdoor unit installed (RX(Y)Q5~18)</p>	<p>Use the outdoor unit multi connection piping kit that is sold separately as an option (BHFQ22P1007+1517) for the multi installation of outdoor units. Selection method is as shown in the right table.</p> <p>Do not use the outdoor unit multi connection piping kit (BHFQ22M009+1359) that are sold separately as an option of the M-type series and do not use T-joints.</p>																									
		<p>Outdoor units installed in a multiple outdoor unit system (RXYQ20~54)</p>																								
<p>Install the joint part (◀ part in the figure) of the outdoor unit multi connection piping kit horizontally with attention to the installation restrictions described in "connecting the refrigerant piping".</p> <p>(*) If the system capacity is RXYQ20 or more, re-read to the first outdoor branch as seen from the indoor unit.</p>	<p>indoor unit</p> <p>refnet joint</p> <p>refnet header</p> <p>outdoor multi connection piping kit</p>	<p>Pipe length between outdoor(*) and indoor units ≤165 m</p> <p>[Example] unit 8: a+b+h≤120 m, unit 8: a+i+k≤165 m [Example] unit 8: a+i≤165 m</p>																								
		<p>Maximum allowable length</p>	<p>Equivalent pipe length between outdoor(*) and indoor units ≤190 m (Assume equivalent pipe length of refnet joint to be 0.5 m and of the refnet header to be 1.0 m. (for calculation purposes))</p> <p>Total piping length from outdoor unit* to all indoor units ≤1000 m</p>																							
<p>Allowable height</p>	<p>Between outdoor branch and outdoor unit (Only for RXYQ20 or more)</p>	<p>Piping length from outdoor branch to outdoor unit ≤10 m. Approximate length: max. 13 m</p>																								
	<p>Between outdoor and indoor units</p>	<p>Difference in height between outdoor and indoor units (H1)≤50 m (≤40 m if outdoor unit is located in a lower position).</p>																								
	<p>Between indoor and indoor units</p>	<p>Difference in height between adjacent indoor units (H2)≤15 m</p>																								
<p>Allowable length after the branch</p>	<p>Between outdoor and outdoor units</p>	<p>Difference in height between outdoor unit (main) and outdoor unit (sub) (H3)≤5 m</p>																								
	<p>Refrigerant branch kit selection</p> <p>Refrigerant branch kits can only be used with R410A.</p>	<p>Pipe length from first refrigerant branch kit (either refnet joint or refnet header) to indoor unit ≤40 m (See note 1 on next page)</p> <p>[Example] unit 8: b+c+d+e+f+g+p≤40 m [Example] unit 6: b+h≤40 m, unit 8: i+k≤40 m</p>																								
<p>Refrigerant branch kit selection</p> <p>Refrigerant branch kits can only be used with R410A.</p>	<p>Outdoor unit capacity type</p> <table border="1"> <tr><td>RX(Y)Q5</td><td>KHRQ22M20T</td></tr> <tr><td>RX(Y)Q8+10</td><td>KHRQ22M29T</td></tr> <tr><td>RX(Y)Q12~18 + RXYQ20~26</td><td>KHRQ22M64T</td></tr> <tr><td>RXYQ28~54</td><td>KHRQ22M75T</td></tr> </table> <p>* For refnet joints other than the first branch, select the proper branch kit model based on the total capacity index.</p>	RX(Y)Q5	KHRQ22M20T	RX(Y)Q8+10	KHRQ22M29T	RX(Y)Q12~18 + RXYQ20~26	KHRQ22M64T	RXYQ28~54	KHRQ22M75T	<p>Refrigerant branch kit name</p> <table border="1"> <tr><td><200</td><td>KHRQ22M20T</td></tr> <tr><td>200-x<290</td><td>KHRQ22M29T</td></tr> <tr><td>290-x<640</td><td>KHRQ22M64T</td></tr> <tr><td>≥640</td><td>KHRQ22M75T</td></tr> </table>	<200	KHRQ22M20T	200-x<290	KHRQ22M29T	290-x<640	KHRQ22M64T	≥640	KHRQ22M75T	<p>Indoor capacity type (kW)</p> <table border="1"> <tr><td><290</td><td>KHRQ22M29H (Max. 8 branch)</td></tr> <tr><td>290-x<640</td><td>KHRQ22M64H (Max. 8 branch)</td></tr> <tr><td>≥640</td><td>KHRQ22M75H (Max. 8 branch)</td></tr> </table>	<290	KHRQ22M29H (Max. 8 branch)	290-x<640	KHRQ22M64H (Max. 8 branch)	≥640	KHRQ22M75H (Max. 8 branch)	<p>How to select the refnet header</p> <ul style="list-style-type: none"> Choose from the following table in accordance with the total capacity of all the indoor units connected below the refnet header. Note: 250 type cannot be connected below the refnet header. <p>How to choose an outdoor multi connection piping kit (needed if the outdoor unit capacity type is RXYQ20 or more.)</p> <ul style="list-style-type: none"> Choose from the following table in accordance with the number of outdoor units.
	RX(Y)Q5	KHRQ22M20T																								
RX(Y)Q8+10	KHRQ22M29T																									
RX(Y)Q12~18 + RXYQ20~26	KHRQ22M64T																									
RXYQ28~54	KHRQ22M75T																									
<200	KHRQ22M20T																									
200-x<290	KHRQ22M29T																									
290-x<640	KHRQ22M64T																									
≥640	KHRQ22M75T																									
<290	KHRQ22M29H (Max. 8 branch)																									
290-x<640	KHRQ22M64H (Max. 8 branch)																									
≥640	KHRQ22M75H (Max. 8 branch)																									
<p>Example of downstream indoor units</p>	<p>[Example] in case of refnet joint C; indoor units 3+4+5+6+7+8</p>	<p>[Example] in case of refnet joint B; indoor units 7+8</p>	<p>[Example] in case of refnet header; indoor units 1+2+3+4+5+6+7+8</p>	<p>[Example] in case of refnet header; indoor units 1+2+3+4+5+6+7+8</p>																						

Pipe size selection
For an outdoor unit multi installation (RX(Y)Q20~54P9W1B), select the pipe size in accordance with the following figure.

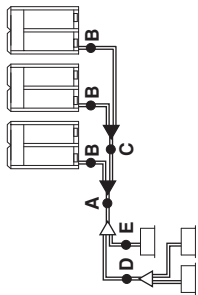

A. Piping between outdoor unit and refrigerant branch kit

- Match to the size of the connection piping on the outdoor unit.
- Outdoor unit connection piping size

Outdoor unit capacity type	Piping size (outer diameter) (mm)	
	Gas pipe	Liquid pipe
RX(Y)Q5	Ø15.9	Ø9.5
RX(Y)Q8	Ø19.1	Ø9.5
RX(Y)Q10	Ø22.2	Ø12.7
RX(Y)Q12~16	Ø28.6	Ø15.9
RX(Y)Q18+	Ø34.9	Ø19.1
RX(Y)Q20+22	Ø34.9	Ø19.1
RX(Y)Q24	Ø41.3	Ø19.1
RX(Y)Q26~34	Ø41.3	Ø19.1
RX(Y)Q36~54	Ø41.3	Ø19.1

D. Piping between refrigerant branch kits

- Choose from the following table in accordance with the total capacity of all the indoor units connected below this.
- Do not let the connection piping exceed the refrigerant piping size chosen by general system model name.

total capacity (kW)	Piping size (outer diameter) (mm)	
	Gas pipe	Liquid pipe
<150	Ø15.9	Ø9.5
150<x<200	Ø19.1	Ø9.5
200<x<290	Ø22.2	Ø12.7
290<x<420	Ø28.6	Ø15.9
420<x<640	Ø34.9	Ø19.1
640<x<920	Ø41.3	Ø19.1
≥920	Ø41.3	Ø19.1

E. Piping between refrigerant branch kit and indoor unit

- Pipe size for direct connection to indoor unit must be the same as the connection size of indoor unit.

Indoor capacity type	Piping size (outer diameter) (mm)	
	Gas pipe	Liquid pipe
20~50	Ø12.7	Ø6.4
80~125	Ø15.9	Ø9.5
200	Ø19.1	Ø9.5
250	Ø22.2	Ø9.5

B. Piping between outdoor branch and outdoor unit

Outdoor capacity type	Piping size (outer diameter) (mm)	
	Gas pipe	Liquid pipe
RX(Y)Q8	Ø19.1	Ø9.5
RX(Y)Q10	Ø22.2	Ø9.5
RX(Y)Q12+14	Ø25.4	Ø12.7
RX(Y)Q16+18	Ø28.6	Ø12.7

When the equivalent pipe length between outdoor and indoor units is 90 m or more, the size of the main pipes (both gas side and liquid side) must be increased.
Depending on the length of the piping, the capacity lay drop, but even in such a case it is possible to increase the size of the main pipes.

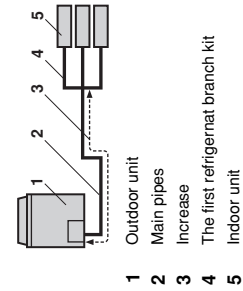

Gas side	Liquid side
RX(Y)Q5	Ø9.5
RX(Y)Q8	Ø9.5 → Ø12.7
RX(Y)Q10	Ø12.7 → Ø15.9
RX(Y)Q12~16	Ø12.7 → Ø15.9
RX(Y)Q18+	Ø15.9 → Ø19.1
RX(Y)Q20~24	Ø15.9 → Ø19.1
RX(Y)Q26~54	Ø19.1 → Ø22.2
— Increase is not allowed	— Increase is not allowed

(*) If not available, increase is not allowed

How to calculate the additional refrigerant to be charged
Additional refrigerant to be charged R (kg)
R should be rounded off in units of 0.1 kg

$$R = \left(\begin{array}{l} \text{Total length (m) of liquid piping size at } \varnothing 19.1 \\ \text{Total length (m) of liquid piping size at } \varnothing 15.9 \end{array} \right) \times 0.26 + \left(\begin{array}{l} \text{Total length (m) of liquid piping size at } \varnothing 12.7 \\ \text{Total length (m) of liquid piping size at } \varnothing 9.5 \end{array} \right) \times 0.059 + \left(\begin{array}{l} \text{Total length (m) of liquid piping size at } \varnothing 9.5 \\ \text{Total length (m) of liquid piping size at } \varnothing 6.4 \end{array} \right) \times 0.022$$

Example for refrigerant branch using refnet joint and refnet header for RX(Y)Q34M9W1B
If the outdoor unit is RX(Y)Q34M9W1B and the piping lengths are as below

a: Ø19.1x30 m	d: Ø9.5x10 m	g: Ø6.4x10 m	j: Ø6.4x10 m
b: Ø15.9x10 m	e: Ø9.5x10 m	h: Ø6.4x20 m	k: Ø6.4x9 m
c: Ø9.5x10 m	f: Ø9.5x10 m	i: Ø12.7x10 m	

$R = [30 \times 0.26] + [10 \times 0.18] + [10 \times 0.12] + [40 \times 0.059] + [9 \times 0.022] = 14.238$
⇒ R = 14.2 kg

Note 1

Allowable length after the first refrigerant branch kit to indoor units is 40 m or less, however it can be extended up to 90 m if all the following conditions are fulfilled.

Required conditions

It is necessary to increase the pipe size between the first branch kit and the final branch kit. (Reducers must be procured on site.) However, if the pipes are of the same pipe size as the main pipe there is no need to increase the pipe size.

For calculation of total extension length, the actual length of above pipes must be doubled, (except main pipe and the pipes that not increase the pipe size)

Indoor unit to the nearest branch kit ≤40 m

The difference between the distance of the outdoor unit to the farthest indoor unit and the distance of the outdoor unit to the nearest indoor unit ≤40 m

Example drawings

indoor unit 8:
b+c+d+e+f+g+p=90 m
increase the pipe size of b, c, d, e, f, g

a+b²+c²+d²+e²+f²+g²+h+h²+j+k+l+m+n+p=1000 m
h, i, j, p≤40 m

The farthest indoor unit 8
The nearest indoor unit 1
(a+b+c+d+e+f+g+p)-(a+h)≤40 m

Increase the pipe size as follows
Ø6.4 → Ø9.5 Ø15.9 → Ø19.1 Ø22.2 → Ø25.4*
Ø9.5 → Ø12.7 Ø19.1 → Ø22.2 Ø28.6 → Ø31.8*
Ø12.7 → Ø15.9 Ø34.9 → Ø38.1*
* If available on the site. Otherwise it can not be increased.

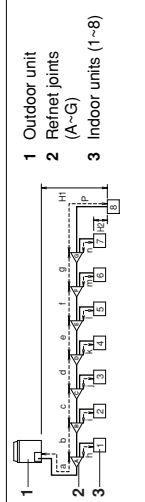

7. LEAK TEST AND VACUUM DRYING

The units were checked for leaks by the manufacturer.

After connecting the field piping, perform the following inspections.

1 Preparations

Referring to figure 27, connect an oxygen tank, a cooling tank, and a vacuum pump to the outdoor unit and perform the airtightness test and the vacuum drying. The stop valve and valves A and B in figure 27 should be open and closed as shown in the table below when performing the airtightness test and vacuum drying.

- 1 Pressure reducing valve
- 2 Nitrogen
- 3 Measuring instrument
- 4 Tank (siphon system)
- 5 Vacuum pump
- 6 Charge hose
- 7 Service port for adding refrigerant
- 8 Gas line stop valve
- 9 Liquid line stop valve
- 10 Outdoor unit
- 11 To indoor unit
- 12 Stop valve service port
- 13 Dotted lines represent on site piping
- 14 Valve B
- 15 Valve C
- 16 Valve A

State of the valves A and B and the stop valve	Valve A	Valve B	Valve C	Liquid side stop valve	Gas side stop valve
Performing the airtightness test and vacuum drying (Valve A must always be shut. Otherwise the refrigerant in the unit will pour out.)	Close	Open	Open	Close	Close

2 Air tightness test and vacuum drying

NOTE



Make sure to perform airtightness test and vacuum drying using the service ports of the stop valves of the liquid side and of the gas side. (For the service port location, refer to the "Caution" label attached on the front panel of the outdoor unit.)

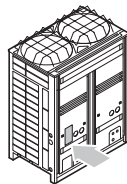

- See "11.1. Stop valve operation procedure" on page 16 for details on handling the stop valve.
- To prevent entry of any contamination and to prevent insufficient pressure resistance, always use the special tools dedicated for working with R410A refrigerant.

■ Air tight test:

NOTE



Make sure to use nitrogen gas.

Pressurize the liquid and gas pipes to 4.0 MPa (40 bar) (do not pressurize more than 4.0 MPa (40 bar)). If the pressure does not drop within 24 hours, the system passes the test. If the pressure drops, check where the nitrogen leaks from.

- Vacuum drying: Use a vacuum pump which can evacuate to -100.7 kPa (5 Torr, -755 mm Hg)

1. Evacuate the system from the liquid and gas pipes by using a vacuum pump for more than 2 hours and bring the system to -100.7 kPa. After keeping the system under that condition for more than 1 hour, check if the vacuum gauge rises or not. If it rises, the system may either contain moisture inside or have leaks.
2. Following should be executed if there is a possibility of moisture remaining inside the pipe (if piping work is carried out during the raining season or over a long period of time, rainwater may enter the pipe during work).
After evacuating the system for 2 hours, pressurize the system to 0.05 MPa (vacuum break) with nitrogen gas and evacuate the system again using the vacuum pump for 1 hour to -100.7 kPa (vacuum drying). If the system cannot be evacuated to -100.7 kPa within 2 hours, repeat the operation of vacuum break and vacuum drying.
Then, after leaving the system in vacuum for 1 hour, confirm that the vacuum gauge does not rise.

8. FIELD WIRING



All field wiring and components must be installed by a licensed electrician and must comply with relevant local and national regulations.

The field wiring must be carried out in accordance with the wiring diagrams and the instructions given below.

Be sure to use a dedicated power circuit. Never use a power supply shared by another appliance. This can lead to electric shock or fire.

Be sure to install an earth leakage circuit breaker.

(Because this unit uses an inverter, install an earth leakage circuit breaker that is capable of handling high harmonics in order to prevent malfunctioning of the earth leakage breaker itself.)

Do not operate until refrigerant piping work is completed. (If operated before completion of the piping work, the compressor may break down.)

Never remove a thermistor, sensor, etc., when connecting power wiring and transmission wiring.

(If operated without thermistor, sensor, etc., the compressor may break down.)

This product's reversed phase protection detector only works when the product started up.

The reversed phase protection detector is designed to stop the product in the event of an abnormalities when the product is started up.

Replace two of the three phases (L1, L2, and L3) during reverse-phase protection circuit operation.

Reversed phase detection is not performed while the product is operating.

If there exists the possibility of reversed phase after a momentary black out and the power goes on and off while the product is operating, attach a reversed phase protection circuit locally. Running the product in reversed phase can break the compressor and other parts.





Means for disconnection must be incorporated in the field wiring in accordance with the wiring rules.

(An all-pole disconnection switch must be available on the unit.)

8.1. Internal wiring – Parts table

Refer to the wiring diagram sticker on the unit. The abbreviations used are listed below:

A1P~7P	Printed circuit board
BS1~5	Push button switch (mode, set, return, test, reset)
C1,C63,C66	Capacitor
DS1,2	Dip switch
E1HC~3HC	Crankcase heater
F1U	Fuse (250 V, 8 A, B)(A4P)(A8P)
F1U,2U	Fuse (250 V, 3.15 A, T)(A1P)
F5U	Field fuse
F400U	Fuse (250 V, 6.3 A, T)(A2P)
H1P~8P	Light emitting diode (service monitor - orange)
HAP	Pilot lamp (service monitor - green)
K1	Magnetic relay
K2	Magnetic contactor (MIC)
K2M,3M	Magnetic contactor (M2C,M3C)
K1R,R	Magnetic relay (K2M,K3M)
K3R~5R	Magnetic relay (Y1S~Y3S)
K6R~9R	Magnetic relay (E1HC~E3HC)
L1R	Reactor
M1C~3C	Motor (compressor)
M1F,2F	Motor (fan)
PS	Switching power supply (A1P,A3P)
Q1DI	Earth leakage breaker (field supply)
Q1RP	Phase reversal detection circuit
R1T	Thermistor (fin) (A2P)
R1T	Thermistor (air) (A1P)
R2T	Thermistor (suction)
R4T	Thermistor (coil-deicer)
R5T	Thermistor (coil-outlet)
R6T	Thermistor (liquid-pipe receiver)
R7T	Thermistor (accumulator)
R10	Resistor (current sensor)(A4P)(A8P)
R31T~33T	Thermistor (discharge)(M1C~M3C)
R50,59	Resistor
R95	Resistor (current limiting)
S1NPH	Pressure sensor (high)
S1NPL	Pressure sensor (low)
S1PH,3PH	Pressure switch (high)
T1A	Current sensor (A6P,A7P)
SD1	Safety devices input
V1R	Power module (A4P,A8P)
V1R,V2R	Power module (A3P)
X1A,X4A	Connector (M1F,M2F)
X1M	Terminal strip (power supply)
X1M	Terminal strip (control)(A1P)
X1M	Terminal strip (A5P)
Y1E,2E	Expansion valve (electronic type) (main, subcool)
Y1S	Solenoid valve (hotgas bypass)
Y2S	Solenoid valve (oil return)
Y3S	Solenoid valve (4 way valve)
Z1C-7C	Noise filter (ferrite core)
Z1F	Noise filter (with surge absorber)

L1,L2,L3	Live
N	Neutral
	Field wiring
	Terminal strip
	Connector
	Terminal
	Protective earth (screw)
BLK	Black
BLU	Blue
BRN	Brown
GRN	Green
GRY	Grey
ORG	Orange
PNK	Pink
RED	Red
WHT	White
YLW	Yellow

NOTE



- (1) This wiring diagram only applies to the outdoor unit.
- (4) When using the option adaptor, refer to the installation manual.
- (5) Refer to the installation manual, for connection wiring to indoor-outdoor transmission F1-F2, outdoor-multi transmission Q1-Q2 and on how to use BS1~BS5 and DS1, DS2 switch.
- (6) Do not operate the unit by short-circuiting protection device S1PH.

8.2. Optional parts cool/heat selector

S1S	Selector switch (fan, cool/heat)
S2S	Selector switch (cool/heat)

NOTE



- Use copper conductors only.
- For connection wiring to the central remote controller, refer to the installation manual of the central remote controller.
- Use insulated wire for the power cord.

8.3. Power circuit and cable requirements

A power circuit (see table below) must be provided for connection of the unit. This circuit must be protected with the required safety devices, i.e. a main switch, a slow blow fuse on each phase and an earth leakage breaker.

	Phase and frequency	Voltage	Minimum circuit ampere	Recommended fuses	Transmission line section
RX(Y)Q5	3 N~50 Hz	400 V	11.9 A	16 A	0.75~1.25 mm ²
RX(Y)Q8	3 N~50 Hz	400 V	18.5 A	32 A	0.75~1.25 mm ²
RX(Y)Q10	3 N~50 Hz	400 V	21.6 A	32 A	0.75~1.25 mm ²
RX(Y)Q12	3 N~50 Hz	400 V	22.7 A	32 A	0.75~1.25 mm ²
RX(Y)Q14	3 N~50 Hz	400 V	31.5 A	50 A	0.75~1.25 mm ²
RX(Y)Q16	3 N~50 Hz	400 V	31.5 A	50 A	0.75~1.25 mm ²
RX(Y)Q18	3 N~50 Hz	400 V	32.5 A	50 A	0.75~1.25 mm ²
RXYQ20	3 N~50 Hz	400 V	41.2 A	63 A	0.75~1.25 mm ²
RXYQ22	3 N~50 Hz	400 V	44.3 A	63 A	0.75~1.25 mm ²
RXYQ24	3 N~50 Hz	400 V	50.4 A	63 A	0.75~1.25 mm ²
RXYQ26	3 N~50 Hz	400 V	51.0 A	63 A	0.75~1.25 mm ²
RXYQ28	3 N~50 Hz	400 V	54.1 A	63 A	0.75~1.25 mm ²
RXYQ30	3 N~50 Hz	400 V	55.2 A	80 A	0.75~1.25 mm ²
RXYQ32	3 N~50 Hz	400 V	63.0 A	80 A	0.75~1.25 mm ²
RXYQ34	3 N~50 Hz	400 V	64.0 A	80 A	0.75~1.25 mm ²
RXYQ36	3 N~50 Hz	400 V	65.0 A	80 A	0.75~1.25 mm ²
RXYQ38	3 N~50 Hz	400 V	73.7 A	100 A	0.75~1.25 mm ²
RXYQ40	3 N~50 Hz	400 V	81.5 A	100 A	0.75~1.25 mm ²
RXYQ42	3 N~50 Hz	400 V	82.5 A	100 A	0.75~1.25 mm ²
RXYQ44	3 N~50 Hz	400 V	83.5 A	100 A	0.75~1.25 mm ²
RXYQ46	3 N~50 Hz	400 V	86.6 A	100 A	0.75~1.25 mm ²
RXYQ48	3 N~50 Hz	400 V	87.7 A	100 A	0.75~1.25 mm ²
RXYQ50	3 N~50 Hz	400 V	96.5 A	125 A	0.75~1.25 mm ²
RXYQ52	3 N~50 Hz	400 V	96.5 A	125 A	0.75~1.25 mm ²
RXYQ54	3 N~50 Hz	400 V	97.5 A	125 A	0.75~1.25 mm ²

NOTE



The above table indicates power specifications for standard combinations. See "1. Introduction" on page 1.

If using anything other than the above combinations in a multi outdoor unit system, calculate using the following procedure.

Calculate the recommended fuse capacity

Calculate, by adding the minimum circuit ampere of each used unit (according to the table above), multiply the result by 1.1 and select the next higher recommended fuse capacity.

Example

Combining the RXYQ30 by using the RXYQ8, RXYQ10, and RXYQ12.

Minimum circuit ampere of the RXYQ8 = 18.5 A

Minimum circuit ampere of the RXYQ10 = 21.6 A

Minimum circuit ampere of the RXYQ12 = 22.7 A

Accordingly, the minimum circuit ampere of the RXYQ30 = 18.5 + 21.6 + 22.7 = 62.8 A

Multiplying the above result by 1.1 (62.8 x 1.1) = 69.08 A, so the recommended fuse capacity would be 80 A.

When using residual current operated circuit breakers, be sure to use a high-speed type 300 mA rated residual operating current.

Be sure to install a main switch for the complete system.

NOTE



- Select the power supply cable in accordance with relevant local and national regulations.
- Wire size must comply with the applicable local and national code.
- Specifications for local wiring power cord and branch wiring are in compliance with IEC60245.
- WIRE TYPE H05VV(*)
*Only in protected pipes (use H07RN-F when protected pipes are not used).

8.4. General cautions

- Up to 3 units can be connected by crossover power source wiring between outdoor units. However, units of smaller capacity must be connected downstream. For details, refer to the technical data.
- When connecting several units in VRV combination, the power supply of each outdoor unit can also be connected separately. Refer to the field wiring on the engineering data book for further details.
- Make sure to connect the power source wire to the power source terminal block and to clamp it as shown in figure 21 and described in chapter "8.8. Field line connection: power wiring" on page 14.
- As this unit is equipped with an inverter, installing a phase advancing capacitor not only will deteriorate power factor improvement effect, but also may cause capacitor abnormal heating accident due to high-frequency waves. Therefore, never install a phase advancing capacitor.
- Keep power imbalance within 2% of the supply rating.
 - Large imbalance will shorten the life of the smoothing capacitor.
 - As a protective measure, the product will stop operating and an error indication will be made, when power imbalance exceeds 4% of the supply rating.
- Follow the "electrical wiring diagram" supplied with the unit when carrying out any electrical wiring.
- Only proceed with wiring work after all power is shut off.
- Always ground wires. (In accordance with national regulations of the pertinent country.)
- Do not connect the ground wire to gas pipes, sewage pipes, lightning rods, or telephone ground wires. This may cause electric shock.
 - Combustion gas pipes: can explode or catch fire if there is a gas leak.
 - Sewage pipes: no grounding effect is possible if hard plastic piping is used.
 - Telephone ground wires and lightning rods: dangerous when struck by lightning due to abnormal rise in electrical potential in the grounding.
- This unit uses an inverter, and therefore generates noise, which will have to be reduced to avoid interfering with other devices. The outer casing of the product may take on an electrical charge due to leaked electrical current, which will have to be discharged with the grounding.
- Be sure to install an earth leakage breaker. (One that can handle high-frequency electrical noise.)
(This unit uses an inverter, which means that an earth leakage breaker capable of handling high-frequency electrical noise must be used in order to prevent malfunctioning of the earth leakage breaker itself.)
- Earth leakage breakers that are especially designed for protecting ground-faults must be used in conjunction with main switch and fuse for use with wiring.
- Never connect the power supply in reversed phase.
The unit can not operate normally in reversed phase. If you connect in reversed phase, replace two of the three phases.
- This unit has a reverse phase detection circuit. (If it is activated, only operate the unit after correcting the wiring.)
- Power supply wires must be attached securely.
- If the power supply has a missing or wrong N-phase, equipment will break down.
- Make sure that all wiring is secure, the specified wires are used, and no external forces act on the terminal connection or wires.
- Improper connections or installation may result in fire.
- When wiring the power supply and connecting the remote controller wiring and transmission wiring, position the wires so that the control box lid can be securely fastened.
Improper positioning of the control box lid may result in electric shocks, fire, or overheating of the terminals.

8.5. System examples

(See figure 15)

- 1 Field power supply
 - 2 Main switch
 - 3 Earth leakage breaker
 - 4 Outdoor unit
 - 5 Indoor unit
 - 6 Remote controller
- Power supply wiring (sheathed cable) (200 V)
- Transmission wiring (sheathed cable) (16 V)

8.6. Leading power line and transmission line

- Be sure to let the power line and the transmission line pass through a conduit hole.
 - Lead the power line from the upper hole on the left side plate, from the front position of the main unit (through the conduit hole of the wiring mounting plate) or from a knock out hole to be made in the unit's bottom plate. (See figure 18)
- 1 Electric wiring diagram. Printed on the back of the electric box lid.
 - 2 Power wiring and ground wiring between outdoor units (inside conduit)
(When the wiring is routed out through the lateral panel.)
 - 3 Transmission wiring
 - 4 Pipe opening
 - 5 Conduit
 - 6 Power wiring and ground wiring
 - 7 Cut off the shaded zones before use.
 - 8 Through cover

Precautions when knocking out knockout holes

- To punch a knockout hole, hit on it with a hammer.
- After knocking out the holes, we recommend you paint the edges and areas around the edges using the repair paint to prevent rusting.
- When passing electrical wiring through the knockout holes, remove any burrs from the knockout holes and wrap the wiring with protective tape to prevent damage.

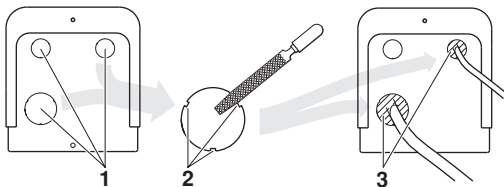

- 1 Knockout hole
- 2 Burr
- 3 If there are any possibilities that small animals enter the system through the knockout holes, plug the holes with packing materials (to be prepared on-site).



- Use a power wire pipe for the power wiring.
- Outside the unit, make sure the weak low voltage electric wiring (i.e. for the remote control, between units, etc.) and the high voltage electric wiring do not pass near each other, keeping them at least 50 mm apart. Proximity may cause electrical interference, malfunctions, and breakage.
- Be sure to connect the power wiring to the power wiring terminal block and secure it as described under "Field line connection: power wiring" on page 14.
- Inter-unit wiring should be secured as described in "8.7. Field line connection: transmission wiring and cool/heat selection" on page 13.
 - Secure the wiring with the accessory clamps so that it does not touch the piping and no external force can be applied to the terminal.
 - Make sure the wiring and the electric box lid do not stick up above the structure, and close the cover firmly.

8.7. Field line connection: transmission wiring and cool/heat selection

In case of RX(Y)Q5~18 (See figure 19)

- 1 Cool/heat selector (not required for cooling only units)
- 2 Outdoor unit PC board (A1P)
- 3 Take care of the polarity (not required for cooling only units)
- 4 Use the conductor of sheathed wire (2 wire) (no polarity)
- 5 Terminal board (field supply)
- 6 Indoor unit
- 7 Outdoor unit

In case of RXYQ20~54 (See figure 20)

- 1 Unit A (Master unit)
- 2 Unit B (Slave unit)
- 3 Unit C (Slave unit)
- 4 To slave unit(s)
- 5 To indoor unit
- 6 To outdoor unit
- 7 To cool/heat selector

NOTE



RXYQ5 cannot install the multi unit transmission wiring. Run will not be successful if the wiring is connected to Q1-Q2 (TO MULTI UNIT) terminal.

- The interconnecting wiring between the outdoor units in the same piping system must be connected to the Q1/Q2 (Out Multi) terminals. Connecting the wires to the F1/F2 (Out-Out) terminals results in system malfunction.
- The wiring for the other systems must be connected to the F1/F2 (Out-Out) terminals of the P-board in the outdoor unit to which the interconnecting wiring for the indoor units is connected.
- The base unit is the outdoor unit to which the interconnecting wiring for the indoor units is connected.

Fixing transmission wiring (See figure 23)

Inside switchbox

- 1 Heating/cooling switching remote control cord (when a heating/cooling switch remote control (optional) is connected) (ABC) (not for RXQ5~18)
- 2 Fix to the indicated plastic brackets using field supplied clamping material.
- 3 Wiring between the units (Outdoor - outdoor) (F1+F2 right)
- 4 Wiring between the units (Indoor - outdoor) (F1+F2 left)
- 5 Wiring for multi connection (only for RXYQ20~54) (Q1+Q2)
- 6 Plastic bracket

Outside unit



- Be sure to follow the limits below. If the unit-to-unit cables are beyond these limits, it may result in malfunction of transmission.

- Maximum wiring length: 1000 m
- Total wiring length: 2000 m
- Maximum interunit wiring length between outdoor units: 30 m
- Transmission wiring to cool/heat selector: 500 m
- Maximum number of branches: 16

- Maximum number of outdoor units connectable: 10.
- Up to 16 branches are possible for unit-to unit cabling. No branching is allowed after branching. (See figure 16)

- 1 Outdoor unit
- 2 Indoor unit
- 3 Main line
- 4 Branch line 1
- 5 Branch line 2
- 6 Branch line 3
- 7 No branch is allowed after branch
- 8 Central remote controller (etc...)
- A Transmission wiring between outdoor unit and indoor unit(s)
- B Transmission wiring between outdoor units

- Never connect the power supply to transmission wiring terminal block. Otherwise the entire system may break down.
- Never connect 400 V to the terminal block of the interconnecting wiring. Doing so will break the entire system.
 - The wiring from the indoor units must be connected to the F1/F2 (In-Out) terminals on the PC board in the outdoor unit.
 - After installing the interconnecting wires inside the unit, wrap them along with the on-site refrigerant pipes using finishing tape, as shown in figure 12.

- 1 Liquid pipe
- 2 Gas pipe
- 3 Insulator
- 4 Interconnecting wiring
- 5 Finishing tape

For the above wiring, always use vinyl cords with 0.75 to 1.25 mm² sheath or cables (2-core wires). (3-core wire cables are allowable for the cooler/heater changeover remote controller only.)



- Be sure to keep the power line and transmission line apart from each other.
- Be careful about polarity of the transmission line.
- Make sure that the transmission line is clamped as shown in figure 23.
- Check that wiring lines do not make contact with refrigerant piping.
- Firmly close the lid and arrange the electrical wires so as to prevent the lid or other parts from coming loose.
- When you do not use a wire conduit, be sure to protect the wires with vinyl tubes etc, to prevent the edge of the knock-out hole from cutting the wires.

Sequential start

The outdoor unit PC board (A1P) is factory set at "Sequential start available".

Setting the cool/heat operation (heat pump unit only)

- 1 Performing cool/heat setting with the remote controller connected to the indoor unit.
Keep the cool/heat selector switch (DS1) on the outdoor unit PC board at the factory setting position IN/D UNIT. (See figure 22)

- 1 Remote controller

- 2 Performing cool/heat setting with the cool/heat selector.
Connect the cool/heat selector remote controller (optional) to the A/B/C terminals and set the cool/heat selector switch (DS1) on the outdoor unit PC board (A1P) to OUT/D UNIT. (See figure 25)

- 1 Cool/heat selector



- For low-noise operation, it is necessary to get the optional 'External control adaptor for outdoor unit' (DTA104A61/62).
For details, see the installation manual attached to the adaptor.

8.8. Field line connection: power wiring

The power cord must be clamped to the plastic bracket using field supplied clamp material.

The green and yellow striped wrapped wires must be used for grounding. (See figure 21)

- 1 Power supply (400 V, 3 N~50 Hz)
- 2 Fuse
- 3 Earth leakage breaker
- 4 Grounding wire
- 5 Power supply terminal block
- 6 Connect each power wire RED to L1, WHT to L2, BLK to L3 and BLU to N
- 7 Ground wire (GRN/YLW)
- 8 Clamp the power wire to the plastic bracket using a field supplied clamp to prevent external force being applied to the terminal.
- 9 Clamp (field supply)
- 10 Cup washer
- 11 When connecting the earth wire, it is recommended to perform curling.



- Do not allow the ground wires to contact the compressor lead wires. If the wires contact each other, adverse effects may occur to other units.
- When connecting or disconnecting a power supply cord, make sure that the current-carrying conductors become taut before the earthing conductor.



Precautions when laying power wiring

- Do not connect wiring of different thicknesses to the power terminal block. (Slack in the power wiring may cause abnormal heat.)
- When connecting wiring which is the same thickness, do as shown in the figure below.

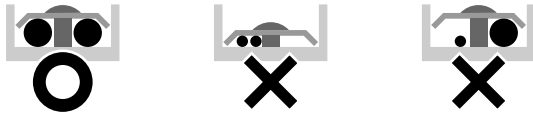

- For wiring, use the designated power wire and connect firmly, then secure to prevent outside pressure being exerted on the terminal board.
- Use an appropriate screwdriver for tightening the terminal screws. A screwdriver with a small head will strip the head and make proper tightening impossible.
- Over-tightening the terminal screws may break them.
- See the table below for tightening torque for the terminal screws.

Tightening torque (N·m)	
M8 (Power terminal block)	5.5~7.3
M8 (Ground)	
M3 (Inter-unit wiring terminal block)	0.8~0.97



Recommendations when connecting the ground

When pulling the ground wire out, wire it so that it comes through the cut out section of the cup washer. (An improper ground connection may prevent a good ground from being achieved.) (See figure 21)

8.9. Wiring example for wiring inside unit

See figure 26.

- 1 Electric wiring
- 2 Wiring between units
- 3 Clamp to the electric box with field supplied clamps.
- 4 When routing out the power/ground wires from the right side:
- 5 When routing the remote control cord and inter-unit wiring, secure clearance of 50 mm or more from the power wiring. Ensure that the power wiring does not contact any heated sections ().
- 6 Clamp to the back of the column support with field supplied clamps.
- 7 When routing out the inter-unit wirings from the opening for piping:
- 8 When routing out the power/ground wires from the front:
- 9 When routing out the ground wires from the left side:
- 10 Grounding wire
- 11 When wiring, pay attention not to detach the acoustic insulators from the compressor.
- 12 Power supply
- 13 Fuse
- 14 Earth leakage breaker
- 15 Ground wire
- 16 Unit A
- 17 Unit B
- 18 Unit C

9. PIPE INSULATION

After finishing the leak test and vacuum drying, the piping must be insulated. Take into account the following points:

- Make sure to insulate the connection piping and refrigerant branch kits entirely.
- Be sure to insulate liquid and gas piping (for all units).
- Use heat resistant polyethylene foam which can withstand a temperature of 70°C for liquid side piping and polyethylene foam which can withstand a temperature of 120°C for gas side piping.
- Reinforce the insulation on the refrigerant piping according to the installation environment.

Ambient temperature	Humidity	Minimum thickness
≤30°C	75% to 80% RH	15 mm
>30°C	≥80 RH	20 mm

Condensation might form on the surface of the insulation.

- If there is a possibility that condensation on the stop valve might drip down into the indoor unit through gaps in the insulation and piping because the outdoor unit is located higher than the indoor unit this must be prevented by sealing up the connections. See figure 9.

- 1 Gas line stop valve
- 2 Liquid line stop valve
- 3 Service port for adding refrigerant
- 4 Sealing up treatment
- 5 Insulation
- 6 Indoor -outdoor interconnection piping

- For cooling only units, insulation which can withstand 70°C is also sufficient for gas side piping.



Be sure to insulate local pipes, as touching them can cause burns.

10. CHECKING OF UNIT AND INSTALLATION CONDITIONS

Be sure to check the following:

The piping work

- 1 Make sure piping size is correct.
See "6.2. Selection of piping material" on page 5.
- 2 Make sure insulation work is done.
See "9. Pipe insulation" on page 15.
- 3 Make sure there is no faulty refrigerant piping.
See "6. Refrigerant piping" on page 4.

The electrical work

- 1 Make sure there is no faulty power wiring or loose nuts.
See "8. Field wiring" on page 10.
- 2 Make sure there is no faulty transmission wiring or loose nuts.
See "8. Field wiring" on page 10.
- 3 Make sure the insulation resistance of the main power circuit is not deteriorated.

Using a megatester for 500 V, check that the insulation resistance of 2 MΩ or more is attained by applying a voltage of 500 V DC between the power terminals and earth. Never use the megatester for the transmission wiring (between outdoor and indoor unit, outdoor and COOL/HEAT selector, etc.).

11. CHARGING REFRIGERANT

11.1. Stop valve operation procedure



- Do not open the stop valve until all piping and electrical steps of "10. Checking of unit and installation conditions" on page 15 are completed. If the stop valve is left open without turning on the power, it may cause refrigerant to build up in the compressor, leading to insulation degradation.
- Always use a charge hose for service port connection.
- After tightening the cap, check that no refrigerant leaks are present.

Introduction

The sizes of stop valves connected to the system are as listed in the table below.

Type	5	8	10	12	14	16	18
Liquid line stop valve	Ø9.5 ^(*)			Ø12.7 ^(†)			
Gas line stop valve	Ø15.9	Ø19.1	Ø25.4 ^(‡)				

- (*) The model RX(Y)Q12 supports field piping of Ø12.7 on the accessory pipe supplied with the unit.
- (†) The model RX(Y)Q18 supports field piping of Ø15.9 on the accessory pipe supplied with the unit.
- (‡) The model RX(Y)Q10 supports field piping of Ø22.2 on the accessory pipe supplied with the unit.
The model RX(Y)Q12~18 supports field piping of Ø28.6 on the accessory pipe supplied with the unit.

Opening stop valve (See figure 14)

- 1 Service port
- 2 Cap
- 3 Hexagon hole
- 4 Shaft
- 5 Seal

1. Remove the cap and turn the valve counterclockwise with the hexagon wrench.
2. Turn it until the shaft stops.



Do not apply excessive force to the stop valve. Doing so may break the valve body, as the valve is not a backseat type. Always use the special tool.

3. Make sure to tighten the cap securely. Refer to the table below

Stop valve size	Tightening torque N·m (Turn clockwise to close)			
	Shaft		Cap (valve lid)	Service port
	Valve body	Hexagonal wrench		
Ø9.5	5.4~6.6	4 mm	13.5~16.5	11.5~13.9
Ø12.7	8.1~9.9		18.0~22.0	
Ø15.9	13.5~16.5	6 mm	23.0~27.0	
Ø22.2	27.0~33.0	8 mm	22.5~27.5	
Ø25.4				

Closing stop valve (See figure 14)

1. Remove the cap and turn the valve clockwise with the hexagon wrench.
2. Securely tighten the valve until the shaft contacts the main body seal.
3. Make sure to tighten the cap securely.
For the tightening torque, refer to the table above.

11.2. Additional refrigerant charge

This outdoor unit is equipped with an automatic refrigerant charging function which automatically charges the system with the correct amount of refrigerant by connecting the refrigerant cylinder and performing a special operation, further explained in this chapter.



Adding refrigerant using the automatic refrigerant charging function is recommended.

If refrigerant is added manually, without using the automatic refrigerant charging function, the refrigerant leak detection function cannot be used.

The refrigerant leak detection function can be used during regular inspections or maintenance after installation of the unit.

The procedure differs for automatic charging and manual charging.

Follow the procedures below.



Refrigerant cannot be charged until field wiring and field piping has been completed.

Refrigerant may only be charged after performing the leak test and the vacuum drying (see above).

When charging a system, charging over the permissible quantity can cause liquid hammer.

Charging with an unsuitable substance may cause explosions and accidents, so always make sure that the appropriate refrigerant (R410A) is charged.

Refrigerant containers must be opened slowly.

Always use protective gloves and protect your eyes when charging refrigerant.



The amount of time required for automatic refrigerant charging depends on the amount of refrigerant to charge and the outdoor temperature. For 60 kg of refrigerant at an outdoor temperature of 30°C, ±180 minutes is needed.

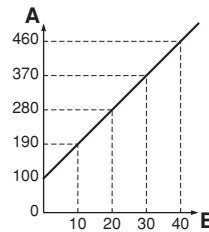

- A Charging rate (g/minute)
- B Outdoor temperature (°C DB)

- The automatic refrigerant charging has limits as described below.

At the out of limit, the system can not operate the automatic refrigerant charging.

- Outdoor temperature : 0°C DB~43°C DB
- Indoor temperature : 20°C DB~32°C DB
- Total indoor unit capacity : 80%~130%

Precautions when adding R410A

Be sure to charge the specified amount of refrigerant in liquid state to the liquid pipe.

Since this refrigerant is a mixed refrigerant, adding it in gas form may cause the refrigerant composition to change, preventing normal operation.

- Before charging, check whether the refrigerant cylinder is equipped with a siphon tube or not.

Charge the liquid refrigerant with the cylinder in upright position.

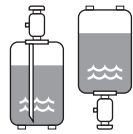

Charge the liquid refrigerant with the cylinder in up-side-down position.

- Be sure to use tools exclusively for R410A to ensure required pressure resistance and to prevent foreign materials from mixing into the system.

Adding refrigerant using the automatic refrigerant charging function

We recommend to use the automatic refrigerant charging function instead of adding refrigerant manually.

- Do not use the automatic refrigerant charging function while working on the indoor units. When using the automatic refrigerant charging function, the indoor units operate as well as the outdoor unit.

- Open the liquid side and gas side stop valves (with valves A, B and C closed). Refer to [figure 28](#).

- Measuring instrument
- Tank (siphon system)
- Charge hose
- Liquid line stop valve
- Gas line stop valve
- Stop valve service port
- Valve B
- Valve C
- Valve A
- Outdoor unit
- Refrigerant charge port
- To indoor unit
- Interunit piping
- Refrigerant flow

State of valves A and B and the stop valve	Valve			Stop valve	
	A	B	C	Liquid line	Gas line
Before starting automatic charging	Close	Close	Close	Open	Open

In case of a multi system, connect a refrigerant tank to each outdoor unit. Refer to [figure 28](#).

- See ["11-5 Shutoff valve operation procedure"](#) for details on how to handle stop valves.
- The refrigerant charging port is connected to the piping inside the unit.
The unit's internal piping is already factory charged with refrigerant, so be careful when connecting the charge hose.
- After adding the refrigerant, do not forget to close the lid of the refrigerant charging port.
The tightening torque for the lid is 11.5 to 13.9 N•m.
- Close the lid of the electric box and all front panels except on the side of the electric box.

- Turn on the outdoor unit (= all the outdoor units in case of a multiple outdoor unit system) and all the connected indoor units.

Normal operation will fail if automatic refrigerant charging is done while one of the units in the refrigeration system is turned off.

The outdoor unit has a function for detecting the number of outdoor and indoor units in the refrigeration system which are connected and turned on. Refer to ["Annex I"](#), ["How to check how many indoor units or outdoor units are active and connected to the outdoor unit"](#) on page 24.



Electric shock warning

- Close the electric box lid before turning on the main power.
- Perform the settings on the circuit board (A1P) of the outdoor unit and check the LED display after the power is on via the service lid which is in the lid of the electric box.

Operate switches with an insulated stick (such as a ball-point pen) to avoid touching the life parts.



Make sure to re-attach the inspection cover into the switch box cover after the job is finished.



Make sure to turn ON the power 6 hours before starting the operation. This is necessary to warm the crankcase by the electric heater.

- Check the LED's on the PC board (A1P) in the outdoor unit to control if the data transmission is performed normally.

(The state of each LED is as shown below when the data transmission is normal.)

LED display (Default status before delivery)	Service monitor HAP	Page H1P	Ready/Error H2P	Cooling/Heating changeover			Low noise H6P	Demand H7P	Multi H8P
				Individual H3P	Bulk (master) H4P	Bulk (slave) H5P			
One outdoor unit installed	☀	●	●	☀	●	●	●	●	●
Multiple outdoor units installed	Master unit (*)	☀	●	☀	●	●	●	●	☀
	Slave unit A (*)	☀	●	●	●	●	●	●	☀
	Slave unit B (*)	☀	●	●	●	●	●	●	●

Led display: ● = OFF, ☀ = ON, ☀ = blinking

(*) The state of the H8P (multi) LED in a multi-system shows which unit is the master unit (☀), slave 1 unit (☀) or slave 2 unit (●). Only the master unit is connected to the indoor units with interunit wiring.



If the H2P LED is lit up, check the malfunction code using the display on the remote controller, and fix the problem according to ["Remote controller displays malfunction code"](#) in ["12.4 Check by Check Operation"](#).

- Perform the automatic refrigerant charging
Refer to ["Annex II"](#), ["Automatic refrigerant charging procedure"](#) on page 25 to perform the automatic refrigerant charging procedure.

Adding refrigerant manually



If refrigerant is added manually, the refrigerant leak detection function cannot be used during regular inspection and maintenance after installation. If the refrigerant leak detection function is needed, charge refrigerant using the automatic refrigerant charging function. (Refer to "Automatic refrigerant charging procedure" on page 25.)

To avoid compressor breakdown, do not charge the refrigerant more than the specified amount.

This outdoor unit is factory charged.

In case re-charge is required, refer to the nameplate of the unit. The nameplate states the type of refrigerant and necessary amount.

- 1 Calculate how much refrigerant is to be added, refer to "How to calculate the additional refrigerant to be charged" on page 9 and fill in the amount in the "Additional refrigerant charge label" attached to the unit.
- 2 Add the refrigerant according to the following procedure.

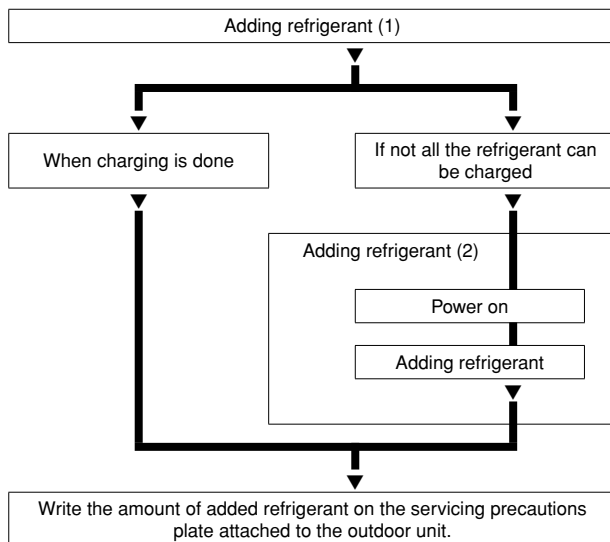

NOTE



- If all the refrigerant could not be added according to "Adding refrigerant (1): Outdoor unit at stand still", do not forget to add the missing amount described in "Adding refrigerant (2): Outdoor unit is operating". Using another method could result in breakage.
- Do not perform the "Adding refrigerant (2): Outdoor unit is operating" procedure while working on the indoor units. When performing "Adding refrigerant (2): Outdoor unit is operating", the indoor units operate as well as the outdoor unit.

Adding refrigerant (1): Outdoor unit at stand still

Open the valve C (valves A and B and the stop valves must be left fully closed) and charge the refrigerant in liquid form via the liquid side stop valve service port. See figure 29.



R410A is a mixed refrigerant, so charging it as a gas will cause the refrigerant composition to change, which may prevent normal operation.

Adding refrigerant (2): Outdoor unit is operating

Add refrigerant using the following procedure. See the service precautions attached to the electric box lid on the outdoor unit for details on the settings for adding refrigerant.

1. Close the electric box lid and turn on the power to all outdoor units and indoor units in the refrigeration system.
2. Fully open the valve C and the gas line stop valve (the liquid line stop valve and valve A and B must be left fully closed) and start the additional refrigerant charge operation. See figure 29.
3. While the unit is at standstill and under setting mode 2 (refer to Field setting, "Setting the mode" on page 20), set the required function "additional refrigerant charging operation" to ON (ON). Then operation starts. The blinking H2P led indicates test operation and the remote controller indicates TEST (test operation) and  (external control).
4. When the specified amount of refrigerant is charged, push the BS3 RETURN button. Then operation stops.
 - The operation automatically stops within 30 minutes.
 - If the refrigerant charge cannot be finished within 30 minutes, repeat step 2.
 - If the operation stops immediately after restart, there is a possibility that the system is overcharged. The refrigerant cannot be charged more than this amount.
- 3 After the refrigerant charge hose is removed, make sure to fully open the liquid stop valve. Otherwise the piping may burst due to blocked liquid.
- 4 After the refrigerant is charged, turn on the power for the indoor units and for the outdoor unit.

12. BEFORE OPERATION

12.1. Service precautions



WARNING: ELECTRIC SHOCK

Caution when performing service to inverter equipment

- 1 Turn off the power supply and wait for 10 minutes before opening the cover of the electric box.
Do not open the electric box cover for 10 minutes after the power supply is turned off.

- 2 Measure the voltage between terminals on the terminal block for power supply with a tester and confirm that the power supply is shut off.

In addition, measure the points, as shown in the figure below, with a tester and confirm that the voltage of the capacitor in the main circuit is less than 50 V DC.

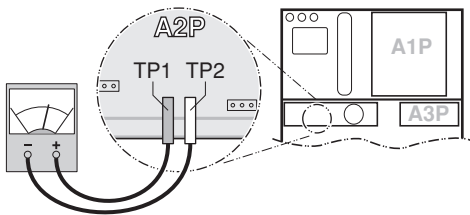

- 3 To prevent damaging the PC-board, touch a noncoated metal part to eliminate static electricity before pulling out or plugging in connectors.

- 4 The performing of the service to the inverter equipment must be started after the junction connectors X1A, X2A, X3A, X4A (X3A and X4A are for Q12~18 unit type only) for the fan motors in the outdoor unit are been pulled out. Be careful not to touch the live parts.

(If a fan rotates due to strong wind, it may store electricity in the capacitor or in the main circuit and cause electric shock.)

- 5 After the service is finished, plug the junction connector back in. Otherwise the error code E7 will be displayed on the remote controller and normal operation will not be performed.

For details refer to the wiring diagram labeled on the back of the electric box cover.

Pay attention to the fan. It is dangerous to inspect the unit while the fan is running. Be sure to turn off the main switch and to remove the fuses from the control circuit located in the outdoor unit.

NOTE **Play it safe!**



For protection of the PCB, touch the switch box casing by hand in order to eliminate static electricity from your body before performing service.

12.2. Checks before initial start-up

NOTE



Remark that during the first running period of the unit, required power input may be higher than stated on the nameplate of the unit. This phenomenon originates from the compressor that needs elapse of a 50 hours run in period before reaching smooth operation and stable power consumption.



- Make sure that the circuit breaker on the power supply panel of the installation is switched off.
- Attach the power wire securely.
- Introducing power with a missing N-phase or with a mistaken N-phase will break the equipment.

After the installation, check the following before switching on the circuit breaker:

- 1 The position of the switches that require an initial setting
Make sure that switches are set according to your application needs before turning the power supply on.
- 2 Power supply wiring and transmission wiring
Use a designated power supply and transmission wiring and make sure that it has been carried out according to the instructions described in this manual, according to the wiring diagrams and according to local and national regulations.
- 3 Pipe sizes and pipe insulation
Make sure that correct pipe sizes are installed and that the insulation work is properly executed.
- 4 Additional refrigerant charge
The amount of refrigerant to be added to the unit should be written on the included "Added Refrigerant" plate and attached to the rear side of the front cover.
- 5 Insulation test of the main power circuit
Using a megatester for 500 V, check that the insulation resistance of 2 MΩ or more is attained by applying a voltage of 500 V DC between power terminals and earth. Never use the megatester for the transmission wiring.
- 6 Installation date
Be sure to keep record of the installation date on the sticker on the rear of the upper front panel according to EN60335-2-40.

12.3. Field setting

If required, carry out field settings according to the following instructions. Refer to the service manual for more details.

Opening the switch box and handling the switches

When carrying out field settings, remove the inspection cover (1).

Operate the switches with an insulated stick (such as a ball-point pen) to avoid touching live parts.

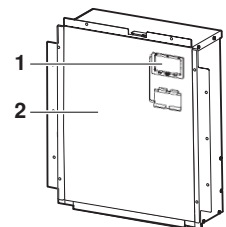

Make sure to re-attach the inspection cover (1) into the switch box cover (2) after the job is finished.

Make sure that all outside panels, except for the panel on the electric box, are closed while working.

Location of the dip switches, leds and buttons

- 1 Led H1~8P
- 2 Push button switches BS1~BS5
- 3 Dip switch 1 (DS1: 1~4)
- 4 Dip switch 2 (DS2: 1~4)
- 5 Dip switch 3 (DS3: 1~2)

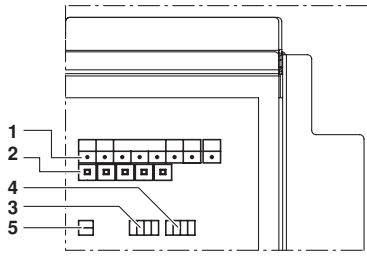

Led state

Throughout the manual the state of the leds is indicated as follows:

- OFF
- ☀ ON
- ⚡ Blinking

Setting the dip switches (only in case of a heat pump unit)

What to set with dip switch DS1	
1	COOL/HEAT selector (refer to "8.7. Field line connection: transmission wiring and cool/heat selection" on page 13) (OFF = not installed = factory setting)
2~4	NOT USED DO NOT CHANGE THE FACTORY SETTING.
What to set with dip switch DS2	
1~4	NOT USED DO NOT CHANGE THE FACTORY SETTING.
What to set with dip switch DS3	
1+2	NOT USED DO NOT CHANGE THE FACTORY SETTING.

Setting the push button switch (BS1~5)

Function of the push button switch which is located on the outdoor unit PCB (A1P):

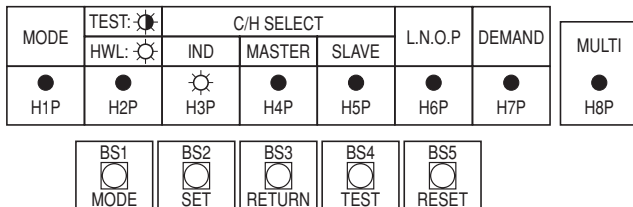

- BS1 MODE** For changing the set mode
- BS2 SET** For field setting
- BS3 RETURN** For field setting
- BS4 TEST** For test operation
- BS5 RESET** For resetting the address when the wiring is changed or when an additional indoor unit is installed

The figure shows state of the led indications when the unit is shipped from the factory.

	H1P	H2P	H3P	H4P	H5P	H6P	H7P
1	●	●	⚡	●	●	●	●
2	●	●	●	⚡	●	●	●
3	●	●	●	●	⚡	●	●

(*) It is necessary to use the optional external control adapter for outdoor unit (DTA104A61/62). See the instruction delivered with the adapter.

Check operation procedure

- 1 Turn the power on for the outdoor unit and the indoor unit.
Be sure to turn the power on at least 6 hours before operation in order to have power running to the crank case heater.
- 2 Make sure that transmission is normal by checking the LED display on the outdoor unit circuit board (A1P). (If transmission is normal, each LED will be displayed as shown below.)

LED display (Default status before delivery)	Micro-computer operation monitor HAP	Page H1P	Ready/Error H2P	Cooling/Heating changeover			Low noise H6P	Demand H7P	Multi H8P
				Individual H3P	Bulk (master) H4P	Bulk (slave) H5P			
Single outdoor unit system	☀	●	●	☀	●	●	●	●	●
Multiple outdoor unit system	Master unit(*)	☀	●	☀	●	●	●	●	☀
	Slave unit 1(*)	☀	●	●	●	●	●	●	⚡
	Slave unit 2(*)	☀	●	●	●	●	●	●	●

(*) The state of the H8P (multi) LED in a multi-system shows which unit is the master unit (☀), slave 1 unit (⚡) or slave 2 unit (●).
Only the master unit is connected to the indoor units with interunit wiring.

Setting the mode

The set mode can be changed with the **BS1 MODE** button according to the following procedure:

- **For setting mode 1:** Press the **BS1 MODE** button once, the H1P led is off ●.
- **For setting mode 2:** Press the **BS1 MODE** button for 5 seconds, the H1P led is on ☀.

If the H1P led is blinking ⚡ and the **BS1 MODE** button is pushed once, the setting mode will change to setting mode 1.

NOTE

If you get confused in the middle of the setting process, push the **BS1 MODE** button. Then it returns to setting mode 1 (H1P led is off).

Setting mode 1

(not in case of cooling only unit)(Check MATSUSHITA!!!)

The H1P led is off (COOL/HEAT selection setting).

Setting procedure

- 1 Push the **BS2 SET** button and adjust the led indication to either one of the possible settings as shown below in the field marked :
 - 1 In case of COOL/HEAT setting by each individual outdoor unit circuit.
 - 2 In case of COOL/HEAT setting by the master unit when outdoor units are connected in multiple system-combination(*).
 - 3 In case of COOL/HEAT setting by the slave unit when outdoor units connected in multiple system-combination(*).

Setting mode 2

The H1P led is on.

Setting procedure

- 1 Push the **BS2 SET** button according to the required function (A~G). The led indication that matches the required function is shown below in the field marked :

Possible functions

- A additional refrigerant charging operation.
- B refrigerant recovery operation/vacuuming operation.
- C setting of high static pressure.
- D automatic low noise operation setting at nighttime.
- E low noise operation level setting (L.N.O.P) via the external control adapter.
- F power consumption limitation setting (DEMAND) via the external control adapter.
- G enabling function of the low noise operation level setting (L.N.O.P) and/or power consumption limitation setting (DEMAND) via the external control adapter (DTA104A61/62).
- H check operation (without initial refrigerant decision)(load)

	H1P	H2P	H3P	H4P	H5P	H6P	H7P
A	☀	●	☀	●	☀	●	●
B	☀	●	☀	●	☀	●	☀
C	☀	●	☀	●	●	☀	●
D	☀	●	☀	●	☀	☀	●
E	☀	●	☀	☀	●	●	☀
F	☀	●	☀	☀	☀	☀	●
G	☀	●	●	☀	☀	●	●
H	☀	●	●	●	●	☀	☀

- 2 When the **BS3 RETURN** button is pushed, the current setting is defined.

- 3 Push the **BS2 SET** button according to the required setting possibility as shown below in the field marked .

- 3.1 Possible settings for function A, B, C, G and H are ON (ON) or OFF (OFF).

	H1P	H2P	H3P	H4P	H5P	H6P	H7P
ON	☀	●	●	●	●	☀	●
OFF (*)	☀	●	●	●	●	●	☀

(*) This setting = factory setting

- 3.2 Possible settings for function D

The noise of level 3 < level 2 < level 1 (▲ 1).

	H1P	H2P	H3P	H4P	H5P	H6P	H7P
OFF (*)	☀	●	●	●	●	●	●
▲ 1	☀	●	●	●	●	●	☀
▲ 2	☀	●	●	●	●	☀	●
▲ 3	☀	●	●	●	●	☀	☀

(*) This setting = factory setting

- 3.3 Possible settings for function E and F

For function E (L.N.O.P) only: the noise of level 3 < level 2 < level 1 (▲ 1).

For function F (DEMAND) only: the power consumption of level 1 < level 2 < level 3 (▲ 3).

	H1P	H2P	H3P	H4P	H5P	H6P	H7P
▲ 1	☀	●	●	●	●	●	☀
▲ 2 (*)	☀	●	●	●	●	☀	●
▲ 3	☀	●	●	●	☀	●	●

(*) This setting = factory setting

- 4 Push the **BS3 RETURN** button and the setting is defined.

- 5 When the **BS3 RETURN** button is pushed again, the operation starts according to the setting.

Refer to the service manual for more details and for other settings.

Confirmation of the set mode

The following items can be confirmed by setting mode 1 (H1P led is off)

Check the led indication in the field marked .

- 1 Indication of the present operation state

- ●, normal
- ☀, abnormal
- ☀, under preparation or under test operation

H1P	H2P	H3P	H4P	H5P	H6P	H7P
●	●	☀	●	●	●	●

- 2 Indication of COOL/HEAT selection setting

- 1 When set to COOL/HEAT change-over by each individual outdoor unit circuit (= factory setting).
- 2 Indication on master unit when COOL/HEAT change-over is carried out by outdoor system connected in multiple system-combination.
- 3 Indication on slave unit when COOL/HEAT change-over is carried out by outdoor system connected in multiple system-combination.

	H1P	H2P	H3P	H4P	H5P	H6P	H7P
1(*)	●	●	☀	●	●	●	●
2	●	●	●	☀	●	●	●
3	●	●	●	●	☀	●	●

(*) This setting = factory setting.

- 3 Indication of low noise operation state L.N.O.P

- ● standard operation (= factory setting)
- ☀ L.N.O.P operation

H1P	H2P	H3P	H4P	H5P	H6P	H7P
●	●	☀	●	●	●	●

- 4 Indication of power consumption limitation setting DEMAND

- ● standard operation (= factory setting)
- ☀ DEMAND operation

H1P	H2P	H3P	H4P	H5P	H6P	H7P
●	●	☀	●	●	●	●

12.4. Test operation



Do not insert fingers, rods or other objects into the air inlet or outlet. When the fan is rotating at high speed, it will cause injury.

NOTE



- In case of 20~54 type: check the setting and the indication results. Refer to chapter "Caution for 20~54 type units" on page 22.
- After turning on the power supply, the unit cannot be started until the H2P initialisation led goes off (maximum 12 minutes).

- Check the stop valves
Make sure to open the gas and liquid line stop valves.
- After installation, perform the test operation.
Unless the test operation is performed, the error code "U3" is shown on the remote controller and the unit cannot be operated.

Performing the test operation

- 1 To protect the compressor, make sure to turn on the power supply 6 hours before starting operation.
- 2 Set to setting mode 1 (H1P led is off) (refer to "Setting mode 1" on page 20).
- 3 Press the **BS4 TEST** button for 5 seconds (or longer when the unit is at standstill). The test operation starts when the H2P led blinks and the remote controller indicates **TEST** (test operation) and  (external control).

It may take 10 minutes to bring the state of refrigerant uniform before the compressor starts, but that is not a malfunction.

The test operation is automatically carried out in cooling mode during 15~30 minutes.

Depending on the situation, the refrigerant running sound or the sound of a magnetic solenoid valve may rise during this operation.

The following items are automatically checked:

- Check for miswiring
- Check if stop valves are open
- Check of refrigerant charge
- Automatic judgement of piping length

NOTE



When you want to terminate the test operation, press the **BS3 RETURN** button. The unit will keep running for 30 seconds and then stops. During test operation it is impossible to stop the unit with the remote controller.

- 4 After the test operation (maximum 30 minutes), the unit automatically stops. Check the operation results by the outdoor unit led indication.

	H1P	H2P	H3P	H4P	H5P	H6P	H7P
Normal	●	●	☀	●	●	●	●
Abnormal	●	☀	☀	●	●	●	●



- Indoor units cannot be checked individually. After the test operation is finished, check the indoor units individually via the remote controller.
- The led indication changes during this operation, but that is not abnormal.
- Please attach the front plate of the outdoor unit in order to prevent incorrect judgement during operation.

- 5 Measure to be taken when operation finishes abnormally
 1. Confirm the error code on the remote controller.
 2. Correct what is abnormal.
(See the installation manual and operation manual or contact your dealer.)

3. After the error is corrected, press the **BS3 RETURN** button and reset the error code.
4. Start the unit again to confirm that the problem is properly solved.

Error codes on the remote controller:

Installation error	Error code	Remedial action
The stop valve of an outdoor unit is left closed.	E3 E4 F3 UF	Check referring to the table in "Additional refrigerant charge" on page 16
The phases of the power to the outdoor units are reversed.	U1	Exchange two of the three phases (L1, L2, L3) to make a positive phase connection.
No power is supplied to an outdoor or indoor unit (including phase interruption).	U1 U4	Check if the power wiring for the outdoor units are connected correctly. (If the power wire is not connected to L2 phase, no malfunction display will appear and the compressor will not work.)
Incorrect interconnections between units	UF	Check if the refrigerant line piping and the unit wiring are consistent with each other.
Refrigerant overcharge	E3 F6 UF	Recalculate the required amount of refrigerant from the piping length and correct the refrigerant charge level by recovering any excessive refrigerant with a refrigerant recovery machine.
For the RX(Y)Q5~18, the wiring is connected to the Q1/Q2 (Out Multi)	U1 UF	Remove the wiring from the Q1/Q2 (Out Multi).
Insufficient refrigerant	E4 F3	Check if the additional refrigerant charge has been finished correctly. Recalculate the required amount of refrigerant from the piping length and add an adequate amount of refrigerant.

6 Caution for 20~54 type units

- The outdoor unit connected to the indoor unit by piping is the master outdoor unit. The other outdoor units (not connected to the indoor unit) are the slave outdoor units.
 - Carry out all the settings of the master unit. Settings on the slave units have no effect.
 - If the unit is operated with the valve closed, it may not function properly or even damage the equipment.
- 7 If no error code is indicated on the remote controller, it is possible to start operation after 5 minutes.

12.5. Temperature adjustment operation confirmation

After the test run is over, operate the unit normally. (Heating is not possible if the outdoor temperature is 24°C or higher.)

- Make sure the indoor and outdoor units are operating normally (If a knocking sound can be heard in the liquid compression of the compressor, stop the unit immediately and then energize the heater for a sufficient length of time before restarting the operation.)
- Run each indoor unit one at a time and make sure the corresponding outdoor unit is also running.
- Check to see if cold (or hot) air is coming out of the indoor unit.
- Press the fan direction and fan strength buttons on the indoor unit to see if they operate properly.



Cautions for normal operation check

- Once stopping, the compressor will not restart in about 5 minutes even if the Run/Stop button of an indoor unit in the same system is pressed.
- When the system operation is stopped by the remote controller, the outdoor units may continue operating for further 5 minutes at maximum.
- After the test run, when handing the unit over to the customer, make sure the electric box lid, the service lid, and the unit casing are all attached.

13. SERVICE MODE OPERATION

Vacuumping method

At the first installation, this vacuuming is not required. It is required only for repair purposes.

- 1 When the unit is at standstill and under the setting mode 2, set the required function B (refrigerant recovery operation/vacuumping operation) to ON (ON).
 - After this is set, do not reset the setting mode 2 until the vacuuming is finished.
 - The H1P led is on and the remote controller indicates TEST (test operation) and  (external control) and the operation will be prohibited.
- 2 Evacuate the system with a vacuum pump.
- 3 Press the BS1 MODE button and reset the setting mode 2.

Refrigerant recovery operation method

by a refrigerant reclaimer

- 1 When the unit is at standstill and under the setting mode 2, set the required function B (refrigerant recovery operation/vacuumping operation) to ON (ON).
 - The indoor unit and the outdoor unit expansion valves will fully open and some solenoid valves will be turned on.
 - The H1P led is on and the remote controller indicates TEST (test operation) and  (external control) and the operation will be prohibited.
- 2 Cut off the power supply to the indoor units and the outdoor unit with the circuit breaker. After the power supply to one side is cut off, cut off the power supply to the other side within 10 minutes. Otherwise, the communication between the indoor and outdoor unit may become abnormal and the expansion valves will be completely closed again.
- 3 Recover the refrigerant by a refrigerant reclaimer. For details, see the operation manual delivered with the refrigerant reclaimer.

14. CAUTION FOR REFRIGERANT LEAKS

Introduction

The installer and system specialist shall secure safety against leakage according to local regulations or standards. The following standards may be applicable if local regulations are not available.

This system uses R410A as refrigerant. R410A itself is an entirely safe non-toxic, non-combustible refrigerant. Nevertheless care must be taken to ensure that air conditioning facilities are installed in a room which is sufficiently large. This assures that the maximum concentration level of refrigerant gas is not exceeded, in the unlikely event of major leak in the system and this in accordance to the local applicable regulations and standards.

Maximum concentration level

The maximum charge of refrigerant and the calculation of the maximum concentration of refrigerant is directly related to the humanly occupied space in to which it could leak.

The unit of measurement of the concentration is kg/m³ (the weight in kg of the refrigerant gas in 1 m³ volume of the occupied space).

Compliance to the local applicable regulations and standards for the maximum allowable concentration level is required.

According to the appropriate European Standard, the maximum allowed concentration level of refrigerant to a humanly space for R410A is limited to 0.44 kg/m³.

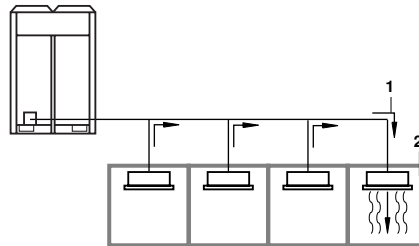

- 1 direction of the refrigerant flow
- 2 room where refrigerant leak has occurred (outflow of all the refrigerant from the system)

Pay special attention to places, such as a basements, etc. where refrigerant can stay, since refrigerant is heavier than air.

Procedure for checking maximum concentration

Check the maximum concentration level in accordance with steps 1 to 4 below and take whatever action is necessary to comply.

- 1 Calculate the amount of refrigerant (kg) charged to each system separately.

amount of refrigerant in a single unit system (amount of refrigerant with which the system is charged before leaving the factory)	+	additional charging amount (amount of refrigerant added locally in accordance with the length or diameter of the refrigerant piping)	=	total amount of refrigerant (kg) in the system
---	---	--	---	--



NOTE Where a single refrigerant facility is divided into 2 entirely independent refrigerant systems, use the amount of refrigerant with which each separate system is charged.

- 2 Calculate the smallest room volume (m³)

In a case such as the following, calculate the volume of (A), (B) as a single room or as the smallest room.

A. Where there are no smaller room divisions

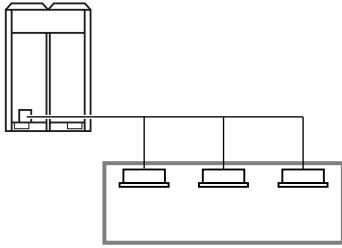

B. Where there is a room division but there is an opening between the rooms sufficiently large to permit a free flow of air back and forth.

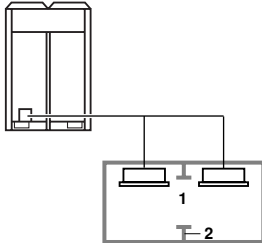

- 1 opening between rooms
- 2 partition
(Where there is an opening without a door or where there are openings above and below the door which are each equivalent in size to 0.15% or more of the floor area.)

3 Calculating the refrigerant density using the results of the calculations in steps 1 and 2 above.

$$\frac{\text{total volume of refrigerant in the refrigerant system}}{\text{size (m}^3\text{) of smallest room in which there is an indoor unit installed}} \leq \text{maximum concentration level (kg/m}^3\text{)}$$

If the result of the above calculation exceeds the maximum concentration level then make similar calculations for the second then third smallest room and so until the result falls short of the maximum concentration.

4 Dealing with the situations where the result exceeds the maximum concentration level.

Where the installation of a facility results in a concentration in excess of the maximum concentration level then it will be necessary to revise the system. Please consult your supplier.

15. DISPOSAL REQUIREMENTS

Dismantling of the unit, treatment of the refrigerant, of oil and of other parts must be done in accordance with relevant local and national legislation.

ANNEX I

How to check how many indoor units or outdoor units are active and connected to the outdoor unit

It is possible to find out how many indoor units are active and connected by operating the push-button switch on the printed circuit board (A1P) of the working outdoor unit. In a multiple outdoor unit system, you can find out how many outdoor units are connected to the system by using the same procedure on a indoor unit.

Make sure that all the indoor units connected to the outdoor unit are active.

Follow the 5-step procedure as explained below.

- The LEDs on the A1P shows the operating status of the outdoor unit and the number of indoor units that are active.

- OFF
- ☀ ON
- ⚡ Blinking

- The number of units that are active can be read from the LED display in the "Monitor Mode" procedure below.

Example: in the following procedure there are 22 units active:

NOTE Wherever during this procedure, press the **BS1 MODE** button if something becomes unclear.

You will return to setting mode 1 (H1P= ● "OFF").

1 Setting mode 1 (default system status)

Settings	H1P	H2P	H3P	H4P	H5P	H6P	H7P
Default status (normal)	●	●	☀	●	●	●	●

Press the **BS1 MODE** button to switch from setting mode 1 to monitor mode.

2 Monitor mode

Settings

H1P	H2P	H3P	H4P	H5P	H6P	H7P
⚡	●	●	●	●	●	●

Default status display

To make the LED display match that below (see step 3).

Standard system: Press the **BS2 SET** button 5 times

Multiple outdoor unit system: Press the **BS2 SET** button 8 times

3 Monitor mode

Settings

H1P	H2P	H3P	H4P	H5P	H6P	H7P
⚡	●	●	●	☀	●	☀

Selection status of how many connected indoor units to display

H1P	H2P	H3P	H4P	H5P	H6P	H7P
⚡	●	●	☀	●	●	●

Pressing the **BS3 RETURN** button causes the LED display to show the data on the number of indoor units that are connected or how many outdoor units that are connected in a multiple outdoor unit system.

4 Monitor mode

Settings

H1P	H2P	H3P	H4P	H5P	H6P	H7P
⚡	●	☀	●	☀	☀	●
		32	16	8	4	2
						1

Displaying the number of connected indoor units

↓ ↓ ↓
16+4+2=22 units

Calculate the number of connected indoor units by adding the values of all (H2P~H7P) blinking (☀) leds together. In this example:

Press the **BS3 RETURN** button to enter the monitor mode default status.

5 Monitor mode

Settings

Default status display

H1P	H2P	H3P	H4P	H5P	H6P	H7P
	●	●	●	●	●	●

Press the **BS1 MODE** button to return to step 1, setting mode 1 (H1P= ● "OFF").

ANNEX II

Automatic refrigerant charging procedure

This outdoor unit automatically charges the correct amount of refrigerant to the system by connecting a refrigerant tank and performing a special operation.

Refrigerant should be charged in the following procedure.

Refer to [figure 27](#) for charging refrigerant using the automatic refrigerant charging function and the state of the stop valve.





































NOTE



- Refer to the paragraph "Stop valve operation procedure" in the section "Inspecting and charging refrigerant" for more details on using the shut valve.
- The service port (for charging refrigerant) is factory mounted. The unit contains no refrigerant when unpacked. Use caution when attaching the charge hose.

State of the valves A and B and the stop valve	Valve A	Valve B	Liquid side stop valve	Gas side stop valve
Before starting automatic charging and after automatic charging is complete (Close valve A immediately after automatic charging is complete.)	Close	Close	Open	Open
During automatic charging (Valve B must always be shut. Otherwise the compressor may be damaged by the liquid refrigerant.)	Close	Close	Open	Open

Automatic refrigerant charging procedure

Step	Procedure (*)	Page H1P	Prep/ Error H2P	Cooling/Heating switch			Quiet H6P	Demand H7P	
				Individual H3P	All master H4P	All slaves H5P			
1	Check if the system is operating normally using setting mode 1 (default state of H1P= ● OFF). <ul style="list-style-type: none"> If the H1P LED is  (blinking) or ● (OFF), press the BS1 MODE button once to enter "Setting mode 1". If the H2P LED is  (ON), check the error via the malfunction code of the remote controller. Correct the problem according to the check operation procedure described in the paragraph "Check operation procedure" on page 20. 	No error							
		Error							
2	Press and hold the BS1 MODE button for at least 5 seconds to enter setting mode 2.		●	●	●	●	●	●	
3	Press the BS1 MODE button 54 times to select the automatic refrigerant charging operation item.				●			●	
4	Press the BS3 RETURN button to confirm the selection.		●	●	●	●	●		
5	Press the BS2 SET button to turn the automatic refrigerant charging function setting on.		●	●	●	●		●	
6	Press the BS3 RETURN button to confirm the setting.		●	●	●	●		●	
7	Press the BS3 RETURN button again to begin operation. During automatic refrigerant charging, the remote controller will display "Centralized control" and "Test run". Caution  Do not forget to close the front panel. If automatic refrigerant charging is performed with the front panel open, the correct amount of refrigerant will not be charged, and normal operation will not be possible.								
8	After the system preparation is complete and operation has started, the unit automatically starts charging refrigerant. Once the LED display becomes as shown at right, open valve A and close the front panel.				●		●	●	
9	Once the unit shuts down, close valve A immediately, open the outer panel and the service lid and check the LED display. One of the following states should be displayed, perform the instructions according to the display. Charging complete Charging of the refrigerant is complete. Operation is done. Re-charge Repeat the automatic refrigerant charging operation from step 1 onwards. Replace tank Replace the refrigerant tank and repeat the automatic refrigerant charging operation from step 1 onwards. Charging interrupted An error in the system interrupted the operation. Correct the problem, <ul style="list-style-type: none"> is the gas side stop valve completely open? are the valve on the refrigerant and valve A open? is the indoor unit intake vent or outlet vent blocked? When the problem is corrected, repeat the automatic refrigerant charging operation from step 1 onwards.								
					●				
			●	●	●	●		●	●
			●	●	●	●	●	●	

(*) If the outer panel is not closed, normal operation will not be possible if the outdoor temperature is high.

- OFF
-  ON
-  Blinking



- Do not use the automatic refrigerant charging function while working on the indoor units.
- If operation is performed within 12 minutes of the indoor and outdoor units being turned on, the compressor will not run and the H2P LED will light up.
- Run the unit after checking that the LED display is normal as shown in step 1.
- In a multiple outdoor unit system, the parent unit is the outdoor unit to which the indoor unit interunit wiring is connected.
- In order to ensure uniform refrigerant distribution, it may take up to around 10 minutes for the compressor to start up after the unit starts running. This is not a malfunction.
- When using the automatic refrigerant charging function, the outdoor unit and all the connected indoor units will start operation.



- Make sure all outside panels other than on the electric box are closed while doing work.
 - Automatic refrigerant charging must be done when the outdoor temperature is not lower than 0°C.
When the outdoor temperature is low, the temperature of the refrigerant tank will drop and causing addition of refrigerant coming to a stop.
 - Keep the outer panel closed unless operating the press-button switch or attaching the charge hose.
 - It is possible that the unit makes loud noises during the automatic refrigerant charging operation, including refrigerant flowing noises, the electromagnetic valve may starts working, etc.
-

NOTES

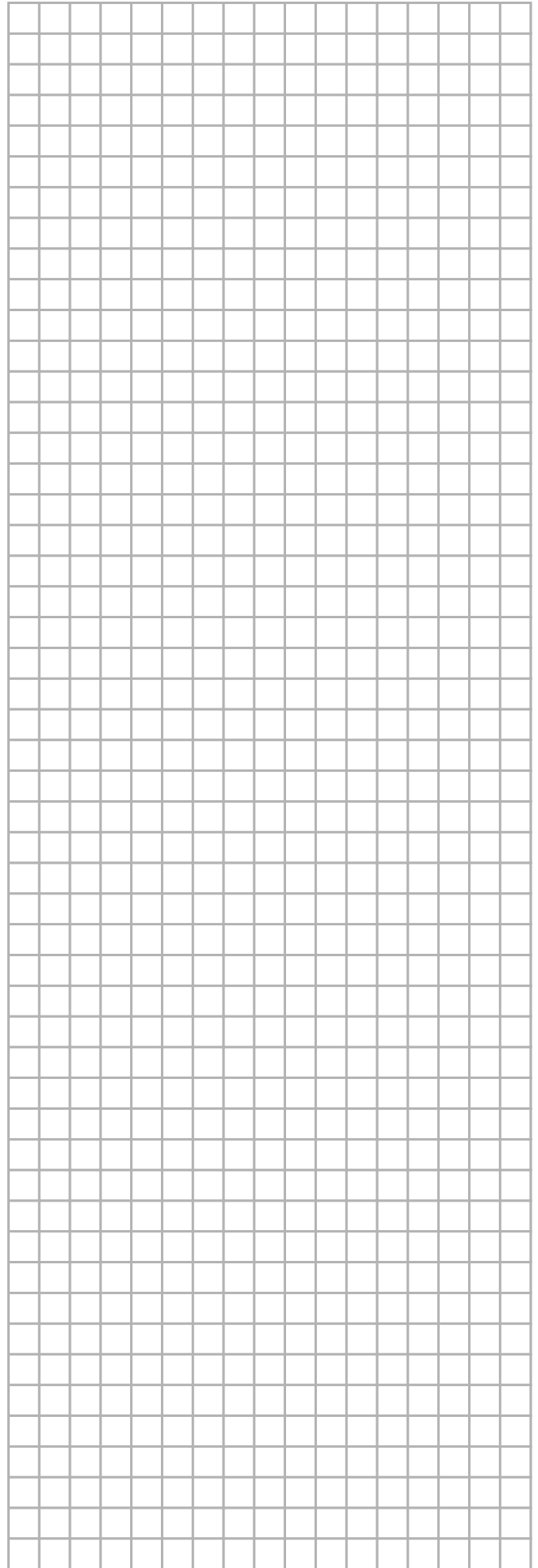
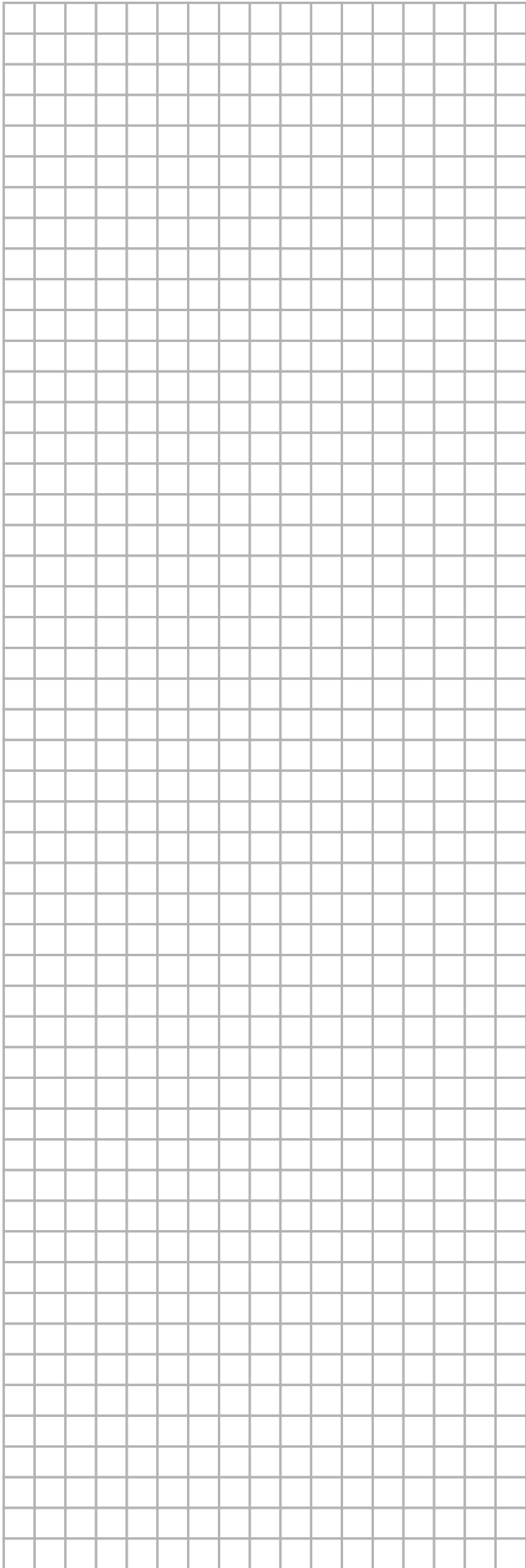

DAIKIN EUROPE NV

Zandvoordestraat 300, B-8400 Oostende, Belgium

4PW28161-1