

DAIKIN

INSTALLATION MANUAL

VRV[®]-WIII System air conditioner

RWEYQ8PY1
RWEYQ10PY1*
RWEYQ16PY1
RWEYQ18PY1
RWEYQ20PY1*
RWEYQ24PY1
RWEYQ26PY1
RWEYQ28PY1
RWEYQ30PY1*

*Only models with suffix numbers
10, 20, and 30 are sold in China.

中国仅出售后缀号为10、20和30的机型。

Installation manual
VRVWIII System air conditioner

English

Installationsanweisung
VRVWIII System Klimaanlage

Deutsch

Manuel d'installation
Conditionneur d'air VRVWIII System

Français

Manual de instalación
Acondicionador de aire con sistema VRVWIII

Español

Manuale di installazione
Condizionatore d'aria a sistema VRVWIII

Italiano

Εγχειρίδιο εγκατάστασης
Κλιματιστικό με σύστημα VRVWIII

Ελληνικά

Installatiehandleiding
Airconditioner met VRVWIII System

Nederlands

Manual de instalação
Ar condicionado VRVWIII System

Portugues

Руководство по монтажу
Кондиционер системы VRVWIII

Русский

安装说明书
VRVWIII系统空调机

中文
(简体)

CE - DECLARATION-OF-CONFORMITY
 CE - KONFORMITÄTSSERKLÄRUNG
 CE - DECLARATION-DE CONFORMITE
 CE - CONFORMITÄTSSERKLÄRUNG

CE - DECLARACION-DE CONFORMIDAD
 CE - DICHIARAZIONE DI CONFORMITÀ
 CE - ΔΗΛΩΣΗ ΣΥΜΜΟΡΦΩΣΗΣ
 CE - FORSKRAN-OM ÖVERENSTÄMMELSE

CE - DECLARACIÓN-DE CONFORMIDADE
 CE - ЗАЯВЛЕНИЕ О СООТВЕТСТВИИ
 CE - OPFYLDSELSESRKLAERING
 CE - PROHLÁŠENÍ O SHODĚ

CE - IZJAVA O SKLADNOSTI
 CE - ERKLÄRUNG OM SAMSVAR
 CE - ILMUUTUS-YHDENMUKAISUJDESTA
 CE - DEKLARACJA-ZGODNOŚCI
 CE - DECLARAȚIE-DE CONFORMITATE

CE - IZJAVA O SKLADNOSTI
 CE - VASTAVUSDEKLARAATIOON
 CE - ДЕКЛАРАЦІЯ-ЗА СЪОТВѢТСТВІЕ
 CE - UYUMLULUK-BİLDİRİSİ

DAIKIN INDUSTRIES, LTD.

- 01 (E) declares under its sole responsibility that the air conditioning models to which this declaration relates;
- 02 (D) erklärt auf seine alleinige Verantwortung, daß die Modelle der Klimaanlage für die diese Erklärung bestimmt ist;
- 03 (E) déclare sous sa seule responsabilité que les appareils ont été conditionnés visés par la présente déclaration;
- 04 (E) verklaart hierbij op eigen exclusieve verantwoordelijkheid dat de airconditioning units waarop deze verklaring betrekking heeft;
- 05 (E) declara bajo su única responsabilidad que los modelos de aire acondicionado a los cuales hace referencia la declaración;
- 06 (I) dichiara sotto sua responsabilità che i condizionatori modello a cui è riferita questa dichiarazione;
- 07 (E) δηλώνει με αποκλειστική της ευθύνη ότι το προϊόν της κλιματιστικής συσκευής στα οποία αναφέρεται η παρούσα δήλωση;
- 08 (P) declara sob sua exclusiva responsabilidade que os modelos de ar condicionado a que esta declaração se refere;
- 09 (E) заявляет, исключительную под свою ответственность, что модели кондиционеров воздуха, к которым относится настоящее заявление;

RXYQ5PY1(E), RXYQ8PY1(E), RXYQ10PY1(E), RXYQ12PY1(E), RXYQ14PY1(E), RXYQ16PY1(E), RXYQ18PY1(E), RXYQ20PY1(E), RXYQ22PY1(E), RXYQ24PY1(E), RXYQ26PY1(E), RXYQ28PY1(E), RXYQ30PY1(E), RXYQ32PY1(E), RXYQ34PY1(E), RXYQ36PY1(E), RXYQ38PY1(E), RXYQ40PY1(E), RXYQ42PY1(E), RXYQ44PY1(E), RXYQ46PY1(E), RXYQ48PY1(E), RXYQ50PY1(E), RXYQ52PY1(E), RXYQ54PY1(E), RTSYQ10PY1, RTSYQ14PY1, RTSYQ16PY1, RTSYQ20PY1, RTSYQ24PY1, RTSYQ26PY1, RTSYQ28PY1, RTSYQ30PY1, RTSYQ32PY1, RTSYQ34PY1, RTSYQ36PY1, RTSYQ38PY1, RTSYQ40PY1, RTSYQ42PY1, RTSYQ44PY1, RTSYQ46PY1, RTSYQ48PY1, RTSYQ50PY1, RTSYQ52PY1, RTSYQ54PY1, BSVQ250PY1, BSVQ260PY1, BSVQ270PY1, BSVQ280PY1, BSVQ290PY1, BSVQ300PY1, BSVQ310PY1, BSVQ320PY1, BSVQ330PY1, BSVQ340PY1, BSVQ350PY1, BSVQ360PY1, BSVQ370PY1, BSVQ380PY1, BSVQ390PY1, BSVQ400PY1, BSVQ410PY1, BSVQ420PY1, BSVQ430PY1, BSVQ440PY1, BSVQ450PY1, BSVQ460PY1, BSVQ470PY1, BSVQ480PY1, BSVQ490PY1, BSVQ500PY1, BSVQ510PY1, BSVQ520PY1, BSVQ530PY1, BSVQ540PY1, BSVQ550PY1, BSVQ560PY1, BSVQ570PY1, BSVQ580PY1, BSVQ590PY1, BSVQ600PY1, BSVQ610PY1, BSVQ620PY1, BSVQ630PY1, BSVQ640PY1, BSVQ650PY1, BSVQ660PY1, BSVQ670PY1, BSVQ680PY1, BSVQ690PY1, BSVQ700PY1, BSVQ710PY1, BSVQ720PY1, BSVQ730PY1, BSVQ740PY1, BSVQ750PY1, BSVQ760PY1, BSVQ770PY1, BSVQ780PY1, BSVQ790PY1, BSVQ800PY1, BSVQ810PY1, BSVQ820PY1, BSVQ830PY1, BSVQ840PY1, BSVQ850PY1, BSVQ860PY1, BSVQ870PY1, BSVQ880PY1, BSVQ890PY1, BSVQ900PY1, BSVQ910PY1, BSVQ920PY1, BSVQ930PY1, BSVQ940PY1, BSVQ950PY1, BSVQ960PY1, BSVQ970PY1, BSVQ980PY1, BSVQ990PY1, BSVQ1000PY1, BSVQ1010PY1, BSVQ1020PY1, BSVQ1030PY1, BSVQ1040PY1, BSVQ1050PY1, BSVQ1060PY1, BSVQ1070PY1, BSVQ1080PY1, BSVQ1090PY1, BSVQ1100PY1, BSVQ1110PY1, BSVQ1120PY1, BSVQ1130PY1, BSVQ1140PY1, BSVQ1150PY1, BSVQ1160PY1, BSVQ1170PY1, BSVQ1180PY1, BSVQ1190PY1, BSVQ1200PY1, BSVQ1210PY1, BSVQ1220PY1, BSVQ1230PY1, BSVQ1240PY1, BSVQ1250PY1, BSVQ1260PY1, BSVQ1270PY1, BSVQ1280PY1, BSVQ1290PY1, BSVQ1300PY1, BSVQ1310PY1, BSVQ1320PY1, BSVQ1330PY1, BSVQ1340PY1, BSVQ1350PY1, BSVQ1360PY1, BSVQ1370PY1, BSVQ1380PY1, BSVQ1390PY1, BSVQ1400PY1, BSVQ1410PY1, BSVQ1420PY1, BSVQ1430PY1, BSVQ1440PY1, BSVQ1450PY1, BSVQ1460PY1, BSVQ1470PY1, BSVQ1480PY1, BSVQ1490PY1, BSVQ1500PY1, BSVQ1510PY1, BSVQ1520PY1, BSVQ1530PY1, BSVQ1540PY1, BSVQ1550PY1, BSVQ1560PY1, BSVQ1570PY1, BSVQ1580PY1, BSVQ1590PY1, BSVQ1600PY1, BSVQ1610PY1, BSVQ1620PY1, BSVQ1630PY1, BSVQ1640PY1, BSVQ1650PY1, BSVQ1660PY1, BSVQ1670PY1, BSVQ1680PY1, BSVQ1690PY1, BSVQ1700PY1, BSVQ1710PY1, BSVQ1720PY1, BSVQ1730PY1, BSVQ1740PY1, BSVQ1750PY1, BSVQ1760PY1, BSVQ1770PY1, BSVQ1780PY1, BSVQ1790PY1, BSVQ1800PY1, BSVQ1810PY1, BSVQ1820PY1, BSVQ1830PY1, BSVQ1840PY1, BSVQ1850PY1, BSVQ1860PY1, BSVQ1870PY1, BSVQ1880PY1, BSVQ1890PY1, BSVQ1900PY1, BSVQ1910PY1, BSVQ1920PY1, BSVQ1930PY1, BSVQ1940PY1, BSVQ1950PY1, BSVQ1960PY1, BSVQ1970PY1, BSVQ1980PY1, BSVQ1990PY1, BSVQ2000PY1, BSVQ2010PY1, BSVQ2020PY1, BSVQ2030PY1, BSVQ2040PY1, BSVQ2050PY1, BSVQ2060PY1, BSVQ2070PY1, BSVQ2080PY1, BSVQ2090PY1, BSVQ2100PY1, BSVQ2110PY1, BSVQ2120PY1, BSVQ2130PY1, BSVQ2140PY1, BSVQ2150PY1, BSVQ2160PY1, BSVQ2170PY1, BSVQ2180PY1, BSVQ2190PY1, BSVQ2200PY1, BSVQ2210PY1, BSVQ2220PY1, BSVQ2230PY1, BSVQ2240PY1, BSVQ2250PY1, BSVQ2260PY1, BSVQ2270PY1, BSVQ2280PY1, BSVQ2290PY1, BSVQ2300PY1, BSVQ2310PY1, BSVQ2320PY1, BSVQ2330PY1, BSVQ2340PY1, BSVQ2350PY1, BSVQ2360PY1, BSVQ2370PY1, BSVQ2380PY1, BSVQ2390PY1, BSVQ2400PY1, BSVQ2410PY1, BSVQ2420PY1, BSVQ2430PY1, BSVQ2440PY1, BSVQ2450PY1, BSVQ2460PY1, BSVQ2470PY1, BSVQ2480PY1, BSVQ2490PY1, BSVQ2500PY1, BSVQ2510PY1, BSVQ2520PY1, BSVQ2530PY1, BSVQ2540PY1, BSVQ2550PY1, BSVQ2560PY1, BSVQ2570PY1, BSVQ2580PY1, BSVQ2590PY1, BSVQ2600PY1, BSVQ2610PY1, BSVQ2620PY1, BSVQ2630PY1, BSVQ2640PY1, BSVQ2650PY1, BSVQ2660PY1, BSVQ2670PY1, BSVQ2680PY1, BSVQ2690PY1, BSVQ2700PY1, BSVQ2710PY1, BSVQ2720PY1, BSVQ2730PY1, BSVQ2740PY1, BSVQ2750PY1, BSVQ2760PY1, BSVQ2770PY1, BSVQ2780PY1, BSVQ2790PY1, BSVQ2800PY1, BSVQ2810PY1, BSVQ2820PY1, BSVQ2830PY1, BSVQ2840PY1, BSVQ2850PY1, BSVQ2860PY1, BSVQ2870PY1, BSVQ2880PY1, BSVQ2890PY1, BSVQ2900PY1, BSVQ2910PY1, BSVQ2920PY1, BSVQ2930PY1, BSVQ2940PY1, BSVQ2950PY1, BSVQ2960PY1, BSVQ2970PY1, BSVQ2980PY1, BSVQ2990PY1, BSVQ3000PY1, BSVQ3010PY1, BSVQ3020PY1, BSVQ3030PY1, BSVQ3040PY1, BSVQ3050PY1, BSVQ3060PY1, BSVQ3070PY1, BSVQ3080PY1, BSVQ3090PY1, BSVQ3100PY1, BSVQ3110PY1, BSVQ3120PY1, BSVQ3130PY1, BSVQ3140PY1, BSVQ3150PY1, BSVQ3160PY1, BSVQ3170PY1, BSVQ3180PY1, BSVQ3190PY1, BSVQ3200PY1, BSVQ3210PY1, BSVQ3220PY1, BSVQ3230PY1, BSVQ3240PY1, BSVQ3250PY1, BSVQ3260PY1, BSVQ3270PY1, BSVQ3280PY1, BSVQ3290PY1, BSVQ3300PY1, BSVQ3310PY1, BSVQ3320PY1, BSVQ3330PY1, BSVQ3340PY1, BSVQ3350PY1, BSVQ3360PY1, BSVQ3370PY1, BSVQ3380PY1, BSVQ3390PY1, BSVQ3400PY1, BSVQ3410PY1, BSVQ3420PY1, BSVQ3430PY1, BSVQ3440PY1, BSVQ3450PY1, BSVQ3460PY1, BSVQ3470PY1, BSVQ3480PY1, BSVQ3490PY1, BSVQ3500PY1, BSVQ3510PY1, BSVQ3520PY1, BSVQ3530PY1, BSVQ3540PY1, BSVQ3550PY1, BSVQ3560PY1, BSVQ3570PY1, BSVQ3580PY1, BSVQ3590PY1, BSVQ3600PY1, BSVQ3610PY1, BSVQ3620PY1, BSVQ3630PY1, BSVQ3640PY1, BSVQ3650PY1, BSVQ3660PY1, BSVQ3670PY1, BSVQ3680PY1, BSVQ3690PY1, BSVQ3700PY1, BSVQ3710PY1, BSVQ3720PY1, BSVQ3730PY1, BSVQ3740PY1, BSVQ3750PY1, BSVQ3760PY1, BSVQ3770PY1, BSVQ3780PY1, BSVQ3790PY1, BSVQ3800PY1, BSVQ3810PY1, BSVQ3820PY1, BSVQ3830PY1, BSVQ3840PY1, BSVQ3850PY1, BSVQ3860PY1, BSVQ3870PY1, BSVQ3880PY1, BSVQ3890PY1, BSVQ3900PY1, BSVQ3910PY1, BSVQ3920PY1, BSVQ3930PY1, BSVQ3940PY1, BSVQ3950PY1, BSVQ3960PY1, BSVQ3970PY1, BSVQ3980PY1, BSVQ3990PY1, BSVQ4000PY1, BSVQ4010PY1, BSVQ4020PY1, BSVQ4030PY1, BSVQ4040PY1, BSVQ4050PY1, BSVQ4060PY1, BSVQ4070PY1, BSVQ4080PY1, BSVQ4090PY1, BSVQ4100PY1, BSVQ4110PY1, BSVQ4120PY1, BSVQ4130PY1, BSVQ4140PY1, BSVQ4150PY1, BSVQ4160PY1, BSVQ4170PY1, BSVQ4180PY1, BSVQ4190PY1, BSVQ4200PY1, BSVQ4210PY1, BSVQ4220PY1, BSVQ4230PY1, BSVQ4240PY1, BSVQ4250PY1, BSVQ4260PY1, BSVQ4270PY1, BSVQ4280PY1, BSVQ4290PY1, BSVQ4300PY1, BSVQ4310PY1, BSVQ4320PY1, BSVQ4330PY1, BSVQ4340PY1, BSVQ4350PY1, BSVQ4360PY1, BSVQ4370PY1, BSVQ4380PY1, BSVQ4390PY1, BSVQ4400PY1, BSVQ4410PY1, BSVQ4420PY1, BSVQ4430PY1, BSVQ4440PY1, BSVQ4450PY1, BSVQ4460PY1, BSVQ4470PY1, BSVQ4480PY1, BSVQ4490PY1, BSVQ4500PY1, BSVQ4510PY1, BSVQ4520PY1, BSVQ4530PY1, BSVQ4540PY1, BSVQ4550PY1, BSVQ4560PY1, BSVQ4570PY1, BSVQ4580PY1, BSVQ4590PY1, BSVQ4600PY1, BSVQ4610PY1, BSVQ4620PY1, BSVQ4630PY1, BSVQ4640PY1, BSVQ4650PY1, BSVQ4660PY1, BSVQ4670PY1, BSVQ4680PY1, BSVQ4690PY1, BSVQ4700PY1, BSVQ4710PY1, BSVQ4720PY1, BSVQ4730PY1, BSVQ4740PY1, BSVQ4750PY1, BSVQ4760PY1, BSVQ4770PY1, BSVQ4780PY1, BSVQ4790PY1, BSVQ4800PY1, BSVQ4810PY1, BSVQ4820PY1, BSVQ4830PY1, BSVQ4840PY1, BSVQ4850PY1, BSVQ4860PY1, BSVQ4870PY1, BSVQ4880PY1, BSVQ4890PY1, BSVQ4900PY1, BSVQ4910PY1, BSVQ4920PY1, BSVQ4930PY1, BSVQ4940PY1, BSVQ4950PY1, BSVQ4960PY1, BSVQ4970PY1, BSVQ4980PY1, BSVQ4990PY1, BSVQ5000PY1, BSVQ5010PY1, BSVQ5020PY1, BSVQ5030PY1, BSVQ5040PY1, BSVQ5050PY1, BSVQ5060PY1, BSVQ5070PY1, BSVQ5080PY1, BSVQ5090PY1, BSVQ5100PY1, BSVQ5110PY1, BSVQ5120PY1, BSVQ5130PY1, BSVQ5140PY1, BSVQ5150PY1, BSVQ5160PY1, BSVQ5170PY1, BSVQ5180PY1, BSVQ5190PY1, BSVQ5200PY1, BSVQ5210PY1, BSVQ5220PY1, BSVQ5230PY1, BSVQ5240PY1, BSVQ5250PY1, BSVQ5260PY1, BSVQ5270PY1, BSVQ5280PY1, BSVQ5290PY1, BSVQ5300PY1, BSVQ5310PY1, BSVQ5320PY1, BSVQ5330PY1, BSVQ5340PY1, BSVQ5350PY1, BSVQ5360PY1, BSVQ5370PY1, BSVQ5380PY1, BSVQ5390PY1, BSVQ5400PY1, BSVQ5410PY1, BSVQ5420PY1, BSVQ5430PY1, BSVQ5440PY1, BSVQ5450PY1, BSVQ5460PY1, BSVQ5470PY1, BSVQ5480PY1, BSVQ5490PY1, BSVQ5500PY1, BSVQ5510PY1, BSVQ5520PY1, BSVQ5530PY1, BSVQ5540PY1, BSVQ5550PY1, BSVQ5560PY1, BSVQ5570PY1, BSVQ5580PY1, BSVQ5590PY1, BSVQ5600PY1, BSVQ5610PY1, BSVQ5620PY1, BSVQ5630PY1, BSVQ5640PY1, BSVQ5650PY1, BSVQ5660PY1, BSVQ5670PY1, BSVQ5680PY1, BSVQ5690PY1, BSVQ5700PY1, BSVQ5710PY1, BSVQ5720PY1, BSVQ5730PY1, BSVQ5740PY1, BSVQ5750PY1, BSVQ5760PY1, BSVQ5770PY1, BSVQ5780PY1, BSVQ5790PY1, BSVQ5800PY1, BSVQ5810PY1, BSVQ5820PY1, BSVQ5830PY1, BSVQ5840PY1, BSVQ5850PY1, BSVQ5860PY1, BSVQ5870PY1, BSVQ5880PY1, BSVQ5890PY1, BSVQ5900PY1, BSVQ5910PY1, BSVQ5920PY1, BSVQ5930PY1, BSVQ5940PY1, BSVQ5950PY1, BSVQ5960PY1, BSVQ5970PY1, BSVQ5980PY1, BSVQ5990PY1, BSVQ6000PY1, BSVQ6010PY1, BSVQ6020PY1, BSVQ6030PY1, BSVQ6040PY1, BSVQ6050PY1, BSVQ6060PY1, BSVQ6070PY1, BSVQ6080PY1, BSVQ6090PY1, BSVQ6100PY1, BSVQ6110PY1, BSVQ6120PY1, BSVQ6130PY1, BSVQ6140PY1, BSVQ6150PY1, BSVQ6160PY1, BSVQ6170PY1, BSVQ6180PY1, BSVQ6190PY1, BSVQ6200PY1, BSVQ6210PY1, BSVQ6220PY1, BSVQ6230PY1, BSVQ6240PY1, BSVQ6250PY1, BSVQ6260PY1, BSVQ6270PY1, BSVQ6280PY1, BSVQ6290PY1, BSVQ6300PY1, BSVQ6310PY1, BSVQ6320PY1, BSVQ6330PY1, BSVQ6340PY1, BSVQ6350PY1, BSVQ6360PY1, BSVQ6370PY1, BSVQ6380PY1, BSVQ6390PY1, BSVQ6400PY1, BSVQ6410PY1, BSVQ6420PY1, BSVQ6430PY1, BSVQ6440PY1, BSVQ6450PY1, BSVQ6460PY1, BSVQ6470PY1, BSVQ6480PY1, BSVQ6490PY1, BSVQ6500PY1, BSVQ6510PY1, BSVQ6520PY1, BSVQ6530PY1, BSVQ6540PY1, BSVQ6550PY1, BSVQ6560PY1, BSVQ6570PY1, BSVQ6580PY1, BSVQ6590PY1, BSVQ6600PY1, BSVQ6610PY1, BSVQ6620PY1, BSVQ6630PY1, BSVQ6640PY1, BSVQ6650PY1, BSVQ6660PY1, BSVQ6670PY1, BSVQ6680PY1, BSVQ6690PY1, BSVQ6700PY1, BSVQ6710PY1, BSVQ6720PY1, BSVQ6730PY1, BSVQ6740PY1, BSVQ6750PY1, BSVQ6760PY1, BSVQ6770PY1, BSVQ6780PY1, BSVQ6790PY1, BSVQ6800PY1, BSVQ6810PY1, BSVQ6820PY1, BSVQ6830PY1, BSVQ6840PY1, BSVQ6850PY1, BSVQ6860PY1, BSVQ6870PY1, BSVQ6880PY1, BSVQ6890PY1, BSVQ6900PY1, BSVQ6910PY1, BSVQ6920PY1, BSVQ6930PY1, BSVQ6940PY1, BSVQ6950PY1, BSVQ6960PY1, BSVQ6970PY1, BSVQ6980PY1, BSVQ6990PY1, BSVQ7000PY1, BSVQ7010PY1, BSVQ7020PY1, BSVQ7030PY1, BSVQ7040PY1, BSVQ7050PY1, BSVQ7060PY1, BSVQ7070PY1, BSVQ7080PY1, BSVQ7090PY1, BSVQ7100PY1, BSVQ7110PY1, BSVQ7120PY1, BSVQ7130PY1, BSVQ7140PY1, BSVQ7150PY1, BSVQ7160PY1, BSVQ7170PY1, BSVQ7180PY1, BSVQ7190PY1, BSVQ7200PY1, BSVQ7210PY1, BSVQ7220PY1, BSVQ7230PY1, BSVQ7240PY1, BSVQ7250PY1, BSVQ7260PY1, BSVQ7270PY1, BSVQ7280PY1, BSVQ7290PY1, BSVQ7300PY1, BSVQ7310PY1, BSVQ7320PY1, BSVQ7330PY1, BSVQ7340PY1, BSVQ7350PY1, BSVQ7360PY1, BSVQ7370PY1, BSVQ7380PY1, BSVQ7390PY1, BSVQ7400PY1, BSVQ7410PY1, BSVQ7420PY1, BSVQ7430PY1, BSVQ7440PY1, BSVQ7450PY1, BSVQ7460PY1, BSVQ7470PY1, BSVQ7480PY1, BSVQ7490PY1, BSVQ7500PY1, BSVQ7510PY1, BSVQ7520PY1, BSVQ7530PY1, BSVQ7540PY1, BSVQ7550PY1, BSVQ7560PY1, BSVQ7570PY1, BSVQ7580PY1, BSVQ7590PY1, BSVQ7600PY1, BSVQ7610PY1, BSVQ7620PY1, BSVQ7630PY1, BSVQ7640PY1, BSVQ7650PY1, BSVQ7660PY1, BSVQ7670PY1, BSVQ7680PY1, BSVQ7690PY1, BSVQ7700PY1, BSVQ7710PY1, BSVQ7720PY1, BSVQ7730PY1, BSVQ7740PY1, BSVQ7750PY1, BSVQ7760PY1, BSVQ7770PY1, BSVQ7780PY1, BSVQ7790PY1, BSVQ7800PY1, BSVQ7810PY1, BSVQ7820PY1, BSVQ7830PY1, BSVQ7840PY1, BSVQ7850PY1, BSVQ7860PY1, BSVQ7870PY1, BSVQ7880PY1, BSVQ7890PY1, BSVQ7900PY1, BSVQ7910PY1, BSVQ7920PY1, BSVQ7930PY1, BSVQ7940PY1, BSVQ7950PY1, BSVQ7960PY1, BSVQ7970PY1, BSVQ7980PY1, BSVQ7990PY1, BSVQ8000PY1, BSVQ8010PY1, BSVQ8020PY1, BSVQ8030PY1, BSVQ8040PY1, BSVQ8050PY1, BSVQ8060PY1, BSVQ8070PY1, BSVQ8080PY1, BSVQ8090PY1, BSVQ8100PY1, BSVQ8110PY1, BSVQ8120PY1, BSVQ8130PY1, BSVQ8140PY1, BSVQ8150PY1, BSVQ8160PY1, BSVQ8170PY1, BSVQ8180PY1, BSVQ8190PY1, BSVQ8200PY1, BSVQ8210PY1, BSVQ8220PY1, BSVQ8230PY1, BSVQ8240PY1, BSVQ8250PY1, BSVQ8260PY1, BSVQ8270PY1, BSVQ8280PY1, BSVQ8290PY1, BSVQ8300PY1, BSVQ8310PY1, BSVQ8320PY1, BSVQ8330PY1, BSVQ8340PY1, BSVQ8350PY1, BSVQ8360PY1, BSVQ8370PY1, BSVQ8380PY1, BSVQ8390PY1, BSVQ8400PY1, BSVQ8410PY1, BSVQ8420PY1, BSVQ8430PY1, BSVQ8440PY1, BSVQ8450PY1, BSVQ8460PY1, BSVQ8470PY1, BSVQ8480PY1, BSVQ8490PY1, BSVQ8500PY1, BSVQ8510PY1, BSVQ8520PY1, BSVQ8530PY1, BSVQ8540PY1, BSVQ8550PY1, BSVQ8560PY1, BSVQ8570PY1, BSVQ8580PY1, BSVQ8590PY1, BSVQ8600PY1, BSVQ8610PY1, BSVQ8620PY1, BSVQ8630PY1, BSVQ8640PY1, BSVQ8650PY1, BSVQ8660PY1, BSVQ8670PY1, BSVQ8680PY1, BSVQ8690PY1, BSVQ8700PY1, BSVQ8710PY1, BSVQ8720PY1, BSVQ8730PY1, BSVQ8740PY1, BSVQ8750PY1, BSVQ8760PY1, BSVQ8770PY1, BSVQ8780PY1, BSVQ8790PY1, BSVQ8800PY1, BSVQ8810PY1, BSVQ8820PY1, BSVQ8830PY1, BSVQ8840PY1, BSVQ8850PY1, BSVQ8860PY1, BSVQ8870PY1, BSVQ8880PY1, BSVQ8890PY1, BSVQ8900PY1, BSVQ8910PY1, BSVQ8920PY1, BSVQ8930PY1, BSVQ8940PY1, BSVQ8950PY1, BSVQ8960PY1, BSVQ8970PY1, BSVQ8980PY1, BSVQ8990PY1, BSVQ9000PY1, BSVQ9010PY1, BSVQ9020PY1, BSVQ9030PY1, BSVQ9040PY1, BSVQ9050PY1, BSVQ9060PY1, BSVQ9070PY1, BSVQ9080PY1, BSVQ9090PY1, BSVQ9100PY1, BSVQ9110PY1, BSVQ9120PY1, BSVQ9130PY1, BSVQ9140PY1, BSVQ9150PY1, BSVQ9160PY1, BSVQ9170PY1, BSVQ9180PY1, BSVQ9190PY1, BSVQ9200PY1, BSVQ9210PY1, BSVQ9220PY1, BSVQ9230PY1, BSVQ9240PY1, BSVQ9250PY1, BSVQ9260PY1, BSVQ9270PY1, BSVQ9280PY1, BSVQ9290PY1, BSVQ9300PY1, BSVQ9310PY1, BSVQ9320PY1, BSVQ9330PY1, BSVQ9340PY1, BSVQ9350PY1, BSVQ9360PY1, BSVQ9370PY1, BSVQ9380PY1, BSVQ9390PY1, BSVQ9400PY1, BSVQ9410PY1, BSVQ9420PY1, BSVQ9430PY1, BSVQ9440PY1, BSVQ9450PY1, BSVQ9460PY1, BSVQ9470PY1, BSVQ9480PY1, BSVQ9490PY1, BSVQ9500PY1, BSVQ9510PY1, BSVQ9520PY1, BSVQ9530PY1, BSVQ9540PY1, BSVQ9550PY1, BSVQ9560PY1, BSVQ9570PY1, BSVQ9580PY1, BSVQ9590PY1, BSVQ9600PY1, BSVQ9610PY1, BSVQ9620PY1, BSVQ9630PY1, BSVQ9640PY1, BSVQ9650PY1, BSVQ9660PY1, BSVQ9670PY1, BSVQ9680PY1, BSVQ9690PY1, BSVQ9700PY1, BSVQ9710PY1, BSVQ9720PY1, BSVQ9730PY1, BSVQ9740PY1, BSVQ9750PY1, BSVQ9760PY1, BSVQ9770PY1, BSVQ9780PY1, BSVQ9790PY1, BSVQ9800PY1, BSVQ9810PY1, BSVQ9820PY1, BSVQ9830PY1, BSVQ9840PY1, BSVQ9850PY1, BSVQ9860PY1, BSVQ9870PY1, BSVQ9880PY1, BSVQ9890PY1, BSVQ9900PY1, BSVQ9910PY1, BSVQ9920PY1, BSVQ9930PY1, BSVQ9940PY1, BSVQ9950PY1, BSVQ9960PY1, BSVQ9970PY1, BSVQ9980PY1, BSVQ9990PY1, BSVQ10000PY1, BSVQ10001PY1, BSVQ10002PY1, BSVQ10003PY1, BSVQ10004PY1, BSVQ10005PY1, BSVQ10006PY1, BSVQ10007PY1, BSVQ10008PY1, BSVQ10009PY1, BSVQ10010PY1, BSVQ10011PY1, BSVQ10012PY1, BSVQ10013PY1, BSVQ10014PY1, BSVQ10015PY1, BSVQ10016PY1, BSVQ10017PY1, BSVQ10018PY1, BSVQ10019PY1, BSVQ10020PY1, BSVQ10021PY1, BSVQ10022PY1, BSVQ10023PY1, BSVQ10024PY1, BSVQ10025PY1, BSVQ10026PY1, BSVQ10027PY1, BSVQ10028PY1, BSVQ10029PY1, BSVQ10030PY1, BSVQ10031PY1, BSVQ10032PY1, BSVQ10033PY1, BSVQ10034PY1, BSVQ10035PY1, BSVQ10036PY1, BSVQ10037PY1, BSVQ10038PY1, BSVQ10039PY1, BSVQ10040PY1, BSVQ10041PY1, BSVQ10042PY1, BSVQ10043PY1, BSVQ10044PY1, BSVQ10045PY1, BSVQ10046PY1, BSVQ10047PY1, BSVQ10048PY1, BSVQ10049PY1, BSVQ10050PY1, BSVQ10051PY1, BSVQ10052PY1, BSVQ10053PY1, BSVQ10054PY1, BSVQ10055PY1, BSVQ10056PY1, BSVQ10057PY1, BSVQ10058PY1, BSVQ10059PY1, BSVQ10060PY1, BSVQ10061PY1, BSVQ10062PY1, BSVQ10063PY1, BSVQ10064PY1, BSVQ10065PY1, BSVQ10066PY1, BSVQ10067PY1, BSVQ10068PY1, BSVQ10069PY1, BSVQ10070PY1, BSVQ10071PY1, BSVQ10072PY1, BSVQ10073PY1, BSVQ10074PY1, BSVQ10075PY1, BSVQ10076PY1, BSVQ10077PY1, BSVQ10078PY1, BSVQ10079PY1, BSVQ10080PY1, BSVQ10081PY1, BSVQ10082PY1, BSVQ10083PY1, BSVQ10084PY1, BSVQ10085PY1, BSVQ10086PY1, BSVQ10087PY1, BSVQ10088PY1, BSVQ10089PY1, BSVQ10090PY1, BSVQ10091PY1, BSVQ10092PY1, BSVQ10093PY1, BSVQ10094PY1, BSVQ10095PY1, BSVQ10096PY1, BSVQ10097PY1, BSVQ10098PY1, BSVQ10099PY1, BSVQ10100PY1, BSVQ10101PY1, BSVQ10102PY1, BSVQ10103PY1, BSVQ10104PY1, BSVQ10105PY1, BSVQ10106PY1, BSVQ10107PY1, BSVQ10108PY1, BSVQ10109PY1, BSVQ10110PY1, BSVQ10111PY1, BSVQ10112PY1, BSVQ10113PY1, BSVQ10114PY1, BSVQ10115PY1, BSVQ10116PY1, BSVQ10117PY1, BSVQ10118PY1, BSVQ10119PY1, BSVQ10120PY1, BSVQ10121PY1, BSVQ10122PY1, BSVQ10123PY1, BSVQ10124PY1, BSVQ10125PY1, BSVQ10126PY1, B

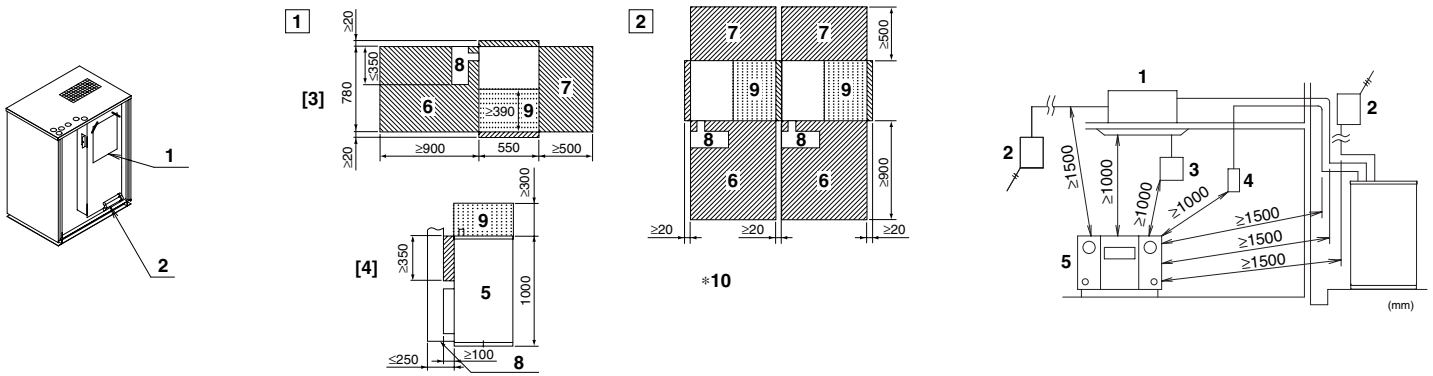

figure 1

figure 2

figure 3

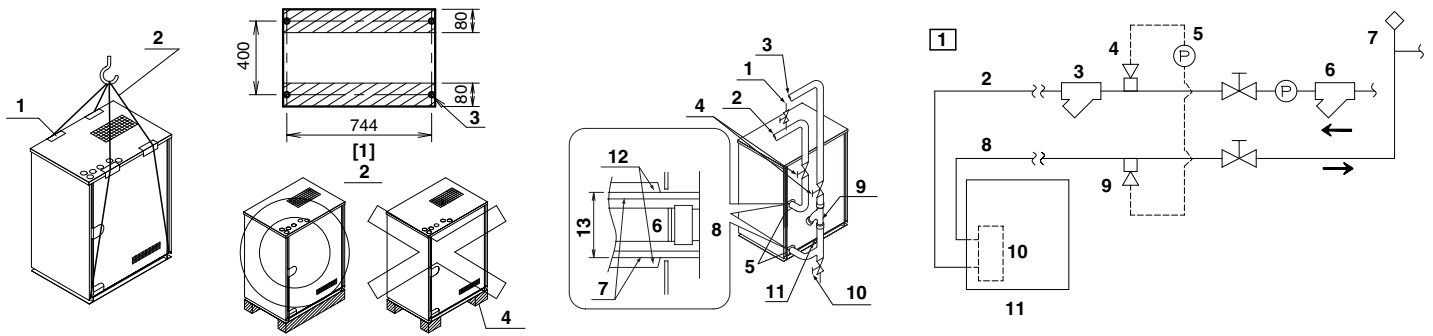

figure 4

figure 5

figure 6

figure 7

[Heat pump system]

[Heat recovery system]

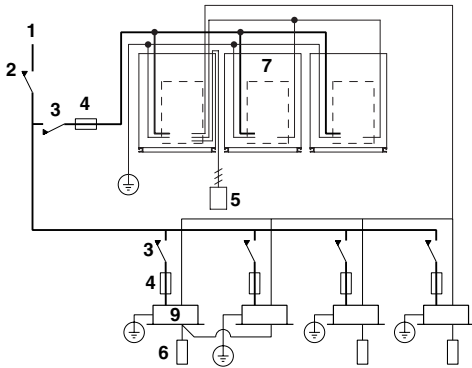

figure 8

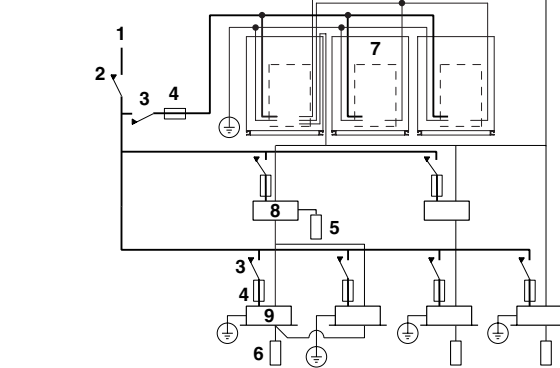

figure 9

[Heat pump system]

[Heat recovery system]

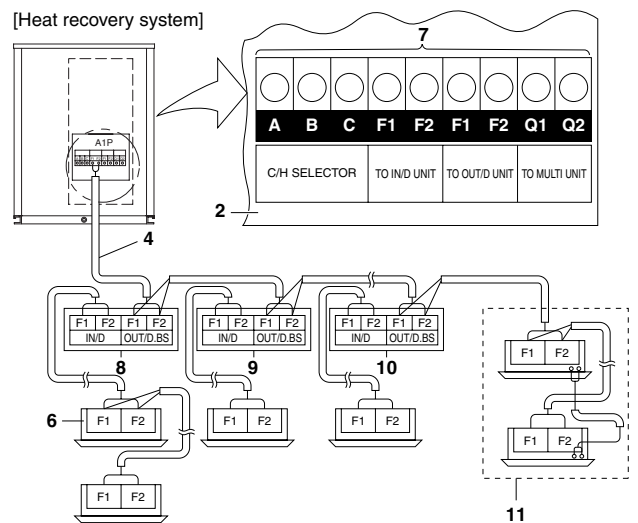
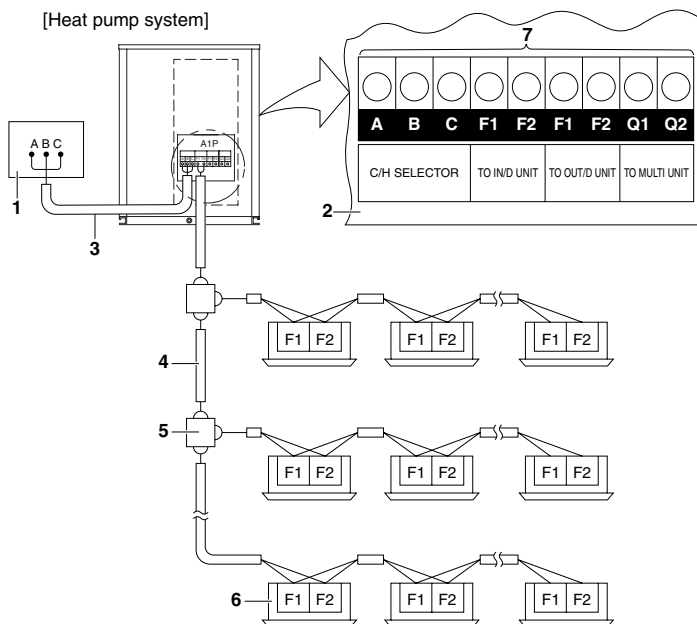

figure 10

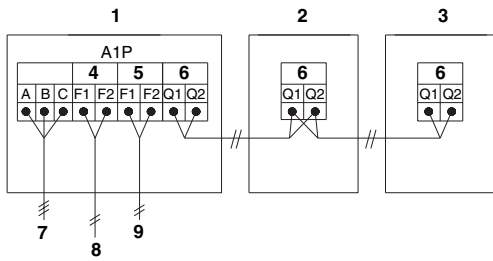

figure 11

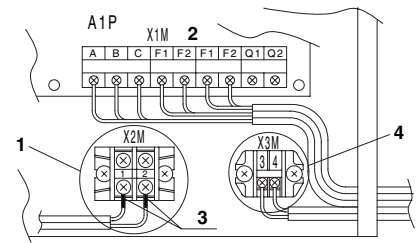

figure 12

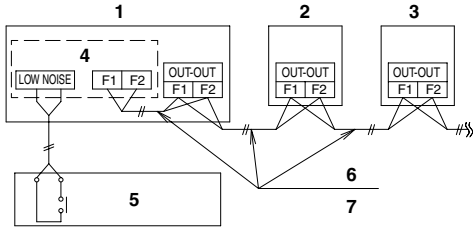

figure 13

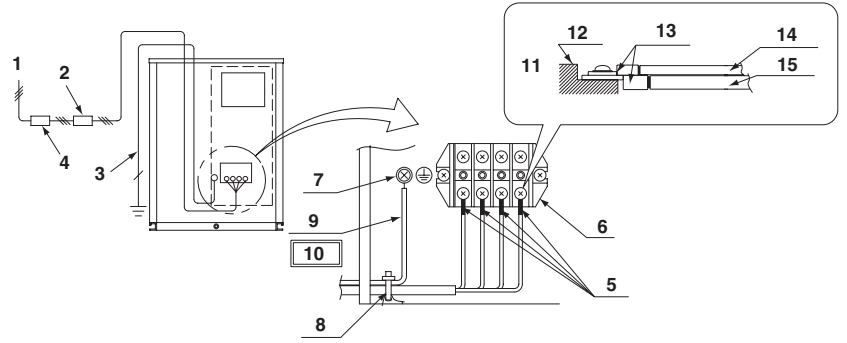

figure 14

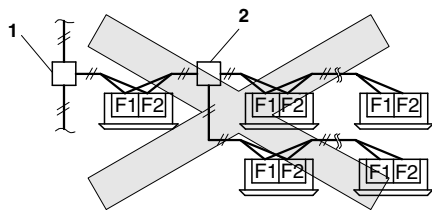

figure 15

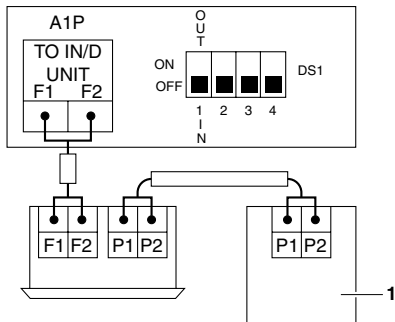

figure 16

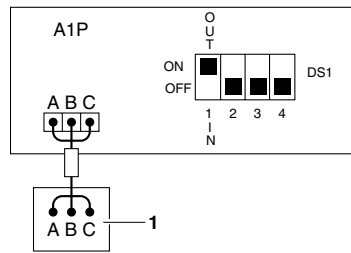

figure 17

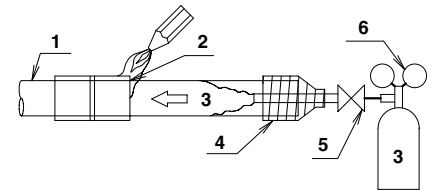

figure 18

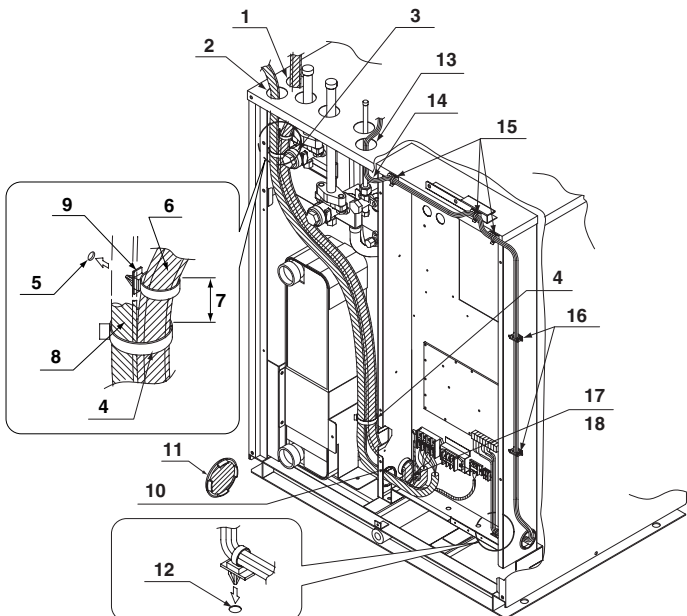

figure 19

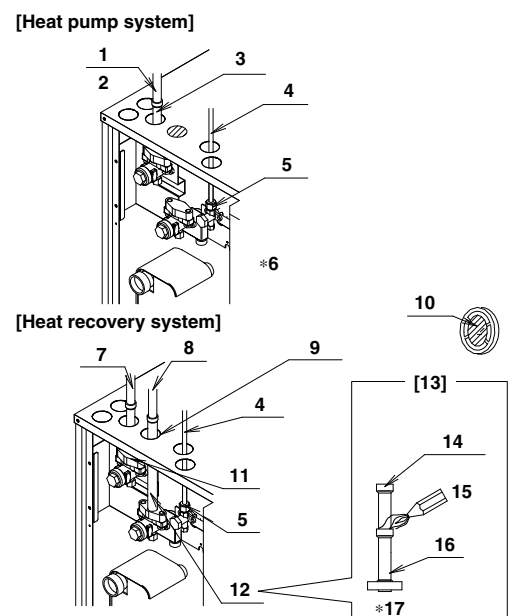

figure 20

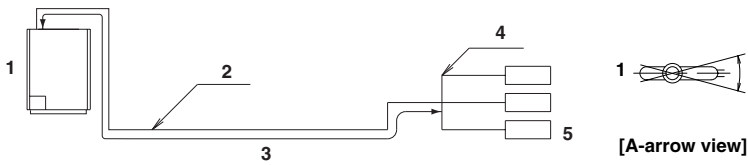

figure 21

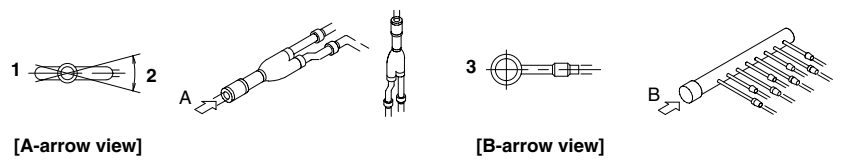

figure 22

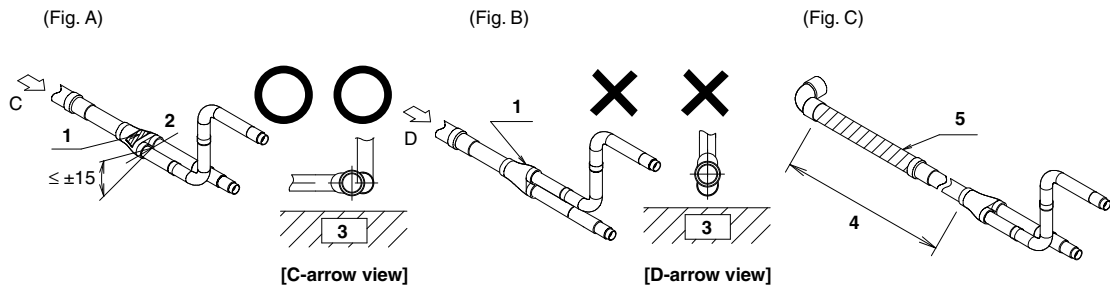
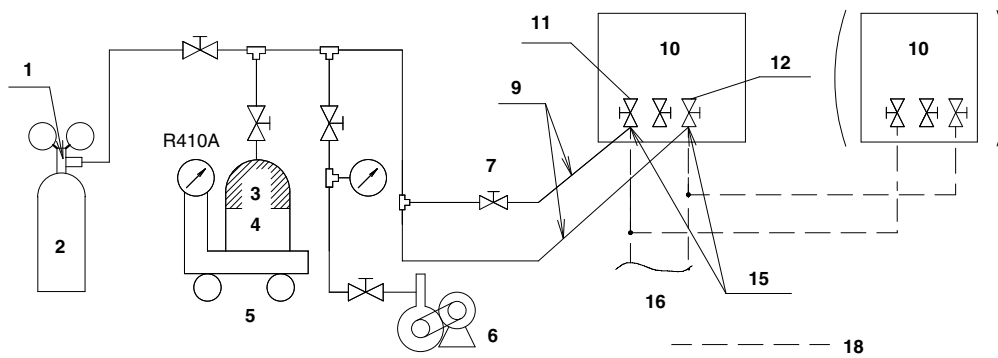

figure 23

[Heat pump system]



[Heat recovery system]

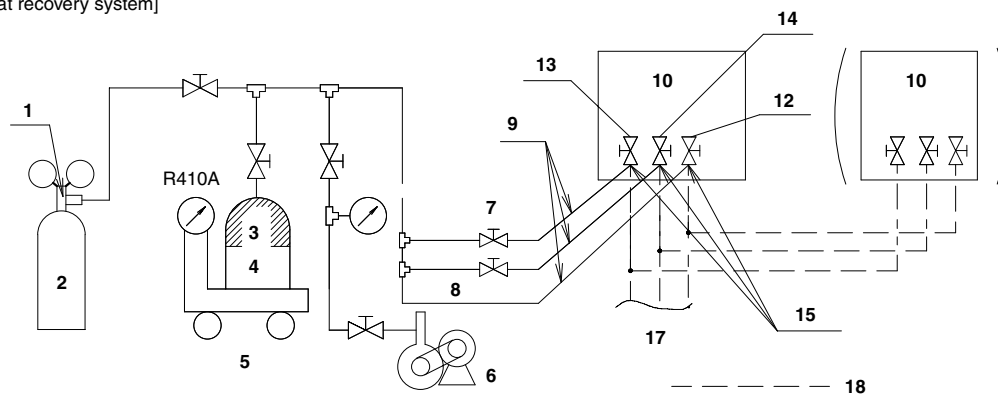

figure 24

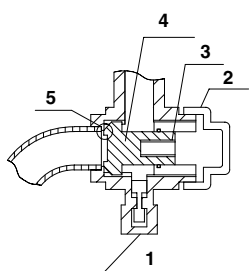

figure 25

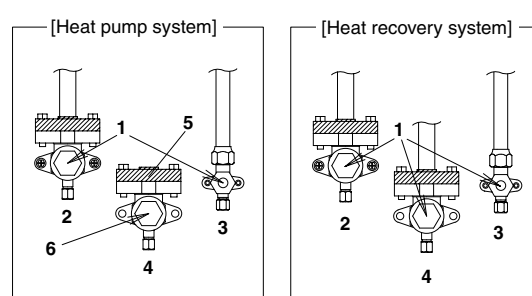

figure 26

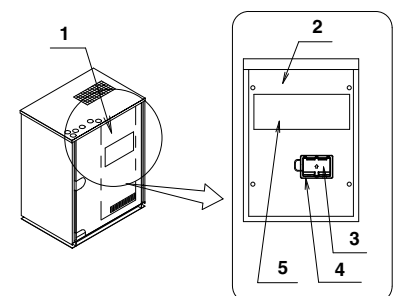

figure 27

CONTENTS

1. SAFETY PRECAUTIONS 1
 2. INTRODUCTION..... 2
 2-1. Combination 2
 2-2. Standard operation limit 3
 2-3. Standard supplied accessories 3
 2-4. Option accessory 3
 2-5. Technical and electrical specifications 3
 3. SELECTION OF LOCATION 3
 4. INSPECTING AND HANDLING THE UNIT 4
 5. UNPACKING AND PLACING THE UNIT 4
 6. WATER PIPING WORK..... 4
 7. HANDLING OF THE BRAZED PLATE TYPE HEAT EXCHANGER 4
 7-1. When designing the equipment 4
 7-2. Before starting a test run..... 5
 7-3. Daily service and maintenance 5
 7-4. Water quality 5
 7-5. Maintenance of plate type heat exchanger 5
 8. FIELD WIRING 6
 8-1. Optional parts..... 6
 8-2. Power circuit and cable requirements..... 6
 8-3. General 6
 8-4. Examples 7
 8-5. In case of a local setting 8
 9. REFRIGERANT PIPING 9
 9-1. Selection of piping material..... 9
 9-2. Protection against contamination when installing pipes.... 9
 9-3. Pipe connection 9
 9-4. Connecting the refrigerant piping..... 10
 9-5. Example of connection..... 11
 9-6. Air tight test and vacuum drying..... 13
 9-7. Pipe insulation..... 13
 9-8. Checking of device and installation conditions 13
 9-9. Additional refrigerant charge 13
 9-10. Shutoff valve operation procedure 14
 10. CHECKS AFTER INSTALLATION..... 14
 11. TEST RUN 14
 11-1. Air discharge 14
 11-2. Before turn on the power supply 14
 11-3. Check operation 14
 11-4. Check of normal operation 15
 12. CAUTION FOR REFRIGERANT LEAKS 16

Important information regarding the refrigerant used

This product contains fluorinated greenhouse gases covered by the Kyoto Protocol. Do not vent gases into the atmosphere.

Refrigerant type: R410A

GWP⁽¹⁾ value: 1975

⁽¹⁾ GWP = global warming potential

Please fill in with indelible ink,

- ① the factory refrigerant charge of the product,
- ② the additional refrigerant amount charged in the field and
- ①+② the total refrigerant charge

on the refrigerant charge label supplied with the product.

The filled out label must be adhered in the proximity of the product charging port (e.g. onto the inside of the service cover).

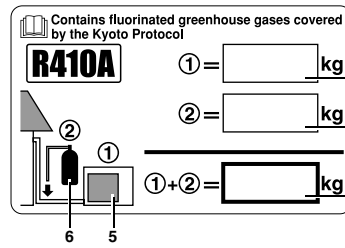

- 1 factory refrigerant charge of the product: see unit name plate⁽²⁾
- 2 additional refrigerant amount charged in the field
- 3 total refrigerant charge
- 4 Contains fluorinated greenhouse gases covered by the Kyoto Protocol
- 5 outdoor unit
- 6 refrigerant cylinder and manifold for charging

⁽²⁾ In case of multiple outdoor systems, only 1 label must be adhered, mentioning the total factory refrigerant charge of all outdoor units connected on the refrigerant system.

1. SAFETY PRECAUTIONS

Please read these “SAFETY PRECAUTIONS” carefully before installing air conditioning unit and be sure to install it correctly. After completing installation, conduct a trial operation to check for faults and explain to the customer how to operate the air conditioner and take care of it with the aid of the operation manual. Ask the customer to store the installation manual along with the operation manual for future reference.

This air conditioner comes under the term “appliances not accessible to the general public”.

(Safety Precaution)

VRV System is a class A product. In a domestic environment this product may cause radio interference in which case the user may be required to take adequate measures.

Meaning of WARNING and CAUTION notices

WARNING Failure to follow these instructions properly may result in personal injury or loss of life.

CAUTION Failure to observe these instructions properly may result in property damage or personal injury, which may be serious depending on the circumstances.

WARNING

- Ask your dealer or qualified personnel to carry out installation work. Do not attempt to install the air conditioner yourself. Improper installation may result in water leakage, electric shocks or fire.
- Install the air conditioner in accordance with the instructions in this installation manual. Improper installation may result in water leakage, electric shocks or fire.
- When installing the unit in a small room, take measures against to keep refrigerant concentration from exceeding allowable safety limits in the event of refrigerant leakage. Contact the place of purchase for more information. Excessive refrigerant in a closed ambient can lead to oxygen deficiency.
- Be sure to use only the specified accessories and parts for installation work. Failure to use the specified parts may result in the unit falling, water leakage, electric shocks or fire.
- Install the air conditioner on a foundation strong enough to withstand the weight of the unit. A foundation of insufficient strength may result in the equipment falling and causing injury.
- Carry out the specified installation work after taking into account strong winds, typhoons or earthquakes. Failure to do so during installation work may result in the unit falling and causing accidents.

- Make sure that a separate power supply circuit is provided for this unit and that all electrical work is carried out by qualified personnel according to local laws and regulations and this installation manual. An insufficient power supply capacity or improper electrical construction may lead to electric shocks or fire.
- Make sure that all wiring is secured, the specified wires are used, and that there is no strain on the terminal connections or wires. Improper connections or securing of wires may result in abnormal heat build-up or fire.
- When wiring the power supply and connecting the remote controller wiring and transmission wiring, position the wires so that the control box lid can be securely fastened. Improper positioning of the control box lid may result in electric shocks, fire or the terminals overheating.
- If refrigerant gas leaks during installation, ventilate the area immediately. Toxic gas may be produced if the refrigerant gas comes into contact with fire.
- After completing installation, check for refrigerant gas leakage. Toxic gas may be produced if the refrigerant gas leaks into the room and comes into contact with a source of fire, such as a fan heater, stove or cooker.
- Be sure to switch off the unit before touching any electrical parts.
- Do not directly touch refrigerant that has leaked from refrigerant pipes or other areas, as there is a danger of frostbite.
- Do not allow children to climb on the outside unit and avoid placing objects on the unit. Injury may result if the unit becomes loose and falls.
- Be sure to earth the air conditioner. Do not earth the unit to a utility pipe, lightning conductor or telephone earth lead. Imperfect earthing may result in electric shocks or fire. A high surge current from lightning or other sources may cause damage to the air conditioner.
- Be sure to install an earth leakage breaker. Failure to install an earth leakage breaker may result in electric shocks or fire.

CAUTION

- While following the instructions in this installation manual, install drain piping to ensure proper drainage and insulate piping to prevent condensation. Improper drain piping may result in indoor water leakage and property damage.
- Install the indoor and outside units, power cord and connecting wires at least 1 meter away from televisions or radios to prevent picture interference and noise. (Depending on the incoming signal strength, a distance of 1 meter may not be sufficient to eliminate noise.)
- Remote controller (wireless kit) transmitting distance can be shorter than expected in rooms with electronic fluorescent lamps (inverter or rapid start types). Install the indoor unit as far away from fluorescent lamps as possible.
- Make sure to provide for adequate measures in order to prevent that the outside unit be used as a shelter by small animals. Small animals making contact with electrical parts can cause malfunctions, smoke or fire. Please instruct the customer to keep the area around the unit clean.
- Install in a machine room that is free of moisture. The unit is designed for indoor use.
- Do not install the air conditioner in the following locations:
 1. Where there is a high concentration of mineral oil spray or vapour (e.g. a kitchen). Plastic parts will deteriorate, parts may fall off and water leakage could result.
 2. Where corrosive gas, such as sulphurous acid gas, is produced. Corroding of copper pipes or soldered parts may result in refrigerant leakage.
 3. Near machinery emitting electromagnetic radiation. Electromagnetic radiation may disturb the operation of the control system and result in a malfunction of the unit.
 4. Where flammable gas may leak, where there is carbon fibre or ignitable dust suspensions in the air, or where volatile flammables such as paint thinner or gasoline are handled. Operating the unit in such conditions may result in fire.

Disposal requirements

Dismantling of the unit, treatment of the refrigerant, of oil and of other parts must be done in accordance with relevant local and national legislation.

CAUTION

The refrigerant R410A requires that strict precautions be observed for keeping the system clean, dry and tightly sealed.

A. Clean and dry

Strict measures must be taken to keep impurities (including SUNISO oil and other mineral oils as well as moisture) out of the system.

B. Tightly sealed

R410A contains no chlorine, does not destroy the ozone layer and so does not reduce the earth's protection against harmful ultraviolet radiation. R410A will contribute only slightly to the greenhouse effect if released into the atmosphere. Therefore, sealing tightness is particularly important in installation. Carefully read the chapter "REFRIGERANT PIPING" and strictly observe the correct procedures.

Since design pressure is 4.0 MPa or 40 bar (for R407C units: 3.3 MPa or 33 bar), the thickness of pipes must be greater than previously. Since R410A is a mixed refrigerant, the required additional refrigerant must be charged in its liquid state. (If the system is charged with refrigerant in its gaseous state, due to composition change, the system will not function normally.) The indoor unit is designed for R410A use. See the catalogue for indoor unit models that can be connected. (Normal operation is not possible when connecting units that are originally designed for other refrigerants.)

2. INTRODUCTION

This installation manual concerns VRV inverters of the Daikin RWEYQ-P series. These units are designed for indoor installation and used for cooling and heatpump applications.

The RWEYQ-P units can be combined with Daikin VRV series indoor units for air conditioning purposes.

The present installation manual describes the procedures for unpacking, installing and connecting the RWEYQ-P units. Installation of the indoor units is not described in this manual. Always refer to the installation manual supplied with these units for their installation.

2-1 Combination

The indoor units can be installed in the following range.

- **Always use appropriate indoor units compatible with R410A. To lean which models of indoor units are compatible with R410A, refer to the product catalogs.**

Total capacity of indoor units (Outside unit)	(Total capacity index of indoor units)
RWEYQ8PY1	100 ~ 260
RWEYQ10PY1	125 ~ 325
RWEYQ16PY1	200 ~ 520
RWEYQ18PY1	225 ~ 585
RWEYQ20PY1	250 ~ 650
RWEYQ24PY1	300 ~ 780
RWEYQ26PY1	325 ~ 845
RWEYQ28PY1	350 ~ 910
RWEYQ30PY1	375 ~ 975

2-2 Standard operation limit

The figures below assume following operating conditions for indoor and outside units:

Equivalent pipe length7.5m
Level difference0m

Cooling

Heating

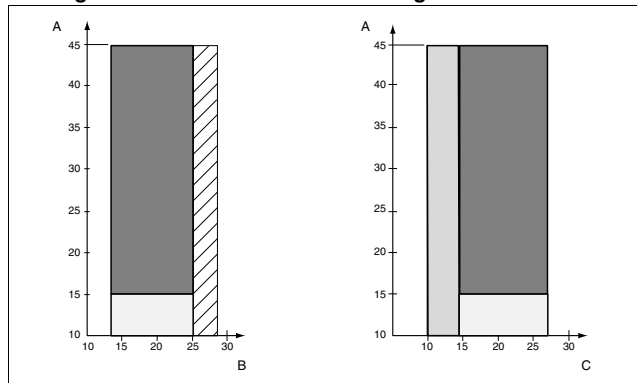

- A Inlet water temperature (°C)
B Indoor temperature (°CWB)
C Indoor temperature (°CDB)
- Range for continuous operation
□ Range for operation
▨ Range for pull down operation
■ Range for warming up operation

- Operation range of water volume is **50-150L/min**
- **The unit is designed for the following operation range:**
Water temperature: 20-35°C
Water volume: 60 L/minute or more
- During cooling operation when the outside temperature is very low, it is possible that the thermostat switches off automatically in order to protect the unit from freezing.
- Hold ambient temperature at 0-40°C
Heat-release from the unit: 0.71 kW/10Hp/hour.
It is therefore recommended to always ventilate the room.

2-3 Standard supplied accessories

- Make sure that the following accessories are included.
(Check by removing the front panel.)

Name	Accessory pipes		
	(1)	(2)	(3)
Quantity	1 pc.	1 pc.	1 pc.
Shape			
Name	Clamp (A)	Clamp (B)	[Others] • Installation manual • Operation manual • Declaration of conformity
Quantity	7 pcs.	2 pcs.	
Shape			

(Refer to figure 1)

- Operation manual
• Installation manual
• Declaration of conformity
• Clamp (A)
• Clamp (B)
- Accessory pipe (1)
• Accessory pipe (2)
• Accessory pipe (3)

Note

The accessory pipe (1), (3) is not used for the heat pump system.

2-4 Option accessory

To install the above outside units, the following optional parts are also required.

- Refrigerant branching kit
(For R410A only: Always use an appropriate kit dedicated for your system.)

(Heat pump system)

REFNET header	KHRP26M22H	KHRP26M33H	KHRP26M72H	KHRP26M73H
REFNET joint	KHRP26A22T	KHRP26A33T	KHRP26A72T	KHRP26A73T

(Heat recovery system For 3-tube piping)

REFNET header	KHRP25M22H	KHRP25M33H	KHRP25M72H	KHRP25M73H
REFNET joint	KHRP25A22T	KHRP25A33T	KHRP25A72T	KHRP25A73T

(Heat recovery system For 2-tube piping)

REFNET header	KHRP26M22H	KHRP26M33H	KHRP26M72H	KHRP26M73H
REFNET joint	KHRP26A22T	KHRP26A33T	KHRP26A72T	KHRP26A73T

- Outside unit multi connection piping kit
(For R410A only: Always use an appropriate kit dedicated for your system.)

Number of outside units connected	2 units	3 units
Heat pump system	BHFP22MA56	BHFP22MA84
Heat recovery system	BHFP26MA56	BHFP26MA84

* To select an optimum kit, refer to "9. REFRIGERANT PIPING"

2-5 Technical and electrical specifications

Refer to the Engineering Data Book for the complete list of specifications.

3. SELECTION OF LOCATION

This unit does not have specifications for outdoor installation. The unit must be installed indoors (example: machine room, ...) Always install it in a room. (machine room, etc.)

Paying attention to the conditions mentioned below, select the place for installation with a prior approval of customer.

1. The foundation is strong enough to support the weight of the unit and the floor is flat to prevent vibration and noise generation.
2. Consider the space required for refrigerant piping work when installing. Refer to [Necessary Space].
3. There is no danger of fire due to leakage of inflammable gas.
4. The piping length between the outside unit and the indoor unit may not exceed the allowable piping length. "9. REFRIGERANT PIPING".
5. Locations where the noise of the unit operating will not disturb nearby houses, etc.
6. Locations with airflow and ventilation holes capable of dissipating heat from the machine and where the ambient temperature around the outside unit is between 0 and 40°C and the humidity does not exceed 80%.

[Necessary Space]

When installing, secure the space mentioned below without fail.

(Refer to figure 2)

1. In case of a single installation [mm]
2. In case of series installations [mm]
3. Top view
4. Side view
5. Outside unit
6. Service Space (front side)
7. Service Space (back side)
8. Space for installing water piping
*Secure a enough space for removing the front panel.
9. Ventilation Space
*above the area (.....) of the outside unit.
10. Secure spaces in the front, back and top sides as same as the case of single installation.

Caution

1. An inverter air conditioner may cause electronic noise generated from AM broadcasting. Examine where to install the main air conditioner and electric wires, keeping proper distances away from stereo equipment, personal computers, etc.

(Refer to figure 3)

1. Indoor unit
2. Branch switch, overcurrent breaker

3. Remote controller
4. Cool/heat selector
5. Personal computer or radio

If the electric wave of AM broadcasting is particularly weak, keep distances of 3m or more and use conduit tubes for power and transmission lines.

2. Water quality

Water containing high level of foreign materials may cause the corrosion of heat exchanger and piping or scale accumulation. Use water satisfying "7-4 Water quality".

3. Cooling tower

Use a closed type cooling tower without fail. (Open type tower cannot be used.)

4. Strainer



Install a strainer (an optional accessory) without fail at the inlet of water piping. (If sands, wastes, rust particles, etc. are mixed in the water circulation system, damage to the plate type heat exchanger may be caused by the corrosion of metal materials and clogging of the heat exchanger.)

5. The refrigerant R410A itself is nontoxic, nonflammable and is safe. If the refrigerant should leak however, its concentration may exceed the allowable limit depending on room size. Due to this it could be necessary to take measures against leakage. Refer to the chapter "CAUTION FOR REFRIGERANT LEAKS".

4. INSPECTING AND HANDLING THE UNIT

At delivery, the package should be checked and any damage should be reported immediately to the carrier claims agent.

When handling the unit, take into account the following:

1.  Fragile, handle the unit with care.
2.  Keep the unit upright in order to avoid compressor damage.
3. Choose the path along which the unit is to be brought in ahead of time.
4. In order to prevent any damage to the unit during installation, use slings (cloth) or patch plates and lift the unit referring to figure 4.
5. Lift the unit preferably with a crane and 2 belts of at least 4m long.
6. Use patch plates or clothes where the belt may hit the casing in order to prevent the casing from being damaged.
7. Be sure use the standard supplied accessories and dedicated parts as installation parts.

(Refer to figure 4)

1. Patch plates or clothes
2. Belt sling

Note

- Use belt sling of 20mm width or less which adequately bears the weight of the product.

5. UNPACKING AND PLACING THE UNIT

- Make sure the area around the machine drains properly by setting up drainage grooves around the foundation.
- Make sure the unit is installed level on a sufficiently strong base to prevent vibration and noise.
- Secure the unit to its base using foundation bolts. (Use four commercially available M12-type foundation bolts, nuts, and washers.)
- The foundation bolts should be inserted 20 mm.
- Fix 4 foundation bolts.
- Support the unit with the foundation which is larger than the hatched area shown in figure 5.

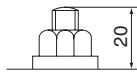

(Refer to figure 5)

1. Front side
2. Position of foundation bolts
3. Hole for a foundation bolt (φ17 holes at 4 corners)
4. Avoid such a foundation where the unit is supported by 4 corner points.



Caution

- When installing the unit closely contacting the wall for any unavoidable reason, arrange so that no vibration from the unit may be transmitted to the wall surface by insulating the vibration using cushions, etc.

6. WATER PIPING WORK

- The water pressure resistance of water piping of this outside unit is 1.96 MPa.
- The pipe connection on the unit is made of stainless steel. Connecting a water pipe made of a material other than stainless steel may result in corrosion of the pipe. Take preventive measures as necessary, for example by insulating the connection on the water pipe.
- The connection port for water piping is located in the front. The connection ports for drain piping are located in the front and back. When using the back port, change the cast iron plug from the back to the front and securely close it.
- Because of indoor use, carry out piping work in such a way no water may drop on the outer plate.
- Drain piping should be short and have a slant downwards. The diameter of drain pipe should be the same as the diameter of unit connection (1/2B) or larger.
- The diameter of water pipe should be the same as the diameter of unit connection (1-1/4) or larger.
- Install an air purge valve in the midway of the water piping to prevent cavitation.
- After completing the drain piping work, make sure that the water runs smoothly without any clogging by dust.
- Do not connect the drain outlet to the water outlet.
- Install a strainer (an optional accessory) in the inlet of water piping within a distance of 1.5 m from the outside unit. (If sand, waste or rust particles are mixed in the water circulation system, metal materials will become corrosive.)
- Install insulation up to the base of heat exchanger as shown in the figure 6.
- Install a gate valve for chemical cleaning in an easy position to handle.
- Use water pipes complied with the local and national codes.
- Run the water pump to flush inside of water piping. Then, clean the strainer.
- If there is a possibility of freezing, take measures to prevent freezing.
- Tighten securely the connection of water piping and socket with tightening torque of 300 N·m or less. (If a larger torque is applied, the unit may be damaged.)

(Refer to figure 6)

1. Air purge
2. Outlet of water
3. Inlet of water
4. Gate valve
5. Water piping socket
6. Water piping
7. Insulation
8. Heat exchanger
9. Strainer (an optional accessory)
10. Drain valve
11. Connection port to draining piping
12. Insulation cover
13. 80 mm or less

7. HANDLING OF THE BRAZED PLATE TYPE HEAT EXCHANGER



Caution

A brazed plate type heat exchanger is used for this unit. Because its structure is different from a conventional type heat exchanger, it must be handled in a different manner.

7-1 When designing the equipment

1. Install a strainer (an optional accessory) at the water inlet side adjacent to the outside unit in order to prevent any foreign materials such as dust, sand, etc. from entering.
2. Depending on the water quality, scale may stick to the plate type heat exchanger. In order to remove this scale, it is necessary to clean it at a regular interval using chemicals. To this end, install a gate valve in the water piping. Set up a piping connection port on the piping between this gate valve and the outside unit for cleaning by chemicals.
3. For the purpose of cleaning and water drain off from the outside unit (water draining during a long period of non-use in winter, draining upon starting of season-off), install an "air discharge plug" and a "water draining plug" at the inlet/outlet ports of water piping. In addition, install an "automatic air discharging valve" at the top of riser piping or at the top of a portion where air tends to stay.
4. Independent of the piping inlet of the outside unit, install a cleanable strainer at a portion close to the pump piping inlet.

5. Carry out complete cooling/thermal insulation of water piping and outdoor dehumidification. If complete cooling or thermal insulation has not been carried out, any damage may be caused during severe winter due to freezing, in addition to thermal loss.
6. When you stop operation during night or winter, it is necessary to take measures to prevent water related circuits from natural freezing in the area the ambient temperature drops below 0°C (by water drain off, keeping the circulation pump running, warming up by a heater, etc.) Freezing of water related circuits may result in any damage to the plate type heat exchanger. Therefore, please take appropriate measures depending on the circumstances of use.

(Refer to figure 7)

1. Example of piping
2. Water inlet piping
3. Strainer (sold separately as an accessory)
4. Air discharge plug (for joint use with cleaning port)
5. Cleaning device
6. Strainer for pump
7. Automatic air discharge valve
8. Water outlet piping
9. Joint use with water draining plug
10. Plate type heat exchanger
11. Outside unit

7-2 Before starting a test run

1. Before starting a test run, please make sure that the piping work has been carried out in a proper manner. Especially, make sure that the strainer, air discharge valve, automatic water supply valve, expansion tank and cistern are positioned at their places correctly.
2. After water has been completely filled in, first run the pump only, and then make sure that no air has been caught in the water circulation system and the water flow rate is correct. If any air has been caught or the flow rate is not enough, the plate type heat exchanger may freeze. Measure any water pressure loss before and after the outside unit and make sure that the flow rate is as designed. In case of any abnormal, stop the test run immediately and carry out trouble shooting to resolve the trouble.
3. Following the installation manual, carry out a test run of the outside unit.
4. After the test run has been completed, inspect the strainer at the inlet piping of the outside unit. Clean it if it is dirty.

7-3 Daily service and maintenance

1. Management of water quality
The plate type heat exchanger has a structure that does not permit dismantling and cleaning, or replacing any parts. Please pay attention carefully to the quality of water to be used for the plate type heat exchanger in order to prevent corrosion and sticking of scale. The water to be used for the plate type heat exchanger should have at least the quality as specified in the table below. When using any corrosion prevention agent, scale depressant agent, etc, such agent should have no corrosive features against stainless steel and copper.
2. Management of chilled water flow rate
If the chilled water flow rate is not enough, it will result in the freezing damage to the plate type heat exchanger. Check for any clogging of the strainer, any air being caught, any reduction in the flow rate due to failure of circulation pump by measuring the temperature and pressure differences at the inlet and outlet ports of the plate type heat exchanger. If the aged difference in the temperature or pressure has increased beyond the proper range, the flow rate should have decreased. Stop the operation and remove the cause before restarting the operation.
3. Steps to be taken when a freezing protection device was activated
When the freezing protection device should be activated during operation, remove the cause without fail before restarting the operation. If the freezing protection device has been once activated, a partial freezing has occurred. If you restart the operation without removing the cause, the plate type heat exchanger will be closed and the ice cannot be melted, and in addition, the freezing process will be repeated resulting in any damage to the plate type heat exchanger, leading to any such accidents that the refrigerant starts leaking or water starts entering the refrigerant circuit.

7-4 Water quality

Water quality standards for chilled water, hot water and make-up water (4) (6)

Item (5)	Cooling water system (3)		Hot water system (2)		Tendency (1)	
	Circulation system		Circulation water (20°C ~ 60°C)	Make-up water	Corrosion	Scale
	Circulation water	Make-up water				
Standard items						
pH(25°C)	6.5 to 8.2	6.0 to 8.0	7.0 to 8.0	7.0 to 8.0	○	○
Electrical Conductivity (mS/m)(25°C)	Less than 80	Less than 30	Less than 30	Less than 30	○	○
Chloride ions (mgCl/L)	Less than 200	Less than 50	Less than 50	Less than 50	○	
Sulfate ions (mgSO ₄ ²⁻ /L)	Less than 200	Less than 50	Less than 50	Less than 50	○	
Acid consumption (pH4.8) (mgCaCO ₃ /L)	Less than 100	Less than 50	Less than 50	Less than 50		○
Total hardness (mgCaCO ₃ /L)	Less than 200	Less than 70	Less than 70	Less than 70		○
Calcium hardness (mgCaCO ₃ /L)	Less than 150	Less than 50	Less than 50	Less than 50		○
Ionic-state silica (mgSiO ₂ /L)	Less than 50	Less than 30	Less than 30	Less than 30		○
Reference items						
Iron (mgFe/L)	Less than 1.0	Less than 0.3	Less than 1.0	Less than 0.3	○	○
Copper (mgCu/L)	Less than 0.3	Less than 0.1	Less than 1.0	Less than 0.1	○	
Sulfate ion (mgS ²⁻ /L)	Shall not be detected	Shall not be detected	Shall not be detected	Shall not be detected	○	
Ammonium ion (mgNH ₄ ⁺ /L)	Less than 1.0	Less than 0.1	Less than 0.3	Less than 0.1	○	
Residual chlorine (mgCl/L)	Less than 0.3	Less than 0.3	Less than 0.25	Less than 0.3	○	
Free carbon dioxide (mgCO ₂ /L)	Less than 4.0	Less than 4.0	Less than 0.4	Less than 4.0	○	
Stability index	6.0 to 7.0	—	—	—	○	○

[NOTES]

- (1) The circle marks in the columns for corrosion or scale to develop.
- (2) Corrosion has a tendency to occur when water temperature is high (40°C or higher), and if metals with no protective coating whatever are directly exposed to water, it would be a good idea to take effective measures against corrosion such as adding a corrosion inhibitor or deaeration treatment.
- (3) In a condenser water circuit that uses a closed cooling tower, the closed circuit circulating water and make-up water must satisfy its water quality standards for the hot water system, and passing water and make-up water must satisfy those for the circulation type cooling water system.
- (4) The supply water must be clean tap water, industrial water or clean underground water. Do not use purified or softened water.
- (5) The fifteen items in the table above represent typical causes of corrosion and scale.
- (6) Once through water may cause corrosion. Do not use once through water.

7-5 Maintenance of plate type heat exchanger

The performance of a plate type heat exchanger may decline due to scale accumulation. It may be damaged by freezing due to the drop of flow rate. For this reason, it is necessary to carry out programmed maintenances at a regular interval in order to prevent the scale from being generated.

1. Before entering the season for use, carry out the following inspections:
 - 1) Conduct a water quality test and make sure that it is within the standard.
 - 2) Clean the strainer.
 - 3) Make sure that the flow rate is correct.
 - 4) Make sure that the operational conditions (pressure, flow rate, outlet temperature, etc.) are normal.

2. Because the plate type heat exchanger has a structure which does not permit disassembling and cleaning, follow the following procedures for cleaning:

- 1) For maintenance purposes it is required to provide for a connection port on the water inlet and on the water outlet. You must connect a circulation pump inbetween these 2 connection ports when cleaning the plate heat exchanger with chemicals. For cleaning the scale in the plate heat exchanger it is recommended to use a solution with 5% diluted formic, citric, oxalic, acetic or phosphoric acid. Never use hydrochloric, sulfuric or nitric acid because such solutions have a strong corrosive feature.
- 2) Make sure to provide for a stopvalve in front of that inlet water pipe connection port and for a stopvalve after the outlet water pipe connection port.
- 3) Connect the piping for circulation of cleaning chemicals to the inlet piping of plate type heat exchanger. Fill the cleaning solution of 50 - 60°C for a while in the plate type heat exchanger. Then, circulate the cleaning solution by a pump for 2-5 hours. The time for cleaning depends on the temperature of cleaning solution or the degree of scale accumulation. Therefore, please watch the change of the dirtiness (color) of cleaning solution to determine the level of removal of scale.
- 4) After circulating the cleaning solution, discharge the solution from the plate type heat exchanger, fill the heat exchanger with a solution of 1-2% sodium hydroxide (NaOH) or sodium bicarbonate (NaHCO₃). Circulate this solution for 15-20 minutes for neutralization purpose.
- 5) After the process of neutralization has been completed, rinse the inner part of the plate type heat exchanger with care using fresh and clean water.
- 6) When using any cleaning agent sold in the market, check in advance that such agent has no corrosive features against stainless steel and copper.
- 7) For details of cleaning method, ask the manufacturer of related cleaning agent.

3. After cleaning has been completed, make sure that the unit can be operated in a normal fashion.

8. FIELD WIRING



Caution

- All field wiring and components must be installed by a licensed electrician and must comply with relevant local and national regulations.
- The field wiring must be carried out in accordance with the wiring diagrams and the instructions given below.
- Be sure to use a dedicated power circuit. Never use a power supply shared by another appliance.
- Do not operate until refrigerant piping work is completed. (If operated before complete the piping work, the compressor may be broken down.)
- Never remove thermistor, sensor or etc. when connecting power wiring and transmission wiring. (If operated with thermistor, sensor or etc. removed, the compressor may be broken down.)
- Be sure to install an earth leak detector. (This unit uses an inverter, so install the earth leak detector that be capable of handling high harmonics in order to prevent malfunctioning of the earth leak detector itself.)
- This product have reversed phase protection detector that only works when the product started up.
- Do not run the unit by short cutting the protection device (S1PH). If there exists the possibility of reversed phase, lose phase, momentary black out or the power goes on and off while the product is operating, attach a reversed phase protection circuit locally. Running the product in reversed phase may break the compressor and other parts.
- Attach the power wire securely.
- Introducing power with a missing N-phase or with a mistaken N-phase will break the equipment.

8-1 Optional parts

Note

- When using the adaptor for sequential start, refer to chapter "Examples".
- For connection wiring to the central remote controller, refer to the installation manual of the central remote controller.

8-2 Power circuit and cable requirements

A power circuit (see table below) must be provided for connection of the unit. This circuit must be protected with the required safety devices, i.e. a main switch, a slow blow fuse on each phase and an earth leak detector.

	Phase and frequency	Voltage	Minimum circuit amp.	Recommended fuses	Transmission line selection
RWEYQ8PY1	φ 3, 50Hz	380-415V	12.6A	25A	0.75-1.25mm ²
RWEYQ10PY1	φ 3, 50Hz	380-415V	12.6A	25A	0.75-1.25mm ²
RWEYQ16PY1	φ 3, 50Hz	380-415V	25.3A	35A	0.75-1.25mm ²
RWEYQ18PY1	φ 3, 50Hz	380-415V	25.3A	35A	0.75-1.25mm ²
RWEYQ20PY1	φ 3, 50Hz	380-415V	25.3A	35A	0.75-1.25mm ²
RWEYQ24PY1	φ 3, 50Hz	380-415V	37.9A	45A	0.75-1.25mm ²
RWEYQ26PY1	φ 3, 50Hz	380-415V	37.9A	45A	0.75-1.25mm ²
RWEYQ28PY1	φ 3, 50Hz	380-415V	37.9A	45A	0.75-1.25mm ²
RWEYQ30PY1	φ 3, 50Hz	380-415V	37.9A	45A	0.75-1.25mm ²

When using residual current operated circuit breakers, be sure to use a high-speed type 200mA rated residual operating current.

Note

- Use copper conductors only.
- Use insulated wire for the power cord.
- Select the power supply cable in accordance with relevant local and national regulations.
- Wire size must comply with the applicable local and national code.
- Specifications for local wiring power cord and branch wiring are in compliance with IEC60245.
- WIRE TYPE H05VV(*)
*Only in protected pipes, use H07RN-F when protected pipes are not used.

8-3 General

- Up to 3 units can be connected by crossover power source wiring between outside units. For details, refer to the equipment design data and technical data.
- Make sure to connect the power source wire to the power source terminal block and to clamp it as shown in figure 8, chapter "Field line connection".
- As this unit is equipped with an inverter, installing a phase advancing capacitor will not only deteriorate power factor improvement effect, but also may cause capacitor abnormal heating accident due to high-frequency waves. Therefore, never install a phase advancing capacitor.
- Keep power imbalance within 2% of the supply rating.
 1. Large imbalance will shorten the life of the smoothing capacitor.
 2. As a protective measure, the product will stop operating and an error indication will be made, when power imbalance exceeds 4% of the supply rating.
- Follow the "electrical wiring diagram" when carrying out any electrical wiring.
- Only proceed with wiring work after blocking off all power.
- Always ground wires. (In accordance with national regulations of the pertinent country.)
- Do not connect the ground wire to gas pipes, sewage pipes, lightning rods, or telephone ground wires.
 - Gas pipes:** can explode or catch fire if there is a gas leak.
 - Sewage pipes:** no grounding effect is possible if hard plastic piping is used.
 - Telephone ground wires and lightning rods:** dangerous when struck by lightning due to abnormal rise in electrical potential in the grounding.
- This unit is equipped with an inverter device. The earth must be connected in order to eliminate impact of the generated electromagnetic noise on other devices and to prevent leaked current from being charged on the outer casing of the unit.
- Earth leak detector which are especially for protecting ground-faults should be used in conjunction with main switch or fuse for use with wiring.
- Connect the wire securely using designated wire and fix it with attached clamp without applying external pressure on the terminal parts (terminal for power wiring, terminal for transmission wiring and earth terminal). See "field line connection".
- Never connect the power supply in reversed phase. (This product have reversed phase protection detector. If the detector operate, replace two of the three phases (L1, L2 and L3).)

8-4 Examples

System example (Refer to figure 8)

1. Field power supply
 2. Main switch
 3. Earth leak detector
 4. Fuse
 5. Cool/heat selector
 6. Remote controller
 7. Outside unit
 8. BS unit
 9. Indoor unit
- power supply wiring (sheathed cable)
— transmission wiring (sheathed cable)



Caution

- Use a power wire pipe for the power wiring.
- Outside the unit, make sure the weak electric wiring (i.e. for the remote controller, transmission, etc.) and the strong electric wiring do not pass near each other, keeping them at least 50 mm apart. Proximity may cause electrical interference, malfunctions, and breakage.
- Be sure to connect the power wiring to the power wiring terminal block and secure it as described in **Field line connection**.
- Transmission wiring should be secured as described in **Field line connection: transmission wiring and COOL/HEAT selector**.
- Secure the wiring with the accessory clamps so that it does not touch the piping.
- Make sure the wiring and the EL. COMPO. BOX cover do not stick up above the structure, and close the cover firmly.

Picking power line and transmission line

(Refer to figure 9)

1. Power supply wiring and wiring for pump operation (High voltage)
2. Connection wiring (Low voltage)
3. Set apart

Connect the wire to the terminal block on PC board with care since too much pressure may cause breakage of the PC board. Field line connection: transmission wiring, interlock circuit, pump operation output and COOL/HEAT selector

Connect the wire to the terminal block on the PC board with care since too much pressure may cause breakage of the PC board.

[In case of single outside unit system]

(Refer to figure 10)

1. COOL/HEAT selector
2. Outside unit PC board (A1P)
3. Take care of the polarity
4. Use the conductor of sheathed wire (2 wire)(no polarity)
5. Terminal board (field supply)
6. Indoor unit
7. Never connect the power wire.
8. BS unit A
9. BS unit B
10. Last BS unit
11. Cool-only unit

[In case of multi outside unit system]

(Refer to figure 11)

1. Unit A (Master unit)
 2. Unit B
 3. Unit C
 4. TO IN/D UNIT
 5. TO OUT/D UNIT
 6. TO MULTI UNIT
 7. To COOL/HEAT selector (only Heat pump system)
 8. To indoor unit
 9. To other systems
- The transmission wiring between the outside units in the same pipe line must be connected to the Q1/Q2 (Out Multi) terminals. Connecting the wires to the (Out-Out) terminals results in system malfunction.
 - The wiring for the other lines must be connected to the F1/F2 (Out-Out) terminals of the PC board in the outside unit to which the transmission wiring for the indoor units is connected.
 - The outside unit to which the transmission wiring for the indoor units is connected is master unit.
 - The transmission wiring between the outside units must be 30 m in length at maximum.

[Setting the interlock circuit and pump operation output.]

(Pump operation output [high voltage])

- Use insulated wires of the size as mentioned below having rated voltage of 250 V or higher:
For single core: 1.25 mm² or larger (conduit pipe work)
For multiple cores: 0.75 mm² or larger
- *The wiring for pump operation output is to be procured locally.

(Refer to figure 12)

1. Pump operation output terminal (X2M)
When water pump is linked with system operation, water pump operation circuit shall be set between terminals (1) and (2).
Contact specification --- 220 VAC, 3mA-0.5A
2. PC board (A1P)
3. Mount an insulation sleeve.
4. **Connection of interlock circuit**
Do not forget to connect an interlock circuit (an auxiliary a-contact of electromagnetic switch for the water pump) to each outside unit.
(Select without fail an auxiliary a-contact able to switch minimum load of DC15V, 1mA.)
(When connecting for each outside unit)
Connect to the terminal block (X3M) as shown in the bottom right of the sketch.
(When connecting multiple outside units as 1 single unit (centralized interlock))
For this unit, it is possible to make a centralized interlock of multiple outside units using an adapter (sold separately as an accessory) for external control of outside units.
For details of wiring connection, refer to "How to centralized interlock wiring".

(How to the centralized interlock wiring)

- When centralized interlock is done, see (3) "8-5 In case of a local setting"
- No wiring to terminal block X3M is necessary when centralized interlock is employed
- For multi system, external/external connection wiring shall be done for master unit only.

(Refer to figure 13)

1. Outside unit A
2. Outside unit B
3. Outside unit C
4. Adapter for external control
5. Interlock circuit of water pump
6. Out-Out connection wiring
7. Use the conductor of sheathed wire (2 wire)(no polarity)

[Setting the cool/heat operation type]

1. Performing cool/heat setting with the remote controller connected to the indoor unit.
Keep the COOL/HEAT selector switch (DS1) on the outside unit PC board (A1P) at the factory setting position OFF.

(Refer to figure 16)

1. Remote controller
2. Performing cool/heat setting with the COOL/HEAT selector.
Connect the COOL/HEAT selector (optional) to the A/B/C terminals and set the COOL/HEAT selector switch (DS1) on the outside unit PC board (A1P) to ON.

(Refer to figure 17)

1. COOL/HEAT selector
- For the above wiring, always use sheathed vinyl cords with 0.75 to 1.25 mm² or cables (2 core wires). (3 core wire are allowable for the COOL/HEAT selector only.)
 - All transmission wire is field supply.

- If the following limits should be exceeded, be careful that any abnormal transmission may be caused;

Maximum wiring length..... 1000 m or less
Total wiring length..... 2000 m or less
Maximum branching 16 branching or less
Wire length between outside unit 30 m or less

- **Never connect power supply to any connection wiring and its terminal block**, otherwise the entire system may be damaged.

- Up to 16 branches are possible for transmission wiring. However no branch is allowed after branch.

(Refer to figure 14)

1. Branch
2. Branch after branch

- The wiring to the indoor units must be connected to the F1/F2 (To IN/D UNIT) terminals on the PC board in the outside unit.

Field line connection: Power supply wiring and transmission wiring

Make sure to connect the power wire to the power terminal block and fix it using attached clamp as shown in figure 15 and 19.

(Refer to figure 15)

- Power supply (3N~, 380-415V)
- Branch switch, overcurrent breaker
- Grounding wire
- Earth leakage breaker
- Attach insulation sleeves.
- Power supply terminal block
- Grounding terminal
- Retain the ground wires along with the power wires using the accessory clamp (A).
- Grounding wire
- When wiring, do not allow the ground wires to contact the compressor lead wires. If the wires contact each other, adverse effects may occur to other units.
- When connecting two wires to one terminal, ensure that the crimp-style terminals face with each other back to back. Moreover, make sure that the wire of the smaller gauge is located above.
- Terminal block
- Crimp-style terminal
- Wire gauge: Small
- Wire gauge: Large

(Refer to figure 19)

- Intake for power supply wiring, pump operation output (high voltage) and ground wiring.
- Intake for power supply jumper wiring and ground jumper wiring. (Only for jumping the power supply.)
- HP/LP shutoff valve (high temperature part)
- Retain the power supply wiring, pump operation output (high voltage) and ground wiring with the accessory clamp(A).
- Insert the accessory clamp (B) in the hole of the fixing plate for stop valve.
- Power supply wiring, pump operation output (high voltage) and ground wiring.
- Approximately 50mm
- Power supply jumper wiring and ground jumper wiring.
- Retain the power supply wiring, pump operation output (high voltage) and ground wiring with the accessory clamp (B) to prevent them from touching with the stop valve for discharge gas.
- Use the through hole cover for power jumper supply by cutting the hatched area.
- Hatched area
- Insert the accessory clamp (B) in the hole of the bottom of electrical box.
- Intake for transmission wiring. (low voltage)
- Make sure to provide for a downward loop in the transmission wiring right in front of the location where the wiring is to be fixed over the topplate of the switch box. This is in order to prevent that condensate drips off the wiring into the switch box.
- Fix the transmission wiring to resin clamps with the accessory clamps (A)
- Pass the transmission wiring (low voltage) through the wire clip.
- Retain the power supply wiring, pump operation output (high voltage) and ground wiring to the bottom of electrical box with the accessory clamp (B)
- Do not bundle the power supply jumper wiring.

Caution

(Precautions when laying power wiring)

Use crimp-style terminals for connections to the power terminal block.

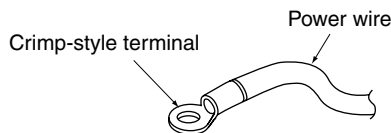

When none are available, follow the instructions below.

- Do not connect wiring of different size to the power terminal block. (Slack in the power wiring may cause abnormal heat.)
- When connecting wiring which is the same thickness, do as shown in the figure below.

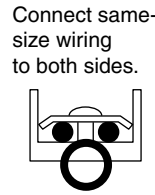

It is forbidden to connect two to one side.

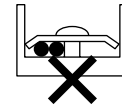

It is forbidden to connect wiring of different size.

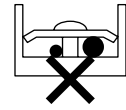

- For wiring, use the designated power wire and connect firmly, then secure to prevent outside pressure being exerted on the terminal board.
- Use an appropriate screwdriver for tightening the terminal screws. A screwdriver with a small head will strip the head and make proper tightening impossible.
- Over-tightening the terminal screws may break them.
- See the table below for tightening torque for the terminal screws.

	Tightening torque (N · m)
M5 (Power terminal block)	2.0-3.0
M5 (Ground)	3.2-3.9
M3.5 (transmission wiring terminal block)	0.8-0.97

(Precautions when connecting the ground)

When pulling the ground wire out, wire it so that it comes through the cut out section of the cup washer. (An improper ground connection may prevent a good ground from being achieved.)

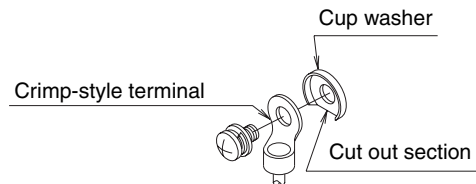

8-5 In case of a local setting

If necessary, do the local settings as mentioned in the table below. For setting, refer to the plate "Cares to be taken in servicing" attached to the cover of electrical box.

Typical local settings

*For other settings than mentioned in the table below, refer to the equipment design materials and service manual.

(1)Setting of switching between cooling and heating	This setting is done when switching between cooling and heating is performed by a switching remote controller (sold separately as an accessory) installed on the outside unit.
(2)Setting to prohibit sequenced start	This setting is done when the outside units are not started in a sequenced order.
(3)Setting of centralized interlock Setting of external demand	These settings are done when the interlocks are connected in a lump-sum manner or when performing a demand operation by external instruction.
(4)Setting of abnormal display when interlock contact is OFF	This setting is done when making an abnormal display (HJ) on a remote controller when the interlock contact is OFF (when the heat source water pump is not operated).

Caution

A separate adapter (sold separately as an accessory) for external control of an outside unit becomes necessary when doing a demand operation from an external instruction, setting of cooling and heating through a centralized remote controller for cooling and heating (sold separately as an accessory) and setting of centralized interlock. For details, refer to the manual attached to the adapter.

9. REFRIGERANT PIPING



Caution

After completing installation, be sure to open the valve. (See 9-9 Additional refrigerant charge for details) (Operating the unit with the valve shut will break the compressor.)
Use R410A to add refrigerant.
All field piping must be installed by a licensed refrigeration technician and must comply with relevant local and national regulations.

CAUTION TO BE TAKEN WHEN BRAZING REFRIGERANT PIPING

Do not use flux when brazing copper-to copper refrigerant piping. (Particularly for the HFC refrigerant piping) Therefore, use the phosphor copper brazing filler metal (BCuP-2: JIS Z 3264, B-Cu93P-710/795: ISO 3677) which does not require flux. (Flux has extremely harmful influence on refrigerant piping systems. For instance, if the chlorine based flux is used, it will cause pipe corrosion or, in particular, if the flux contains fluorine, it will damage the refrigerant oil.)

Note

- Installation tools:

Gauge manifold, charge hose, etc.

Make sure to use installation tools that are exclusively used for R410A installations to withstand the pressure and to prevent foreign materials (e.g. mineral oils such as SUNISO and moisture) from mixing into the system.
(The screw specifications differ for R410A and R407C.)

Vacuum pump

- Use a 2-stage vacuum pump with a non-return valve.
- Make sure the pump oil does not flow oppositely into the system while the pump is not working.
- Use a vacuum pump which can evacuate to -100.7 kPa (5Torr, -755 mmHg).

9-1 Selection of piping material

- Foreign materials inside pipes (including oils for fabrication) must be $30 \text{ mg}/10 \text{ m}$ or less.

- Use the following items for the refrigerant piping.

Material : Jointless phosphor-deoxidized copper pipe

Size : See "Example of connection" to determine the correct size.

Thickness : Select a thickness for the refrigerant piping which complies with national and local laws.

For R410A, the design pressure is 4.0 MPa (40-bar).
The minimum thickness of piping according to Japan's High-Pressure Gas Safety Law (as of January 2003) is shown below.

Temper grade (O type, 1/2H type) in the table indicate the material types specified in JIS H 3300.

(unit : mm)

Temper grade	O type			
outer diameter	$\phi 6.4$	$\phi 9.5$	$\phi 12.7$	$\phi 15.9$
smallest thickness	0.80	0.80	0.80	0.99

(unit : mm)

Temper grade	1/2H type							
outer diameter	$\phi 19.1$	$\phi 22.2$	$\phi 25.4$	$\phi 28.6$	$\phi 31.8$	$\phi 34.9$	$\phi 38.1$	$\phi 41.3$
smallest thickness	0.80	0.80	0.88	0.99	1.10	1.21	1.32	1.43

- Make sure to use the particular branches of piping that have been selected referring to chapter "Example of connection".

- Refer to chapter "Shutoff valve operation procedure" in 9-10 about the shutoff valve operation procedure.

- Make sure to perform the piping installation within the range of the maximum allowable pipe length, allowable level difference and allowable length after branching as indicated in chapter "Example of connection"

- For installation of the refrigerant branching kit, refer to the installation manual delivered with the kit.
And follow the conditions listed below.

- Mount the REFNET joint so that it branches either horizontally or vertically.
- Mount the REFNET header so that it branches horizontally.

(Refer to figure 22)

- Horizontal surface
- With in 30° against horizontal surface
- Horizontal surface

- The outside unit multi connection piping kit that is sold separately as an option (BHFP22MA56-84, BHFP26MA56-84) is necessary for the multi installation of outside units. See the installation manual attached to the kit with attention to the following restrictions when installing.

Restriction for the installation of the outside unit multi connection piping kit

- Install the joint horizontally within a lean of $\pm 15^\circ$ with caution nameplate on top. Refer to figure 23 (Fig. A)
Do not connect it vertically. Refer to figure 23 (Fig. B)
- Reserve the straight part of 500mm or more to the branch pipe and do not bend the local pipe in that area. Straight part of 500mm or more can be reserved if a local pipe (straight pipe) of 120mm or more is connected to the joint. Refer to figure 23 (Fig. C)
- Incorrect installation may cause breakage of outside unit.
(Refer to figure 23)
 - Caution nameplate
 - Horizontal line
 - Ground
 - Straight part of 500mm or more
 - Local pipe
(120mm length or more)

9-2 Protection against contamination when installing pipes

- Take measures to prevent foreign materials like moisture and contamination from mixing into the system.

Place	Installation period	Protection method
Outdoor	More than a month	Pinch the pipe
	Less than a month	
Indoor	Regardless of the period	Pinch or tape the pipe

- Great caution is needed when passing copper tubes through walls.

9-3 Pipe connection

- Only use the flare nuts included with the unit.
Using different flare nuts may cause the refrigerant to leak.
- Be sure to perform a nitrogen blow when brazing.
(Brazing without performing nitrogen replacement or releasing nitrogen into the piping will create large quantities of oxidized film on the inside of the pipes, adversely affecting valves and compressors in the refrigerating system and preventing normal operation.)



Caution

Do not use anti-oxidants when brazing the pipe joints.
Residue can clog pipes and break equipment.

Note

- For nitrogen replacement method, see the "Installation Manual" (contact your dealer).
- The pressure regulator for the nitrogen released when doing the brazing should be set to 0.02 MPa (0.2 kg/cm^2) or less.

(Refer to figure 18)

- Refrigerant pipe
- Location to be brazed
- Nitrogen
- Taping
- Manual valve
- Regulator

Precautions when connecting pipes

- See the following table for flare part machining dimensions.
- When connecting the flare nuts, apply refrigerant oil to the inside and outside of the flares and screw them in by hand three or four times at first.
(Use ester oil or ether oil.)
- See the following table for tightening torque.
(Applying too much torque may cause the flares to crack.)
- After all the piping has been connected, check the gas leak with nitrogen.

pipe size	tightening torque (N · m)	A (mm)	flare shape
$\phi 9.5$	32.7 - 39.9	12.8 - 13.2	
$\phi 12.7$	49.5 - 60.3	16.2 - 16.6	
$\phi 15.9$	61.8 - 75.4	19.3 - 19.7	

—Not recommendable but in case of emergency—

You must use a torque wrench but if you are obliged to install the unit without a torque wrench, you may follow the installation method mentioned below.

After the work is finished, make sure to check that there is no gas leak.

When you keep on tightening the flare nut with a spanner, there is a point where the tightening torque suddenly increases. From that position, further tighten the flare nut the angle shown below:

Pipe size	Further tightening angle	Recommended arm length of tool
φ9.5	60 to 90 degrees	Approx. 200 mm
φ12.7	30 to 60 degrees	Approx. 250 mm
φ15.9	30 to 60 degrees	Approx. 300 mm

9-4 Connecting the refrigerant piping

Connect piping to outside unit by using accessory pipes (Refer to figure 20)

1. Gas side piping
2. (field supply)
3. Accessory pipe (2) (**THICK**)
4. Liquid side pipe (field supply)
5. Flare nut (Included in the unit)
6. Accessory pipe (1) (**THIN**) and (3) is not used.
7. Piping on HP/LP gas side (field supply)
8. Piping on suction gas side (field supply)
9. Cut off the hatched area and use it as a cover for the drilled.
10. Hatched area
11. Accessory pipe (1) (**THIN**)
12. Accessory pipe (2) and Accessory pipe (3)
13. Guideline for pipe machining
14. Accessory pipe (3)
15. Brazing
16. Accessory pipe (2) (**THICK**)
17. Before fitting to the product, apply brazing.

Precautions for installation of units

Note 

- The outside unit multi connection piping kit that is sold separately as an option (BHFP22MA56-84, BHFP26MA56-84) is necessary for the multi installation of outside units.
- See the installation manual attached to the kit with attention to installation restrictions described in "connecting the refrigerant piping" when installing.

1. To avoid the risk of oil detention in the piping the piping between the outside units must be routed level or slightly upward.

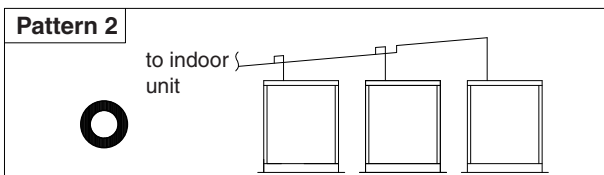
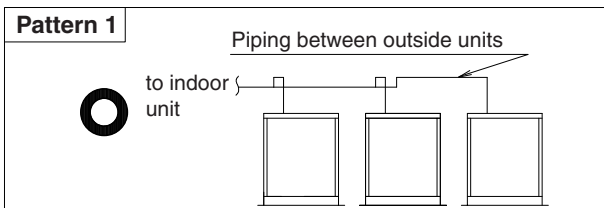

 Change to pattern 1 or pattern 2

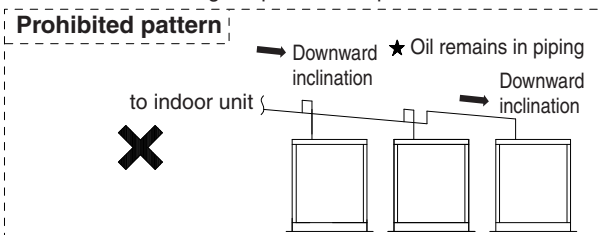

2. The gas piping (both discharge and suction gas pipings in case of the heat recovery system) after branched, install without fail a trap of 200 mm or larger using the piping included in the piping kit for connecting the outside unit. Otherwise, the refrigerant may stay within the piping, causing any damage to the outside unit.

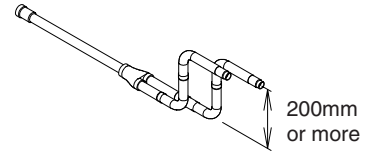

Prohibited pattern

No trap has been installed in the gas piping.

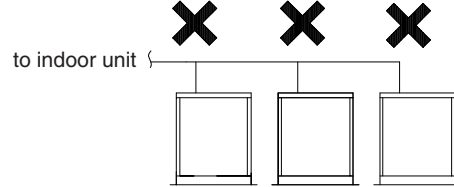

★Oil may remain in the farthest outside unit.
Change to pattern 1 or pattern 2

3. If the piping length between the outside unit connecting pipe kit or between the outside units exceeds 2 m, create a rise of 200 mm or more in the gas line within a length of 2 m from the kit.

If 2 m or less

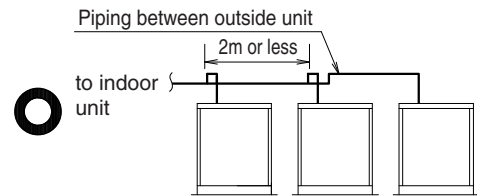

If 2 m or more

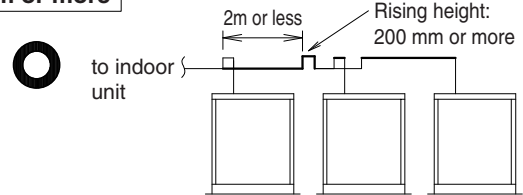

Note 1.

When the equivalent pipe length between outside and indoor units is 80m or more, the size of main pipes on the liquid side (refer to figure 21) must be increased according to the right table.
(Never increase suction gas pipe and HP/LP gas pipe.)

(Refer to figure 21)

1. Outside unit
2. Main pipes
3. Increase only liquid pipe size
4. First refrigerant branch kit
5. Indoor unit

System	Liquid pipe
RWEYQ8 ~ 10PY1	φ9.5 → φ12.7
RWEYQ16PY1	φ12.7 → φ15.9
RWEYQ18 ~ 24PY1	φ15.9 → φ19.1
RWEYQ26 ~ 30PY1	φ19.1 → φ22.2

Note 2. Allowable length after the first refrigerant branch kit to indoor units is 40m or less, however it can be extended up to 90m if all the following conditions are satisfied. (In case of "Branch with REFNET joint")

Required Conditions	Example Drawings
<p>1. It is necessary to increase the liquid and suction gas pipe size between the first branch kit and the final branch kit. (Reducers must be procured on site) However, the pipes that are same pipe size with main pipe must not be increased.</p> <p>2. For calculation of Total extension length, the actual length of above pipes must be doubled. (except main pipe and the pipes that are not increased)</p> <p>3. Indoor unit to the nearest branch kit ≤ 40 m</p> <p>4. The difference between [Outside unit to the farthest indoor unit] and [Outside unit to the nearest indoor unit] ≤ 40 m</p>	<p>$\text{8} \quad b + c + d + e + f + g + p \leq 90 \text{ m}$ increase the liquid and suction gas pipe size of b, c, d, e, f, g</p> <p>$a + b \times 2 + c \times 2 + d \times 2 + e \times 2 + f \times 2 + g \times 2 + h + i + j + k + l + m + n + p \leq 300 \text{ m}$</p> <p>$h, i, j, \dots, p \leq 40 \text{ m}$ The farthest indoor unit 8 The nearest indoor unit 1 $(a + b + c + d + e + f + g + p) \cdot (a + h) \leq 40 \text{ m}$</p> <p>Increase the liquid and suction gas pipe size as follows $\phi 9.5 \rightarrow \phi 12.7 \quad \phi 15.9 \rightarrow \phi 19.1 \quad \phi 22.2 \rightarrow \phi 25.4^*$ $\phi 12.7 \rightarrow \phi 15.9 \quad \phi 19.1 \rightarrow \phi 22.2 \quad \phi 28.6 \rightarrow \phi 31.8^*$ $\phi 34.9 \rightarrow \phi 38.1^*$</p> <p>REFNET joint (A-G)</p> <p>Outside unit Indoor units (1 - 8)</p>

*If available on the site, use this size. Otherwise it can not be increased.

9-6 Air tight test and vacuum drying

The units were checked for leaks by the manufacturer.

Confirm that the valves are firmly closed before Air tight test or vacuum drying.

To prevent entry of any impurities and insure sufficient pressure resistance, always use the special tools dedicated for R410A.

- **Air tight test:** Make sure to use nitrogen gas. (For the service port location, refer to the "Caution" label attached on the front panel [right] of the outside unit.)

(Refer to figure)

1. [Service precautions] Label
2. EL. COMPO. BOX cover
3. [Caution] Label

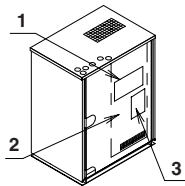

Pressurize the liquid and gas pipes to 4.0MPa (40bar) (do not pressurize more than 4.0MPa (40bar)). If the pressure does not drop within 24 hours, the system passes the test. If the pressure drops, check where the nitrogen leaks from.

- **Vacuum drying:** Use a vacuum pump which can evacuate to -100.7kPa (5Torr, -755mmHg).
 1. Evacuate the system from the liquid and gas pipes by using a vacuum pump for more than 2 hours and bring the system to -100.7kPa or less. After keeping the system under that condition for more than 1 hour, check if the vacuum gauge rises or not. If it rises, the system may either contain moisture inside or have leaks.
 2. Following should be executed if there is a possibility of moisture remaining inside the pipe (if piping work is carried out during the raining season or over a long period of time rainwater may enter the pipe during work).
After evacuating the system for 2 hours, pressurize the system to 0.05MPa (vacuum break) with nitrogen gas and evacuate the system again using the vacuum pump for 1 hour to -100.7kPa or less (vacuum drying). If the system cannot be evacuated to -100.7kPa within 2 hours, repeat the operation of vacuum break and vacuum drying.
Then, after leaving the system in vacuum for 1 hour, confirm that the vacuum gauge does not rise.

9-7 Pipe insulation

After finishing the leak test and vacuum drying, the piping must be insulated. Take into account the following points:

- Make sure to insulate the connection piping both liquid-side and gas-side and refrigerant branch kits entirely.
Not insulating them may cause leaking. (The gas piping can reach temperatures of 120°C . Be sure the insulation used can withstand such temperatures.)
- Reinforce the insulation on the refrigerant piping according to the installation environment. Condensation might form on the surface of the insulation.
- If there is a possibility that condensation on the shutoff valve might drip down into the indoor unit through gaps in the insulation and piping because the outside unit is located higher than the indoor unit, etc., this must be prevented by caulking the connections, etc.



Caution

Be sure to insulate connection piping, as touching them can cause burns.

9-8 Checking of device and installation conditions

Be sure to check the followings.

1. Make sure there is no faulty power wiring or loosening of a nut.
See "8. FIELD WIRING".
2. Make sure there is no faulty transmission wiring or loosening of a nut.
See "8. FIELD WIRING".
3. Make sure there is no faulty refrigerant piping.
See "9. REFRIGERANT PIPING".
4. Make sure piping size is correct.
See "9-1 Selection of piping material".
5. Make sure insulation work is done.
See "9-7 Pipe insulation".
6. Make sure insulation resistance of main power circuit is not deteriorated.
Using a megatester for 500V, check that the insulation resistance of $2\text{M}\Omega$ or more is attained by applying a voltage of 500V DC between power terminals and earth. Never use the megatester for the transmission wiring (between outdoor and indoor unit, outdoor and COOL/HEAT selector and etc.).

9-9 Additional refrigerant charge



Caution

- Refrigerant cannot be charged until field wiring has been completed.
- Refrigerant may only be charged after performing the leak test and the vacuum drying.
- When charging a system, care shall be taken that its maximum permissible charge is never exceeded, in view of the danger of liquid hammer.
- Charging with an unsuitable substance may cause explosions and accidents, so always ensure that the appropriate refrigerant (R410A) is charged.
- Refrigerant containers shall be opened slowly.
- Always use protective gloves and protect your eyes when charging refrigerant.

- This outside unit is factory charged with refrigerant and depending on pipe sizes and pipe lengths some systems require additional charging of refrigerant.

- Determine the amount of refrigerant to be added by referring to the table, write it down on the included "Added Refrigerant" plate and attach it to the rear side of the front cover.

Note: refer to the example of connection for the amount to be added.

Additional refrigerant charge procedure (1)-normally

- Charge the refrigerant to the liquid pipe in its liquid state. Since R410A is a mixed refrigerant, its composition changes if charged in a state of gas and normal system operation would no longer be assured.
- Make sure to use installation tools you exclusively use on R410A installations to withstand the pressure and to prevent foreign materials from mixing into the system.

1. Before charging, check whether the tank has a siphon attached or not.

How to charge with a siphon attached tank.

Charge with the tank upright.

(There is a siphon tube inside, so there is no need to turn the tank upside-down.)



How to charge with other tank.

Charge with the tank upside-down.



2. After the vacuum drying is finished, charge the additional refrigerant in its liquid state through the liquid shutoff valve service port. Taking into account following instructions:

- Check that gas and liquid shutoff valves are closed.
- Stop the compressor and charge the specified weight of refrigerant.

(If the outside unit is not in operation and the total amount cannot be charged, follow the Additional refrigerant charge procedure (2) shown below.)

Note

- Procedures for charging additional refrigerant.

(Refer to figure 24)

1. Pressure reducing valve
2. Nitrogen
3. Refrigerant tank
4. With a siphon
5. Measuring instrument
6. Vacuum pump
7. Valve A
8. Valve B
9. Charge hose
10. Outside unit
11. Gas side
12. Liquid side
13. Discharge gas side
14. Suction gas side
15. Shutoff valve service port
16. To indoor unit
17. To indoor units / BS units
18. Dotted lines represent onsite piping

Additional refrigerant charge procedure (2)-by Additional refrigerant charge operation

About the system settings for additional refrigerant charge operation, refer to the [Service Precaution] label attached on the electric box cover in the outside unit.

1. Fully open all shutoff valves (valve A and valve B in the figure 24 must be left fully closed).
2. After ten minutes, fully close liquid line shutoff valve and then, open the valve by turning 180°. Start the additional refrigerant charge operation. See [Service precautions] Label for detail. If it is difficult to charge the refrigerant additionally, decrease the water temperature or warm the refrigerant tank. (Warm the refrigerant tank with a stupe or a warm hot water of 40 degrees or less.)
3. After the system is charged with a specified amount of refrigerant, press the RETURN button (BS3) on the PC board (A1P) in the outside unit to stop the additional refrigerant charge operation.
4. Immediately open both liquid-side and gas-side shutoff valve. (If do not open the shutoff valve immediately, liquid seal may cause the pipe to burst.)

Note

- Procedures for charging additional refrigerant. (Refer to figure 24)

9-10 Shutoff valve operation procedure

Caution

Do not open the shutoff valve until 1-6 of "9-8 Checking of device and installation conditions" are completed. If the shutoff valve is left open without turning on power, it may cause refrigerant to buildup in the compressor, leading to insulation degradation.

Opening shutoff valve

1. Remove the cap and turn the valve counterclockwise with the hexagon wrench (JISB4648).
2. Turn it until the shaft stops. Do not apply excessive force to the shutoff valve. Doing so may break the valve body, as the valve is not a backseat type. Always use the hexagon wrench.
3. Make sure to tighten the cap securely.

Closing shutoff valve

1. Remove the cap and turn the valve clockwise with the hexagon wrench (JISB4648).
2. Securely tighten the valve until the shaft contacts the main body seal.
3. Make sure to tighten the cap securely. * For the tightening torque, refer to the table on the bellow.

Tightening torque

Shutoff valve size	Tightening torque N-m (Turn clockwise to close)					
	Shaft (valve body)		Cap (valve lid)	Service port	Flare nut	Gas side accessory pipe (1)
Liquid side	5.4-6.6	Hexagonal wrench 4 mm	13.5-16.5	11.5-13.9	32.7-39.9	-
Gas side	27-33	Hexagonal wrench 10 mm	36-44	11.5-13.9	-	22-28

(Refer to figure 25)

1. Service port
2. Cap
3. Hexagon hole
4. Shaft
5. The main body seal

(Caution)

- Do not damage the cap sealing.
- Always use a charge hose for service port connection.
- After tightening the cap, check that no refrigerant leaks are present.
- After working, securely tighten the cover of service port without fail by specified torque.
- When loosening a flare nut, always use two wrenches in combination. When connecting the piping, always use a spanner and torque wrench in combination to tighten the flare nut.
- When connecting a flare nut, coat the flare (inner and outer faces) with ether oil or ester oil and hand-tighten the nut 3 to 4 turns as the initial tightening.
- Do not forget to open the stop valve before starting operation.

(Refer to figure 26)

1. Remove the cap and turn the valve counter clockwise with the hexagon wrenches until it stops.
2. HP/LP gas shutoff valve
3. Liquid shutoff valve
4. Suction gas shutoff valve
5. Never remove the partition flange for any reason.
6. Full close on the suction gas side

10. CHECKS AFTER INSTALLATION

After the installation, check the following.

1. The shutoff valve
Make sure that the shutoff valve (both liquid and gas) is opened. See the "Shutoff valve operation procedure" in chapter 9-10.
2. Additional refrigerant charge
The amount of refrigerant to be added to the unit should be written on the included "Added Refrigerant" plate and attached to the rear side of the front cover.
3. Installation date
Be sure to keep record of the installation date on the sticker on the EL. COMPO. BOX cover according to EN60335-2-40.

11. TEST RUN

Caution

After completing installation, be sure to open the shutoff valve. (Operating the unit with the valve shut will break the compressor.)

11-1 Air discharge

- Running the heat source water pump, carry out air discharge process until the water comes out from the air discharge hole of local piping. (For the operation to be done for the first time after installation, you need to perform a checking operation.)

11-2 Before turn on the power supply

- Close the EL. COMPO. BOX cover securely before turning on power.
- Make settings for outside unit PC board (A1P) after power-on and check the LED display from inspection door that is on the EL. COMPO. BOX cover.

11-3 Check operation

(For the operation to be done for the first time after installation, you need to perform a checking operation according to this guideline without fail. Otherwise, Abnormal Code "U3" appears and normal operation cannot be carried out.)

(1)Check the connection of interlock circuit	The outside unit cannot be operated if the interlock circuit has not been connected.																																																												
(2)As necessary, configure the system settings onsite by using the dipswitch (DS1) and push button switches (BS1 to 5) on the outside unit PC board (A1P). After this, close the cover of electrical box.	Always perform configuration after turning ON the power. To learn the setting method, refer to the [Service Precautions] label attached at the cover of electrical box shown in the figure 27. Remember, the actual settings you have made must be recorded on the [Service Precautions] label.																																																												
(3)Turn ON the power to the outside units and indoor units.	Make sure to turn ON the power 6 hours before starting the operation. This is necessary to warm the crankcase by the electric heater.																																																												
(4)Start the heat source water pump and fill the heat source water in the outside unit.	The outside unit cannot be operated if the heat source water pump is not running.																																																												
(5)Make sure that the temperature of heat source water is kept within the operation range (10 - 45°C).	The outside unit cannot be operated at a temperature outside the operation range.																																																												
(6)Check the LED on the PC board (A1P) in the outside unit to see if the data transmission is performed normally.	<table border="1"> <thead> <tr> <th rowspan="2">LED display (Default status before delivery)</th> <th rowspan="2">Microcomputer operation monitor</th> <th colspan="3">Page</th> <th colspan="3">Cooler/heater changeover</th> <th rowspan="2">Low noise</th> <th rowspan="2">Demand</th> <th rowspan="2">Multi</th> </tr> <tr> <th>H1P</th> <th>H2P</th> <th>H3P</th> <th>Bulk (parent)</th> <th>Bulk (child)</th> <th>H5P</th> </tr> </thead> <tbody> <tr> <td>One outside unit installed</td> <td>●</td> <td>●</td> <td>●</td> <td>☀</td> <td>●</td> <td>●</td> <td>●</td> <td>●</td> <td>●</td> <td>●</td> </tr> <tr> <td rowspan="2">When multiple outside unit installed (*)</td> <td>Master station</td> <td>●</td> <td>●</td> <td>☀</td> <td>●</td> <td>●</td> <td>●</td> <td>●</td> <td>●</td> <td>☀</td> </tr> <tr> <td>Sub station 1</td> <td>●</td> <td>●</td> <td>●</td> <td>●</td> <td>●</td> <td>●</td> <td>●</td> <td>●</td> <td>●</td> </tr> <tr> <td>Sub station 2</td> <td>●</td> <td>●</td> <td>●</td> <td>●</td> <td>●</td> <td>●</td> <td>●</td> <td>●</td> <td>●</td> <td>●</td> </tr> </tbody> </table> <p>LED display: ● OFF ☀ ON ◐ Blinking</p> <p>(*) The master unit is the outside unit to which the transmission wiring for the indoor units is connected. The other outside units are sub units.</p>	LED display (Default status before delivery)	Microcomputer operation monitor	Page			Cooler/heater changeover			Low noise	Demand	Multi	H1P	H2P	H3P	Bulk (parent)	Bulk (child)	H5P	One outside unit installed	●	●	●	☀	●	●	●	●	●	●	When multiple outside unit installed (*)	Master station	●	●	☀	●	●	●	●	●	☀	Sub station 1	●	●	●	●	●	●	●	●	●	Sub station 2	●	●	●	●	●	●	●	●	●	●
LED display (Default status before delivery)	Microcomputer operation monitor			Page			Cooler/heater changeover						Low noise	Demand	Multi																																														
		H1P	H2P	H3P	Bulk (parent)	Bulk (child)	H5P																																																						
One outside unit installed	●	●	●	☀	●	●	●	●	●	●																																																			
When multiple outside unit installed (*)	Master station	●	●	☀	●	●	●	●	●	☀																																																			
	Sub station 1	●	●	●	●	●	●	●	●	●																																																			
Sub station 2	●	●	●	●	●	●	●	●	●	●																																																			

(7) • Using the push button switches (BS1 - 5) on the P-panel (A1P) of outside unit, carry out a local setting, if necessary. • In case of an installation of multiple outside units, carry out the setting on the master unit. (Setting on the slave unit becomes invalid.)	Always carry out the setting only after the power supply has been applied. For the method of setting, refer to the label of "Points to be noted when providing services" attached to the cover of electrical box (shown in the figure 27) of the outside unit. (After setting, record the details of that setting to the label of "Points to be noted when providing services" without fail.)
(8) Check all shutoff valve is opened. If some shutoff valve is closed, open them. (Refer to "9-10 Shutoff valve operation procedure".)	[CAUTION] Do not leave any shutoff valve closed. Otherwise the compressor will fail. For Heat recovery system of cooling and heating: Open all stop valves on the suction side, discharge gas side and liquid side. For cooling and heating switching operation system: Open the stop valves on discharge gas side and liquid side. (Keep the stop valve on suction side fully closed.)
(9) Perform the check operation following the instructions printed on the [Service Precautions] label.	If you push the test run button (BS4) on the P-panel (A1P) of the outside unit, for 5 seconds, the test run starts. If you want to interrupt the test run, push the RETURN button (BS3) on P-panel (A1P) of the outside unit. The system continues residual operation for about 1 minute (maximum 10 minutes) and then stops. (During test run, you cannot stop it by a command from a remote controller.) You need to perform the above settings on the PCB by accessing the PCB through the inspection cover on the switch box cover.

(Refer to figure 27)

1. Electrical box
2. Cover of electrical box
3. Cover for servicing
4. Inspection cover
5. Points to be noted when providing services

(Cautions for check operation)

- If operated within about 12 minutes after power supply has been applied to the indoor unit and outside unit, H2P will turn ON but the compressor does not start running. Before start operation, make sure that the LED display is correct referring to the table (6) of "11-3 Check operation".
- The system may require up to 10 minutes until it can start the compressor after an operation start. This is a normal operation to equalize the refrigerant distribution.
- The check operation does not provide any means of checking the indoor units individually. For that purpose, perform normal operation using the remote controller after the check operation.
- Check operation is not possible in other modes such as collection mode.
- If the setting of indoor remote controller is changed before the check operation, it may not be performed correctly and malfunction code "UF" may be displayed.

Remote controller displays malfunction code

Malfunction code	Installation error	Remedial action
E3 E4 F3 F6 UF U2	The shutoff valve of an outside unit is left closed.	Open the shutoff valve.
U1	The phases of the power to the outside units are reversed.	Exchange two of the three phases (L1, L2, L3) to make a positive phase connection.
U3	The check operation is not completed.	Complete the check operation.
U1 U2 U4	No power is supplied to an outdoor or indoor unit (including phase interruption).	Check if the power wiring for the outside units are connected correctly. (If the power wire is not connected to L2 phase, no malfunction display will appear and the compressor will not work.)
UF	Incorrect transmission between units	Check if the refrigerant piping line and the unit transmission wiring are consistent with each other.
E3 F6 UF U2	Refrigerant overcharge	Recalculate the required amount of refrigerant from the piping length and correct the refrigerant charge level by recovering any excessive refrigerant with a refrigerant recovery machine.
E4 F3	Insufficient refrigerant	<ul style="list-style-type: none"> • Check if the additional refrigerant charge has been finished correctly. • Recalculate the required amount of refrigerant from the piping length and add an adequate amount of refrigerant.
U7 UF	If an outdoor multi terminal is connected when there is one outside unit installed	Remove the line from the outdoor multi terminals (Q1 and Q2).
UF E4	The operation mode on the remote controller was changed before the check operation.	Set the operation mode on all indoor unit remote controllers to "cooling."
HJ	The heat source water is not circulating.	Make sure that the water pump is running.

11-4 Check of normal operation

After the check operation is completed, operate the unit normally. (Heating is not possible if the outdoor temperature is 24°C or higher. Refer to the Operation manual.)

Check the below items.

- Make sure the indoor and outside units are operating normally (If a knocking sound can be heard in the liquid compression of the compressor, stop the unit immediately and then energize the heater for a sufficient length of time before restarting the operation.)
- Run each indoor unit one at a time and make sure the corresponding outside unit is also running.
- Check if cold (or hot) air is coming out of the indoor unit.
- Press the fan direction and fan strength buttons on the indoor unit to check if they operate properly.

Caution

(Cautions for normal operation check)

- Once stopping, the compressor will not restart in about 5 minutes even if the Run/Stop button of an indoor unit in the same system is pressed.
- When the system operation is stopped by the remote controller, the outside units may continue operating for further 5 minutes at maximum.
- If the system has not undergone any check operation by the test operation button since it was first installed, an malfunction code "U3" is displayed. In this case, perform check operation referring to "11-3 Check operation".
- After the test run, when handing the unit over to the customer, make sure the EL. COMPO. BOX cover, the inspection door, and the unit casing are all attached.

12. CAUTION FOR REFRIGERANT LEAKS

(Points to note in connection with refrigerant leaks)

Introduction

The installer and system specialist shall secure safety against leakage according to local regulations or standards. The following standards may be applicable if local regulations are not available.

The VRV System, like other air conditioning systems, uses R410A as refrigerant. R410A itself is an entirely safe non-toxic, non-combustible refrigerant. Nevertheless care must be taken to ensure that air conditioning facilities are installed in a room which is sufficiently large. This assures that the maximum concentration level of refrigerant gas is not exceeded, in the unlikely event of major leak in the system and this in accordance to the local applicable regulations and standards.

Maximum concentration level

The maximum charge of refrigerant and the calculation of the maximum concentration of refrigerant is directly related to the humanly occupied space in to which it could leak.

The unit of measurement of the concentration is kg/m^3 (the weight in kg of the refrigerant gas in 1m^3 volume of the occupied space).

Compliance to the local applicable regulations and standards for the maximum allowable concentration level is required.

In Australia the maximum allowed concentration level of refrigerant to a humanly space is limited to 0.35kg/m^3 for R407C and 0.44kg/m^3 for R410A.

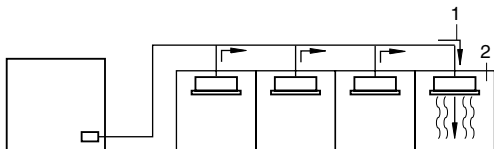

1. direction of the refrigerant flow
2. room where refrigerant leak has occurred (outflow of all the refrigerant from the system)

Pay a special attention to the place, such as a basement, etc. where refrigerant can stay, since refrigerant is heavier than air.

Procedure for checking maximum concentration

Check the maximum concentration level in accordance with steps 1 to 4 below and take whatever action is necessary to comply.

1. Calculate the amount of refrigerant (kg) charged to each system separately.

amount of refrigerant in a single unit system (amount of refrigerant with which the system is charged before leaving the factory)	+	additional charging amount (amount of refrigerant added locally in accordance with the length or diameter of the refrigerant piping)	=	total amount of refrigerant (kg) in the system
---	---	--	---	--

Note

- Where a single refrigerant facility is divided into 2 entirely independent refrigerant systems then use the amount of refrigerant with which each separate system is charged.
2. Calculate the smallest room volume (m^3)
In case like the following, calculate the volume of (A), (B) as a single room or as the smallest room.

A. Where there are no smaller room divisions

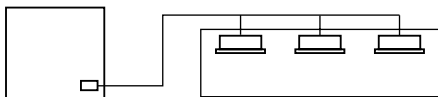

B. Where there is a room division but there is an opening between the rooms sufficiently large to permit a free flow of air back and forth.

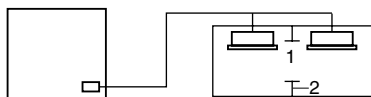

1. opening between rooms
2. partition

(Where there is an opening without a door or where there are openings above and below the door which are each equivalent in size to 0.15% or more of the floor area.)

3. Calculating the refrigerant density using the results of the calculations in steps 1 and 2 above.

$$\frac{\text{total volume of refrigerant in the refrigerant system}}{\text{size (m}^3\text{) of smallest room in which there is an indoor unit installed}} \leq \text{maximum concentration level (kg/m}^3\text{)}$$

If the result of the above calculation exceeds the maximum concentration level then make similar calculations for the second then third smallest room and so until the result falls short of the maximum concentration.

4. Dealing with the situations where the result exceeds the maximum concentration level.
Where the installation of a facility results in a concentration in excess of the maximum concentration level then it will be necessary to revise the system. Please consult your Daikin supplier.

