

technical data

InstallationProcedure

air conditioning systems

R-410A

VRV[®]-WII

2b

TABLE OF CONTENTS

Installation procedure

1	Installation of outdoor	2
	Introduction	3
	Selection of location	5
	Inspecting and handling the unit	6
	Unpacking and placing the unit	7
	Water piping work	8
	Handling of the plate type heat exchanger	9
	Field wiring	12
	Refrigerant piping	21
	Checks after installation	31
	Test run	32

1 Installation of outdoor

CAUTION

- 1 Ground the air conditioner.
Do not connect the ground wire to gas or water pipes, lightning rod or a telephone ground wire.
Incomplete grounding may result in electric shocks.
- 2 Be sure to install an earth leakage breaker.
Failure to install an earth leakage breaker may result in electric shocks.
- 3 While following the instructions in this installation manual, install drain piping in order to ensure proper drainage and insulate piping in order to prevent condensation.
Improper drain piping may result in water leakage and property damage.
- 4 Install the indoor and outside units, power supply wiring and connecting wiring at least 1 meter away from televisions or radios in order to prevent image interference or noise.
(Depending on the radio waves, a distance of 1 meter may not be sufficient enough to eliminate the noise.)
- 5 Remote controller (wireless kit) transmitting distance can result shorter than expected in rooms with electronic fluorescent lamps.
(inverter or rapid start types)
Install the indoor unit as far away from fluorescent lamps as possible.
- 6 Install in a machine room that has no water drops.
This unit is for indoor use.
- 7 Do not install the air conditioner in the following locations:
 - a where a mineral oil mist or an oil spray or vapor is produced, for example in a kitchen
Plastic parts may deteriorate and fall off or result in water leakage.
 - b where corrosive gas, such as sulfurous acid gas, is produced
Corroding copper pipes or soldered parts may result in refrigerant leakage.
 - c near machinery emitting electromagnetic waves
Electromagnetic waves may disturb the operation of the control system and result in a malfunction of the unit.
 - d where flammable gas may leak, where there are carbon fiber or ignitable dust suspensions in the air, or where volatile flammables such as thinner or gasoline are handled.
Operating the unit in such conditions may result in fire.

Disposal requirements

Dismantling of the unit, treatment of the refrigerant, oil and eventual other parts, should be done in accordance with the relevant local and national regulations.

CAUTION

The refrigerant R410A requires strict cautions for keeping the system clean, dry and tight.

1 Clean and dry

Foreign materials (including mineral oils such as SUNISO oil or moisture) should be prevented from getting mixed into the system.

2 Tight

R410A does not contain any chlorine, does not destroy the ozone layer, and does not reduce the earth's protection against harmful ultraviolet radiation.

R410A can contribute slightly to the greenhouse effect if it is released. Therefore we should take special attention to check the tightness of the installation.

Read the chapter "REFRIGERANT PIPING" carefully and follow these procedures correctly.

Since design pressure is 4.0MPa or 40bar (for R407C units: 3.3MPa or 33bar), the wall thickness of pipes should be more carefully selected.

Since R410A is a mixed refrigerant, the required additional refrigerant must be charged in its liquid state. (If the refrigerant is charged in a state of gas, its composition changes and the system will not work properly.)

The indoor unit is for R410A. See the catalog for indoor unit models which can be connected.

(Normal operation is not possible when connected to other units.)

1 Installation of outdoor

1 - 1 Introduction

This installation manual concerns VRV inverters of the Daikin RWEYQ-M series. These units are designed for indoor installation and used for cooling and heatpump applications.

The RWEYQ-M units can be combined with Daikin VRV series indoor units for air conditioning purposes.

The present installation manual describes the procedures for unpacking, installing and connecting the RWEYQ-M units. Installation of the indoor units is not described in this manual. Always refer to the installation manual supplied with these units for their installation.

1 - 1 - 1 Combination

The indoor units can be installed in the following range.

- **Always use appropriate indoor units compatible with R410A.**
To lean which models of indoor units are compatible with R410A, refer to the product catalogs.
- Total capacity/quantity of indoor units
<Outside unit > <Total capacity index of indoor units> <Total quantity of indoor units >
RWEYQ10MY1.....125 ~ 325 16 units
RWEYQ20MY1.....250 ~ 650 20 units
RWEYQ30MY1.....375 ~ 975 32 units

1 - 1 - 2 Standard operation limit

The figures below assume following operating conditions for indoor and outside units:

Equivalent pipe length 7.5m

Level difference 0m

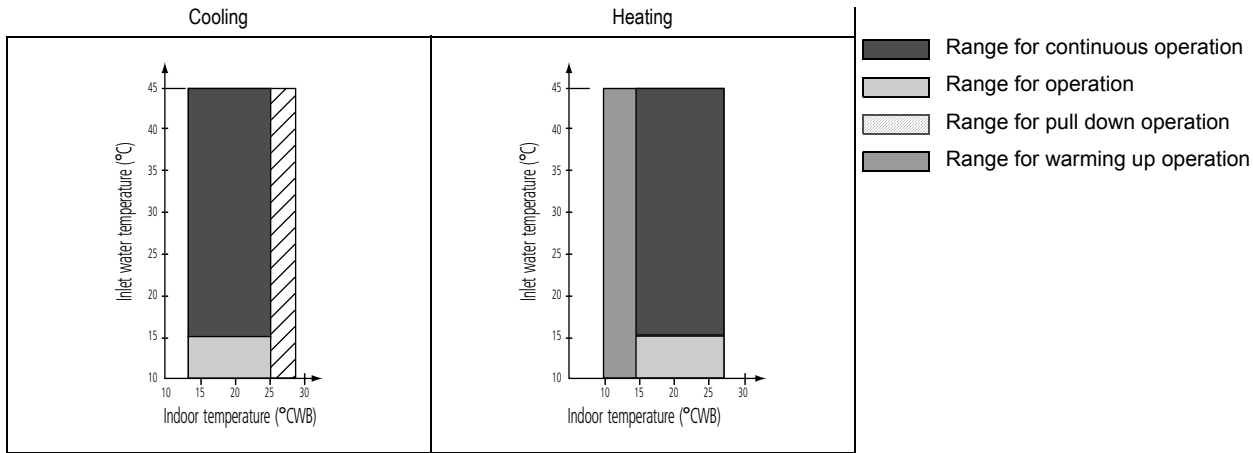

- Operation range of water volume is 50-150L/min
- **Design in the following condition range**
water temp. : 20-35°C
water volume : 60L/min more
- When cooling condition load is small, thermostat-off may be carried out for freeze-up protection
- Hold ambient temperature at 0-40°C
Heat rejection from the casing: 0.71kw/10HP

1 Installation of outdoor

1 - 1 Introduction

1 - 1 - 3 Technical specifications (1)

GENERAL		FXYCP10MY1	FXYCP20MY1	FXYCP30MY1
Nominal cooling capacity (2)	(kW)	26.7	53.4	80.1
Nominal heating capacity (3)	(kW)	31.5	63.0	94.5
Nominal input cooling / heating (4)	(kW)	6.03 / 6.05	12.1 / 12.1	18.1 / 18.2
Dimensions HxWxD	(mm)	1000 x 780 x 550	(1000 x 780 x 550) x 2	(1000 x 780 x 550) x 3
Mass	(kg)	150	(150) x 2	(150) x 3
Connections				
Refrigerant liquid pipe	(inch)	3/8	5/8	3/4
	(mm)	ø9.5	ø28.6	ø19.1
Refrigerant gas pipe	(inch)	7/8	1 1/8	1 3/8
	(mm)	ø22.2	ø28.6	ø34.9
Refrigerant discharge gas pipe (5)	(inch)	3/4	7/8	1 1/8
	(mm)	ø19.1	ø22.2	ø28.6
Water piping connections				
Inlet pipe		PT1 1/4B Internal Thread	(PT1 1/4B) x 2 Internal Thread	(PT1 1/4B) x 3 Internal Thread
Outlet pipe		PT1 1/4B Internal Thread	(PT1 1/4B) x 2 Internal Thread	(PT1 1/4B) x 3 Internal Thread
Drain pipe		PS1/2B Internal Thread	(PS1/2B) x 2 Internal Thread	(PS1/2B) x 3 Internal Thread

NOTES

- 1 Refer to the engineering data book for the complete list of specifications.
- 2 The normal cooling capacities are based on:
 - indoor temperature: 27°CDB / 19°CWB,
 - inlet water temperature: 30°C,
 - equivalent pipe length: 7.5m,
 - level difference: 0m
- 3 The normal heating capacities are based on: –indoor temperature: 20°CDB,
 - inlet water temperature: 20°C,
 - equivalent pipe length: 7.5m,
 - level difference: 0m
- 4 The nominal input includes total input of the unit: compressor and control circuit.
- 5 Only use incase of –H/R system

COMPRESSOR		FXYCP10MY1	FXYCP20MY1	FXYCP30MY1
Oil type	-	Synthetic(ether)oil	Synthetic(ether)oil	Synthetic(ether)oil
Crankcase heater	(W)	33	33 + 33	33 + 33 + 33
Refrigerant type	-	R410A	R410A	R410A
Refrigerant charge	(kg)	5.2	5.2 + 5.2	5.2 + 5.2 + 5.2

1 - 1 - 4 Electrical specifications

MODEL		FXYCP10MY1	FXYCP20MY1	FXYCP30MY1
Power supply				
Phase	-	3N-	3N-	3N-
Frequency	(Hz)	50	50	50
Voltage	(V)	380 - 415	380 - 415	380 - 415
Voltage torerance	(%)	±10	±10	±10
Recommended fuses	(A)	25	35	45
Compressor				
Phase	-	3-	3-	3-
Frequency	(Hz)	50	50	50
Voltage	(V)	380 - 415	380 - 415	380 - 415
Nominal running current	(A)	9.9 - 9.1	(9.9 - 9.1) + (9.9 - 9.1)	(9.9 - 9.1) + (9.9 - 9.1) + (9.9 - 9.1)

1 Installation of outdoor

1 - 2 Selection of location

This unit is not a type of specifications for outdoor installation.

Always install it in a room.

(machine room, etc.)

Paying attention to the conditions mentioned below, select the place for installation with a prior approval of customer.

- 1 The foundation is strong enough to support the weight of the unit and the floor is flat to prevent vibration and noise generation.
- 2 Consider the space required for refrigerant piping work when installing. Refer to [Necessary Space].
- 3 There is no danger of fire due to leakage of inflammable gas.
- 4 The piping length between the outside unit and the indoor unit may not exceed the allowable piping length. "10-9 Refrigerant piping".
- 5 Locations where the noise of the unit operating will not disturb nearby houses, etc.
- 6 Locations with airflow and ventilation holes capable of dissipating heat from the machine and where the ambient temperature around the outside unit is between 0 and 40°C and the humidity does not exceed 80%.

[Necessary Space]

When installing, secure the space mentioned below without fail.

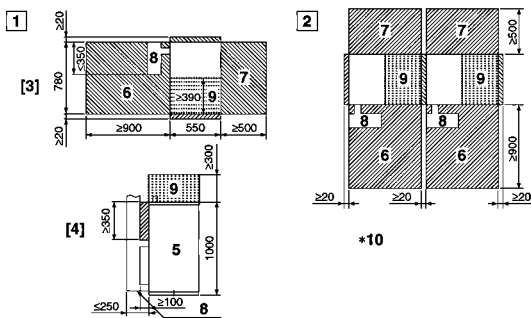

- ① In case of a single installation [mm]
- ② In case of series installations [mm]
- ③ Top view
- ④ Side view
- ⑤ Outside unit
- ⑥ Service Space (front side)
- ⑦ Service Space (back side)
- ⑧ Space for installing water piping
*Secure a enough space for removing the front panel.
- ⑨ Ventilation Space
*above the area () of the outside unit.
- ⑩ Secure spaces in the front, back and top sides as same as the case of single installation.

1 Installation of outdoor

1 - 2 Selection of location

CAUTION

- 1 An inverter air conditioner may cause electronic noise generated from AM broadcasting. Examine where to install the main air conditioner and electric wires, keeping proper distances away from stereo equipment, personal computers, etc.

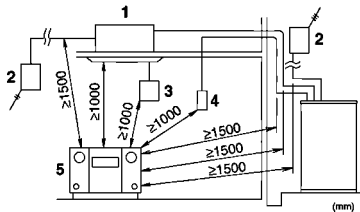

- ① Indoor unit
- ② Branch switch, overcurrent breaker
- ③ Remote controller
- ④ Cool/heat selector
- ⑤ Personal computer or radio

If the electric wave of AM broadcasting is particularly weak, keep distances of 3m or more and use conduit tubes for power and transmission lines.

- 2 Water quality
Water containing high level of foreign materials may cause the corrosion of heat exchanger and piping or scale accumulation. Use water satisfying "10-7-4 Water quality".
- 3 Cooling tower
Use a closed type cooling tower without fail. (Open type tower cannot be used.)
- 4 Strainer
Install a strainer (an optional accessory) without fail at the inlet of water piping. (If sands, wastes, rust particles, etc. are mixed in the water circulation system, damage to the plate type heat exchanger may be caused by the corrosion of metal materials and clogging of the heat exchanger.)
- 5 The refrigerant R410A itself is nontoxic, nonflammable and is safe. If the refrigerant should leak however, its concentration may exceed the allowable limit depending on room size. Due to this it could be necessary to take measures against leakage. Refer to the chapter "Caution for refrigerant leaks".

1 - 3 Inspecting and handling the unit

At delivery, the package should be checked and any damage should be reported immediately to the carrier claims agent.

When handling the unit, take into account the following:

- 1 Fragile, handle the unit with care.
Keep the unit upright in order to avoid compressor damage.
- 2 Choose the path along which the unit is to be brought in ahead of time.
- 3 In order to prevent any damage to the unit during installation, use slings (cloth) or patch plates and lift the unit referring to the figure below.
- 4 Lift the unit preferably with a crane and 2 belts of at least 4m long.
- 5 Use patch plates or clothes where the belt may hit the casing in order to prevent the casing from being damaged.
- 6 Be sure use the standard supplied accessories and dedicated parts as installation parts.

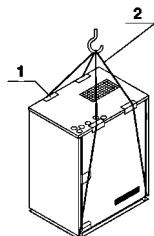

- ① Patch plates or clothes
- ② Belt sling

NOTE

Use belt sling of 20mm width or less which adequately bears the weight of the product.

1 Installation of outdoor

1 - 4 Unpacking and placing the unit

- Make sure the area around the machine drains properly by setting up drainage grooves around the foundation.
- Make sure the unit is installed level on a sufficiently strong base to prevent vibration and noise.
- Secure the unit to its base using foundation bolts. (Use four commercially available M12-type foundation bolts, nuts, and washers.)
- The foundation bolts should be inserted 20 mm.
- Fix 4 foundation bolts.
- Support the unit with the foundation which is larger than the hatched area shown in the figure below.

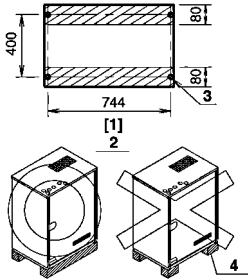
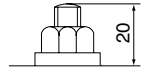

- ① Front side
- ② Position of foundation bolts
- ③ Hole for a foundation bolt
($\varnothing 17$ holes at 4 corners)
- ④ Avoid such a foundation where the unit is supported by 4 corner points.

CAUTION

When installing the unit closely contacting the wall for any unavoidable reason, arrange so that no vibration from the unit may be transmitted to the wall surface by insulating the vibration using cushions, etc.

1 Installation of outdoor

1 - 5 Water piping work

- The water pressure resistance of water piping of this outside unit is 1.96 MPa.
- The connection port for water piping is located in the front. The connection ports for drain piping are located in the front and back. When using the back port, change the cast iron plug from the back to the front and securely close it.
- Because of indoor use, carry out piping work in such a way no water may drop on the outer plate.
- Drain piping should be short and have a slant downwards.
The diameter of drain pipe should be the same as the diameter of unit connection (1/2B) or larger.
- The diameter of water pipe should be the same as the diameter of unit connection (1-1/4) or larger.
- Install an air purge valve in the midway of the water piping to prevent cavitation.
- After completing the drain piping work, make sure that the water runs smoothly without any clogging by dust.
- Do not connect the drain outlet to the water outlet.
- Install a strainer (an optional accessory) in the inlet of water piping within a distance of 1.5 m from the outside unit.
(If sand, waste or rust particles are mixed in the water circulation system, metal materials will become corrosive.)
- Install insulation on the inlet/outlet of water piping to prevent condensation and freezing.
- Install insulation up to the base of heat exchanger as shown in the figure below.
- Install a gate valve for chemical cleaning in an easy position to handle.
- Use water pipes complied with the local and national codes.
- Run the water pump to flush inside of water piping.
Then, clean the strainer.
- If there is a possibility of freezing, take measures to prevent freezing.
- Tighten securely the connection of water piping and socket with tightening torque of 300 N·m or less.
(If a larger torque is applied, the unit may be damaged.)

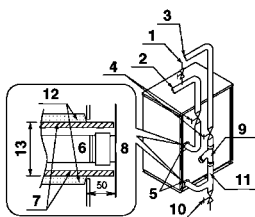

- ① Air purge
- ② Outlet of water
- ③ Inlet of water
- ④ Gate valve
- ⑤ Water piping socket
- ⑥ Water piping
- ⑦ Insulation
- ⑧ Heat exchanger
- ⑨ Strainer (an optional accessory)
- ⑩ Drain valve
- ⑪ Connection port to draining piping
- ⑫ Insulation cover
- ⑬ 80 mm or less

1 Installation of outdoor

1 - 6 Handling of the plate type heat exchanger

CAUTION

The brazing plate type heat exchanger (the plate type heat exchanger) is used for this outside unit. Because its structure is different from a conventional type heat exchanger, it must be handled in a different manner.

1 - 6 - 1 When designing the equipment

- 1 Install a strainer (an optional accessory) at the water inlet side adjacent to the outside unit in order to prevent any foreign materials such as dust, sand, etc. from entering.
- 2 Depending on the water quality, scale may stick to the plate type heat exchanger. In order to remove this scale, it is necessary to clean it at a regular interval using chemicals. To this end, install a gate valve in the water piping. Set up a piping connection port on the piping between this gate valve and the outside unit for cleaning by chemicals.
- 3 For the purpose of cleaning and water drain off from the outside unit (water draining during a long period of nonuse in winter, draining upon starting of season-off), install an "air discharge plug" and a "water draining plug" at the inlet/outlet ports of water piping. In addition, install an "automatic air discharging valve" at the top of riser piping or at the top of a portion where air tends to stay.
- 4 Independent of the piping inlet of the outside unit, install a cleanable strainer at a portion close to the pump piping inlet.
- 5 Carry out complete cooling/thermal insulation of water piping and outdoor dehumidification. If complete cooling or thermal insulation has not been carried out, any damage may be caused during severe winter due to freezing, in addition to thermal loss.
- 6 When you stop operation during night or winter, it is necessary to take measures to prevent water related circuits from natural freezing in the area the ambient temperature drops below 0°C (by water drain off, keeping the circulation pump running, warming up by a heater, etc.) Freezing of water related circuits may result in any damage to the plate type heat exchanger. Therefore, please take appropriate measures depending on the circumstances of use.

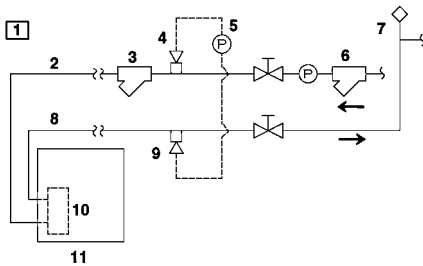

- ① Example of piping
- ② Water inlet piping
- ③ Strainer (sold separately as an accessory)
- ④ Air discharge plug (for joint use with cleaning port)
- ⑤ Cleaning device
- ⑥ Strainer for pump
- ⑦ Automatic air discharge valve
- ⑧ Water outlet piping
- ⑨ Joint use with water draining plug
- ⑩ Plate type heat exchanger
- ⑪ Outside unit

1 - 6 - 2 Before starting a test run

- 1 Before starting a test run, please make sure that the piping work has been carried out in a proper manner. Especially, make sure that the strainer, air discharge valve, automatic water supply valve, expansion tank and cistern are positioned at their places correctly.
- 2 After water has been completely filled in, first run the pump only, and then make sure that no air has been caught in the water circulation system and the water flow rate is correct. If any air has been caught or the flow rate is not enough, the plate type heat exchanger may freeze. Measure any water pressure loss before and after the outside unit and make sure that the flow rate is as designed. In case of any abnormal, stop the test run immediately and carry out trouble shooting to resolve the trouble.
- 3 Following the installation manual, carry out a test run of the outside unit.
- 4 After the test run has been completed, inspect the strainer at the inlet piping of the outside unit. Clean it if it is dirty.

1 Installation of outdoor

1 - 6 Handling of the plate type heat exchanger

1 - 6 - 3 Daily service and maintenance

1 Management of water quality

The plate type heat exchanger has a structure that does not permit dismantling and cleaning, or replacing any parts. Please pay attention carefully to the quality of water to be used for the plate type heat exchanger in order to prevent corrosion and sticking of scale.

The water to be used for the plate type heat exchanger should have at least the quality as specified in the table below.

When using any corrosion prevention agent, scale depressant agent, etc. such agent should have no corrosive features against stainless steel and copper.

2 Management of chilled water flow rate

If the chilled water flow rate is not enough, it will result in the freezing damage to the plate type heat exchanger.

Check for any clogging of the strainer, any air being caught, any reduction in the flow rate due to failure of circulation pump by measuring the temperature and pressure differences at the inlet and outlet ports of the plate type heat exchanger. If the aged difference in the temperature or pressure has increased beyond the proper range, the flow rate should have decreased. Stop the operation and remove the cause before restarting the operation.

3 Steps to be taken when a freezing protection device was activated

When the freezing protection device should be activated during operation, remove the cause without fail before restarting the operation. If the freezing protection device has been once activated, a partial freezing has occurred. If you restart the operation without removing the cause, the plate type heat exchanger will be closed and the ice cannot be melted, and in addition, the freezing process will be repeated resulting in any damage to the plate type heat exchanger, leading to any such accidents that the refrigerant starts leaking or water starts entering the refrigerant circuit.

1 - 6 - 4 Water quality

Water quality standards for chilled water, hot water and make-up water (4) (6)

ITEM (5)	Cooling water system (3)		Hot water system (2)		Tendency (1)	
	Circulation system		Circulation water (20°C ~ 60°C)	Make-up water	Corrosion	Scale
	Circulation water	Make-up water				
Standard items						
pH (25°C)	6.8 to 8.2	6.0 to 8.0	7.0 to 8.0	7.0 to 8.0	○	○
Electrical conductivity (mS/m) (25°C)	Less than 80	Less than 30	Less than 30	Less than 30	○	○
Chloride ions (mg Cl ⁻ /l)	Less than 200	Less than 50	Less than 50	Less than 50	○	
Sulfate ions (mg SO ₄ ²⁻ /l)	Less than 200	Less than 50	Less than 50	Less than 50	○	
Acid consumption (pH 4.8) (mg CaCO ₃ /l)	Less than 100	Less than 50	Less than 50	Less than 50		○
Total hardness (mg CaCO ₃ /l)	Less than 200	Less than 70	Less than 70	Less than 70		○
Calcium hardness (mg CaCO ₃ /l)	Less than 150	Less than 50	Less than 50	Less than 50		○
Ionic-state silica (mg SiO ₂ /l)	Less than 50	Less than 30	Less than 30	Less than 30		○
Reference items						
Iron (mg Fe/l)	Less than 1.0	Less than 0.3	Less than 1.0	Less than 0.3	○	○
Copper (mg Cu/l)	Less than 0.3	Less than 0.1	Less than 1.0	Less than 0.1	○	
Sulfite ion (mg S ²⁻ /l)	Shall not be	Shall not be	Shall not be	Shall not be	○	
Ammonium ion (mg NH ₄ ⁺ /l)	Less than 1.0	Less than 0.1	Less than 0.3	Less than 0.1	○	
Residual chlorine (mg CL/l)	Less than 0.3	Less than 0.3	Less than 0.25	Less than 0.3	○	
Free carbon dioxide (mg CO ₂ /l)	Less than 4.0	Less than 4.0	Less than 0.4	Less than 4.0	○	
Stability index	6.0 to 7.0	-	-	-	○	○

NOTES

- The circle marks in the columns for corrosion or scale to develop.
- Corrosion has a tendency to occur when water temperature is high (40°C or higher), and if metals with no protective coating whatever are directly exposed to water, it would be a good idea to take effective measures against corrosion such as adding a corrosion inhibitor or deaeration treatment.
- In a condenser water circuit that uses a closed cooling tower, the closed circuit circulating water and make-up water must satisfy its water quality standards for the hot water system, and passing water and make-up water must satisfy those for the circulation type cooling water system.
- Supply or make-up water should be tap water (clean water), industrial water and underground water except for purified water, neutral water and softened water or the like.
- The fifteen items in the table above represent typical causes of corrosion and scale.
- Passing water may cause corrosion.
Do not use passing water.

1 Installation of outdoor

1 - 6 Handling of the plate type heat exchanger

1 - 6 - 5 Maintenance of plate type heat exchanger

The performance of a plate type heat exchanger may decline due to scale accumulation. It may be damaged by freezing due to the drop of flow rate. For this reason, it is necessary to carry out programmed maintenances at a regular interval in order to prevent the scale from being generated.

- 1 Before entering the season for use, carry out the following inspections:
 - Conduct a water quality test and make sure that it is within the standard.
 - Clean the strainer.
 - Make sure that the flow rate is correct.
 - Make sure that the operational conditions (pressure, flow rate, outlet temperature, etc.) are normal.

- 2 Because the plate type heat exchanger has a structure which does not permit disassembling and cleaning, follow the following procedures for cleaning:
 - Make sure that a connection port for piping has been reserved for cleaning by chemicals. For chemicals to clean the scale, solution with 5% diluted formic acid, citric acid, oxalic acid, acetic acid, phosphoric acid, etc. is recommendable. Never use hydrochloric acid, sulfuric acid, nitric acid, etc., because they have strong corrosive features.
 - Make sure that a valve has been reserved for each before the inlet connection port and after the outlet connection port.
 - Connect the piping for circulation of cleaning chemicals to the inlet piping of plate type heat exchanger. Fill the cleaning solution of 50 - 60°C for a while in the plate type heat exchanger. Then, circulate the cleaning solution by a pump for 2-5 hours. The time for cleaning depends on the temperature of cleaning solution or the degree of scale accumulation. Therefore, please watch the change of the dirtiness (color) of cleaning solution to determine the level of removal of scale.
 - After circulating the cleaning solution, discharge the solution from the plate type heat exchanger, fill the heat exchanger with a solution of 1-2% sodium hydroxide (NaOH) or sodium bicarbonate (NaHCO₃). Circulate this solution for 15-20 minutes for neutralization purpose.
 - After the process of neutralization has been completed, rinse the inner part of the plate type heat exchanger with care using fresh and clean water.
 - When using any cleaning agent sold in the market, check in advance that such agent has no corrosive features against stainless steel and copper.
 - For details of cleaning method, ask the manufacturer of related cleaning agent.

- 3 After cleaning has been completed, make sure that the unit can be operated in a normal fashion.

1 Installation of outdoor

1 - 7 Field wiring

CAUTION

All field wiring and components must be installed by a licensed electrician and must comply with relevant local and national regulations.
 The field wiring must be carried out in accordance with the wiring diagrams and the instructions given below.
 Be sure to use a dedicated power circuit. Never use a power supply shared by another appliance.
 Do not operate until refrigerant piping work is completed.
 (If operated before complete the piping work, the compressor may be broken down.)
 Never remove thermistor, sensor or etc. when connecting power wiring and transmission wiring.
 (If operated with thermistor, sensor or etc. removed, the compressor may be broken down.)
 Be sure to install an earth leak detector.
 (This unit uses an inverter, so install the earth leak detector that be capable of handling high harmonics in order to prevent malfunctioning of the earth leak detector itself.)
 This product have reversed phase protection detector that only works when the product started up.
 Do not run the unit by short cutting the protection device (S1PH).
 If there exists the possibility of reversed phase, lose phase, momentary black out or the power goes on and off while the product is operating, attach a reversed phase protection circuit locally. Running the product in reversed phase may break the compressor and other parts.
 Attach the power wire securely.
 Introducing power with a missing N-phase or with a mistaken N-phase will break the equipment.

1 - 7 - 1 Optional parts

COOL/HEAT Selector

S1S.....Selector switch (fan, cool/heat), S2S.....Selector switch (cool/heat)

NOTES

- 1 When using the adaptor for sequential start, refer to chapter “Examples”.
- 2 For connection wiring to the central remote controller, refer to the installation manual of the central remote controller.

1 - 7 - 2 Power circuit and cable requirements

A power circuit (see table below) must be provided for connection of the unit. This circuit must be protected with the required safety devices, i.e. a main switch, a slow blow fuse on each phase and an earth leak detector.

	Phase and frequency	Voltage	Minimum circuit amp.	Recommended fuses	Transmission line selection
FXYCP10MY1	ø 3, 50Hz	380 - 415V	12.6A	25A	0.75 - 1.25mm ²
FXYCP20MY1	ø 3, 50Hz	380 - 415V	25.3A	35A	0.75 - 1.25mm ²
FXYCP30MY1	ø 3, 50Hz	380 - 415V	37.9A	45A	0.75 - 1.25mm ²

When using residual current operated circuit breakers, be sure to use a high-speed type 200mA rated residual operating current.

NOTES

- 1 Use copper conductors only.
- 2 Use insulated wire for the power cord.
- 3 Select the power supply cable in accordance with relevant local and national regulations.
- 4 Wire size must comply with the applicable local and national code.
- 5 Specifications for local wiring power cord and branch wiring are in compliance with IEC60245.
- 6 WIRE TYPE H05VV(*)
 *Only in protected pipes, use H07RN-F when protected pipes are not used.

1 Installation of outdoor

1 - 7 Field wiring

1 - 7 - 3 General

- Up to 3 units can be connected by crossover power source wiring between outside units. For details, refer to the equipment design data and technical data.
- Make sure to connect the power source wire to the power source terminal block and to clamp it as shown in figure 8, chapter “Field line connection”.
- As this unit is equipped with an inverter, installing a phase advancing capacitor will not only deteriorate power factor improvement effect, but also may cause capacitor abnormal heating accident due to high-frequency waves. Therefore, never install a phase advancing capacitor.
- Keep power imbalance within 2% of the supply rating.
1 Large imbalance will shorten the life of the smoothing capacitor.
2 As a protective measure, the product will stop operating and an error indication will be made, when power imbalance exceeds 4% of the supply rating.
- Follow the “electrical wiring diagram” when carrying out any electrical wiring.
- Only proceed with wiring work after blocking off all power.
- Always ground wires. (In accordance with national regulations of the pertinent country.)
- Do not connect the ground wire to gas pipes, sewage pipes, lightning rods, or telephone ground wires.
Gas pipes: can explode or catch fire if there is a gas leak.
Sewage pipes: no grounding effect is possible if hard plastic piping is used.
Telephone ground wires and lightning rods: dangerous when struck by lightning due to abnormal rise in electrical potential in the grounding.
- This machine includes an inverter device. Connect earth and leave charge to eliminate the impact on other devices by reducing noise generated from the inverter device and to prevent leaked current from being charged in the outer hull of the product.
- Earth leak detector which are especially for protecting ground faults should be used in conjunction with main switch or fuse for use with wiring.
- Connect the wire securely using designated wire and fix it with attached clamp without applying external pressure on the terminal parts (terminal for power wiring, terminal for transmission wiring and earth terminal). See “field line connection”.
- Never connect the power supply in reversed phase.
(This product have reversed phase protection detector.
If the detector operate, replace two of the three phases (L1, L2 and L3).

1 - 7 - 4 Examples

System example

[Heat pump system]

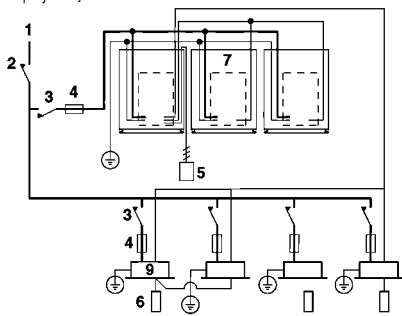

[Heat recovery system]

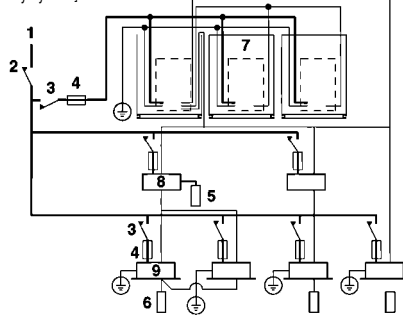

- ① Field power supply
- ② Main switch
- ③ Earth leak detector
- ④ Fuse
- ⑤ Cool/heat selector
- ⑥ Remote controller
- ⑦ Outside unit
- ⑧ BS unit
- ⑨ Indoor unit

—power supply wiring (sheathed cable)
—transmission wiring (sheathed cable)

1 Installation of outdoor

1 - 7 Field wiring

1 - 7 - 4 Examples

CAUTION

- 1 Use a power wire pipe for the power wiring.
- 2 Outside the unit, make sure the weak electric wiring (i.e. for the remote controller, transmission, etc.) and the strong electric wiring do not pass near each other, keeping them at least 50 mm apart. Proximity may cause electrical interference, malfunctions, and breakage.
- 3 Be sure to connect the power wiring to the power wiring terminal block and secure it as described in **Field line connection**.
- 4 Transmission wiring should be secured as described in **Field line connection: transmission wiring and COOL/HEAT selector**.
- 5 Secure the wiring with the accessory clamps so that it does not touch the piping.
- 6 Make sure the wiring and the EL. COMPO. BOX cover do not stick up above the structure, and close the cover firmly.

Picking power line and transmission line

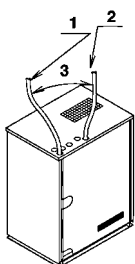

- ① Power supply wiring
Pump operation output
(High voltage)
- ② Connection wiring
(Low voltage)
- ③ Set apart

Connect the wire to the terminal block on PC board with care since too much pressure may cause breakage of the PC board.

Field line connection: transmission wiring, interlock circuit, pump operation output and COOL/HEAT selector

Connect the wire to the terminal block on the PC board with care since too much pressure may cause breakage of the PC board.

1 Installation of outdoor

1 - 7 Field wiring

1 - 7 - 4 Examples

[In case of RWEYQ10MY1]

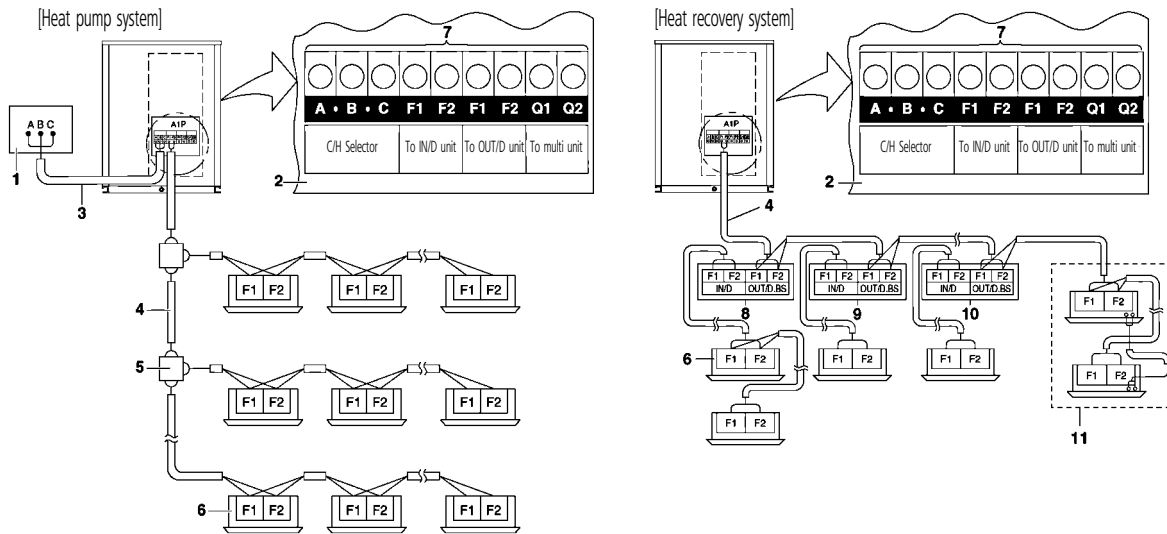

- ① COOL/HEAT selector
- ② Outside unit PC board (A1P)
- ③ Take care of the polarity
- ④ Use the conductor of sheathed wire (2 wire) (no polarity)
- ⑤ Terminal board (field supply)
- ⑥ Indoor unit
- ⑦ Never connect the power wire.
- ⑧ BS unit A
- ⑨ BS unit B
- ⑩ Last BS unit
- ⑪ Cool-only unit

[In case of RWEYQ20,30MY1]

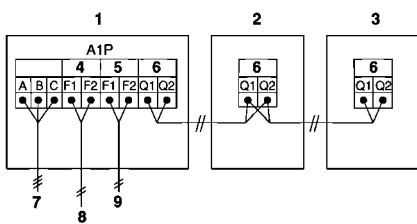

- ① Unit A (Master unit)
- ② Unit B
- ③ Unit C
- ④ TO IN/D UNIT
- ⑤ TO OUT/D UNIT
- ⑥ TO MULTI UNIT
- ⑦ To COOL/HEAT selector (only Heat pump system)
- ⑧ To indoor unit
- ⑨ To other systems

1 Installation of outdoor

1 - 7 Field wiring

1 - 7 - 4 Examples

- The transmission wiring between the outside units in the same pipe line must be connected to the Q1/Q2 (Out Multi) terminals. Connecting the wires to the (Out-Out) terminals results in system malfunction.
- The wiring for the other lines must be connected to the F1/F2 (Out-Out) terminals of the PC board in the outside unit to which the transmission wiring for the indoor units is connected.
- The outside unit to which the transmission wiring for the indoor units is connected is master unit.
- The transmission wiring between the outside units must be 30 m in length at maximum.

[Setting the interlock circuit and pump operation output.]

<Pump operation output [high voltage]>

- Use insulated wires of the size as mentioned below having rated voltage of 250 V or higher:
For single core: 1.25 mm² or larger (conduit pipe work)
For multiple cores: 0.75 mm² or larger

*The wiring for pump operation output is to be procured locally

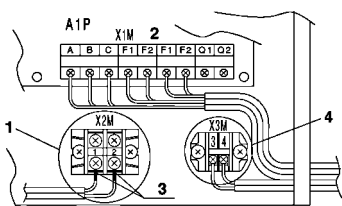

- ① Pump operation output terminal (X2M) when water pump is linked with system operation, water pump operation circuit shall be set between terminals (1) and (2).
Contact specification --- 220 VAC, 3mA-0.5A

- ② PC board (A1P)

- ③ Mount an insulation sleeve.

④ Connection of interlock circuit

Do not forget to connect an interlock circuit (an auxiliary a-contact of electromagnetic switch for the water pump) to each outside unit.

(Select without fail an auxiliary a-contact able to switch minimum load of DC15V, 1mA.)

<When connecting for each outside unit>

Connect to the terminal block (X3M) as shown in the bottom right of the sketch.

<When connecting in a lump-sum manner (centralized interlock)>

For this unit, it is possible to make a lump-sum interlock of multiple outside unit using an adapter (sold separately as an accessory) for external control of outside units.

For details of wiring connection, refer to “How to centralized interlock wiring”.

<How to the centralized interlock wiring>

- When centralized interlock is done, see (3) “10-8-5 In case of a local setting”
- No wiring to terminal block X3M is necessary when centralized interlock is employed
- For RWEYQ20-30MY1, external/external connection wiring shall be done for master unit only.

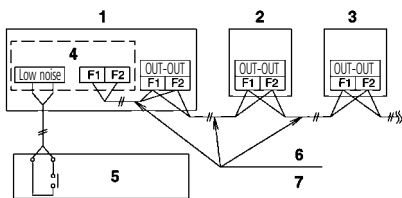

- ① Outside unit A
- ② Outside unit B
- ③ Outside unit C
- ④ Adapter for external control
- ⑤ Interlock circuit of water pump
- ⑥ Out-Out connection wiring
- ⑦ Use the conductor of sheathed wire (2 wire) (no polarity)

1 Installation of outdoor

1 - 7 Field wiring

1 - 7 - 4 Examples

[Setting the cool/heat operation type]

- 1 Performing cool/heat setting with the remote controller connected to the indoor unit.
Keep the COOL/HEAT selector switch (DS1) on the outside unit PC board (A1P) at the factory setting position OFF.

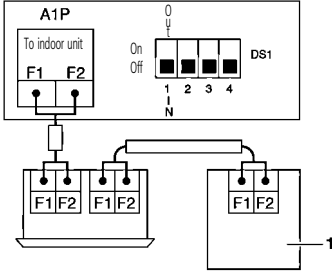

① Remote controller

- 2 Performing cool/heat setting with the COOL/HEAT selector.
Connect the COOL/HEAT selector (optional) to the A/B/C terminals and set the COOL/HEAT selector switch (DS1) on the outside unit PC board (A1P) to ON.

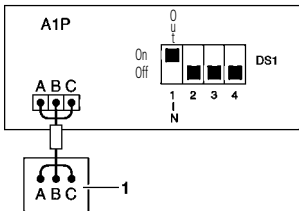

① COOL/HEAT selector

- For the above wiring, always use sheathed vinyl cords with 0.75 to 1.25 mm² or cables (2 core wires). (3 core wire are allowable for the COOL/HEAT selector only.)
- All transmission wire is field supply.
- If the following limits should be exceeded, be careful that any abnormal transmission may be caused;
 - Maximum wiring length1000 m or less
 - Total wiring length2000 m or less
 - Maximum branching16 branching or less
 - Wire length between outside unit30 m or less
- Never connect power supply to any connection wiring and its terminal block, otherwise the entire system may be damaged.
- Up to 16 branches are possible for transmission wiring. However no branch is allowed after branch.

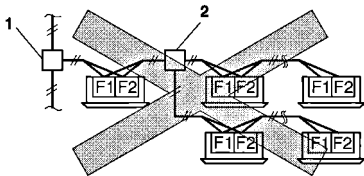

① Branch
② Branch after branch

- The wiring to the indoor units must be connected to the F1/F2 (To IN/D UNIT) terminals on the PC board in the outside unit.

1 Installation of outdoor

1 - 7 Field wiring

1 - 7 - 4 Examples

Field line connection: Power supply wiring and transmission wiring

Make sure to connect the power wire to the power terminal block and fix it using attached clamp as shown in figure 15 and 19.

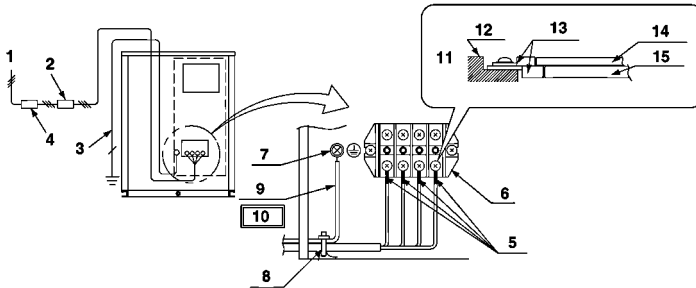

- ① Power supply
(3N~, 380-415V)
- ② Branch switch, overcurrent breaker
- ③ Grounding wire
- ④ Earth leakage breaker
- ⑤ Attach insulation sleeves.
- ⑥ Power supply terminal block
- ⑦ Grounding terminal
- ⑧ Retain the ground wires along with the power wires using the accessory clamp (A).
- ⑨ Grounding wire
- ⑩ When wiring, do not allow the ground wires to contact the compressor lead wires. If the wires contact each other, adverse effects may occur to other units.
- ⑪ When connecting two wires to one terminal, ensure that the crimp-style terminals face with each other back to back. Moreover, make sure that the wire of the smaller gauge is located above.
- ⑫ Terminal block
- ⑬ Crimp-style terminal
- ⑭ Wire gauge: Small
- ⑮ Wire gauge: Large

1 Installation of outdoor

1 - 7 Field wiring

1 - 7 - 4 Examples

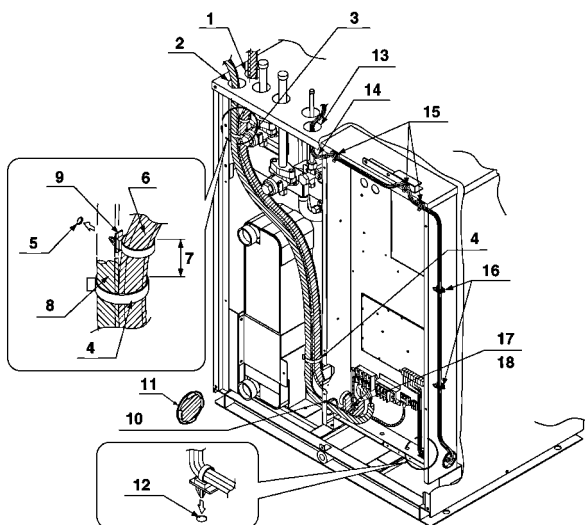

- ① Intake for power supply wiring, pump operation output (high voltage) and ground wiring.
- ② Intake for power supply jumper wiring and ground jumper wiring. (Only for jumping the power supply.)
- ③ Stop valve for discharge gas (high temperature part)
- ④ Retain the power supply wiring, pump operation output (high voltage) and ground wiring with the accessory clamp(A).
- ⑤ Insert the accessory clamp (B) in the hole of the fixing plate for stop valve.
- ⑥ Power supply wiring, pump operation output (high voltage) and ground wiring.
- ⑦ Approximately 50mm
- ⑧ Power supply jumper wiring and ground jumper wiring.
- ⑨ Retain the power supply wiring, pump operation output (high voltage) and ground wiring with the accessory clamp (B) to prevent them from touching with the stop valve for discharge gas.
- ⑩ Use the through hole cover for power jumper supply by cutting the hatched area.
- ⑪ Hatched area
- ⑫ Insert the accessory clamp (B) in the hole of the bottom of electrical box.
- ⑬ Intake for transmission wiring. (low voltage)
- ⑭ Make the transmission wiring have a trap with looseness to prevent condensate from reaching the top of electrical box.
- ⑮ Fix the transmission wiring to resin clamps with the accessory clamps (A)
- ⑯ Pass the transmission wiring (low voltage) through the wire clip.
- ⑰ Retain the power supply wiring, pump operation output (high voltage) and ground wiring to the bottom of electrical box with the accessory clamp (B)
- ⑱ Do not bundle the power supply jumper wiring.

1 Installation of outdoor

1 - 7 Field wiring

1 - 7 - 4 Examples

CAUTION

<Precautions when laying power wiring>

Use crimp-style terminals for connections to the power terminal block.

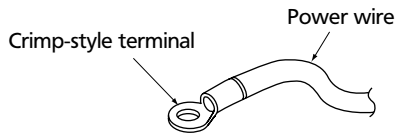

When none are available, follow the instructions below.

- Do not connect wiring of different size to the power terminal block. (Slack in the power wiring may cause abnormal heat.)
- When connecting wiring which is the same thickness, do as shown in the figure below.

Connect same-size wiring to both sides.

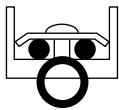

It is forbidden to connect two to one side.

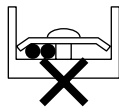

It is forbidden to connect wiring of different size.

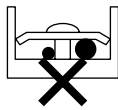

- For wiring, use the designated power wire and connect firmly, then secure to prevent outside pressure being exerted on the terminal board.
- Use an appropriate screwdriver for tightening the terminal screws. A screwdriver with a small head will strip the head and make proper tightening impossible.
- Over-tightening the terminal screws may break them.
- See the table below for tightening torque for the terminal screws.

	Tightening torque (N · m)
M5 (Power terminal block)	3.0 - 4.1
M5 (Ground)	
M3 (transmission wiring terminal block)	0.8 - 0.97

<Precautions when connecting the ground>

When pulling the ground wire out, wire it so that it comes through the cut out section of the cup washer. (An improper ground connection may prevent a good ground from being achieved.)

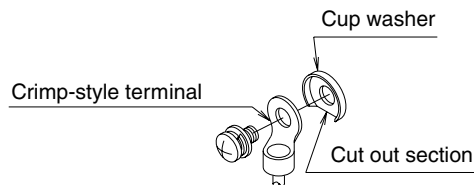

1 - 7 - 5 In case of a local setting

If necessary, do the local settings as mentioned in the table below.

For setting, refer to the plate “Cares to be taken in servicing” attached to the cover of electrical box.

Typical local settings

*For other settings than mentioned in the table below, refer to the equipment design materials and service manual.

(1) Setting of switching between cooling and heating	This setting is done when switching between cooling and heating is performed by a switching remote controller (sold separately as an accessory) installed on the outside unit.
(2) Setting to prohibit sequenced start	This setting is done when the outside units are not started in a sequenced order.
(3) Setting of centralized interlock Setting of external demand	These settings are done when the interlocks are connected in a lump-sum manner or when performing a demand operation by external instruction.
(4) Setting of abnormal display when interlock contact is OFF	This setting is done when making an abnormal display (HJ) on a remote controller when the interlock contact is OFF (when the heat source water pump is not operated)

CAUTION

A separate adapter (sold separately as an accessory) for external control of an outside unit becomes necessary when doing a demand operation from an external instruction, setting of cooling and heating through a centralized remote controller for cooling and heating (sold separately as an accessory) and setting of centralized interlock.

For details, refer to the pamphlet attached to the adapter.

1 Installation of outdoor

1 - 8 Refrigerant piping

CAUTION

After completing installation, be sure to open the valve.

(See **10-9-9 Additional refrigerant charge for details**) (Operating the unit with the valve shut will break the compressor.)

Use R410A to add refrigerant. (The R410A refrigerant cylinder has a pink stripe painted around it.)

All field piping must be installed by a licensed refrigeration technician and must comply with relevant local and national regulations.

CAUTION TO BE TAKEN WHEN BRAZING REFRIGERANT PIPING

Do not use flux when brazing copper-to-copper refrigerant piping.

(Particularly for the HFC refrigerant piping) Therefore, use the phosphor copper brazing filler metal (BCuP-2: JIS Z 3264/B-Cu93P-710/ 795: ISO 3677) which does not require flux.

(Flux has extremely harmful influence on refrigerant piping systems. For instance, if the chlorine based flux is used, it will cause pipe corrosion or, in particular, if the flux contains fluorine, it will damage the refrigerant oil.)

NOTE

Installation tools:

Gauge manifold, charge hose, etc.

Make sure to use installation tools that are exclusively used for R410A installations to withstand the pressure and to prevent foreign materials (e.g. mineral oils such as SUNISO and moisture) from mixing into the system.

(The screw specifications differ for R410A and R407C.)

Vacuum pump

1 Use a 2-stage vacuum pump with a non-return valve.

2 Make sure the pump oil does not flow oppositely into the system while the pump is not working.

3 Use a vacuum pump which can evacuate to -100.7 kPa (5Torr, -755 mmHg).

1 - 8 - 1 Selection of piping material

- 1 Foreign materials inside pipes (including oils for fabrication) must be 30mg/10m or less.
- 2 Use the following material specification for refrigerant piping:
 - Construction material: Phosphoric acid deoxidized seamless copper for refrigerant.
 - Size: Determine the proper size referring to chapter "Example of connection".
 - The wall thickness of the refrigerant piping should comply with relevant local and national regulations. For R410A the design pressure is 4.0 MPa.
- 3 Make sure to use the particular branches of piping that have been selected referring to chapter "Example of connection".
- 4 Refer to chapter "Shutoff valve operation procedure" in 9-10 about the shutoff valve operation procedure.
- 5 Make sure to perform the piping installation within the range of the maximum allowable pipe length, allowable level difference and allowable length after branching as indicated in chapter "Example of connection"
- 6 For installation of the refrigerant branching kit, refer to the installation manual delivered with the kit. And follow the conditions listed below.
 - Mount the REFNET joint so that it branches either horizontally or vertically.
 - Mount the REFNET header so that it branches horizontally.

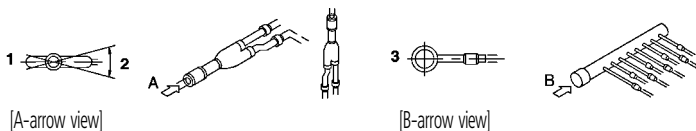

- ① Horizontal surface
- ② With in 30° against horizontal surface
- ③ Horizontal surface

- 7 The outside unit multi connection piping kit that is sold separately as an option (BHFP22MA56-84) is necessary for the multi installation of indoor units. See the installation manual attached to the kit with attention to the following restrictions when installing.

1 Installation of outdoor

1 - 8 Refrigerant piping

1 - 8 - 1 Selection of piping material

Restriction for the installation of the outside unit multi connection piping kit

- Install the joint horizontally within a lean of $\pm 15^\circ$ with caution nameplate on top. Refer to figure 23 (Fig. A)
Do not connect it vertically. Refer to figure below (Fig. B)
- Reserve the straight part of 500mm or more to the branch pipe and do not bend the local pipe in that area. Straight part of 500mm or more can be reserved if a local pipe (straight pipe) of 120mm or more is connected to the joint. Refer to figure below (Fig. C)
- Incorrect installation may cause breakage of outside unit.

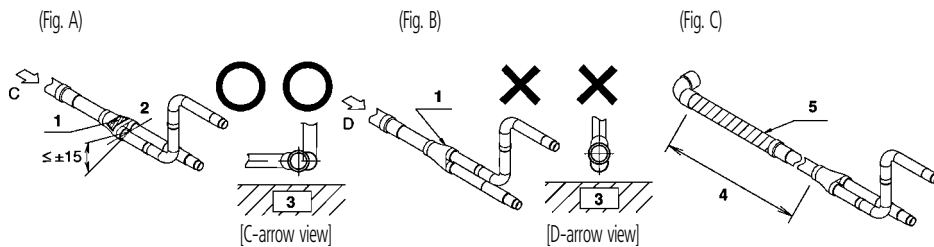

- ① Caution nameplate
- ② Horizontal line
- ③ Ground
- ④ Straight part of 500mm or more
- ⑤ Local pipe (120mm length or more)

Precautions when selecting branch piping.

- If the equivalent length of piping between the outside units and indoor units is 80m or longer, be sure to enlarge the main pipe in the liquid-side branch piping.
Depending on the length of the refrigerant piping, the cooling/ heating capacity may drop, but even in such cases it is ok to enlarge the main pipe.

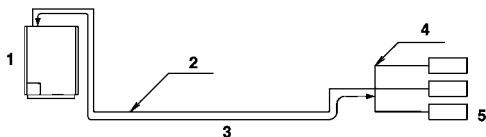

- ① Outside unit
- ② Main pipe
- ③ Enlarge
- ④ The first refrigerant branching kit.
- ⑤ Indoor unit

[Liquid side]

RWEYQ10MY1 type:f9.5. f12.7 (Minimum thickness f0.80mm)

RWEYQ20MY1 type:f15.9. f19.1 (Minimum thickness f1.00mm)

RWEYQ30MY1 type:f19.1. f22.2 (Minimum thickness f1.00mm)

(Unit: mm)

TEMPER GRADE	O Type			1/2 H Type					
Outer diameter	ø9.5	ø12.7	ø15.9	ø19.1	ø22.2	ø25.4	ø28.6	ø31.8	ø34.9
Minimum Wall Thickness	0.80	0.80	0.99	0.80	0.80	0.88	0.99	1.10	1.21

1 Installation of outdoor

1 - 8 Refrigerant piping

1 - 8 - 2 Protection against contamination when installing pipes

- Take measures to prevent foreign materials like moisture and contamination from mixing into the system.

Place	Installation period	Protection method
Outdoor	More than a month	Pinch the pipe
	Less than a month	Pinch or tape the pipe
Indoor	Regardless of the period	

- Great caution is needed when passing copper tubes through walls.

1 - 8 - 3 Pipe connection

- Only use the flare nuts included with the unit.
Using different flare nuts may cause the refrigerant to leak.
- Be sure to perform a nitrogen blow when brazing.
(Brazing without performing nitrogen replacement or releasing nitrogen into the piping will create large quantities of oxidized film on the inside of the pipes, adversely affecting valves and compressors in the refrigerating system and preventing normal operation.)

CAUTION

Do not use anti-oxidants when brazing the pipe joints. Residue can clog pipes and break equipment.

NOTES

- 1 For nitrogen replacement method, see the "Installation Manual" (contact your dealer).
- 2 The pressure regulator for the nitrogen released when doing the brazing should be set to 0.02 MPa(0.2kg/cm²) or less.

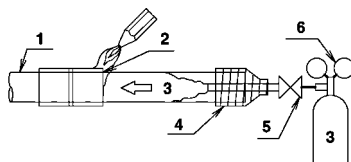

- ① Refrigerant pipe
- ② Location to be brazed
- ③ Nitrogen
- ④ Taping
- ⑤ Manual valve
- ⑥ Regulator

Precautions when connecting pipes

- See the following table for flare part machining dimensions.
- When connecting the flare nuts, apply refrigerant oil to the inside and outside of the flares and screw them in by hand three or four times at first. (Use ester oil or ether oil.)
- See the following table for tightening torque. (Applying too much torque may cause the flares to crack.)
- After all the piping has been connected, check the gas leak with nitrogen.

Pipe size	Tightening torque (N·m)	A (mm)	Flare shape
ø9.5	32.7 - 39.9	12.8 - 13.2	
ø12.7	49.5 - 60.3	16.2 - 16.6	
ø15.9	61.8 - 75.4	19.3 - 19.7	

Not recommendable but in case of emergency

You must use a torque wrench but if you are obliged to install the unit without a torque wrench, you may follow the installation method mentioned below.

After the work is finished, make sure to check that there is no gas leak.

When you keep on tightening the flare nut with a spanner, there is a point where the tightening torque suddenly increases. From that position, further tighten the flare nut the angle shown below:

Pipe size	Further tightening angle	Recommended arm length of tool
ø9.5	60 to 90 degrees	Approx. 200 mm
ø12.7	30 to 60 degrees	Approx. 250 mm
ø15.9	30 to 60 degrees	Approx. 300 mm

1 Installation of outdoor

1 - 8 Refrigerant piping

1 - 8 - 4 Connecting the refrigerant piping

Connect piping to outside unit by using accessory pipes

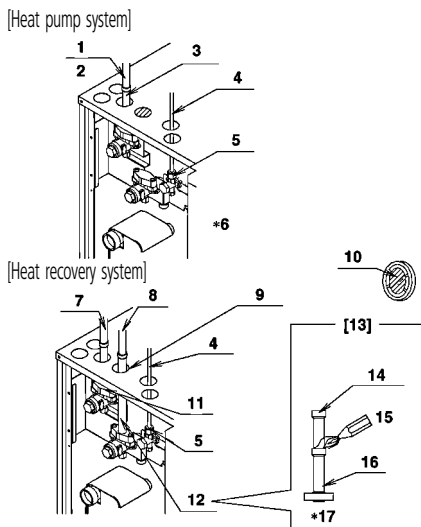

- ① Gas side piping
- ② (field supply)
- ③ Gas side accessory pipe (for suction gas (1))
- ④ Liquid side pipe (field supply)
- ⑤ Flare nut (Included in the unit)
- ⑥ Accessory pipes (for discharge gas and suction gas (2)) is not used.
- ⑦ Piping on discharge gas side (field supply)
- ⑧ Piping on suction gas side (field supply)
- ⑨ Cut off the hatched area and use it as a cover for the drilled.
- ⑩ Hatched area
- ⑪ Accessory pipe (for discharge gas)
- ⑫ Accessory pipe (for suction gas)
- ⑬ Guideline for pipe machining
- ⑭ Accessory pipe (for suction gas (2))
- ⑮ Brazing
- ⑯ Accessory pipe (for suction gas (1))
- ⑰ Before fitting to the product, apply brazing.

Precautions for installation of units

NOTES

- 1 The outside unit multi connection piping kit that is sold separately as an option (BHFP22MA56·84 or BHFP26MA56·84) is necessary for the multi installation of outside units.
- 2 See the installation manual attached to the kit with attention to installation restrictions described in "connecting the refrigerant piping" when installing.

1 Installation of outdoor

1 - 8 Refrigerant piping

1 - 8 - 4 Connecting the refrigerant piping

1 To avoid the risk of oil detention in the piping the piping between the outside units must be routed level or slightly upward.

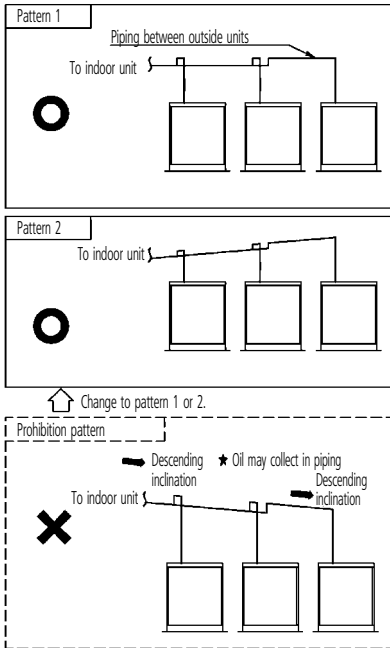

2 The gas piping (both discharge and suction gas pipings in case of the heat recovery system) after branched, install without fail a trap of 200 mm or larger using the piping included in the piping kit for connecting the outside unit. Otherwise, the refrigerant may stay within the piping, causing any damage to the outside unit.

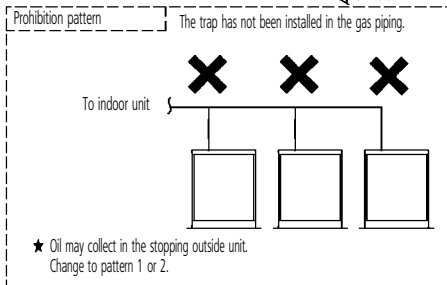
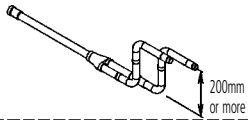

3 If the piping length between the outside unit connecting pipe kit or between the outside units exceeds 2 m, create a rise of 200 mm or more in the gas line within a length of 2 m from the kit.

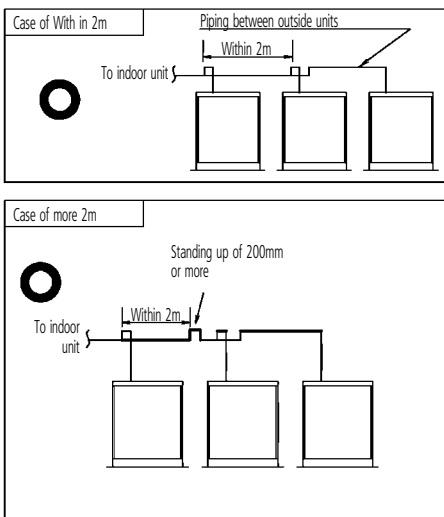

1 Installation of outdoor

1 - 8 Refrigerant piping

1 - 8 - 5 Air tight test and vacuum drying

The units were checked for leaks by the manufacturer.

Confirm that the valves are firmly closed before Air tight test or vacuum drying.

To prevent entry of any impurities and insure sufficient pressure resistance, always use the special tools dedicated for R410A.

- **Air tight test:** Make sure to use nitrogen gas.
(For the service port location, refer to the "Caution" label attached on the front panel [right] of the outside unit.)

(Refer to figure)

- ① [Service precautions] Label
- ② EL. COMPO. BOX cover
- ③ [Caution] Label

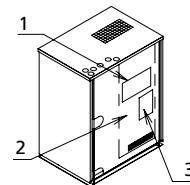

Pressurize the liquid and gas pipes to 4.0MPa (40bar) (do not pressurize more than 4.0MPa (40bar)). If the pressure does not drop within 24 hours, the system passes the test. If the pressure drops, check where the nitrogen leaks from.

- **Vacuum drying:** Use a vacuum pump which can evacuate to -100.7kPa (5Torr, -755mmHg).

1Evacuate the system from the liquid and gas pipes by using a vacuum pump for more than 2 hours and bring the system to -100.7kPa or less. After keeping the system under that condition for more than 1 hour, check if the vacuum gauge rises or not. If it rises, the system may either contain moisture inside or have leaks.

2Following should be executed if there is a possibility of moisture remaining inside the pipe (if piping work is carried out during the raining season or over a long period of time rainwater may enter the pipe during work).

After evacuating the system for 2 hours, pressurize the system to 0.05MPa (vacuum break) with nitrogen gas and evacuate the system again using the vacuum pump for 1 hour to -100.7kPa or less (vacuum drying). If the system cannot be evacuated to -100.7kPa within 2 hours, repeat the operation of vacuum break and vacuum drying.

Then, after leaving the system in vacuum for 1 hour, confirm that the vacuum gauge does not rise.

1 - 8 - 6 Pipe insulation

After finishing the leak test and vacuum drying, the piping must be insulated. Take into account the following points:

- Make sure to insulate the connection piping both liquid-side and gas-side and refrigerant branch kits entirely. Not insulating them may cause leaking. (The gas piping can reach temperatures of 120°C . Be sure the insulation used can withstand such temperatures.)
- Reinforce the insulation on the refrigerant piping according to the installation environment. Condensation might form on the surface of the insulation.
- If there is a possibility that condensation on the shutoff valve might drip down into the indoor unit through gaps in the insulation and piping because the outside unit is located higher than the indoor unit, etc., this must be prevented by caulking the connections, etc.

CAUTION

Be sure to insulate connection piping, as touching them can cause burns.

1 - 8 - 7 Checking of device and installation conditions

Be sure to check the followings.

- 1 Make sure there is no faulty power wiring or loosening of a nut.
See "10-8 Field wiring".
- 2 Make sure there is no faulty transmission wiring or loosening of a nut.
See "10-8 Field wiring".
- 3 Make sure there is no faulty refrigerant piping.
See "10-9 Refrigerant piping".
- 4 Make sure piping size is correct.
See "10-9-1 Selection of piping material".
- 5 Make sure insulation work is done.
See "10-9-7 Pipe insulation".
- 6 Make sure insulation resistance of main power circuit is not deteriorated.
Using a megatester for 500V, check that the insulation resistance of 2M or more is attained by applying a voltage of 500V DC between power terminals and earth. Never use the megatester for the transmission wiring (between outdoor and indoor unit, outdoor and COOL/HEAT selector and etc.).

1 Installation of outdoor

1 - 8 Refrigerant piping

1 - 8 - 8 Additional refrigerant charge

CAUTION

Refrigerant cannot be charged until field wiring has been completed.

Refrigerant may only be charged after performing the leak test and the vacuum drying.

When charging a system, care shall be taken that its maximum permissible charge is never exceeded, in view of the danger of liquid hammer.

Charging with an unsuitable substance may cause explosions and accidents, so always ensure that the appropriate refrigerant (R410A) is charged.

Refrigerant containers shall be opened slowly.

Always use protective gloves and protect your eyes when charging refrigerant.

- This outside unit is factory charged with refrigerant and depending on pipe sizes and pipe lengths some systems require additional charging of refrigerant.
- Determine the amount of refrigerant to be added by referring to the table, write it down on the included "Added Refrigerant" plate and attach it to the rear side of the front cover.

NOTE

Refer to the example of connection for the amount to be added.

Additional refrigerant charge procedure (1)-normally

- Charge the refrigerant to the liquid pipe in its liquid state. Since R410A is a mixed refrigerant, its composition changes if charged in a state of gas and normal system operation would no longer be assured.
 - Make sure to use installation tools you exclusively use on R410A installations to withstand the pressure and to prevent foreign materials from mixing into the system.
- 1 Before charging, check whether the tank has a siphon attached or not.

How to charge with a siphon attached tank.

Charge with the tank upright.

(There is a siphon tube inside, so there is no need to turn the tank upside-down.)



How to charge with other tank.

Charge with the tank upside-down.



- 2 After the vacuum drying is finished, charge the additional refrigerant in its liquid state through the liquid shutoff valve service port. Taking into account following instructions:

- Check that gas and liquid shutoff valves are closed.
- Stop the compressor and charge the specified weight of refrigerant. (If the outside unit is not in operation and the total amount cannot be charged, follow the Additional refrigerant charge procedure (2) shown below.)

1 Installation of outdoor

1 - 8 Refrigerant piping

1 - 8 - 8 Additional refrigerant charge

NOTE

Procedures for charging additional refrigerant.

[Heat pump system]

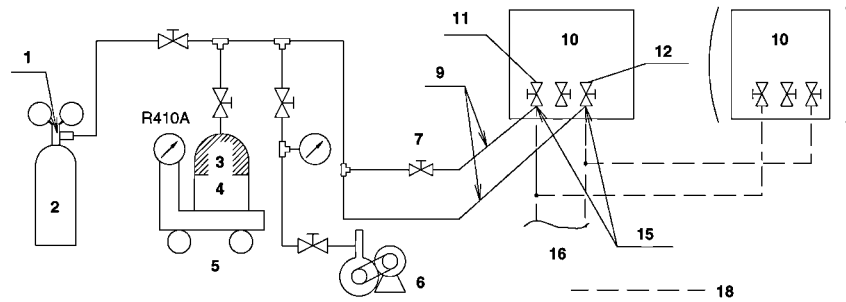

[Heat recovery system]

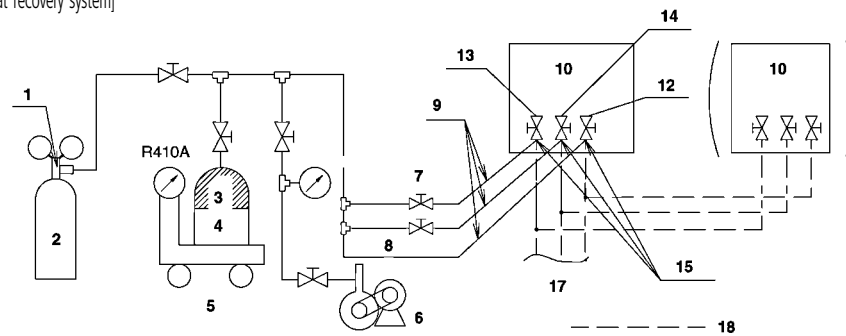

- ① Pressure reducing valve
- ② Nitrogen
- ③ Refrigerant tank
- ④ With a siphon
- ⑤ Measuring instrument
- ⑥ Vacuum pump
- ⑦ Valve A
- ⑧ Valve B
- ⑨ Charge hose
- ⑩ Outside unit
- ⑪ Gas side
- ⑫ Liquid side
- ⑬ Discharge gas side
- ⑭ Suction gas side
- ⑮ Shutoff valve service port
- ⑯ To indoor unit
- ⑰ To indoor units / BS units
- ⑱ Dotted lines represent onsite piping

1 Installation of outdoor

1 - 8 Refrigerant piping

1 - 8 - 8 Additional refrigerant charge

Additional refrigerant charge procedure (2)-by Additional refrigerant charge operation

About the system settings for additional refrigerant charge operation, refer to the [Service Precaution] label attached on the electric box cover in the outside unit.

- 1 Fully open all shutoff valves (valve A and valve B must be left fully closed).
- 2 After ten minutes, fully close liquid line shutoff valve and then, open the valve by turning 180°. Start the additional refrigerant charge operation. See [Service precautions] Label for detail.
If it is difficult to charge the refrigerant additionally, decrease the water temperature or warm the refrigerant tank. (Warm the refrigerant tank with a stupe or a warm hot water of 40 degrees or less.)
- 3 After the system is charged with a specified amount of refrigerant, press the RETURN button (BS3) on the PC board (A1P) in the outside unit to stop the additional refrigerant charge operation.
- 4 Immediately open both liquid-side and gas-side shutoff valve. (If do not open the shutoff valve immediately, liquid seal may cause the pipe to burst.)

NOTE

Procedures for charging additional refrigerant.
(Refer to figure above)

1 Installation of outdoor

1 - 8 Refrigerant piping

1 - 8 - 9 Shutoff valve operation procedure

CAUTION

Do not open the shutoff valve until 1-6 of “9-8 Checking of device and installation conditions” are completed. If the shutoff valve is left open without turning on power, it may cause refrigerant to buildup in the compressor, leading to insulation degradation.

Opening shutoff valve

- 1 Remove the cap and turn the valve counterclockwise with the hexagon wrench (JISB4648).
- 2 Turn it until the shaft stops.

Do not apply excessive force to the shutoff valve. Doing so may break the valve body, as the valve is not a backseat type. Always use the hexagon wrench.

- 3 Make sure to tighten the cap securely.

Closing shutoff valve

- 1 Remove the cap and turn the valve clockwise with the hexagon wrench (JISB4648).
- 2 Securely tighten the valve until the shaft contacts the main body seal.
- 3 Make sure to tighten the cap securely.

* For the tightening torque, refer to the table on the bellow.

Tightening torque

SHUTOFF VALVE SIZE	Tightening torque N-m (Turn clockwise to close)					Gas side accessory pipe (1)
	Shaft (valve body)		Cap (valve lid)	Service port	Flare nut	
Liquid side	5.4 - 6.6	Hexagonal wrench 4 mm	13.5 - 16.5	11.5 - 13.9	32.7 - 39.9	-
Gas side	27 - 33	Hexagonal wrench 10 mm	36 - 44	11.5 - 13.9	-	22 - 28

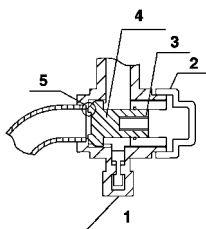

- ① Service port
- ② Cap
- ③ Hexagon hole
- ④ Shaft
- ⑤ The main body seal

1 Installation of outdoor

1 - 8 Refrigerant piping

1 - 8 - 9 Shutoff valve operation procedure

CAUTION

- 1 Do not damage the cap sealing.
- 2 Always use a charge hose for service port connection.
- 3 After tightening the cap, check that no refrigerant leaks are present.
- 4 After working, securely tighten the cover of service port without fail by specified torque.
- 5 When loosening a flare nut, always use two wrenches in combination. When connecting the piping, always use a spanner and torque wrench in combination to tighten the flare nut.
- 6 When connecting a flare nut, coat the flare (inner and outer faces) with ether oil or ester oil and hand-tighten the nut 3 to 4 turns as the initial tightening.
- 7 Do not forget to open the stop valve before starting operation.

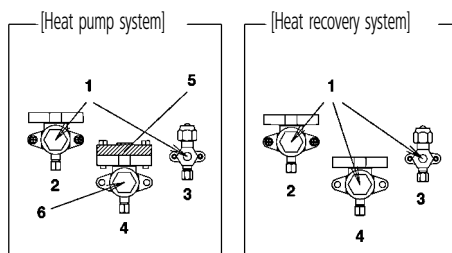

- ① Remove the cap and turn the valve counter clockwise with the hexagon wrenches until it stops.
- ② Discharge gas side
- ③ Liquid side
- ④ Suction gas side
- ⑤ Never remove the partition flange for any reason.
- ⑥ Full close on the suction gas side

1 - 9 Checks after installation

After the installation, check the following.

- 1 The shutoff valve
 - Make sure that the shutoff valve (both liquid and gas) is opened.
 - See the "Shutoff valve operation procedure" in chapter 10-9 and 10-10.
- 2 Additional refrigerant charge
 - The amount of refrigerant to be added to the unit should be written on the included "Added Refrigerant" plate and attached to the rear side of the front cover.
- 3 Installation date
 - Be sure to keep record of the installation date on the sticker on the EL. COMPO. BOX cover according to EN60335-2-40.

1 Installation of outdoor

1 - 10 Test run

CAUTION

After completing installation, be sure to open the shutoff valve.
(Operating the unit with the valve shut will break the compressor.)

1 - 10 - 1 Air discharge

- Running the heat source water pump, carry out air discharge process until the water comes out from the air discharge hole of local piping.
(For the operation to be done for the first time after installation, you need to perform a checking operation.)

1 - 10 - 2 Before turn on the power supply

- Close the EL. COMPO. BOX cover securely before turning on power.
- Make settings for outside unit PC board (A1P) after power-on and check the LED display from inspection door that is on the EL. COMPO. BOX cover.

1 - 10 - 3 Check operation

(For the operation to be done for the first time after installation, you need to perform a checking operation according to this guideline without fail. Otherwise, Abnormal Code "U3" appears and normal operation cannot be carried out.)

(1) Check the connection of interlock circuit	The outside unit cannot be operated if the interlock circuit has not been connected.
(2) As necessary, configure the system settings onsite by using the dip switch (DS1) and push button switches (BS1 to 5) on the outside unit PC board (A1P). After this, close the cover of electrical box.	Always perform configuration after turning ON the power. To learn the setting method, refer to the [Service Precautions] label attached at the cover of electrical box shown in the figure 27. Remember, the actual settings you have made must be recorded on the [Service Precautions] label.
(3) Turn ON the power to the outside units and indoor units.	Make sure to turn ON the power 6 hours before starting the operation. This is necessary to warm the crankcase by the electric heater.
(4) Start the heat source water pump and fill the heat source water in the outside unit.	The outside unit cannot be operated if the heat source water pump is not running.
(5) Make sure that the temperature of heat source water is kept within the operation range (10 - 45°C).	The outside unit cannot be operated at a temperature outside the operation range.
(6) Check the LED on the PC board (A1P) in the outside unit to see if the data transmission is performed normally.	

LED display (Default status before delivery)	Microcomputer operation monitor	Page	Ready/Error	Cooler/heater changeover			Low noise	Demand	Multi
	HAP	H1P	H2P	H3P	H4P	H5P	H6P	H7P	H8P
One outside unit installed	●	●	●	○	●	●	●	●	●
When multiple outside unit installed (*)	Master station	●	●	○	●	●	●	●	○
	Sub station 1	○	●	●	●	●	●	●	●
	Sub station 2	○	●	●	●	●	●	●	●

LED display: ● OFF ○ ON ● Blinking

(*) The master unit is the outside unit to which the transmission wiring for the indoor units is connected. The other outside units are sub units.

(7) • Using the push button switches (BS1 - 5) on the P-panel (A1P) of outside unit, carry out a local setting, if necessary. •In case of an installation of multiple outside units, carry out the setting on the master unit. (Setting on the slave unit becomes invalid.)	Always carry out the setting only after the power supply has been applied . For the method of setting, refer to the label of "Points to be noted when providing services" attached to the cover of electrical box (shown in the figure 27) of the outside unit. (After setting, record the details of that setting to the label of "Points to be noted when providing services" without fail.)
(8) Check all shutoff valve is opened. If some shutoff valve is closed, open them. (Refer to "9-10 Shutoff valve operation procedure".)	CAUTION Do not leave any shutoff valve closed. Otherwise the compressor will fail. For Heat recovery system of cooling and heating: Open all stop valves on the suction side, discharge gas side and liquid side. For cooling and heating switching operation system: Open the stop valves on discharge gas side and liquid side. (Keep the stop valve on suction side fully closed.)
(9) Perform the check operation following	If you push the test run button (BS4) on the P-panel (A1P) of the outside unit. for 5 seconds, the test run starts. If you want to interrupt the test run, push the RETURN button (BS3) on Ppanel (A1P) of the outside unit. The system continues residual operation for about 1 minute (maximum 10 minutes) and then stops. (During test run, you cannot stop it by a command from a remote controller.) Carry out above setting from a service window.

1 Installation of outdoor

1 - 10 Test run

1 - 10 - 3 Check operation

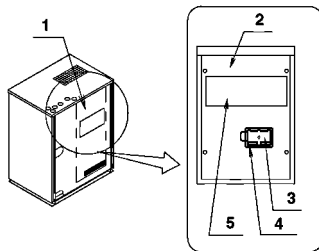

- ① Electrical box
- ② Cover of electrical box
- ③ Cover for servicing
- ④ Service window
- ⑤ Points to be noted when providing services

<Cautions for check operation>

- If operated within about 12 minutes after power supply has been applied to the indoor unit and outside unit, H2P will turn ON but the compressor does not start running. Before start operation, make sure that the LED display is correct referring to the table (6) of “11-3 Check operation”.
- The system may require up to 10 minutes until it can start the compressor after an operation start. This is a normal operation to equalize the refrigerant distribution.
- The check operation does not provide any means of checking the indoor units individually. For that purpose, perform normal operation using the remote controller after the check operation.
- Check operation is not possible in other modes such as collection mode.
- If the setting of indoor remote controller is changed before the check operation, it may not be performed correctly and malfunction code “UF” may be displayed.

Remote controller displays malfunction code

Malfunction code	Installation error	Remedial action
E3 E4 F3 F6 UF U2	The shutoff valve of an outside unit is left closed.	Open the shutoff valve.
U1	The phases of the power to the outside units are reversed.	Exchange two of the three phases (L1, L2, L3) to make a positive phase connection.
U1 U2 U4	No power is supplied to an outdoor or indoor unit (including phase interruption).	Check if the power wiring for the outside units are connected correctly. (If the power wire is not connected to L2 phase, no malfunction display will appear and the compressor will not work.)
UF	Incorrect transmission between units	Check if the refrigerant piping line and the unit transmission wiring are consistent with each other.
E3 F6 UF U2	Refrigerant overcharge	Recalculate the required amount of refrigerant from the piping length and correct the refrigerant charge level by recovering any excessive refrigerant with a refrigerant recovery machine.
E4 F3	Insufficient refrigerant	<ul style="list-style-type: none"> • Check if the additional refrigerant charge has been finished correctly. • Recalculate the required amount of refrigerant from the piping length and add an adequate amount of refrigerant.
U7 UF	If an outdoor multi terminal is connected when there is one outside unit installed	Remove the line from the outdoor multi terminals (Q1 and Q2).
UF E4	The operation mode on the remote controller was changed before the check operation.	Set the operation mode on all indoor unit remote controllers to “cooling.”
HJ	The heat source water is not circulating.	Make sure that the water pump is running.

2b

VRV-WII



In all of us,
a green heart

Daikin's unique position as a manufacturer of air conditioning equipment, compressors and refrigerants has led to its close involvement in environmental issues. For several years Daikin has had the intension to become a leader in the provision of products that have limited impact on the environment. This challenge demands the eco design and development of a wide range of products and an energy management system, resulting in energy conservation and a reduction of waste.



Daikin Europe N.V. is approved by LRQA for its Quality Management System in accordance with the ISO9001 standard. ISO9001 pertains to quality assurance regarding design, development, manufacturing as well as to services related to the product.



ISO14001 assures an effective environmental management system in order to help protect human health and the environment from the potential impact of our activities, products and services and to assist in maintaining and improving the quality of the environment.



Daikin units comply with the European regulations that guarantee the safety of the product.

VRV® products are not within the scope of the Eurovent certification programme.

The present publication is drawn up by way of information only and does not constitute an offer binding upon Daikin Europe N.V.. Daikin Europe N.V. has compiled the content of this publication to the best of its knowledge. No express or implied warranty is given for the completeness, accuracy, reliability or fitness for particular purpose of its content and the products and services presented therein. Specifications are subject to change without prior notice. Daikin Europe N.V. explicitly rejects any liability for any direct or indirect damage, In the broadest sense, arising from or related to the use and/or interpretation of this publication. All content is copyrighted by Daikin Europe N.V..

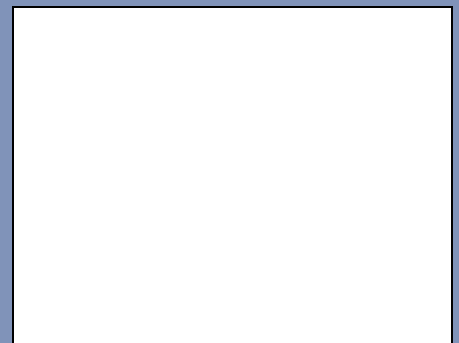

DAIKIN EUROPE N.V.

Naamloze Vennootschap
Zandvoordestraat 300
B-8400 Oostende, Belgium
www.daikin.eu
BTW: BE 0412 120 336
RPR Oostende



EEDEN08-201 • 01/2008 • Copyright © Daikin
The present publication supersedes EEDEN07-200
Prepared in Belgium by Lannoo (www.lannooprint.be), a company whose concern for
the environment is set in the EMAS and ISO 14001 systems.
Responsible Editor: Daikin Europe N.V., Zandvoordestraat 300, B- 8400 Oostende