

DAIKIN

INSTALLATION MANUAL

VRV[®] III System air conditioner

VRV[®] III-Q Series

MODELS

**RQYQ8PY1B
RQYQ10PY1B
RQYQ12PY1B
RQYQ14PY1B
RQYQ16PY1B
RQYQ18PY1B
RQYQ20PY1B
RQYQ22PY1B
RQYQ24PY1B
RQYQ26PY1B
RQYQ28PY1B
RQYQ30PY1B
RQYQ32PY1B
RQYQ34PY1B
RQYQ36PY1B
RQYQ38PY1B
RQYQ40PY1B
RQYQ42PY1B
RQYQ44PY1B
RQYQ46PY1B
RQYQ48PY1B**

English

Deutsch

Français

Español

Italiano

Ελληνικά

Nederlands

Portugues

Русский

Türkçe

[Q8 · 10 · 12 type]

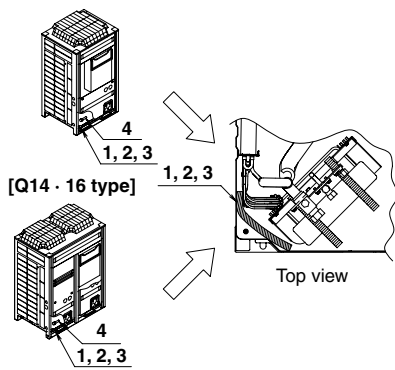

figure 1

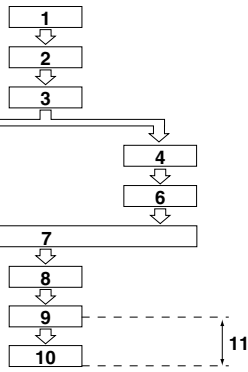

figure 2

< If installed as a single unit >

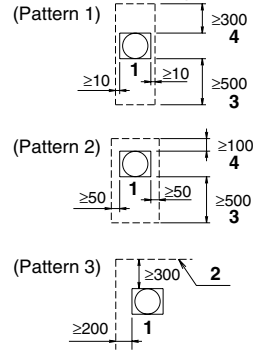

figure 3

< When installed in serial >

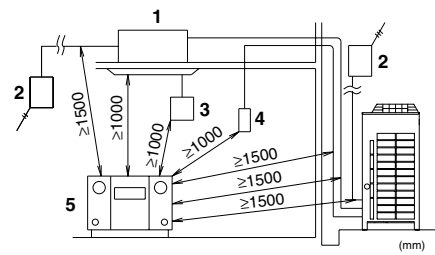
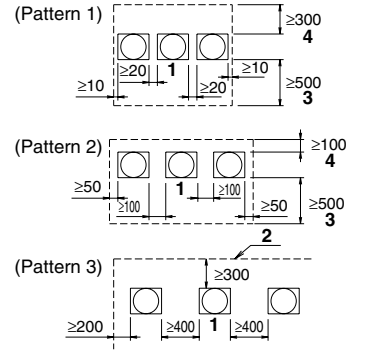

figure 4

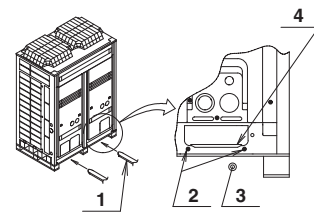

figure 5

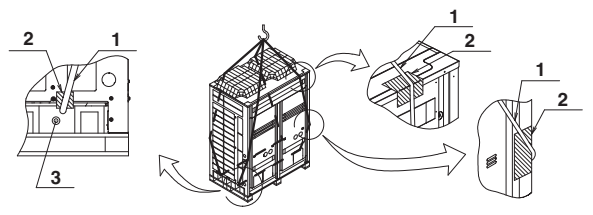

figure 6

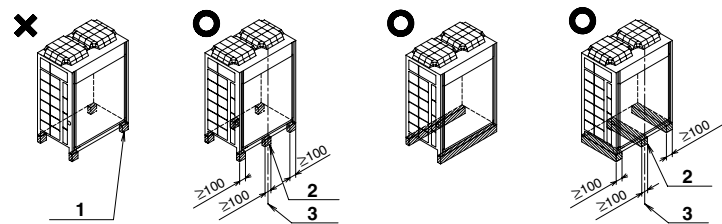

figure 7

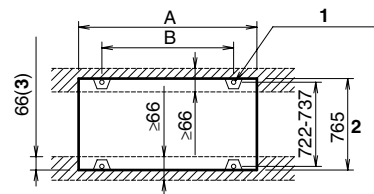

figure 8

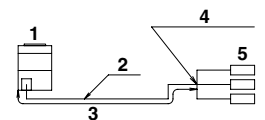

figure 9

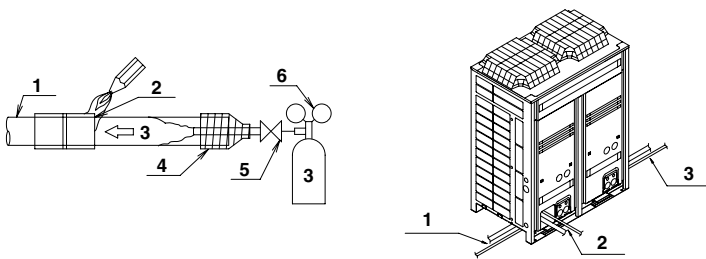

figure 10

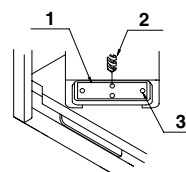

figure 12

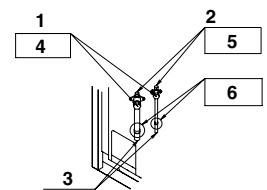

figure 13

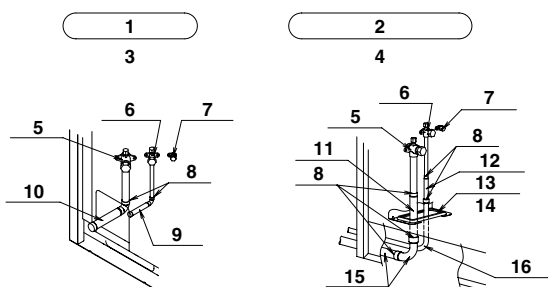

figure 14

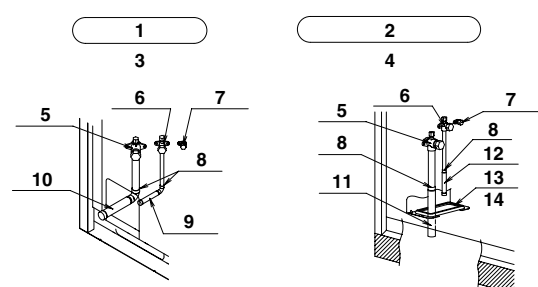

figure 15

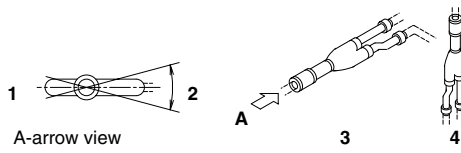

figure 16

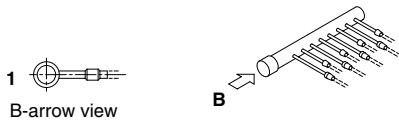

figure 17

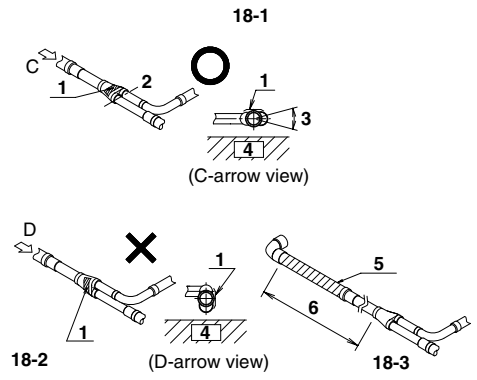

figure 18

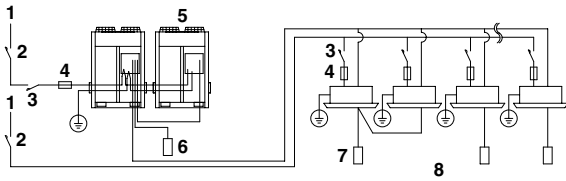

figure 19

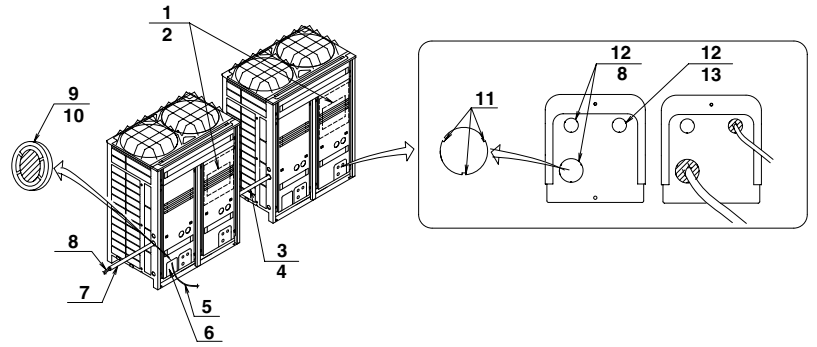

figure 20

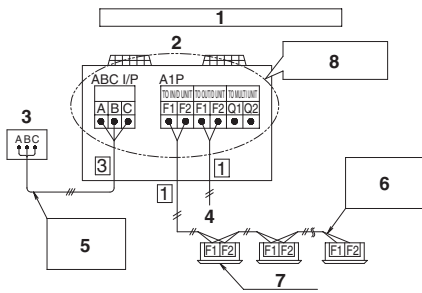

figure 21

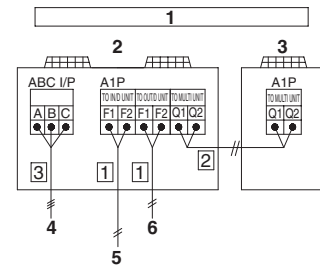

figure 22

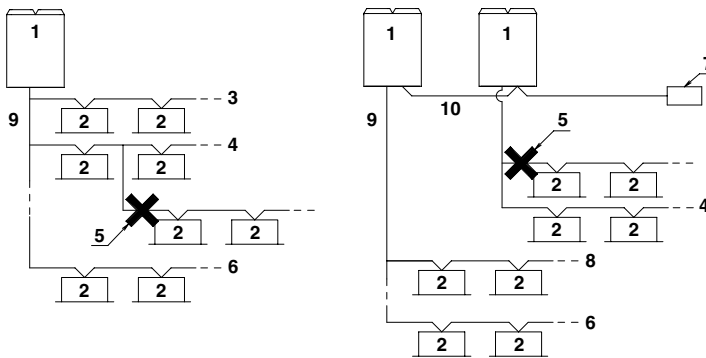

figure 23

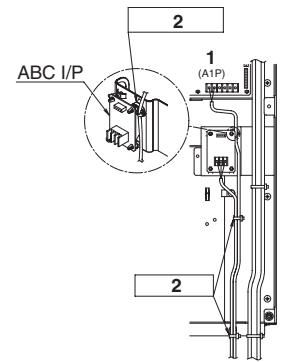

figure 24

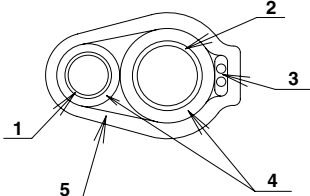

figure 25

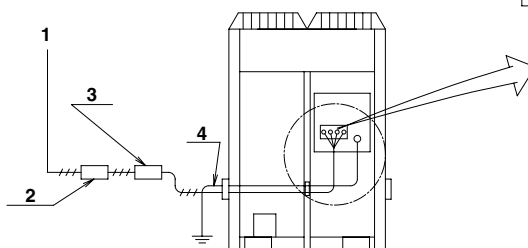
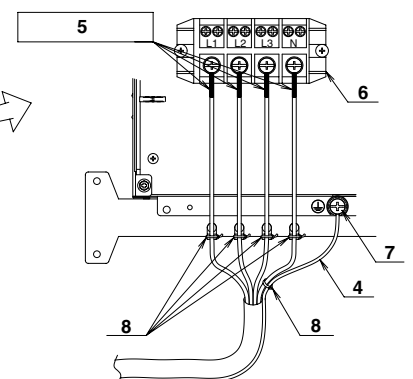

figure 26



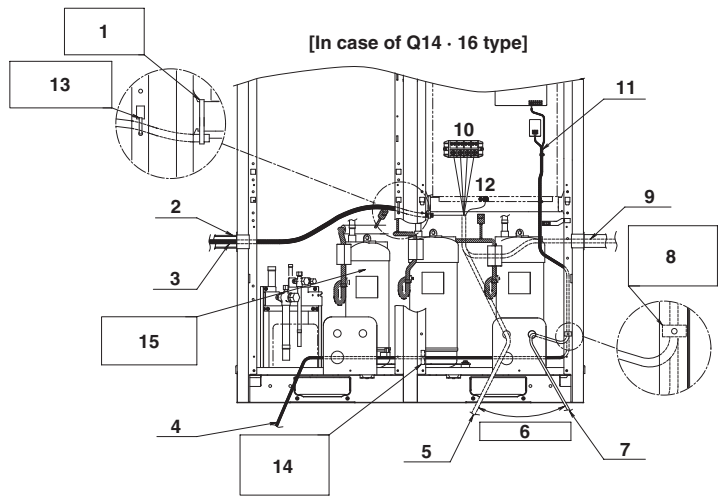
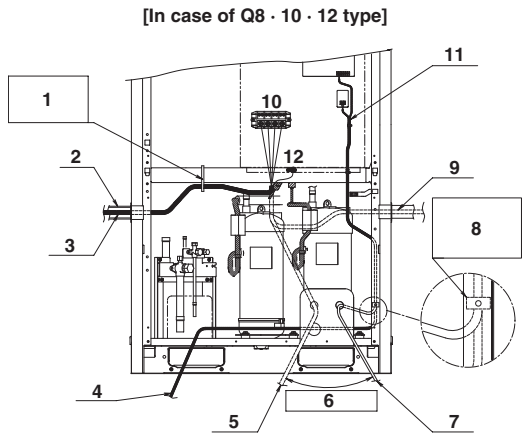

figure 27

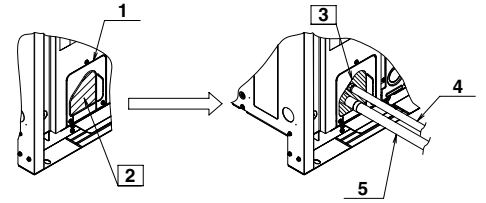
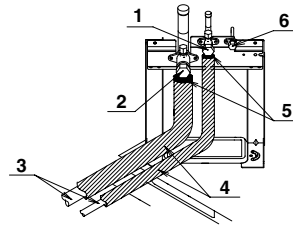
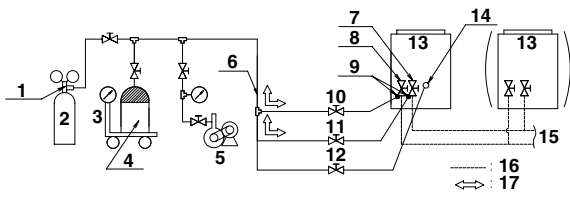

figure 28

figure 29

figure 30

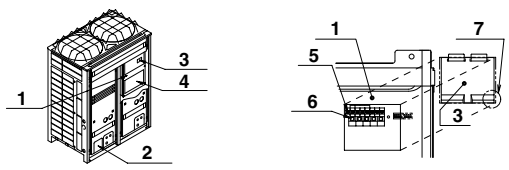
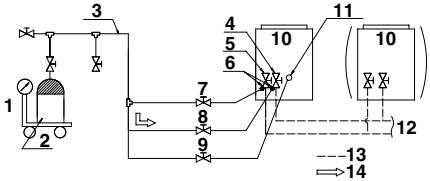

figure 31

figure 32

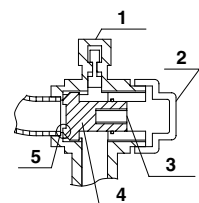
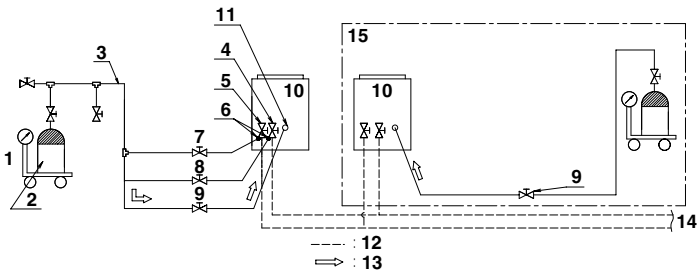

figure 33

figure 34

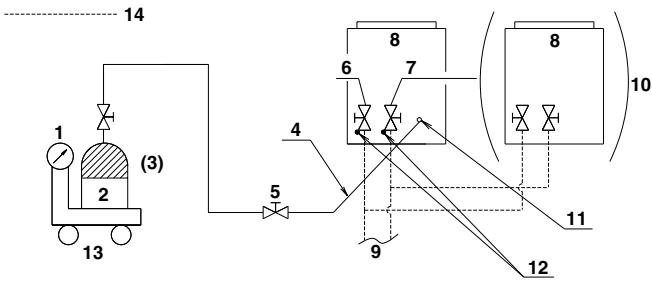

figure 35

RQYQ8PY1B	RQYQ18PY1B	RQYQ28PY1B	RQYQ38PY1B	RQYQ48PY1B
RQYQ10PY1B	RQYQ20PY1B	RQYQ30PY1B	RQYQ40PY1B	
RQYQ12PY1B	RQYQ22PY1B	RQYQ32PY1B	RQYQ42PY1B	
RQYQ14PY1B	RQYQ24PY1B	RQYQ34PY1B	RQYQ44PY1B	
RQYQ16PY1B	RQYQ26PY1B	RQYQ36PY1B	RQYQ46PY1B	

CONTENTS

1. FIRST OF ALL	1
1-1 Safety precautions	1
1-2 Special notice of product	2
1-3 Disposal requirements	2
2. INTRODUCTION.....	2
2-1 Combination.....	2
2-2 Standard supplied accessories.....	3
2-3 Option accessory	3
2-4 Technical and Electrical specifications	3
2-5 Main components	3
2-6 Installation Process.....	3
3. SELECTION OF LOCATION	4
4. INSPECTING AND HANDLING THE UNIT	4
5. PLACING THE UNIT.....	4
6. REFRIGERANT PIPING	5
6-1 Selection of piping material and Refrigerant branching kit	5
6-2 Protection against contamination when installing pipes	5
6-3 Pipe connection	5
6-4 Connecting the refrigerant piping.....	5
6-5 Example of connection	8
7. FIELD WIRING	10
7-1 Power circuit, safety device, and cable requirements	10
7-2 Wiring Connection Example for Whole System	10
7-3 Leading wire Procedure.....	10
7-4 Transmission Wiring Connection Procedure	11
7-5 Power Wiring Connection Procedure.....	11
7-6 Procedure for Wiring Inside Units	12
8. AIR TIGHT TEST AND VACUUM DRYING	12
8-1 Preparations	12
8-2 Air tight test and vacuum drying method	12
9. PIPE INSULATION	13
10. CHECKING OF DEVICE AND INSTALLATION CONDITIONS	13
11. ADDITIONAL REFRIGERANT CHARGE AND CHECK OPERATION	13
11-1 Before working.....	13
11-2 Procedure of Adding Refrigerant charging and check operation.....	15
12. ONSITE SETTINGS.....	20
12-1 Onsite Settings With the Power Off	20
12-2 Onsite Settings With the Power On	20
13. TEST RUN	20
13-1 Before test run	20
13-2 Test Run	20
13-3 Checks After Test Run.....	20
14. CAUTION FOR REFRIGERANT LEAKS	20

1. FIRST OF ALL

- This document is an installation manual for the Daikin “VRVIII-Q” Series VRV Inverter. Before installing the unit, read this manual thoroughly, and following the instructions contained in it. After installation, do a test run to make sure the unit runs properly, and then explain how to operate and take care of the unit to the customer, using the operation manual.
- Lastly, make sure the customer keeps this manual, along with the operation manual, in a safe place.
- This manual does not describe how to install the indoor unit. Refer to the installation manual included with the indoor unit for that.

1-1 Safety precautions

Please read these “Safety precautions” carefully before installing air conditioning unit and be sure to install it correctly. After completing installation, conduct a trial operation to check for faults and explain to the customer how to operate the air conditioner and take care of it with the aid of the operation manual. Ask the customer to store the installation manual along with the operation manual for future reference.

This air conditioner comes under the term “appliances not accessible to the general public”.

Meaning of WARNING and CAUTION notices



WARNING..... Failure to follow these instructions properly may result in personal injury or loss of life.



CAUTION..... Failure to observe these instructions properly may result in property damage or personal injury, which may be serious depending on the circumstances.



WARNING

- Ask your dealer or qualified personnel to carry out installation work. Do not attempt to install the air conditioner yourself. Improper installation may result in water leakage, electric shocks or fire.
- Install the air conditioner in accordance with the instructions in this installation manual. Improper installation may result in water leakage, electric shocks or fire.
- When installing the unit in a small room, take measures against to keep refrigerant concentration from exceeding allowable safety limits in the event of refrigerant leakage. Contact the place of purchase for more information. Excessive refrigerant in a closed ambient can lead to oxygen deficiency.
- Be sure to use only the specified accessories and parts for installation work. Failure to use the specified parts may result in the unit falling, water leakage, electric shocks or fire.
- Install the air conditioner on a foundation strong enough to withstand the weight of the unit. A foundation of insufficient strength may result in the equipment falling and causing injury.
- Carry out the specified installation work after taking into account strong winds, typhoons or earthquakes. Failure to do so during installation work may result in the unit falling and causing accidents.
- Make sure that a separate power supply circuit is provided for this unit and that all electrical work is carried out by qualified personnel according to local laws and regulations and this installation manual. An insufficient power supply capacity or improper electrical construction may lead to electric shocks or fire.
- Make sure that all wiring is secured, the specified wires are used, and that there is no strain on the terminal connections or wires. Improper connections or securing of wires may result in abnormal heat build-up or fire.
- When wiring the power supply and connecting the remote controller wiring and transmission wiring, position the wires so that the EL.COMPO.BOX lid can be securely fastened. Improper positioning of the EL.COMPO.BOX lid may result in electric shocks, fire or the terminals overheating.
- If refrigerant gas leaks during installation, ventilate the area immediately. Toxic gas may be produced if the refrigerant comes into contact with fire.
- After completing installation, check for refrigerant gas leakage. Toxic gas may be produced if the refrigerant gas leaks into the room and comes into contact with a source of fire, such as a fan heater, stove or cooker.
- Do not directly touch refrigerant that has leaked from refrigerant pipes or other areas, as there is a danger of frostbite.
- Be sure to switch off the unit before touching any electrical parts.
- Do not allow children to climb on the outdoor unit and avoid placing objects on the unit. Injury may result if the unit becomes loose and falls.
- Be sure to earth the air conditioner. Do not earth the unit to a utility pipe, lightning conductor or telephone earth lead. Imperfect earthing may result in electric shocks or fire. 
- A high surge current from lightning or other sources may cause damage to the air conditioner.
- Be sure to install an earth leakage breaker. Failure to install an earth leakage breaker may result in electric shocks or fire.



CAUTION

- While following the instructions in this installation manual, install drain piping to ensure proper drainage and insulate piping to prevent condensation. Improper drain piping may result in indoor water leakage and property damage.

- Install the indoor and outdoor units, power cord and connecting wires at least 1 meter away from televisions or radios to prevent picture interference and noise.
(Depending on the incoming signal strength, a distance of 1 meter may not be sufficient to eliminate noise.)
- Remote controller (wireless kit) transmitting distance can be shorter than expected in rooms with electronic fluorescent lamps (inverter or rapid start types).
Install the indoor unit as far away from fluorescent lamps as possible.
- Make sure to provide for adequate measures in order to prevent that the outdoor unit be used as a shelter by small animals.
Small animals making contact with electrical parts can cause malfunctions, smoke or fire.
Please instruct the customer to keep the area around the unit clean.
- Do not install the air conditioner in the following locations:
 1. Where there is a high concentration of mineral oil spray or vapour (e.g. a kitchen).
Plastic parts will deteriorate, parts may fall off and water leakage could result.
 2. Where corrosive gas, such as sulphurous acid gas, is produced.
Corroding of copper pipes or soldered parts may result in refrigerant leakage.
 3. Near machinery emitting electromagnetic radiation.
Electromagnetic radiation may disturb the operation of the control system and result in a malfunction of the unit.
 4. Where flammable gas may leak, where there is carbon fibre or ignitable dust suspensions in the air, or where volatile flammables such as paint thinner or gasoline are handled.
Operating the unit in such conditions may result in fire.

1-2 Special notice of product

[CLASSIFICATION]

This air conditioner comes under the term "appliances not accessible to the general public".

[REFRIGERANT]

VRVIII System use R410A refrigerant.

- The refrigerant R410A requires that strict precautions be observed for keeping the system clean, dry and tightly sealed.
Read the chapter "REFRIGERANT PIPING" carefully and follow these procedures correctly.
 - A. Clean and dry
Strict measures must be taken to keep impurities (including SUNISO oil and other mineral oils as well as moisture) out of the system.
 - B. Tightly sealed
R410A contains no chlorine, does not destroy the ozone layer and so does not reduce the earth's protection against harmful ultraviolet radiation. R410A will contribute only slightly to the greenhouse effect if released into the atmosphere. Therefore, sealing tightness is particularly important in installation. Carefully read the chapter "REFRIGERANT PIPING" and strictly observe the correct procedures.
- Since design pressure is 4.0 MPa or 40 bar (for R407C units: 3.3 MPa or 33 bar), the thickness of pipes must be greater than previously. Since R410A is a mixed refrigerant, the required additional refrigerant must be charged in its liquid state. (If the system is charged with refrigerant in its gaseous state, due to composition change, the system will not function normally). The indoor unit is designed for R410A use. See the catalogue for indoor unit models that can be connected. (Normal operation is not possible when connecting units that are originally designed for other refrigerants.)

Total maximum refrigerant charge limits

The total maximum refrigerant charge of a VRVIII system must be below 100kg, this to be in accordance with CE requirement (EN60335-2-40 standard).

This means that in case the total maximum refrigerant charge of the system (factory and additional charge) is equal to or more than 100kg you must divide your multiple outdoor system into smaller independent systems, each containing less than 100kg refrigerant charge.

For factory charge, refer to the unit name plate.

Important information regarding the refrigerant used

This product contains fluorinated greenhouse gases covered by the Kyoto Protocol. Do not vent gases into the atmosphere.

Refrigerant type : R410A

GWP⁽¹⁾ value : 1975

⁽¹⁾ GWP = global warming potential

Please fill in with indelible ink,

- ① the factory refrigerant charge of the product,
 - ② the additional refrigerant amount charged onsite and
 - ① + ② the total refrigerant charge on the refrigerant charge label supplied with the product.
- The filled out label must be adhered in the proximity of the product charging port (e.g. onto the inside of the service cover).

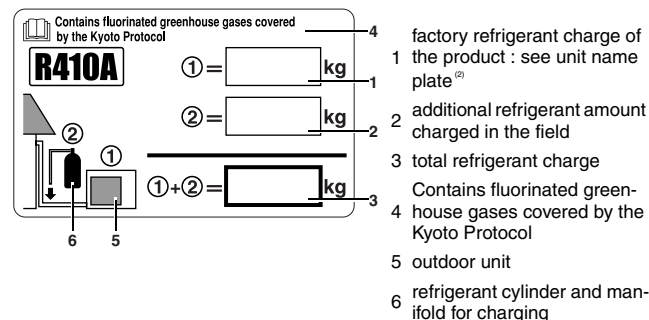

(2) In case of multiple outdoor systems, only 1 label must be adhered, mentioning the total factory refrigerant charge of all outdoor units connected on the refrigerant system.

[DESIGN PRESSURE]

Since design pressure is 4.0MPa or 40bar, the wall thickness of pipes should be more carefully selected in accordance with the relevant local and national regulations.

1-3 Disposal requirements

Dismantling of the unit, treatment of the refrigerant, of oil and of other parts must be done in accordance with relevant local and national legislation.

2. INTRODUCTION

- "VRVIII-Q" series are designed for outdoor installation and used for cooling and heatpump applications. Outdoor units come in three standard sizes, and with a single system through a multi system combining up to two outdoor units, rated cooling capacity from 22.4 kW to 118 kW and rated heating capacity from 25.0 kW to 132 kW can be achieved.
- The "VRV" units can be combined with Daikin VRV series indoor units for air conditioning purposes. Always use appropriate indoor units compatible with R410A. To lean which models of indoor units are compatible with R410A, refer to the product catalogs.
To combine with other refrigerant indoor unit will cause malfunction.

2-1 Combination

The indoor units can be installed in the following range.

〈Outdoor unit〉	〈Total capacity of indoor units〉	〈Total quantity of indoor units〉
RQYQ8PY1B	100 ~ 260	13 units
RQYQ10PY1B	125 ~ 325	16 units
RQYQ12PY1B	150 ~ 390	19 units
RQYQ14PY1B	175 ~ 455	22 units
RQYQ16PY1B	200 ~ 520	26 units
RQYQ18PY1B	225 ~ 585	29 units
RQYQ20PY1B	250 ~ 650	32 units
RQYQ22PY1B	275 ~ 715	35 units
RQYQ24PY1B	300 ~ 780	39 units
RQYQ26PY1B	325 ~ 845	42 units
RQYQ28PY1B	350 ~ 910	45 units
RQYQ30PY1B	375 ~ 975	48 units
RQYQ32PY1B	400 ~ 1040	52 units
RQYQ34PY1B	425 ~ 1105	55 units
RQYQ36PY1B	450 ~ 1170	58 units
RQYQ38PY1B	475 ~ 1235	61 units
RQYQ40PY1B	500 ~ 1300	64 units
RQYQ42PY1B	525 ~ 1365	64 units
RQYQ44PY1B	550 ~ 1430	64 units
RQYQ46PY1B	575 ~ 1495	64 units
RQYQ48PY1B	600 ~ 1560	64 units

Note

- Be sure to connect an R410A indoor unit.
See the catalog for indoor unit models which can be connected.
- At above is the total capacity and total number of units of the indoor units when configured in a standard combination. See the technical reference for details on total capacity and total number of indoor units when using a configuration other than the standard combination. The standard combination are as follows.

<Combination unit>	<Independent unit>
RQYQ8PY1B	RQYQ8PY1B
RQYQ10PY1B	RQYQ10PY1B
RQYQ12PY1B	RQYQ12PY1B
RQYQ14PY1B	RQYQ14PY1B
RQYQ16PY1B	RQYQ16PY1B
RQYQ18PY1B	RQYQ8PY1B+ RQYQ10PY1B
RQYQ20PY1B	RQYQ8PY1B+ RQYQ12PY1B
RQYQ22PY1B	RQYQ10PY1B+ RQYQ12PY1B
RQYQ24PY1B	RQYQ12PY1B+ RQYQ12PY1B
RQYQ26PY1B	RQYQ10PY1B+ RQYQ16PY1B
RQYQ28PY1B	RQYQ12PY1B+ RQYQ16PY1B
RQYQ30PY1B	RQYQ14PY1B+ RQYQ16PY1B
RQYQ32PY1B	RQYQ16PY1B+ RQYQ16PY1B
RQYQ34PY1B	RQYQ10PY1B+ RQYQ10PY1B+ RQYQ14PY1B
RQYQ36PY1B	RQYQ10PY1B+ RQYQ10PY1B+ RQYQ16PY1B
RQYQ38PY1B	RQYQ10PY1B+ RQYQ12PY1B+ RQYQ16PY1B
RQYQ40PY1B	RQYQ12PY1B+ RQYQ12PY1B+ RQYQ16PY1B
RQYQ42PY1B	RQYQ10PY1B+ RQYQ16PY1B+ RQYQ16PY1B
RQYQ44PY1B	RQYQ12PY1B+ RQYQ16PY1B+ RQYQ16PY1B
RQYQ46PY1B	RQYQ14PY1B+ RQYQ16PY1B+ RQYQ16PY1B
RQYQ48PY1B	RQYQ16PY1B+ RQYQ16PY1B+ RQYQ16PY1B

- If the total capacity of the connected indoor units exceeds the capacity of the outdoor unit, cooling and heating performance may drop when running the indoor units. See the capacity table in the Engineering Data Book for details.
- There are restrictions on the refrigerant pipe connecting order between outdoor unit in the case of the multi system. Install so that the following restrictions are satisfied.

<Restrictions>



The capacities of outdoor units A,B and C must fulfill the following conditions.

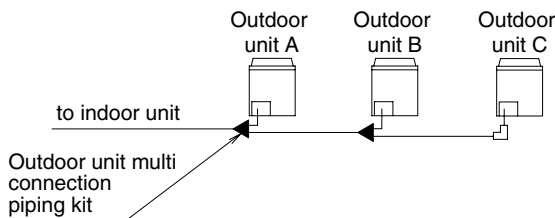

A ≥ B ≥ C



2-2 Standard supplied accessories

The following accessories are included. The storage location of the accessories is shown in figure 1.

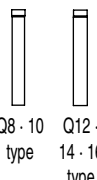
Q8~16 type			
Name	Clamp (1)	Clamp (2)	Clamp (3)
Quantity	9 pcs.	2 pcs.	1 pc.
Shape	 Small		 Large

Q8~16 type			
Name	Gas side accessory pipe (1)	Gas side accessory pipe (2)	Liquid side accessory pipe (1)
Quantity	1 pc.	1 pc.	1 pc.
Shape		 Q8 · 10 type Q12 · 14 · 16 type	

Q8~16 type		
Name	Liquid side accessory pipe (2)	Others
Quantity	1 pc.	1 pc. each item
Shape	 Q8 · 10 · 14 · 16 type	<ul style="list-style-type: none"> • Operation manual • Installation manual • Check list of installed system • Declaration conformity (PED, EMC, MD) • "REQUEST FOR THE INDICATION" label (Installation records) • "ADDITIONAL REF. CHARGE" label

(Refer to figure 1)

1. Operation manual
2. Installation manual
3. Clamps
4. Accessory pipes

Note

Do not throw away any of the accessories until installation is complete.

2-3 Option accessory

To install the outdoor units, the following optional parts are also required. To select an optimum kit, refer to "6-5 Example of connection".

- Refrigerant branching kit

REFNET header	KHRP26M22H	KHRP26M33H	KHRP26M72H	KHRP26M73H
REFNET joint	KHRP26A22T	KHRP26A33T	KHRP26A72T	KHRP26A73T

- Outdoor unit multi connection piping kit

Number of outdoor units connected	2 units	3 units
Kit name	BHFP22P100	BHFP22P151

- Pipe size reducer

Kit name	KHRP26M73TP	KHRP26M73HP
----------	-------------	-------------

Note

Make sure that any separately purchased accessories are designed for use with R410A.

2-4 Technical and Electrical specifications

Refer to the Engineering Data Book for the complete list of specifications.

2-5 Main components

For main components and function of the main components, refer to the Engineering Data Book.

2-6 Installation Process

Figure 2 shows the installation process. Install in the order of the steps shown.

(Refer to figure 2)

1. "3. SELECTION OF LOCATION"
2. "4. INSPECTING AND HANDLING THE UNIT"
3. "5. PLACING THE UNIT"
4. "6. REFRIGERANT PIPING"
5. "7. FIELD WIRING"
6. "8. AIR TIGHT TEST AND VACUUM DRYING"
7. "9. PIPE INSULATION"
8. "10. CHECKING OF DEVICE AND INSTALLATION CONDITIONS"
9. "11. ADDITIONAL REFRIGERANT CHARGE AND CHECK OPERATION"
10. "13. TEST RUN"
11. Operations which require the power to be turned on.

3. SELECTION OF LOCATION

Select a location for installation that meets the following conditions. Get the customer's permission.

1. There is no danger of fire due to leakage of inflammable gas.
2. Select the location of the unit in such a way that neither the discharged air nor the sound generated by the unit disturb anyone.
3. The foundation is strong enough to support the weight of the unit and the floor is flat to prevent vibration and noise generation.
4. The piping length between the outdoor unit and the indoor unit may not exceed the allowable piping length. (Refer to "6. REFRIGERANT PIPING")
5. Locations where the unit's suction vent and outlet vent do not generally face the wind.
Wind blowing directly into the suction or outlet vents will interfere with the unit's operation.
If necessary, install some kind of obstruction to block the wind.
6. The space around the unit is adequate for servicing and the minimum space for air inlet and air outlet is available. (See the "Installation Space Examples" for the minimum space requirements.)

Installation Space Examples

- The installation space requirement shown in figure 3 is a reference for cooling operation when the outdoor temperature is 35°C. If the design outdoor temperature exceeds 35°C or the heat load exceeds maximum capacity in all the outdoor unit, take an even large space on the intake shown in figure 3.
- During installation, install the units using the most appropriate of the patterns shown in figure 3 for the location in question, taking into consideration human traffic and wind.
- If the number of units installed is more than that shown in the pattern in figure 3, install the units so there are no short circuits.
- As regards space in front of the unit, consider the space needed for the local refrigerant piping when installing the units.
- If the work conditions in figure 3 do not apply, contact your dealer or Daikin directly.

(Refer to figure 3)

1. Front side
2. No limit to wall height
3. Service space of front side
4. Service space of suction side

For Patterns 1 and 2 in figure 3:

- Wall height for front side – no higher than 1500 mm.
- Wall height on the suction side – no higher than 500 mm.
- Wall height for sides – no limit.
- If the height is exceeded the above, calculate h1 and h2 shown in the figure below, and add h1/2 to the service space of front side and h2/2 to the service space of suction side.

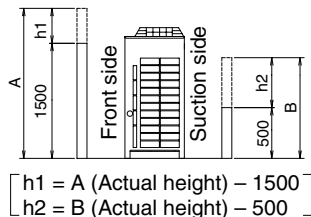

Note

1. An inverter air conditioner may cause electronic noise generated from AM broadcasting. Examine where to install the main air conditioner and electric wires, keeping proper distances away from stereo equipment, personal computers, etc. Particularly for locations with weak reception, ensure there is a distance of at least 3 meters for indoor remote controllers, place power wiring and transmission wiring in conduits, and ground the conduits.

(Refer to figure 4)

1. Indoor unit
 2. Branch switch, overcurrent breaker
 3. Remote controller
 4. COOL/HEAT selector
 5. Personal computer or radio
2. When installing in a locations where there is heavy snowfall, implement the following snow measures.
 - Ensure the base is high enough that intakes are not clogged by snow.
 - Remove the rear intake grille to prevent snow from accumulating on the fins.

3. If condensate may drip on downstairs (or walkway) depending on the floor condition, take a measure such as the installation of central drain pan kit (sold separately).
4. The refrigerant R410A itself is nontoxic, nonflammable and is safe. If the refrigerant should leak however, its concentration may exceed the allowable limit depending on room size. Due to this it could be necessary to take measures against leakage. See "14. CAUTION FOR REFRIGERANT LEAKS" for details.

4. INSPECTING AND HANDLING THE UNIT

- At delivery, the package should be checked and any damage should be reported immediately to the carrier claims agent.
 - When handling the unit, take into account the following:
 1. Fragile, handle the unit with care.
 2. Keep the unit upright in order to avoid compressor damage.
 - 2. Decide on the transportation route.
 - 3. If a forklift is to be used, insert forks into the opening of the skid under the unit. (Refer to figure 5)
 - 4. If hanging the unit, use a cloth sling to prevent damaging the unit. Keeping the following points in mind, hang the unit following the procedure shown in figure 6.
 - Use a sling sufficiently strong to hold the mass of the unit.
 - Use 2 belts of at least 8m long.
 - Place extra cloth or boards in the locations where the casing comes in contact with the sling to prevent damage.
 - Hoist the unit making sure it is being lifted at its center of gravity.
 - 5. After installation, remove the transportation clasp attached to the large openings. (Refer to figure 6)
 1. Forklift
 2. Hook
 3. Skid opening
 4. Transport protector (Yellow)
- (Refer to figure 6)
1. Belt sling
 2. Rag
 3. Skid opening

Note

Apply a filler cloth on a fork to prevent coating of the bottom frame from coming off and rust from occurring when bringing in the unit with anti-corrosion treatment type using a forklift.

5. PLACING THE UNIT

- Make sure the unit is installed level on a sufficiently strong base to prevent vibration and noise. (Refer to figure 7)
- The base should be bigger around than the width of the unit's legs (66 mm), and should support the unit. (Refer to figure 8)
- If protective rubber is to be attached, attach it to the whole face of the base.
- The height of the base should be at least 150mm from the floor.
- Secure the unit to its base using foundation bolts. (Use four commercially available M12-type foundation bolts, nuts, and washers.)
- The foundation bolts should be inserted 20 mm.

(Refer to figure 7)

1. Unit can not be supported with the independent footing in four corners only.
- 2, 3. Make sure to install on the base that faces four corners and centers of the unit.

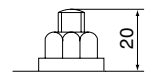

(Refer to figure 8)

1. Foundation bolt point (φ15 dia. : 4 positions)
2. Depth of product
3. Width of support leg

Model	A	B
Q8 · 10 · 12 type	930	792
Q14 · 16 type	1240	1102

Note

- There are restrictions on the refrigerant pipe connecting order between outdoor unit in the case of the multi system. See the Note in "2-1 Combination" for detail.
- When installing on a roof, make sure the roof floor is strong enough and be sure to water-proof all work.
- Make sure the area around the machine drains properly by setting up drainage grooves around the foundation. Drain water is sometimes discharged from the outdoor unit when it is running.

- For anti-corrosion type use nuts with resin washers. If the paint on nut connections comes off, the anti-corrosion effect may decrease.

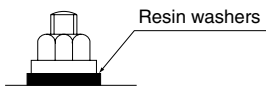

6. REFRIGERANT PIPING

Note

- All field piping must be installed by a licensed refrigeration technician and must comply with relevant local and national regulations.
- After piping work is complete, do not under any circumstances open the shutoff valve until "7. FIELD WIRING" and "10. CHECKING OF DEVICE AND INSTALLATION CONDITIONS" are complete.
- Do not use flux when brazing the refrigerant piping. Use the phosphor copper brazing filler metal (BCuP-2: JIS Z 3264/B-Cu93P-710/795: ISO 3677) which does not require flux. (Flux has extremely harmful influence on refrigerant piping systems. For instance, if the chlorine based flux is used, it will cause pipe corrosion or, in particular, if the flux contains fluorine, it will damage the refrigerant oil.)

6-1 Selection of piping material and Refrigerant branching kit

- Use only pipes which are clean inside and outside and which do not accumulate harmful sulfur, oxidants, dirt, cutting oils, moisture, or other contamination. (Foreign materials inside pipes including oils for fabrication must be 30mg/10m or less.)
- Use the following items for the refrigerant piping.

Material: Jointless phosphor-deoxidized copper pipe
Size: See "6-5 Example of connection" to determine the correct size.

Thickness: Select a thickness for the refrigerant piping which complies with national and local laws.

Refrigerant pipe (Gas pipe and Liquid pipe) and refrigerant branch must meet the condition of design pressure 3.3MPa. If it is not possible to confirm, use the refrigerant branch kit selected with "6-5 Example of connection".

Existing pipes must meet the condition of design pressure 3.3MPa.

Specifically, to confirm that there are no corrosion and the pipe thickness must not be less than the smallest thickness below. Temper grade (O type, 1/2H type) in the table indicate the material types specified in JIS H 3300.

(unit: mm)

Temper grade	O type			
outer diameter	φ6.4	φ9.5	φ12.7	φ15.9
smallest thickness	0.4*	0.5*	0.7*	0.9*

* In case of bending 3xD or more (D: O.D. of refrigerant pipe)

(unit: mm)

Temper grade	1/2H type							
outer diameter	φ19.1	φ22.2	φ25.4	φ28.6	φ31.8	φ34.9	φ38.1	φ41.3
smallest thickness	0.6	0.6	0.7	0.8	0.9	1.0	1.1	1.1

- For piping work, follow the maximum tolerated length, difference in height, and length after a branch indicated in the "6-5 Example of connection".
- A refrigerant branching kit (sold separately) is needed for piping branches and connection of piping between outdoor unit (in case of multi system).

Use only separately sold items selected specifically according to the refrigerant branch kit selection in the "6-5 Example of connection".

6-2 Protection against contamination when installing pipes

Protect the piping to prevent moisture, dirt, dust, etc. from entering the piping.

Place	Installation period	Protection method
Outdoor	More than a month	Pinch the pipe
	Less than a month	Pinch or tape the pipe
Indoor	Regardless of the period	

Note

Exercise special caution to prevent dirt or dust when passing piping through holes in walls and when passing pipe edges to the exterior.

6-3 Pipe connection

- Be sure to perform nitrogen permutation or nitrogen blow when brazing. (Refer to figure 10)
 Brazing without performing nitrogen permutation or nitrogen blow into the piping will create large quantities of oxidized film on the inside of the pipes, adversely affecting valves and compressors in the refrigerating system and preventing normal operation. (Refer to figure 10)
 - Refrigerant pipe
 - Location to be brazed
 - Nitrogen
 - Taping
 - Handy valve
 - Regulator
- The pressure regulator for the nitrogen released when doing the brazing should be set to 0.02 MPa (about 0.2kg/cm²). Enough to feel a slight breeze on your cheek).

Note

Do not use anti-oxidants when brazing the pipe joints. Residue can clog pipes and break equipment.

6-4 Connecting the refrigerant piping

- Direction to bring out the pipes
 The local interunit piping can be connected either forward or to the sides (taken out through the bottom) as shown in the figure 11. (When passing out through the bottom, use the knock hole in the bottom frame.)

(Refer to figure 11)

- Left-side connection
- Front connection
- Right-side connection

Precautions when knocking out knock holes

- Open knock hole in the base frame by drilling the 4 concave around it with a 6mm bit. (Refer to figure 12)
 (Refer to figure 12)
 - Knock hole
 - Drill
 - Concave section
 - Be sure to avoid damaging the casing
 - After knocking out the holes, we recommend you remove any burrs and paint them using the repair paint to prevent rusting.
 - When passing electrical wiring through the knock holes, protect the wiring with a conduit or bushings, making sure not to damage the wiring.
- Removing Pinch Piping
 - When connecting refrigerant piping to an outdoor unit, remove the pinch piping. (Refer to figure 13)
 - Pinch piping should be removed using the procedure in the figure 13.

(Refer to figure 13)

- Shutoff valve (liquid side · gas side)
- Service port
- Pinch piping
- Procedure 1:
Confirm the shutoff valve is closed.
- Procedure 2:
Connect a charge hose to the service port of the liquid side and gas side shutoff valves and remove the gas from the pinch piping.
- Procedure 3:
After removing the gas from the pinch piping, dissolve the brazing using a burner and remove the pinch piping.



CAUTION

After removing the gas, remove the pinch piping. Any gas remaining inside may blow off the pinch piping when you dissolve the brazing, causing damage.

- Connecting refrigerant piping to outdoor units

<In case of single system: Q8-16 type>

(Refer to figure 14)

- If connected to the front
- When connected at lateral side (bottom)
- Remove the shutoff valve cover to connect.

4. Remove the knock hole on the bottom frame and route the piping under the bottom frame.
5. Gas side shutoff valve
6. Liquid side shutoff valve
7. Refrigerant charge port
8. Brazing
9. Liquid side accessory pipe (1)
10. Gas side accessory pipe (1)
11. Gas side accessory pipe (2)
12. Liquid side accessory pipe (2)
13. Knockout hole
14. Punch the knock hole
15. Gas side piping (field supply)
16. Liquid side piping (field supply)

Processing the Gas side accessory pipe (2)

Only in case of connecting at lateral side, cut the Gas side accessory pipe (2) referring the figure below.

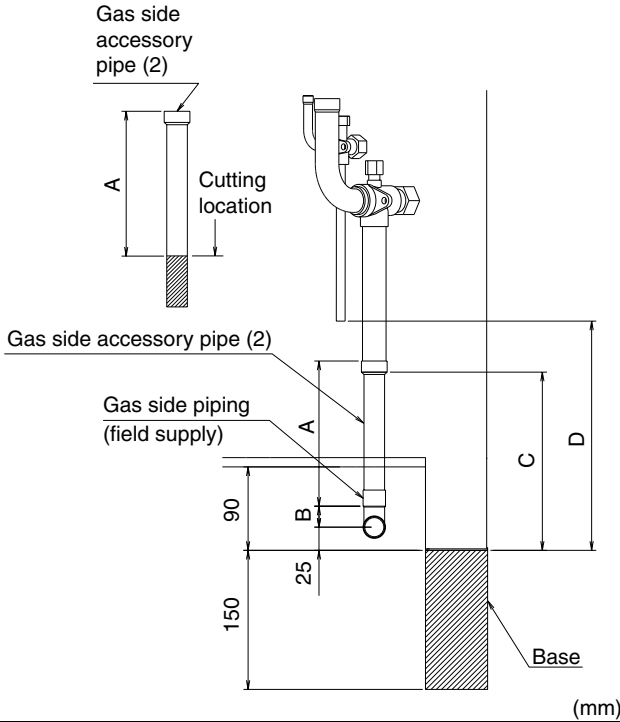

Model	A	B	C	D
Q8 type	156	17	188	247
Q10 type	156	23	192	247
Q12 type	150	29	192	247
Q14 · 16 type	150	29	192	251

**<In case of multi system: RQYQ18-48PY1B>
(Refer to figure 15)**

1. If connected to the front
2. When connected at lateral side (bottom)
3. Remove the shutoff valve cover to connect.
4. Remove the knock hole on the bottom frame and route the piping under the bottom frame.
5. Gas side shutoff valve
6. Liquid side shutoff valve
7. Refrigerant charge port
8. Brazing
9. Liquid side accessory pipe (1)
10. Gas side accessory pipe (1)
11. Gas side accessory pipe (2)
12. Liquid side accessory pipe (2)
13. Knockout hole
14. Punch the knock hole.

Note

<Connecting Refrigerant Piping>

- When connecting the piping on site, be sure to use the accessory piping.
- Make sure the onsite piping does not come into contact with other piping or the bottom frame or side panels of the unit.

<Multi Systems>

- The Outdoor unit multi connection piping kit (sold separately) is needed when connecting piping between outdoor units. Refer to the installation manual that comes with the kit when doing this piping work.
4. Precautions when connecting piping between outdoor units (In case of multi system)

The Outdoor unit multi connection piping kit (sold separately) is needed to connect piping between outdoor units in multi system. Only proceed with piping work after considering the limitations on installation listed here and in "5. Branching the refrigerant piping", always referring to the kit's installation manual.

- (1) The piping between outdoor units must be installed level (Pattern 1) or with a rise (Pattern 2). Otherwise oil may pool in the pipes.

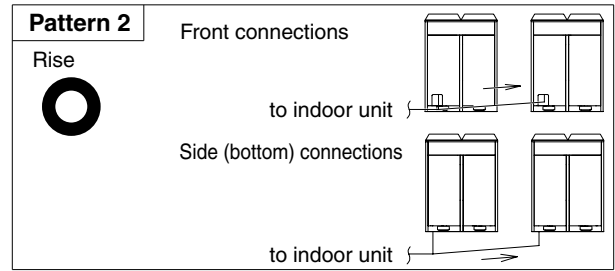
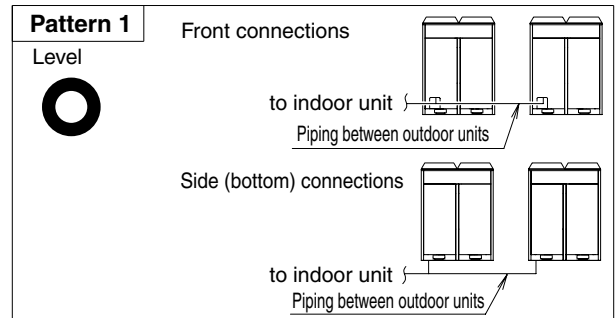

Change to pattern 1 or pattern 2

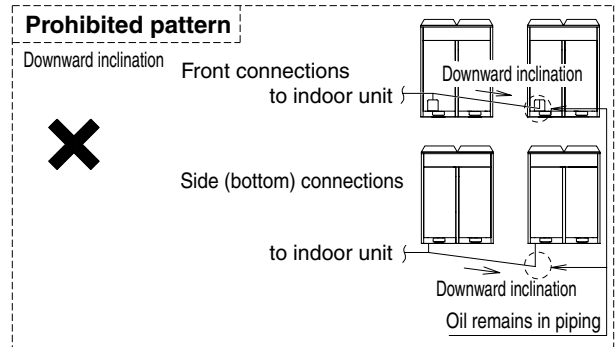

- (2) To avoid the risk of oil detention in the stopping unit, always connect the shutoff valve and the piping between outdoor units as shown in the figure A or figure B.

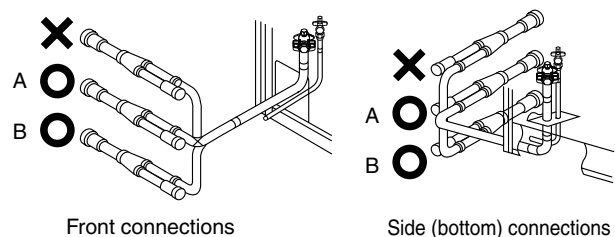

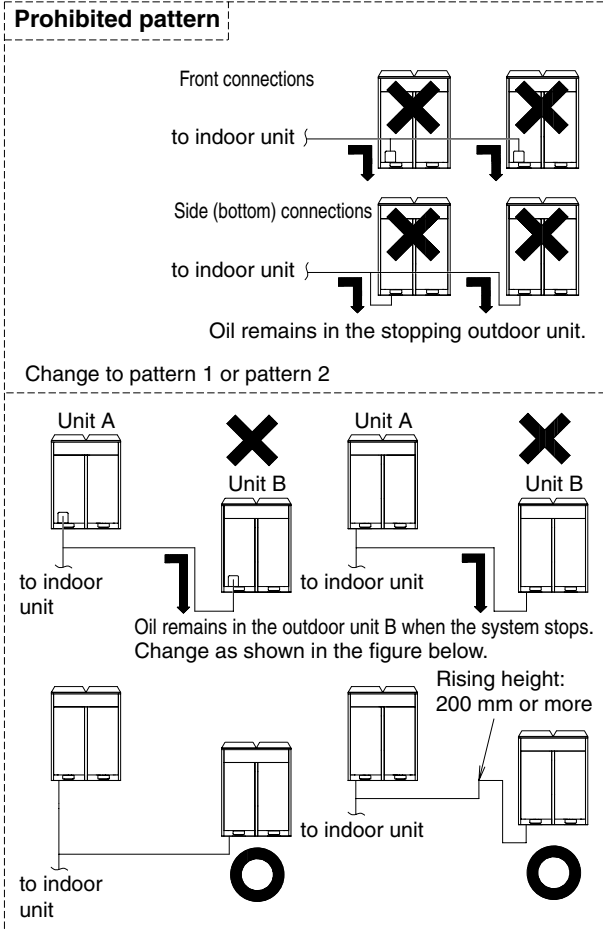

- (3) If the piping length between the outdoor units exceeds 2 m, create a rise of 200 mm or more in the gas line under a length of 2 m from the outdoor unit multi connection piping kit.

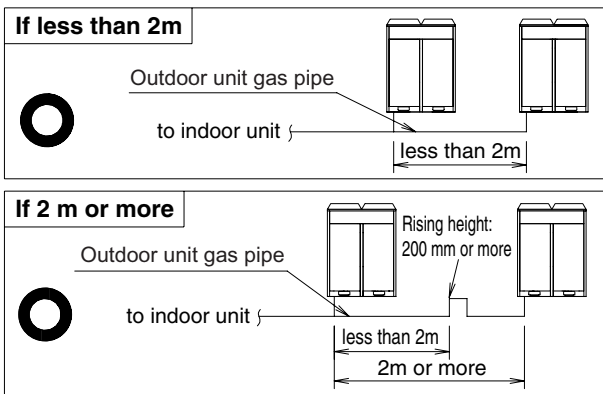

5. Branching the refrigerant piping

Heed the restrictions below when installing the refrigerant branching kit and read the installation instruction manual with the kit. (Improper installation could lead to malfunctioning or breakdown of the outdoor unit.)

<REFNET joint>

Install the REFNET joint so it splits horizontally or vertically.

(Refer to figure 16)

1. Horizontal surface
2. $\pm 30^\circ$ or less
3. Horizontal
4. Vertical

<REFNET header>

Install the REFNET header so it splits horizontally.

(Refer to figure 17)

1. Horizontal surface

<Outdoor unit multi connection piping kit>

- Install the joint horizontally so that the attached warning label faces straight up, and the tilt is within $\pm 15^\circ$. (Refer to figure 18-1) Do not install vertically. (Refer to figure 18-2)

- Maintain a straight portion of 500 mm or more until the split of the joint without wrapping any onsite piping around this area. Over 500 mm of straight area can be maintained by connecting at least 120 mm of onsite pipe (straight) to the joint.

(Refer to figure 18-3)

(Refer to figure 18)

1. Warning label
2. Horizontal surface
3. $\pm 15^\circ$ or less
4. Ground
5. Onsite pipe (120mm length or more)
6. Straight part of 500mm or more

Refrigerant Piping Works (attached table)

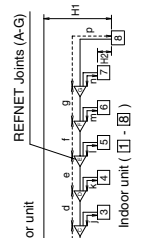
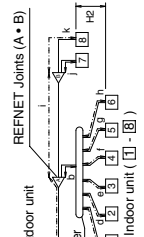
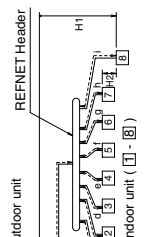
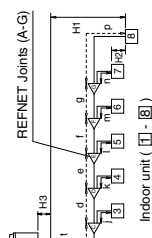
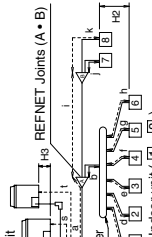
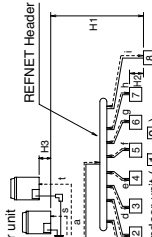
Connection Examples (as connecting 8 indoor units)		Example Refrigerant Branch using REFINET Joint and REFINET Header	Example Refrigerant Branch using REFINET Joint	Example Refrigerant Branch using REFINET Header																								
<p>Individual outdoor unit system (Q8~16)</p> <p>Multi-connecting outdoor unit system (Q18~)</p>	<p>(*) shows outdoor unit multi connection piping kit. Outdoor unit connection piping kit must be located in level.</p> <p>(*) For the multi-connecting systems, please replace "outdoor unit" with "outdoor unit multi connection piping kit" as you read the directions.</p>																											
																												
<p>Allowable Max. Length</p>	<p>Between outdoor unit (*) and indoor unit</p>	<p>Example unit [6] : a + b + h ≤ 150m, [8] : a + i + k ≤ 150m</p>	<p>Example unit [6] : a + b + h ≤ 150m, [8] : a + i + k ≤ 150m</p>	<p>Example unit [8] : a + i ≤ 150m</p>																								
<p>Allowable Height Length</p>	<p>Between outdoor unit multi connection piping kit and outdoor unit (Only for multi-connecting systems)</p>	<p>Total pipe length between outdoor unit (*) and indoor units. ≤ 175m (assume equivalent length of REFINET header to be 1m, calculation purposes.)</p>	<p>Total pipe length between outdoor unit (*) and indoor units. ≤ 300m</p>	<p>Total pipe length between outdoor unit (*) and indoor units. ≤ 130m</p>																								
	<p>Between outdoor unit and indoor unit</p>	<p>Actual pipe length between outdoor unit and indoor unit (H1). ≤ 50m (≤ 40m if the outdoor unit is below)</p>	<p>Actual pipe length between outdoor unit and indoor unit. ≤ 10m</p>	<p>Actual pipe length between outdoor unit and indoor unit. ≤ 13m</p>																								
<p>Allowable Length after the Branch</p>	<p>Between indoor unit and indoor unit</p>	<p>Difference in height between indoor units. (H2) ≤ 15m</p>	<p>Difference in height between indoor units. (H2) ≤ 15m</p>	<p>Difference in height between indoor units. (H2) ≤ 15m</p>																								
	<p>Between outdoor unit and outdoor unit</p>	<p>Difference in height between outdoor units. (H3) ≤ 5m</p>	<p>Difference in height between outdoor units. (H3) ≤ 5m</p>	<p>Difference in height between outdoor units. (H3) ≤ 5m</p>																								
<p>Refrigerant Branch pipe kit selection</p> <p>Refrigerant branch kits can only be used with R410.</p> <p>* When multi outdoor system are installed, be sure to use the special separately sold outdoor unit multi connection piping kit. The table at right shows how to select the proper kit.</p>		<p>How to select REFINET joint</p> <ul style="list-style-type: none"> When REFINET joint is used for the first branch from outdoor unit (REFINET joint A in above e.g.), select from below chart according to outdoor unit capacity. 	<p>How to select REFINET header</p> <ul style="list-style-type: none"> Select from below table according to total indoor units capacity index connected below REFINET header. (Note) 250 type indoor unit cannot be connected below the REFINET header. Use REFINET joint (s). 	<p>How to select outdoor unit multi connection piping kit</p> <ul style="list-style-type: none"> Required for Q18 or more capacity type of outdoor unit. 																								
		<table border="1"> <thead> <tr> <th>Capacity type of outdoor unit</th> <th>Refrigerant branch kit name</th> </tr> </thead> <tbody> <tr> <td>Q8, 10 type</td> <td>KHRP26A33T</td> </tr> <tr> <td>Q12, 22 type</td> <td>KHRP26A72T</td> </tr> <tr> <td>Q 24 type~</td> <td>KHRP26A73T + KHRP26M73TP</td> </tr> </tbody> </table>	Capacity type of outdoor unit	Refrigerant branch kit name	Q8, 10 type	KHRP26A33T	Q12, 22 type	KHRP26A72T	Q 24 type~	KHRP26A73T + KHRP26M73TP	<table border="1"> <thead> <tr> <th>Total capacity index of indoor units</th> <th>Refrigerant branch connection to be used</th> </tr> </thead> <tbody> <tr> <td>< 200</td> <td>KHRP26M22H (max. 4 branch)</td> </tr> <tr> <td>200 ≤ x < 290</td> <td>KHRP26M33H (max. 8 branch)</td> </tr> <tr> <td>290 ≤ x < 640</td> <td>KHRP26M72H (max. 8 branch) (* note)</td> </tr> <tr> <td>640 ≤ x</td> <td>KHRP26M73H + KHRP26M73HP</td> </tr> </tbody> </table> <p>(* Note) If the pipe size above the REFINET header is φ64.9 or more, KHRP26M73HP is required.</p>	Total capacity index of indoor units	Refrigerant branch connection to be used	< 200	KHRP26M22H (max. 4 branch)	200 ≤ x < 290	KHRP26M33H (max. 8 branch)	290 ≤ x < 640	KHRP26M72H (max. 8 branch) (* note)	640 ≤ x	KHRP26M73H + KHRP26M73HP	<table border="1"> <thead> <tr> <th>Numbers of outdoor units</th> <th>Outdoor unit multi connection piping kit name</th> </tr> </thead> <tbody> <tr> <td>2 set</td> <td>BHFP22P100</td> </tr> <tr> <td>3 set</td> <td>BHFP22P151</td> </tr> </tbody> </table>	Numbers of outdoor units	Outdoor unit multi connection piping kit name	2 set	BHFP22P100	3 set	BHFP22P151
Capacity type of outdoor unit	Refrigerant branch kit name																											
Q8, 10 type	KHRP26A33T																											
Q12, 22 type	KHRP26A72T																											
Q 24 type~	KHRP26A73T + KHRP26M73TP																											
Total capacity index of indoor units	Refrigerant branch connection to be used																											
< 200	KHRP26M22H (max. 4 branch)																											
200 ≤ x < 290	KHRP26M33H (max. 8 branch)																											
290 ≤ x < 640	KHRP26M72H (max. 8 branch) (* note)																											
640 ≤ x	KHRP26M73H + KHRP26M73HP																											
Numbers of outdoor units	Outdoor unit multi connection piping kit name																											
2 set	BHFP22P100																											
3 set	BHFP22P151																											
<p>Example of indoor units connected down-stream</p>		<p>(Example) With REFINET joints C, indoor units [3]+[4]+[5]+[6]+[7]+[8]</p>	<p>(Example) With REFINET joints B, indoor units [1]+[2]+[3]+[4]+[5]+[6]</p>	<p>(Example) With REFINET header, indoor units [1]+[2]+[3]+[4]+[5]+[6]+[7]+[8]</p>																								

7. FIELD WIRING

CAUTION

- All field wiring and components must be installed by a licensed electrician and must comply with relevant local and national regulations.
- Be sure to use a dedicated power circuit. Never use a power supply shared by another appliance.
- Never install a phase advancing capacitor. As this unit is equipped with an inverter, installing a phase advancing capacitor will not only deteriorate power factor improvement effect, but also may cause capacitor abnormal heating accident due to high-frequency waves.
- Only proceed with wiring work after blocking off all power.
- Always ground wires in accordance with relevant local and national regulations.
- This machine includes an inverter device. Connect earth and leave charge to eliminate the impact on other devices by reducing noise generated from the inverter device and to prevent leaked current from being charged in the outer hull of the product.
- Do not connect the ground wire to gas pipes, sewage pipes, lightning rods, or telephone ground wires.
Gas pipes: can explode or catch fire if there is a gas leak.
Sewage pipes: no grounding effect is possible if hard plastic piping is used.
Telephone ground wires and lightning rods: dangerous when struck by lightning due to abnormal rise in electrical potential in the grounding.
- Be sure to install an earth leakage circuit breaker.
This unit uses an inverter, so install the earth leakage circuit breaker that be capable of handling high harmonics in order to prevent malfunctioning of the earth leakage circuit breaker itself.
- Earth leakage circuit breaker which are especially for protecting ground-faults should be used in conjunction with main switch or fuse for use with wiring.

Note

- Electrical wiring must be done in accordance with the wiring diagrams and the description herein.
- Do not operate until refrigerant piping work is completed. (If operated before complete the piping work, the compressor may be broken down.)
- Never remove thermistor, sensor or etc. when connecting power wiring and transmission wiring. (If operated with thermistor, sensor or etc. removed, the compressor may be broken down.)
- This product have reversed phase protection detector that only works when the power is turned on. If there exists black out or the power goes on and off which the product is operating, attach a reversed phase protection circuit locally. Running the product in reversed phase may break the compressor and other parts.
- Attach the power wire securely. Introducing power with a missing N-phase or with a mistaken N-phase will break the unit.
- Never connect the power supply in reversed phase. The unit can not operate normally in reversed phase. If you connect in reversed phase, replace two of the three phases.
- Make sure the electrical unbalance ratio is no greater than 2%. If it is larger than this, the unit's lifespan will be reduced. If the ratio exceeds 4%, the unit will shut down and an malfunction code will be displayed on the indoor remote controller.
- Connect the wire securely using designated wire and fix it with attached clamp without applying external pressure on the terminal parts (terminal for power wiring, terminal for transmission wiring and earth terminal).

7-1 Power circuit, safety device, and cable requirements

- A power circuit (see the following table) must be provided for connection of the unit. This circuit must be protected with the required safety devices, i.e. a main switch, a slow blow fuse on each phase and an earth leakage circuit breaker.
- When using residual current operated circuit breakers, be sure to use a high-speed type (1 second or less) 200mA rated residual operating current.
- Use copper conductors only.
- Use insulated wire for the power cord.
- Select the power supply cable type and size in accordance with relevant local and national regulations.

- Specifications for local wiring are in compliance with IEC60245.
- Use wire type H05VV when protected pipes are used.
Use wire type H07RN-F when protected pipes are not used.

	Phase and frequency	Voltage	Minimum circuit amp.	Recommended fuses
RQYQ8PY1B	φ 3, 50Hz	380-415V	18.5A	25A
RQYQ10PY1B	φ 3, 50Hz	380-415V	21.6A	25A
RQYQ12PY1B	φ 3, 50Hz	380-415V	22.7A	25A
RQYQ14PY1B	φ 3, 50Hz	380-415V	31.5A	35A
RQYQ16PY1B	φ 3, 50Hz	380-415V	31.5A	35A
RQYQ18PY1B	φ 3, 50Hz	380-415V	32.5A	40A
RQYQ20PY1B	φ 3, 50Hz	380-415V	41.2A	50A
RQYQ22PY1B	φ 3, 50Hz	380-415V	44.3A	50A
RQYQ24PY1B	φ 3, 50Hz	380-415V	50.0A	60A
RQYQ26PY1B	φ 3, 50Hz	380-415V	51.0A	60A
RQYQ28PY1B	φ 3, 50Hz	380-415V	54.1A	60A
RQYQ30PY1B	φ 3, 50Hz	380-415V	55.2A	70A
RQYQ32PY1B	φ 3, 50Hz	380-415V	63.0A	70A
RQYQ34PY1B	φ 3, 50Hz	380-415V	64.0A	80A
RQYQ36PY1B	φ 3, 50Hz	380-415V	65.0A	80A
RQYQ38PY1B	φ 3, 50Hz	380-415V	73.7A	90A
RQYQ40PY1B	φ 3, 50Hz	380-415V	81.5A	90A
RQYQ42PY1B	φ 3, 50Hz	380-415V	82.5A	100A
RQYQ44PY1B	φ 3, 50Hz	380-415V	83.5A	100A
RQYQ46PY1B	φ 3, 50Hz	380-415V	86.6A	100A
RQYQ48PY1B	φ 3, 50Hz	380-415V	87.7A	100A

Note

The above table indicates power specifications for standard combinations (see 2. INTRODUCTION).

7-2 Wiring Connection Example for Whole System

(Refer to figure 19)

- Power supply
- Main switch
- Earth leakage circuit breaker
- Fuse
- Outdoor unit
- COOL/HEAT selector
- Remote controller
- Indoor unit

Note

- Make sure the weak electric wiring (i.e. for the remote controller, between units, etc.) and the power wiring do not pass near each other, keeping them at least 50 mm apart. Proximity may cause electrical interference, malfunctions, and breakage.
- Be sure to connect the power wiring to the power wiring terminal block and secure it as described in "7-5 Power Wiring Connection Procedure".
- Transmission wiring should be secured as described in "7-4 Transmission Wiring Connection Procedure".
- Secure wiring with clamp such as insulation lock ties to avoid contact with piping.
- Shape the wires to prevent the structure such as the EL.COMPO. BOX lid deforming. And close the cover firmly.

7-3 Leading wire Procedure

- The power wiring and ground wiring are passed out from the power wiring hole on the sides, the front (knock hole) or the bottom frame (knock hole).
- The transmission wiring is passed out from the wiring hole (knock hole) on the front of the unit or from a piping hole.

(Refer to figure 20)

- Electrical wiring diagram
- On the back of the EL.COMPO. BOX lid.
- Power wiring, ground wiring (inside conduit)
- (When the wiring is routed out through the side panel.)
- Transmission wiring
- Pipe opening
- Conduit
- For power wiring and ground wiring
- Through cover
- Cut off the shaded zones before use.
- Burr
- Knockout hole
- For transmission wiring

Note 

- Open the knock holes with a hammer or the like.
- After knocking out the holes, we recommend you remove any burrs and paint them using the repair paint to prevent rusting.
- When passing wiring through the knock holes, remove burrs around the knock holes and protect the wiring with protective tape. (Refer to figure 20)
- If small animals might enter the unit, block off any gaps (hatching parts in figure 20) with material (field supply).

7-4 Transmission Wiring Connection Procedure

- Referring to figure 21, 22 connect the transmission wiring between outdoor unit and indoor unit, outdoor unit and outdoor unit of other system, outdoor unit and outdoor unit of same system (only multi system) or to COOL/HEAT selector.

(Refer to figure 21)

1. Connection example for single system
2. Outdoor unit
3. COOL/HEAT selector
4. To outdoor unit of other system
5. Match up terminal symbols. (Has polarity)
6. Use duplex wires
7. Indoor unit
8. Never connect the power wire

(Refer to figure 22)

1. Connection example for multi system
2. Outdoor unit A (Master unit)
3. Outdoor unit B (Sub unit)
4. COOL/HEAT selector
5. To indoor unit
6. To outdoor unit of other system

- All transmission wiring is to be procured on site. All wiring should use sheathed vinyl cord 0.75-1.25 mm² or cable (duplex). (Triplex only for the COOL/HEAT selector.)
- Transmission wiring (About the symbol ① ~ ③, see figure 21, 22) should be done within the following limitations. If they are exceeded, transmission problems may occur.

① Between outdoor unit and indoor unit

Between outdoor unit and outdoor unit of other systems

- Max. wiring length : 1,000 m
- Max. total wiring length : 2,000 m
- Max. no. of branches : 16

[Note]
No branch is allowed after branch
(See figure 23)

Max. no. of outdoor units of other system that can be connected : 10

(Refer to figure 23)

1. Outdoor unit
2. Indoor unit
3. Branch line 1
4. Branch line 2
5. No branch is allowed after branch
6. Main line
7. Central remote controller, etc.
8. Branch line 3
9. Transmission wiring between outdoor unit and indoor unit
10. Transmission wiring between outdoor unit and outdoor unit

② Between outdoor unit and outdoor unit of same system (Only for multi system)

Max. wiring length : 30 m

③ Transmission wiring to COOL/HEAT selector

Max. wiring length : 500 m

- The transmission wiring inside the EL.COMPO.BOX should be secured using the clamp (1) as shown in figure 24.

(Refer to figure 24)

1. In the EL.COMPO.BOX
2. Retain to the EL.COMPO.BOX with the accessory clamp (1).

- Outside the units, the transmission wiring must be finished simultaneously with the local refrigerant piping, and wound with tape (field supply) as shown in figure 25.

(Refer to figure 25)

1. Liquid pipe
2. Gas pipe
3. Transmission wiring
4. Insulation material
5. Finishing tape

- For multi system:
 1. Transmission wiring between outdoor units in the same piping system must be connected to terminals Q1 and Q2 (TO MULTI UNIT).
Connecting the wires to the F1, F2 (TO OUT/D UNIT) terminals results in system malfunction.
 2. Wiring to other systems should be connected to terminals F1 and F2 (TO OUT/D UNIT) on the PC-board of the master unit. The outdoor unit that connected transmission wiring to indoor unit is the master unit. The others are sub unit.

CAUTION

- Do not connect the power wiring to terminals for the transmission wiring. Doing so would destroy the entire system.
- When connecting wires to the terminal block on the PC-board, too much heat or tightening could damage the PC-board. Attach with care.
See the table below for the tightening torque of the transmission wiring terminals.

Screw size	Tightening torque (N·m)
M3 ABC I/P	0.53 - 0.63
M3.5 (A1P)	0.80 - 0.96

7-5 Power Wiring Connection Procedure

Be sure to connect the power supply wiring to the power supply terminal block and hold it in place using the included clamp as shown in the figure 26.

(Refer to figure 26)

1. Power supply (3N~50Hz 380-415V)
2. Earth leakage circuit breaker
3. Branch switch, Overcurrent breaker
4. Ground wire
5. Attach insulation sleeves
6. Power supply terminal block
7. Ground terminal
8. Clamp (1) (accessory)

- The L1, L2, L3 and N phases of the power wiring should be secured separately to the hook using the included clamp (1).
- The ground wiring should be bound to the power wiring using the included clamp (1) to prevent outside force from being applied to the terminal area.
- Wire so that the ground wiring does not come into contact with the compressor lead wiring. If they touch, this may have an adverse effect on other devices.

CAUTION

- Be sure to use crimp-style terminal with insulating sleeves for connections. (See the figure below.)

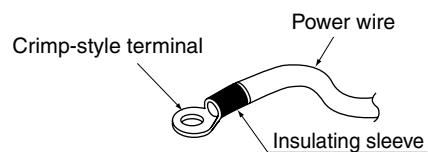

- For wiring, use the designated power wire and connect firmly, then secure to prevent outside pressure being exerted on the terminal board.
- Use an appropriate screwdriver for tightening the terminal screws. A screwdriver with a small head will strip the head and make proper tightening impossible.
- Over-tightening the terminal screws may break them.
See the following table for the tightening torque of the terminal screws.

Screw size	Tightening torque (N·m)
M8 Power terminal, ground terminal	5.5 ~7.3

- When pulling the ground wire out, wire it so that it comes through the cut out section of the cup washer. (See the figure below.) An improper ground connection may prevent a good ground from being achieved.

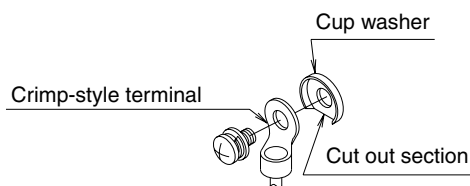

- When two wires are connected to a single terminal, connect them so that the rear sides of the crimp contacts face each other. Also, make sure the thinner wire is on top, securing the two wires simultaneously to the resin hook using the included clamp (1).

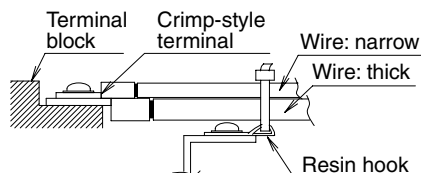

7-6 Procedure for Wiring Inside Units

- Referring to figure 27, secure and wire the power and transmission wiring using the included clamp (1), (2), and (3).

(Refer to figure 27)

- Retain with accessory clamp (3).
- Electric conduit
- When routing out the power/ground wires from the left side.
- When routing out the transmission wiring from the opening for piping.
- When routing out the power/ground wires from the front.
- Clear over 50 mm.
- When routing out the transmission wiring from the knockout hole.
- Retain to the back of the column support with the accessory clamp (2).
- When routing out the power/ground wires from the right side.
- Power wiring
- Transmission wiring
- Ground wire
- Secure to the back side of the support beam using the accessory clamp (1).
- Retain to the back of the column support with the accessory clamp (2).
- When wiring, exercise sufficient caution not to detach the acoustic insulators from the compressor.



CAUTION

- The transmission wiring must be at least 50 mm away from the power wiring.
- Make sure all wiring do not contact to the pipes (hatching parts in the figure 27).
- After wiring work is completed, check to make sure there are no loose connections among the electrical parts in the EL.COMPO.BOX.

8. AIR TIGHT TEST AND VACUUM DRYING

Note

- Always use nitrogen gas for the airtightness test.
- Absolutely do not open the shutoff valve until the main power circuit insulation measurement has been completed. (measuring after the shutoff valve is opened will cause the insulation value to drop.)

8-1 Preparations

<Needed tools>

Gauge manifold Charge hose valve	<ul style="list-style-type: none"> To prevent entry of any impurities and insure sufficient pressure resistance, always use the special tools dedicated for R410A. Use charge hose that have pushing stick for connecting to service port of shutoff valves or refrigerant charge port.
Vacuum pump	<ul style="list-style-type: none"> The vacuum pump for vacuum drying should be able to lower the pressure to -100.7kPa (5 Torr -75mm Hg). Take care the pump oil never flow backward into the refrigerant pipe during the pump stops.

<The system for air tight test and vacuum drying>

- Referring to figure 28, connect an nitrogen tank, refrigerant tank, and a vacuum pump to the outdoor unit.

The refrigerant tank and the charge hose connection to refrigerant charge port or the valve A, C in figure 28 are needed in "11. ADDITIONAL REFRIGERANT CHARGE AND CHECK OPERATION".

- The shutoff valve and valve A~C in figure 28 should be open or closed as shown in the table below.

(Refer to figure 28)

- Gauge manifold
- Nitrogen
- Measuring device
- R410A tank (with siphon)
- Vacuum pump
- Charge hose
- Liquid side shutoff valve
- Gas side shutoff valve
- Shutoff valve service port
- Valve B
- Valve C
- Valve A
- Outdoor unit
- Refrigerant charge port
- To indoor unit
- Interunit pipings
- Refrigerant flow

State of valve A, B and C and shutoff valves	Valve			shutoff valve	
	A	B	C	Liquid side	Gas side
Air tight test, Vacuum drying (Close valve A and shutoff valves certainly. Otherwise the refrigerant in the unit are released.)	Close	Open	Open	Close	Close

Note

- The airtightness test and vacuum drying should be done using the liquid side and gas side shutoff valve service ports. See the [R410A] Label attached to the front plate of the outdoor unit for details on the location of the service port (see figure at right).
- See [Shutoff valve operation procedure] in "11-1 Before working" for details on handling the shutoff valve.
- The refrigerant charge port is connected to unit pipe. When shipped, the unit contains the refrigerant, so use caution when attaching the charge hose.

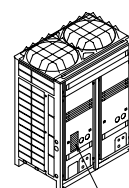

[R410A] Label

8-2 Air tight test and vacuum drying method

After finished piping work, carry out air tight test and vacuum drying.

<Air tight test>

Pressurize the liquid and gas pipes to 3.3MPa (33bar) (do not pressurize more than 3.3MPa (33bar)). If the pressure does not drop within 24 hours, the system passes the test.

If there is a pressure drop, check for leaks, make repairs and perform the airtight test again.

<Vacuum drying>

Evacuate the system from the liquid and gas pipes by using a vacuum pump for more than 2 hours and bring the system to -100.7kPa or less. After keeping the system under that condition for more than 1 hour, check if the vacuum gauge rises or not. If it rises, the system may either contain moisture inside or have leaks.



Note 

If moisture might enter the piping, follow belows. (I.e., if doing work during the rainy season, if the actual work takes long enough that condensation may form on the inside of the pipes, if rain might enter the pipes during work, etc.)

- (1) After performing the vacuum drying for two hours, pressurize to 0.05 MPa (i.e., vacuum breakdown) with nitrogen gas, then depressurize down to -100.7 kPa for an hour using the vacuum pump (vacuum drying).
- (2) If the pressure does not reach -100.7 kPa even after depressurizing for at least two hours, repeat the vacuum breakdown - vacuum drying process.

After vacuum drying, maintain the vacuum for an hour and make sure the pressure does not rise by monitoring with a vacuum gauge.

9. PIPE INSULATION

- Insulation of pipes should be done after performing “8. AIR TIGHT TEST AND VACUUM DRYING”.
- Always insulate the liquid side piping and gas side piping in the interunit piping and refrigerant branching kit. Failing to insulate the pipes could cause leaking or burns. (The gas side piping can reach temperatures of 120°C. Be sure the insulation used can withstand such temperatures.)
- Reinforce the insulation on the refrigerant piping according to the installation environment. Condensation might form on the surface of the insulation.
 - Ambient temperature: 30°C, humidity: 75% to 80% RH: min. thickness: 15 mm.
 - If the ambient temperature exceeds 30°C and the humidity 80% RH, then the min. thickness is 20 mm.
- If there is a possibility that condensation on the shutoff valve might drip down into the indoor unit through gaps in the insulation and piping because the outdoor unit is located higher than the indoor unit, etc., this must be prevented by caulking the connections, etc. (Refer to figure 29)
- The piping lead-out hole lid should be attached after opening a knock hole. (Refer to figure 30)
- If small animals and the like might enter the unit through the piping lead-out hole, close the hole with blocking material (procured on site) after completion of “11. ADDITIONAL REFRIGERANT CHARGE AND CHECK OPERATION”. (Refer to figure 30)
 - (Refer to figure 29)
 1. Liquid side shutoff valve
 2. Gas side shutoff valve
 3. Indoor interunit piping
 4. Insulation material
 5. Coking, etc.
 6. Refrigerant charge port
 - (Refer to figure 30)
 1. Piping lead-out hole lid
 2. Open a knock hole at “”.
 3. Block “”.
 4. Liquid side piping
 5. Gas side piping

Note 

- After knocking out the holes, we recommend you remove burrs in the knock holes (see figure 30) and paint the edges and areas around the edges using the repair paint.

10. CHECKING OF DEVICE AND INSTALLATION CONDITIONS

Be sure to check the followings.

For those doing electrical work

1. Make sure there is no faulty transmission wiring or loosening of a nut. See “7-4 Transmission Wiring Connection Procedure”.
2. Make sure there is no faulty power wiring or loosening of a nut. See “7-5 Power Wiring Connection Procedure”.
3. Has the insulation of the main power circuit deteriorated? Measure the insulation and check the insulation is above regular value in accordance with relevant local and national regulations.

For those doing pipe work

1. Make sure piping size is correct. See “6-1 Selection of piping material and Refrigerant branching kit”.
2. Make sure insulation work is done. See “9. PIPE INSULATION”.
3. Make sure there is no faulty refrigerant piping. See “6. REFRIGERANT PIPING”.

11. ADDITIONAL REFRIGERANT CHARGE AND CHECK OPERATION

The outdoor unit is charged with refrigerant when shipped from the factory, but depending on the size and length of the piping when installed, it may require additional charging.



For charging the additional refrigerant, follow the procedure in this chapter.

And then carry out the check operation.

11-1 Before working

[About the refrigerant tank]

Check whether the tank has a siphon pipe before charging and place the tank so that the refrigerant is charged in liquid form. (See the figure below.)

With siphon pipe	
	Stand the tank upright and charge. (The siphon pipe goes all the way inside, so the tank does not need be put upside-down charge in liquid form.)
Other tanks	
	Stand the tank upside-down and charge.

CAUTION 

- Always use the proper refrigerant (R410A). If charged with the refrigerant containing an improper material, it may cause an explosion or accident.
- R410A is a mixed refrigerant, so charging it as a gas will cause the refrigerant composition to change, which may prevent normal operation.

[Shutoff valve operation procedure]

When operating the shutoff valve, follow the procedure instructed below.

Note 

- Do not open the shutoff valve until “10. CHECKING OF DEVICE AND INSTALLATION CONDITIONS” are completed. If the shutoff valve is left open without turning on the power, it may cause refrigerant to buildup in the compressor, leading insulation degradation.
- Be sure to use the correct tools. The shutoff valve is not a back-seat type. If forced it to open, it might break the valve body.
- When using a service port, use the charge hose.
- After tightening the cap, make sure no refrigerant gas is leaking.

[Tightening torque]

The sizes of the shutoff valves on each model and the tightening torque for each size are listed in the table below.

<Size of Shutoff Valve>

	Q8 type	Q10 type	Q12 type	Q14 type	Q16 type
Liquid side shutoff valve	φ 9.5 The Q12 type corresponds to the 12.7-diameter onsite piping using the included piping.			φ 12.7	
Gas side shutoff valve	φ 15.9	φ 19.1	φ 25.4 The Q10 type corresponds to the 22.2-diameter onsite piping using the accessory pipe. The Q12 ~ 16 type corresponds to the 28.6-diameter onsite piping using the accessory pipe.		

<Tightening torque>

Shutoff valve size	Tightening torque N·m (Turn clockwise to close)			
	Shaft (valve body)		Cap (valve lid)	Service port
φ 9.5	5.4 - 6.6	Hexagonal wrench 4 mm	13.5 - 16.5	
φ 12.7	8.1 - 9.9		18.0 - 22.0	
φ 15.9	13.5 - 16.5	Hexagonal wrench 6 mm	22.5 - 27.5	
φ 19.1	27.0 - 33.0	Hexagonal wrench 8 mm		
φ 25.4				

(Refer to figure 34)

1. Service port
2. Cap
3. Hex holes
4. Shaft (valve body)
5. Seal section

[To open]

1. Remove the cap and turn the shaft counterclockwise with the hexagon wrench (JISB4648).
2. Turn it until the shaft stops.
3. Make sure to tighten the cap securely.
(For the tightening torque, refer to the item <Tightening Torque>.)

[To close]

1. Remove the cap and turn the shaft clockwise with the hexagon wrench (JISB4648).
2. Securely tighten the valve until the shaft contacts the main body seal.
3. Make sure to tighten the cap securely.
(For the tightening torque, refer to the item <Tightening Torque>.)

[To connect R22 indoor unit]

To connect an indoor unit compatible with R22, the following setting is required (R410 is default set at the factory).

It is impossible to connect combination of R410 unit and R22 unit. (For K type and following versions, connection of R22 indoor unit is possible.)

(LED display: ● ...OFF ☀ ...ON 🌀 ...Blinking * ...Uncertain)	LED display						
	H1P	H2P	H3P	H4P	H5P	H6P	H7P
From Setting Mode 1 (LED1: Lights off)	●	*	☀	●	●	●	●
(1) Hold down the MODE button (BS1) for 5 seconds. LED1 lights on.	☀	*	●	●	●	●	●
(2) Press the SET button (BS2) 62 times. Confirm LEDs display as right in this table.	☀	☀	☀	☀	☀	☀	●
(3) Press the RETURN button (BS3) once. LED7 blinks.	☀	●	●	●	●	●	🌀
(4) Press the SET button (BS2) once, and adjust the setting value. Set to 2 from 1.	☀	●	●	●	●	🌀	●
(5) Press the RETURN button (BS3). Blinking LEDs change to light on.	☀	●	●	●	●	☀	●
(6) Press the RETURN button (BS3) again. The setting is changed.	☀	●	●	●	●	●	●
(7) Press the MODE button (BS1) once to exit out of Setting Mode. Exits Setting Mode and returns to Normal Mode.	●	*	☀	●	●	●	●

Note 📌

Press the MODE button (BS1) if you get confused while operating. This returns to **Setting Mode 1** (default).

[How to Check How Many Units are Connected]

It is possible to find out how many indoor or outdoor unit in the system are turned on by operating the push button on the PC-board (A1P) of outdoor unit (In case of multi system master unit).

Follow the procedure below to check how many indoor or outdoor units are turned on.

(LED display: ● ...OFF ☀ ...ON 🌀 ...Blinking * ...Uncertain)	LED display						
	H1P	H2P	H3P	H4P	H5P	H6P	H7P
(1) Press the MODE button (BS1) once, and set the MONITOR MODE (H1P: Blinking).	🌀	●	●	●	●	●	●
(2) Press the SET button (BS2) the number of times until the LED display matches that at right.	For checking the number of outdoor units: eight times	🌀	●	●	☀	●	●
		For checking the number of indoor units: five times	🌀	●	●	☀	●
(3) Press the RETURN button (BS3) and read the number of units from the display of H2P through H7P. [Reading Method] The display of H2P through H7P should be read as a binary number, with 🌀 standing for "1" and ● standing for "0".	🌀	*	*	*	*	*	*
<p>Ex: For the LED display at right, this would be "010110", which would mean 22 units are connected.</p> $32 \times 0 + 16 \times 1 + 8 \times 0 + 4 \times 1 + 2 \times 1 + 1 \times 0 = 22 \text{ units}$ <p>Note: "000000" indicates 64 units.</p>	🌀	●	🌀	●	🌀	🌀	●
(4) Press the MODE button (BS1) once. This returns to Setting Mode 1 (default).	●	●	☀	●	●	●	●

Note 📌

Press the MODE button (BS1) if you get confused while operating. This returns to **Setting Mode 1** (default).

11-2 Procedure of Adding Refrigerant charging and check operation

⚠ WARNING ⚠ ELECTRIC SHOCK WARNING

- Make sure to close the EL. COMPO. BOX lid before turning on the power when performing the refrigerant charging operation.
- Perform the setting on the PC-board (A1P) of the outdoor unit and check the LED display after the power is on via the inspection door which is in the EL. COMPO. BOX lid.
- Use an insulated rod to operate the push buttons via the EL. COMPO. BOX's inspection door.
There is a risk of electric shock if you touch any live parts, since this operation must be performed with the power on.

⚠ CAUTION

- Make sure to use the protect tool (protective grooves and goggles) when charging the refrigerant.
- Due to a danger of liquid hammer, the refrigerant must not be charged over the allowable maximum amount when charging the refrigerant.
- Do not perform the refrigerant charging operation under working for the indoor unit.
- When opening the front panel, make sure to take caution to the fan rotation during the working.
After the outdoor unit stops operating, the fan may keep rotation for a while.

Note

- If operation is performed within 12 minutes after the indoor and outdoor units are turned on, H2P will be lit on and the compressor will not operate.
- In order to ensure uniform refrigerant distribution, it may take up to around 10 minutes for the compressor to start up after the unit starting operating. This is not a malfunction.

<About refrigerant charging>

- The refrigerant charge port is connected to the piping inside the unit.
When the unit is shipped from the factory, the unit's internal piping is already charged with refrigerant, so be careful when connecting the charge hose.
- After adding the refrigerant, make sure to close the lid of the refrigerant charging port.
The tightening torque for the lid is 11.5 to 13.9 N·m.
- See [Shutoff valve operation procedure] in chapter 11-1 for details on how to handle shutoff valves.
- When done or when pausing the refrigerant charging operation, close the valve of the refrigerant tank immediately. If the tank is left with the valve open, the amount of refrigerant which is properly charged may be off the point. More refrigerant may be charged by any remaining pressure after the machine is stopped.

<About check operation>

- **Make sure to perform the check operation after installation. Otherwise, the malfunction code "U3" will be displayed and normal operation cannot be performed.**
And the failure of "Check of miswiring" may also cause abnormal operation. Performance may drop due to the failure of "Judgment of piping length".
- Check operation must be performed for each refrigerant piping system.
Checking is impossible if plural systems are being done at once.
- The individual problems of indoor units can not be checked.
About these problems check by test run after the check operation is completed. (See chapter 13)
- The check operation cannot be performed in recovery or other service modes.

<About re-charging of refrigerant>

- When sizes and length of field pipings are certain, figure out the re-charging amount of refrigerant by calculation method of refrigerant charging amount on the installation manual, then charge according to "6-5. Example of connection". (Check operation time shall be shortened.)
Although there supposed to be no re-charging amount required by calculation, it still occasionally needed to be re-charged depending on the installation circumstances, etc.
- In case of long pipings, but sizes and length of field pipings are not certain, indication for re-charging of refrigerant is shown by outdoor unit LED and (for BRC1A52) on the remote controller.

Please see the remote controller indication list at "11-2 Procedure of Adding Refrigerant charging and check operation".

<Notes on check operation>

- If operated within approx. 12 min. after turning on the indoor, BS and outdoor units, H2P will light-on and compressor shall not start its operation.
Please start the operation after confirming the proper indication of LED according to "Check operation".
- For multi-connecting outdoor unit systems, operation of push-buttons and checks of LED indications shall be done at the parent unit.
Outdoor unit to which indoor unit connection wires are connected is the parent unit.
- It may takes approx. 10 min. from turning on the operation till the compressor actually starts operating. This is to equalize the refrigerant condition, not a sign of malfunction of the system.
- Indoor unit cannot be checked individually.
Please check at normal operation by remote controller after this check operation.
- Do not test operate while working on the indoor units.
Not only outdoor units but also indoor units are operated at the check operation.
- Please close all the outside panels except the one for electrical components box while working.
- Re-charging according to a check operation shall be done when outdoor temperature is 0°C or higher, and indoor temperature is 10°C or higher.
If outdoor temperature is too low, it drops the temperature of refrigerant tank and may not be able to charge.
If indoor temperature is too low, it may cause an excess of charging.
- Close the outside panels except when operating the push-buttons, or installing the charging tube.
- Sounds of refrigerant flow, activating of solenoid valves, etc. could be from time to time louder during operation.

1. Make sure the following works are complete in accordance with the installation manual.
 - Piping work
 - Wiring work
 - Air tight test
 - Vacuum drying
 - Installation work for indoor unit
2. Calculate the "additional charging amount" from the following.

	additional charge amount
RQYQ8PY1B	0.0kg
RQYQ10PY1B	0.7kg
RQYQ12PY1B	2.1kg
RQYQ14PY1B	1.7kg
RQYQ16PY1B	2.0kg
RQYQ18PY1B	0.7kg
RQYQ20PY1B	2.1kg
RQYQ22PY1B	2.8kg
RQYQ24PY1B	4.2kg
RQYQ26PY1B	2.7kg
RQYQ28PY1B	4.1kg
RQYQ30PY1B	3.7kg
RQYQ32PY1B	4.0kg
RQYQ34PY1B	2.7kg
RQYQ36PY1B	4.1kg
RQYQ38PY1B	4.8kg
RQYQ40PY1B	6.2kg
RQYQ42PY1B	4.7kg
RQYQ44PY1B	6.1kg
RQYQ46PY1B	5.7kg
RQYQ48PY1B	6.0kg

3. Open the valve C (See the figure 31. The valve A, B and the liquid and gas side shutoff valve must be left closed), and charge the refrigerant of the “additional charging amount” from the liquid side shutoff valve service port.
If the “additional charging amount” was charged fully, close the valve C and go to step 4.
If the “additional charging amount” was not charged fully, go to step 4.

(Refer to figure 31)

1. Measuring device
2. R410A tank (with siphon)
3. Charge hose
4. Liquid side shutoff valve
5. Gas side shutoff valve
6. Shutoff valve service port
7. Valve B
8. Valve C
9. Valve A
10. Outdoor unit
11. Refrigerant charge port
12. To indoor unit
13. Field pipings
14. Refrigerant flow

(Refer to figure 35)

1. R410A
2. Tank
3. (Siphon method)
4. Charging tube
5. Valve A
6. Gas side
7. Liquid side
8. Outdoor unit
9. To indoor unit
10. Slave unit
11. Refrigerant charging port
12. Stop valve service port
13. Scale
14. Shows field pipings

- Use a charging tube with a pushing projection (at the connecting end) to connect the refrigerant charging port mounted to the shutoff valve fixing plate.
- Please be careful not to leak refrigerant when connecting the charging tube.

Refrigerant charging port is mounted to internal pipings of the product, in which refrigerant is already charged by the manufacturer.

Liquid side shutoff valve	Gas side shutoff valve
open	open

4. Perform the refrigerant charging operation according to [check operation], and charge the remaining refrigerant of the “additional charging amount”. For performing the refrigerant charging operation the push button on the PC-board (A1P) of outdoor unit (In case of multi system master unit) are use. (See the figure 32) In addition, the refrigerant are charged from the refrigerant charge port via the valve A. (See the figure 33)
For operating the push button and opening and closing the valve, follow the work procedure.

Note 

The refrigerant will be charged about 22kg in one hour at outdoor temp. 30°C DB (6kg at 0°C DB).

If you need to speedup in case of multi system, connect the refrigerant tanks to each outdoor unit as shown in the figure 33.

(Refer to figure 32)

1. EL.COMPO.BOX lid
2. Pipe intake
3. Inspection door
4. Label “Service Precaution”
5. LED (H1~8P)
6. Push button (BS1-5)
7. Lift the protruding part to open the cover



(Refer to figure 33)

1. Measuring device
2. R410A tank (with siphon)
3. Charge hose
4. Liquid side shutoff valve
5. Gas side shutoff valve
6. Shutoff valve service port
7. Valve B
8. Valve C

9. Valve A
 10. Outdoor unit
 11. Refrigerant charge port
 12. Field piping
 13. Refrigerant flow
 14. To indoor unit
 15. In case of multi system if you need to speedup.
5. Make certain you have fully completed the supplied CHECK LIST OF INSTALLED SYSTEM, and then sign your signature.

11-2-1 Refrigerant Charging Operation Procedure

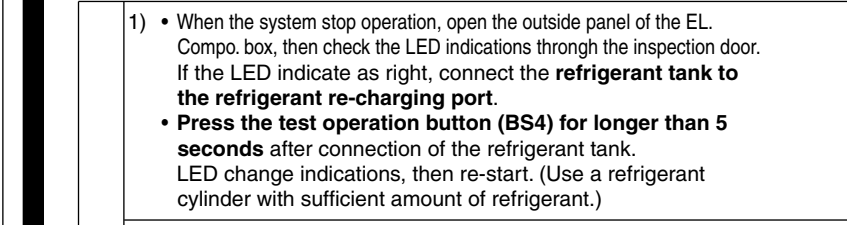
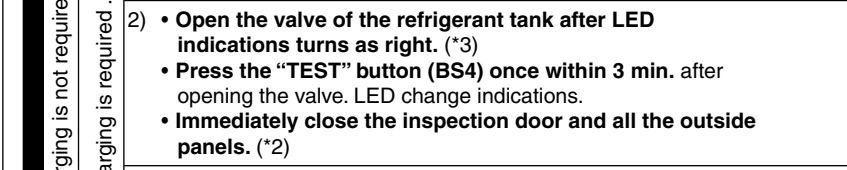
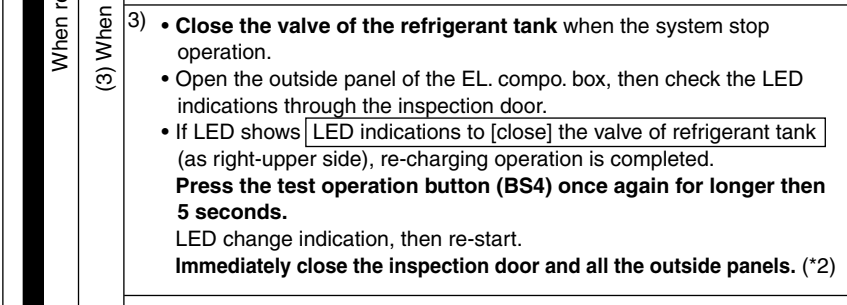
[Check operation]

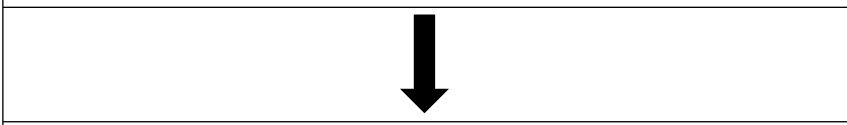
Procedures	Operational Conditions (Each of mentioned below is a standard operation time. It could change depending on the installation circumstances, etc.)
(1) Turn to [Set-up Mode 1] (H1P : light-out) H1P light is usually out. If H1P is \odot (blinking) or \circ (lighted-on), press "MODE" button (BS1) once to go into [set-up Mode 1]. (If H2P is lighted-on, check the defect codes with a remote controller to find out the cause. Repair the defect part according to the list on the installation manual (1) 11.)	normal (H2P : light-out)
	defect (H2P : light-on)
(2) After confirmed that it's back in a normal condition, press "TEST" button (BS4) for longer than 5 seconds. It starts warming-up for the operation, and LED indication turns as right descriptions (in approx. 50 seconds). Close all the outside panels after putting back the service cover. (*2)	Operation to check refrigerant amount 1 Turn on the indoor fan to keep the condition of refrigerant stable. (It may take nearly 30 min., depending on the refrigerant condition.)
	Operation to check stop valve and mis-wiring (approx.5 min.) (Contamination prevention is operated at the same time.)
	Operation to check refrigerant amount 2 Check the refrigerant amount, and make adjustments. (Contamination prevention is operated at the same time.)
	The system stop operation for warming-ups before re-charging of refrigerant, then LED indicate to connect the refrigerant tank (as on the right).
	Stand-by for a stable condition after the re-start.
	LED indicate to open the valve of the refrigerant tank (as on the right) in approx. 6 min. after the re-start.
	Operation for re-charging of refrigerant (1~ 60 min.) (Contamination prevention is operated at the same time.)
	The system stop operation upon completion of re-charging of refrigerant, then LED indicate to close the valve of the refrigerant tank (as on the right).
	The system stop operation due to shortage of refrigerant re-charging amount, then LED indicate to replace the refrigerant tank (as on the right).
	Stand-by for a stable condition after the re-start.
	Operation for contamination prevention (30 ~ 60 min.) It takes max. 1 hour.
	Automatic measuring of piping length. (Approx.10 min.) This is to check the length of field pipings. Final check of the refrigerant amount is done at the same time.
(4) • After the system stop operation, remove the outside panel of the EL. compo. box, then check the LED indications through the inspection door. • When completed properly. • Disconnect the refrigerant tank. • Close all the outside panels after putting back the inspection door.	Properly completed (H2P : light-out)
	Defect determined (H2P : light-on)

When re-charging is not required

(3) When re-charging is required (*4)

LED indications ●: light-out ○: light-on ◐: blinking

MODE	HWL:☀	C/H SELECTOR			L.N.O.P	DEMAND	indications on remote controller (*1)
		IND	MASTER	SLAVE			
H1P	H2P	H3P	H4P	H5P	H6P	H7P	
●	●	○	●	●	●	●	A
●	○	○	●	●	●	●	B
●	◐	●	●	●	●	○	C
●	◐	●	●	●	○	●	C
●	◐	●	●	●	○	○	C
LED indications to connect the refrigerant tank							D (P8)
◐	◐	◐	●	○	●	●	
●	◐	●	●	○	●	●	C
LED indications to [open] the valve of refrigerant tank							C (*3)
◐	◐	◐	●	○	●	○	
●	◐	●	●	○	●	○	C
LED indications to [close] the valve of refrigerant tank							D (P9)
◐	◐	◐	●	○	○	●	
LED indications as re-charging amount of refrigerant is not sufficient.							D (PA)
◐	◐	◐	●	◐	●	●	
●	◐	●	●	○	○	●	C
●	◐	●	●	○	○	○	C
●	◐	●	○	●	●	●	C
●	●	○	●	●	●	●	A
●	○	○	●	●	●	●	B

■ Functions of push-buttons

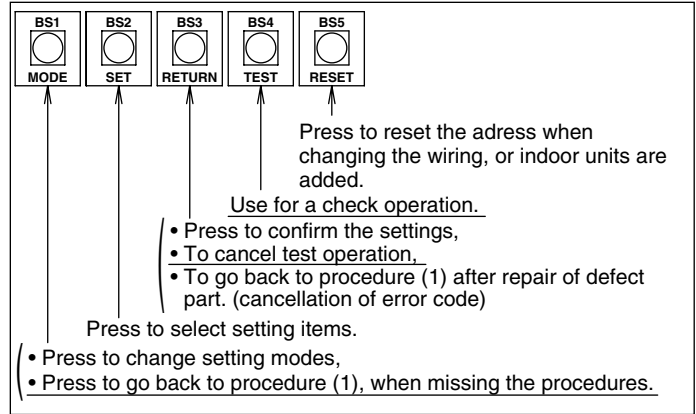

• If the system stops and a indoor remote controller indicates any defect, repair the defect part according to the list on the installation manual (1) 11.
Test operate again after the repair.
• To test operate again, press the "RETURN" button (BS3) to turn the LED back to "normal" indications as procedure (1).

If the "TEST" button (BS4) is not pressed within 3 min. after the indication to open the valve, it goes back to procedure (3) 1) and stops the system again.

In this case, either refrigerant tank became empty, or the valve of the refrigerant tank is not open.
If the refrigerant tank is empty, replace the tank, then press the "TEST" button (BS4) for longer than 5 sec. to re-start the system.
LED change indications, then stand-by for a stable condition before the operation for refrigeration re-charge.
Then open the valve of the refrigerant cylinder by following the procedure (3) 2).

• If the system stops and a indoor remote controller indicates any defect, repair the defect part according to the list on the installation manual (1) 11.
Test operate again after the repair.
• To check operate again, press the "RETURN" button (BS3) to turn the LED back to "normal" indications as procedure (1).

(*1) : Please refer below ■ Remote controller indications at check operation to confirm the details of each indication.

(*2) : If outside panels are not closed, it may not be able to operate normally when outdoor temperature is high, etc.

(*3) : Remote controller does not indicate the procedures. Make sure to check the LED indications upon operation.

(*4) : Recode the amount of refrigerant re-charge on the additional refrigerant charge label.

⚠ WARNING ⚡ ELECTRIC SHOCK WARNING

- Do not move away from the outdoor unit if outside panel is not closed during a test operation.
- In case you need to move away from the outdoor unit, follow either one of the below directions
 1. Replace with other installation worker.
 2. Push the "RETURN" button (BS3) to cancel the test operation.
(In this case, close all the outside panel, and close also the valve if any cylinder is connected.)

■ Remote controller indications at check operation (for BRC1C62)

A. Before check operation } Normal Indications
After check operation }

- *1 Regardless of previous settings, it always indicates for cooling operation after a check operation.
- *2 Indication of “ ” may occasionally blinks, light-on, or light-out, which depends on the setting of cooling/heating switch on the remote controller.
Please see the instruction manual of indoor unit for the details.

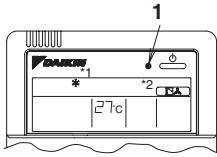

All indications are lighted-on.

1 Pilot lamp (light-out)

B. Error Codes (defect indications)

(Note) Error codes shown here are examples and only for a reference.

(1) Before check operation

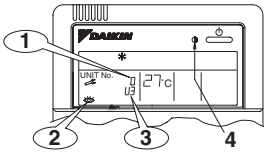

All other indications are lighted-on.

(2) During check operation

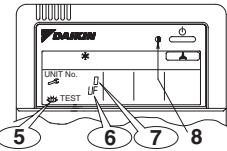

All other indications are lighted-on.

1 2 3 5 6 7 blinking
4 8 Pilot lamp (blinking)

Repair the defect part according to the list on the installation manual (1) 11.

C. Indications at check operation

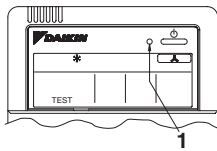

All other indications are lighted-on.

1 Pilot lamp (light-on)

D. Indications at check operation

(For when re-charging from refrigerant tank is required. (Compressor is not operated.))

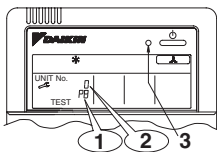

All other indications are lighted-on.

*Error code indicated at	Procedures to be taken
P8	Connect the refrigerant tank.
P9	Close the valve of the refrigerant tank.
P9	This shows a request (instruction) to re-connect the refrigerant tank when refrigerant re-charging amount is not sufficient. It happens when either the refrigerant cylinder becomes empty, or cylinder valve is not open. Replace the cylinder, or open the cylinder valve after a re-start.

* It shows as an error code, but not actually any kind of defect. Indicates directions of refrigerant re-charging procedures. Indications shall be different depending on each remote controller and/or optional accessory.

[Remote controller displays malfunction code]

Malfunction code	Installation error	Remedial action
A* C* (Note)	Indoor unit of connecting remote controller is malfunction.	Correct the malfunction by reference to installation manual of indoor unit or operation manual of outdoor unit.
E3, F4 F3, UF	The shutoff valve of the outdoor unit is left closed.	Open the shutoff valve.
U1	The phases of the power to the outdoor unit are reversed.	Exchange two of the three phases (L1, L2, L3) and connect with the correct phase.
U3	Check operation has been completed normally.	Perform the check operation again.
U1 U4 LC	Power is not being supplied (including cases of open phase) to the outdoor or BS or indoor unit.	Supply power correctly to the outdoor, BS or indoor unit.
U7 UA	A model which cannot be connected in a multi-outdoor-unit system has been connected in a multi-outdoor-unit system.	Change to individual piping, and disconnect the wiring from the multi-outdoor-unit terminals (Q1, Q2)
U9	There is a problem with another BS and indoor unit within the same system.	A malfunction code is displayed on the remote controller, or else trouble has occurred at BS and indoor unit where a malfunction code is not displayed on the remote controller. Correct the trouble at the corresponding BS and indoor unit. If no malfunction code is displayed on the remote controller, press the Inspection/Test button on the remote controller to display the malfunction code.
UF	Wrong wiring between units.	Agree refrigerant system and connection wire between the units.
UF	If an outdoor - outdoor transmission wire was connected or disconnected during check operation.	Complete the transmission wiring work, then perform check operation again.
U4, U7 UH, UF	Wrong wiring between units.	Connect the interunit wiring (indoor - outdoor, outdoor - outdoor, multi-outdoor-unit). If voltage of 100V or higher was applied to the outdoor unit PCB (A1P), the outdoor unit PCB or BS unit PCB may be damaged. If the malfunction display “UH” appears even after the connection was corrected, the PCB must be replaced. Refer to Service Manual for details.
PJ	DIP switch (DS1) setting is incorrect after the outdoor unit PCB (A1P) was replaced.	Follow the information on spare parts with a spare PCB of outdoor unit and make the correct setting.
P2	Check operation cannot be continued by the low pressure drops.	Check the following. • All shutoff valves are open. • Refrigerant tank is connected. • Valve of refrigerant tank is open. • Inlet or outlet of indoor unit are not closed due to a foreign object.
P8 PA	Instruction to perform additional refrigerant charging during check operation (not a malfunction).	Make the check operation by “11-2 Procedure of Adding Refrigerant charging and check operation”.
UA	R22 indoor unit is connected.	Set necessary setting for R22 indoor unit. Refer to “11. ADDITIONAL REFRIGERANT CHARGE AND CHECK OPERATION”.

If any malfunction codes other than the above are displayed, check the service manual for how to respond.

12. ONSITE SETTINGS

Note

In the case of a multi system, all onsite settings should be made on the master unit. Settings made on sub units are invalid. The outdoor unit to which the indoor unit transmission wire are connected is the master unit, and all other units are sub units.

12-1 Onsite Settings With the Power Off

If the COOL/HEAT selector was connected to the outdoor unit in "7. FIELD WIRING", set the dip switch (DS1) on the outdoor unit PC-board (A1P) to "ON" (it is set to "OFF" when shipped from the factory).

For the position of the dip switch (DS1), see the "Service Precautions" label (see at right) which is attached to the EL. COMPO. BOX lid.

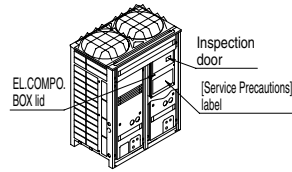

⚠ WARNING ⚠ ELECTRIC SHOCK WARNING

Never perform with the power on. There is a serious risk of electric shock if any live part is touched.

12-2 Onsite Settings With the Power On

Use the push button switches (BS1 through BS5) on the outdoor unit PC-board (A1P) to make the necessary onsite settings.

See the "Service Precautions" label on the EL. CONPO. BOX lid for details on the positions and operating method of the push button switches and on the onsite setting.

Make sure to record the setting on the accessory "REQUEST FOR THE INDICATION" label.

⚠ WARNING ⚠ ELECTRIC SHOCK WARNING

Use an insulated rod to operate the push buttons via the inspection door of EL. COMPO. BOX lid. There is a risk of electric shock if you touch any live parts, since this operation must be performed with the power on.

13. TEST RUN

13-1 Before test run

- Make sure the following works are completed in accordance with the installation manual.
 - Piping work
 - Wiring work
 - Air tight test
 - Vacuum drying
 - Additional refrigerant charge
- Check that all work for the indoor unit are finished and there are no danger to operate.

13-2 Test Run

After check operation is completed, operate the unit normally and check the following.

- Make sure the indoor and outdoor units are operating normally.
- Operate each indoor unit one by one and make sure the corresponding outdoor unit is also operating.
- Check to see if cold (or hot) air is coming out from the indoor unit.
- Push the fan direction and strength buttons on the remote controller to see if they operate properly.

Note

- Heating is not possible if the outdoor temperature is 24°C or higher. Refer to the Operation manual.
- If a knocking sound can be heard in the liquid compression of the compressor, stop the unit immediately and then energize the crank case heater for a sufficient length of time before restarting the operation.
- Once stopping, the compressor will not restart in about 5 minutes even if the On/Off button of the remote controller is pushed.
- When the system operation is stopped by the remote controller, the outdoor units may continue operating for further 5 minutes at maximum.
- The outdoor unit fan may rotate at low speeds if the Night-time low noise setting or the External low noise level setting is made, but this is not a malfunction.

13-3 Checks After Test Run

Perform the following checks after the test run is complete.

- Record the contents of field setting.
 - Record them on the accessory "REQUEST FOR THE INDICATION" label. And attach the label on the back side of the front panel.
- Record the installation date.
 - Record the installation date on the accessory "REQUEST FOR THE INDICATION" label in accordance with the IEC60335-2-40. And attach the label on the back side of the front panel.

Note

After the test run, when handing the unit over to the customer, make sure the EL.COMPO.BOX lid, the inspection door, and the unit casing are all attached.

14. CAUTION FOR REFRIGERANT LEAKS

(Points to note in connection with refrigerant leaks)

Introduction

The installer and system specialist shall secure safety against leakage according to local regulations or standards. The following standards may be applicable if local regulations are not available.

The VRV System, like other air conditioning systems, uses R410A as refrigerant. R410A itself is an entirely safe non-toxic, non-combustible refrigerant. Nevertheless care must be taken to ensure that air conditioning facilities are installed in a room which is sufficiently large. This assures that the maximum concentration level of refrigerant gas is not exceeded, in the unlikely event of major leak in the system and this in accordance to the local applicable regulations and standards.

Maximum concentration level

The maximum charge of refrigerant and the calculation of the maximum concentration of refrigerant is directly related to the humanly occupied space in to which it could leak.

The unit of measurement of the concentration is kg/m³ (the weight in kg of the refrigerant gas in 1m³ volume of the occupied space).

Compliance to the local applicable regulations and standards for the maximum allowable concentration level is required.

In Australia the maximum allowed concentration level of refrigerant to a humanly space is limited to 0.35kg/m³ for R407C and 0.44kg/m³ for R410A.

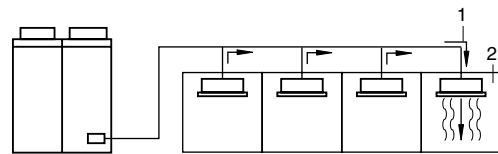

- direction of the refrigerant flow
- room where refrigerant leak has occurred (outflow of all the refrigerant from the system)

Pay a special attention to the place, such as a basement, etc. where refrigerant can stay, since refrigerant is heavier than air.

Procedure for checking maximum concentration

Check the maximum concentration level in accordance with steps 1 to 4 below and take whatever action is necessary to comply.

- Calculate the amount of refrigerant (kg) charged to each system separately.

amount of refrigerant in a single unit system (amount of refrigerant with which the system is charged before leaving the factory)	+	additional charging amount (amount of refrigerant added locally in accordance with the length or diameter of the refrigerant piping)	=	total amount of refrigerant (kg) in the system
-----------------------------------------------------------------------------------------------------------------------------------	---	--------------------------------------------------------------------------------------------------------------------------------------	---	------------------------------------------------

Note

- Where a single refrigerant facility is divided into 2 entirely independent refrigerant systems then use the amount of refrigerant with which each separate system is charged.

2. Calculate the smallest room volume (m³)
 In case like the following, calculate the volume of (A), (B) as a single room or as the smallest room.

A. Where there are no smaller room divisions

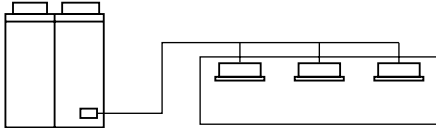

B. Where there is a room division but there is an opening between the rooms sufficiently large to permit a free flow of air back and forth.

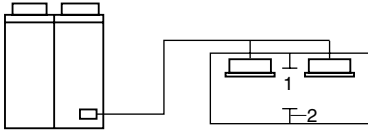

1. opening between rooms
2. partition

(Where there is an opening without a door or where there are openings above and below the door which are each equivalent in size to 0.15% or more of the floor area.)

3. Calculating the refrigerant density using the results of the calculations in steps 1 and 2 above.

$$\frac{\text{total volume of refrigerant in the refrigerant system}}{\text{size (m}^3\text{) of smallest room in which there is an indoor unit installed}} \leq \text{maximum concentration level (kg/m}^3\text{)}$$

If the result of the above calculation exceeds the maximum concentration level then make similar calculations for the second then third smallest room and so until the result falls short of the maximum concentration.

4. Dealing with the situations where the result exceeds the maximum concentration level.
 Where the installation of a facility results in a concentration in excess of the maximum concentration level then it will be necessary to revise the system. Please consult your Daikin supplier.

