

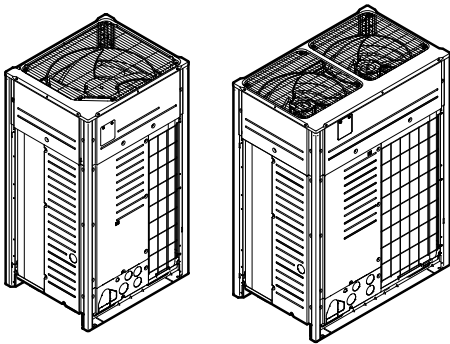

Installation and operation manual

VRV IV+ heat recovery



VRV IV⁺

REYQ8U7Y1B
REYQ10U7Y1B
REYQ12U7Y1B
REYQ14U7Y1B
REYQ16U7Y1B
REYQ18U7Y1B
REYQ20U7Y1B

REMQ5U7Y1B

Installation and operation manual
VRV IV+ heat recovery

English

Table of contents

Table of contents

1 About the documentation 5

- 1.1 About this document..... 5

For the installer 5

2 About the box 5

- 2.1 To remove the accessories from the outdoor unit 5
- 2.2 Accessory pipes: Diameters..... 5
- 2.3 To remove the transportation stay (only for 14+16 HP) 6
- 2.4 To remove the transportation stay (only for 18+20 HP) 6

3 About the units and options 6

- 3.1 About the outdoor unit..... 6
- 3.2 System layout..... 6

4 Preparation 7

- 4.1 Preparing the installation site 7
 - 4.1.1 Installation site requirements of the outdoor unit 7
 - 4.1.2 Additional installation site requirements of the outdoor unit in cold climates 7
- 4.2 Preparing refrigerant piping..... 7
 - 4.2.1 Refrigerant piping requirements..... 7
 - 4.2.2 To select the piping size 8
 - 4.2.3 To select refrigerant branch kits..... 9
 - 4.2.4 Multiple outdoor units: Possible layouts..... 9
- 4.3 Preparing electrical wiring 10
 - 4.3.1 About electrical compliance 10
 - 4.3.2 Safety device requirements 10

5 Installation 11

- 5.1 Opening the units 11
 - 5.1.1 To open the outdoor unit..... 11
 - 5.1.2 To open the electrical component box of the outdoor unit 11
- 5.2 Mounting the outdoor unit..... 11
 - 5.2.1 To provide the installation structure 11
- 5.3 Connecting the refrigerant piping 12
 - 5.3.1 To route the refrigerant piping..... 12
 - 5.3.2 To connect the refrigerant piping to the outdoor unit .. 12
 - 5.3.3 To connect the multi connection piping kit 12
 - 5.3.4 Multiple outdoor units: Knockout holes 13
 - 5.3.5 To protect against contamination..... 13
 - 5.3.6 Using the stop valve and service port..... 13
 - 5.3.7 To remove the pinched pipes..... 13
- 5.4 Checking the refrigerant piping 14
 - 5.4.1 About checking the refrigerant piping 14
 - 5.4.2 Checking refrigerant piping: General guidelines 14
 - 5.4.3 Checking refrigerant piping: Setup..... 15
 - 5.4.4 To perform a leak test..... 15
 - 5.4.5 To perform vacuum drying 15
- 5.5 To insulate the refrigerant piping..... 15
- 5.6 Charging refrigerant 16
 - 5.6.1 Precautions when charging refrigerant 16
 - 5.6.2 About charging refrigerant 16
 - 5.6.3 To determine the additional refrigerant amount..... 16
 - 5.6.4 To charge refrigerant: Flow chart..... 17
 - 5.6.5 To charge refrigerant 19
 - 5.6.6 Step 6a: To automatically charge refrigerant..... 20
 - 5.6.7 Step 6b: To manually charge refrigerant..... 21
 - 5.6.8 Error codes when charging refrigerant..... 21
 - 5.6.9 Checks after charging refrigerant..... 21
 - 5.6.10 To fix the fluorinated greenhouse gases label 21
- 5.7 Connecting the electrical wiring..... 21
 - 5.7.1 Field wiring: Overview..... 21
 - 5.7.2 Guidelines when knocking out knockout holes 22

- 5.7.3 To route and fix the transmission wiring 22
- 5.7.4 To connect the transmission wiring..... 22
- 5.7.5 To finish the transmission wiring..... 23
- 5.7.6 To route and fix the power supply 23
- 5.7.7 To connect the power supply 23

6 Configuration 24

- 6.1 Making field settings..... 24
 - 6.1.1 About making field settings..... 24
 - 6.1.2 Field setting components 24
 - 6.1.3 To access the field setting components..... 24
 - 6.1.4 To access mode 1 or 2 25
 - 6.1.5 To use mode 1 25
 - 6.1.6 To use mode 2 25
 - 6.1.7 Mode 1: Monitoring settings..... 25
 - 6.1.8 Mode 2: Field settings..... 26
 - 6.1.9 To connect the PC configurator to the outdoor unit 27
- 6.2 Using the leak detection function 27
 - 6.2.1 About automatic leak detection..... 27

7 Commissioning 27

- 7.1 Precautions when commissioning 27
- 7.2 Checklist before commissioning 27
- 7.3 About the test run 28
- 7.4 To perform a test run..... 28
- 7.5 Correcting after abnormal completion of the test run 29

8 Troubleshooting 29

- 8.1 Solving problems based on error codes 29
- 8.2 Error codes: Overview 29

9 Technical data 33

- 9.1 Service space: Outdoor unit 33
- 9.2 Piping diagram: Outdoor unit..... 34
- 9.3 Wiring diagram: Outdoor unit 36

For the user 38

10 About the system 38

- 10.1 System layout..... 38

11 User interface 38

12 Operation 38

- 12.1 Operation range 38
- 12.2 Operating the system 38
 - 12.2.1 About operating the system 38
 - 12.2.2 About cooling, heating, fan only, and automatic operation 39
 - 12.2.3 About the heating operation..... 39
 - 12.2.4 To operate the system (WITHOUT cool/heat changeover remote control switch)..... 39
 - 12.2.5 To operate the system (WITH cool/heat changeover remote control switch)..... 39
- 12.3 Using the dry program 39
 - 12.3.1 About the dry program 39
 - 12.3.2 To use the dry program (WITHOUT cool/heat changeover remote control switch)..... 40
 - 12.3.3 To use the dry program (WITH cool/heat changeover remote control switch)..... 40
- 12.4 Adjusting the air flow direction..... 40
 - 12.4.1 About the air flow flap 40
- 12.5 Setting the master user interface 40
 - 12.5.1 About setting the master user interface 40

13 Maintenance and service 41

- 13.1 About the refrigerant..... 41
- 13.2 After-sales service and warranty 41
 - 13.2.1 Warranty period 41
 - 13.2.2 Recommended maintenance and inspection..... 41

14 Troubleshooting 41

14.1 Error codes: Overview 42

14.2 Symptoms that are NOT system malfunctions 43

14.2.1 Symptom: The system does not operate 43

14.2.2 Symptom: Cool/Heat cannot be changed over 43

14.2.3 Symptom: Fan operation is possible, but cooling and heating do not work..... 43

14.2.4 Symptom: The fan speed does not correspond to the setting 43

14.2.5 Symptom: The fan direction does not correspond to the setting 43

14.2.6 Symptom: White mist comes out of a unit (Indoor unit) 43

14.2.7 Symptom: White mist comes out of a unit (Indoor unit, outdoor unit) 43

14.2.8 Symptom: The user interface display reads "U4" or "U5" and stops, but then restarts after a few minutes. 43

14.2.9 Symptom: Noise of air conditioners (Indoor unit) 43

14.2.10 Symptom: Noise of air conditioners (Indoor unit, outdoor unit) 43

14.2.11 Symptom: Noise of air conditioners (Outdoor unit) 43

14.2.12 Symptom: Dust comes out of the unit 44

14.2.13 Symptom: The units can give off odours..... 44

14.2.14 Symptom: The outdoor unit fan does not spin 44

14.2.15 Symptom: The display shows "88" 44

14.2.16 Symptom: The compressor in the outdoor unit does not stop after a short heating operation 44

14.2.17 Symptom: The inside of an outdoor unit is warm even when the unit has stopped 44

14.2.18 Symptom: Hot air can be felt when the indoor unit is stopped 44

15 Relocation 44

16 Disposal 44

1 About the documentation

1.1 About this document

Target audience



INFORMATION

This appliance is intended to be used by expert or trained users in shops, in light industry and on farms, or for commercial use by lay persons.

Documentation set

This document is part of a documentation set. The complete set consists of:

- **General safety precautions:**
 - Safety instructions that you must read before installing
 - Format: Paper (in the box of the outdoor unit)
- **Outdoor unit installation and operation manual:**
 - Installation and operation instructions
 - Format: Paper (in the box of the outdoor unit)
- **Installer and user reference guide:**
 - Preparation of the installation, reference data,...
 - Detailed step-by-step instructions and background information for basic and advanced usage
 - Format: Digital files on <http://www.daikineurope.com/support-and-manuals/product-information/>

Latest revisions of the supplied documentation may be available on the regional Daikin website or via your dealer.

The original documentation is written in English. All other languages are translations.

Technical engineering data

- A **subset** of the latest technical data is available on the regional Daikin website (publicly accessible).
- The **full set** of latest technical data is available on the Daikin extranet (authentication required).

For the installer

2 About the box

2.1 To remove the accessories from the outdoor unit

Make sure that all accessories are available in the unit.

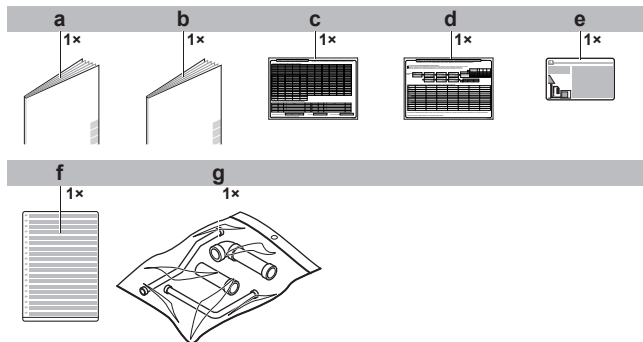





a General safety precautions
b Installation manual and operation manual

- c** Additional refrigerant charge label
- d** Installation information sticker
- e** Fluorinated greenhouse gases label
- f** Multilingual fluorinated greenhouse gases label
- g** Piping accessory bag

2.2 Accessory pipes: Diameters

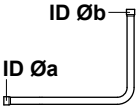
Accessory pipes (mm)	HP	Øa	Øb	
Gas pipe	5	25.4	19.1	
	8			
	Front connection	10	22.2	28.6
		12		
	Bottom connection	14		
		16		
		18	31.8	41.4
		20		
		18+20 ^(a)		

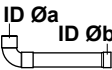
3 About the units and options

Accessory pipes (mm)	HP	Øa	Øb		
Liquid pipe ▪ Front connection 	5	12.7	9.5		
	8				
	10				
	12				
	14				
	16				
	18				
▪ Bottom connection 	20	15.9			
	20	15.9			
High pressure/low pressure gas pipe ▪ Front connection 	5	19.1	15.9		
	8				
	10				
	12				
	14				
	16				
	18				
	20				
	▪ Bottom connection 			18	22.2
				20	28.6

(a) Only in combination with the outdoor unit multi-connection piping kit.

2.3 To remove the transportation stay (only for 14+16 HP)

The transportation stays for protecting the unit during transport must be removed. Proceed as shown in the figure and procedure below.

NOTICE

If the unit is operated with the transportation stay attached, abnormal vibration or noise may be generated.

- 1 Slightly loosen the bolt (a).
- 2 Remove the transportation stay (b) as shown in the figure below.
- 3 Tighten the bolt (a) again.

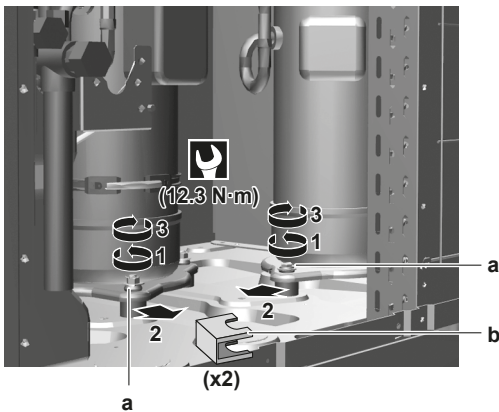

2.4 To remove the transportation stay (only for 18+20 HP)

The transportation stays for protecting the unit during transport must be removed. Proceed as shown in the figure and procedure below.

NOTICE

If the unit is operated with the transportation stay attached, abnormal vibration or noise may be generated.

- 1 Slightly loosen the bolt (a).

- 2 Remove the transportation stay (b) as shown in the figure below.
- 3 Tighten the bolt (a) again.
- 4 Slightly loosen the bolt (c).
- 5 Remove the bolt (d) of the transportation stay (e).
- 6 Remove the transportation stay (e) as shown in the figure below.
- 7 Tighten the bolt (c) again.

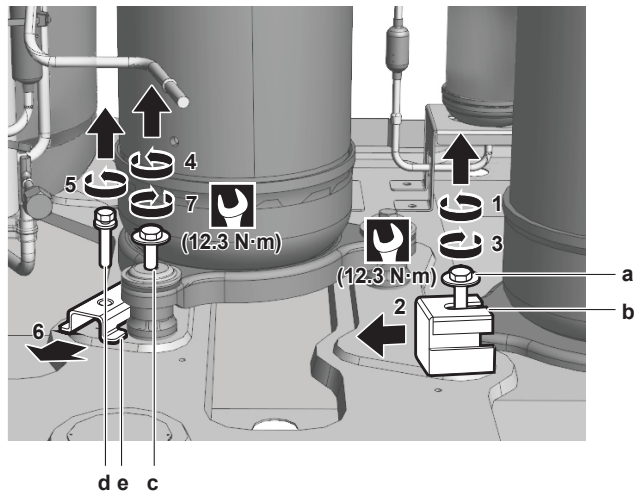

3 About the units and options

3.1 About the outdoor unit

This installation manual concerns the VRV IV, full inverter driven, heat recovery system.

Model line up:

Model	Description
REYQ8~20	Heat recovery model for single or multi-use
REMQ5	Heat recovery model for multi-use only

Depending on the type of outdoor unit which is chosen, some functionality will or will not exist. It will be indicated throughout this installation manual and brought to your attention. Certain features have exclusive model rights.

These units are intended for outdoor installation and aimed for heat pump applications including air to air and air to water applications.

These units have (in single use) heating capacities ranging from 25 to 63 kW and cooling capacities rating from 22.4 to 56 kW. In multi combination the heating capacity can go up till 168 kW and in cooling till 150 kW.

The outdoor unit is designed to work in heating mode at ambient temperatures from -20°C WB to 15.5°C WB and in cooling mode at ambient temperatures from -5°C DB to 43°C DB.

3.2 System layout

NOTICE

Design of the system must not be done at temperatures below -15°C.

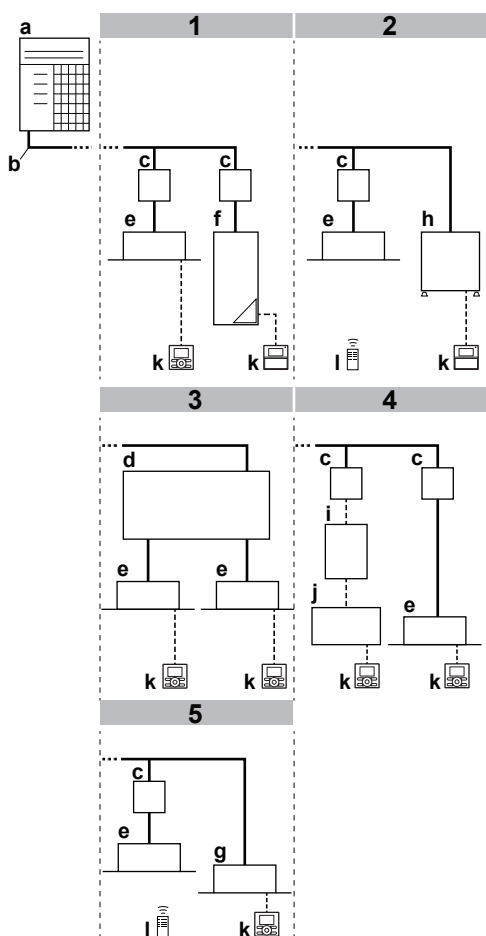

- a Outdoor unit
- b Refrigerant piping
- c BS unit
- d Multi BS unit
- e VRV DX indoor unit
- f LT Hydrobox unit
- g Cooling only VRV indoor unit
- h HT Hydrobox unit
- i EKEXV kit
- j AHU
- k User interface
- l Wireless user interface

4 Preparation

4.1 Preparing the installation site

4.1.1 Installation site requirements of the outdoor unit

Mind the spacing guidelines. See the "Technical data" chapter.



CAUTION

Appliance not accessible to the general public, install it in a secured area, protected from easy access.

This unit, both indoor and outdoor, is suitable for installation in a commercial and light industrial environment.



NOTICE

This is a class A product. In a domestic environment this product may cause radio interference in which case the user may be required to take adequate measures.

4.1.2 Additional installation site requirements of the outdoor unit in cold climates



NOTICE

When operating the unit in a low outdoor ambient temperature with high humidity conditions, make sure to take precautions to keep the drain holes of the unit free by using proper equipment.

In heating:

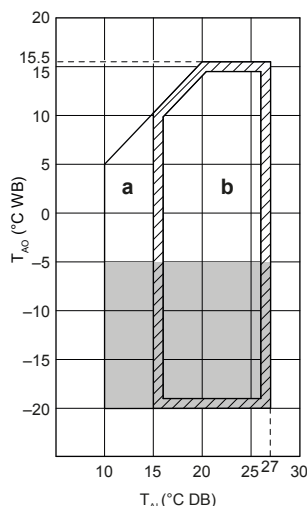

a Warming up operation range

b Operation range

T_{Ai} Ambient indoor temperature

T_{Ao} Ambient outdoor temperature

■ If the unit has to operate for 5 days in this area with high humidity (>90%), Daikin recommends to install the optional heater tape kit (EKBP012TA or EKBP020TA) to keep the drain holes free.

4.2 Preparing refrigerant piping

4.2.1 Refrigerant piping requirements



NOTICE

Refrigerant R410A requires strict cautions for keeping the system clean and dry. Foreign materials (including mineral oils or moisture) should be prevented from getting mixed into the system.



NOTICE

The piping and other pressure-containing parts shall be suitable for refrigerant. Use phosphoric acid deoxidised seamless copper for refrigerant.

- Only use phosphoric acid deoxidised seamless copper.
- Foreign materials inside pipes (including oils for fabrication) must be ≤30 mg/10 m.
- Temper grade: use piping with temper grade in function of the pipe diameter as listed in table below.

Pipe Ø	Temper grade of piping material
≤15.9 mm	O (annealed)
≥19.1 mm	1/2H (half hard)

- All piping lengths and distances have been taken into consideration (see About the piping length in the installer reference guide).

4 Preparation

4.2.2 To select the piping size

Determine the proper size using the following tables and reference figure (only for indication).

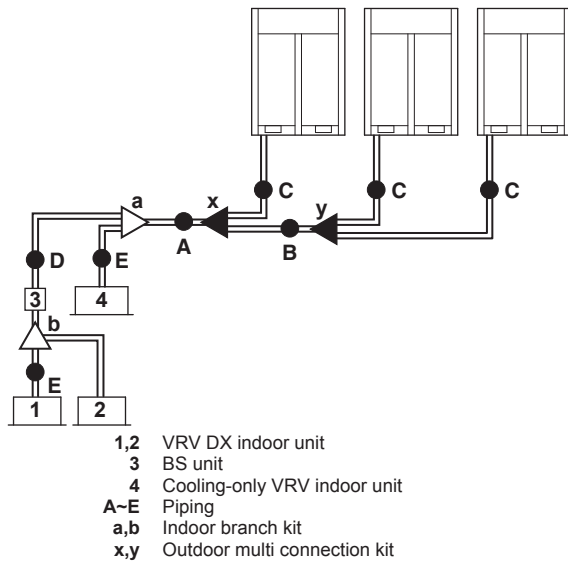

A, B, C: Piping between outdoor unit and (first) refrigerant branch kit

Choose from the following table in accordance with the outdoor unit total capacity type, connected downstream.

Outdoor unit capacity type (HP)	Piping outer diameter size (mm)		
	Liquid pipe	Suction gas pipe	High pressure/low pressure gas pipe
5~8	9.5	19.1	15.9
10	9.5	22.2	19.1
12	12.7	28.6	19.1
14~16	12.7	28.6	22.2
18	15.9	28.6	22.2
20~22	15.9	28.6	28.6
24	15.9	34.9	28.6
26~34	19.1	34.9	28.6
36	19.1	41.3	28.6
38~54	19.1	41.3	34.9

D: Piping between refrigerant branch kits or refrigerant branch kit and BS unit

Choose from the following table in accordance with the indoor unit total capacity type, connected downstream. Do not let the connection piping exceed the refrigerant piping size chosen by the general system model name.

Indoor unit capacity index	Piping outer diameter size (mm)		
	Liquid pipe	Suction gas pipe	High pressure/low pressure gas pipe
<150	9.5	15.9	12.7
150≤x<200		19.1	15.9
200≤x<290		22.2	19.1
290≤x<420	12.7	28.6	28.6
420≤x<640	15.9		
640≤x<920	19.1	34.9	28.6
≥920		41.3	

Example:

- Downstream capacity for E=[capacity index of unit 1]
- Downstream capacity for D=[capacity index of unit 1]+[capacity index of unit 2]

E: Piping between refrigerant branch kit or BS unit and indoor unit

Pipe size for direct connection to indoor unit must be the same as the connection size of the indoor unit (in case indoor unit is VRV DX indoor or Hydrobox).

Indoor unit capacity index	Piping outer diameter size (mm)	
	Gas pipe	Liquid pipe
15~50	12.7	6.4
63~140	15.9	9.5
200	19.1	
250	22.2	

- If a size-up of the piping is required, refer to the table below.

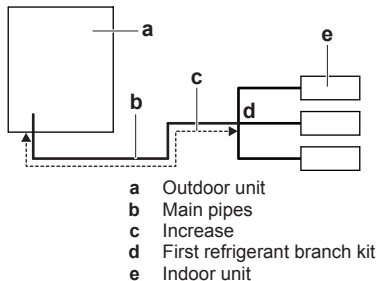

Size up	
HP class	Liquid piping outer diameter size (mm)
5~8	9.5 → 12.7
10	
12+14	12.7 → 15.9
16	
18~22	15.9 → 19.1
24	
26~34	19.1 → 22.2
36~54	

- The pipe thickness of the refrigerant piping shall comply with the applicable legislation. The minimal pipe thickness for R410A piping must be in accordance with the table below.

Pipe Ø (mm)	Minimal thickness t (mm)
6.4/9.5/12.7	0.80
15.9	0.99
19.1/22.2	0.80
28.6	0.99

Pipe Ø (mm)	Minimal thickness t (mm)
34.9	1.21
41.3	1.43

- In case the required pipe sizes (inch sizes) are not available, it is also allowed to use other diameters (mm sizes), taken the following into account:
 - Select the pipe size nearest to the required size.
 - Use the suitable adapters for the change-over from inch to mm pipes (field supply).
 - The additional refrigerant calculation has to be adjusted as mentioned in "5.6.3 To determine the additional refrigerant amount" on page 16.

4.2.3 To select refrigerant branch kits

Refrigerant refnets

For piping example, refer to "4.2.2 To select the piping size" on page 8.

- When using refnet joints at the first branch counted from the outdoor unit side, choose from the following table in accordance with the capacity of the outdoor unit (example: refnet joint a).

Outdoor unit capacity type (HP)	3 pipes
8+10	KHRQ23M29T9
12~22	KHRQ23M64T
24~54	KHRQ23M75T

- For refnet joints other than the first branch (example refnet joint b), select the proper branch kit model based on the total capacity index of all indoor units connected after the refrigerant branch.

Indoor unit capacity index	3 pipes
<200	KHRQ23M20T
200≤x<290	KHRQ23M29T9
290≤x<640	KHRQ23M64T
≥640	KHRQ23M75T

- Concerning refnet headers, choose from the following table in accordance with the total capacity of all the indoor units connected below the refnet header.

Indoor unit capacity index	3 pipes
<200	KHRQ23M29H
200≤x<290	
290≤x<640	KHRQ23M64H ^(a)
≥640	KHRQ23M75H

(a) If the pipe size above the refnet header is Ø34.9 or more, KHRQ23M75H is required.

i INFORMATION

Maximum 8 branches can be connected to a header.

- How to choose an outdoor multi connection piping kit. Choose from the following table in accordance with the number of outdoor units.

Number of outdoor units	Branch kit name
2	BHFQ23P907
3	BHFQ23P1357

i INFORMATION

Reducers or T-joints are field supplied.

! NOTICE

Refrigerant branch kits can only be used with R410A.

4.2.4 Multiple outdoor units: Possible layouts

- The piping between the outdoor units must be routed level or slightly upward to avoid the risk of oil retention into the piping.

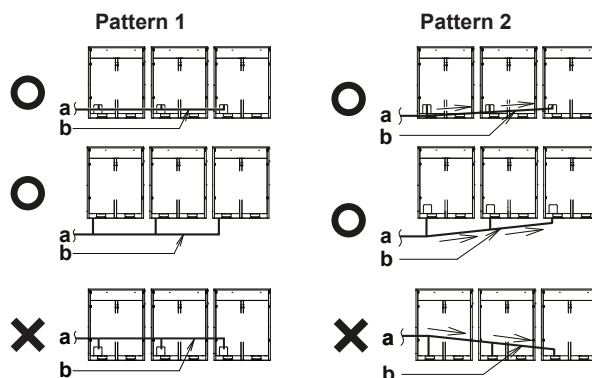

- a To indoor unit
- b Piping between outdoor units
- X Not allowed (oil remains in piping)
- O Allowed

- To avoid the risk of oil retention to the outmost outdoor unit, always connect the stop valve and the piping between outdoor units as shown in the 4 correct possibilities of the figure below.

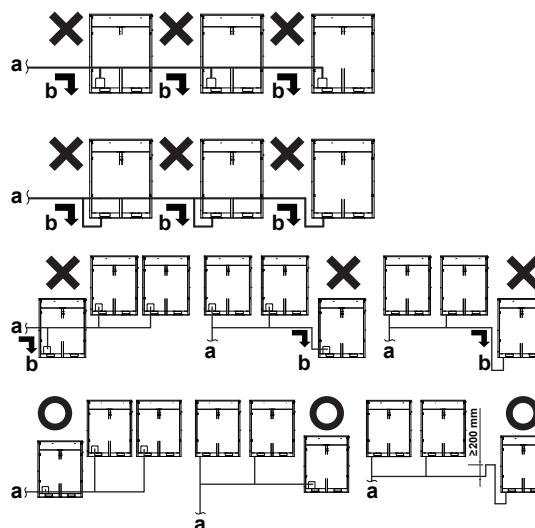
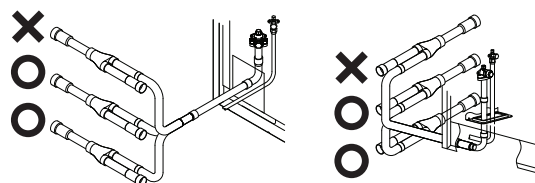

- a To indoor unit
- b Oil collects to the outmost outdoor unit when the system stops
- X Not allowed
- O Allowed

- If the piping length between the outdoor units exceeds 2 m, create a rise of 200 mm or more in the suction gas line and the high pressure/low pressure gas line within a length of 2 m from the kit.

If	Then
≤2 m	

4 Preparation

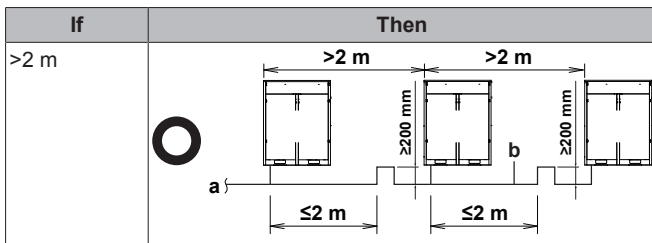

- a To indoor unit
b Piping between outdoor units



NOTICE

There are restrictions on the refrigerant pipe connection order between outdoor units during installation in case of a multiple outdoor unit system. Install according to following restrictions. The capacities of outdoor units A, B and C must fulfill the following restriction conditions: $A \geq B \geq C$.

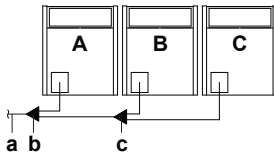

- a To indoor units
b Outdoor unit multi connecting piping kit (first branch)
c Outdoor unit multi connecting piping kit (second branch)

4.3 Preparing electrical wiring

4.3.1 About electrical compliance

This equipment complies with:

- EN/IEC 61000-3-11 provided that the system impedance Z_{sys} is less than or equal to Z_{max} at the interface point between the user's supply and the public system.
 - EN/IEC 61000-3-11 = European/International Technical Standard setting the limits for voltage changes, voltage fluctuations and flicker in public low-voltage supply systems for equipment with rated current ≤ 75 A.
 - It is the responsibility of the installer or user of the equipment to ensure, by consultation with the distribution network operator if necessary, that the equipment is connected only to a supply with a system impedance Z_{sys} less than or equal to Z_{max} .
- EN/IEC 61000-3-12 provided that the short-circuit power S_{sc} is greater than or equal to the minimum S_{sc} value at the interface point between the user's supply and the public system.
 - EN/IEC 61000-3-12 = European/International Technical Standard setting the limits for harmonic currents produced by equipment connected to public low-voltage systems with input current > 16 A and ≤ 75 A per phase.
 - It is the responsibility of the installer or user of the equipment to ensure, by consultation with the distribution network operator if necessary, that the equipment is connected only to a supply with a short-circuit power S_{sc} greater than or equal to the minimum S_{sc} value.

Single outdoor unit		
Model	$Z_{max}(\Omega)$	Minimum S_{sc} value (kVA)
REMQ5	—	2893
REYQ8	—	2893
REYQ10	—	3954
REYQ12	—	4313
REYQ14	—	4852

Single outdoor unit		
Model	$Z_{max}(\Omega)$	Minimum S_{sc} value (kVA)
REYQ16	—	5391
REYQ18	—	6289
REYQ20	—	7009

Multiple outdoor units		
Model	$Z_{max}(\Omega)$	Minimum S_{sc} value (kVA)
REYQ10	—	5786
REYQ13	—	5786
REYQ16	—	5786
REYQ18	—	6846
REYQ20	—	7206
REYQ22	—	8266
REYQ24	—	8284
REYQ26	—	9165
REYQ28	—	9704
REYQ30	—	10602
REYQ32	—	10781
REYQ34	—	11680
REYQ36	—	12399
REYQ38	—	13495
REYQ40	—	14556
REYQ42	—	14735
REYQ44	—	15094
REYQ46	—	15634
REYQ48	—	16172
REYQ50	—	17071
REYQ52	—	17969
REYQ54	—	18868



INFORMATION

Multi units are standard combinations.

4.3.2 Safety device requirements

The power supply must be protected with the required safety devices, i.e. a main switch, a slow blow fuse on each phase and an earth leakage protector in accordance with the applicable legislation.

For standard combinations

Selection and sizing of the wiring should be done in accordance with the applicable legislation based on the information mentioned in the table below.

Single outdoor unit		
Model	Minimum circuit ampacity	Recommended fuses
REMQ5	16.1 A	20 A
REYQ8	16.1 A	20 A
REYQ10	22.0 A	25 A
REYQ12	24.0 A	32 A
REYQ14	27.0 A	32 A
REYQ16	31.0 A	40 A
REYQ18	35.0 A	40 A
REYQ20	39.0 A	50 A

For all models:

- Phase and frequency: 3N~ 50 Hz
- Voltage: 380~415 V
- Transmission line section: 0.75~1.25 mm², maximum length is 1000 m. If the total transmission wiring exceeds these limits, it may result in communication error.

For non-standard combinations

Calculate the recommended fuse capacity.

Formula	Calculate, by adding the minimum circuit amps of each used unit (according to the table above), multiply the result by 1.1 and select the next higher recommended fuse capacity.
Example	<p>Combining the REYQ30 by using the REYQ8, REYQ10, and REYQ12.</p> <ul style="list-style-type: none"> Minimum circuit ampacity of the REYQ8=16.1 A Minimum circuit ampacity of the REYQ10=22.0 A Minimum circuit ampacity of the REYQ12=24.0 A <p>Accordingly, the minimum circuit ampacity of the REYQ30=16.1+22.0+24.0=62.1 A</p> <p>Multiply the above result by 1.1 ⇒ (62.1 A×1.1)=68.3 A, so the recommended fuse capacity would be 80 A.</p>



NOTICE

When using residual current operated circuit breakers, be sure to use a high-speed type 300 mA rated residual operating current.

5 Installation

5.1 Opening the units

5.1.1 To open the outdoor unit



DANGER: RISK OF ELECTROCUTION



DANGER: RISK OF BURNING

To gain access to the unit, front plates need to be opened as follows:

5~12 HP

14~20 HP

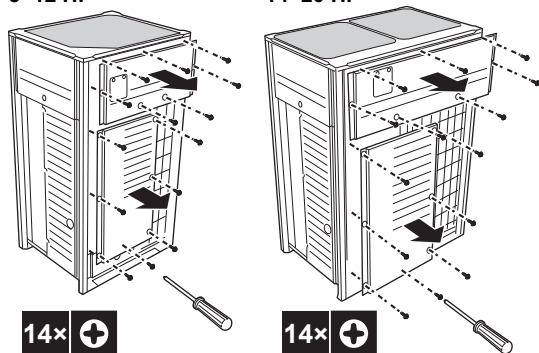

Once the front plates open, the electrical component box can be accessed. See "5.1.2 To open the electrical component box of the outdoor unit" on page 11.

For service purposes, the pushbuttons on the main PCB need to be accessed. To access these pushbuttons, the electrical component box cover does not need to be opened. See "6.1.3 To access the field setting components" on page 24.

5.1.2 To open the electrical component box of the outdoor unit



NOTICE

Do NOT apply excessive force when opening the electronic component box cover. Excessive force can deform the cover, resulting in entering of water to cause equipment failure.

5~12 HP

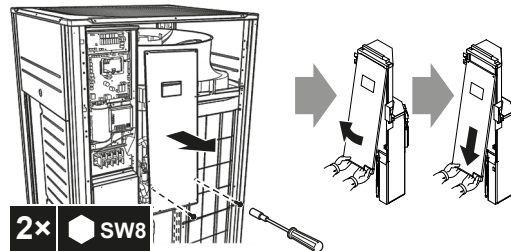

14~20 HP

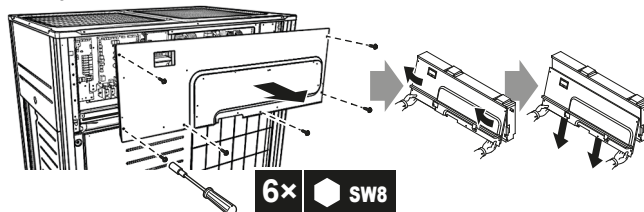

NOTICE

When closing the electrical component box cover, make sure that the sealing material on the lower back side of the cover is NOT caught and bend towards the inside.

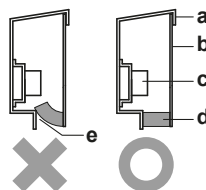

a Electrical component box cover

b Front side

c Power supply terminal block

d Sealing material

e Moisture and dirt could enter

X Not allowed

O Allowed

5.2 Mounting the outdoor unit

5.2.1 To provide the installation structure

Make sure the unit is installed level on a sufficiently strong base to prevent vibration and noise.



NOTICE

- When the installation height of the unit needs to be increased, do NOT use stands to only support the corners.
- Stands under the unit must be at least 100 mm wide.

5 Installation

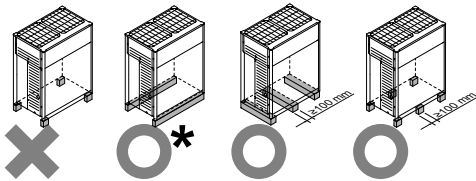

- X Not allowed
O Allowed (* = preferred installation)

- The height of the foundation must at least be 150 mm from the floor. In heavy snowfall areas, this height should be increased, depending on the installation place and condition.
- The preferred installation is on a solid longitudinal foundation (steel beam frame or concrete). The foundation must be larger than the grey marked area.

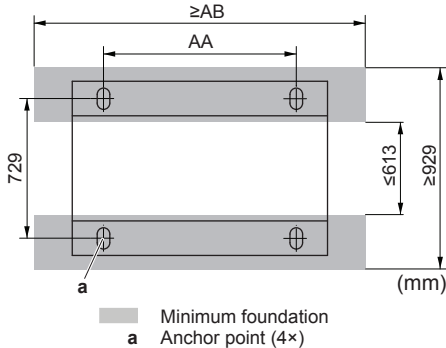

HP	AA	AB
5~12	766	992
14~20	1076	1302

- Fasten the unit in place using four foundation bolts M12. It is best to screw in the foundation bolts until their length remains 20 mm above the foundation surface.

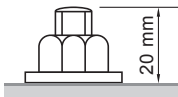

NOTICE

- Prepare a water drainage channel around the foundation to drain waste water from around the unit. During heating operation and when the outdoor temperatures are negative, the drained water from the outdoor unit will freeze up. If the water drainage is not taken care of, the area around the unit might be very slippery.
- When installed in a corrosive environment, use a nut with plastic washer (a) to protect the nut tightening part from rust.

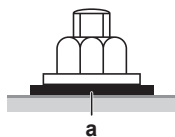

5.3 Connecting the refrigerant piping

5.3.1 To route the refrigerant piping

Installation of refrigerant piping is possible as front connection or side connection (when taken out from the bottom) as shown in the figure below.

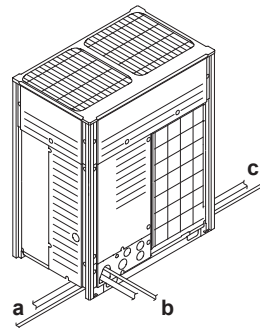

- a Left-side connection
b Front connection
c Right-side connection

For side connections, the knockout hole on the bottom plate should be removed:

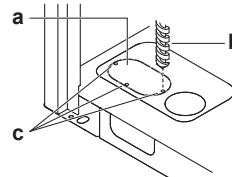

- a Large knockout hole
b Drill
c Points for drilling

NOTICE

Precautions when making knockout holes:

- Avoid damaging the casing.
- After making the knockout holes, we recommend you remove the burrs and paint the edges and areas around the edges using repair paint to prevent rusting.
- When passing electrical wiring through the knockout holes, wrap the wiring with protective tape to prevent damage.

5.3.2 To connect the refrigerant piping to the outdoor unit

NOTICE

- Be sure to use the supplied accessory pipes when carrying out piping work in the field.
- Be sure that the field installed piping does not touch other pipes, the bottom panel or side panel. Especially for the bottom and side connection, be sure to protect the piping with suitable insulation, to prevent it from coming into contact with the casing.

Connect the stop valves to the field piping using the accessory pipes supplied with the unit.

The connections to the branch kits are the responsibility of the installer (field piping).

5.3.3 To connect the multi connection piping kit

NOTICE

Improper installation may lead to malfunction of the outdoor unit.

- Install the joints horizontally, so that the caution label (a) attached to the joint comes to the top.
 - Do not tilt the joint more than 7.5° (see view A).
 - Do not install the joint vertically (see view B).

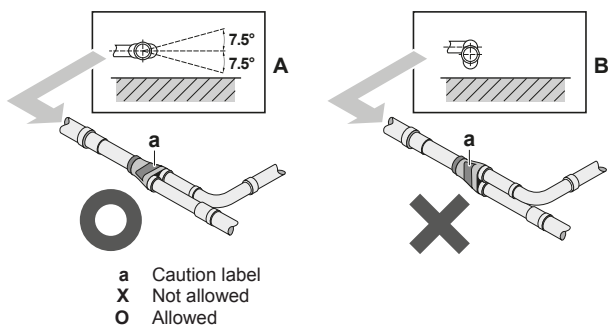

- Make sure that the total length of the piping connected to the joint is absolute straight for more than 500 mm. Only if a straight field piping of more than 120 mm is connected, more than 500 mm of straight section can be ensured.

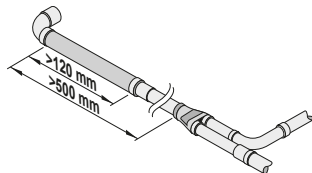

5.3.4 Multiple outdoor units: Knockout holes

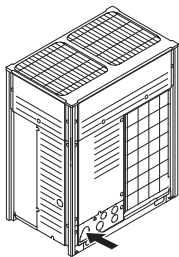
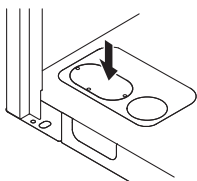
Connection	Description
Front connection	Remove the front plate knockout holes to connect. 
Bottom connection	Remove the knockout holes on the bottom frame and route the piping under the bottom. 

5.3.5 To protect against contamination

Seal the piping and wiring intake holes using sealing material (field supply), otherwise the capacity of the unit will drop and small animals may enter the machine.

5.3.6 Using the stop valve and service port

To handle the stop valve

- Make sure to keep all stop valves open during operation.
- The gas and liquid stop valves are factory closed.

To open/close the stop valve

- Remove the dust cap.
- Insert a hexagon wrench (liquid side: 4 mm, gas side: 8 mm) into the stop valve and turn the stop valve:

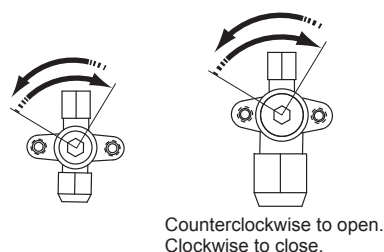

- Tighten the stop valve securely when opening or closing the stop valve. For the correct tightening torque value, refer to the table below.



NOTICE

Inadequate torque may cause leakage of refrigerant and breakage of the stop valve.

- Install the dust cap.

Result: The valve is now open/closed.

To handle the service port

- Always use a charge hose equipped with a valve depressor pin, since the service port is a Schrader type valve.
- After handling the service port, make sure to tighten the service port cover securely. For the tightening torque, refer to the table below.
- Check for refrigerant leaks after tightening the service port cover.

Tightening torques

Stop valve size (mm)	Tightening torque (when opening or closing)		
	Valve body	Hexagonal wrench	Service port
Ø9.5	5~7 N•m	4 mm	10.7~14.7
Ø12.7	8~10 N•m		
Ø15.9	14~16 N•m	6 mm	
Ø19.1	19~21 N•m	8 mm	
Ø25.4			

5.3.7 To remove the pinched pipes



WARNING

Any gas or oil remaining inside the stop valve may blow off the pinched piping.

Failure to observe the instructions in procedure below properly may result in property damage or personal injury, which may be serious depending on the circumstances.

Use the following procedure to remove the pinched piping:

- Make sure that the stop valves are fully closed.

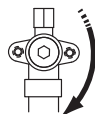

- Connect the vacuuming/recovery unit through a manifold to the service port of all stop valves.

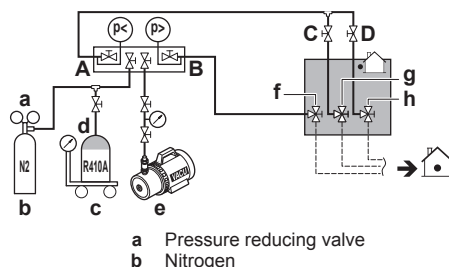

5 Installation

- c Weighing scales
- d Refrigerant R410A tank (siphon system)
- e Vacuum pump
- f Liquid line stop valve
- g Gas line stop valve
- h High pressure/low pressure gas line stop valve
- A Valve A
- B Valve B
- C Valve C
- D Valve D

- 3 Recover gas and oil from the pinched piping by using a recovery unit.



CAUTION

Do not vent gases into the atmosphere.

- 4 When all gas and oil is recovered from the pinched piping, disconnect the charge hose and close the service ports.
- 5 Cut off the lower part of the liquid-, gas-, and high pressure/low pressure gas stop valve pipes along the black line. Use an appropriate tool (e.g. a pipe cutter).

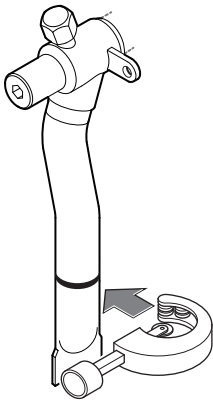

WARNING



Never remove the pinched piping by brazing.

Any gas or oil remaining inside the stop valve may blow off the pinched piping.

- 6 Wait until all oil has dripped out before continuing with the connection of the field piping in case the recovery was not complete.

5.4 Checking the refrigerant piping

5.4.1 About checking the refrigerant piping

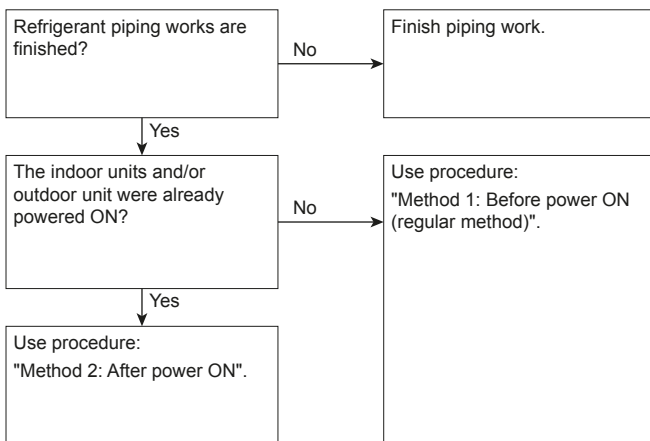

It is very important that all refrigerant piping work is done before the units (outdoor or indoor) are powered on.

When the units are powered on, the expansion valves will initialise. This means that they will close. Leak test and vacuum drying of field piping and indoor units is impossible when this happens.

Therefore, there will be explained 2 methods for initial installation, leak test and vacuum drying.

Method 1: Before power ON

If the system has not yet been powered on, no special action is required to perform the leak test and the vacuum drying.

Method 2: After power ON

If the system has already been powered on, activate setting [2-21] (refer to "6.1.4 To access mode 1 or 2" on page 25). This setting will open field expansion valves to guarantee a R410A piping pathway and make it possible to perform the leak test and the vacuum drying.



NOTICE

Make sure that all indoor units connected to the outdoor unit are powered on.



NOTICE

Wait to apply setting [2-21] until the outdoor unit has finished the initialisation.

Leak test and vacuum drying

Checking the refrigerant piping involves:

- Checking for any leakages in the refrigerant piping.
- Performing vacuum drying to remove all moisture, air or nitrogen in the refrigerant piping.

If there is a possibility of moisture being present in the refrigerant piping (for example, water may have entered the piping), first carry out the vacuum drying procedure below until all moisture has been removed.

All piping inside the unit has been factory tested for leaks.

Only field installed refrigerant piping needs to be checked. Therefore, make sure that all the outdoor unit stop valves are firmly closed before performing leak test or vacuum drying.



NOTICE

Make sure that all (field supplied) field piping valves are OPEN (not outdoor unit stop valves!) before you start leak test and vacuuming.

For more information on the state of the valves, refer to "5.4.3 Checking refrigerant piping: Setup" on page 15.

5.4.2 Checking refrigerant piping: General guidelines

Connect the vacuum pump through a manifold to the service port of all stop valves to increase efficiency (refer to "5.4.3 Checking refrigerant piping: Setup" on page 15).



NOTICE

Use a 2-stage vacuum pump with a non-return valve or a solenoid valve that can evacuate to a gauge pressure of -100.7 kPa (-1.007 bar)(5 Torr absolute).



NOTICE

Make sure the pump oil does not flow oppositely into the system while the pump is not working.



NOTICE

Do not purge the air with refrigerants. Use a vacuum pump to evacuate the installation.

5.4.3 Checking refrigerant piping: Setup

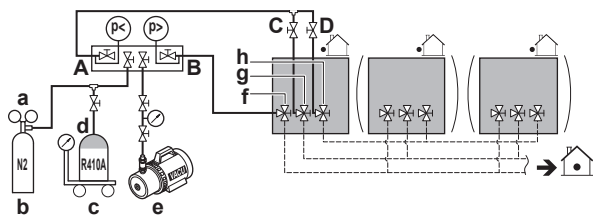

- a Pressure reducing valve
- b Nitrogen
- c Weighing scales
- d Refrigerant R410A tank (siphon system)
- e Vacuum pump
- f Liquid line stop valve
- g Gas line stop valve
- h High pressure/low pressure gas line stop valve
- A Valve A
- B Valve B
- C Valve C
- D Valve D

Valve	State of valve
Valve A	Open
Valve B	Open
Valve C	Open
Valve D	Open
Liquid line stop valve	Close
Gas line stop valve	Close
High pressure/low pressure gas line stop valve	Close



NOTICE

The connections to the indoor units and all indoor units should also be leak and vacuum tested. Keep any possible (field supplied) field piping valves open as well.

Refer to the indoor unit installation manual for more details. Leak test and vacuum drying should be done before the power supply is set to the unit. If not, see also the flow chart earlier described in this chapter (see "5.4.1 About checking the refrigerant piping" on page 14).

5.4.4 To perform a leak test

The leak test must satisfy the specifications of EN378-2.

To check for leaks: Vacuum leak test

- 1 Evacuate the system from the liquid and gas piping to -100.7 kPa (-1.007 bar) (5 Torr absolute) for more than 2 hours.
- 2 Once reached, turn off the vacuum pump and check that the pressure does not rise for at least 1 minute.
- 3 Should the pressure rise, the system may either contain moisture (see vacuum drying below) or have leaks.

To check for leaks: Pressure leak test

- 1 Break the vacuum by pressurising with nitrogen gas to a minimum gauge pressure of 0.2 MPa (2 bar). Never set the gauge pressure higher than the maximum operation pressure of the unit, i.e. 4.0 MPa (40 bar).
- 2 Test for leaks by applying a bubble test solution to all piping connections.
- 3 Discharge all nitrogen gas.



NOTICE

Make sure to use a recommended bubble test solution from your wholesaler. Do not use soap water, which may cause cracking of flare nuts (soap water may contain salt, which absorbs moisture that will freeze when the piping gets cold), and/or lead to corrosion of flared joints (soap water may contain ammonia which causes a corrosive effect between the brass flare nut and the copper flare).

5.4.5 To perform vacuum drying

To remove all moisture from the system, proceed as follows:

- 1 Evacuate the system for at least 2 hours to a target vacuum of -100.7 kPa (-1.007 bar) (5 Torr absolute).
- 2 Check that, with the vacuum pump turned off, the target vacuum is maintained for at least 1 hour.
- 3 Should you fail to reach the target vacuum within 2 hours or maintain the vacuum for 1 hour, the system may contain too much moisture. In that case, break the vacuum by pressurising with nitrogen gas to a gauge pressure of 0.05 MPa (0.5 bar) and repeat steps 1 to 3 until all moisture has been removed.
- 4 Depending on whether you want to immediately charge refrigerant through the refrigerant charge port or first pre-charge a portion of refrigerant through the liquid line, either open the outdoor unit stop valves, or keep them closed. See "5.6.2 About charging refrigerant" on page 16 for more information.

5.5 To insulate the refrigerant piping

After finishing the leak test and vacuum drying, the piping must be insulated. Take into account the following points:

- Make sure to insulate the connection piping and refrigerant branch kits entirely.
- Be sure to insulate the liquid and gas piping (for all units).
- Use heat resistant polyethylene foam which can withstand a temperature of 70°C for liquid piping and polyethylene foam which can withstand a temperature of 120°C for gas piping.
- Reinforce the insulation on the refrigerant piping according to the installation environment.

Ambient temperature	Humidity	Minimum thickness
$\leq 30^\circ\text{C}$	75% to 80% RH	15 mm
$> 30^\circ\text{C}$	$\geq 80\%$ RH	20 mm

Condensation might form on the surface of the insulation.

- If there is a possibility that condensation on the stop valve might drip down into the indoor unit through gaps in the insulation and piping because the outdoor unit is located higher than the indoor unit, this must be prevented by sealing up the connections. See below figure.

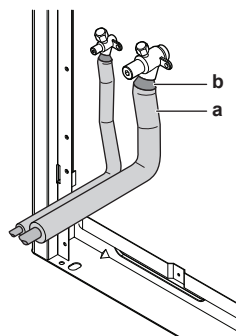

- a Insulation material
- b Caulking etc.

5 Installation

5.6 Charging refrigerant

5.6.1 Precautions when charging refrigerant



WARNING

- Only use R410A as refrigerant. Other substances may cause explosions and accidents.
- R410A contains fluorinated greenhouse gases. Its global warming potential (GWP) value is 2087.5. Do NOT vent these gases into the atmosphere.
- When charging refrigerant, always use protective gloves and safety glasses.



NOTICE

If the power of some units is turned off, the charging procedure cannot be finished properly.



NOTICE

In case of a multiple outdoor system, turn on the power of all outdoor units.



NOTICE

Be sure to turn on the power 6 hours before operation in order to have power running to the crankcase heater and to protect the compressor.



NOTICE

If operation is performed within 12 minutes after the indoor and outdoor units are turned on, the compressor will not operate before the communication is established in a correct way between outdoor unit(s) and indoor units.



NOTICE

Before starting charging procedures, check if the 7-segment display indication of the outdoor unit A1P PCB is as normal (see "6.1.4 To access mode 1 or 2" on page 25). If a malfunction code is present, see "8.1 Solving problems based on error codes" on page 29.



NOTICE

Make sure all connected indoor units are recognised (see [1-10] and [1-39] in "6.1.7 Mode 1: Monitoring settings" on page 25).



NOTICE

Close the front panel before any refrigerant charge operation is executed. Without the front panel attached the unit cannot judge correctly whether it is operating properly or not.



NOTICE

In case of maintenance and the system (outdoor unit+field piping+indoor units) does not contain any refrigerant any more (e.g., after refrigerant reclaim operation), the unit has to be charged with its original amount of refrigerant (refer to the nameplate on the unit) by pre-charging before the automatic charging function can be started.

5.6.2 About charging refrigerant

Once vacuum drying is finished, additional refrigerant charging can start.

There are two methods to charge additional refrigerant.

Method	See
Automatic charge	"5.6.6 Step 6a: To automatically charge refrigerant" on page 20

Method	See
Manual charge	"5.6.7 Step 6b: To manually charge refrigerant" on page 21



INFORMATION

Adding refrigerant using the automatic refrigerant charging function is not possible when Hydrobox units are connected to the system.

To speed up the refrigerant charging process, it is in case of larger systems recommended to first pre-charge a portion of refrigerant through the liquid line before proceeding with the actual automatic or manual charging. This step is included in below procedure (see "5.6.5 To charge refrigerant" on page 19). It can be skipped, but charging will take longer then.

A flow chart is available which gives an overview of the possibilities and actions to be taken (see "5.6.4 To charge refrigerant: Flow chart" on page 17).

5.6.3 To determine the additional refrigerant amount



INFORMATION

For final charge adjustment in the test laboratory, please contact your local dealer.



NOTICE

The refrigerant charge of the system must be less than 100 kg. This means that in case the calculated total refrigerant charge is equal to or more than 95 kg you must divide your multiple outdoor system into smaller independent systems, each containing less than 95 kg refrigerant charge. For factory charge, refer to the unit name plate.

Formula:

$$R = [(X_1 \times \text{Ø}22.2) \times 0.37 + (X_2 \times \text{Ø}19.1) \times 0.26 + (X_3 \times \text{Ø}15.9) \times 0.18 + (X_4 \times \text{Ø}12.7) \times 0.12 + (X_5 \times \text{Ø}9.5) \times 0.059 + (X_6 \times \text{Ø}6.4) \times 0.022] \times 1.04 + (A+B+C)$$

R Additional refrigerant to be charged [in kg and rounded off to 1 decimal place]

X₁₋₆ Total length [m] of liquid piping size at **Øa**

A~C Parameters A~C

Parameter A. If the total indoor unit capacity connection ratio (CR)>100%, charge an additional 0.5 kg of refrigerant per outdoor unit.

Parameter B. In case of a multi-outdoor-unit system, add the sum of the individual outdoor unit charge factors.

Model	B
REMQ5+REYQ8+	0 kg
REYQ10+REYQ12	
REYQ14	1.3 kg
REYQ16	1.4 kg
REYQ18	4.7 kg
REYQ20	4.8 kg

Parameter C. When using more than one multi BS unit, add the sum of the individual BS unit charge factors.

Model	C
BS1Q10	0.05 kg
BS1Q16	0.1 kg
BS1Q25	0.2 kg
BS4Q	0.3 kg
BS6Q	0.4 kg

Model	C
BS8Q	0.5 kg
BS10Q	0.7 kg
BS12Q	0.8 kg
BS16Q	1.1 kg

Metric piping. When using metric piping, replace the weight factors in the formula by the ones from the following table:

Inch piping		Metric piping	
Piping	Weight factor	Piping	Weight factor
Ø6.4 mm	0.022	Ø6 mm	0.018
Ø9.5 mm	0.059	Ø10 mm	0.065
Ø12.7 mm	0.12	Ø12 mm	0.097
Ø15.9 mm	0.18	Ø15 mm	0.16
		Ø16 mm	0.18
Ø19.1 mm	0.26	Ø18 mm	0.24
Ø22.2 mm	0.37	Ø22 mm	0.35

5.6.4 To charge refrigerant: Flow chart

For more information, see "5.6.5 To charge refrigerant" on page 19.

Pre-charging refrigerant

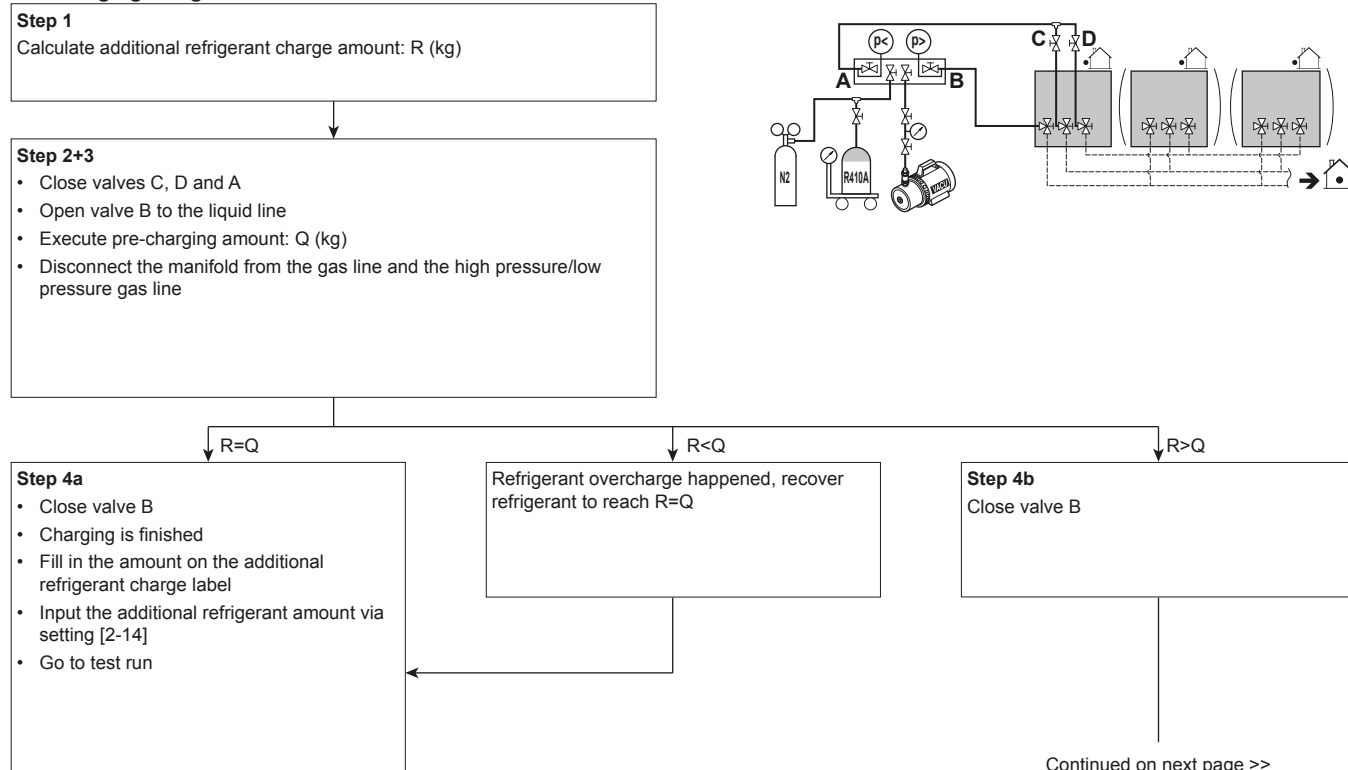

5 Installation

Charging refrigerant

<< Continuation of previous page

R>Q

Step 5

- Connect valve A to the refrigerant charge port (d)
- Open all outdoor unit stop valves

Step 6
Proceed with automatic or manual charge

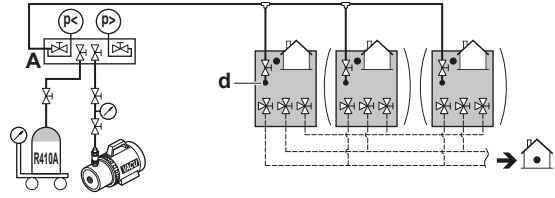

Automatic charge

Step 6a

- Push 1x BS2: "888"
- Push BS2 for more than 5 seconds "tQ !" pressure equalisation

Depending on ambient conditions, the unit will decide to perform autocharge operation in heating or cooling mode.

Continued on next page >>

Manual charge

Step 6b
Activate field setting [2-20]=1
Unit will start manual refrigerant charging operation.

- Open valve A
- Charge remaining amount of refrigerant P (kg)
 $R=Q+P$

- Close valve A
- Push BS3 to stop manual charging
- Charging is finished
- Fill in the amount on the additional refrigerant charge label
- Input the additional refrigerant amount via setting [2-14]
- Go to test run

<< Continuation of previous page

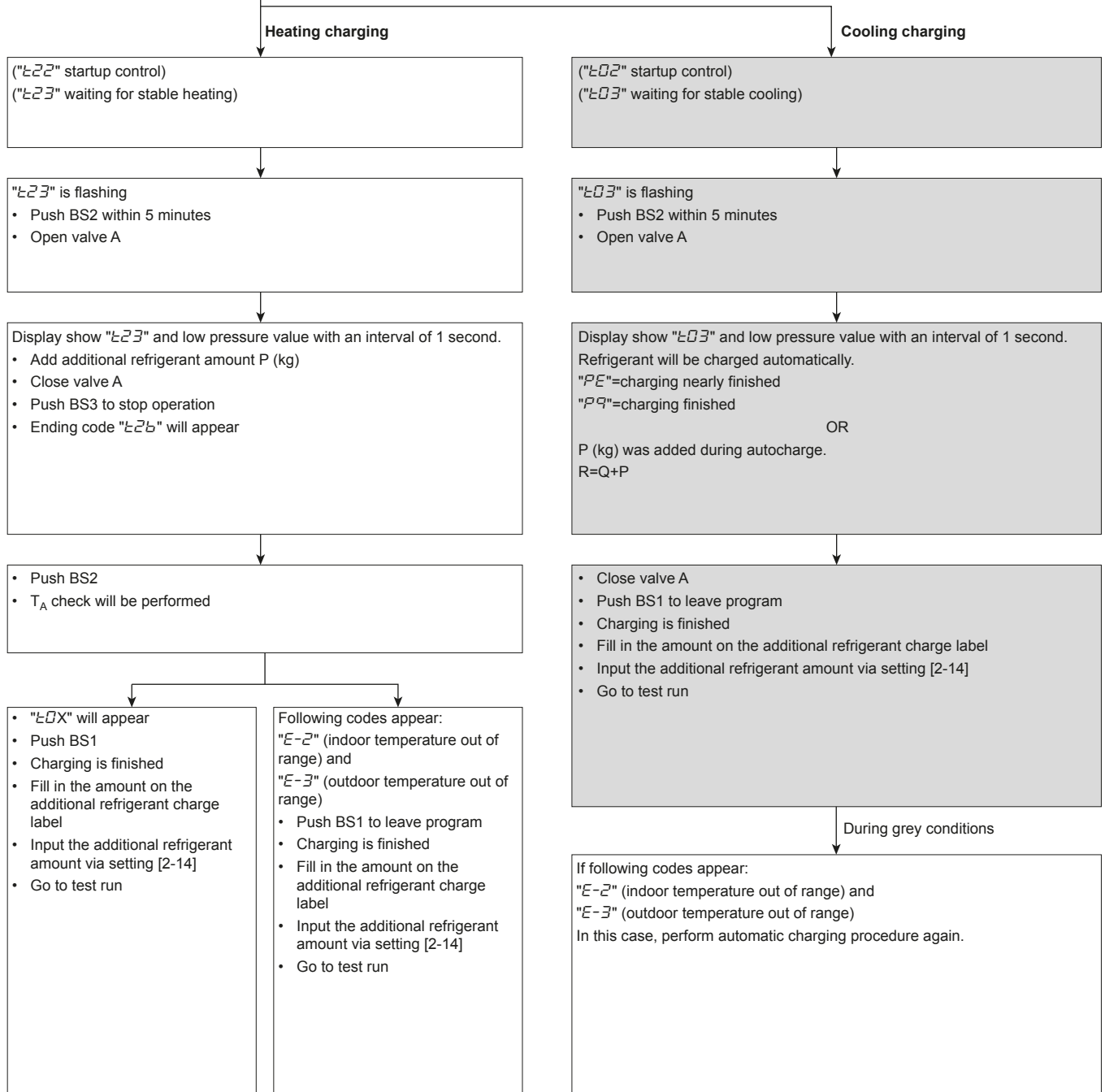

5.6.5 To charge refrigerant

Follow the steps as described below and take into account whether you want to use the automatic charge function or not.

Pre-charging refrigerant

- 1 Calculate the additional amount of refrigerant to be added using the formula mentioned in "5.6.3 To determine the additional refrigerant amount" on page 16.
- 2 The first 10 kg of additional refrigerant can be pre-charged without outdoor unit operation:

If	Then
The additional refrigerant amount is smaller than 10 kg	Perform steps 3~4.
The additional refrigerant charge is larger than 10 kg	Perform steps 3~6.

- 3 Pre-charging can be done without compressor operation, by connecting the refrigerant bottle to the service port of the liquid stop valve (open valve B). Make sure that all outdoor unit stop valves, as well as valves A, C, and D are closed.



NOTICE

During pre-charging, the refrigerant is charged through the liquid line only. Close valves C, D, and A and disconnect the manifold from the gas line and the high pressure/low pressure gas line.

5 Installation

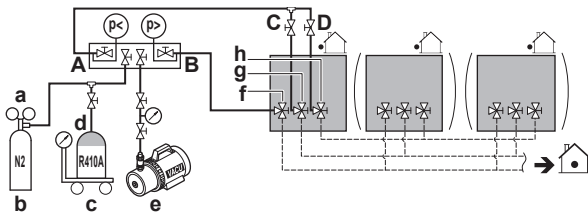

- a Pressure reducing valve
- b Nitrogen
- c Weighing scales
- d Refrigerant R410A tank (siphon system)
- e Vacuum pump
- f Liquid line stop valve
- g Gas line stop valve
- h High pressure/low pressure gas line stop valve
- A Valve A
- B Valve B
- C Valve C
- D Valve D

4 Do one of the following:

	If	Then
4a	The calculated additional refrigerant amount is reached by above pre-charging procedure	Close valve B and disconnect the manifold from the liquid line.
4b	The total amount of refrigerant could not be charged by pre-charging	Close valve B, disconnect the manifold from the liquid line, and perform steps 5~6.

i INFORMATION

If the total additional refrigerant amount was reached in step 4 (by pre-charging only), record the amount of refrigerant that was added on the additional refrigerant charge label provided with the unit and attach it on the back side of the front panel.

Additionally, input the additional refrigerant amount into the system via setting [2-14].

Perform the test procedure as described in "7 Commissioning" on page 27.

Charging refrigerant

5 After pre-charging, connect valve A to the refrigerant charge port and charge the remaining additional refrigerant through this port. Open all outdoor unit stop valves. At this point, valve A must remain closed!

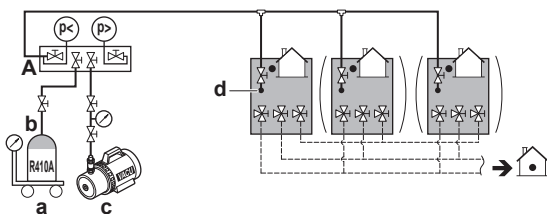

- a Weighing scales
- b Refrigerant R410A tank (siphon system)
- c Vacuum pump
- d Refrigerant charge port
- A Valve A

i INFORMATION

For a multi outdoor unit system, it is not required to connect all charge ports to a refrigerant tank.

The refrigerant will be charged with ± 22 kg in 1 hour time at an outdoor temperature of 30°C DB or with ± 6 kg at an outdoor temperature of 0°C DB.

If you need to speed up in case of a multiple outdoor system, connect the refrigerant tanks to each outdoor unit.

! NOTICE

- The refrigerant charging port is connected to the piping inside the unit. The unit's internal piping is already factory charged with refrigerant, so be careful when connecting the charge hose.
- After adding the refrigerant, do not forget to close the lid of the refrigerant charging port. The tightening torque for the lid is 11.5 to 13.9 N·m.
- In order to ensure uniform refrigerant distribution, it may take the compressor ± 10 minutes to start up after the unit has started operation. This is not a malfunction.

6 Proceed with one of the following:

6a	"5.6.6 Step 6a: To automatically charge refrigerant" on page 20
6b	"5.6.7 Step 6b: To manually charge refrigerant" on page 21

i INFORMATION

After charging refrigerant:

- Record the additional refrigerant amount on the refrigerant label provided with the unit and attach it to the backside of the front panel.
- Input the additional refrigerant amount into the system via setting [2-14].
- Perform the test procedure described in "7 Commissioning" on page 27.

5.6.6 Step 6a: To automatically charge refrigerant

i INFORMATION

The automatic refrigerant charging has limits as described below. Out of these limits, the system cannot operate the automatic refrigerant charging:

- Outdoor temperature: $0\sim 43^{\circ}\text{C}$ DB.
- Indoor temperature: $10\sim 32^{\circ}\text{C}$ DB.
- Total indoor unit capacity: $\geq 80\%$.

When "E23" or "E03" starts flashing (ready for charging), push BS2 within 5 minutes. Open valve A. If BS2 is not pushed within 5 minutes, a malfunction code will appear:

If	Then
Heating operation	"E2E" will be flashing. Push BS2 to restart the procedure.
Cooling operation	Malfunction code "P2" will appear. Push BS1 to abort and restart the procedure.

Test run including detailed refrigerant status check is required to use the leak detection functionality. More information, see "7 Commissioning" on page 27.

If	Then
"E01", "E02", or "E03" appears	Push BS1 to finish the automatic charging function procedure. The ambient conditions are favourable to execute the test run.
"E-2", or "E-3" appears	The ambient conditions are NOT favourable to execute the test run. Push BS1 to finish the automatic charging procedure.

i INFORMATION

In case a malfunction code occurred during this automatic charging procedure, the unit will stop and indicate "E2E" flashing. Push BS2 to restart the procedure.

i INFORMATION

- When a malfunction is detected during the procedure (e.g., in case of closed stop valve), a malfunction code will be displayed. In that case, refer to ["8.1 Solving problems based on error codes" on page 29](#) and solve the malfunction accordingly. Resetting the malfunction can be done by pushing BS1. The procedure can be restarted from ["5.6.6 Step 6a: To automatically charge refrigerant" on page 20](#).
- Aborting the automatic refrigerant charge is possible by pushing BS1. The unit will stop and return to idle condition.

5.6.7 Step 6b: To manually charge refrigerant**i** INFORMATION

The manual refrigerant charge operation will automatically stop within 30 minutes. If charging is not completed after 30 minutes, perform the additional refrigerant charging operation again.

i INFORMATION

- When a malfunction is detected during the procedure (e.g., in case of closed stop valve), a malfunction code will be displayed. In that case, refer to ["5.6.8 Error codes when charging refrigerant" on page 21](#) and solve the malfunction accordingly. Resetting the malfunction can be done by pushing BS3. The procedure can be restarted from ["5.6.7 Step 6b: To manually charge refrigerant" on page 21](#).
- Aborting the manual refrigerant charge is possible by pushing BS3. The unit will stop and return to idle condition.

5.6.8 Error codes when charging refrigerant

Code	Cause	Solution
P2	Unusual low pressure on suction line	Close valve A immediately. Push BS3 to reset. Check following items before retrying autocharge procedure: <ul style="list-style-type: none"> Check if all gas-side stop valves are opened correctly. Check if the valve of the refrigerant cylinder is opened. Check if the air inlet and outlet of the indoor unit are not obstructed.
P8	Freeze-up prevention indoor unit	Close valve A immediately. Push BS3 to reset. Retry autocharge procedure.
E-2	Indoor unit is out of temperature range for leak detection operation	Retry when ambient conditions are satisfied.
E-3	Outdoor unit is out of temperature range for leak detection operation	Retry when ambient conditions are satisfied.
E-5	Indicates an indoor unit which is not compatible with leak detection functionality is installed (e.g. Hydrobox units, ...)	Refer to requirements to be able to execute leak detection operation.

Code	Cause	Solution
Other malfunction code	—	Close valve A immediately. Confirm the malfunction code and take corresponding action, "8.1 Solving problems based on error codes" on page 29 .

5.6.9 Checks after charging refrigerant

- Are all stop valves open?
- Is the amount of refrigerant, that has been added, recorded on the refrigerant charge label?

**NOTICE**

Make sure to open all stop valves after (pre-) charging the refrigerant.

Operating with the stop valves closed will damage the compressor.

5.6.10 To fix the fluorinated greenhouse gases label

- Fill in the label as follows:

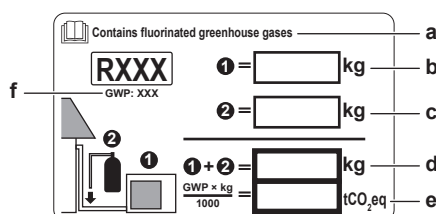

- If a multilingual fluorinated greenhouse gases label is delivered with the unit (see accessories), peel off the applicable language and stick it on top of a.
- Factory refrigerant charge: see unit name plate
- Additional refrigerant amount charged
- Total refrigerant charge
- Quantity of fluorinated greenhouse gases** of the total refrigerant charge expressed as tonnes CO₂ equivalent.
- GWP = Global warming potential

**NOTICE**

Applicable legislation on **fluorinated greenhouse gases** requires that the refrigerant charge of the unit is indicated both in weight and CO₂ equivalent.

Formula to calculate the quantity in CO₂ equivalent tonnes: GWP value of the refrigerant × total refrigerant charge [in kg] / 1000

Use the GWP value mentioned on the refrigerant charge label. That GWP is based on the latest IPCC Assessment report. The GWP mentioned in the manual might be outdated.

- Fix the label on the inside of the outdoor unit near the gas and liquid stop valves.

5.7 Connecting the electrical wiring**5.7.1 Field wiring: Overview**

Field wiring consists of power supply (always including earth) and indoor-outdoor communication (= transmission) wiring.

Example:

5 Installation

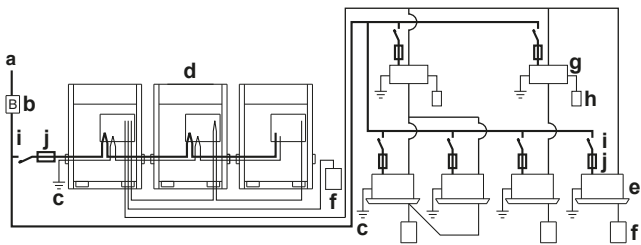

- a Field power supply (with earth leakage protector)
- b Main switch
- c Earth connection
- d Outdoor unit
- e Indoor unit
- f User interface
- g BS unit
- h Cool/heat selector
- i Circuit breaker
- j Fuse
- Power supply 3N~ 50 Hz
- Power supply 1~ 50 Hz
- Earth wiring

5.7.2 Guidelines when knocking out knockout holes

- To punch a knockout hole, hit on it with a hammer.
- After knocking out the holes, we recommend removing any burrs and paint the edges and areas around the holes using repair paint to prevent rusting.
- When passing electrical wiring through the knockout holes, prevent damage to the wires by wrapping the wiring with protective tape, putting the wires through field supplied protective wire conduits at that location, or install suitable field supplied wire nipples or rubber bushings into the knockout holes.

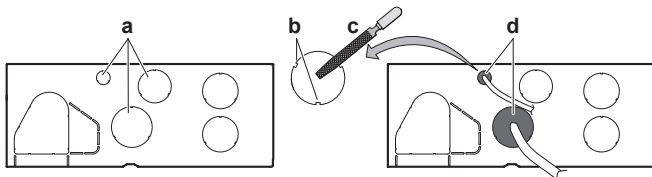

- a Knockout hole
- b Burr
- c Remove burrs
- d If there are any possibilities that small animals enter the system through the knockout holes, close the holes with packing materials (to be prepared on-site)

5.7.3 To route and fix the transmission wiring

Transmission wiring can be routed through the front side only. Fix it to the upper mounting hole.

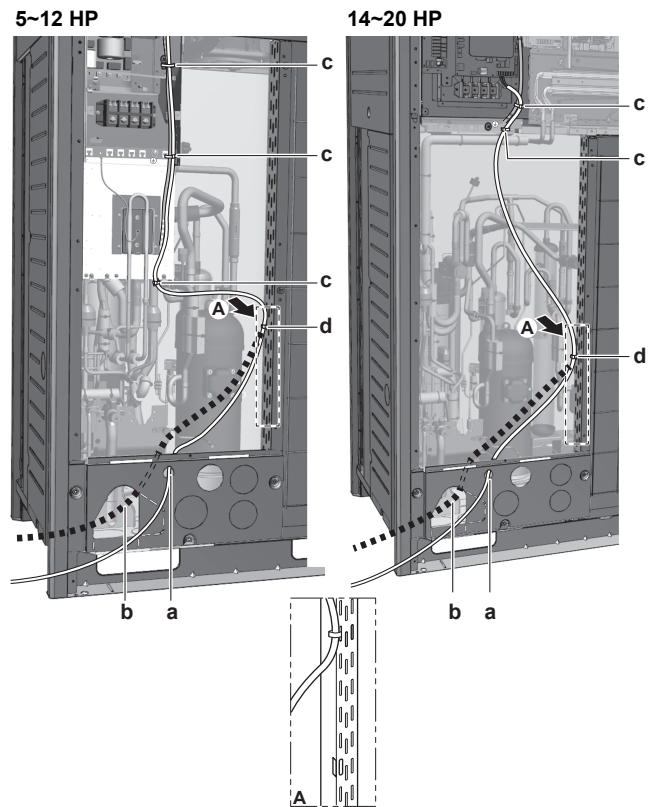

- a Transmission wiring (possibility 1)^(a)
- b Transmission wiring (possibility 2)^(a). Fix to pipe insulation with tie wraps.
- c Tie wrap. Fix to factory-mounted low voltage wiring.
- d Tie wrap.

(a) Knockout hole has to be removed. Close the hole to avoid small animals or dirt from entering.

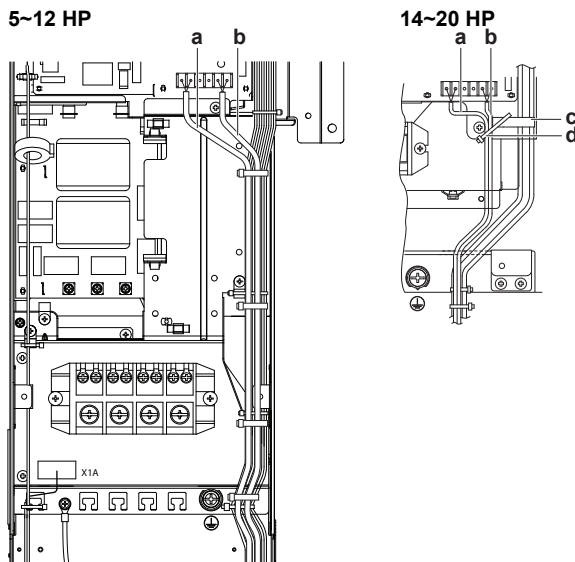

Fix to the indicated plastic brackets using field supplied clamping material.

- a Wiring between the units (indoor-outdoor) (F1/F2 left)
- b Internal transmission wiring (Q1/Q2)
- c Plastic bracket
- d Field supplied clamps

5.7.4 To connect the transmission wiring

The wiring from the indoor units must be connected to the F1/F2 (In-Out) terminals on the PCB in the outdoor unit.

Tightening torque for the transmission wiring terminal screws:

Screw size	Tightening torque (N·m)
M3.5 (A1P)	0.8~0.96

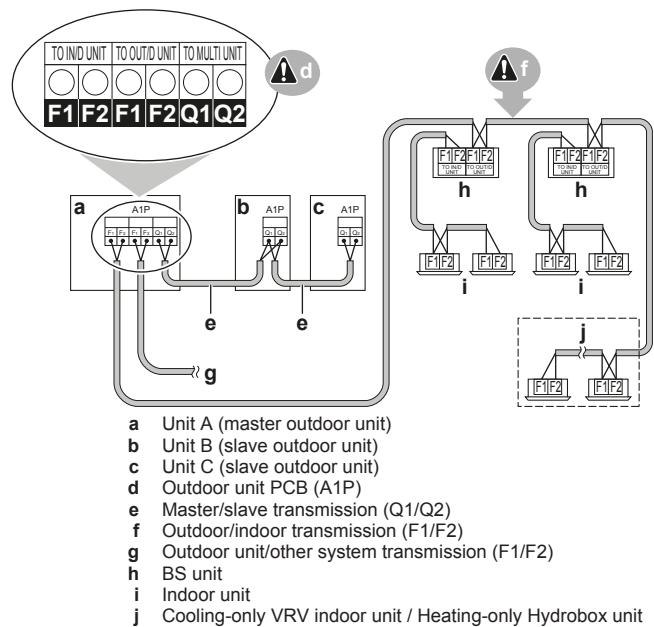

INFORMATION

U-series units cannot share the same refrigerant circuit with T-series units. However, electrically, U-series units and T-series units can be connected via F1/F2.

- The interconnecting wiring between the outdoor units in the same piping system must be connected to the Q1/Q2 (Out Multi) terminals. Connecting the wires to the F1/F2 terminals results in system malfunction.
- The wiring for the other systems must be connected to the F1/F2 (Out-Out) terminals of the PCB in the outdoor unit to which the interconnecting wiring for the indoor units is connected.
- The base unit is the outdoor unit to which the interconnecting wiring for the indoor units is connected.

5.7.5 To finish the transmission wiring

After installing the transmission wires inside the unit, wrap them along with the on-site refrigerant pipes using finishing tape, as shown in figure below.

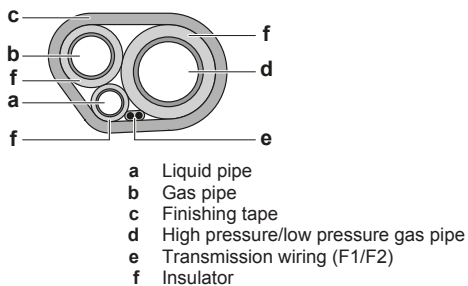

5.7.6 To route and fix the power supply

NOTICE

When routing earth wires, secure clearance of 25 mm or more away from compressor lead wires. Failure to observe this instruction properly may adversely affect correct operation of other units connected to the same earth.

The power supply wiring can be routed from the front and left side. Fix it to the lower mounting hole.

5~12 HP

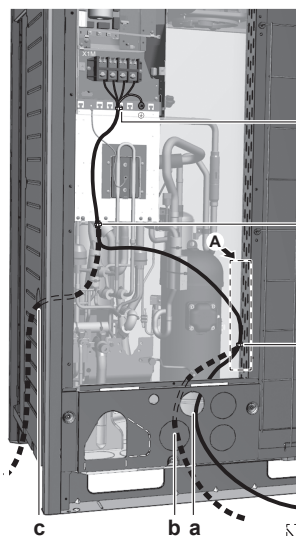

14~20 HP

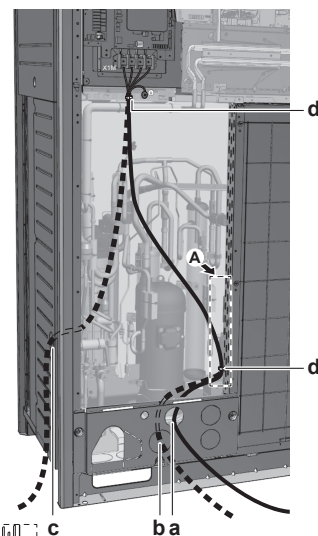

- a Power supply (possibility 1)^(a)
- b Power supply (possibility 2)^(a)
- c Power supply (possibility 3)^(a). Use conduit.
- d Tie wrap

(a) Knockout hole has to be removed. Close the hole to avoid small animals or dirt from entering.

5.7.7 To connect the power supply

The power supply MUST be clamped to the plastic bracket using field supplied clamp material to prevent external force being applied to the terminal. The green and yellow striped wire MUST be used for earthing only.

5~12 HP

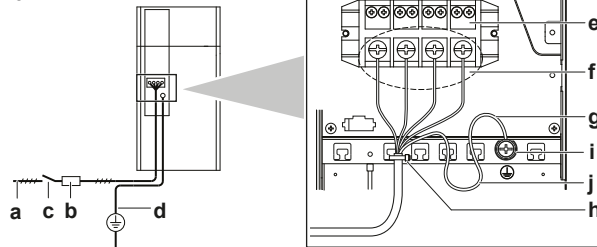

14~20 HP

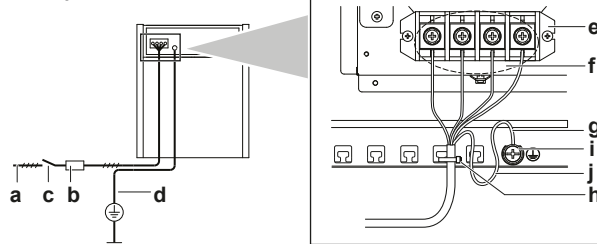

- a Power supply (380~415 V, 3N~ 50 Hz)
- b Fuse
- c Earth leakage protector
- d Earth wire
- e Power supply terminal block
- f Connect each power wire: RED to L1, WHT to L2, BLK to L3 and BLU to N
- g Earth wire (GRN/YLW)
- h Tie wrap
- i Cup washer

6 Configuration

- j When connecting the earth wire, it is recommended to perform curling.

Multiple outdoor units

To connect the power supply for multiple outdoor units to each other, ring tongues have to be used. No bare cable can be used.

In that case, the ring washer that is installed by default should be removed.

Attach both cables to the power supply terminal as indicated below:

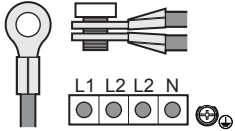

6 Configuration



INFORMATION

It is important that all information in this chapter is read sequentially by the installer and that the system is configured as applicable.



DANGER: RISK OF ELECTROCUTION

6.1 Making field settings

6.1.1 About making field settings

To continue the configuration of the VRV IV heat recovery system, it is required to give some input to the PCB of the unit. This chapter will describe how manual input is possible by operating the push buttons on the PCB and reading the feedback from the 7-segment displays.

Making settings is done via the master outdoor unit.

Next to making field settings it is also possible to confirm the current operation parameters of the unit.

Push buttons

Performing special actions (automatic refrigerant charge, test run, etc.) and making field settings (demand operation, low noise, etc.) happens by way of operating the push buttons.

See also:

- "6.1.2 Field setting components" on page 24
- "6.1.3 To access the field setting components" on page 24

PC configurator

For VRV IV heat recovery system it is alternatively possible to make several commissioning field settings through a personal computer interface (for this, option EKPCCAB is required). The installer can prepare the configuration (off-site) on PC and afterwards upload the configuration to the system.

See also: "6.1.9 To connect the PC configurator to the outdoor unit" on page 27.

Mode 1 and 2

Mode	Description
Mode 1 (monitoring settings)	Mode 1 can be used to monitor the current situation of the outdoor unit. Some field setting contents can be monitored as well.

Mode	Description
Mode 2 (field settings)	<p>Mode 2 is used to change the field settings of the system. Consulting the current field setting value and changing the current field setting value is possible.</p> <p>In general, normal operation can be resumed without special intervention after changing field settings.</p> <p>Some field settings are used for special operation (e.g., 1 time operation, recovery/vacuuming setting, manual adding refrigerant setting, etc.). In such a case, it is required to abort the special operation before normal operation can restart. It will be indicated in below explanations.</p>

See also:

- "6.1.4 To access mode 1 or 2" on page 25
- "6.1.5 To use mode 1" on page 25
- "6.1.6 To use mode 2" on page 25
- "6.1.7 Mode 1: Monitoring settings" on page 25
- "6.1.8 Mode 2: Field settings" on page 26

6.1.2 Field setting components

Location of the 7-segment displays, buttons and DIP switches:

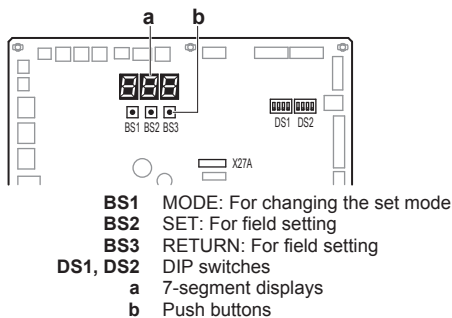

6.1.3 To access the field setting components

It is not required to open the complete electronic component box to access the push buttons on the PCB and read out the 7-segment display(s).

To access you can remove the front inspection cover of the front plate (see figure). Now you can open the inspection cover of the electrical component box front plate (see figure). You can see the three push buttons and the three 7-segment displays and DIP switches.

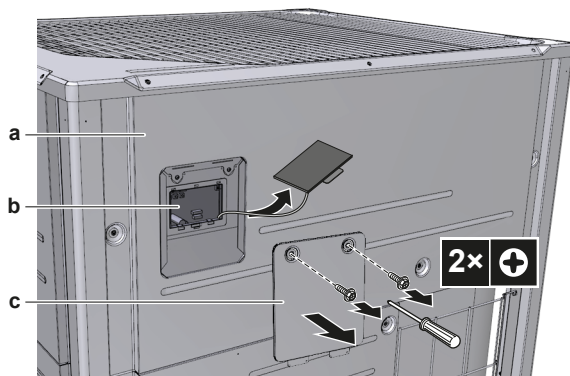

- a Front plate
 b Main PCB with 3 7-segment displays and 3 push buttons
 c Electrical component box service cover

Operate the switches and push buttons with an insulated stick (such as a closed ball-point pen) to avoid touching of live parts.



Make sure to re-attach the inspection cover into the electronic component box cover and to close the front plate's inspection cover after the job is finished. During operation of the unit the front plate of the unit should be attached. Settings are still possible to be made through the inspection opening.

NOTICE

Make sure that all outside panels, except for the service cover on the electrical component box, are closed while working.

Close the lid of the electrical component box firmly before turning on the power.

6.1.4 To access mode 1 or 2

Initialisation: default situation

NOTICE

Be sure to turn on the power 6 hours before operation in order to have power running to the crankcase heater and to protect the compressor.

Turn on the power supply of the outdoor unit and all indoor units. When the communication between indoor units and outdoor unit(s) is established and normal, the 7-segment display indication state will be as below (default situation when shipped from factory).

Stage	Display
When turning on the power supply: flashing as indicated. First checks on power supply are executed (1~2 min).	
When no trouble occurs: lighted as indicated (8~10 min).	
Ready for operation: blank display indication as indicated.	

7-segment display indications:

	Off
	Blinking
	On

When above situation cannot be confirmed after 12 min, the malfunction code can be checked on the indoor unit user interface and the outdoor unit 7-segment display. Solve the malfunction code accordingly. The communication wiring should be checked at first.

Access

BS1 is used to change the mode you want to access.

Access	Action
Mode 1	Push BS1 one time. 7-segment display indication changes to:
Mode 2	Push BS1 for at least 5 seconds. 7-segment display indication changes to:

INFORMATION

If you get confused in the middle of the process, push BS1. Then it returns to idle situation (no indication on 7-segment displays: blank, refer to "6.1.4 To access mode 1 or 2" on page 25.

6.1.5 To use mode 1

Mode 1 is used to set basic settings and to monitor the status of the unit.

What	How
Changing and accessing the setting in mode 1	Once mode 1 is selected (push BS1 one time), you can select the wanted setting. It is done by pushing BS2. Accessing the selected setting's value is done by pushing BS3 one time.
To quit and return to the initial status	Press BS1.

6.1.6 To use mode 2

The master unit should be used to input field settings in mode 2.

Mode 2 is used to set field settings of the outdoor unit and system.

What	How
Changing and accessing the setting in mode 2	Once mode 2 is selected (push BS1 for more than 5 seconds), you can select the wanted setting. It is done by pushing BS2. Accessing the selected setting's value is done by pushing BS3 1 time.
To quit and return to the initial status	Press BS1.
Changing the value of the selected setting in mode 2	<ul style="list-style-type: none"> Once mode 2 is selected (push BS1 for more than 5 seconds) you can select the wanted setting. It is done by pushing BS2. Accessing the selected setting's value is done by pushing BS3 1 time. Now BS2 is used to select the required value of the selected setting. When the required value is selected, you can define the change of value by pushing BS3 1 time. Press BS3 again to start operation according to the chosen value.

6.1.7 Mode 1: Monitoring settings

[1-0]

Shows whether the unit you check is a master, slave 1 or slave 2 unit.

The master unit should be used to input field settings in mode 2.

[1-0]	Description
No indication	Undefined situation.
0	Outdoor unit is master unit.
1	Outdoor unit is slave 1 unit.
2	Outdoor unit is slave 2 unit.

[1-1]

Shows the status of low noise operation.

[1-1]	Description
0	Unit is currently not operating under low noise restrictions.
1	Unit is currently operating under low noise restrictions.

6 Configuration

[1-2]

Shows the status of power consumption limitation operation.

[1-2]	Description
0	Unit is currently not operating under power consumption limitations.
1	Unit is currently operating under power consumption limitation.

[1-5] [1-6]

Shows:

- [1-5]: The current T_e target parameter position.
- [1-6]: The current T_c target parameter position.

[1-10]

Show the total number of connected VRV and AHU indoor units.

[1-13]

Shows the total number of connected outdoor units (in case of multiple outdoor system).

[1-17] [1-18] [1-19]

Shows:

- [1-17]: The latest malfunction code.
- [1-18]: The 2nd last malfunction code.
- [1-19]: The 3rd last malfunction code.

[1-29] [1-30] [1-31]

Show the result of the leak detection function:

- $---$: No data.
- $E-r-$: Leak detection failure due to abnormal operation.
- αH : No leak detected.
- $\alpha \bar{C}$: Leak detected.

[1-34]

Shows the remaining days till the next automatic leak detection (if automatic leak detection function is activated).

[1-39]

Shows:

- The number of Hydrobox (HXY080/125 and HXHD) indoor units connected to the system.

[1-40] [1-41]

Shows:

- [1-40]: The current cooling comfort setting.
- [1-41]: The current heating comfort setting.

6.1.8 Mode 2: Field settings

[2-8]

T_e target temperature during cooling operation.

[2-8]	T_e target (°C)
0 (default)	Auto
2	6
3	7
4	8
5	9
6	10
7	11

[2-9]

T_c target temperature during heating operation.

[2-9]	T_c target (°C)
0 (default)	Auto
1	41
2	42
3	43
4	44
5	45
6	46

[2-14]

Input additional refrigerant amount that was charged.

In case you want to use the automatic leak detection functionality, it is required to input the total additional refrigerant charge amount.

[2-14]	Additional amount charged (kg)
0 (default)	No input
1	0<x<5
2	5<x<10
3	10<x<15
4	15<x<20
5	20<x<25
6	25<x<30
7	30<x<35
8	35<x<40
9	40<x<45
10	45<x<50
11	50<x<55
12	55<x<60
13	60<x<65
14	65<x<70
15	70<x<75
16	75<x<80
17	80<x<85
18	85<x<90
19	Setting cannot be used. Total refrigerant charge has to be <100 kg.
20	
21	

- For details concerning the calculation of additional refrigerant charge amount, see ["5.6.3 To determine the additional refrigerant amount" on page 16](#).

- For guidance concerning the input of the additional refrigerant charge amount and leak detection function see ["6.2 Using the leak detection function" on page 27](#).

[2-20]

Manual additional refrigerant charge.

[2-20]	Description
0 (default)	Deactivated.
1	Activated. To stop the manual additional refrigerant charge operation (when the required additional refrigerant amount is charged), push BS3. If this function was not aborted by pushing BS3, the unit will stop its operation after 30 minutes. If 30 minutes was not sufficient to add the needed refrigerant amount, the function can be reactivated by changing the field setting again.

[2-35]

Height difference setting.

[2-35]	Description
0	In case the outdoor unit is installed in the lowest position (indoor units are installed on a higher position than outdoor units) and the height difference between the highest indoor unit and the outdoor unit exceeds 40 m, the setting [2-35] should be changed to 0.
1 (default)	—

[2-45]

Technical cooling.

[2-45]	Description
0 (default)	No technical cooling available
1	Technical cooling available

For more information about this setting, refer to the service manual.

[2-47]

T_e target temperature during heat recovery operation.

[2-47]	T_e target (°C)
0 (default)	Auto
2	6
3	7
4	8
5	9
6	10
7	11

[2-49]

Height difference setting.

[2-49]	Description
0 (default)	—
1	In case the outdoor unit is installed in the highest position (indoor units are installed on a lower position than outdoor units) and the height difference between the lowest indoor unit and the outdoor unit exceeds 50 m, the setting [2-49] has to be changed to 1.

6.1.9 To connect the PC configurator to the outdoor unit

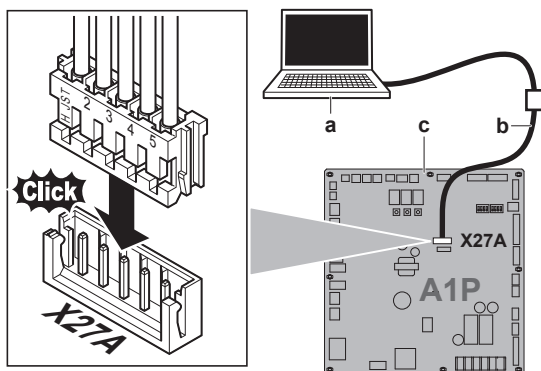

- a PC
- b Cable (EKPCCAB)
- c Outdoor unit main PCB

6.2 Using the leak detection function

6.2.1 About automatic leak detection

The (automatic) leak detection function is not by default activated and can only start working when the additional refrigerant charge is inputted into the system's logic (see [2-14]).

The leak detection operation can be automated. By changing parameter [2-85] to chosen value, the interval time or the time till the next automatic leak detection operation can be chosen. The parameter [2-86] defines whether the leak detection operation is executed one time (within [2-85] days) or intermittent, respecting an interval of [2-85] days.

Availability of the leak detection function feature requires input of the additional refrigerant charge amount immediately after finishing the charging. The input must be executed before performing the test operation.

**NOTICE**

If a wrong value is input for the additional charged refrigerant weight, the accuracy of the leak detection function will decrease.

**INFORMATION**

- The weighed and already recorded amount of additional refrigerant charge (not the total amount of refrigerant present in the system) must be entered.
- The leak detection function is not available when Hydrobox units are connected to the system.
- When the height difference between indoor units is $\geq 50/40$ m, the leak detection function can not be used.

7 Commissioning

After installation and once the field settings are defined, the installer is obliged to verify correct operation. Therefore a test run **MUST** be performed according to the procedures described below.

7.1 Precautions when commissioning

**CAUTION**

Do NOT perform the test operation while working on the indoor units.

When performing the test operation, NOT only the outdoor unit, but the connected indoor unit will operate as well. Working on an indoor unit while performing a test operation is dangerous.

**NOTICE**

Be sure to turn on the power 6 hours before operation in order to have power running to the crankcase heater and to protect the compressor.

During test operation, the outdoor unit and the indoor units will start up. Make sure that the preparations of all indoor units are finished (field piping, electrical wiring, air purge, ...). See installation manual of the indoor units for details.

7.2 Checklist before commissioning

After the installation of the unit, first check the following items. Once all below checks are fulfilled, the unit **MUST** be closed, **ONLY** then can the unit be powered up.



You read the complete installation and operation instructions, as described in the **installer and user reference guide**.

7 Commissioning

<input type="checkbox"/>	Installation Check that the unit is properly installed, to avoid abnormal noises and vibrations when starting up the unit.
<input type="checkbox"/>	Field wiring Be sure that the field wiring has been carried out according to the instructions described in the chapter "5.7 Connecting the electrical wiring" on page 21, according to the wiring diagrams and according to the applicable legislation.
<input type="checkbox"/>	Power supply voltage Check the power supply voltage on the local supply panel. The voltage MUST correspond to the voltage on the identification label of the unit.
<input type="checkbox"/>	Earth wiring Be sure that the earth wires have been connected properly and that the earth terminals are tightened.
<input type="checkbox"/>	Insulation test of the main power circuit Using a megatester for 500 V, check that the insulation resistance of 2 MΩ or more is attained by applying a voltage of 500 V DC between power terminals and earth. NEVER use the megatester for the transmission wiring.
<input type="checkbox"/>	Fuses, circuit breakers, or protection devices Check that the fuses, circuit breakers, or the locally installed protection devices are of the size and type specified in the chapter "4.3.2 Safety device requirements" on page 10. Be sure that neither a fuse nor a protection device has been bypassed.
<input type="checkbox"/>	Internal wiring Visually check the electrical component box and the inside of the unit for loose connections or damaged electrical components.
<input type="checkbox"/>	Pipe size and pipe insulation Be sure that correct pipe sizes are installed and that the insulation work is properly executed.
<input type="checkbox"/>	Stop valves Be sure that the stop valves are open on both liquid and gas side.
<input type="checkbox"/>	Damaged equipment Check the inside of the unit on damaged components or squeezed pipes.
<input type="checkbox"/>	Refrigerant leak Check the inside of the unit on refrigerant leakage. If there is a refrigerant leak, try to repair the leak. If the repair is unsuccessful, call your local dealer. Do not touch any refrigerant which has leaked out from refrigerant piping connections. This may result in frostbite.
<input type="checkbox"/>	Oil leak Check the compressor for oil leakage. If there is an oil leak, try to repair the leak. If the repairing is unsuccessful, call your local dealer.
<input type="checkbox"/>	Air inlet/outlet Check that the air inlet and outlet of the unit is NOT obstructed by paper sheets, cardboard, or any other material.
<input type="checkbox"/>	Additional refrigerant charge The amount of refrigerant to be added to the unit shall be written on the included "Added refrigerant" plate and attached to the rear side of the front cover.

<input type="checkbox"/>	Installation date and field setting Be sure to keep record of the installation date on the sticker on the rear of the upper front panel according to EN60335-2-40 and keep record of the contents of the field setting(s).
--------------------------	--

7.3 About the test run

The procedure below describes the test operation of the complete system. This operation checks and judges following items:

- Check for incorrect wiring (communication check with indoor units).
- Check of the stop valves opening.
- Judgement of piping length.

In case Hydrobox units are present in the system, the pipe length check and the refrigerant situation check will not be performed.

- Make sure to carry out the system test operation after the first installation. Otherwise, the malfunction code **U3** will be displayed on the user interface and normal operation or individual indoor unit test run cannot be carried out.
- Abnormalities on indoor units cannot be checked for each unit separately. After the test operation is finished, check the indoor units one by one by performing a normal operation using the user interface. Refer to the indoor unit installation manual for more details (e.g., Hydrobox) concerning the individual test run.



INFORMATION

- It may take 10 minutes to achieve a uniform refrigerant state before the compressor starts.
- During the test operation, the refrigerant running sound or the magnetic sound of a solenoid valve may become loud and the display indication may change. These are not malfunctions.

7.4 To perform a test run

- 1 Close all front panels in order to not let it be the cause of misjudgement (except the electrical component box inspection opening service cover).
- 2 Make sure all field settings you want are set; see ["6.1 Making field settings"](#) on page 24.
- 3 Turn ON the power to the outdoor unit and the connected indoor units.



NOTICE

Be sure to turn on the power 6 hours before operation in order to have power running to the crankcase heater and to protect the compressor.

- 4 Make sure the default (idle) situation is existing; see ["6.1.4 To access mode 1 or 2"](#) on page 25. Push BS2 for 5 seconds or more. The unit will start test operation.

Result: The test operation is automatically carried out, the outdoor unit display will indicate "E1 !" and the indication "Test operation" and "Under centralised control" will display on the user interface of indoor units.

Steps during the automatic system test run procedure:

Step	Description
E01	Control before start up (pressure equalisation)
E02	Cooling start up control
E03	Cooling stable condition
E04	Communication check
E05	Stop valve check
E06	Pipe length check

Step	Description
E07	Refrigerant amount check
E09	Pump down operation
E10	Unit stop

Note: During the test operation, it is not possible to stop the unit operation from a user interface. To abort the operation, press BS3. The unit will stop after ±30 seconds.

- 5 Check the test operation results on the outdoor unit 7-segment display.

Completion	Description
Normal completion	No indication on the 7-segment display (idle).
Abnormal completion	Indication of malfunction code on the 7-segment display. Refer to "7.5 Correcting after abnormal completion of the test run" on page 29 to take actions for correcting the abnormality. When the test operation is fully completed, normal operation will be possible after 5 minutes.

7.5 Correcting after abnormal completion of the test run

The test operation is only completed if there is no malfunction code displayed on the user interface or outdoor unit 7-segment display. In case of a displayed malfunction code, perform correcting actions as explained in the malfunction code table. Carry out the test operation again and confirm that the abnormality is properly corrected.

8.2 Error codes: Overview

In case other error codes appear, contact your dealer.

Main code	Sub code			Cause	Solution
	Master	Slave 1	Slave 2		
E2	-01	-02	-03	Earth leakage detector activated	Restart the unit. If the problem reoccurs, contact your dealer.
	-05	-07	-08	Earth leakage detector malfunction: open circuit) - A1P (X101A)	Check connection on PCB or actuator.
E3	-01	-03	-05	High pressure switch was activated (S1PH, S2PH) – main PCB (X2A, X3A)	Check stop valve situation or abnormalities in (field) piping or airflow over air cooled coil.
	-02	-04	-05	<ul style="list-style-type: none"> Refrigerant overcharge Stop valve closed 	<ul style="list-style-type: none"> Check refrigerant amount+recharge unit. Open stop valves
	-13	-14	-15	Stop valve closed (liquid)	Open liquid stop valve.
		-18		<ul style="list-style-type: none"> Refrigerant overcharge Stop valve closed 	<ul style="list-style-type: none"> Check refrigerant amount+recharge unit. Open stop valves.
E4	-01	-02	-03	Low pressure malfunction: <ul style="list-style-type: none"> Stop valve closed Refrigerant shortage Indoor unit malfunction 	<ul style="list-style-type: none"> Open stop valves. Check refrigerant amount+recharge unit. Check the user interface's display or transmission wiring between the outdoor unit and the indoor unit.



INFORMATION

Refer to the installation manual of the indoor unit for detailed malfunction codes related to indoor units.

8 Troubleshooting

8.1 Solving problems based on error codes

In case of a displayed malfunction code, perform correcting actions as explained in the malfunction code table.

After correcting the abnormality, press BS3 to reset the malfunction code and retry operation.

The malfunction code which is displayed on the outdoor unit will indicate a main malfunction code and a sub code. The sub code indicates more detailed information about the malfunction code. The malfunction code will be displayed intermittently.

Example:

Code	Example
Main code	E3
Sub code	-01

With an interval of 1 second, the display will switch between main code and sub code.

8 Troubleshooting

Main code	Sub code			Cause	Solution
	Master	Slave 1	Slave 2		
E9	-01	-05	-08	Electronic expansion valve malfunction (upper heat exchanger) (Y1E) – main PCB (X21A)	Check connection on PCB or actuator.
	-04	-07	-10	Electronic expansion valve malfunction (lower heat exchanger) (Y3E) – main PCB (X23A)	Check connection on PCB or actuator.
	-03	-06	-09	Electronic expansion valve malfunction (subcool heat exchanger) (Y2E) – main PCB (X22A)	Check connection on PCB or actuator.
	-26	-27	-28	Electronic expansion valve malfunction (receiver gas) (Y4E) – main PCB (X25A)	Check connection on PCB or actuator.
	-29	-34	-39	Electronic expansion valve malfunction (inverter cooling) (Y5E) – sub PCB (X8A)	Check connection on PCB or actuator.
	-31	-36	-41	Electronic expansion valve malfunction (auto charge) (Y6E) - sub PCB (X10A)	Check connection on PCB or actuator.
F3	-01	-03	-05	Discharge temperature too high (R21T/ R22T) – main PCB (X19A): <ul style="list-style-type: none"> ▪ Stop valve closed ▪ Refrigerant shortage 	<ul style="list-style-type: none"> ▪ Open stop valves. ▪ Check refrigerant amount+recharge unit.
	-20	-21	-22	Compressor casing temperature too high (R15T) – main PCB (X19A): <ul style="list-style-type: none"> ▪ Stop valve closed ▪ Refrigerant shortage 	<ul style="list-style-type: none"> ▪ Open stop valves. ▪ Check refrigerant amount+recharge unit.
F6		-02		<ul style="list-style-type: none"> ▪ Refrigerant overcharge ▪ Stop valve closed 	<ul style="list-style-type: none"> ▪ Check refrigerant amount+recharge unit. ▪ Open stop valves.
H9	-01	-02	-03	Ambient temperature sensor malfunction (R1T) – main PCB (X18A)	Check connection on PCB or actuator.
J3	-16	-22	-28	Discharge temperature sensor malfunction (R21T): open circuit – main PCB (X19A)	Check connection on PCB or actuator.
	-17	-23	-29	Discharge temperature sensor malfunction (R21T): short circuit - main PCB (X19A)	Check connection on PCB or actuator.
	-18	-24	-30	Discharge temperature sensor malfunction (R22T): open circuit - main PCB (X19A)	Check connection on PCB or actuator.
	-19	-25	-31	Discharge temperature sensor malfunction (R22T): short circuit - main PCB (X19A)	Check connection on PCB or actuator.
	-47	-49	-51	Compressor casing temperature sensor malfunction (R15T): open circuit - main PCB (X19A)	Check connection on PCB or actuator.
	-48	-50	-52	Compressor casing temperature sensor malfunction (R15T): short circuit - main PCB (X19A)	Check connection on PCB or actuator.
J5	-01	-03	-05	Suction compressor temperature sensor (R12T) – sub PCB (X15A)	Check connection on PCB or actuator.
	-18	-19	-20	Suction temperature sensor (R10T) – main PCB (X29A)	Check connection on PCB or actuator.
J6	-01	-02	-03	Heat exchanger deicer temperature sensor (R11T) – sub PCB (X15A)	Check connection on PCB or actuator.
	-08	-09	-10	Upper heat exchanger – gas - temperature sensor (R8T) – main PCB (X29A)	Check connection on PCB or actuator.
	-11	-12	-13	Lower heat exchanger – gas - temperature sensor (R9T) main PCB (X29A)	Check connection on PCB or actuator.

Main code	Sub code			Cause	Solution
	Master	Slave 1	Slave 2		
J7	-01	-02	-03	Liquid main - temperature sensor (R3T) – main PCB (X30A)	Check connection on PCB or actuator.
	-06	-07	-08	Subcool heat exchanger – liquid - temperature sensor (R7T) - main PCB (X30A)	Check connection on PCB or actuator.
J8	-01	-02	-03	Upper heat exchanger – liquid - temperature sensor (R4T) - main PCB (X30A)	Check connection on PCB or actuator.
	-08	-09	-10	Lower heat exchanger – liquid - temperature sensor (R5T) - main PCB (X30A)	Check connection on PCB or actuator.
	-11	-12	-13	Auto charge temperature sensor (R14T) – sub PCB (X15A)	Check connection on PCB or actuator.
J9	-01	-02	-03	Subcool heat exchanger – gas - temperature sensor (R6T) – main PCB (X30A)	Check connection on PCB or actuator.
	-11	-12	-13	Receiver gas temperature sensor (R13T) – sub PCB (X17A)	Check connection on PCB or actuator.
JR	-06	-08	-10	High pressure sensor malfunction (S1NPH): open circuit - main PCB (X32A)	Check connection on PCB or actuator.
	-07	-09	-11	High pressure sensor malfunction (S1NPH): short circuit - main PCB (X32A)	Check connection on PCB or actuator.
JC	-06	-08	-10	Low pressure sensor malfunction (S1NPL): open circuit - main PCB (X31A)	Check connection on PCB or actuator.
	-07	-09	-11	Low pressure sensor malfunction (S1NPL): short circuit - main PCB (X31A)	Check connection on PCB or actuator.
LC	-14	-15	-16	Transmission outdoor unit - inverter: INV1 transmission trouble - main PCB (X20A, X28A, X40A)	Check connection.
	-19	-20	-21	Transmission outdoor unit - inverter: FAN1 transmission trouble - main PCB (X20A, X28A, X40A)	Check connection.
	-24	-25	-26	Transmission outdoor unit - inverter: FAN2 transmission trouble - main PCB (X20A, X28A, X40A)	Check connection.
	-30	-31	-32	Transmission outdoor unit - inverter: INV2 transmission trouble - main PCB (X20A, X28A, X40A)	Check connection.
	-33	-34	-35	Transmission main PCB – sub PCB – main PCB (X20A), sub PCB (X2A, X3A)	Check connection.
P1	-01	-02	-03	INV1 unbalanced power supply voltage	Check if power supply is within range.
	-07	-08	-09	INV2 unbalanced power supply voltage	Check if power supply is within range.
U1	-01	-05	-07	Reversed power supply phase malfunction	Correct phase order.
	-04	-06	-08	Reversed power supply phase malfunction	Correct phase order.
U2	-01	-08	-11	INV1 voltage power shortage	Check if power supply is within range.
	-02	-09	-12	INV1 power phase loss	Check if power supply is within range.
	-22	-25	-28	INV2 voltage power shortage	Check if power supply is within range.
	-23	-26	-29	INV2 power phase loss	Check if power supply is within range.
U3		-03		Malfunction code: system test run not yet executed (system operation not possible)	Execute system test run.
		-04		An error occurred during the test run	Re-execute the test run.
		-05, -06		Test run aborted	Re-execute the test run.
		-07, -08		Test run aborted due to communication issues	Check the communication wires and re-execute the test run.

8 Troubleshooting

Main code	Sub code			Cause	Solution
	Master	Slave 1	Slave 2		
U4	-01			Faulty wiring to Q1/Q2 or indoor - outdoor	Check (Q1/Q2) wiring.
	-03			Indoor unit communication error	Check user interface connection.
U7	-03, -04			Malfunction code: faulty wiring to Q1/Q2	Check Q1/Q2 wiring.
	-11			Too many indoor units are connected to F1/F2 line	Check indoor unit amount and total capacity connected.
U9	-01			System mismatch. Wrong type of indoor units combined (R410A, R407C, Hydrobox, etc) Indoor unit malfunction	Check if other indoor units have malfunction and confirm indoor unit mix is allowed.
UR	-03			Connection malfunction over indoor units or type mismatch (R410A, R407C, Hydrobox, etc)	Check if other indoor units have malfunction and confirm indoor unit mix is allowed.
	-18			Connection malfunction over indoor units or type mismatch (R410A, R407C, Hydrobox, etc)	Check if other indoor units have malfunction and confirm indoor unit mix is allowed.
	-31			Wrong unit combination (multi system)	Check if unit types are compatible.
	-20			Wrong outdoor unit connected	Disconnect the outdoor unit.
	-27			No BS unit connected	Connect a BS unit.
	-28			Old BS unit connected	Disconnect the BS unit.
	-53			BS unit DIP switch abnormality	Check the DIP switches of the BS unit.
UH	-01			Auto address malfunction (inconsistency)	Check if transmission wired unit amount matches with powered unit amount (by monitor mode) or wait till initialisation is finished.
UF	-01			Auto address malfunction (inconsistency)	Check if transmission wired unit amount matches with powered unit amount (by monitor mode) or wait till initialisation is finished.
	-05			Stop valve closed or wrong (during system test run)	Open stop valves.
Auto charging related					
P2	—			Unusual low pressure on suction line	Close valve A immediately. Push BS1 to reset. Check following items before retrying autocharge procedure: <ul style="list-style-type: none"> ▪ Check if the gas side stop valve is opened correctly. ▪ Check if the valve of the refrigerant cylinder is opened. ▪ Check if the air inlet and outlet of the indoor unit are not obstructed.
P8	—			Freeze-up prevention indoor unit	Close valve A immediately. Push BS1 to reset. Retry autocharge procedure.
PE	—			Automatic charging nearly finished	Prepare for autocharge stopping.
P9	—			Automatic charging finished	Finish autocharge mode.
Leak detection function related					
E-1	—			Unit is not prepared to execute leak detection operation	Refer to requirements to be able to execute leak detection operation.
E-2	—			Indoor unit is out of temperature range for leak detection operation	Retry when ambient conditions are satisfied.
E-3	—			Outdoor unit is out of temperature range for leak detection operation	Retry when ambient conditions are satisfied.
E-4	—			Too low pressure was noticed during leak detection operation	Restart leak detection operation.
E-5	—			Indicates an indoor unit which is not compatible with leak detection functionality is installed (e.g. Hydrobox, ...)	Refer to requirements to be able to execute leak detection operation.

9 Technical data

A **subset** of the latest technical data is available on the regional Daikin website (publicly accessible). The **full set** of latest technical data is available on the Daikin Business Portal (authentication required).

9.1 Service space: Outdoor unit

Make sure the space around the unit is adequate for servicing and the minimum space for air inlet and air outlet is available (refer to the figure below and choose one of the possibilities).

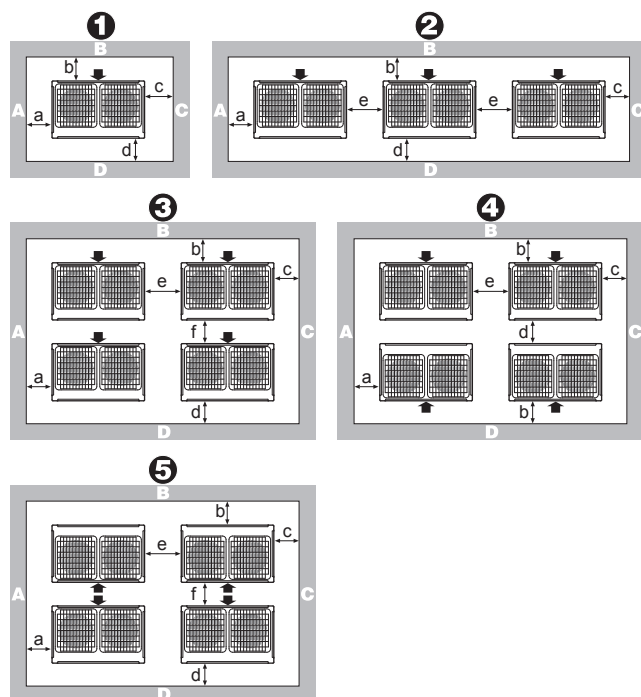

Layout	A+B+C+D		A+B
	Possibility 1	Possibility 2	
1	a ≥ 10 mm b ≥ 300 mm c ≥ 10 mm d ≥ 500 mm	a ≥ 50 mm b ≥ 100 mm c ≥ 50 mm d ≥ 500 mm	a ≥ 200 mm b ≥ 300 mm
2	a ≥ 10 mm b ≥ 300 mm c ≥ 10 mm d ≥ 500 mm e ≥ 20 mm	a ≥ 50 mm b ≥ 100 mm c ≥ 50 mm d ≥ 500 mm e ≥ 100 mm	a ≥ 200 mm b ≥ 300 mm e ≥ 400 mm
3	a ≥ 10 mm b ≥ 300 mm c ≥ 10 mm d ≥ 500 mm e ≥ 20 mm f ≥ 600 mm	a ≥ 50 mm b ≥ 100 mm c ≥ 50 mm d ≥ 500 mm e ≥ 100 mm f ≥ 500 mm	—
4	a ≥ 10 mm b ≥ 300 mm c ≥ 10 mm d ≥ 500 mm e ≥ 20 mm	a ≥ 50 mm b ≥ 100 mm c ≥ 50 mm d ≥ 500 mm e ≥ 100 mm	—

Layout	A+B+C+D		A+B
	Possibility 1	Possibility 2	
5	a ≥ 10 mm b ≥ 500 mm c ≥ 10 mm d ≥ 500 mm e ≥ 20 mm f ≥ 900 mm	a ≥ 50 mm b ≥ 500 mm c ≥ 50 mm d ≥ 500 mm e ≥ 100 mm f ≥ 600 mm	—

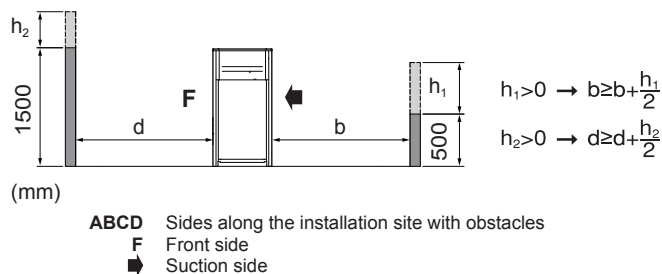

- In case of an installation site where sides A+B+C+D have obstacles, the wall heights of sides A+C have no impact on service space dimensions. Refer to the figure above for impact of wall heights of sides B+D on service space dimensions.
- In case of an installation site where only the sides A+B have obstacles, the wall heights have no influence on any indicated service space dimensions.
- The installation space required on these drawings are for full load heating operation without considering possible ice accumulation. If the location of the installation is in a cold climate, then all dimensions above should be >500 mm to avoid accumulation of ice in between the outdoor units.

i **INFORMATION**

The service space dimensions in above figure are based on cooling operation at 35°C ambient temperature (standard conditions).

i **INFORMATION**

Further specifications can be found in the technical engineering data.

9 Technical data

9.2 Piping diagram: Outdoor unit

Piping diagram: 5~12 HP

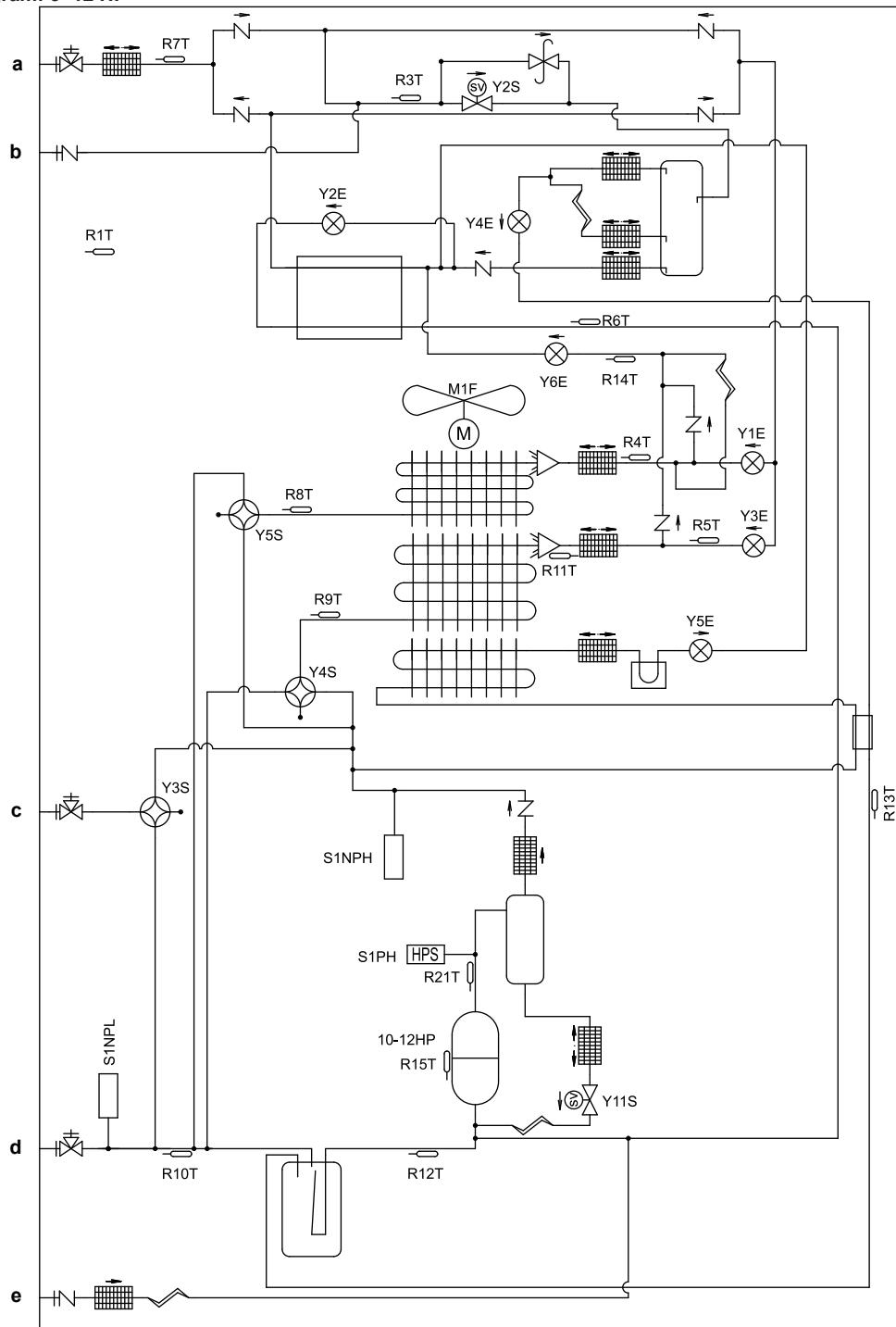





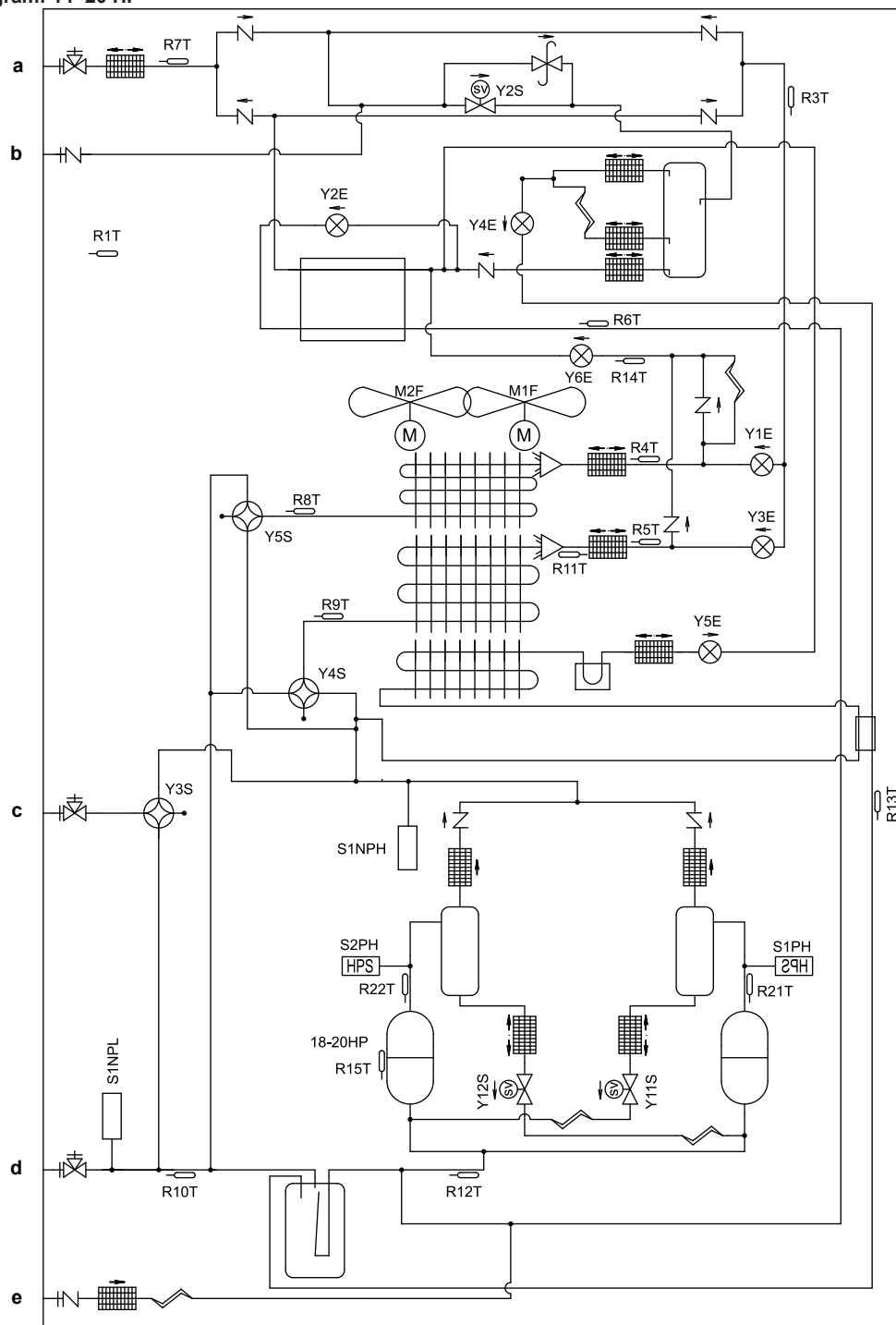

















- a Stop valve (liquid)
- b Service port
- c Stop valve (high pressure/low pressure)
- d Stop valve (gas)
- e Charge port

Piping diagram: 14~20 HP



- a Stop valve (liquid)
- b Service port
- c Stop valve (high pressure/low pressure)
- d Stop valve (gas)
- e Charge port









9 Technical data

	Charge port / Service port
	Stop valve
	Filter
	Check valve
	Pressure relief valve
	Thermistor
	Solenoid valve
	Heat sink (PCB)
	Capillary tube
	Expansion valve
	4-way valve
	Propeller fan
	High pressure switch
	Low pressure sensor
	High pressure sensor
	Oil separator
	Accumulator
	Heat exchanger
	Compressor
	Double tube heat exchanger
	Distributor
	Liquid receiver

7 For 14~20 HP: When using the optional accessory, refer to the installation manual of the optional accessory.

8 For 14~20 HP: Colours (see below).

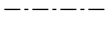
Symbols:

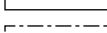
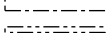
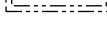
	Field wiring
	Terminal block
	Connector
	Terminal
	Protective earth
	Noiseless earth
	Earth wiring
	Field supply
	PCB
	Switch box
	Option

Colours:

BLK	Black
RED	Red
BLU	Blue
WHT	White
GRN	Green

Legend for wiring diagram 5~12 HP:

A1P	Printed circuit board (main)
A2P	Printed circuit board (noise filter)
A3P	Printed circuit board (inverter)
A4P	Printed circuit board (fan)
A5P	Printed circuit board (sub)
BS1~BS3 (A1P)	Push button switch (MODE, SET, RETURN)
C* (A3P)	Capacitor
DS1, DS2 (A1P)	DIP switch
E1HC	Crankcase heater
E3H	Drain pan heater (option)
F1U, F2U (A1P)	Fuse (T 3.15 A / 250 V)
F3U	Field fuse
F101U (A4P)	Fuse
F401U, F403U (A2P)	Fuse
F601U, (A3P)	Fuse
HAP (A*P)	Pilot lamp (service monitor is green)
K3R (A1P)	Magnetic relay (Y11S)
K6R (A1P)	Magnetic relay (E3H)
K7R (A1P)	Magnetic relay (E1HC)
K9R (A1P)	Magnetic relay (Y3S)
K11R (A1P)	Magnetic relay (Y2S)
K12R (A1P)	Magnetic relay (Y4S)
K13R (A1P)	Magnetic relay (Y5S)
L1R	Reactor
M1C	Motor (compressor)
M1F	Motor (fan)
PS (A1P, A3P, A5P)	Switching power supply
Q1DI	Earth leakage circuit breaker

9.3 Wiring diagram: Outdoor unit

Refer to the wiring diagram sticker on the unit. The abbreviations used are listed below:

INFORMATION

The wiring diagram on the outdoor unit is only for the outdoor unit. For the indoor unit or optional electrical components, refer to the wiring diagram of the indoor unit.

- 1 This wiring diagram applies only to the outdoor unit.
- 2 Symbols (see below).
- 3 For connection wiring to indoor-outdoor transmission F1-F2, outdoor-outdoor transmission F1-F2, outdoor-multi transmission Q1-Q2, refer to the installation manual.
- 4 How to use BS1~BS3 switch, refer to the "Service Precaution" label on the electrical component box cover.
- 5 When operating, do NOT short-circuit the protection devices (S1PH, S2PH (for 14~20 HP only)).
- 6 For 5~12 HP: When using the optional accessory, refer to the installation manual of the optional accessory.
- 6 For 14~20 HP: connector X1A (M2F is red, connector X2A (M2F) is white).
- 7 For 5~12 HP: Colours (see below).

Q1LD (A1P)	Earth current detector	BS1~BS3 (A1P)	Push button switch (MODE, SET, RETURN)
Q1RP (A1P)	Phase reversal detect circuit	C* (A3P)	Capacitor
R24 (A4P)	Resistor (current sensor)	DS1, DS2 (A1P)	DIP switch
R300 (A3P)	Resistor (current sensor)	E1HC	Crankcase heater
R1T	Thermistor (air)	E3H	Drain pan heater (option)
R3T	Thermistor (liquid, main)	F1U, F2U (A1P)	Fuse (T 3.15 A / 250 V)
R4T	Thermistor (heat exchanger, liquid pipe upper)	F1U (A8P)	Fuse (T 3.15 A / 250 V)
R5T	Thermistor (heat exchanger, liquid pipe lower)	F3U	Field fuse
R6T	Thermistor (subcool heat exchanger gas)	F101U (A4P, A7P)	Fuse
R7T	Thermistor (subcool heat exchanger liquid)	F401U, F403U (A2P, A5P)	Fuse
R8T	Thermistor (heat exchanger, gas upper)	F601U, (A3P, A6P)	Fuse
R9T	Thermistor (heat exchanger, gas lower)	HAP (A*P)	Pilot lamp (service monitor is green)
R10T	Thermistor (suction)	K3R (A3P, A6P)	Magnetic relay
R11T	Thermistor (heat exchanger, de-icer)	K3R (A1P)	Magnetic relay (Y12S)
R12T	Thermistor (suction compressor)	K4R (A1P)	Magnetic relay (Y11S)
R13T	Thermistor (receiver gas)	K6R (A1P)	Magnetic relay (E3H)
R14T	Thermistor (auto charge)	K7R (A1P)	Magnetic relay (E1HC)
R15T	Thermistor (compressor body)	K8R (A1P)	Magnetic relay (E2HC)
R21T	Thermistor (M1C discharge)	K9R (A1P)	Magnetic relay (Y3S)
S1NPH	Pressure sensor (high)	K11R (A1P)	Magnetic relay (Y2S)
S1NPL	Pressure sensor (low)	K12R (A1P)	Magnetic relay (Y4S)
S1PH	Pressure switch (discharge)	K13R (A1P)	Magnetic relay (Y5S)
SEG1~SEG3 (A1P)	7-segment display	L1R, L2R	Reactor
T1A	Current sensor	M1C, M2C	Motor (compressor)
V1D (A3P)	Diode	M1F, M2F	Motor (fan)
V1R (A3P, A4P)	Power module	PS (A1P, A3P, A6P, A8P)	Switching power supply
X*A	Connector	Q1DI	Earth leakage circuit breaker
X1M	Terminal block	Q1LD (A1P)	Earth current detector
X1M (A1P)	Terminal block (control)	Q1RP (A1P)	Phase reversal detect circuit
Y1E	Electronic expansion valve (heat exchanger upper)	R24 (A4P, A7P)	Resistor (current sensor)
Y2E	Electronic expansion valve (subcool heat exchanger)	R300 (A3P, A6P)	Resistor (current sensor)
Y3E	Electronic expansion valve (heat exchanger lower)	R1T	Thermistor (air)
Y4E	Electronic expansion valve (receiver gas)	R3T	Thermistor (liquid, main)
Y5E	Electronic expansion valve (inverter cooling)	R4T	Thermistor (heat exchanger, liquid pipe upper)
Y6E	Electronic expansion valve (auto charge)	R5T	Thermistor (heat exchanger, liquid pipe lower)
Y2S	Solenoid valve (liquid pipe)	R6T	Thermistor (subcool heat exchanger gas)
Y3S	Solenoid valve (high pressure/low pressure gas pipe)	R7T	Thermistor (subcool heat exchanger liquid)
Y4S	Solenoid valve (heat exchanger lower)	R8T	Thermistor (heat exchanger, gas upper)
Y5S	Solenoid valve (heat exchanger upper)	R9T	Thermistor (heat exchanger, gas lower)
Y11S	Solenoid valve (M1C oil return)	R10T	Thermistor (suction)
Z*C	Noise filter (ferrite core)	R11T	Thermistor (heat exchanger, de-icer)
Z*F (A2P)	Noise filter (with surge absorber)	R12T	Thermistor (suction compressor)
Connector for optional accessories:		R13T	Thermistor (receiver gas)
X10A	Connector (bottom plate heater)	R14T	Thermistor (auto charge)
Legend for wiring diagram 14~20 HP:		R15T (only 18+20 HP)	Thermistor (compressor body)
A1P	Printed circuit board (main)	R21T, R22T	Thermistor (M1C, M2C discharge)
A2P, A5P	Printed circuit board (noise filter)	S1NPH	Pressure sensor (high)
A3P, A6P	Printed circuit board (inverter)	S1NPL	Pressure sensor (low)
A4P, A7P	Printed circuit board (fan)	S1PH, S2PH	Pressure switch (discharge)
A8P	Printed circuit board (sub)		

10 About the system

SEG1~SEG3 (A1P)	7-segment display	Y5E	Electronic expansion valve (inverter cooling)
T1A	Current sensor	Y6E	Electronic expansion valve (auto charge)
V1D (A3P, A6P)	Diode	Y2S	Solenoid valve (liquid pipe)
V1R (A3P, A4P, A6P, A7P)	Power module	Y3S	Solenoid valve (high pressure/low pressure gas pipe)
X*A	Connector	Y4S	Solenoid valve (heat exchanger lower)
X1M	Terminal block	Y5S	Solenoid valve (heat exchanger upper)
X1M (A1P)	Terminal block (control)	Y11S	Solenoid valve (M1C oil return)
Y1E	Electronic expansion valve (heat exchanger upper)	Y12S	Solenoid valve (M2C oil return)
Y2E	Electronic expansion valve (subcool heat exchanger)	Z*C	Noise filter (ferrite core)
Y3E	Electronic expansion valve (heat exchanger lower)	Z*F (A2P, A5P)	Noise filter (with surge absorber)
Y4E	Electronic expansion valve (receiver gas)	Connector for optional accessories:	
		X10A	Connector (bottom plate heater)

For the user

10 About the system

The indoor unit part of VRV IV heat recovery system can be used for heating/cooling applications. The type of indoor unit which can be used depends on the outdoor units series.

NOTICE

For future modifications or expansions of your system:

A full overview of allowable combinations (for future system extensions) is available in technical engineering data and should be consulted. Contact your installer to receive more information and professional advice.

10.1 System layout

Your VRV IV heat recovery series outdoor unit can be one of following models:

Model	Description
REYQ8~20	Heat recovery model for single or multi-use
REMQ5	Heat recovery model for multi-use only

Depending on the type of outdoor unit which is chosen, some functionality will or will not exist. It will be indicated throughout this operation manual when certain features have exclusive model rights or not.

The complete system can be divided into several sub-systems. These sub-systems have 100% independence regarding the selection of cooling and heating operation, and each consists of one single BS unit or one individual branch set of a multi BS unit, and all indoor units connected downstream. When using a cool/heat selector, connect this to the BS unit.

11 User interface

CAUTION

- NEVER touch the internal parts of the controller.
- Do NOT remove the front panel. Some parts inside are dangerous to touch and appliance problems may happen. For checking and adjusting the internal parts, contact your dealer.

This operation manual will give a non-exhaustive overview of the main functions of the system.

Detailed information on required actions to achieve certain functions can be found in the dedicated installation and operation manual of the indoor unit.

Refer to the operation manual of the installed user interface.

12 Operation

12.1 Operation range

Use the system in the following temperature and humidity ranges for safe and effective operation.

	Cooling	Heating
Outdoor temperature	-5~43°C DB	-20~20°C DB -20~15.5°C WB
Indoor temperature	21~32°C DB 14~25°C WB	15~27°C DB
Indoor humidity	≤80% ^(a)	

- (a) To avoid condensation and water dripping out of the unit. If the temperature or the humidity is beyond these conditions, safety devices may be put in action and the air conditioner may not operate.

Above operation range is only valid in case direct expansion indoor units are connected to the VRV IV system.

Special operation ranges are valid in case of using Hydrobox units or AHU. They can be found in the installation/operation manual of the dedicated unit. Latest information can be found in the technical engineering data.

12.2 Operating the system

12.2.1 About operating the system

- Operation procedure varies according to the combination of outdoor unit and user interface.
- To protect the unit, turn on the main power switch 6 hours before operation.
- If the main power supply is turned off during operation, operation will restart automatically after the power turns back on again.

12.2.2 About cooling, heating, fan only, and automatic operation

- Changeover cannot be made with a user interface whose display shows "change-over under centralised control" (refer to installation and operation manual of the user interface).
- When the display "change-over under centralised control" flashes, refer to "12.5.1 About setting the master user interface" on page 40.
- The fan may keep on running for about 1 minute after the heating operation stops.
- The air flow rate may adjust itself depending on the room temperature or the fan may stop immediately. This is not a malfunction.

12.2.3 About the heating operation

It may take longer to reach the set temperature for general heating operation than for cooling operation.

The following operation is performed in order to prevent the heating capacity from dropping or cold air from blowing.

Defrost operation

In heating operation, freezing of the outdoor unit's air cooled coil increases over time, restricting the energy transfer to the outdoor unit's coil. Heating capability decreases and the system needs to go into defrost operation to be able to remove frost from the outdoor unit's coil. During defrost operation the heating capacity on the indoor unit side will temporarily drop until defrosting is completed. After defrosting, the unit will regain its full heating capacity.

In case of	Then
REYQ10~54 multi-models	The indoor unit will continue heating operation at a reduced level during defrost operation. It will guarantee a decent comfort level indoor.
REYQ8~20 single models	The indoor unit will stop fan operation, the refrigerant cycle will reverse and energy from inside the building will be used to defrost the outdoor unit coil.

The indoor unit will indicate defrost operation on the display .

Hot start

In order to prevent cold air from blowing out of an indoor unit at the start of heating operation, the indoor fan is automatically stopped. The display of the user interface shows . It may take some time before the fan starts. This is not a malfunction.

12.2.4 To operate the system (WITHOUT cool/heat changeover remote control switch)

- Press the operation mode selector button on the user interface several times and select the operation mode of your choice.

- Cooling operation
- Heating operation
- Fan only operation

- Press the ON/OFF button on the user interface.

Result: The operation lamp lights up and the system starts operating.

12.2.5 To operate the system (WITH cool/heat changeover remote control switch)

Overview of the changeover remote control switch

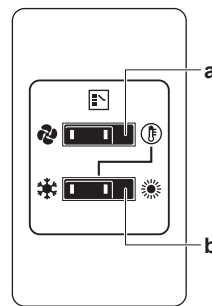

- FAN ONLY/AIR CONDITIONING SELECTOR SWITCH**
Set the switch to for fan only operation or to for heating or cooling operation.
- COOL/HEAT CHANGEOVER SWITCH**
Set the switch to for cooling or to for heating

To start

- Select operation mode with the cool/heat changeover switch as follows:

Cooling operation



Heating operation



Fan only operation

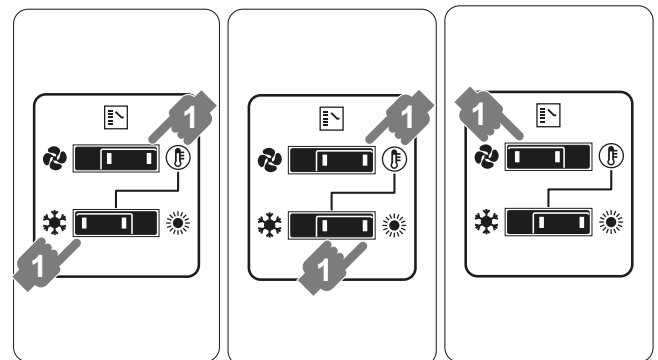

- Press the ON/OFF button on the user interface.

Result: The operation lamp lights up and the system starts operating.

To stop

- Press the ON/OFF button on the user interface once again.

Result: The operation lamp goes out and the system stops operating.



NOTICE

Do not turn off power immediately after the unit stops, but wait for at least 5 minutes.

To adjust

For programming temperature, fan speed and air flow direction refer to the operation manual of the user interface.

12.3 Using the dry program

12.3.1 About the dry program

- The function of this program is to decrease the humidity in your room with minimal temperature decrease (minimal room cooling).
- The micro computer automatically determines temperature and fan speed (cannot be set by the user interface).
- The system does not go into operation if the room temperature is low (<20°C).

12 Operation

12.3.2 To use the dry program (WITHOUT cool/heat changeover remote control switch)

To start

- 1 Press the operation mode selector button on the user interface several times and select  (program dry operation).
- 2 Press the ON/OFF button of the user interface.
Result: The operation lamp lights up and the system starts operating.
- 3 Press the air flow direction adjust button (only for double-flow, multi-flow, corner, ceiling-suspended and wall-mounted). Refer to "12.4 Adjusting the air flow direction" on page 40 for details.

To stop

- 4 Press the ON/OFF button on the user interface once again.

Result: The operation lamp goes out and the system stops operating.



NOTICE

Do not turn off power immediately after the unit stops, but wait for at least 5 minutes.

12.3.3 To use the dry program (WITH cool/heat changeover remote control switch)

To start

- 1 Select cooling operation mode with the cool/heat changeover remote control switch.



- 2 Press the operation mode selector button on the user interface several times and select  (program dry operation).
- 3 Press the ON/OFF button of the user interface.
Result: The operation lamp lights up and the system starts operating.
- 4 Press the air flow direction adjust button (only for double-flow, multi-flow, corner, ceiling-suspended and wall-mounted). Refer to "12.4 Adjusting the air flow direction" on page 40 for details.

To stop

- 5 Press the ON/OFF button on the user interface once again.

Result: The operation lamp goes out and the system stops operating.



NOTICE

Do not turn off power immediately after the unit stops, but wait for at least 5 minutes.

12.4 Adjusting the air flow direction

Refer to the operation manual of the user interface.

12.4.1 About the air flow flap

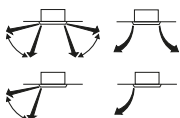

Double flow+multi-flow units

Corner units

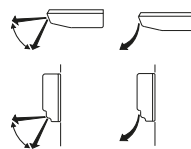



Ceiling suspended units

Wall-mounted units

For the following conditions, a micro computer controls the air flow direction which may be different from the display.

Cooling	Heating
<ul style="list-style-type: none"> When the room temperature is lower than the set temperature. 	<ul style="list-style-type: none"> When starting operation. When the room temperature is higher than the set temperature. At defrost operation.
<ul style="list-style-type: none"> When operating continuously at horizontal air flow direction. When continuous operation with downward air flow is performed at the time of cooling with a ceiling-suspended or a wall-mounted unit, the micro computer may control the flow direction, and then the user interface indication will also change. 	

The air flow direction can be adjusted in one of the following ways:

- The air flow flap itself adjusts its position.
- The air flow direction can be fixed by the user.
- Automatic  and desired position .



WARNING

Never touch the air outlet or the horizontal blades while the swing flap is in operation. Fingers may become caught or the unit may break down.



NOTICE

- The movable limit of the flap is changeable. Contact your dealer for details. (only for double-flow, multi-flow, corner, ceiling-suspended and wall-mounted).
- Avoid operating in the horizontal direction . It may cause dew or dust to settle on the ceiling or flap.

12.5 Setting the master user interface

12.5.1 About setting the master user interface

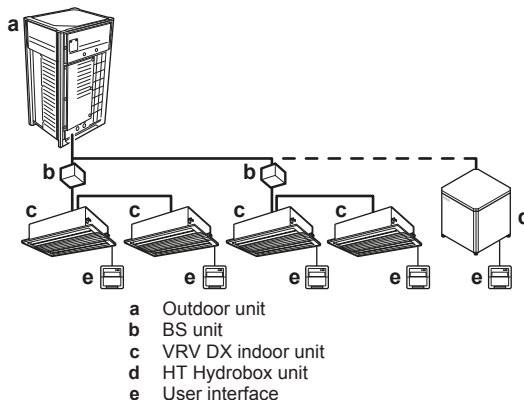

When the system is installed as shown in the figure above, it is necessary to – for each subsystem – designate one of the user interfaces as the master user interface.

The displays of slave user interfaces show  (change-over under centralised control) and slave user interfaces automatically follow the operation mode directed by the master user interface.

Only the master user interface can select heating or cooling mode.

13 Maintenance and service



NOTICE

Never inspect or service the unit by yourself. Ask a qualified service person to perform this work.



WARNING

Never replace a fuse with a fuse of a wrong ampere ratings or other wires when a fuse blows out. Use of wire or copper wire may cause the unit to break down or cause a fire.



CAUTION

Do NOT insert fingers, rods or other objects into the air inlet or outlet. Do NOT remove the fan guard. When the fan is rotating at high speed, it will cause injury.



CAUTION

After a long use, check the unit stand and fitting for damage. If damaged, the unit may fall and result in injury.



NOTICE

Do NOT wipe the controller operation panel with benzine, thinner, chemical dust cloth, etc. The panel may get discoloured or the coating peeled off. If it is heavily dirty, soak a cloth in water-diluted neutral detergent, squeeze it well and wipe the panel clean. Wipe it with another dry cloth.

13.1 About the refrigerant

This product contains fluorinated greenhouse gases. Do NOT vent gases into the atmosphere.

Refrigerant type: R410A

Global warming potential (GWP) value: 2087.5



NOTICE

Applicable legislation on **fluorinated greenhouse gases** requires that the refrigerant charge of the unit is indicated both in weight and CO₂ equivalent.

Formula to calculate the quantity in CO₂ equivalent tonnes: GWP value of the refrigerant × total refrigerant charge [in kg] / 1000

Please contact your installer for more information.



WARNING

The refrigerant in the system is safe and normally does not leak. If the refrigerant leaks in the room, contact with a fire of a burner, a heater or a cooker may result in a harmful gas.

Turn off any combustible heating devices, ventilate the room and contact the dealer where you purchased the unit.

Do not use the system until a service person confirms that the portion where the refrigerant leaks is repaired.

13.2 After-sales service and warranty

13.2.1 Warranty period

- This product includes a warranty card that was filled in by the dealer at the time of installation. The completed card has to be checked by the customer and stored carefully.
- If repairs to the product are necessary within the warranty period, contact your dealer and keep the warranty card at hand.

13.2.2 Recommended maintenance and inspection

Since dust collects when using the unit for several years, performance of the unit will deteriorate to some extent. As taking apart and cleaning interiors of units requires technical expertise and in order to ensure the best possible maintenance of your units, we recommend to enter into a maintenance and inspection contract on top of normal maintenance activities. Our network of dealers has access to a permanent stock of essential components in order to keep your unit in operation as long as possible. Contact your dealer for more information.

When asking your dealer for an intervention, always state:

- The complete model name of the unit.
- The manufacturing number (stated on the nameplate of the unit).
- The installation date.
- The symptoms or malfunction, and details of the defect.



WARNING

- Do not modify, disassemble, remove, reinstall or repair the unit yourself as incorrect dismantling or installation may cause an electric shock or fire. Contact your dealer.
- In case of accidental refrigerant leaks, make sure there are no naked flames. The refrigerant itself is entirely safe, non-toxic and non-combustible, but it will generate toxic gas when it accidentally leaks into a room where combustible air from fan heaters, gas cookers, etc. is present. Always have qualified service personnel confirm that the point of leakage has been repaired or corrected before resuming operation.

14 Troubleshooting

If one of the following malfunctions occur, take the measures shown below and contact your dealer.



WARNING

Stop operation and shut off the power if anything unusual occurs (burning smells etc.).

Leaving the unit running under such circumstances may cause breakage, electric shock or fire. Contact your dealer.

The system MUST be repaired by a qualified service person.

Malfunction	Measure
If a safety device such as a fuse, a breaker or an earth leakage breaker frequently actuates or the ON/OFF switch does NOT properly work.	Turn OFF the main power switch.
If water leaks from the unit.	Stop the operation.
The operation switch does NOT work well.	Turn OFF the power supply.
If the user interface display indicates the unit number, the operation lamp flashes and the malfunction code appears.	Notify your installer and report the malfunction code.

If the system does NOT properly operate except for the above mentioned cases and none of the above mentioned malfunctions is evident, investigate the system according to the following procedures.

14 Troubleshooting

Malfunction	Measure
If the system does not operate at all.	<ul style="list-style-type: none"> Check if there is no power failure. Wait until power is restored. If power failure occurs during operation, the system automatically restarts immediately after power is restored. Check if no fuse has blown or breaker is activated. Change the fuse or reset the breaker if necessary.
If the system goes into fan only operation, but as soon as it goes into heating or cooling operation, the system stops.	<ul style="list-style-type: none"> Check if air inlet or outlet of outdoor or indoor unit is not blocked by obstacles. Remove any obstacles and make sure the air can flow freely. Check if the user interface display shows  (time to clean the air filter). (Refer to "13 Maintenance and service" on page 41 and "Maintenance" in the indoor unit manual.)
The system operates but cooling or heating is insufficient.	<ul style="list-style-type: none"> Check if air inlet or outlet of outdoor or indoor unit is not blocked by obstacles. Remove any obstacles and make sure the air can flow freely. Check if the air filter is not clogged (refer to "Maintenance" in the indoor unit manual). Check the temperature setting. Check the fan speed setting on your user interface. Check for open doors or windows. Close doors and windows to prevent wind from coming in. Check if there are too many occupants in the room during cooling operation. Check if the heat source of the room is excessive. Check if direct sunlight enters the room. Use curtains or blinds. Check if the air flow angle is proper.

If after checking all above items, it is impossible to fix the problem yourself, contact your installer and state the symptoms, the complete model name of the unit (with manufacturing number if possible) and the installation date (possibly listed on the warranty card).

14.1 Error codes: Overview

In case a malfunction code appears on the indoor unit user interface display, contact your installer and inform the malfunction code, the unit type, and serial number (you can find this information on the nameplate of the unit).

For your reference, a list with malfunction codes is provided. You can, depending on the level of the malfunction code, reset the code by pushing the ON/OFF button. If not, ask your installer for advice.

Main code	Contents
<i>R0</i>	External protection device was activated
<i>R1</i>	EEPROM failure (indoor)
<i>R3</i>	Drain system malfunction (indoor)
<i>R5</i>	Fan motor malfunction (indoor)
<i>R7</i>	Swing flap motor malfunction (indoor)
<i>R9</i>	Expansion valve malfunction (indoor)
<i>RF</i>	Drain malfunction (indoor unit)
<i>RH</i>	Filter dust chamber malfunction (indoor)
<i>RJ</i>	Capacity setting malfunction (indoor)

Main code	Contents
<i>C1</i>	Transmission malfunction between main PCB and sub PCB (indoor)
<i>C4</i>	Heat exchanger thermistor malfunction (indoor; liquid)
<i>C5</i>	Heat exchanger thermistor malfunction (indoor; gas)
<i>C9</i>	Suction air thermistor malfunction (indoor)
<i>CR</i>	Discharge air thermistor malfunction (indoor)
<i>CE</i>	Movement detector or floor temperature sensor malfunction (indoor)
<i>CJ</i>	User interface thermistor malfunction (indoor)
<i>E1</i>	PCB malfunction (outdoor)
<i>E2</i>	Current leakage detector was activated (outdoor)
<i>E3</i>	High pressure switch was activated
<i>E4</i>	Low pressure malfunction (outdoor)
<i>E5</i>	Compressor lock detection (outdoor)
<i>E7</i>	Fan motor malfunction (outdoor)
<i>E9</i>	Electronic expansion valve malfunction (outdoor)
<i>F3</i>	Discharge temperature malfunction (outdoor)
<i>F4</i>	Abnormal suction temperature (outdoor)
<i>F6</i>	Refrigerant overcharge detection
<i>H3</i>	High pressure switch malfunction
<i>H4</i>	Low pressure switch malfunction
<i>H7</i>	Fan motor trouble (outdoor)
<i>H9</i>	Ambient temperature sensor malfunction (outdoor)
<i>J1</i>	Pressure sensor malfunction
<i>J2</i>	Current sensor malfunction
<i>J3</i>	Discharge temperature sensor malfunction (outdoor)
<i>J4</i>	Heat exchanger gas temperature sensor malfunction (outdoor)
<i>J5</i>	Suction temperature sensor malfunction (outdoor)
<i>J6</i>	De-icing temperature sensor malfunction (outdoor)
<i>J7</i>	Liquid temperature sensor (after subcool HE) malfunction (outdoor)
<i>J8</i>	Liquid temperature sensor (coil) malfunction (outdoor)
<i>J9</i>	Gas temperature sensor (after subcool HE) malfunction (outdoor)
<i>JA</i>	High pressure sensor malfunction (S1NPH)
<i>JC</i>	Low pressure sensor malfunction (S1NPL)
<i>L1</i>	INV PCB abnormal
<i>L4</i>	Fin temperature abnormal
<i>L5</i>	Inverter PCB faulty
<i>LB</i>	Compressor over current detected
<i>L9</i>	Compressor lock (startup)
<i>LC</i>	Transmission outdoor unit - inverter: INV transmission trouble
<i>P1</i>	INV unbalanced power supply voltage
<i>P2</i>	Autocharge operation related
<i>P4</i>	Fin thermistor malfunction
<i>P8</i>	Autocharge operation related
<i>P9</i>	Autocharge operation related
<i>PE</i>	Autocharge operation related
<i>PJ</i>	Capacity setting malfunction (outdoor)
<i>U0</i>	Abnormal low pressure drop, faulty expansion valve
<i>U1</i>	Reversed power supply phase malfunction
<i>U2</i>	INV voltage power shortage
<i>U3</i>	System test run not yet executed
<i>U4</i>	Faulty wiring indoor/outdoor

Main code	Contents
U5	Abnormal user interface - indoor communication
U7	Faulty wiring to outdoor/outdoor
U8	Abnormal main-sub user interface communication
U9	System mismatch. Wrong type of indoor units combined. Indoor unit malfunction.
UR	Connection malfunction over indoor units or type mismatch
UC	Centralised address duplication
UE	Malfunction in communication centralised control device - indoor unit
UF	Auto address malfunction (inconsistency)
UH	Auto address malfunction (inconsistency)



14.2 Symptoms that are NOT system malfunctions

The following symptoms are NOT system malfunctions:

14.2.1 Symptom: The system does not operate

- The air conditioner does not start immediately after the ON/OFF button on the user interface is pressed. If the operation lamp lights, the system is in normal condition. To prevent overloading of the compressor motor, the air conditioner starts 5 minutes after it is turned ON again in case it was turned OFF just before. The same starting delay occurs after the operation mode selector button was used.
- If "Under Centralized Control" is displayed on the user interface, pressing the operation button causes the display to blink for a few seconds. The blinking display indicates that the user interface cannot be used.
- The system does not start immediately after the power supply is turned on. Wait one minute until the micro computer is prepared for operation.

14.2.2 Symptom: Cool/Heat cannot be changed over

- When the display shows  (change-over under centralized control), it shows that this is a slave user interface.
- When the cool/heat changeover remote control switch is installed and the display shows  (change-over under centralized control), this is because cool/heat changeover is controlled by the cool/ heat changeover remote control switch. Ask your dealer where the remote control switch is installed.

14.2.3 Symptom: Fan operation is possible, but cooling and heating do not work

Immediately after the power is turned on. The micro computer is getting ready to operate and is performing a communication check with all indoor units. Please wait 12 minutes maximally until this process is finished.

14.2.4 Symptom: The fan speed does not correspond to the setting

The fan speed does not change even if the fan speed adjustment button is pressed. During heating operation, when the room temperature reaches the set temperature, the outdoor unit goes off and the indoor unit changes to whisper fan speed. This is to prevent cold air blowing directly on occupants of the room. The fan speed will not change even when another indoor unit is in heating operation, if the button is pressed.

14.2.5 Symptom: The fan direction does not correspond to the setting

The fan direction does not correspond with the user interface display. The fan direction does not swing. This is because the unit is being controlled by the micro computer.

14.2.6 Symptom: White mist comes out of a unit (Indoor unit)

- When humidity is high during cooling operation. If the interior of an indoor unit is extremely contaminated, the temperature distribution inside a room becomes uneven. It is necessary to clean the interior of the indoor unit. Ask your dealer for details on cleaning the unit. This operation requires a qualified service person.
- Immediately after the cooling operation stops and if the room temperature and humidity are low. This is because warm refrigerant gas flows back into the indoor unit and generates steam.

14.2.7 Symptom: White mist comes out of a unit (Indoor unit, outdoor unit)

When the system is changed over to heating operation after defrost operation. Moisture generated by defrost becomes steam and is exhausted.

14.2.8 Symptom: The user interface display reads "U4" or "U5" and stops, but then restarts after a few minutes

This is because the user interface is intercepting noise from electric appliances other than the air conditioner. The noise prevents communication between the units, causing them to stop. Operation automatically restarts when the noise ceases.

14.2.9 Symptom: Noise of air conditioners (Indoor unit)

- A "zeen" sound is heard immediately after the power supply is turned on. The electronic expansion valve inside an indoor unit starts working and makes the noise. Its volume will reduce in about one minute.
- A continuous low "shah" sound is heard when the system is in cooling operation or at a stop. When the drain pump (optional accessories) is in operation, this noise is heard.
- A "pishi-pishi" squeaking sound is heard when the system stops after heating operation. Expansion and contraction of plastic parts caused by temperature change make this noise.
- A low "sah", "choro-choro" sound is heard while the indoor unit is stopped. When another indoor unit is in operation, this noise is heard. In order to prevent oil and refrigerant from remaining in the system, a small amount of refrigerant is kept flowing.

14.2.10 Symptom: Noise of air conditioners (Indoor unit, outdoor unit)

- A continuous low hissing sound is heard when the system is in cooling or defrost operation. This is the sound of refrigerant gas flowing through both indoor and outdoor units.
- A hissing sound which is heard at the start or immediately after stopping operation or defrost operation. This is the noise of refrigerant caused by flow stop or flow change.

14.2.11 Symptom: Noise of air conditioners (Outdoor unit)

When the tone of operating noise changes. This noise is caused by the change of frequency.

15 Relocation

14.2.12 Symptom: Dust comes out of the unit

When the unit is used for the first time in a long time. This is because dust has gotten into the unit.

14.2.13 Symptom: The units can give off odours

The unit can absorb the smell of rooms, furniture, cigarettes, etc., and then emit it again.

14.2.14 Symptom: The outdoor unit fan does not spin

During operation. The speed of the fan is controlled in order to optimise product operation.

14.2.15 Symptom: The display shows "88"

This is the case immediately after the main power supply switch is turned on and means that the user interface is in normal condition. This continues for 1 minute.

14.2.16 Symptom: The compressor in the outdoor unit does not stop after a short heating operation

This is to prevent refrigerant from remaining in the compressor. The unit will stop after 5 to 10 minutes.

14.2.17 Symptom: The inside of an outdoor unit is warm even when the unit has stopped

This is because the crankcase heater is warming the compressor so that the compressor can start smoothly.

14.2.18 Symptom: Hot air can be felt when the indoor unit is stopped

Several different indoor units are being run on the same system. When another unit is running, some refrigerant will still flow through the unit.

15 Relocation

Contact your dealer for removing and reinstalling the total unit. Moving units requires technical expertise.

16 Disposal

This unit uses hydrofluorocarbon. Contact your dealer when discarding this unit.



NOTICE

Do NOT try to dismantle the system yourself: dismantling of the system, treatment of the refrigerant, oil and other parts MUST comply with applicable legislation. Units MUST be treated at a specialised treatment facility for reuse, recycling and recovery.

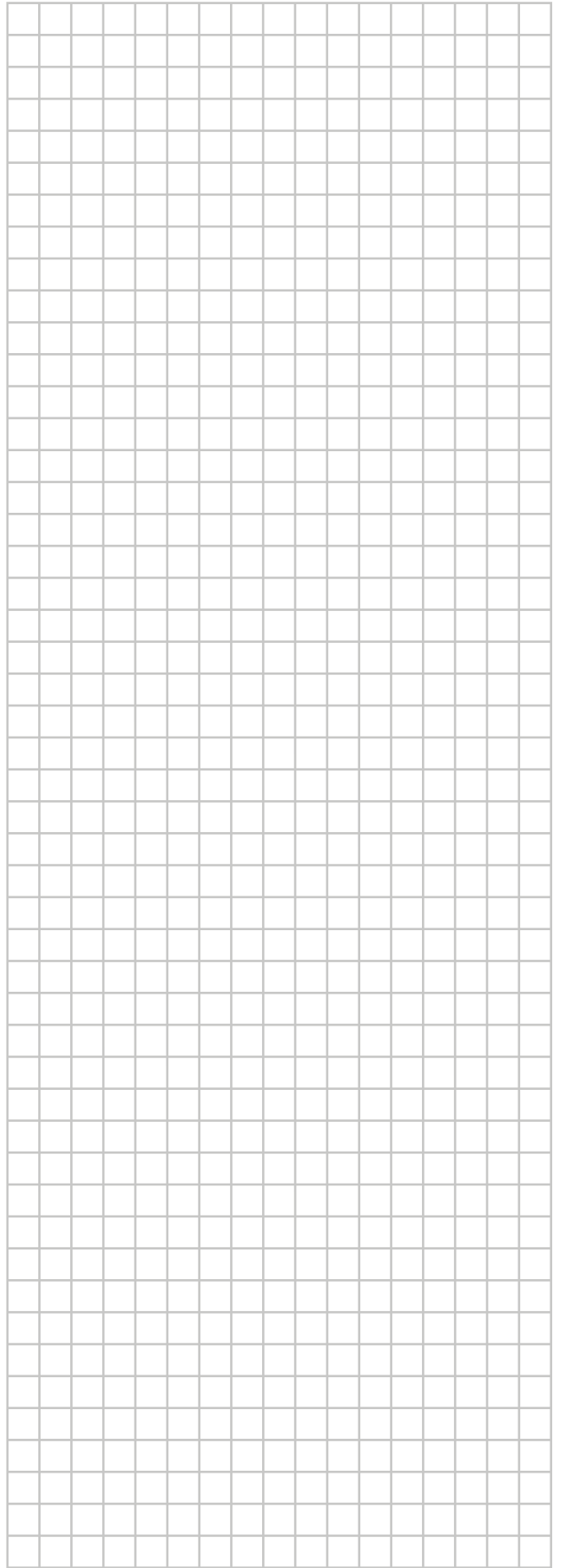
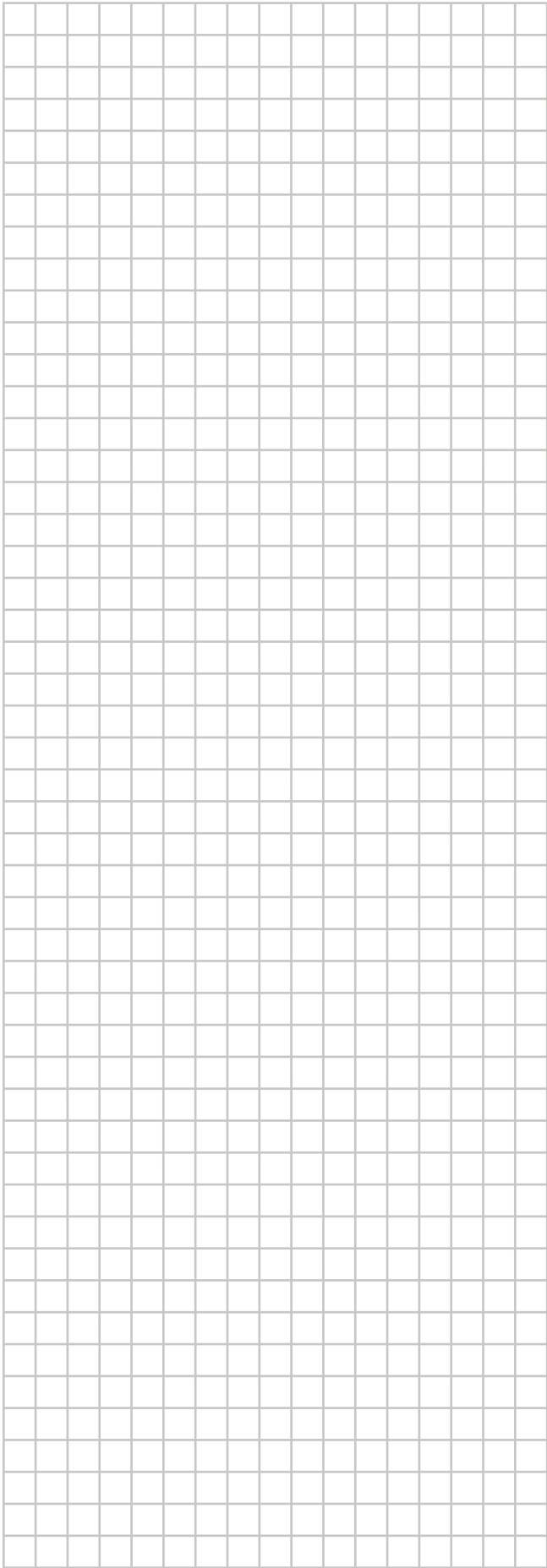

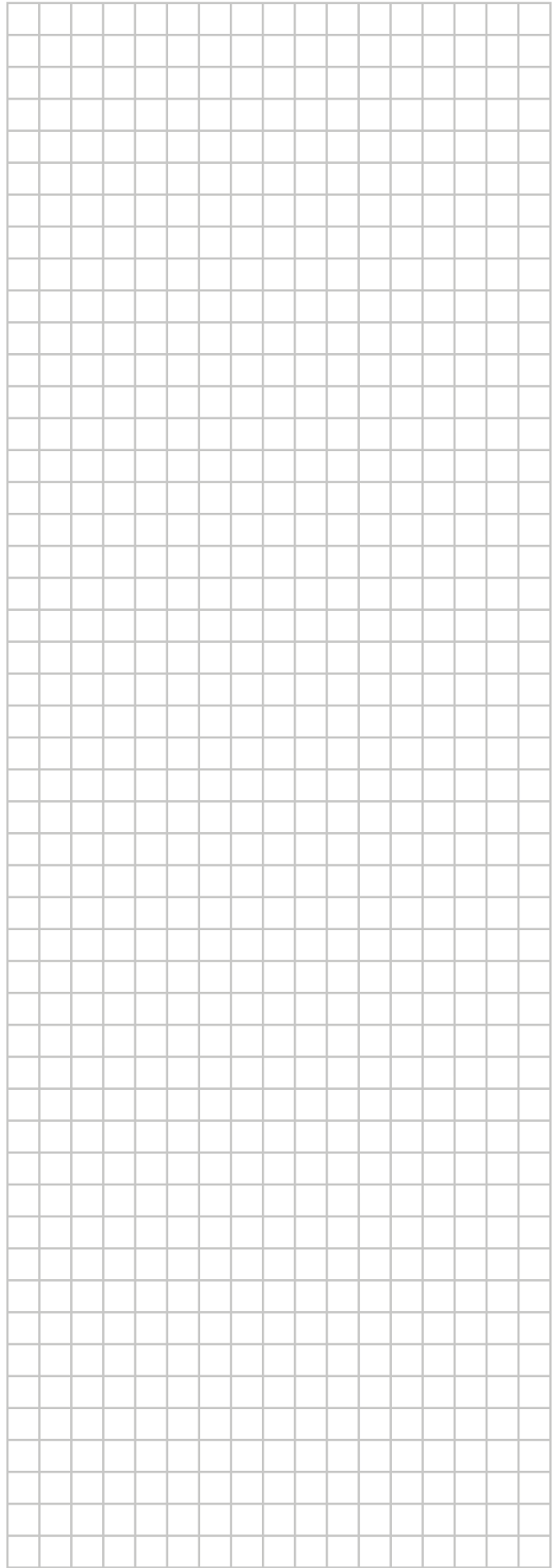

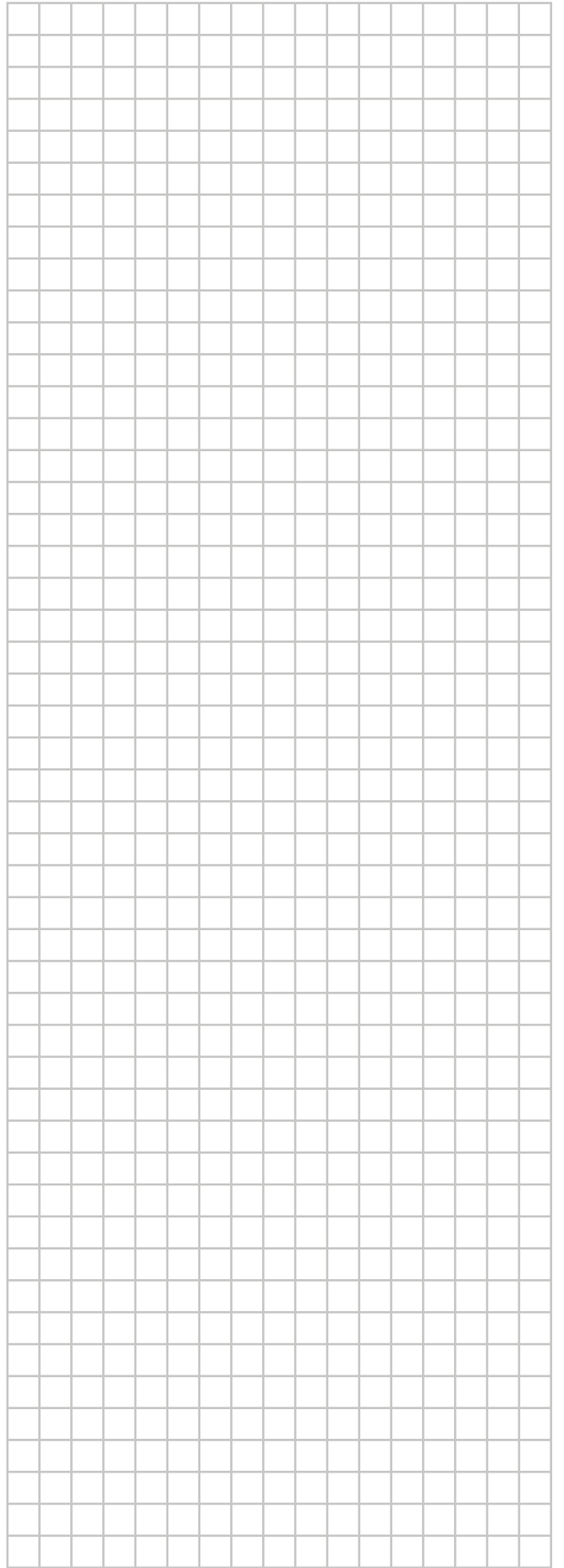

ERC



4P546222-1 000000J

Copyright 2018 Daikin

DAIKIN EUROPE N.V.

Zandvoordestraat 300, B-8400 Oostende, Belgium

4P546222-1 2018.09