

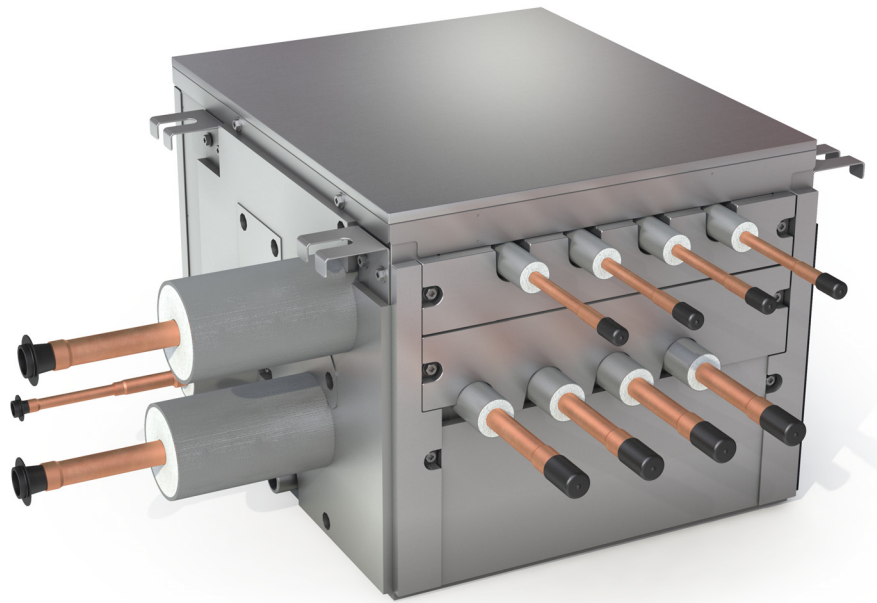

Air Conditioning Technical Data

Multi branch selector for VRV IV heat recovery



EEDEN14-200_4

BS-Q14A

TABLE OF CONTENTS

BS-Q14A

1	Features	2
2	Specifications	3
	Technical Specifications	3
	Electrical Specifications	3
3	Safety device settings	4
4	Options	5
5	Dimensional drawings	6
6	Centre of gravity	9
7	Piping diagrams	12
8	Wiring diagrams	15
	Wiring Diagrams - Single Phase	15
9	Sound data	19
	Sound Pressure Spectrum	19

1 Features

- Unique range of single and multi BS boxes for flexible and fast design
- Major reduction in installation time thanks to wide range, compact size and light weight multi BS boxes
- Up to 70% smaller and 66% lighter than previous series
- Faster installation thanks to a reduced number of brazing points and wiring
- All indoor units connectable to one BS box
- Less inspection ports needed compared to installing single BS boxes
- Up to 16kW capacity available per port
- Connect up to 250 class unit (28kW) by combining 2 ports
- No limit on unused ports allowing phased installation
- Faster installation thanks to open connection
- Connectable to REYQ-T VRV IV heat recovery units

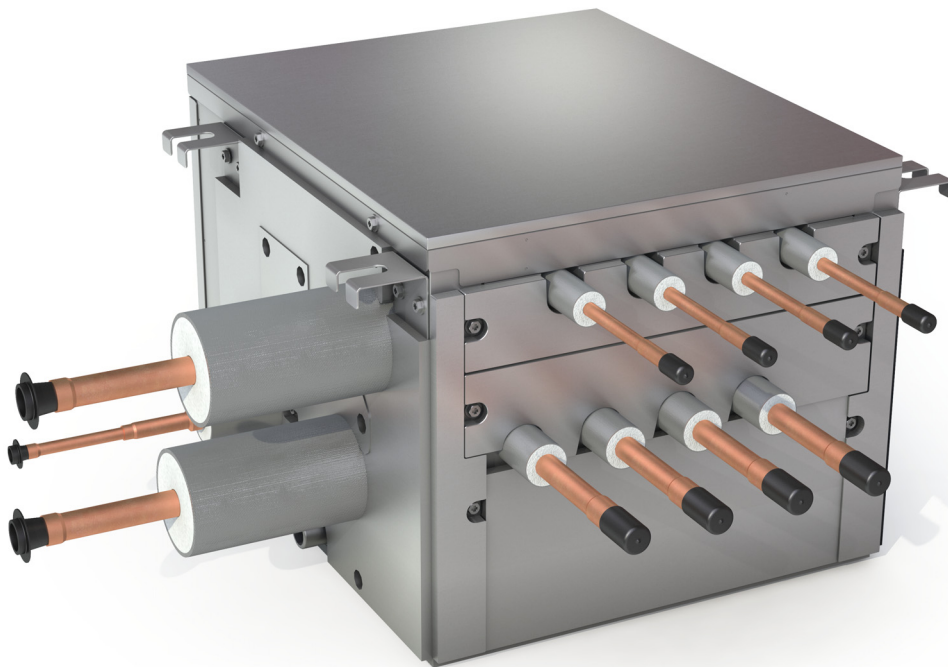

1

2 Specifications

2-1 Technical Specifications				BS4Q14A	BS6Q14A	BS8Q14A	BS10Q14A	BS12Q14A	BS16Q14A	
Power input	Cooling	Nom.	kW	0.043	0.064	0.086	0.107	0.129	0.172	
	Heating	Nom.	kW	0.043	0.064	0.086	0.107	0.129	0.172	
Maximum number of connectable indoor units				20	30	40	50	60	64	
Maximum number of connectable indoor units per branch				5						
Number of branches				4	6	8	10	12	16	
Maximum capacity index of connectable indoor units				400	600	750				
Maximum capacity index of connectable indoor units per branch				140						
Dimensions	Unit	HeightxWidthxDepth	mm	298x370x430	298x580x430		298x820x430		298x1,060x430	
Weight	Unit		kg	17	24	26	35	38	50	
Casing	Material Galvanised steel plate									
Piping connections	Outdoor unit	Liquid	OD	mm	9.5	12.7	12.7 $\text{\$}$ 15.9 (3)	15.9	15.9 $\text{\$}$ 19.1 (3)	19.1
		Gas	OD	mm	22.2 $\text{\$}$ 19.1 (3)	28.6 $\text{\$}$ 22.2 (3)	28.6	28.6 $\text{\$}$ 34.9 (3)		34.9
		Discharge gas	OD	mm	19.1 $\text{\$}$ 15.9 (3)	19.1 $\text{\$}$ 22.2 (3)	19.1 $\text{\$}$ 22.2 (3) $\text{\$}$ 28.6 (3)	28.6		
	Indoor unit	Liquid	OD	mm	9.5 (1) $\text{\$}$ 6.4 (2)					
		Gas	OD	mm	15.9 (1) $\text{\$}$ 12.7 (2)					
	Sound absorbing thermal insulation				Urethane foam, polyethylene foam					

Standard Accessories : Clamps;

Standard Accessories : Insulation tube;

Standard Accessories : Metal clamp for drain hose;

Standard Accessories : Accessory pipe;

Standard Accessories : Sealing material;

Standard Accessories : Stopper pipes;

Standard Accessories : Insulation tube for stopper pipes;

2-2 Electrical Specifications				BS4Q14A	BS6Q14A	BS8Q14A	BS10Q14A	BS12Q14A	BS16Q14A
Power supply	Phase			1~					
	Frequency			Hz 50					
	Voltage			V 220-440					
	Voltage range	Min.	%	-10					
		Max.	%	10					
Total circuit	Minimum circuit amps (MCA)			A 0.4	0.6	0.8	1.0	1.2	1.6
	Maximum fuse amps (MFA)			A 15					

Notes

- (1) When connecting indoor units smaller or equal to 50 class (no need to cut the outlet pipe)
- (2) When connecting indoor units larger or equal to 63 class (the outlet pipe needs to be cut)
- (3) Diameter when using the attached reducer. If the joint does not fit, a reducer is requested (field supply).
- (4) Insulators are necessary (field supply) for the triple piping side
- (5) Voltage range: units are suitable for use on electrical systems where voltage supplied to unit terminal is not below or above listed range limits.
- (6) Maximum allowable voltage range variation between phases is 2%.
- (7) MCA/MFA: MCA = 1.25 x FLA
- (8) MFA \leq 4 x FLA
- (9) Next lower standard fuse rating minimum 15A
- (10) Select wire size based on the value of MCA
- (11) Instead of a fuse, use a circuit breaker

3 Safety device settings

3 - 1 Safety Device Settings

3

BS-Q14A

MODEL	Safety devices	
	PC board fuse	
BS4Q14A	250V	3.15A
BS6Q14A	250V	3.15A
BS8Q14A	250V	3.15A
BS10Q14A	250V	3.15A
BS12Q14A	250V	3.15A
BS16Q14A	250V	3.15A

4D086060

4 Options

4 - 1 Options

BS-Q14A

Option name	BS4Q14A	BS6Q14A	BS8Q14A	BS10Q14A	BS12Q14A	BS162Q14A
Closed pipe kit	KHFP26A100C					
Joint kit	KHRP26A1250C					
Quiet kit	KDDN26A4	KDDN26A8		KDDN26A12		KDDN26A16

3D087639

5 Dimensional drawings

5 - 1 Dimensional Drawings

5

BS4Q14A

No.	Parts name	Remarks
1	Outdoor unit suction gas pipe connection port (Note 5, 6)	ø 22.2mm brazing connection
2	Outdoor unit HP/LP gas pipe connection port (Note 5, 6)	ø 19.1mm brazing connection
3	Outdoor unit liquid pipe connection port (Note 5, 6)	ø 9.5mm brazing connection
4	Indoor unit gas pipe connection port (Note 4)	ø 15.9mm brazing connection
5	Indoor unit gas pipe connection port (Note 4)	ø 12.7mm brazing connection
6	Indoor unit liquid pipe connection port (Note 4)	ø 9.5mm brazing connection
7	Indoor unit liquid pipe connection port (Note 4)	ø 6.4mm brazing connection
8	Electric box (Note 1)	
9	Suspension brackets	M8-M10
10	Grounding terminal	M4
11	Socket for drain	VP20 (O, D, ø 26mm/ I, D ø 20mm)
12	Attached pipe (Note 5, 6)	ø 19.1mm brazing connection
13	Attached pipe (Note 5, 6)	ø 15.9mm brazing connection
14	Inspection hole	

3D086003

NOTES

- Be sure to install an inspection door at electric box side. Another door is necessary to unload the product.
- Install it at the place where sound of refrigerant does not disturb. Must not install it at the space such as roof-space of room where person exists.
- Occupy the space with is possible to install field pipes.
- In case of connecting with a 20-50 type indoor unit, there is no need to cut and connect as it is. In case of others, cut the outlet pipe and connect to the connecting pipe. Refer to above figure.
- Reducer may be required (field supply) if joint diameter does not suit on the triple piping side.
- Insulators are necessary (field supply) for the triple piping side.
- This space is a space to keep a top panel when servicing.
- Install it in a place which can be secured downward slope of 1/100 or greater.
- It is a space for removing the drain pan.
- This is a space for removing a top panel when servicing.

BS6Q14A

No.	Parts name	Remarks
1	Outdoor unit suction gas pipe connection port (Note 5, 6)	ø 28.6mm brazing connection
2	Outdoor unit HP/LP gas pipe connection port (Note 5, 6)	ø 19.1mm brazing connection
3	Outdoor unit liquid pipe connection port (Note 5, 6)	ø 12.7mm brazing connection
4	Indoor unit gas pipe connection port (Note 4)	ø 15.9mm brazing connection
5	Indoor unit gas pipe connection port (Note 4)	ø 12.7mm brazing connection
6	Indoor unit liquid pipe connection port (Note 4)	ø 9.5mm brazing connection
7	Indoor unit liquid pipe connection port (Note 4)	ø 6.4mm brazing connection
8	Electric box (Note 1)	
9	Suspension brackets	M8-M10
10	Grounding terminal	M4
11	Socket for drain	VP20 (O, D, ø 26mm/ I, D ø 20mm)
12	Attached pipe (Note 5, 6)	ø 22.2mm brazing connection
13	Inspection hole	

3D086004

NOTES

- Be sure to install an inspection door at electric box side. Another door is necessary to unload the product.
- Install it at the place where sound of refrigerant does not disturb. Must not install it at the space such as roof-space of room where person exists.
- Occupy the space with is possible to install field pipes.
- In case of connecting with a 20-50 type indoor unit, there is no need to cut and connect as it is. In case of others, cut the outlet pipe and connect to the connecting pipe. Refer to above figure.
- Reducer may be required (field supply) if joint diameter does not suit on the triple piping side.
- Insulators are necessary (field supply) for the triple piping side.
- This space is a space to keep a top panel when servicing.
- Install it in a place which can be secured downward slope of 1/100 or greater.
- It is a space for removing the drain pan.
- This is a space for removing a top panel when servicing.

6

5 Dimensional drawings

5 - 1 Dimensional Drawings

BS8Q14A

No.	Parts name	Remarks
1	Outdoor unit suction gas pipe connection port (Note 5, 6)	ø 28.6mm brazing connection
2	Outdoor unit HP/LP gas pipe connection port (Note 5, 6)	ø 19.1mm brazing connection
3	Outdoor unit liquid pipe connection port (Note 5, 6)	ø 12.7mm brazing connection
4	Indoor unit gas pipe connection port (Note 4)	ø 15.9mm brazing connection
5	Indoor unit gas pipe connection port (Note 4)	ø 12.7mm brazing connection
6	Indoor unit liquid pipe connection port (Note 4)	ø 9.5mm brazing connection
7	Indoor unit liquid pipe connection port (Note 4)	ø 6.4mm brazing connection
8	Electric box (Note 1)	
9	Suspension brackets	M8-M10
10	Grounding terminal	M4
11	Socket for drain	VP20 (O. D., ø 26mm/ I. D ø 20mm)
12	Attached pipe (Note 5, 6)	ø 28.6mm brazing connection
13	Attached pipe (Note 5, 6)	ø 22.2mm brazing connection
14	Attached pipe (Note 5, 6)	ø 15.9mm brazing connection
15	Inspection hole	

3D086005

NOTES

- Be sure to install an inspection door at electric box side. Another door is necessary to unload the product.
- Install it at the place where sound of refrigerant does not disturb. Must not install it at the space such as roof-space of room where person exists.
- Occupy the space with is possible to install field pipes.
- In case of connecting with a 20-50 type indoor unit, there is no need to cut and connect as it is. In case of others, cut the outlet pipe and connect to the connecting pipe. Refer to above figure.
- Reducer may be required (field supply) if joint diameter does not suit on the triple piping side.
- Insulators are necessary (field supply) for the triple piping side.
- This space is a space to keep a top panel when servicing.
- Install it in a place which can be secured downward slope of 1/100 or greater.
- It is a space for removing the drain pan.
- This is a space for removing a top panel when servicing.

BS10Q14A

No.	Parts name	Remarks
1	Outdoor unit suction gas pipe connection port (Note 5, 6)	ø 28.6mm brazing connection
2	Outdoor unit HP/LP gas pipe connection port (Note 5, 6)	ø 28.6mm brazing connection
3	Outdoor unit liquid pipe connection port (Note 5, 6)	ø 15.9mm brazing connection
4	Indoor unit gas pipe connection port (Note 4)	ø 15.9mm brazing connection
5	Indoor unit gas pipe connection port (Note 4)	ø 12.7mm brazing connection
6	Indoor unit liquid pipe connection port (Note 4)	ø 9.5mm brazing connection
7	Indoor unit liquid pipe connection port (Note 4)	ø 6.4mm brazing connection
8	Electric box (Note 1)	
9	Suspension brackets	M8-M10
10	Grounding terminal	M4
11	Socket for drain	VP20 (O. D., ø 26mm/ I. D ø 20mm)
12	Attached pipe (Note 5, 6)	ø 34.9mm brazing connection
13	Inspection hole	

3D086006

NOTES

- Be sure to install an inspection door at electric box side. Another door is necessary to unload the product.
- Install it at the place where sound of refrigerant does not disturb. Must not install it at the space such as roof-space of room where person exists.
- Occupy the space with is possible to install field pipes.
- In case of connecting with a 20-50 type indoor unit, there is no need to cut and connect as it is. In case of others, cut the outlet pipe and connect to the connecting pipe. Refer to above figure.
- Reducer may be required (field supply) if joint diameter does not suit on the triple piping side.
- Insulators are necessary (field supply) for the triple piping side.
- This space is a space to keep a top panel when servicing.
- Install it in a place which can be secured downward slope of 1/100 or greater.
- It is a space for removing the drain pan.
- This is a space for removing a top panel when servicing.

5 Dimensional drawings

5 - 1 Dimensional Drawings

5

BS12Q14A

No.	Parts name	Remarks
1	Outdoor unit suction gas pipe connection port (Note 5, 6)	ø 28.6mm brazing connection
2	Outdoor unit HP/LP gas pipe connection port (Note 5, 6)	ø 28.6mm brazing connection
3	Outdoor unit liquid pipe connection port (Note 5, 6)	ø 15.9mm brazing connection
4	Indoor unit gas pipe connection port (Note 4)	ø 15.9mm brazing connection
5	Indoor unit gas pipe connection port (Note 4)	ø 12.7mm brazing connection
6	Indoor unit liquid pipe connection port (Note 4)	ø 9.5mm brazing connection
7	Indoor unit liquid pipe connection port (Note 4)	ø 6.4mm brazing connection
8	Electric box (Note 1)	
9	Suspension brackets	M8-M10
10	Grounding terminal	M4
11	Socket for drain	VP20 (O, D, ø 26mm/ I, D ø 20mm)
12	Attached pipe (Note 5, 6)	ø 34.9mm brazing connection
13	Attached pipe (Note 5, 6)	ø 19.1mm brazing connection
14	Inspection hole	

3D086007

NOTES

- Be sure to install an inspection door at electric box side. Another door is necessary to unload the product.
- Install it at the place where sound of refrigerant does not disturb. Must not install it at the space such as roof-space of room where person exists.
- Occupy the space with is possible to install field pipes.
- In case of connecting with a 20-50 type indoor unit, there is no need to cut and connect as it is. In case of others, cut the outlet pipe and connect to the connecting pipe. Refer to above figure.
- Reducer may be required (field supply) if joint diameter does not suit on the triple piping side.
- Insulators are necessary (field supply) for the triple piping side.
- This space is a space to keep a top panel when servicing.
- Install it in a place which can be secured downward slope of 1/100 or greater.
- It is a space for removing the drain pan.
- This is a space for removing a top panel when servicing.

BS16Q14A

No.	Parts name	Remarks
1	Outdoor unit suction gas pipe connection port (Note 5, 6)	ø 34.9mm brazing connection
2	Outdoor unit HP/LP gas pipe connection port (Note 5, 6)	ø 28.6mm brazing connection
3	Outdoor unit liquid pipe connection port (Note 5, 6)	ø 19.1mm brazing connection
4	Indoor unit gas pipe connection port (Note 4)	ø 15.9mm brazing connection
5	Indoor unit gas pipe connection port (Note 4)	ø 12.7mm brazing connection
6	Indoor unit liquid pipe connection port (Note 4)	ø 9.5mm brazing connection
7	Indoor unit liquid pipe connection port (Note 4)	ø 6.4mm brazing connection
8	Electric box (Note 1)	
9	Suspension brackets	M8-M10
10	Grounding terminal	M4
11	Socket for drain	VP20 (O, D, ø 26mm/ I, D ø 20mm)
12	Inspection hole	

3D086008

NOTES

- Be sure to install an inspection door at electric box side. Another door is necessary to unload the product.
- Install it at the place where sound of refrigerant does not disturb. Must not install it at the space such as roof-space of room where person exists.
- Occupy the space with is possible to install field pipes.
- In case of connecting with a 20-50 type indoor unit, there is no need to cut and connect as it is. In case of others, cut the outlet pipe and connect to the connecting pipe. Refer to above figure.
- Reducer may be required (field supply) if joint diameter does not suit on the triple piping side.
- Insulators are necessary (field supply) for the triple piping side.
- This space is a space to keep a top panel when servicing.
- Install it in a place which can be secured downward slope of 1/100 or greater.
- It is a space for removing the drain pan.
- This is a space for removing a top panel when servicing.

8

6 Centre of gravity

6 - 1 Centre of Gravity

BS4Q14A

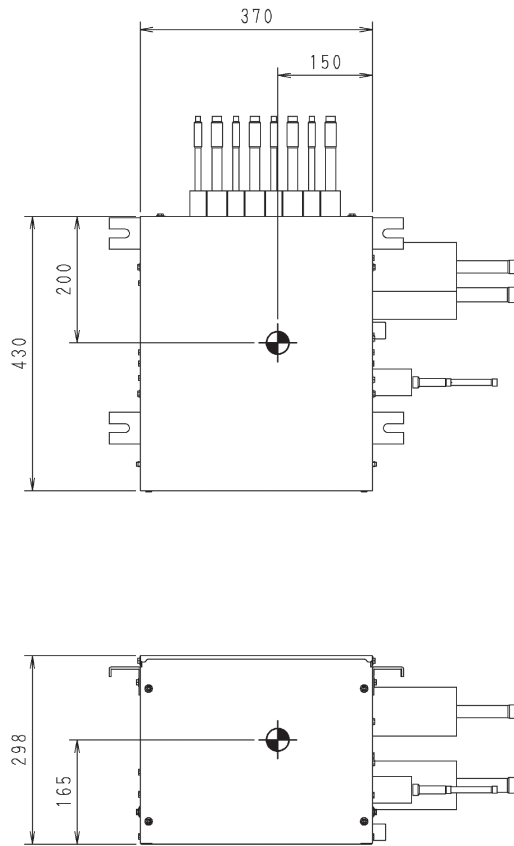

4D086046

BS6Q14A

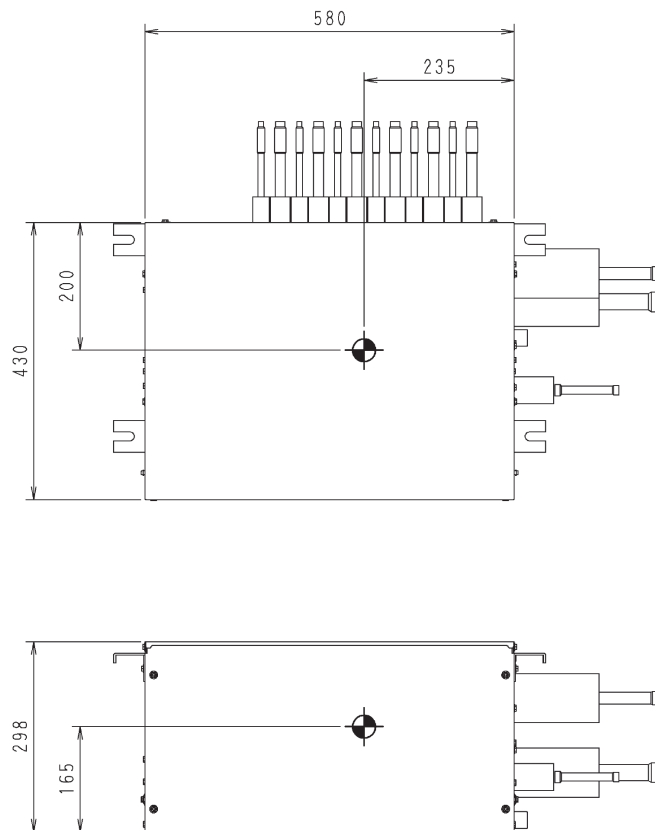

4D086047

6 Centre of gravity

6 - 1 Centre of Gravity

6

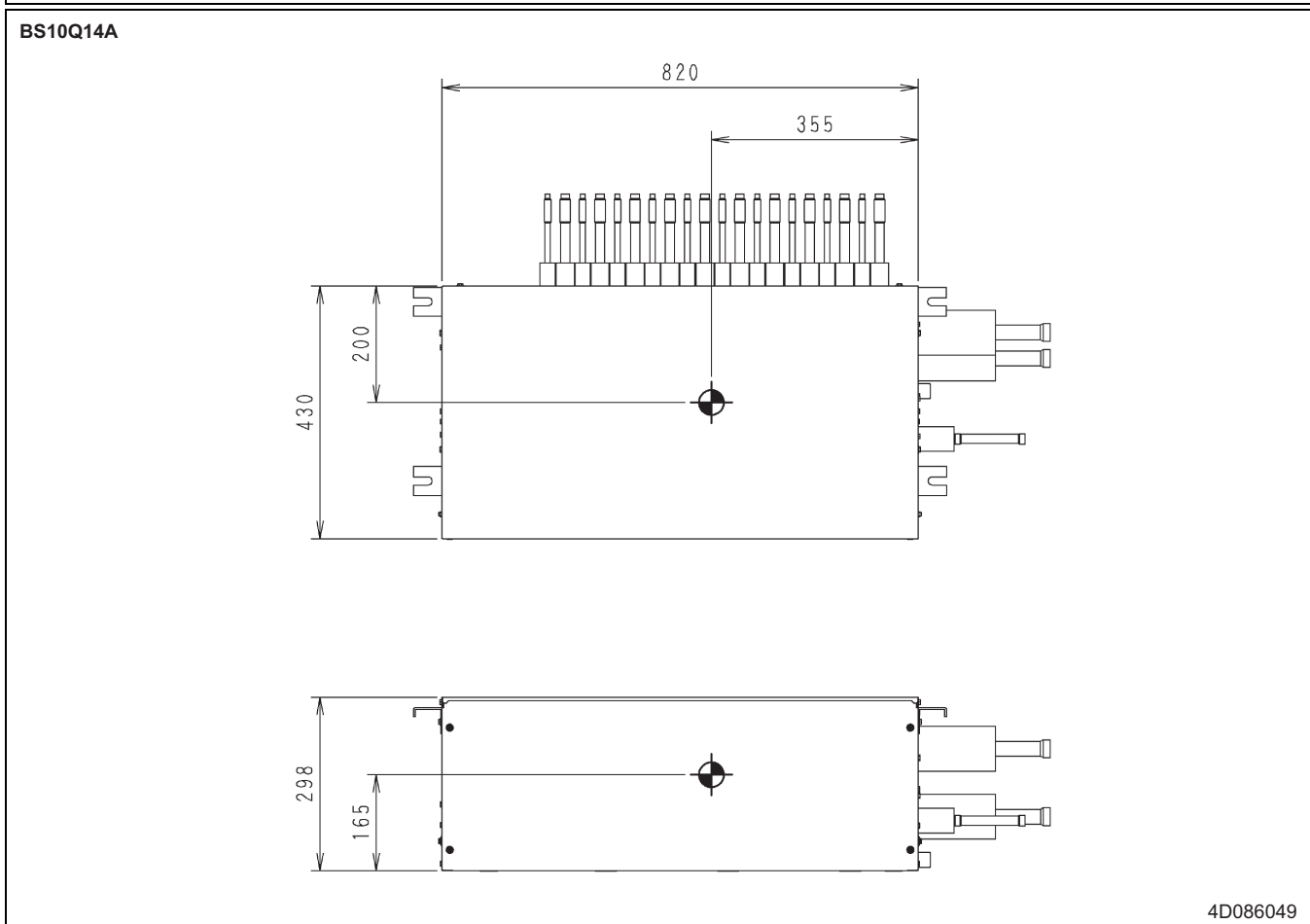
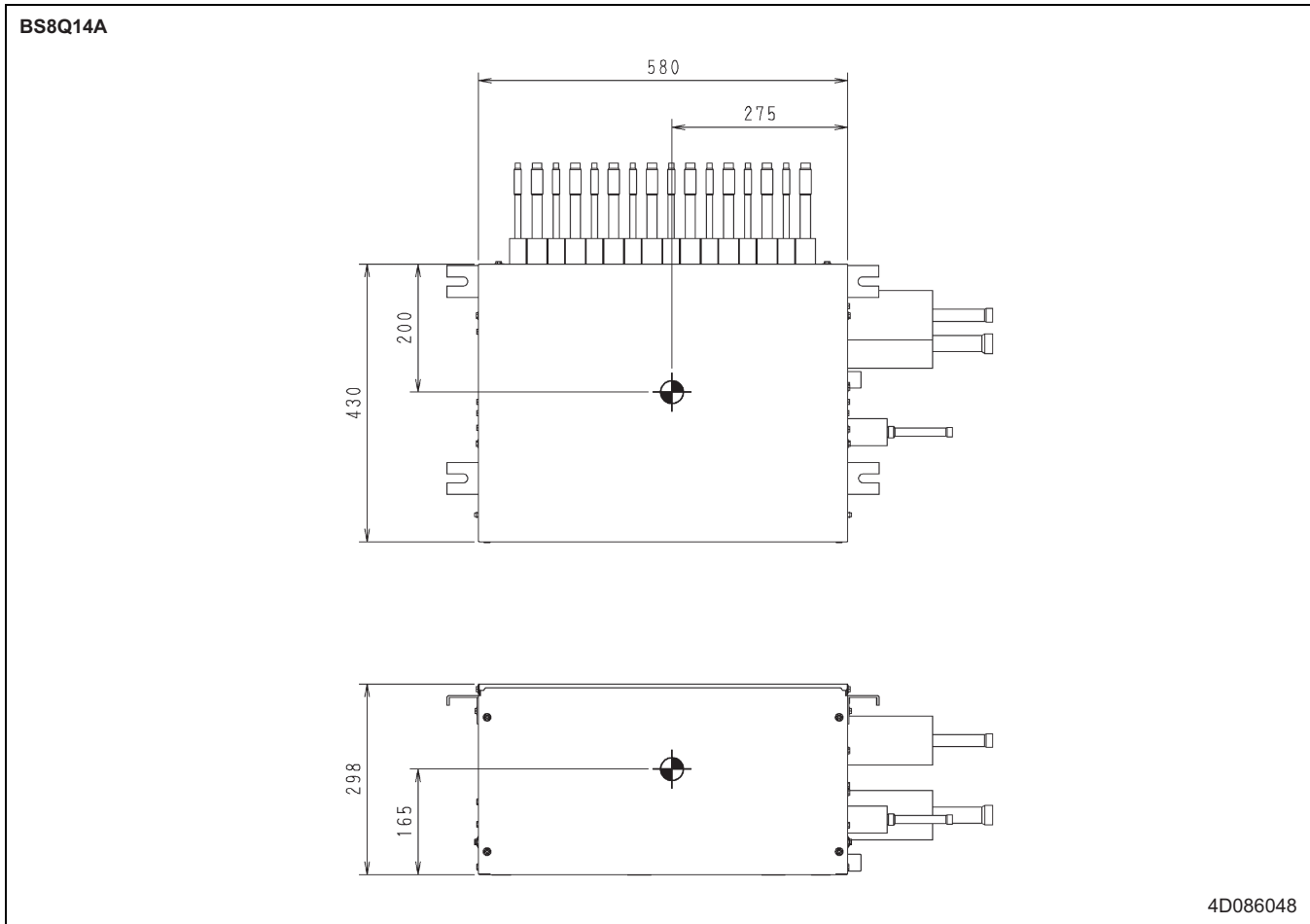

6 Centre of gravity

6 - 1 Centre of Gravity

BS12Q14A

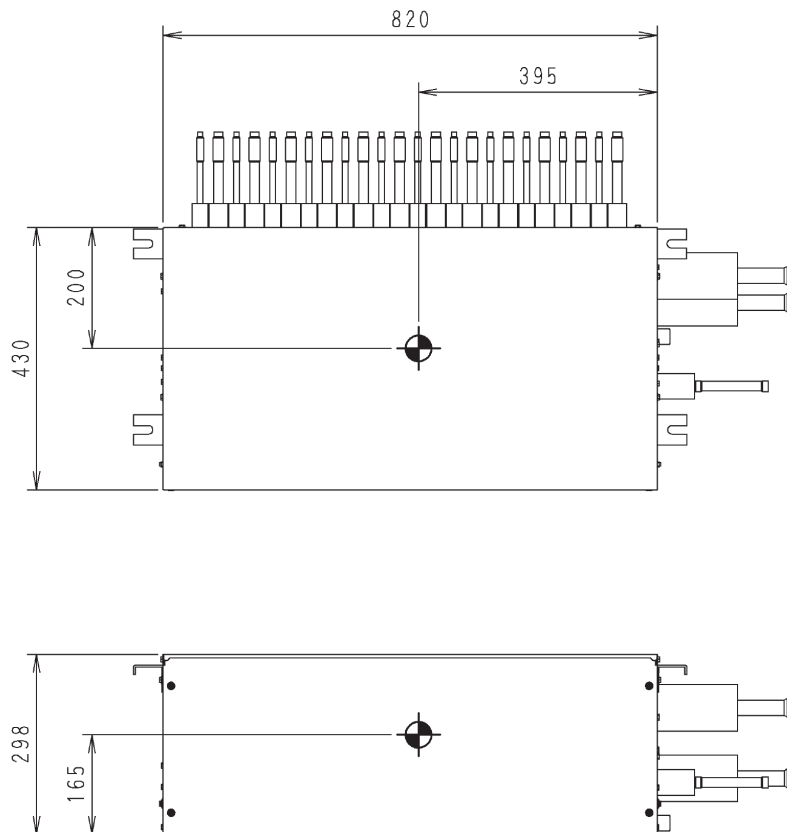

4D086050

BS16Q14A

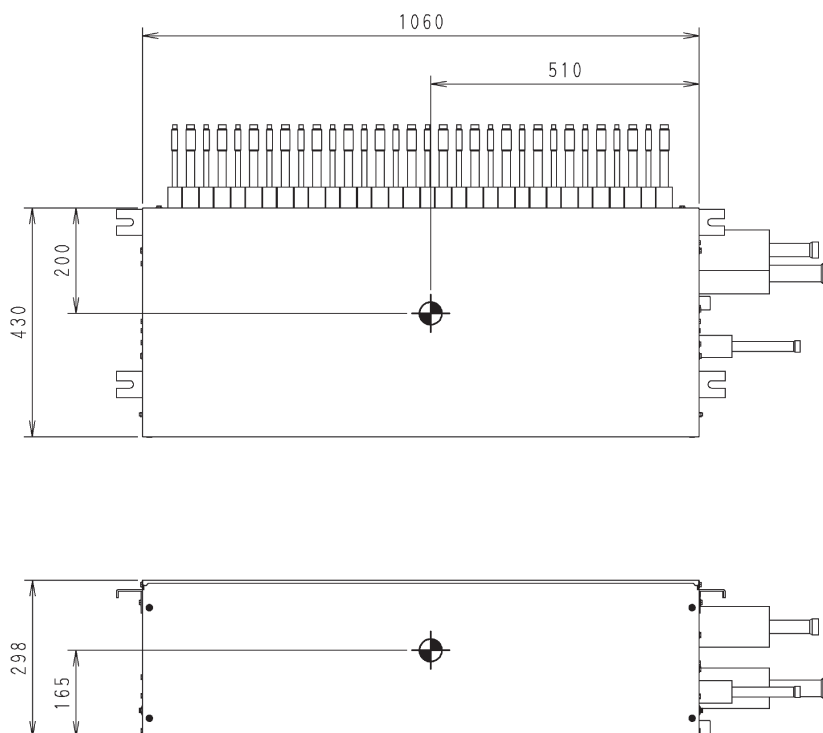

4D086051

7 Piping diagrams

7 - 1 Piping Diagrams

7

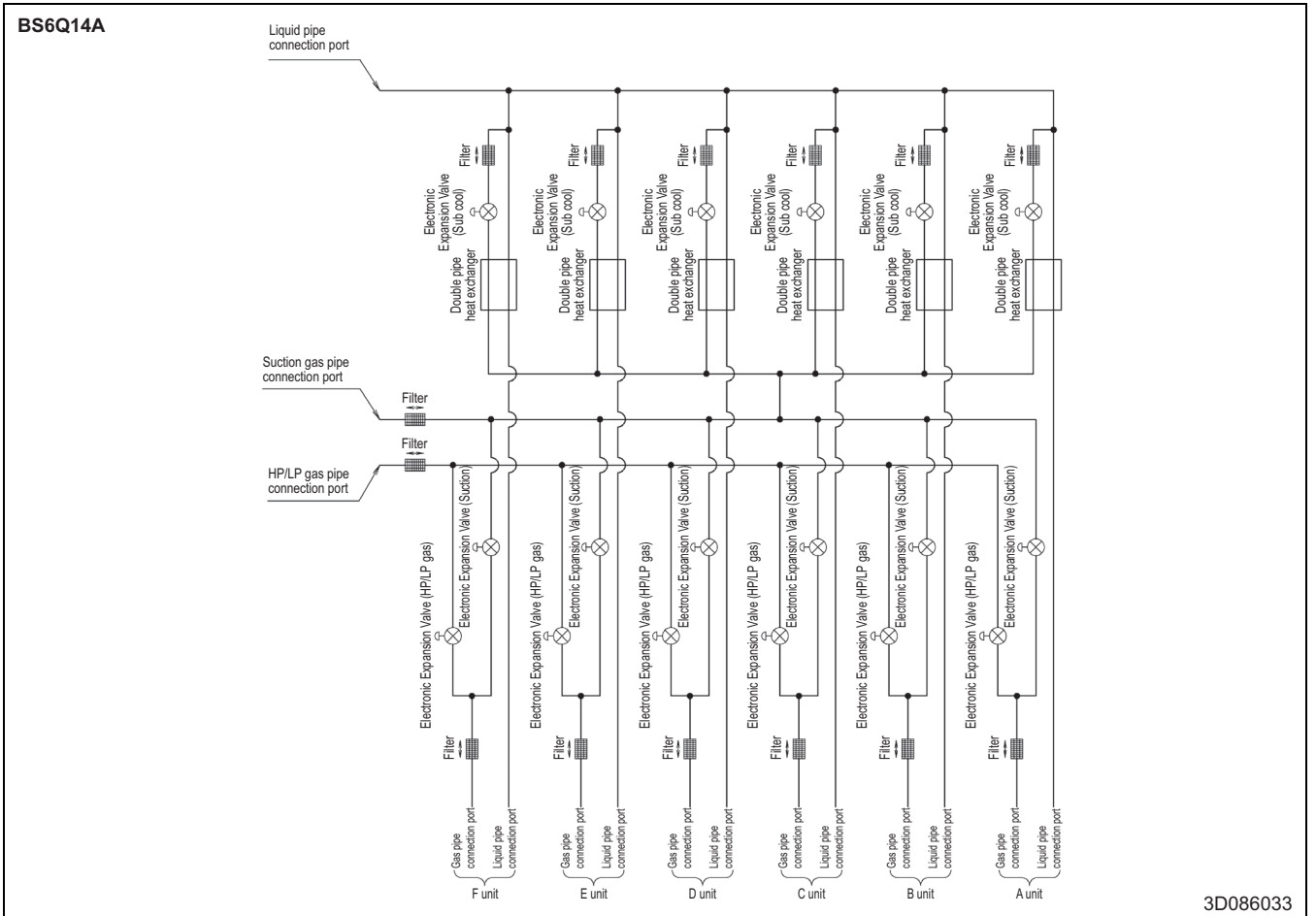
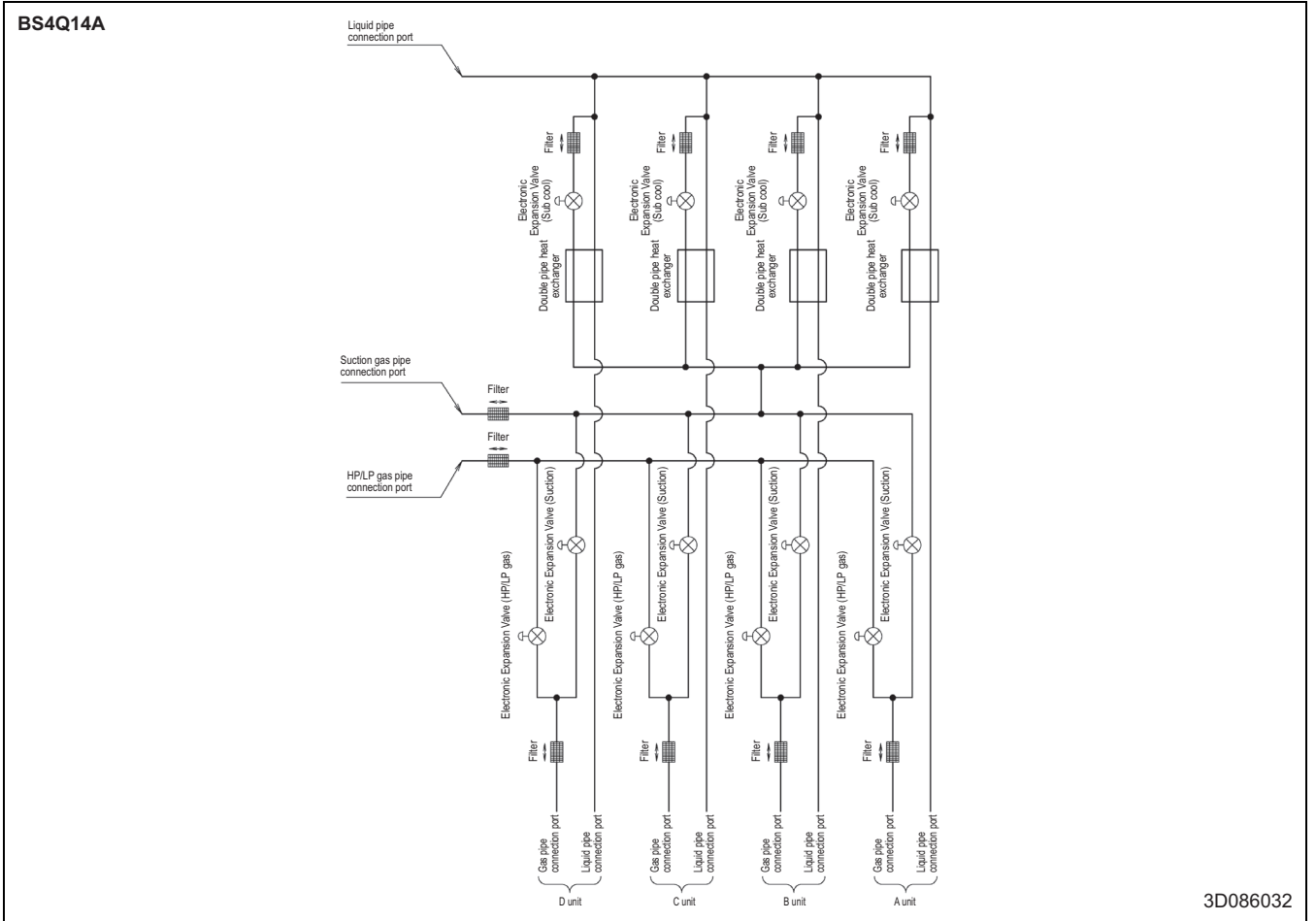

7 Piping diagrams

7 - 1 Piping Diagrams

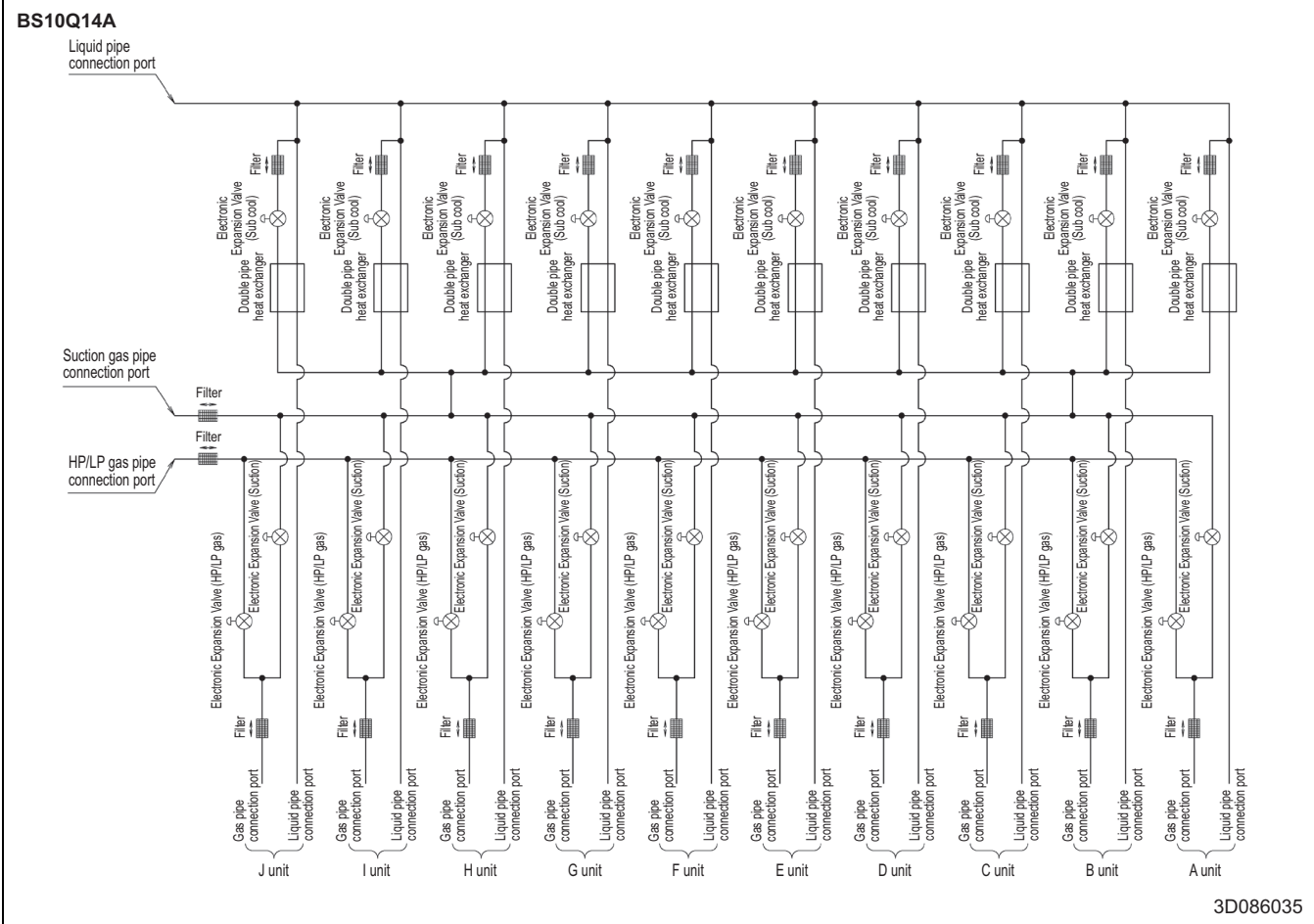
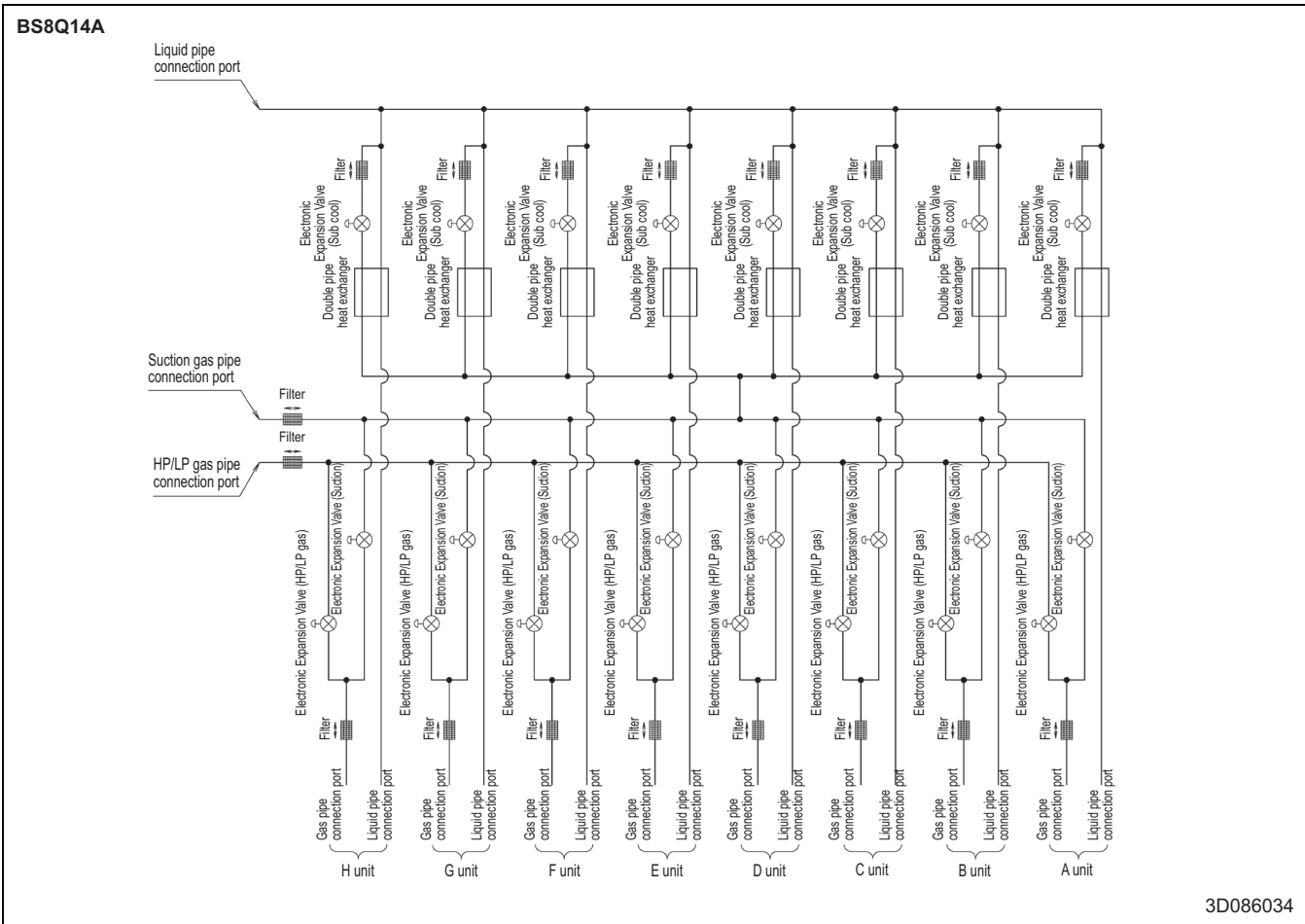

7 Piping diagrams

7 - 1 Piping Diagrams

7

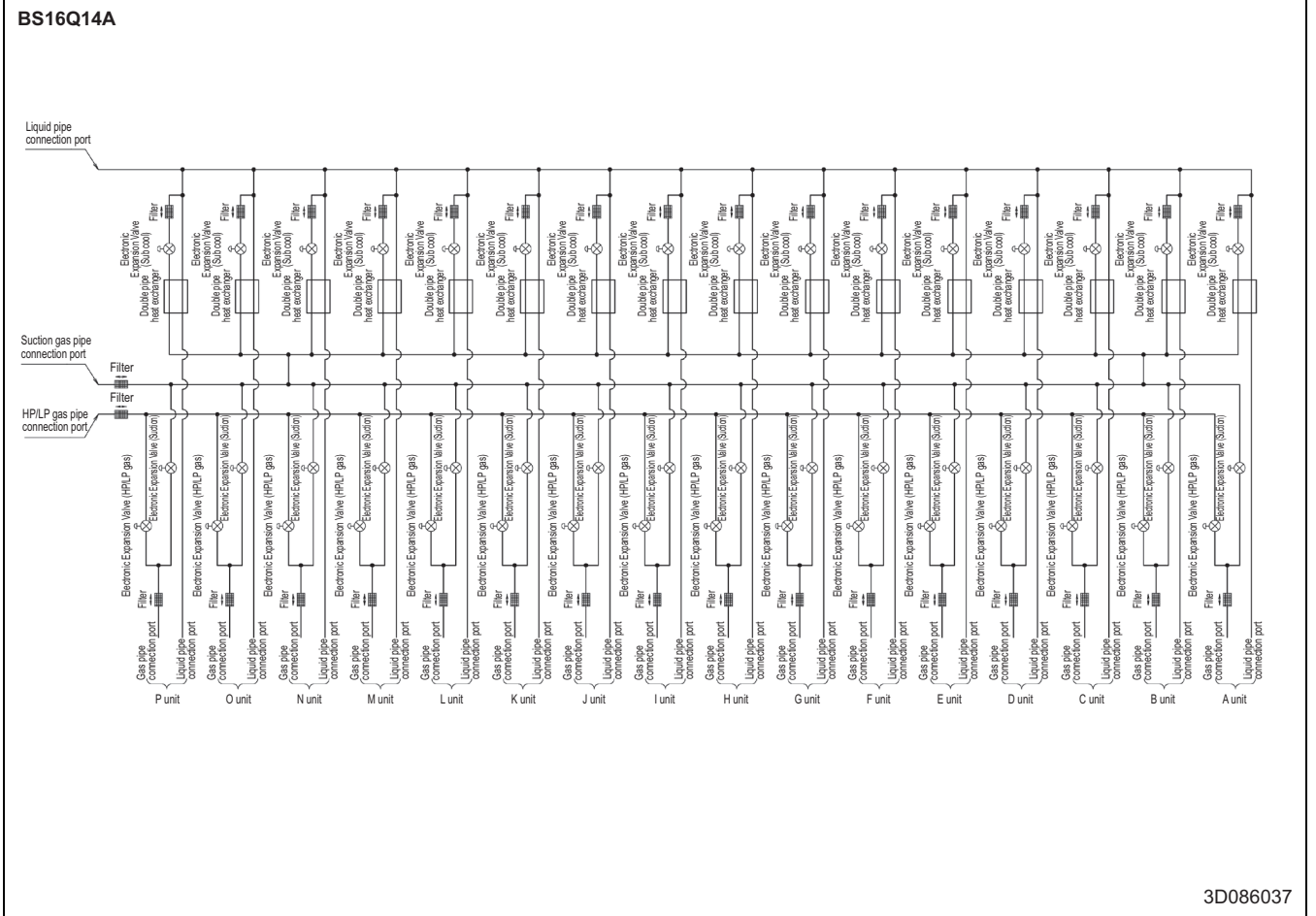
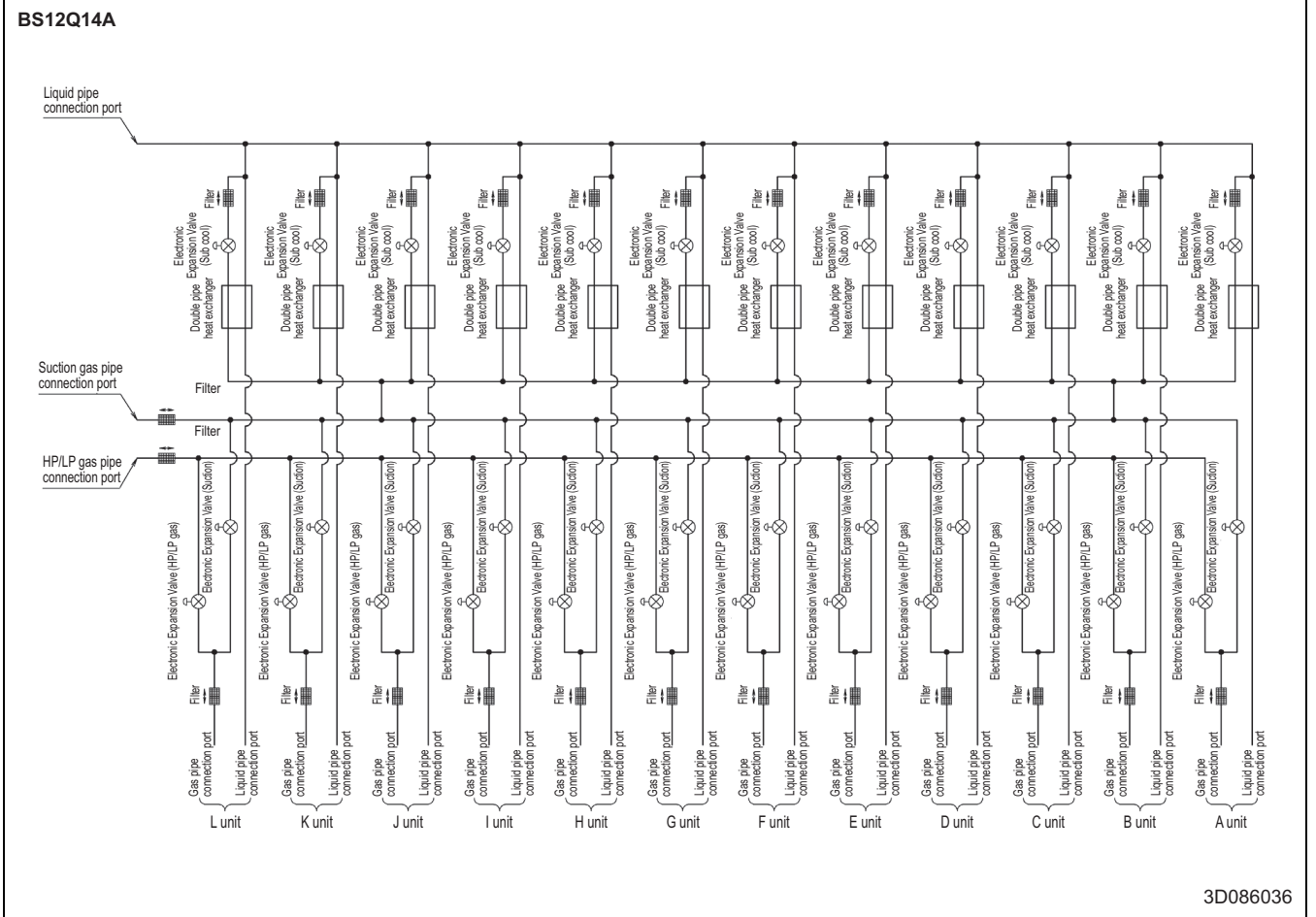

8 Wiring diagrams

8 - 1 Wiring Diagrams - Single Phase

BS4Q14A

Power supply

1~220-240V 50Hz

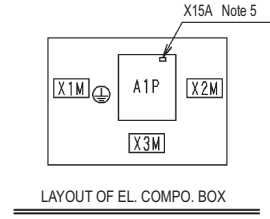
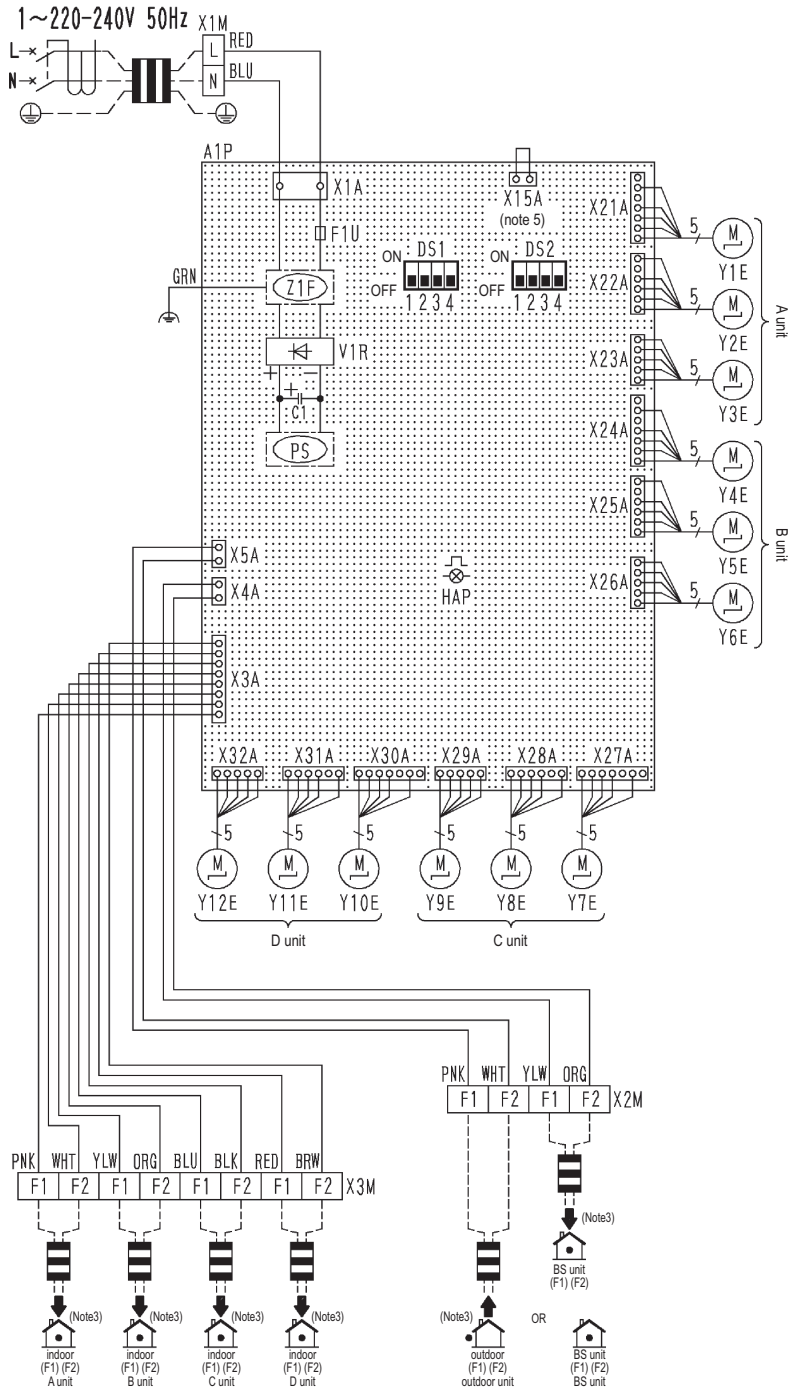

NOTES

- 1 This wiring diagram is for BS units only.
- 2 The marks in this diagram indicate: Terminal block, Connector, Field wiring, Earth terminal.
- 3 For wiring for the terminal block X2M • X3M (operation), refer to the installation manual attached to the product.
- 4 The factory setting of dip switch (DS1 • DS2) are as follows. For the setting method of dip switch (DS1 • DS2), refer to 'the installation manual' and 'precaution for service' attached on the control box cover.

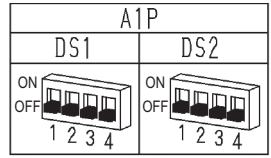

- 5 As for X15A(A1P), remove the short circuit connector and connect the air conditioner stop signal (optional product) when using the drain-up kit (optional product). For details, please refer to the operation manual attached to the kit.

A1P	Printed circuit board (Control)	Y4E	Electric expansion valve (Suction)	
C1	Capacitor	Y5E	Electric expansion valve (HP/LP Gas)	B unit
DS1, DS2	Dip switch	Y6E	Electric expansion valve (Sub cool)	
F1U	Fuse (T, 3.15A, 250V)	Y7E	Electric expansion valve (Suction)	
HAP	Flashing lamp (Service monitor-green)	Y8E	Electric expansion valve (HP/LP Gas)	C unit
PS	Switching power supply	Y9E	Electric expansion valve (Sub cool)	
V1R	Diode bridge	Y10E	Electric expansion valve (Suction)	
X1M	Terminal strip (Power)	Y11E	Electric expansion valve (HP/LP Gas)	D unit
X2M, X3M	Terminal strip (Transmission)	Y12E	Electric expansion valve (Sub cool)	
Z1F	Noise filter			
Y1E	Electric expansion valve (Suction)			A unit
Y2E	Electric expansion valve (HP/LP Gas)			
Y3E	Electric expansion valve (Sub cool)			
			Optional accessories	
		X15A	Connector (drain up kit abnormal signal)	

3D086235

8 Wiring diagrams

8 - 1 Wiring Diagrams - Single Phase

8

BS6-8Q14A

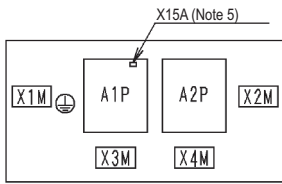
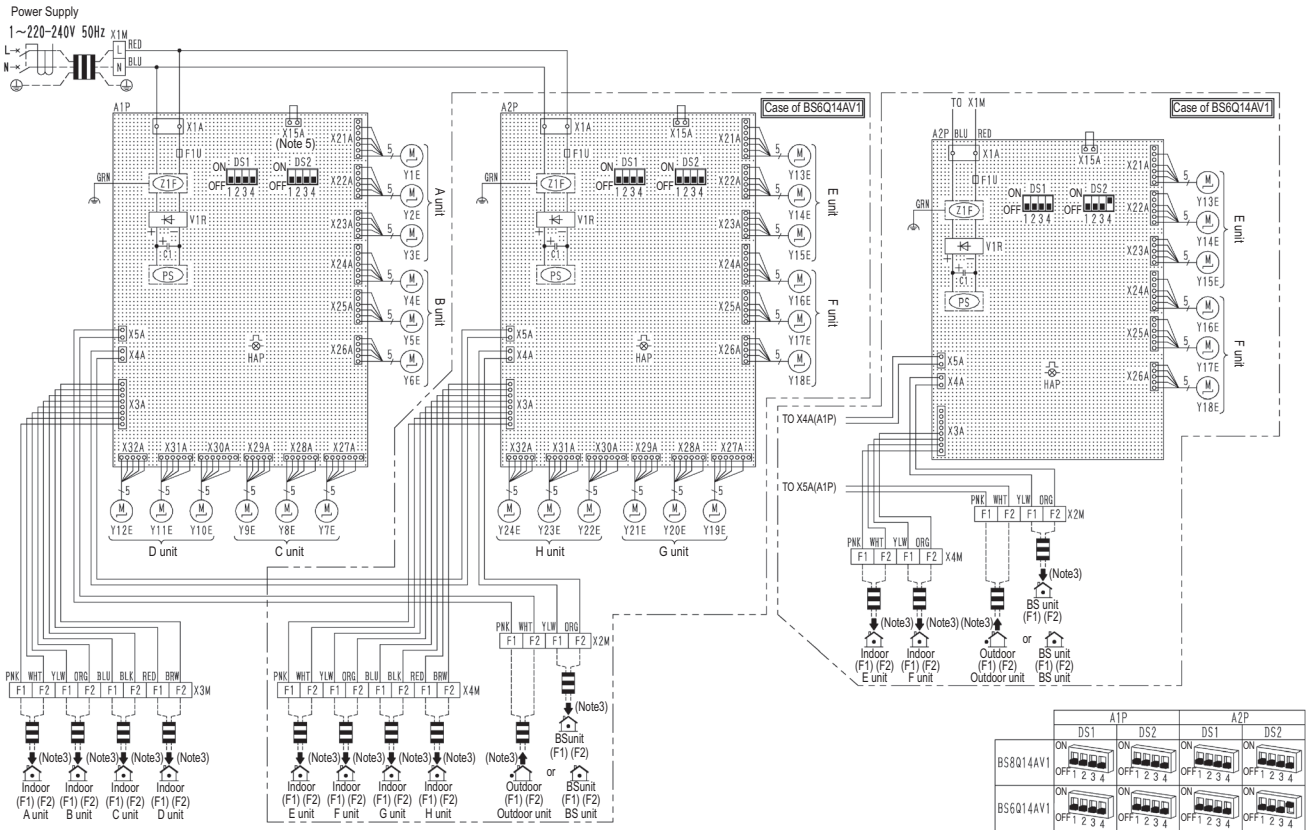

A1P, A2P	Printed circuit board (Control)	Y4E	Electric expansion valve (Suction)	Y16E	Electric expansion valve (Suction)	
C1	Capacitor (A1P, A2P)	Y5E	Electric expansion valve (HP/LP Gas)	Y17E	Electric expansion valve (HP/LP Gas)	B unit
DS1, DS2	Dip switch (A1P, A2P)	Y6E	Electric expansion valve (Sub cool)	Y18E	Electric expansion valve (Sub cool)	F unit
F1U	Fuse (T, 3.15A 250V (A1P, A2P))	Y7E	Electric expansion valve (Suction)	Y19E	Electric expansion valve (Suction)	
HAP	Flashing lamp (Service monitor - green) (A1P, A2P)	Y8E	Electric expansion valve (HP/LP Gas)	Y20E	Electric expansion valve (HP/LP Gas)	C unit
PS	Switching power supply (A1P, A2P)	Y9E	Electric expansion valve (Sub cool)	Y21E	Electric expansion valve (Sub cool)	
V1R	Diode bridge (A1P, A2P)	Y10E	Electric expansion valve (Suction)	Y22E	Electric expansion valve (Suction)	
X1M	Terminal strip (Power)	Y11E	Electric expansion valve (HP/LP Gas)	Y23E	Electric expansion valve (HP/LP Gas)	D unit
X2M-X4M	Terminal strip (Transmission)	Y12E	Electric expansion valve (Sub cool)	Y24E	Electric expansion valve (Sub cool)	H unit
Z1P	Noise filter (A1P, A2P)	Y13E	Electric expansion valve (Suction)	Optional Accessories		
Y1E	Electric expansion valve (Suction)	Y14E	Electric expansion valve (HP/LP Gas)	X15A	Connector (Drain up kit abnormal signal) (A1P)	
Y2E	Electric expansion valve (HP/LP Gas)	Y15E	Electric expansion valve (Sub cool)			
Y3E	Electric expansion valve (Sub cool)					

2D086236

NOTES

- This wiring diagram is for BS units only.
- The marks in this diagram indicate: Terminal block, Connector, Field wiring, Earth terminal
- For wiring for the terminal block X2M-X4M (operation), refer to the installation manual attached to the product.
- The factory setting of dip switch (DS1 • DS2) are as follows. For the setting method of dip switch (DS1 • DS2), refer to 'the installation manual' and 'precaution for service' attached on the control box cover.
- As for X15A(A1P), remove the short circuit connector and connect the air conditioner stop signal (optional product) when using the drain-up kit (optional product). For details, please refer to the operation manual attached to the kit.

8 Wiring diagrams

8 - 1 Wiring Diagrams - Single Phase

BS10-12Q14A

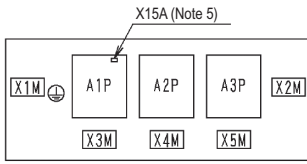
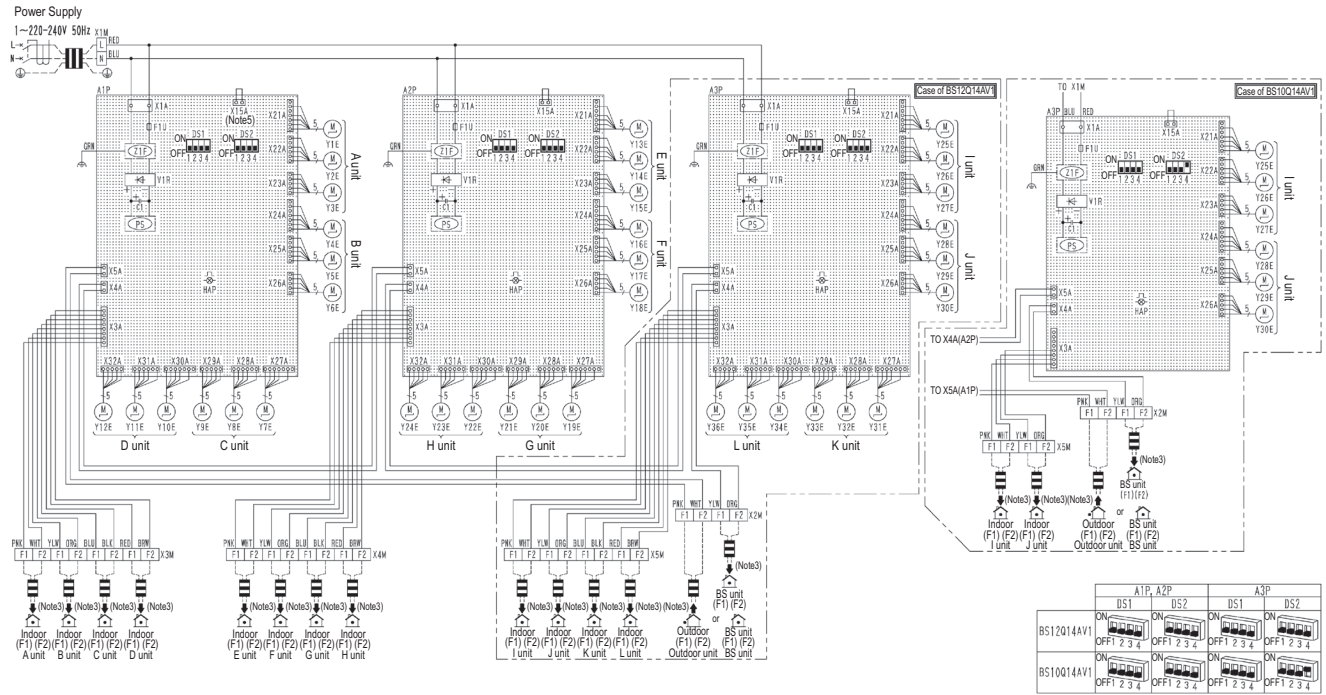

LAYOUT OF EL. COMPO. BOX

A1P~A3P	Printed circuit board (Control)	Y7E	Electric expansion valve (Suction)	C unit	Y22E	Electric expansion valve (Suction)	H unit
C1	Capacitor (A1P~ A3P)	Y8E	Electric expansion valve (HP/LP Gas)		Y23E	Electric expansion valve (HP/LP Gas)	
DS1, DS2	Dip switch (A1P~ A3P)	Y9E	Electric expansion valve (Sub cool)	D unit	Y24E	Electric expansion valve (Sub cool)	I unit
F1U	Fuse (T, 3.15A 250V (A1P~ A3P))	Y10E	Electric expansion valve (Suction)		Y25E	Electric expansion valve (Suction)	
HAP	Flashing lamp (Service monitor - green) (A1P~ A3P)	Y11E	Electric expansion valve (HP/LP Gas)	E unit	Y26E	Electric expansion valve (HP/LP Gas)	J unit
PS	Switching power supply (A1P~ A3P)	Y12E	Electric expansion valve (Sub cool)		Y27E	Electric expansion valve (Sub cool)	
V1R	Diode bridge (A1P~ A3P)	Y13E	Electric expansion valve (Suction)	F unit	Y28E	Electric expansion valve (Suction)	K unit
X1M	Terminal strip (Power)	Y14E	Electric expansion valve (HP/LP Gas)		Y29E	Electric expansion valve (HP/LP Gas)	
X2M~X5M	Terminal strip (Transmission)	Y15E	Electric expansion valve (Sub cool)	G unit	Y30E	Electric expansion valve (Sub cool)	L unit
Z1F	Noise filter (A1P~ A3P)	Y16E	Electric expansion valve (Suction)		Y31E	Electric expansion valve (Suction)	
Y1E	Electric expansion valve (Suction)	A unit	Y17E	Electric expansion valve (HP/LP Gas)	Y32E	Electric expansion valve (HP/LP Gas)	K unit
Y2E	Electric expansion valve (HP/LP Gas)		Y18E	Electric expansion valve (Sub cool)	Y33E	Electric expansion valve (Sub cool)	
Y3E	Electric expansion valve (Sub cool)	B unit	Y19E	Electric expansion valve (Suction)	Y34E	Electric expansion valve (Suction)	L unit
Y4E	Electric expansion valve (Suction)		Y20E	Electric expansion valve (HP/LP Gas)	Y35E	Electric expansion valve (HP/LP Gas)	
Y5E	Electric expansion valve (HP/LP Gas)	G unit	Y21E	Electric expansion valve (Sub cool)	Y36E	Electric expansion valve (Sub cool)	L unit
Y6E	Electric expansion valve (Sub cool)						
Optional Accessories							
X15A	Connector (Drain up kit abnormal signal) (A1P)						

2D086237

NOTES

- This wiring diagram is for BS units only.
- The marks in this diagram indicate: : Terminal block, : Connector, : Field wiring, : Earth terminal
- For wiring for the terminal block X2M~X5M (operation), refer to the installation manual attached to the product.
- The factory setting of dip switch (DS1 • DS2) are as follows. For the setting method of dip switch (DS1 • DS2), refer to 'the installation manual' and 'precaution for service' attached on the control box cover.
- As for X15A(A1P), remove the short circuit connector and connect the air conditioner stop signal (optional product) when using the drain-up kit (optional product). For details, please refer to the operation manual attached to the kit.

8 Wiring diagrams

8 - 1 Wiring Diagrams - Single Phase

8

BS16Q14A

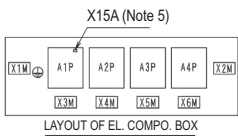
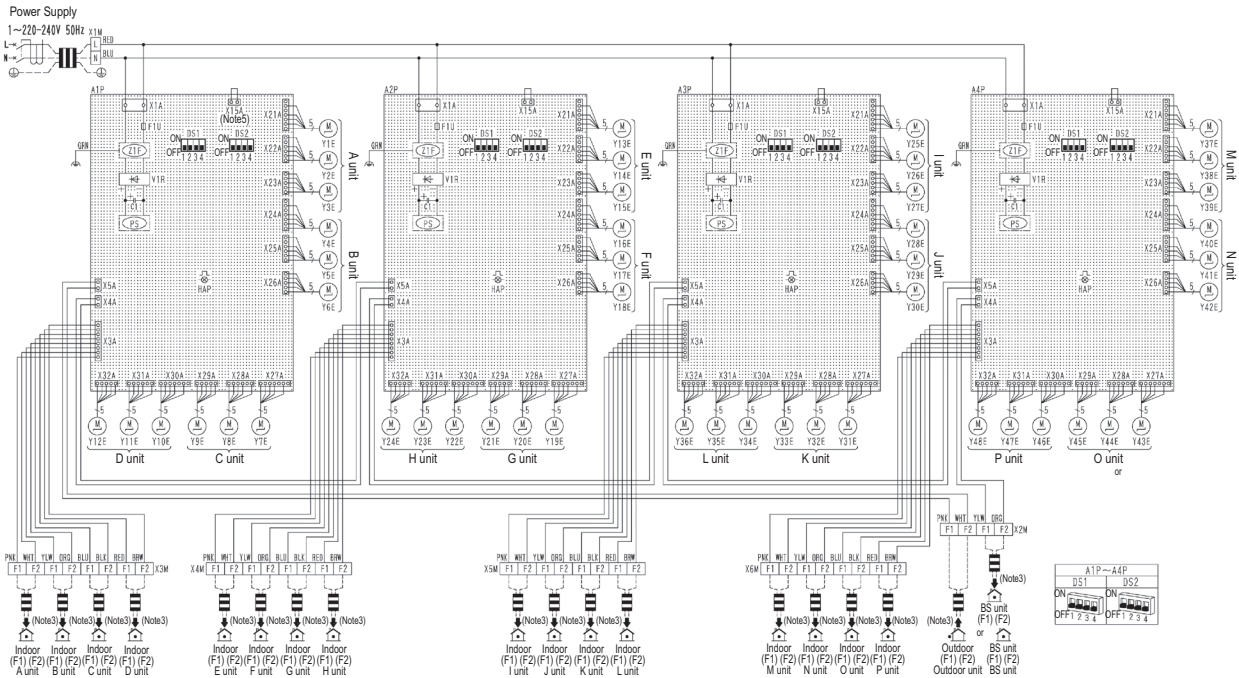

A1P~A4P	Printed circuit board (Control)	Y13E	Electric expansion valve (Suction)	E unit	Y34E	Electric expansion valve (Suction)	L unit
C1	Capacitor (A1P~ A4P)	Y14E	Electric expansion valve (HP/LP Gas)	F unit	Y35E	Electric expansion valve (HP/LP Gas)	
DS1, DS2	Dip switch (A1P~ A4P)	Y15E	Electric expansion valve (Sub cool)		Y36E	Electric expansion valve (Sub cool)	
F1U	Fuse (T, 3.15A 250V (A1P~ A4P))	Y16E	Electric expansion valve (Suction)		Y37E	Electric expansion valve (Suction)	M unit
HAP	Flashing lamp (Service monitor - green) (A1P~ A4P)	Y17E	Electric expansion valve (HP/LP Gas)	Y38E	Electric expansion valve (HP/LP Gas)		
PS	Switching power supply (A1P~ A4P)	Y18E	Electric expansion valve (Sub cool)	Y39E	Electric expansion valve (Sub cool)	N unit	
V1R	Diode bridge (A1P~ A4P)	Y19E	Electric expansion valve (Suction)	Y40E	Electric expansion valve (Suction)		
X1M	Terminal strip (Power)	Y20E	Electric expansion valve (HP/LP Gas)	Y41E	Electric expansion valve (HP/LP Gas)		
X2M~X6M	Terminal strip (Transmission)	Y21E	Electric expansion valve (Sub cool)	Y42E	Electric expansion valve (Sub cool)	O unit	
Z1F	Noise filter (A1P~ A4P)	Y22E	Electric expansion valve (Suction)	Y43E	Electric expansion valve (Suction)		
Y1E	Electric expansion valve (Suction)	Y23E	Electric expansion valve (HP/LP Gas)	Y44E	Electric expansion valve (HP/LP Gas)		
Y2E	Electric expansion valve (HP/LP Gas)	Y24E	Electric expansion valve (Sub cool)	Y45E	Electric expansion valve (Sub cool)	P unit	
Y3E	Electric expansion valve (Sub cool)	Y25E	Electric expansion valve (Suction)	Y46E	Electric expansion valve (Suction)		
Y4E	Electric expansion valve (Suction)	Y26E	Electric expansion valve (HP/LP Gas)	Y47E	Electric expansion valve (HP/LP Gas)	Optional Accessories	
Y5E	Electric expansion valve (HP/LP Gas)	Y27E	Electric expansion valve (Sub cool)	Y48E	Electric expansion valve (Sub cool)		
Y6E	Electric expansion valve (Sub cool)	Y28E	Electric expansion valve (Suction)	X15A	Connector (Drain up kit abnormal signal) (A1P)		
Y7E	Electric expansion valve (Suction)	Y29E	Electric expansion valve (HP/LP Gas)	J unit			
Y8E	Electric expansion valve (HP/LP Gas)	Y30E	Electric expansion valve (Sub cool)	K unit			
Y9E	Electric expansion valve (Sub cool)	Y31E	Electric expansion valve (Suction)				
Y10E	Electric expansion valve (Suction)	Y32E	Electric expansion valve (HP/LP Gas)				
Y11E	Electric expansion valve (HP/LP Gas)	Y33E	Electric expansion valve (Sub cool)				
Y12E	Electric expansion valve (Sub cool)						

2D086238

NOTES

- This wiring diagram is for BS units only.
- The marks in this diagram indicate: Terminal block, Connector, Field wiring, Earth terminal
- For wiring for the terminal block X2M~X6M (operation), refer to the installation manual attached to the product.
- The factory setting of dip switch (DS1 • DS2) are as follows. For the setting method of dip switch (DS1 • DS2), refer to 'the installation manual' and 'precaution for service' attached on the control box cover.
- As for X15A(A1P), remove the short circuit connector and connect the air conditioner stop signal (optional product) when using the drain-up kit (optional product). For details, please refer to the operation manual attached to the kit.

9 Sound data

9 - 1 Sound Pressure Spectrum

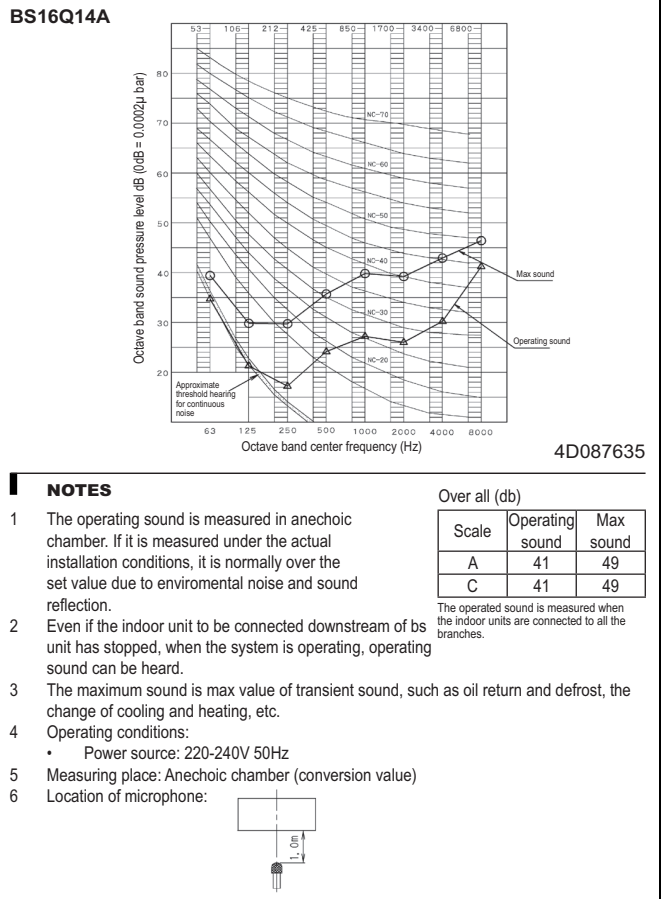
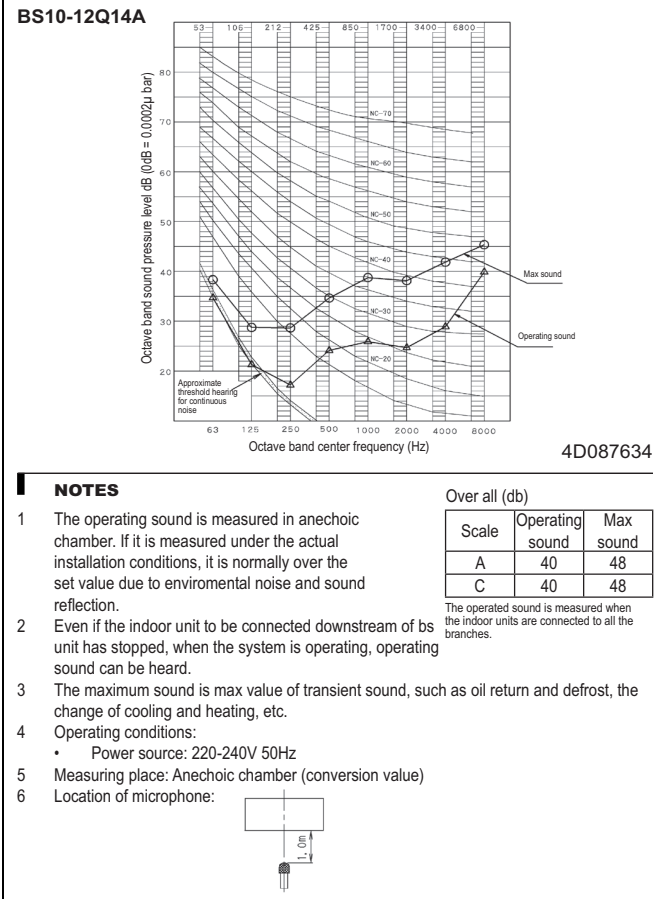
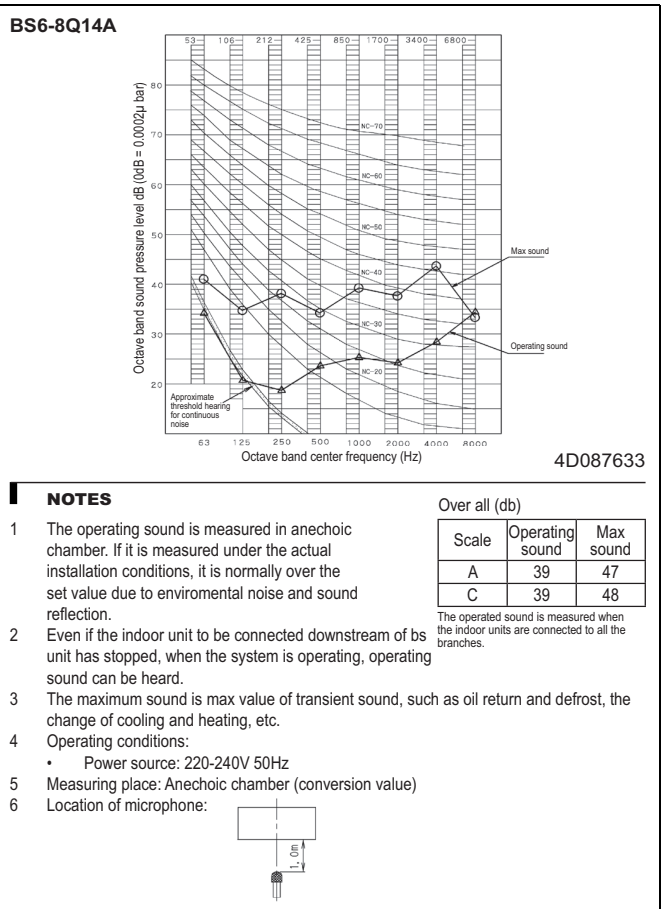
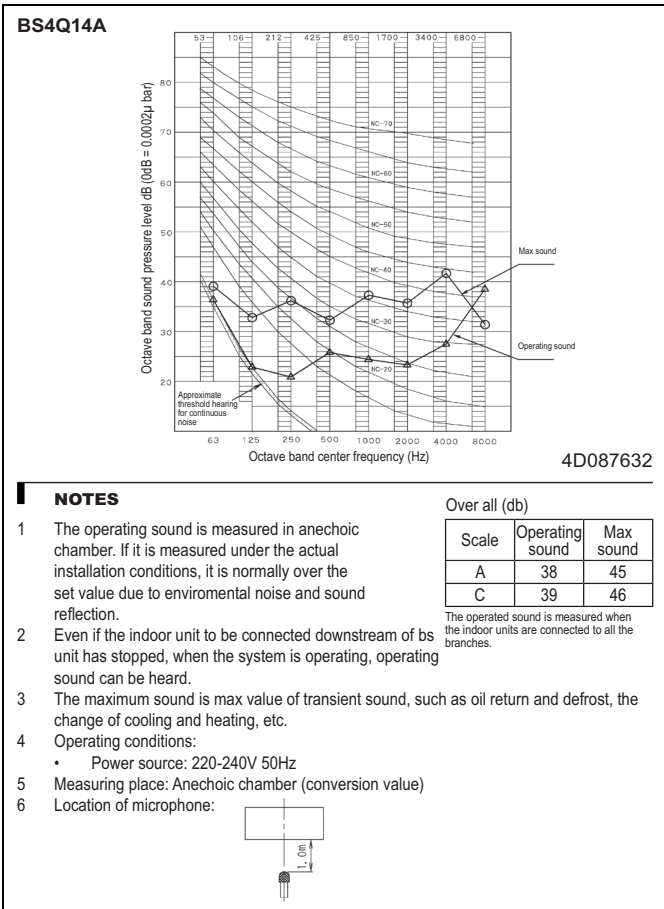



These products are not within the scope of the Eurovent certification program

The present leaflet is drawn up by way of information only and does not constitute an offer binding upon Daikin Europe N.V.. Daikin Europe N.V. has compiled the content of this leaflet to the best of its knowledge. No express or implied warranty is given for the completeness, accuracy, reliability or fitness for particular purpose of its content and the products and services presented therein. Specifications are subject to change without prior notice. Daikin Europe N.V. explicitly rejects any liability for any direct or indirect damage, in the broadest sense, arising from or related to the use and/or interpretation of this leaflet. All content is copyrighted by Daikin Europe N.V.

BARCODE

Daikin products are distributed by: