



technical data

Floor standing unit
FXLQ-P

air conditioning systems

R-410A



technical data

Floor standing unit
FXLQ-P

air conditioning systems

R-410A

TABLE OF CONTENTS

FXLQ-P

1	Specifications	2
	Technical Specifications	2
	Electrical Specifications (50 Hz)	3
	Electrical Specifications (60 Hz)	3
2	Safety device settings	4
4	Capacity tables	5
	Cooling capacity tables	5
	Heating capacity tables	7
	Capacity correction for high sensible	9
5	Dimensional drawing & centre of gravity	10
	Dimensional drawing	10
	Centre of gravity	12
6	Piping diagram	13
7	Wiring diagram	14
	Wiring diagram	14
8	Sound data	15
	Sound pressure spectrum	15
9	Installation	17
	Suspension bolt pitch position	17
	Service space	18

1 Specifications

1-1 Technical Specifications				FXLQ20P	FXLQ25P	FXLQ32P	FXLQ40P	FXLQ50P	FXLQ63P
Nominal Capacity	Cooling	kW	2.2	2.8	3.6	4.5	5.6	7.1	
	Heating	kW	2.5	3.2	4.0	5.0	6.3	8.0	
Power input (50Hz)	Cooling	kW	0.049		0.090		0.110		
	Heating	kW	0.049		0.090		0.110		
Power input (60Hz)	Cooling	kW	0.047	0.079	0.084	0.105	0.108		
	Heating	kW	0.047	0.079	0.084	0.105	0.108		
Casing	Colour	Fresh white (RAL9010) / Dark grey (RAL7011)							
Dimensions	Unit	Height	mm	600					
		Width	mm	1,000	1,140		1,420		
		Depth	mm	232					
	Packing	Height	mm	720					
		Width	mm	1,130	1,270		1,650		
		Depth	mm	350					
Weight	Unit	kg	27	32	38				
	Gross weight	kg	32	37	43				
Heat Exchanger	Dimensions	Nr of Rows	3						
		Fin Pitch	mm	1.5	1.5	1.5	1.5	1.5	1.5
		Face Area	m ²	0.159	0.200		0.282		
		Nr of Stages	14						
Fan	Type	Sirocco fan							
Air Flow Rate (50Hz)	Cooling	High	m ³ /min	7	8	11	14	16	
		Low	m ³ /min	6		8.5	11	12	
Air Flow Rate (60Hz)	Cooling	High	m ³ /min	7	8	11	14	16	
		Low	m ³ /min	6		8.5	11	12	
Fan	Motor	Output (high)	W	15	25		35		
		Drive	Direct drive						
Refrigerant	Name	R-410A							
Piping connections	Liquid (OD)	Type	Flare connection						
		Diameter	mm	6.35				9.52	
	Gas	Type	Flare connection						
		Diameter	mm	12.7				15.9	
	Drain	Diameter	mm	O.D. 21					
	Heat Insulation	Glass Fiber/Urethane Foam							
Air Filter	Resin net								
Refrigerant control	Electronic expansion valve								
Temperature control	Microprocessor thermostat for cooling and heating								
Safety devices	Fuse								
	Fan motor thermal protector								
Notes	Nominal cooling capacities are based on : indoor temperature : 27°CDB, 19°CWB, outdoor temperature : 35°CDB, equivalent refrigerant piping : 7.5m (horizontal)								
	Nominal heating capacities are based on : indoor temperature : 20°CDB, outdoor temperature : 7°CDB, 6°CWB, equivalent refrigerant piping : 7.5m (horizontal)								
	Capacities are net, including a deduction for cooling (an addition for heating) for indoor fan motor heat.								

1 Specifications

1-2 Electrical Specifications (50 Hz)			FXLQ20P	FXLQ25P	FXLQ32P	FXLQ40P	FXLQ50P	FXLQ63P
Power Supply	Name		VE					
	Phase		1					
	Frequency	Hz	50					
	Voltage	V	220-240					
Current	Minimum circuit amps (MCA)	A	0.3		0.6			
	Maximum fuse amps (MFA)	A	15					
	Full load amps (FLA)	A	0.2		0.5			
Voltage range	Minimum	V	-10%					
	Maximum	V	+10%					
Notes			Voltage range : units are suitable for use on electrical systems where voltage supplied to unit terminals is not below or above listed range limits. Maximum allowable voltage range variation between phases is 2%. MCA/MFA : MCA = 1.25 x FLA MFA is smaller than or equal to 4 x FLA Next lower standard fuse rating minimum 15A Select wire size based on the MCA Instead of a fuse, use a circuit breaker					

1-3 Electrical Specifications (60 Hz)			FXLQ20P	FXLQ25P	FXLQ32P	FXLQ40P	FXLQ50P	FXLQ63P
Power Supply	Name		VE					
	Phase		1					
	Frequency	Hz	60					
	Voltage	V	220					
Current	Minimum circuit amps (MCA)	A	0.3		0.5		0.6	
	Maximum fuse amps (MFA)	A	15					
	Full load amps (FLA)	A	0.2		0.4		0.5	
Voltage range	Minimum	V	-10%					
	Maximum	V	+10%					
Notes			Voltage range : units are suitable for use on electrical systems where voltage supplied to unit terminals is not below or above listed range limits. Maximum allowable voltage range variation between phases is 2%. MCA/MFA : MCA = 1.25 x FLA MFA is smaller than or equal to 4 x FLA Next lower standard fuse rating minimum 15A Select wire size based on the MCA Instead of a fuse, use a circuit breaker					

2 Safety device settings

FXLQ-P		FXLQ20P	FXLQ25P	FXLQ32P	FXLQ40P	FXLQ50P	FXLQ63P
PC BOARD FUSE		250V 10A					
FAN MOTOR THERMAL PROTECTOR	°C	OFF: 135 ^{±10} / ON: 120 or less					

3D034529E

3 Options

Item		Type	FXLQ20,25P	FXLQ32,40P	FXLQ50,63P
Remote control	Wired type		BRC1D52 / BRC1E51A		
	Infrared type	HP	BRC4C65		
		CO	BRC4C66		
Simplified remote control			BRC2A51		
Remote control for hotel use			BRC3A61		
Adapter for wiring			KRP1B61		
Wiring adapter for electrical appendices (1)			KRP2A51		
Wiring adapter for electrical appendices (2)			KRP4A51		
Remote sensor			KRCS01-1		
Central remote control			DCS302B51		
Electrical box with earth terminal (3 blocks)			KJB311A		
Unified ON/OFF controller			DCS301BA51		
Electrical box with earth terminal (2 blocks)			KJB212A		
Noise filter (for electromagnetic interface use only)			KEK26-1		
Schedule timer			DST301BA51		
External adapter for outdoor unit (installation on indoor unit)			DTA104A61		
Long life replacement filter			KAFJ361K28	KAFJ361K45	KAFJ361K71
Rear decoration panel			EKRDP25A	EKRDP40A	EKRDP63A
Multi tenant *1			EKMTAC		

4TW32299-1A

NOTES

*1 This kit contains parts to connect with 10 multi tenant indoor units.

4 Capacity tables

4 - 1 Cooling capacity tables

FXLQ-P																
Unit size	Nominal capacity	Outdoor air temp.	Indoor air temperature													
			14.OWB		16.OWB		18.OWB		19.OWB		20.OWB		22.OWB		24.OWB	
			20.0DB		23.0DB		26.0DB		27.0DB		28.0DB		30.0DB		32.0DB	
			°CDB	TC	SHC	TC	SHC	TC	SHC	TC	SHC	TC	SHC	TC	SHC	TC
20	2.2	10.0	1.5	1.3	1.8	1.5	2.1	1.7	2.2	1.7	2.3	1.8	2.6	1.8	2.9	1.8
		12.0	1.5	1.3	1.8	1.5	2.1	1.7	2.2	1.7	2.3	1.8	2.6	1.8	2.9	1.7
		14.0	1.5	1.3	1.8	1.5	2.1	1.7	2.2	1.7	2.3	1.8	2.6	1.8	2.8	1.7
		16.0	1.5	1.3	1.8	1.5	2.1	1.7	2.2	1.7	2.3	1.8	2.6	1.8	2.8	1.7
		18.0	1.5	1.3	1.8	1.5	2.1	1.7	2.2	1.7	2.3	1.8	2.6	1.8	2.7	1.7
		20.0	1.5	1.3	1.8	1.5	2.1	1.7	2.2	1.7	2.3	1.8	2.6	1.8	2.7	1.6
		21.0	1.5	1.3	1.8	1.5	2.1	1.7	2.2	1.7	2.3	1.8	2.6	1.8	2.7	1.6
		23.0	1.5	1.3	1.8	1.5	2.1	1.7	2.2	1.7	2.3	1.8	2.6	1.8	2.6	1.6
		25.0	1.5	1.3	1.8	1.5	2.1	1.7	2.2	1.7	2.3	1.8	2.6	1.7	2.6	1.6
		27.0	1.5	1.3	1.8	1.5	2.1	1.7	2.2	1.7	2.3	1.8	2.5	1.7	2.6	1.6
		29.0	1.5	1.3	1.8	1.5	2.1	1.7	2.2	1.7	2.3	1.8	2.5	1.7	2.5	1.6
		31.0	1.5	1.3	1.8	1.5	2.1	1.7	2.2	1.7	2.3	1.8	2.4	1.7	2.5	1.6
		33.0	1.5	1.3	1.8	1.5	2.1	1.7	2.2	1.7	2.3	1.8	2.4	1.7	2.5	1.6
25	2.8	10.0	1.9	1.6	2.3	1.8	2.6	2.0	2.8	2.1	3.0	2.1	3.4	2.1	3.7	2.1
		12.0	1.9	1.6	2.3	1.8	2.6	2.0	2.8	2.1	3.0	2.1	3.4	2.1	3.6	2.1
		14.0	1.9	1.6	2.3	1.8	2.6	2.0	2.8	2.1	3.0	2.1	3.4	2.1	3.6	2.1
		16.0	1.9	1.6	2.3	1.8	2.6	2.0	2.8	2.1	3.0	2.1	3.4	2.1	3.5	2.1
		18.0	1.9	1.6	2.3	1.8	2.6	2.0	2.8	2.1	3.0	2.1	3.4	2.1	3.5	2.0
		20.0	1.9	1.6	2.3	1.8	2.6	2.0	2.8	2.1	3.0	2.1	3.4	2.1	3.4	2.0
		21.0	1.9	1.6	2.3	1.8	2.6	2.0	2.8	2.1	3.0	2.1	3.4	2.1	3.4	2.0
		23.0	1.9	1.6	2.3	1.8	2.6	2.0	2.8	2.1	3.0	2.1	3.3	2.1	3.4	2.0
		25.0	1.9	1.6	2.3	1.8	2.6	2.0	2.8	2.1	3.0	2.1	3.3	2.1	3.3	2.0
		27.0	1.9	1.6	2.3	1.8	2.6	2.0	2.8	2.1	3.0	2.1	3.2	2.1	3.3	1.9
		29.0	1.9	1.6	2.3	1.8	2.6	2.0	2.8	2.1	3.0	2.1	3.2	2.0	3.2	1.9
		31.0	1.9	1.6	2.3	1.8	2.6	2.0	2.8	2.1	3.0	2.1	3.1	2.0	3.2	1.9
		33.0	1.9	1.6	2.3	1.8	2.6	2.0	2.8	2.1	3.0	2.1	3.1	2.0	3.1	1.9
32	3.6	10.0	2.4	2.1	2.9	2.2	3.4	2.5	3.6	2.5	3.8	2.6	4.3	2.6	4.7	2.6
		12.0	2.4	2.1	2.9	2.2	3.4	2.5	3.6	2.5	3.8	2.6	4.3	2.6	4.7	2.6
		14.0	2.4	2.1	2.9	2.2	3.4	2.5	3.6	2.5	3.8	2.6	4.3	2.6	4.6	2.6
		16.0	2.4	2.1	2.9	2.2	3.4	2.5	3.6	2.5	3.8	2.6	4.3	2.6	4.6	2.5
		18.0	2.4	2.1	2.9	2.2	3.4	2.5	3.6	2.5	3.8	2.6	4.3	2.6	4.5	2.5
		20.0	2.4	2.1	2.9	2.2	3.4	2.5	3.6	2.5	3.8	2.6	4.3	2.6	4.4	2.5
		21.0	2.4	2.1	2.9	2.2	3.4	2.5	3.6	2.5	3.8	2.6	4.3	2.6	4.4	2.5
		23.0	2.4	2.1	2.9	2.2	3.4	2.5	3.6	2.5	3.8	2.6	4.2	2.6	4.3	2.4
		25.0	2.4	2.1	2.9	2.2	3.4	2.5	3.6	2.5	3.8	2.6	4.2	2.6	4.3	2.4
		27.0	2.4	2.1	2.9	2.2	3.4	2.5	3.6	2.5	3.8	2.6	4.1	2.5	4.2	2.4
		29.0	2.4	2.1	2.9	2.2	3.4	2.5	3.6	2.5	3.8	2.6	4.1	2.5	4.2	2.4
		31.0	2.4	2.1	2.9	2.2	3.4	2.5	3.6	2.5	3.8	2.6	4.0	2.5	4.1	2.4
		33.0	2.4	2.1	2.9	2.2	3.4	2.5	3.6	2.5	3.8	2.6	3.9	2.4	4.0	2.3
40	4.5	10.0	3.0	2.5	3.6	2.7	4.2	3.1	4.5	3.1	4.8	3.2	5.4	3.3	5.9	3.3
		12.0	3.0	2.5	3.6	2.7	4.2	3.1	4.5	3.1	4.8	3.2	5.4	3.3	5.8	3.3
		14.0	3.0	2.5	3.6	2.7	4.2	3.1	4.5	3.1	4.8	3.2	5.4	3.3	5.8	3.2
		16.0	3.0	2.5	3.6	2.7	4.2	3.1	4.5	3.1	4.8	3.2	5.4	3.3	5.7	3.2
		18.0	3.0	2.5	3.6	2.7	4.2	3.1	4.5	3.1	4.8	3.2	5.4	3.3	5.6	3.1
		20.0	3.0	2.5	3.6	2.7	4.2	3.1	4.5	3.1	4.8	3.2	5.4	3.3	5.5	3.1
		21.0	3.0	2.5	3.6	2.7	4.2	3.1	4.5	3.1	4.8	3.2	5.4	3.3	5.5	3.1
		23.0	3.0	2.5	3.6	2.7	4.2	3.1	4.5	3.1	4.8	3.2	5.3	3.2	5.4	3.0
		25.0	3.0	2.5	3.6	2.7	4.2	3.1	4.5	3.1	4.8	3.2	5.2	3.2	5.3	3.0
		27.0	3.0	2.5	3.6	2.7	4.2	3.1	4.5	3.1	4.8	3.2	5.2	3.1	5.3	3.0
		29.0	3.0	2.5	3.6	2.7	4.2	3.1	4.5	3.1	4.8	3.2	5.1	3.1	5.2	3.0
		31.0	3.0	2.5	3.6	2.7	4.2	3.1	4.5	3.1	4.8	3.2	5.0	3.1	5.1	2.9
		33.0	3.0	2.5	3.6	2.7	4.2	3.1	4.5	3.1	4.8	3.2	4.9	3.0	5.0	2.9
CA03A095																

4 Capacity tables

4 - 1 Cooling capacity tables

FXLQ-P																
Unit size	Nominal capacity	Outdoor air temp. °CDB	Indoor air temperature													
			14.0WB		16.0WB		18.0WB		19.0WB		20.0WB		22.0WB		24.0WB	
			20.0DB		23.0DB		26.0DB		27.0DB		28.0DB		30.0DB		32.0DB	
			TC	SHC	TC	SHC	TC	SHC	TC	SHC	TC	SHC	TC	SHC	TC	SHC
50	5.6	10.0	3.8	3.0	4.5	3.4	5.2	3.8	5.6	3.9	6.0	4.0	6.7	4.1	7.4	4.1
		12.0	3.8	3.0	4.5	3.4	5.2	3.8	5.6	3.9	6.0	4.0	6.7	4.1	7.3	4.1
		14.0	3.8	3.0	4.5	3.4	5.2	3.8	5.6	3.9	6.0	4.0	6.7	4.1	7.2	4.0
		16.0	3.8	3.0	4.5	3.4	5.2	3.8	5.6	3.9	6.0	4.0	6.7	4.1	7.1	4.0
		18.0	3.8	3.0	4.5	3.4	5.2	3.8	5.6	3.9	6.0	4.0	6.7	4.1	7.0	3.9
		20.0	3.8	3.0	4.5	3.4	5.2	3.8	5.6	3.9	6.0	4.0	6.7	4.1	6.9	3.9
		21.0	3.8	3.0	4.5	3.4	5.2	3.8	5.6	3.9	6.0	4.0	6.7	4.1	6.8	3.8
		23.0	3.8	3.0	4.5	3.4	5.2	3.8	5.6	3.9	6.0	4.0	6.6	4.0	6.7	3.8
		25.0	3.8	3.0	4.5	3.4	5.2	3.8	5.6	3.9	6.0	4.0	6.5	4.0	6.6	3.7
		27.0	3.8	3.0	4.5	3.4	5.2	3.8	5.6	3.9	6.0	4.0	6.4	3.9	6.6	3.7
		29.0	3.8	3.0	4.5	3.4	5.2	3.8	5.6	3.9	6.0	4.0	6.3	3.9	6.5	3.7
		31.0	3.8	3.0	4.5	3.4	5.2	3.8	5.6	3.9	6.0	4.0	6.2	3.8	6.4	3.7
		33.0	3.8	3.0	4.5	3.4	5.2	3.8	5.6	3.9	6.0	4.0	6.1	3.8	6.3	3.6
		35.0	3.8	3.0	4.5	3.4	5.2	3.8	5.6	3.9	5.9	4.0	6.0	3.8	6.2	3.6
		37.0	3.8	3.0	4.5	3.4	5.2	3.8	5.6	3.9	5.8	3.9	5.9	3.7	6.1	3.6
		39.0	3.8	3.0	4.5	3.4	5.2	3.8	5.6	3.9	5.7	3.9	5.8	3.7	6.0	3.5
63	7.1	10.0	4.8	3.7	5.7	4.2	6.6	4.8	7.1	4.9	7.6	5.0	8.5	5.1	9.3	5.0
		12.0	4.8	3.7	5.7	4.2	6.6	4.8	7.1	4.9	7.6	5.0	8.5	5.1	9.2	5.0
		14.0	4.8	3.7	5.7	4.2	6.6	4.8	7.1	4.9	7.6	5.0	8.5	5.1	9.1	4.9
		16.0	4.8	3.7	5.7	4.2	6.6	4.8	7.1	4.9	7.6	5.0	8.5	5.1	9.0	4.8
		18.0	4.8	3.7	5.7	4.2	6.6	4.8	7.1	4.9	7.6	5.0	8.5	5.1	8.8	4.8
		20.0	4.8	3.7	5.7	4.2	6.6	4.8	7.1	4.9	7.6	5.0	8.5	5.1	8.7	4.7
		21.0	4.8	3.7	5.7	4.2	6.6	4.8	7.1	4.9	7.6	5.0	8.5	5.1	8.7	4.7
		23.0	4.8	3.7	5.7	4.2	6.6	4.8	7.1	4.9	7.6	5.0	8.4	5.0	8.5	4.6
		25.0	4.8	3.7	5.7	4.2	6.6	4.8	7.1	4.9	7.6	5.0	8.3	5.0	8.4	4.5
		27.0	4.8	3.7	5.7	4.2	6.6	4.8	7.1	4.9	7.6	5.0	8.1	4.9	8.3	4.5
		29.0	4.8	3.7	5.7	4.2	6.6	4.8	7.1	4.9	7.6	5.0	8.0	4.8	8.2	4.5
		31.0	4.8	3.7	5.7	4.2	6.6	4.8	7.1	4.9	7.6	5.0	7.9	4.7	8.1	4.4
		33.0	4.8	3.7	5.7	4.2	6.6	4.8	7.1	4.9	7.6	5.0	7.8	4.7	7.9	4.4
		35.0	4.8	3.7	5.7	4.2	6.6	4.8	7.1	4.9	7.5	4.9	7.7	4.7	7.8	4.3
		37.0	4.8	3.7	5.7	4.2	6.6	4.8	7.1	4.9	7.4	4.9	7.5	4.6	7.7	4.2
		39.0	4.8	3.7	5.7	4.2	6.6	4.8	7.1	4.9	7.2	4.8	7.4	4.6	7.6	4.2

CA03A095

4 Capacity tables

4 - 2 Heating capacity tables

FXLQ-P										
Unit Size	Nominal capacity	Outdoor air temperature		Indoor air temperature °CDB						
				16.0	18.0	20.0		21.0	22.0	24.0
		°CDB	°CWB	kW	kW	kW	kW	kW	kW	kW
20	2.5	-19.8	-20.0	1.5	1.5	1.5	1.5	1.5	1.5	1.5
		-18.8	-19.0	1.5	1.5	1.5	1.5	1.5	1.5	1.5
		-16.7	-17.0	1.6	1.6	1.6	1.6	1.6	1.6	1.6
		-14.7	-15.0	1.7	1.7	1.7	1.7	1.7	1.7	1.7
		-12.6	-13.0	1.8	1.8	1.8	1.8	1.8	1.8	1.8
		-10.5	-11.0	1.9	1.9	1.9	1.9	1.9	1.9	1.9
		-9.5	-10.0	1.9	1.9	1.9	1.9	1.9	1.9	1.9
		-8.5	-9.1	2.0	2.0	1.9	1.9	1.9	1.9	1.9
		-7.0	-7.6	2.0	2.0	2.0	2.0	2.0	2.0	2.0
		-5.0	-5.6	2.1	2.1	2.1	2.1	2.1	2.1	2.1
		-3.0	-3.7	2.2	2.2	2.2	2.2	2.2	2.2	2.2
		0.0	-0.7	2.3	2.3	2.3	2.3	2.3	2.3	2.2
		3.0	2.2	2.5	2.5	2.4	2.4	2.3	2.3	2.2
		5.0	4.1	2.5	2.5	2.5	2.4	2.3	2.3	2.2
		7.0	6.0	2.6	2.6	2.5	2.4	2.3	2.3	2.2
		9.0	7.9	2.7	2.7	2.5	2.4	2.3	2.3	2.2
11.0	9.8	2.8	2.7	2.5	2.4	2.3	2.3	2.2		
13.0	11.8	2.8	2.7	2.5	2.4	2.3	2.3	2.2		
15.0	13.7	2.8	2.7	2.5	2.4	2.3	2.3	2.2		
25	3.2	-19.8	-20.0	1.9	1.9	1.9	1.9	1.9	1.9	
		-18.8	-19.0	1.9	1.9	1.9	1.9	1.9	1.9	
		-16.7	-17.0	2.1	2.1	2.0	2.0	2.0	2.0	
		-14.7	-15.0	2.2	2.2	2.2	2.2	2.2	2.1	
		-12.6	-13.0	2.3	2.3	2.3	2.3	2.3	2.3	
		-10.5	-11.0	2.4	2.4	2.4	2.4	2.4	2.4	
		-9.5	-10.0	2.5	2.4	2.4	2.4	2.4	2.4	
		-8.5	-9.1	2.5	2.5	2.5	2.5	2.5	2.5	
		-7.0	-7.6	2.6	2.6	2.6	2.6	2.6	2.6	
		-5.0	-5.6	2.7	2.7	2.7	2.7	2.7	2.7	
		-3.0	-3.7	2.8	2.8	2.8	2.8	2.8	2.8	
		0.0	-0.7	3.0	3.0	3.0	3.0	3.0	3.0	
		3.0	2.2	3.1	3.1	3.1	3.1	3.0	2.8	
		5.0	4.1	3.3	3.2	3.2	3.1	3.0	2.8	
		7.0	6.0	3.4	3.4	3.2	3.1	3.0	2.8	
		9.0	7.9	3.5	3.4	3.2	3.1	3.0	2.8	
11.0	9.8	3.6	3.4	3.2	3.1	3.0	2.8			
13.0	11.8	3.6	3.4	3.2	3.1	3.0	2.8			
15.0	13.7	3.6	3.4	3.2	3.1	3.0	2.8			
32	4.0	-19.8	-20.0	2.4	2.4	2.3	2.3	2.3	2.3	
		-18.8	-19.0	2.4	2.4	2.4	2.4	2.4	2.4	
		-16.7	-17.0	2.6	2.6	2.6	2.6	2.6	2.5	
		-14.7	-15.0	2.7	2.7	2.7	2.7	2.7	2.7	
		-12.6	-13.0	2.9	2.8	2.8	2.8	2.8	2.8	
		-10.5	-11.0	3.0	3.0	3.0	3.0	3.0	3.0	
		-9.5	-10.0	3.1	3.1	3.1	3.1	3.0	3.0	
		-8.5	-9.1	3.1	3.1	3.1	3.1	3.1	3.1	
		-7.0	-7.6	3.2	3.2	3.2	3.2	3.2	3.2	
		-5.0	-5.6	3.4	3.4	3.4	3.4	3.4	3.4	
		-3.0	-3.7	3.5	3.5	3.5	3.5	3.5	3.5	
		0.0	-0.7	3.7	3.7	3.7	3.7	3.7	3.5	
		3.0	2.2	3.9	3.9	3.9	3.9	3.7	3.5	
		5.0	4.1	4.1	4.1	4.0	3.9	3.7	3.5	
		7.0	6.0	4.2	4.2	4.0	3.9	3.7	3.5	
		9.0	7.9	4.3	4.3	4.0	3.9	3.7	3.5	
11.0	9.8	4.5	4.3	4.0	3.9	3.7	3.5			
13.0	11.8	4.5	4.3	4.0	3.9	3.7	3.5			
15.0	13.7	4.5	4.3	4.0	3.9	3.7	3.5			
40	5.0	-19.8	-20.0	3.0	2.9	2.9	2.9	2.9	2.9	
		-18.8	-19.0	3.0	3.0	3.0	3.0	3.0	3.0	
		-16.7	-17.0	3.2	3.2	3.2	3.2	3.2	3.2	
		-14.7	-15.0	3.4	3.4	3.4	3.4	3.4	3.4	
		-12.6	-13.0	3.6	3.6	3.6	3.5	3.5	3.5	
		-10.5	-11.0	3.7	3.7	3.7	3.7	3.7	3.7	
		-9.5	-10.0	3.8	3.8	3.8	3.8	3.8	3.8	
		-8.5	-9.1	3.9	3.9	3.9	3.9	3.9	3.9	
		-7.0	-7.6	4.0	4.0	4.0	4.0	4.0	4.0	
		-5.0	-5.6	4.2	4.2	4.2	4.2	4.2	4.2	
		-3.0	-3.7	4.4	4.4	4.4	4.4	4.4	4.4	
		0.0	-0.7	4.7	4.6	4.6	4.6	4.6	4.4	
		3.0	2.2	4.9	4.9	4.9	4.8	4.7	4.4	
		5.0	4.1	5.1	5.1	5.0	4.8	4.7	4.4	
		7.0	6.0	5.2	5.2	5.0	4.8	4.7	4.4	
		9.0	7.9	5.4	5.3	5.0	4.8	4.7	4.4	
11.0	9.8	5.6	5.3	5.0	4.8	4.7	4.4			
13.0	11.8	5.6	5.3	5.0	4.8	4.7	4.4			
15.0	13.7	5.6	5.3	5.0	4.8	4.7	4.4			

CA03A095

4 Capacity tables

4 - 2 Heating capacity tables

FXLQ-P										
Unit Size	Nominal capacity	Outdoor air temperature		Indoor air temperature °CDB						
				16.0	18.0	20.0		21.0	22.0	24.0
		°CDB	°CWB	kW	kW	kW	kW	kW	kW	kW
50	6.3	-19.8	-20.0	3.7	3.7	3.7	3.7	3.7	3.7	3.7
		-18.8	-19.0	3.8	3.8	3.8	3.8	3.8	3.8	3.8
		-16.7	-17.0	4.1	4.0	4.0	4.0	4.0	4.0	4.0
		-14.7	-15.0	4.3	4.3	4.3	4.2	4.2	4.2	4.2
		-12.6	-13.0	4.5	4.5	4.5	4.5	4.5	4.5	4.5
		-10.5	-11.0	4.7	4.7	4.7	4.7	4.7	4.7	4.7
		-9.5	-10.0	4.8	4.8	4.8	4.8	4.8	4.8	4.8
		-8.5	-9.1	4.9	4.9	4.9	4.9	4.9	4.9	4.9
		-7.0	-7.6	5.1	5.1	5.1	5.1	5.1	5.1	5.1
		-5.0	-5.6	5.3	5.3	5.3	5.3	5.3	5.3	5.3
		-3.0	-3.7	5.5	5.5	5.5	5.5	5.5	5.5	5.5
		0.0	-0.7	5.9	5.9	5.8	5.8	5.8	5.8	5.5
		3.0	2.2	6.2	6.2	6.2	6.1	5.9	5.5	5.5
		5.0	4.1	6.4	6.4	6.3	6.1	5.9	5.5	5.5
		7.0	6.0	6.6	6.6	6.3	6.1	5.9	5.5	5.5
		9.0	7.9	6.8	6.7	6.3	6.1	5.9	5.5	5.5
		11.0	9.8	7.0	6.7	6.3	6.1	5.9	5.5	5.5
13.0	11.8	7.1	6.7	6.3	6.1	5.9	5.5	5.5		
15.0	13.7	7.1	6.7	6.3	6.1	5.9	5.5	5.5		
63	8.0	-19.8	-20.0	4.7	4.7	4.7	4.7	4.7	4.7	4.7
		-18.8	-19.0	4.9	4.9	4.8	4.8	4.8	4.8	4.8
		-16.7	-17.0	5.1	5.1	5.1	5.1	5.1	5.1	5.1
		-14.7	-15.0	5.4	5.4	5.4	5.4	5.4	5.4	5.4
		-12.6	-13.0	5.7	5.7	5.7	5.7	5.7	5.7	5.7
		-10.5	-11.0	6.0	6.0	6.0	6.0	6.0	6.0	5.9
		-9.5	-10.0	6.1	6.1	6.1	6.1	6.1	6.1	6.1
		-8.5	-9.1	6.3	6.3	6.2	6.2	6.2	6.2	6.2
		-7.0	-7.6	6.5	6.5	6.4	6.4	6.4	6.4	6.4
		-5.0	-5.6	6.8	6.7	6.7	6.7	6.7	6.7	6.7
		-3.0	-3.7	7.0	7.0	7.0	7.0	7.0	7.0	7.0
		0.0	-0.7	7.5	7.4	7.4	7.4	7.4	7.4	7.0
		3.0	2.2	7.9	7.8	7.8	7.7	7.5	7.0	7.0
		5.0	4.1	8.1	8.1	8.0	7.7	7.5	7.0	7.0
		7.0	6.0	8.4	8.4	8.0	7.7	7.5	7.0	7.0
		9.0	7.9	8.7	8.5	8.0	7.7	7.5	7.0	7.0
		11.0	9.8	8.9	8.5	8.0	7.7	7.5	7.0	7.0
13.0	11.8	9.0	8.5	8.0	7.7	7.5	7.0	7.0		
15.0	13.7	9.0	8.5	8.0	7.7	7.5	7.0	7.0		

CA03A095

4 Capacity tables

4 - 3 Capacity correction for high sensible

FXLQ-P

		Single module and 2 module systems (not applicable for 3 module systems)						
		20°CDB 14°CWB	23°CDB 16°CWB	26°CDB 18°CWB	27°CDB 19°CWB	28°CDB 20°CWB	30°CDB 22°CWB	32°CDB 24°CWB
20	TC ratio	0,527	0,540	0,601	0,638	0,671	0,727	0,768
	SHF ratio	1,205	1,300	1,249	1,196	1,157	1,101	1,063
25	TC ratio	0,527	0,542	0,604	0,642	0,675	0,730	0,771
	SHF ratio	1,206	1,301	1,247	1,194	1,155	1,099	1,063
32	TC ratio	0,525	0,538	0,600	0,637	0,669	0,725	0,769
	SHF ratio	1,212	1,308	1,249	1,197	1,158	1,100	1,061
40	TC ratio	0,533	0,553	0,610	0,648	0,681	0,731	0,771
	SHF ratio	1,184	1,274	1,238	1,187	1,150	1,100	1,070
50	TC ratio	0,530	0,545	0,601	0,639	0,672	0,727	0,768
	SHF ratio	1,194	1,288	1,247	1,195	1,156	1,101	1,064
63	TC ratio	0,535	0,553	0,608	0,646	0,678	0,729	0,769
	SHF ratio	1,179	1,269	1,238	1,188	1,151	1,103	1,075

4TW27232-9

NOTES - ANMERKUNGEN - Σημειώσεις - NOTAS - REMARQUES - NOTE - OPMERKINGEN - Примечания - NOTLAR

How to use this table - So verwenden Sie diese Tabelle - Πώς θα χρησιμοποιήσετε αυτό τον πίνακα - Cómo utilizar esta tabla - Utilisation de ce tableau - Come utilizzare questa tabella - Gebruik van deze tabel - Как пользоваться этой таблицей - Bu tablo nasıl kullanılmalı? :

1. Capacity : Total capacity for High sensible mode = Total capacity for normal capacity table X TC ratio.

Leistung: Gesamtleistung für hochfühlbaren Leistungsmodus = Gesamtleistung für normale Leistungstabelle x GL-Verhältnis.

Απόδοση: Συνολική απόδοση για τη λειτουργία υψηλής ευαισθησίας = Συνολική απόδοση για τον πίνακα κανονικών αποδόσεων X αναλογία TC

Capacidad: Capacidad total para el modo de alta sensibilidad = Capacidad total para la tabla de capacidad normal X relación TC.

Capacité sensible (FCS (Facteur de chaleur sensible) – en anglais : SHF) : FCS pour le mode sensibilité élevée (« High ») = FCS du tableau des capacités normales x rapport FCS.

Capacità: Capacità totale per modalità ad alta capacità sensibile = Capacità totale per tabella capacità normali X rapporto TC.

Capaciteit: totale capaciteit in modus grote ("High") gevoeligheid = totale capaciteit uit de tabel met normale capaciteiten x TC-ratio.

Производительность: Общая производительность для режима с высоким коэфф. ошутимого охлаждения = Общая производительность для нормального режима, таблица X коэфф. TC.

Kapasite: Yüksek algı modu için toplam kapasite = Normal kapasite tablosundaki toplam kapasite değeri x TC oranı.

2. Sensible capacity (SHF): SHF for High sensible mode = SHF for normal capacity table X SHF ratio .

Fühlbare Leistung (SHF): SHF für hochfühlbaren Leistungsmodus = SHF für normale Leistungstabelle x SHF-Verhältnis.

Αισθητή απόδοση (SHF): SHF για λειτουργία υψηλής ευαισθησίας = SHF για πίνακα κανονικών αποδόσεων X αναλογία SHF .

Capacidad sensible (FCS): SHF para el modo de alta sensibilidad = SHF para la tabla de capacidad normal X relación SHF.

Capacité sensible (FCS (Facteur de chaleur sensible) – en anglais : SHF) : FCS pour le mode sensibilité élevée (« High ») = FCS du tableau des capacités normales x rapport FCS.

Capacità sensibile (SHF): SHF per modalità ad alta capacità sensibile = SHF per tabella capacità normali X rapporto SHF.

Gevoeligheidsfactor (WGF (warmtegevoelsfactor)– in het Engels "SHF"): WGF voor de modus grote ("High") gevoeligheid = WGF uit de tabel met normale capaciteiten x WGF-ratio.

Ощутимая производительность (SHF): SHF для режима с высоким коэфф. ошутимого охлаждения = SHF для нормального режима, таблица X коэфф. SHF.

Algılanabilir kapasite (SHF): Yüksek algı modu için SHF = Normal kapasite tablosundaki SHF değeri x SHF oranı.

3. In case of SHF is bigger than 1 , SHF is "1"

Für den Fall, dass SHF größer als 1 ist, wird SHF als "1" angenommen.

Σε περίπτωση που το SHF είναι μεγαλύτερο από 1, το SHF είναι "1"

En caso de que SHF sea superior a 1 , SHF equivale a "1"

Si FCS est supérieur à 1 , utilisez « 1 » pour FCS.

Qualora il valore SHF sia maggiore di 1 , SHF è "1"

Indien WGF groter is dan 1 , neem dan "1" voor WGF.

Если SHF больше 1, то SHF равен "1"

SHF değeri 1'den büyükse, SHF değeri "1" kabul edilmelidir

5 Dimensional drawing & centre of gravity

5 - 1 Dimensional drawing

FXLQ20-25P

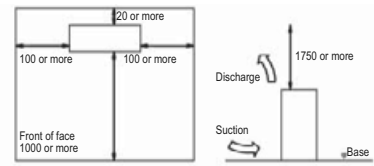
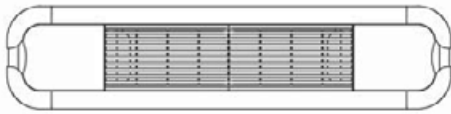

Required installation space

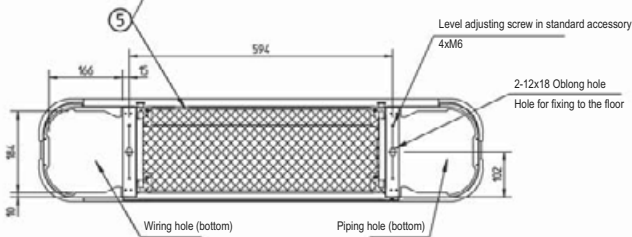
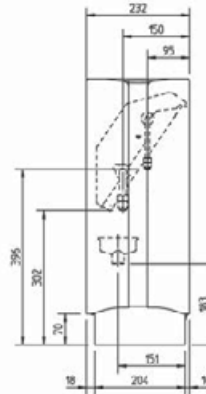
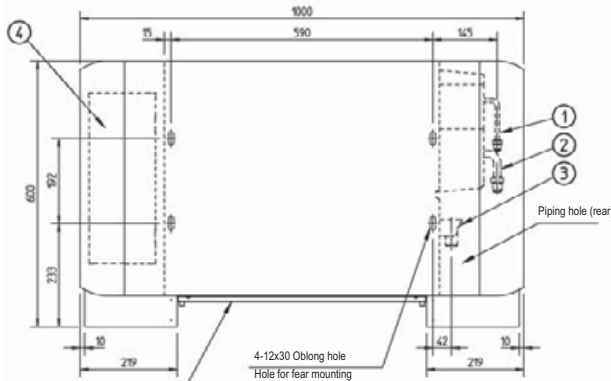

Item	Name	Description
1	Liquid pipe connection	Ø6.4 Flare connection
2	Gas pipe connection	Ø12.7 Flare connection
3	Drain pipe connection	O.D.Ø21
4	Switch box	
5	Air filter	

3TW32294-1

FXLQ32-40P

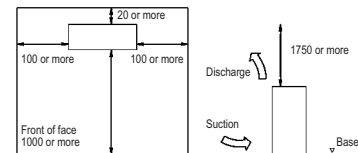
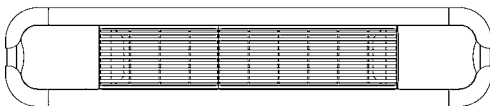

Required installation space

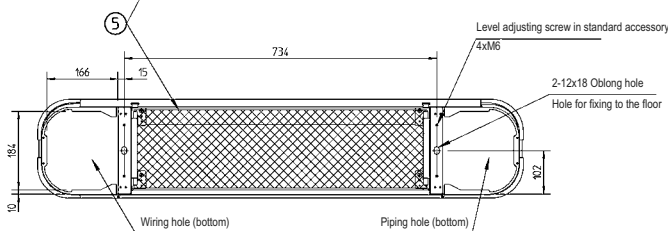
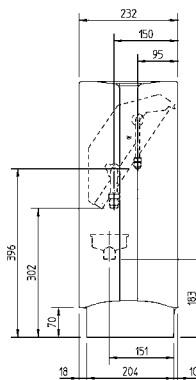
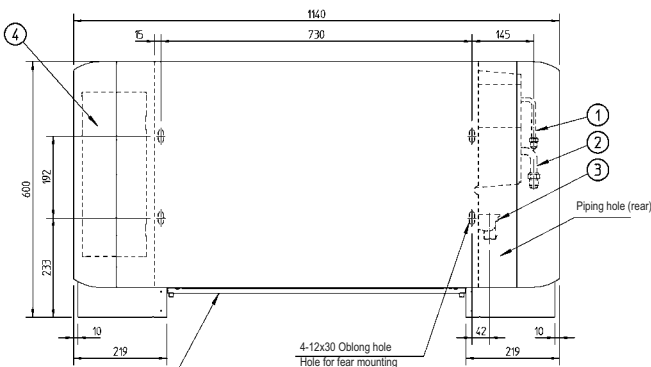

Item	Name	Description
1	Liquid pipe connection	Ø6.4 Flare connection
2	Gas pipe connection	Ø12.7 Flare connection
3	Drain pipe connection	O.D.Ø21
4	Switch box	
5	Air filter	

3TW32314-1

5 Dimensional drawing & centre of gravity

5 - 1 Dimensional drawing

FXLQ50-63P

Required installation space

Discharge
Suction
1750 or more
v Base

20 or more
100 or more
100 or more
Front of face
1000 or more

1420
1010
145
15
10
209
601
192
233
42
10
219
Piping hole (rear)
4-12x30 Oblong hole
Hole for rear mounting

232
150
95
302
70
151
18
204
10

1014
166
15
4xM6
Level adjusting screw in standard accessory
2-12x18 Oblong hole
Hole for fixing to the floor
Wiring hole (bottom)
Piping hole (bottom)

Model	A	B
FXL050	Ø6.4	Ø12.7
FXL063	Ø9.5	Ø15.9

Item	Name	Description
1	Liquid pipe connection	ØA Flare connection
2	Gas pipe connection	ØB Flare connection
3	Drain pipe connection	O.D.Ø21
4	Switch box	
5	Air filter	

3TW32334-1

5 Dimensional drawing & centre of gravity

5 - 2 Centre of gravity

FXLQ-P

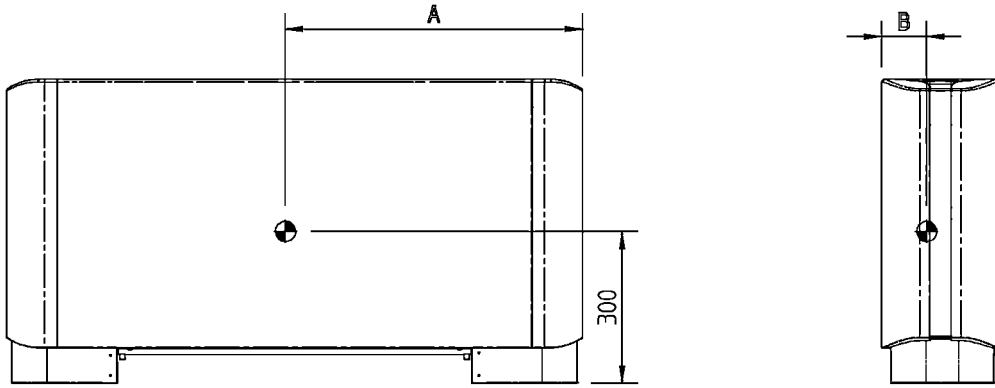

Model	A	B
FXLQ 20, 25 P	500	81
FXLQ 32, 40 P	588	89
FXLQ 50, 63 P	728	99

4TW32299-2

6 Piping diagram

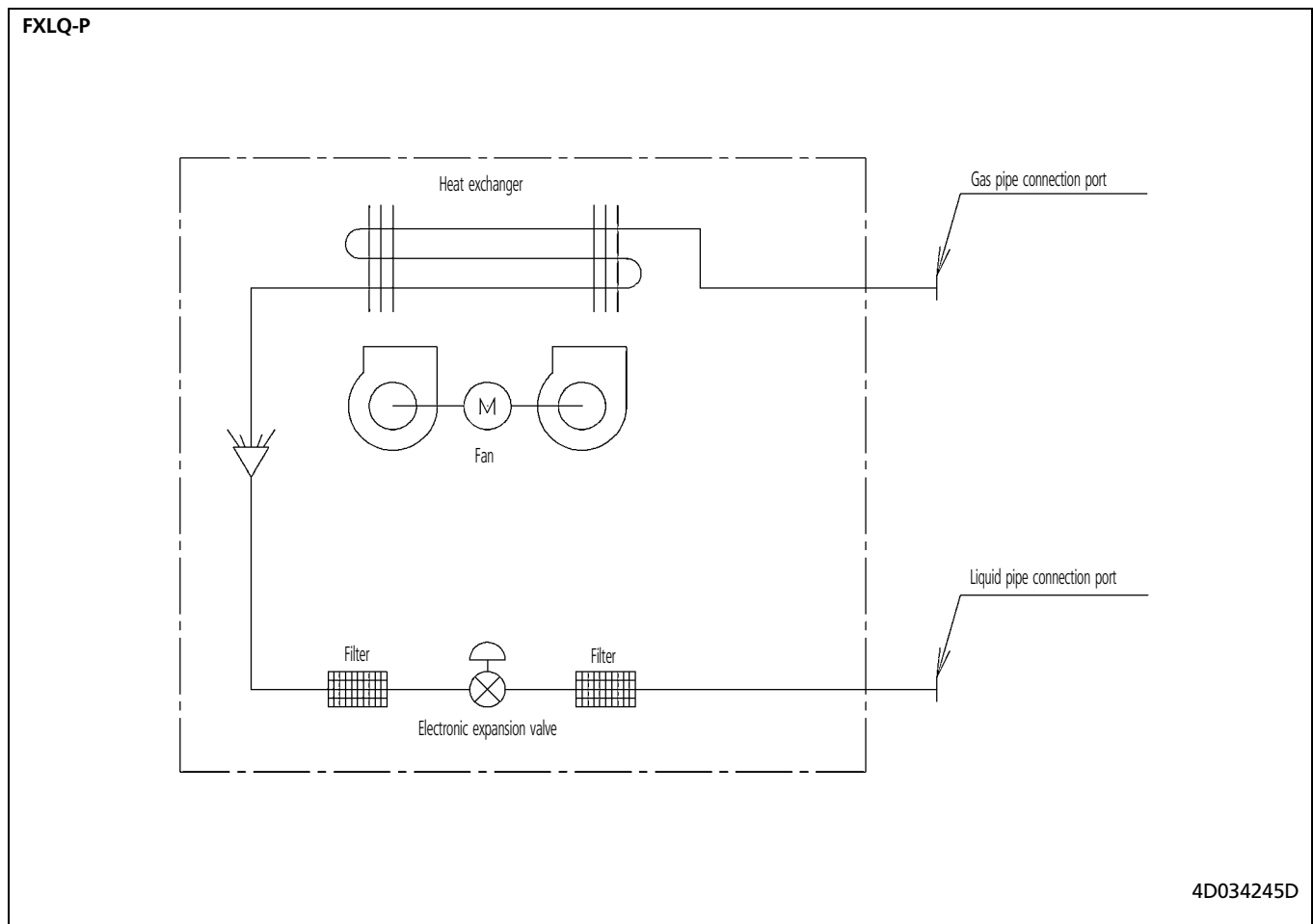

7 Wiring diagram

7 - 1 Wiring diagram

FXLQ-P

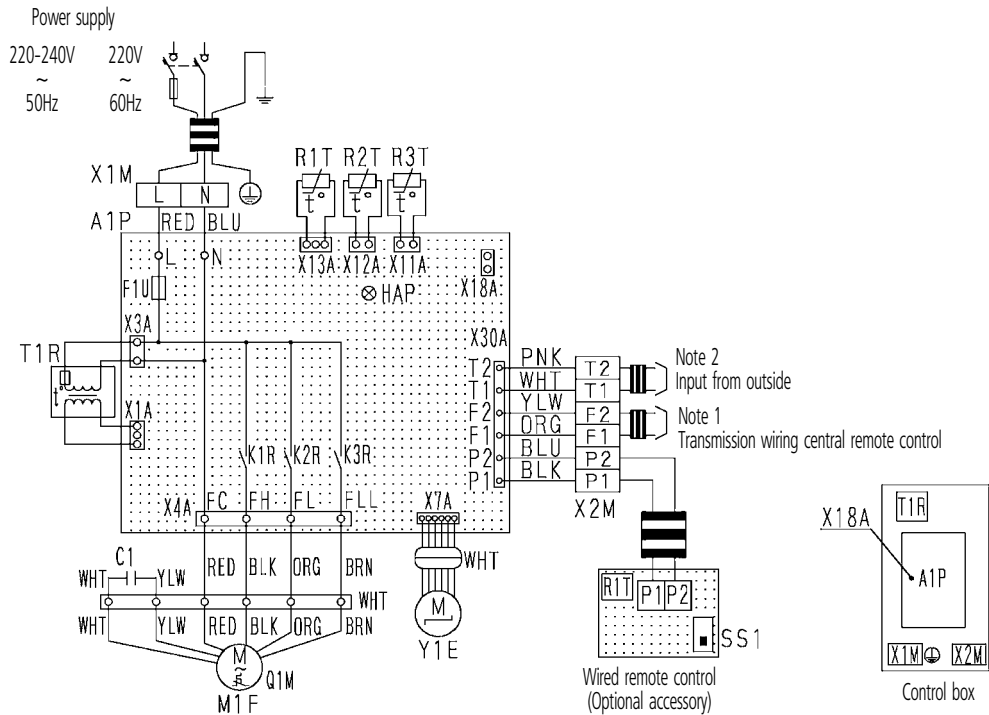

Indoor unit		R2T • R3T	Thermistor (Coil)
A1P	Printed circuit board	T1R	Transformer (220-240V/22V)
C1	Capacitor (M1F)	X1M	Terminal block (Power)
F1U	Fuse (⊗, 5A, 250V)	X2M	Terminal block (Control)
HAP	Light emitting diode (Service monitor-green)	Y1E	Electronic expansion valve
K1R-K3R	Magnetic relay (M1F)	Wired remote control	
M1F	Motor (Indoor fan)	R1T	Thermistor (Air)
Q1M	Thermo switch (M1F embedded)	SS1	Selector switch (Main/sub)
R1T	Thermistor (Air)	Connector for optional parts	
		X18A	Connector (Wiring adapter for electrical appendices)

: Terminal block
 : Connector
 : Terminal
 : Field wiring

COLORS : BLK : Black PNK : Pink
 BLU : Blue RED : Red
 BRN : Brown WHT : White
 ORG : Orange YLW : Yellow

NOTES

- In case using central remote control, connect it to the unit in accordance with the attached instruction manual.
- When connecting the input wires from the outside, forced off or on/off control operation can be selected by remote control. In details, refer to the installation manual attached to the unit.
- Use copper conductors only.

8 Sound data

8 - 1 Sound pressure spectrum

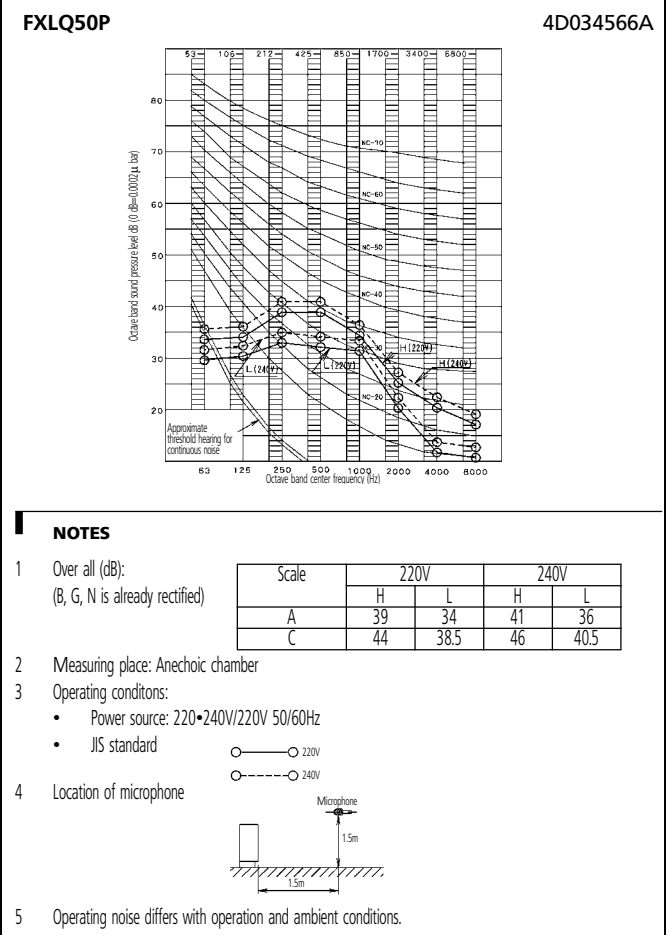
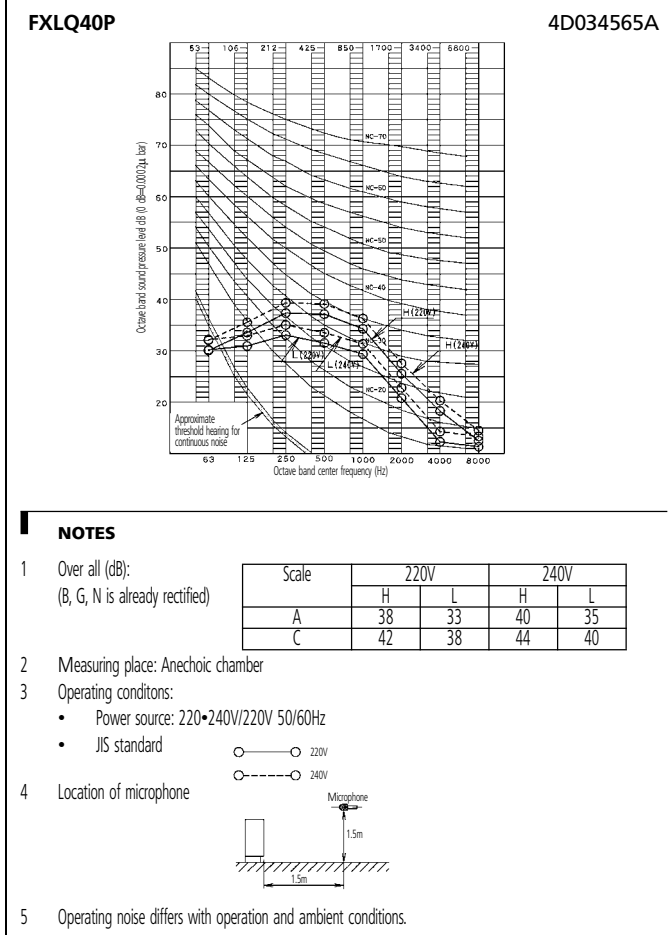
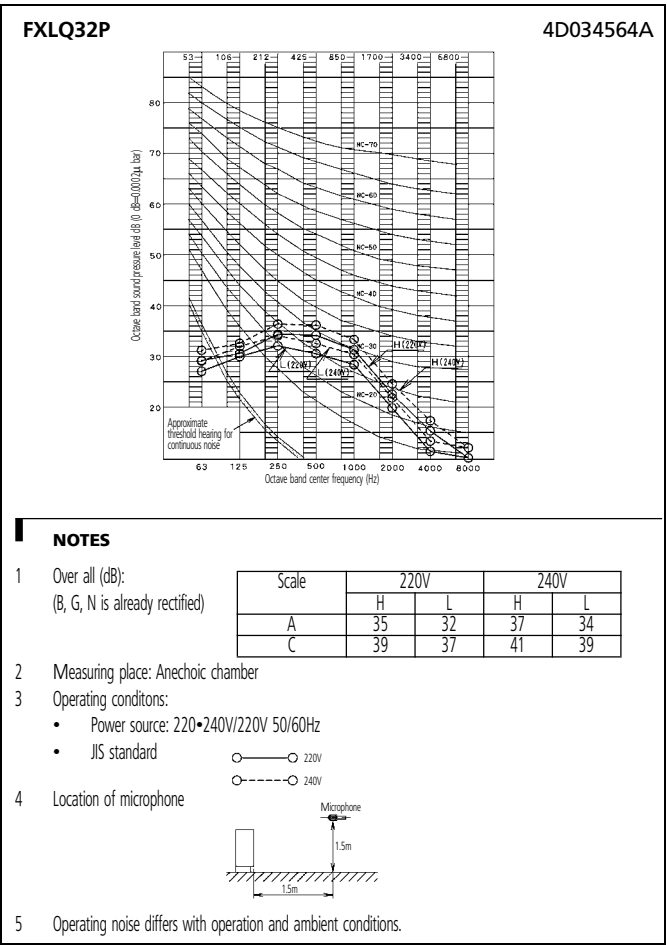
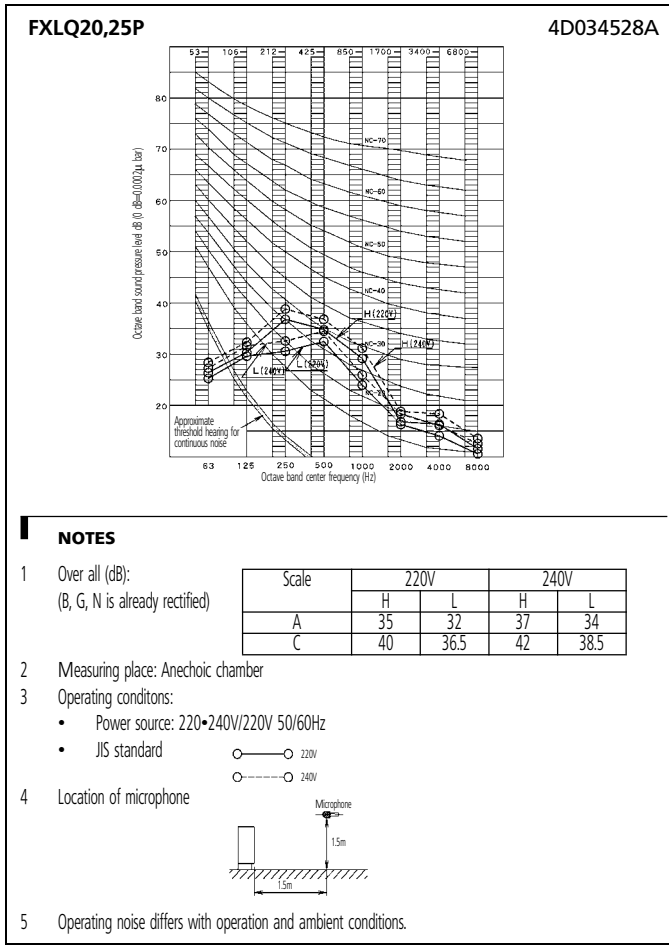

8 Sound data

8 - 1 Sound pressure spectrum

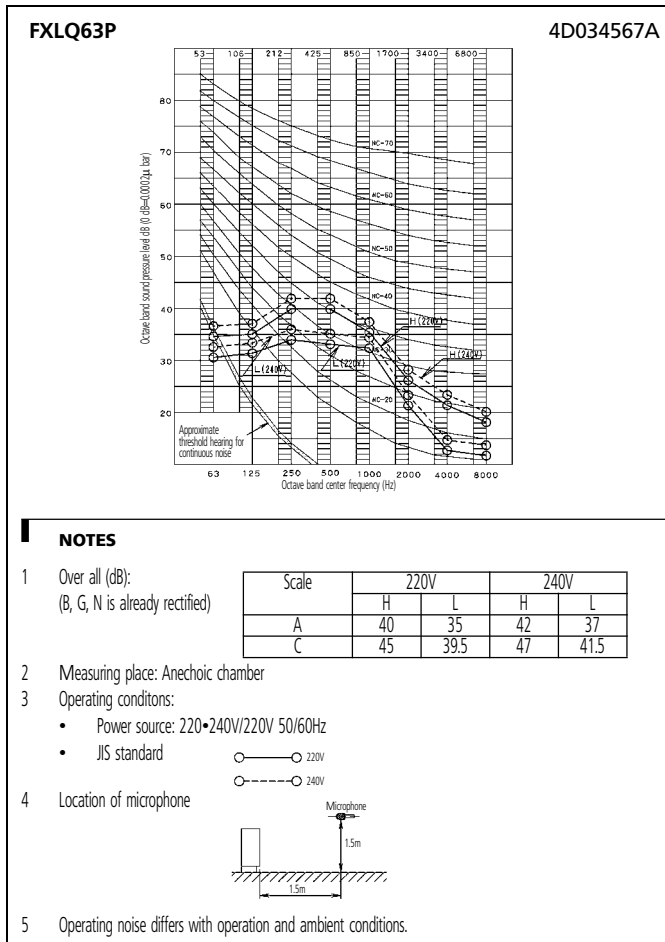

9 Installation

9 - 1 Suspension bolt pitch position

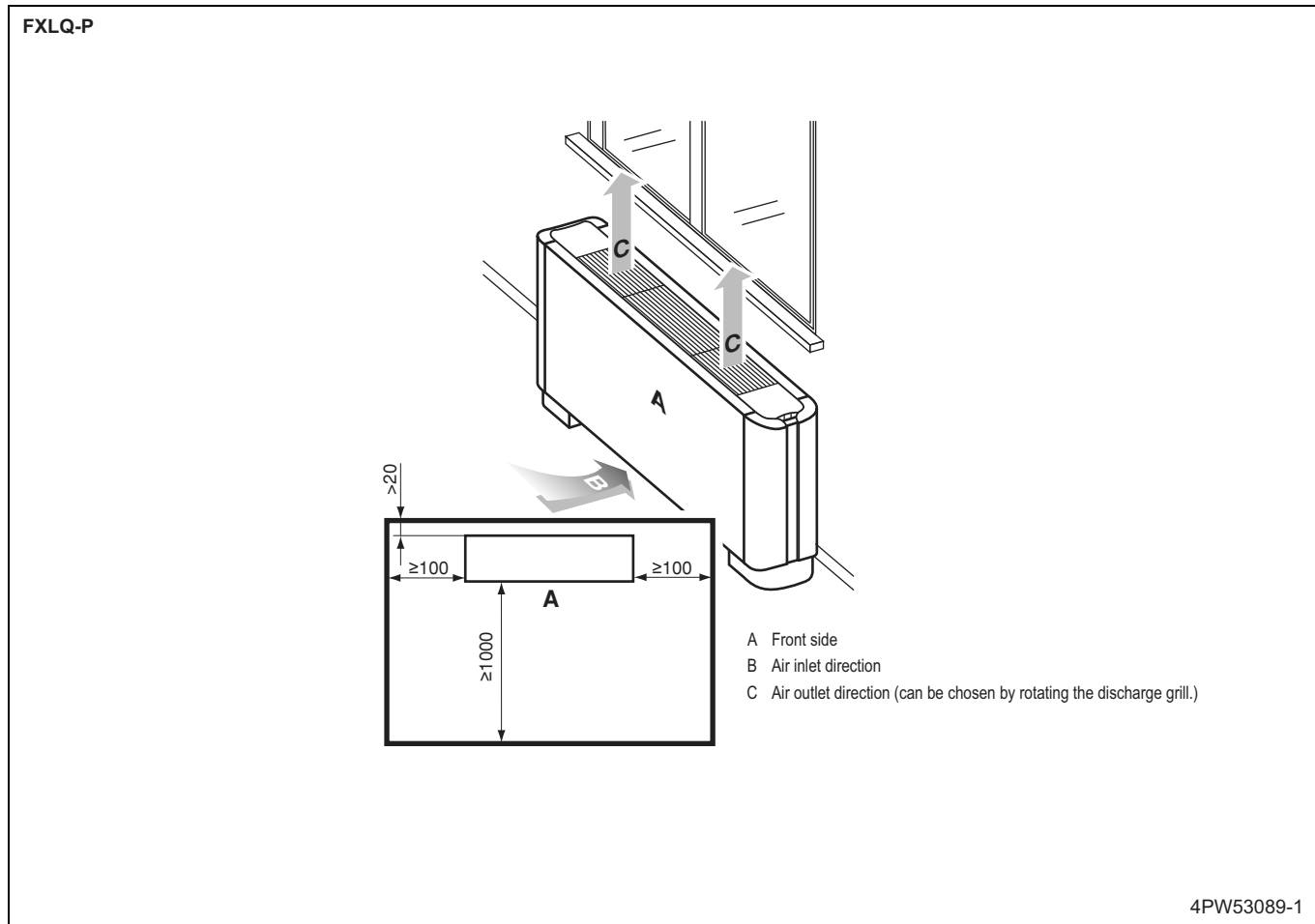

9 Installation

9 - 2 Service space

FXLQ-P

- 1 Position of holes for fastening to the wall.
Unit of measurement = mm.

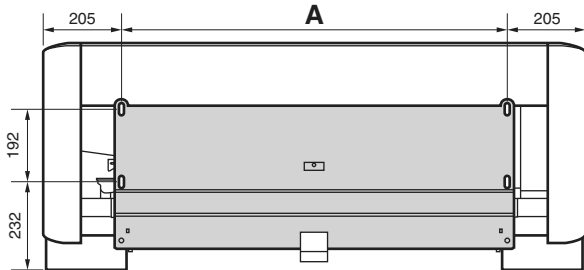

Model	A (mm)
FXLQ20P + FXLQ25P	590
FXLQ32P + FXLQ40P	730
FXLQ50P + FXLQ63P	1,010

- 2 How to open and close the front panel

To open the front panel, remove 4 screws from the corner pieces, unhook the corner pieces and remove the front panel as shown in the figure below.

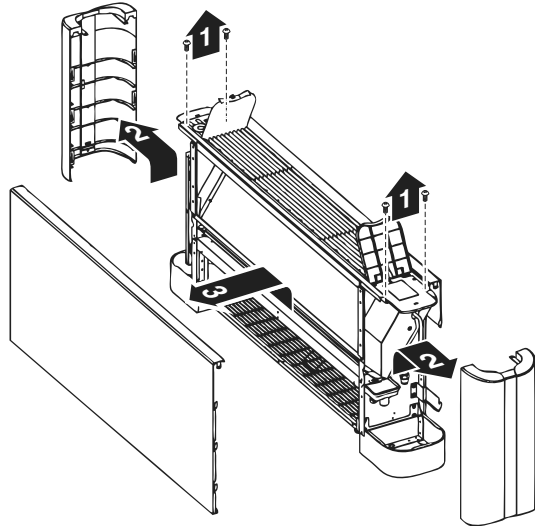

To close the front panel, use the opposite method.

4PW53089-1

In all of us,
a green heart



Daikin's unique position as a manufacturer of air conditioning equipment, compressors and refrigerants has led to its close involvement in environmental issues. For several years Daikin has had the intension to become a leader in the provision of products that have limited impact on the environment. This challenge demands the eco design and development of a wide range of products and an energy management system, resulting in energy conservation and a reduction of waste.



Daikin Europe N.V. is approved by LRQA for its Quality Management System in accordance with the ISO9001 standard. ISO9001 pertains to quality assurance regarding design, development, manufacturing as well as to services related to the product.



ISO14001 assures an effective environmental management system in order to help protect human health and the environment from the potential impact of our activities, products and services and to assist in maintaining and improving the quality of the environment.



Daikin units comply with the European regulations that guarantee the safety of the product.

VRV® products are not within the scope of the Eurovent certification programme.

The present publication is drawn up by way of information only and does not constitute an offer binding upon Daikin Europe N.V.. Daikin Europe N.V. has compiled the content of this publication to the best of its knowledge. No express or implied warranty is given for the completeness, accuracy, reliability or fitness for particular purpose of its content and the products and services presented therein. Specifications are subject to change without prior notice. Daikin Europe N.V. explicitly rejects any liability for any direct or indirect damage, in the broadest sense, arising from or related to the use and/or interpretation of this publication. All content is copyrighted by Daikin Europe N.V..

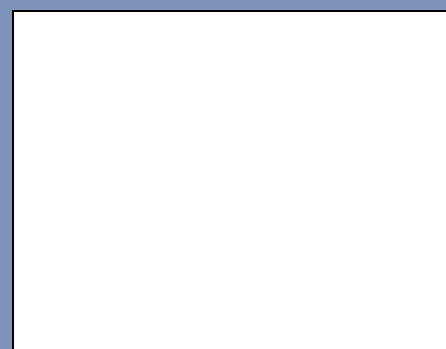

DAIKIN EUROPE N.V.

Naamloze Vennoetschap
Zandvoordestraat 300
B-8400 Oostende, Belgium
www.daikin.eu
BE 0412 120 336
RPR Oostende