



MODELS

FTXZ-N (25/35/50).....	1
FTXS-K (25/42/50).....	4
FTXLS-K (25/35)	
FTXM-K (35/42/50)	
ATXS-K (35/50)	
FTXS-G (60/71).....	8
FTX-G (60/71).....	11
FVXG-K (25/35/50).....	15
FVXS-F (25/35/50).....	20
FVXM-F (25/35/50)	
FLXS-B(9) (25/35/50).....	24
FTX-KN (25/35).....	28



FTXZ-N (25/35/50)

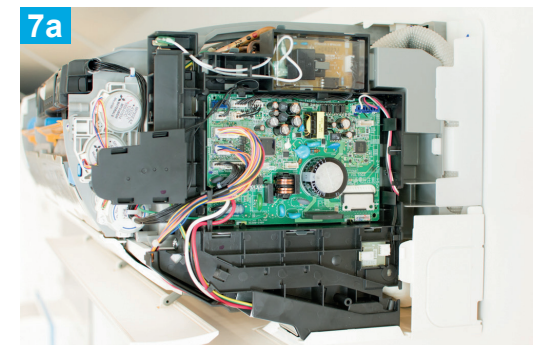
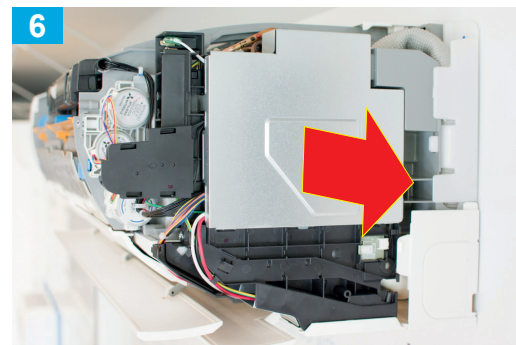
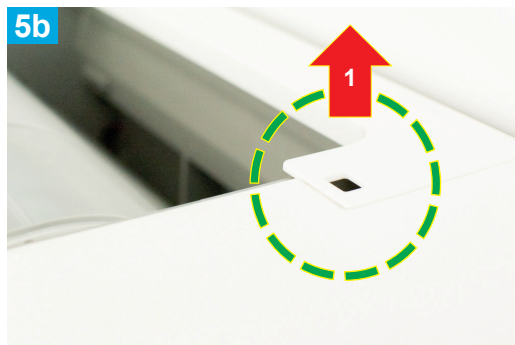
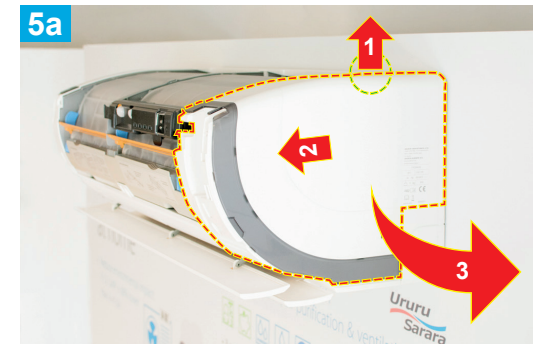
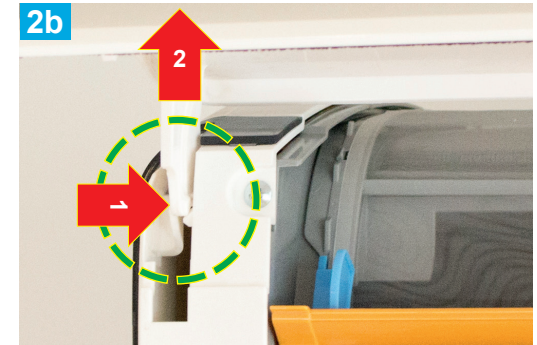
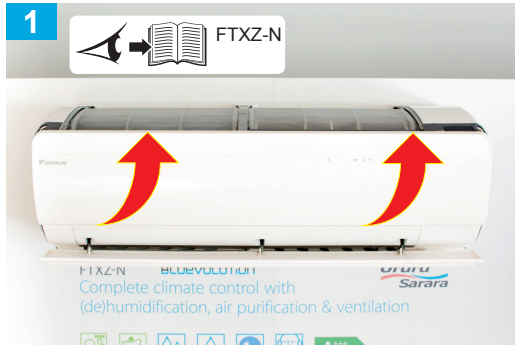
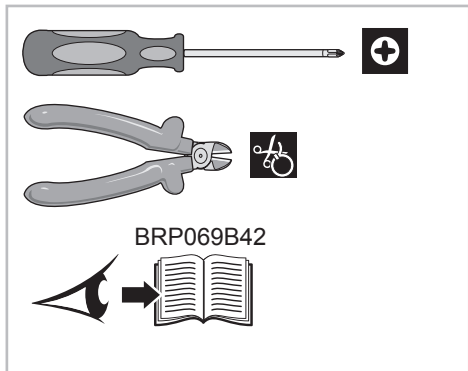
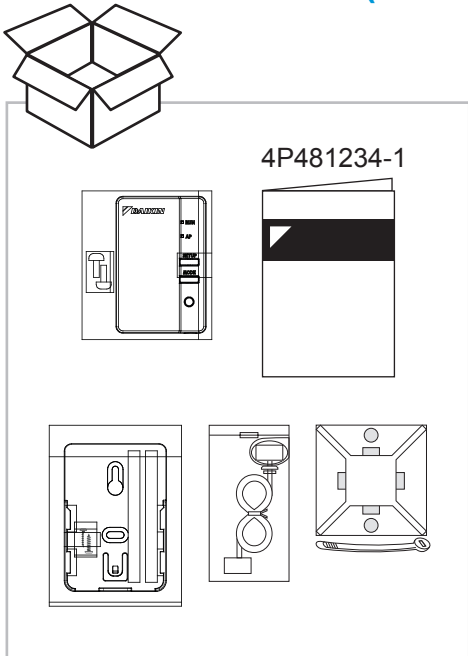



FTXZ-N (25/35/50)

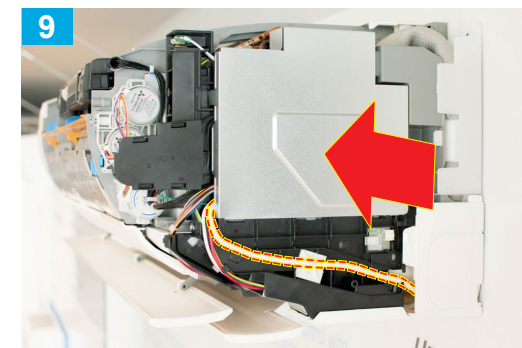
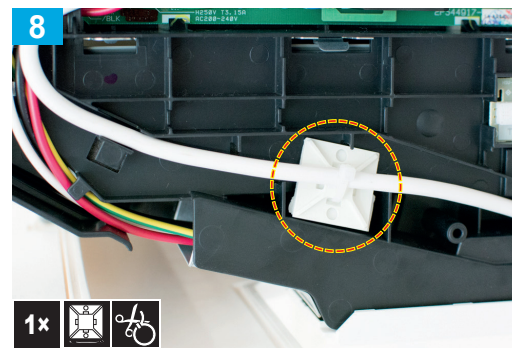
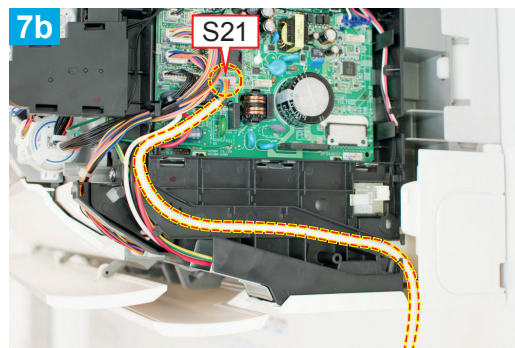

... 5 → 1 ...

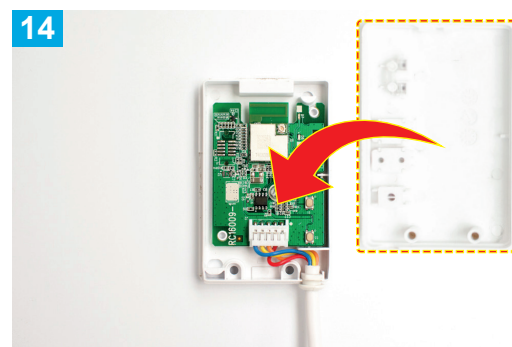
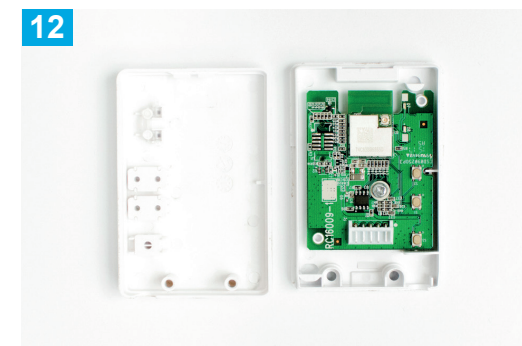
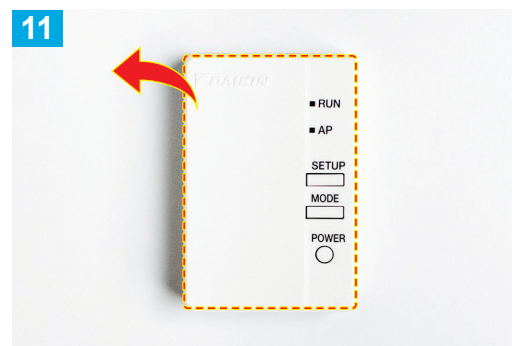



FTXZ-N (25/35/50)

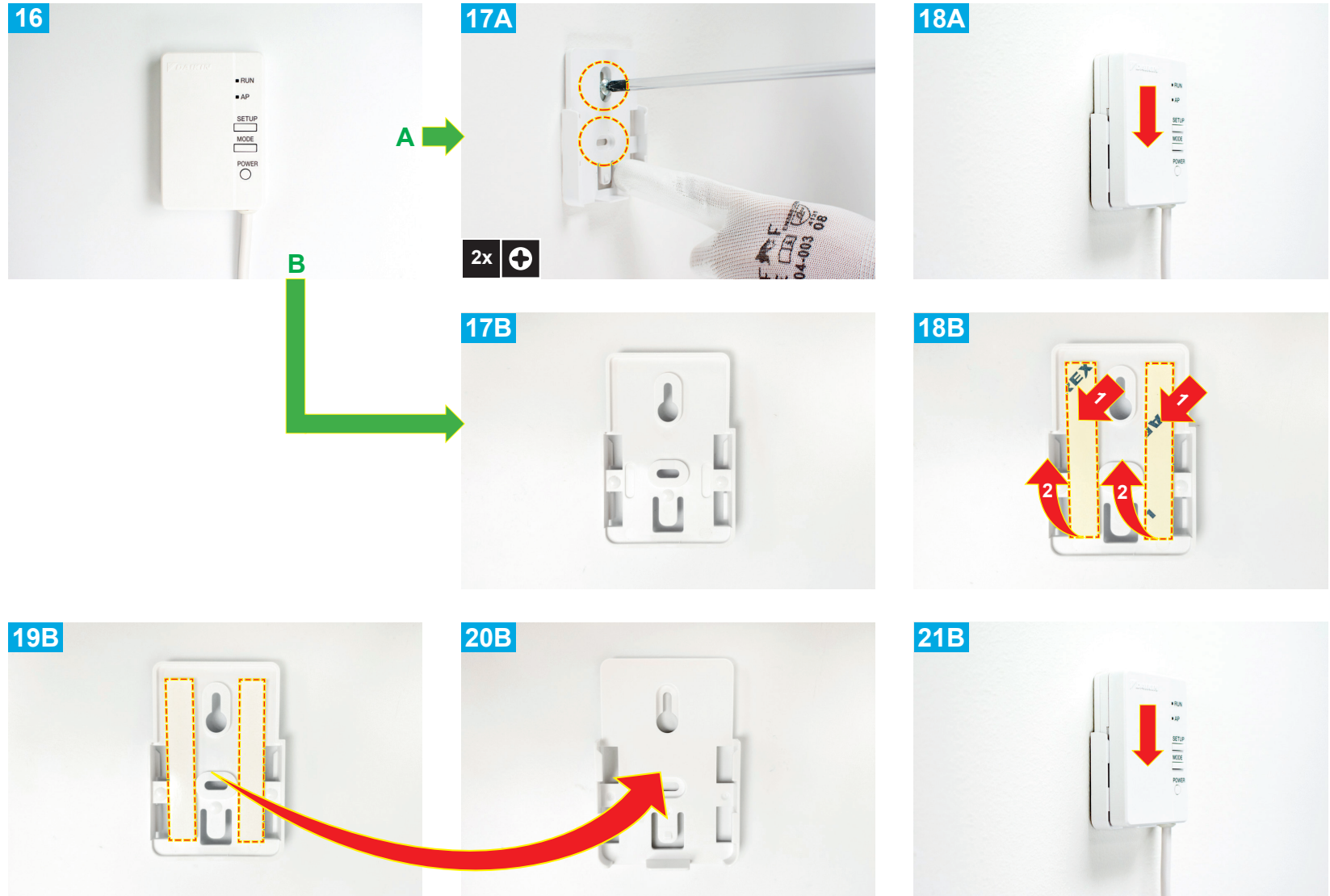



FTXS-K (35/42/50), FTXLS-K (25/35), FTXM-K (35/42/50), ATXS-K (35/50)

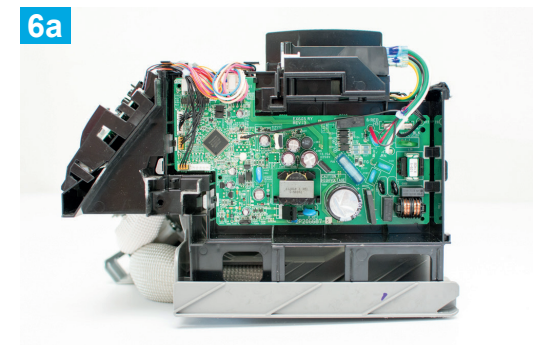
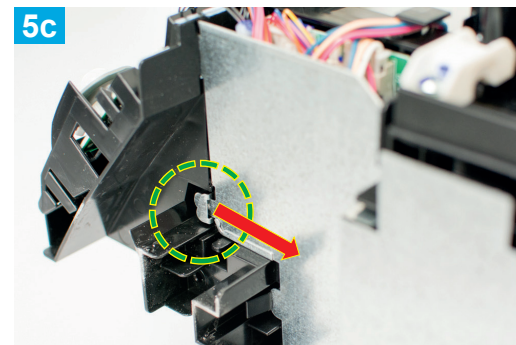
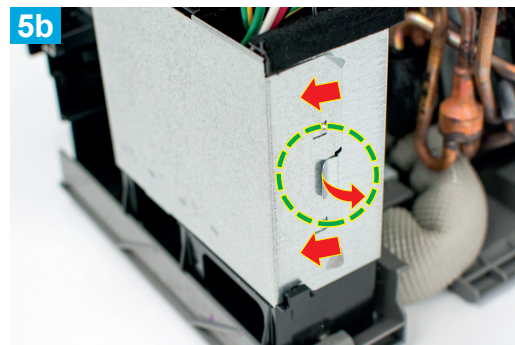
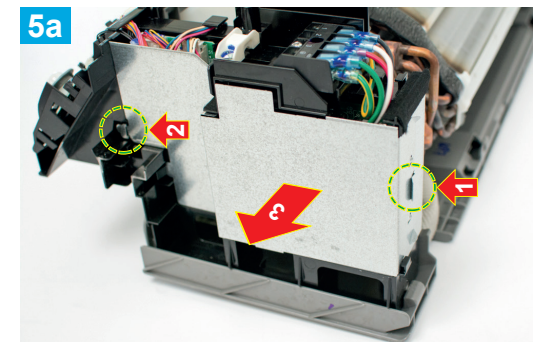
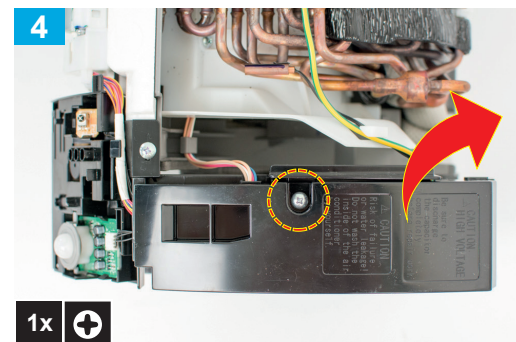
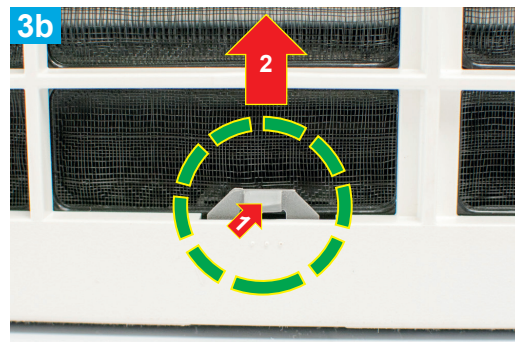
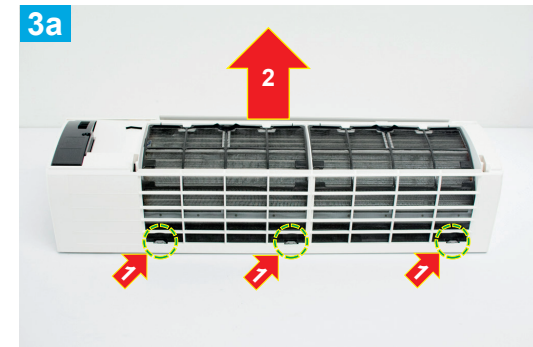
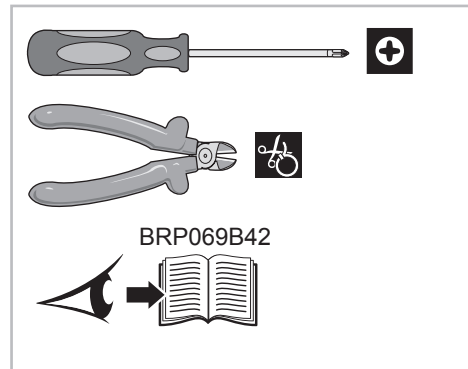
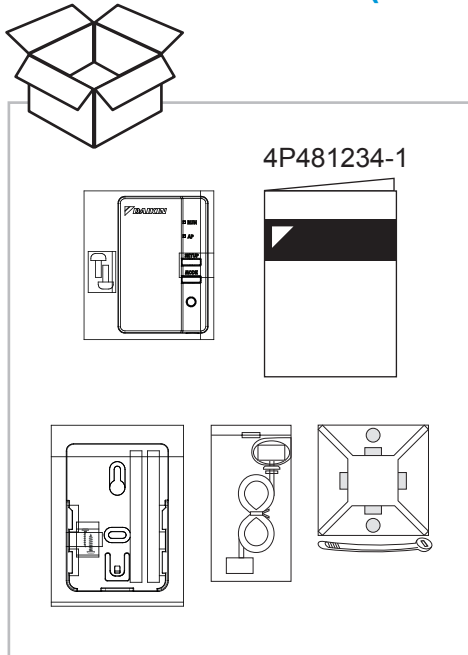



FTXS-K (35/42/50), FTXLS-K (25/35), FTXM-K (35/42/50), ATXS-K (35/50)

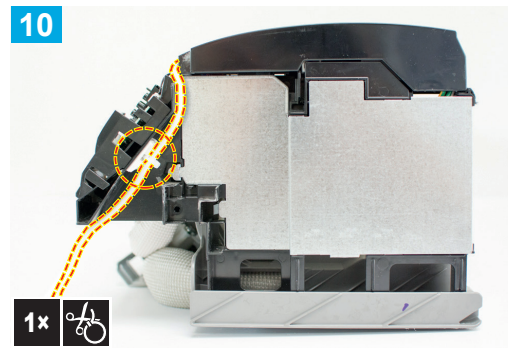
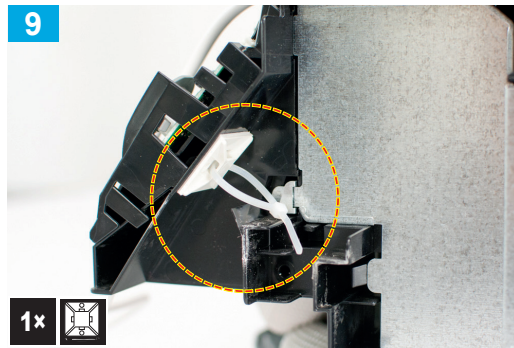
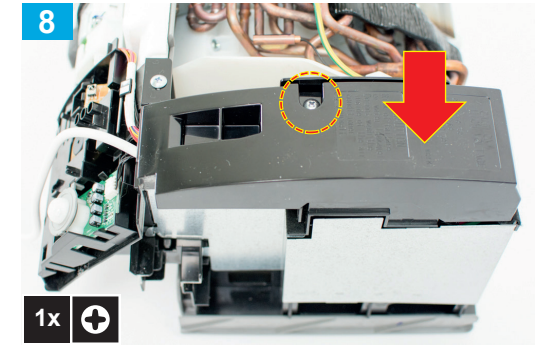
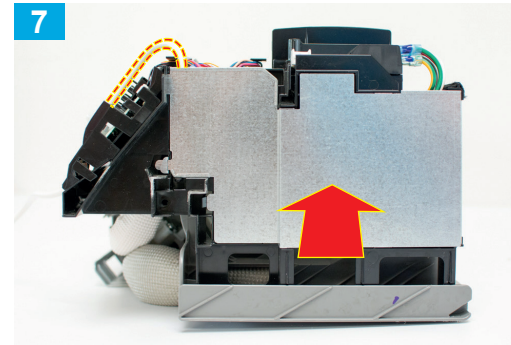
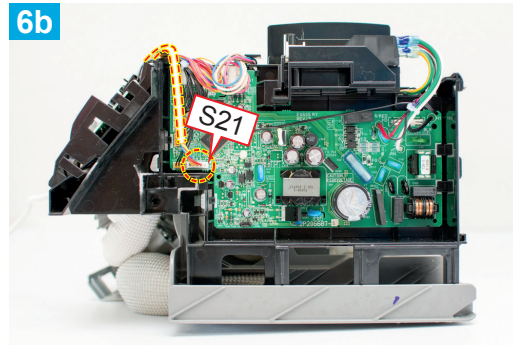

... 4 → 1 ...

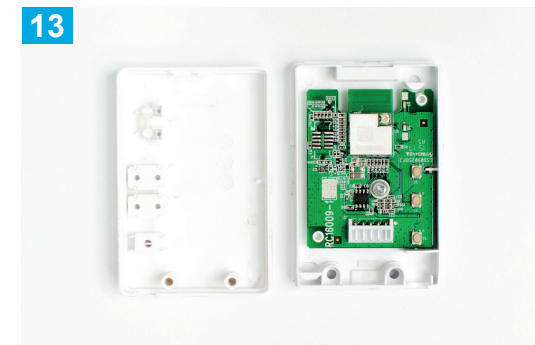
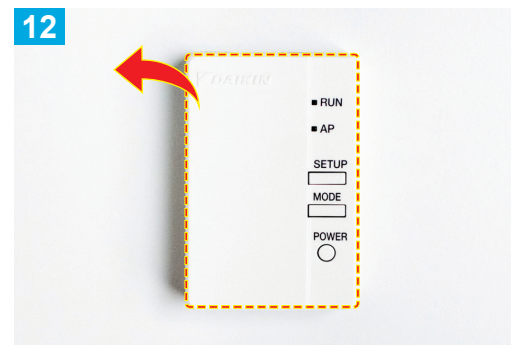
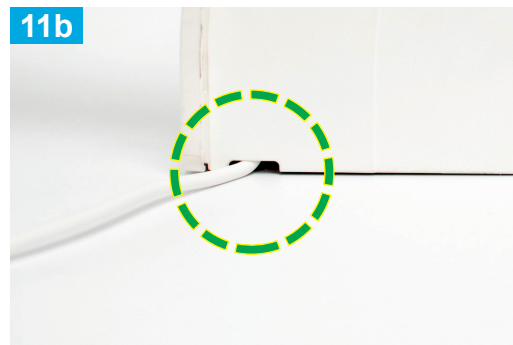



FTXS-K (35/42/50), FTXLS-K (25/35), FTXM-K (35/42/50), ATXS-K (35/50)

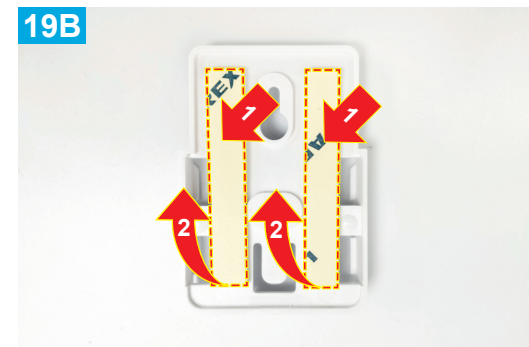
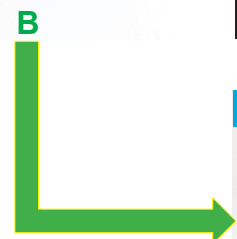
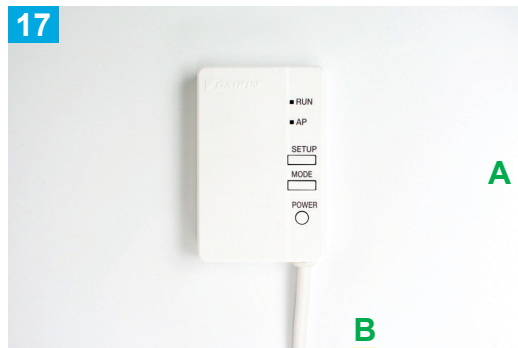
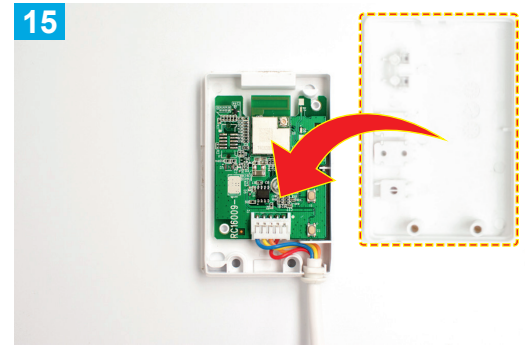
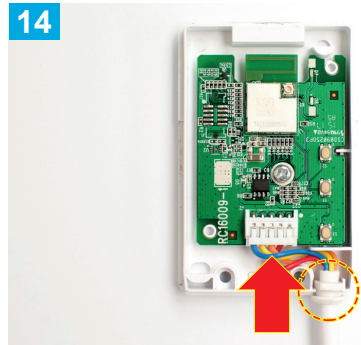



FTXS-K (35/42/50), FTXLS-K (25/35), FTXM-K (35/42/50), ATXS-K (35/50)

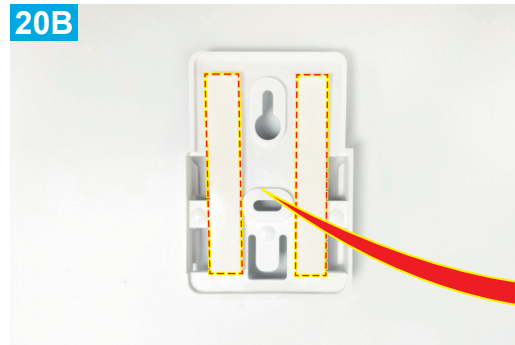



FTXS-G (60/71)

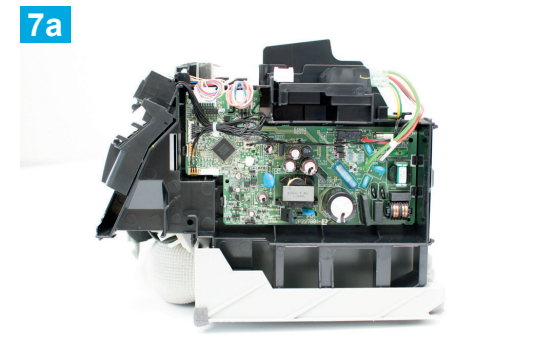
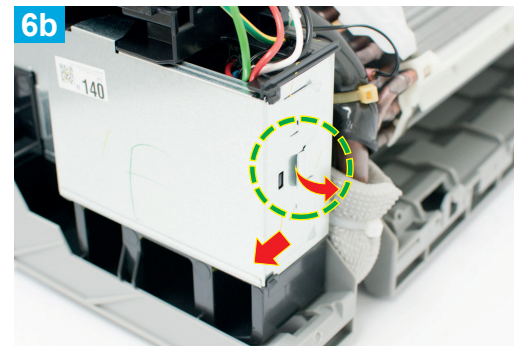
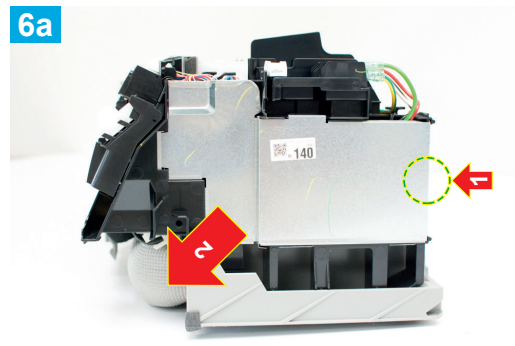
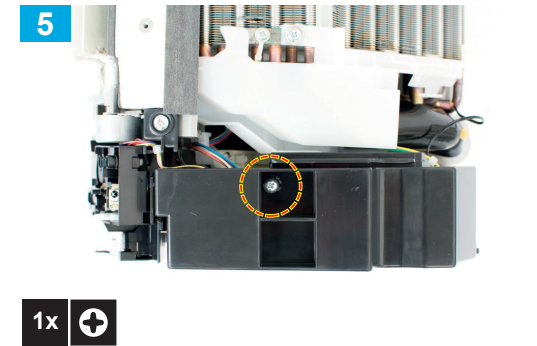
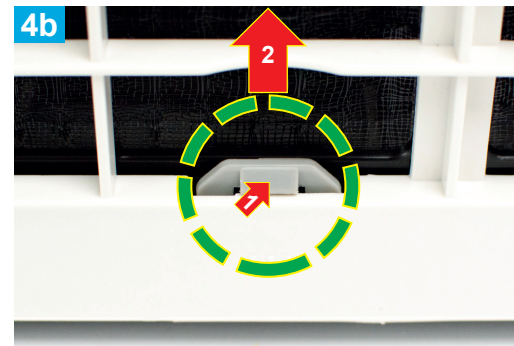
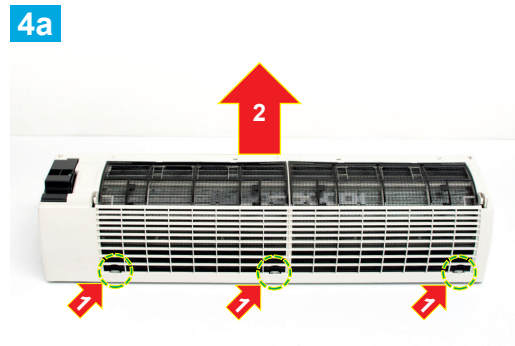
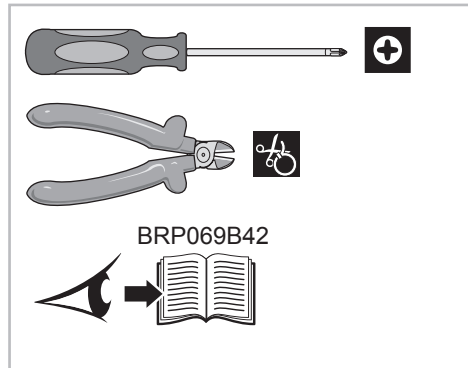
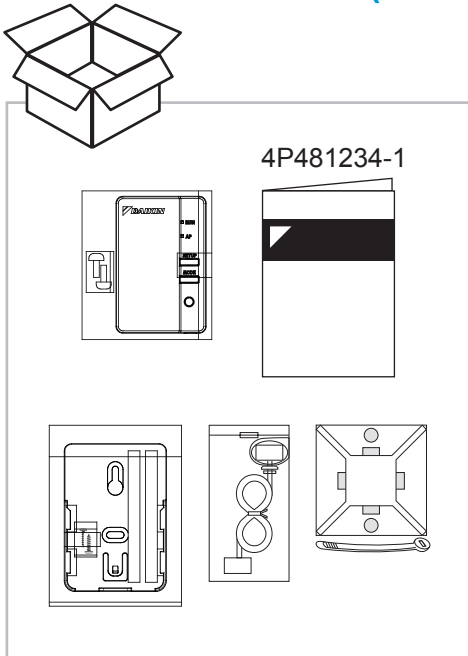



FTXS-G (60/71)

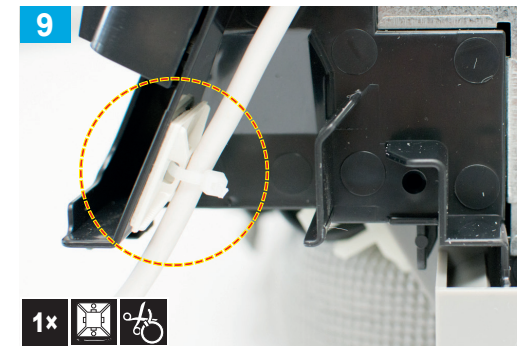
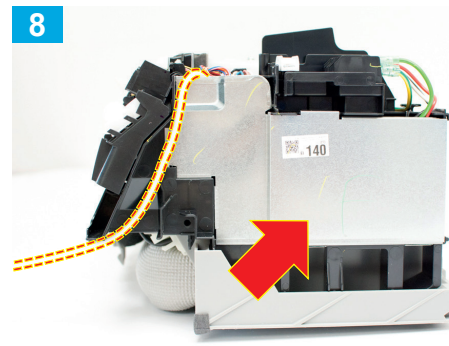
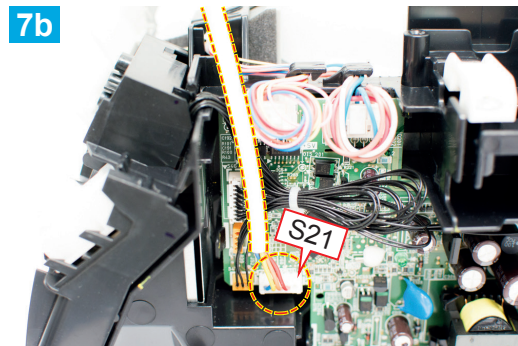

... **6** → **1** ...

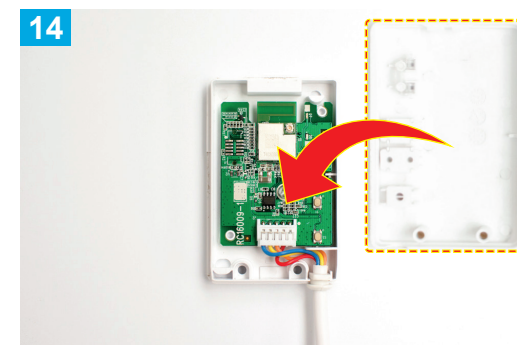
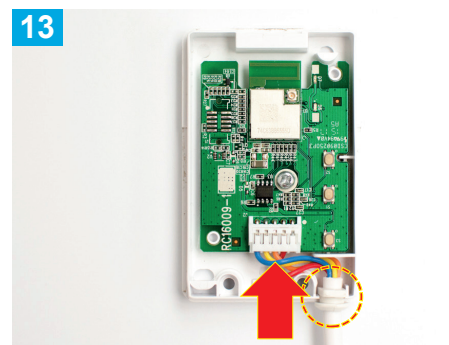
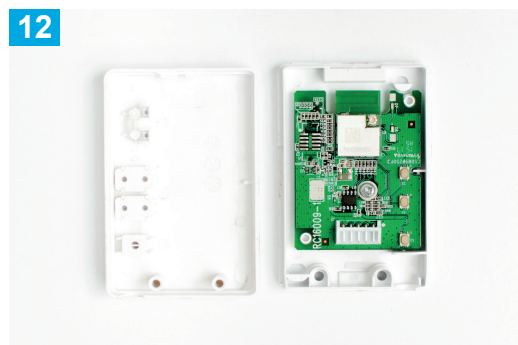
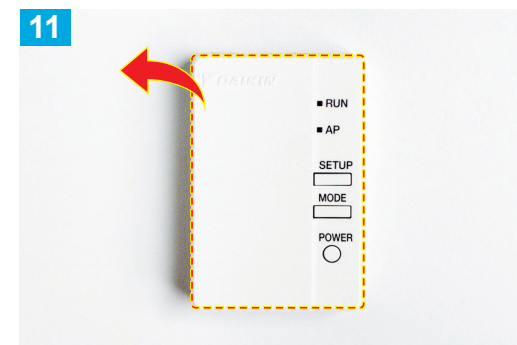



FTXS-G (60/71)

15



16

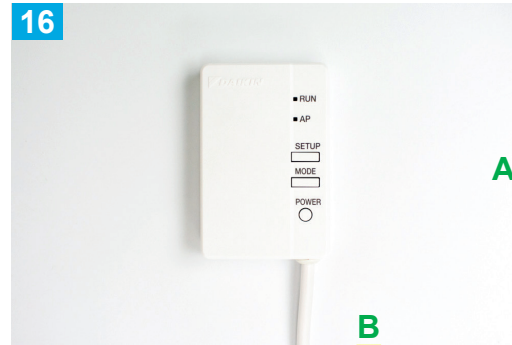

17A

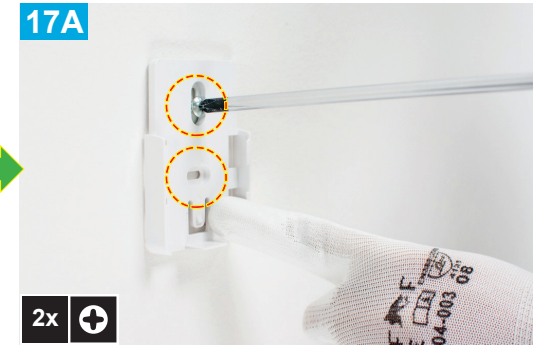

18A



17B



18B

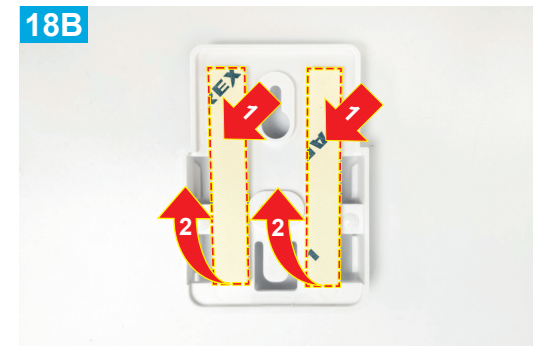

19B

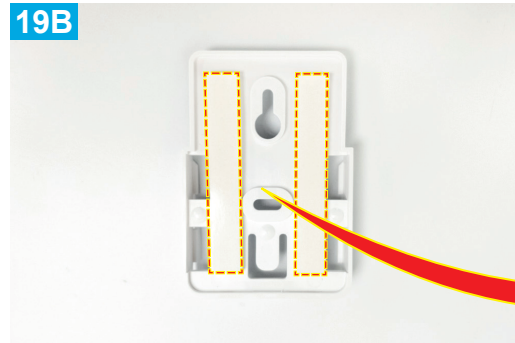

20B

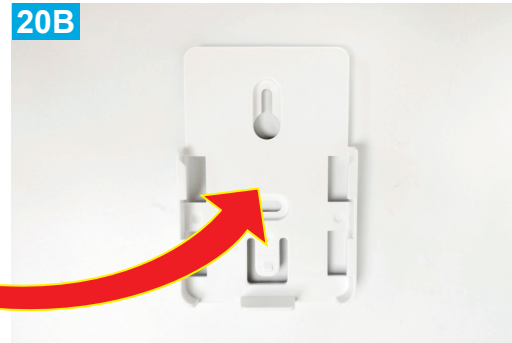

21B





FTX-G (60/71)

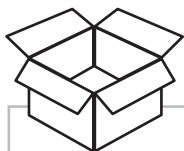

4P481234-1

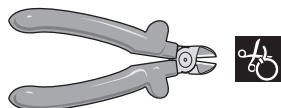
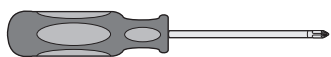
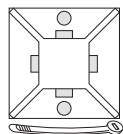
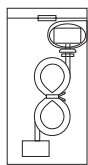
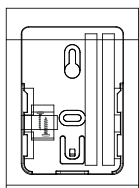
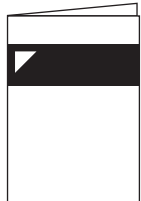
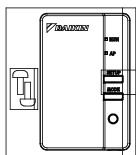

BRP069B42

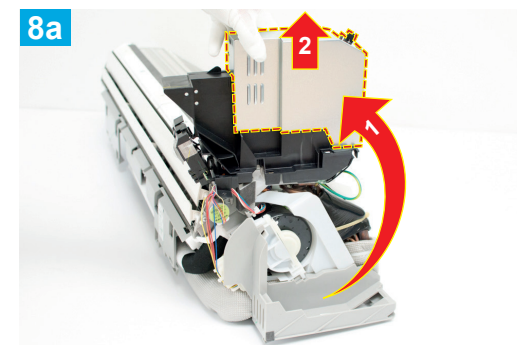
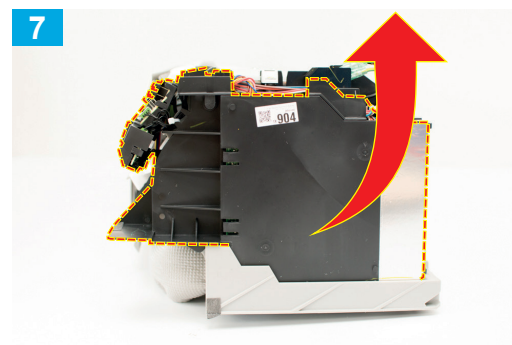
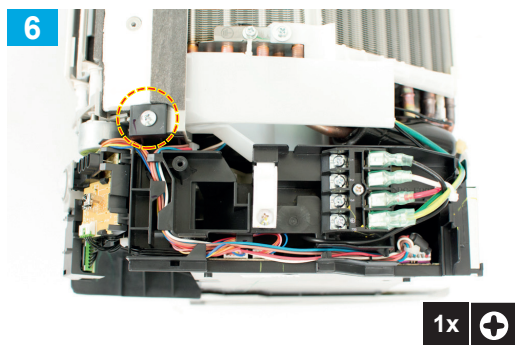
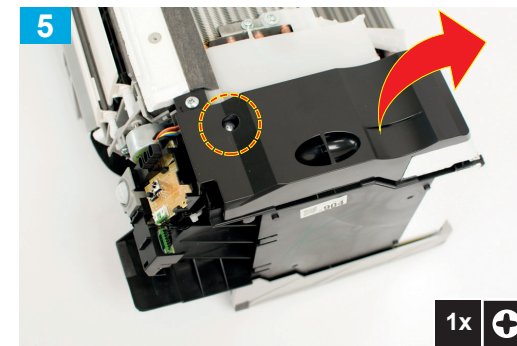
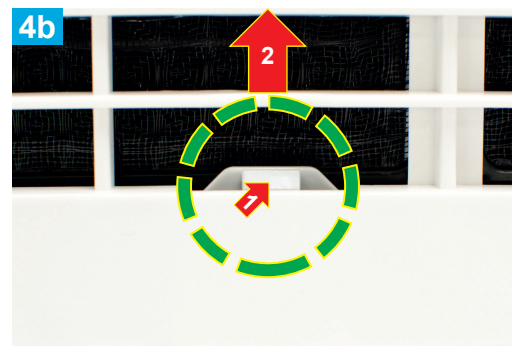
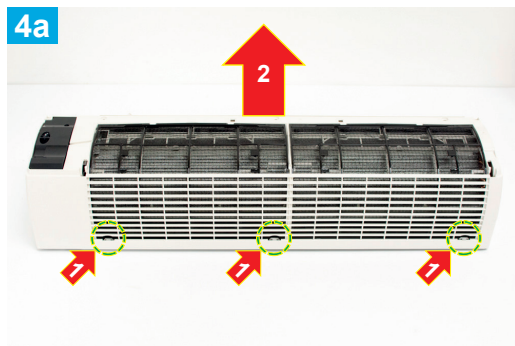



FTX-G (60/71)

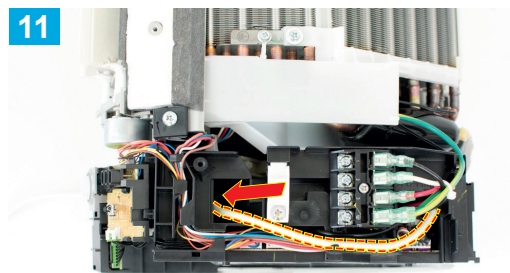
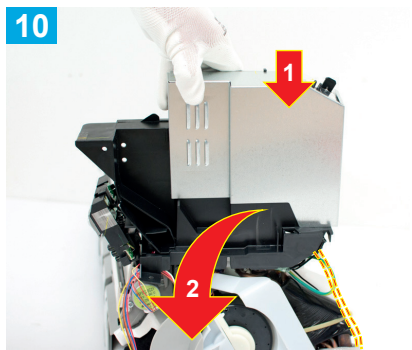
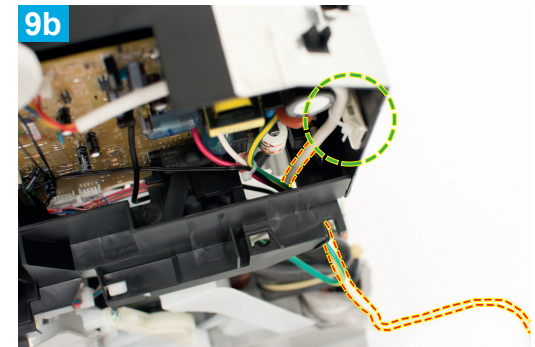
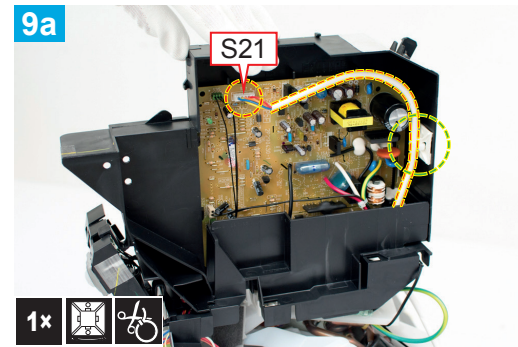
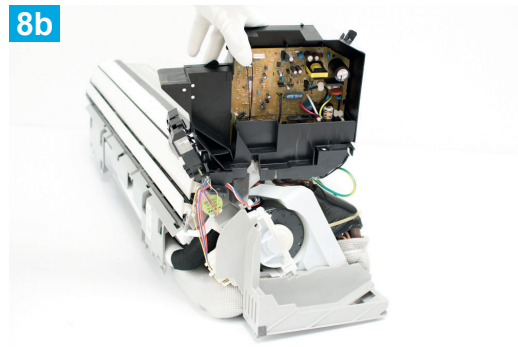

... 5 → 1 ...

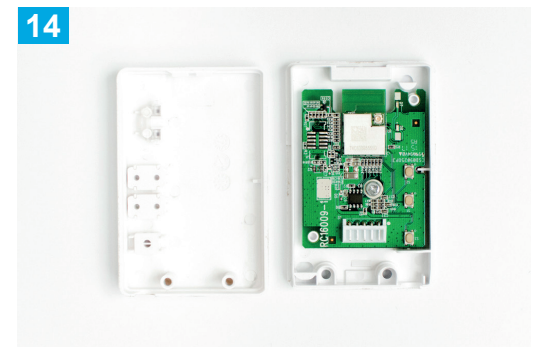
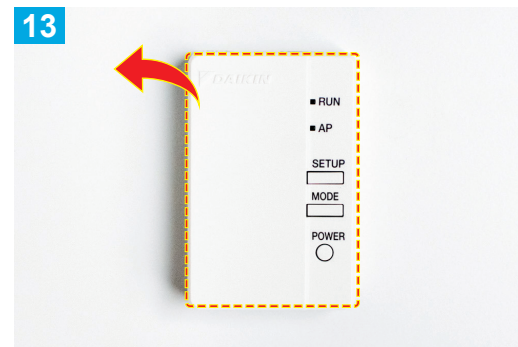



FTX-G (60/71)

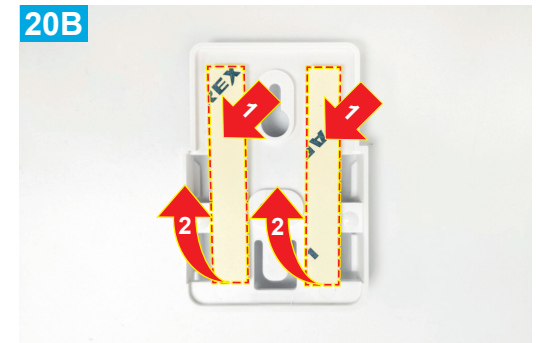
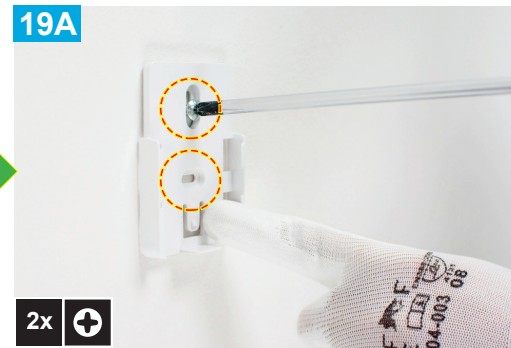
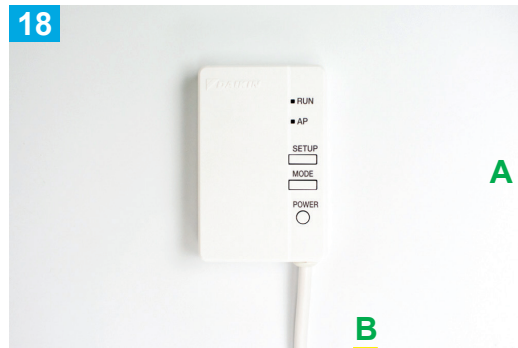
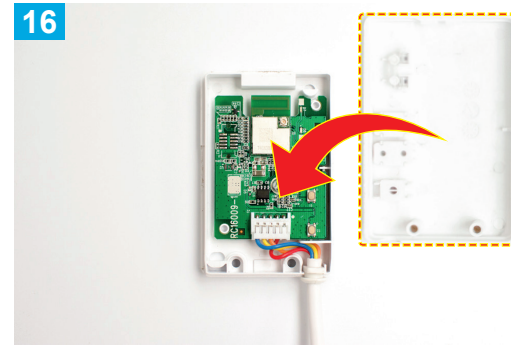



FTX-G (60/71)

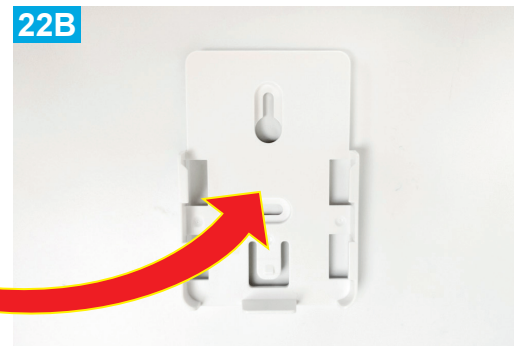
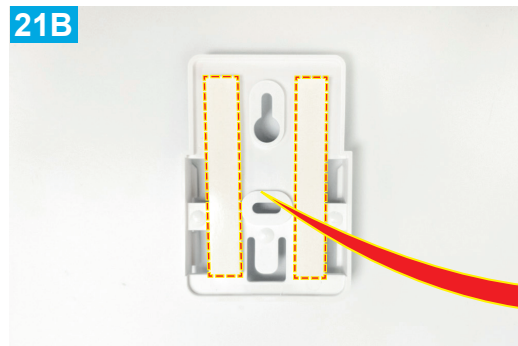



FVXG-K (25/35/50)

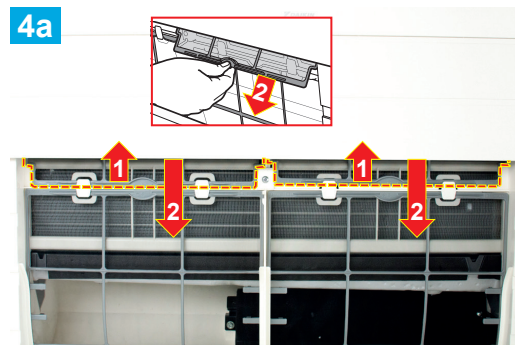
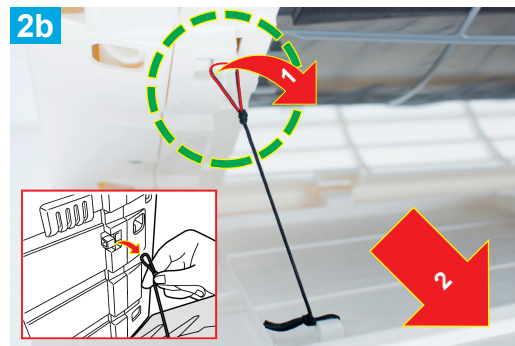
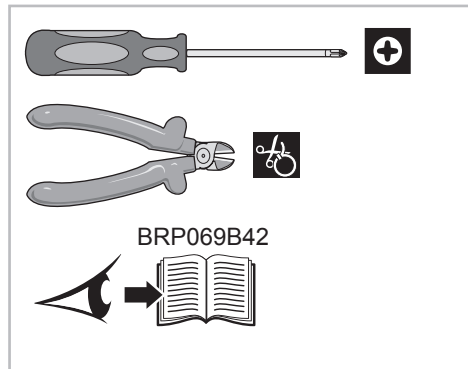
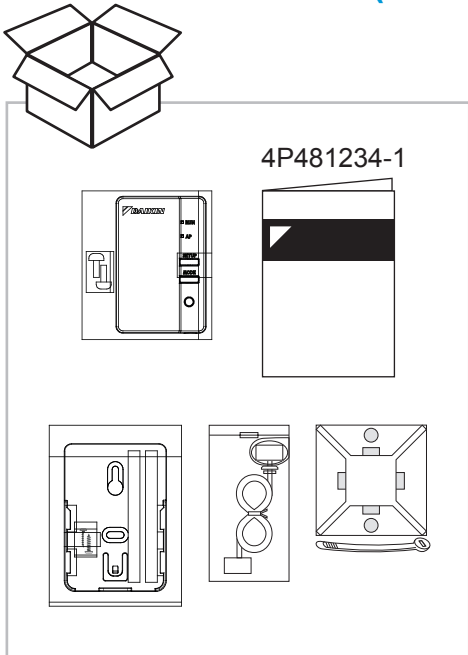



FVXG-K (25/35/50)

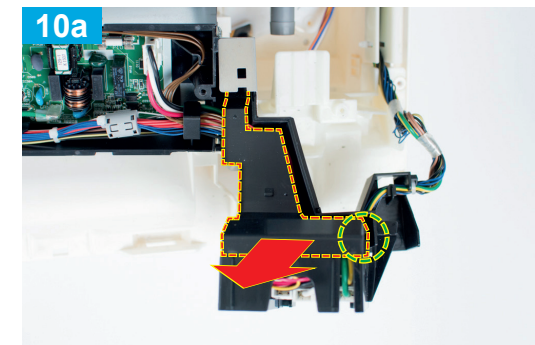
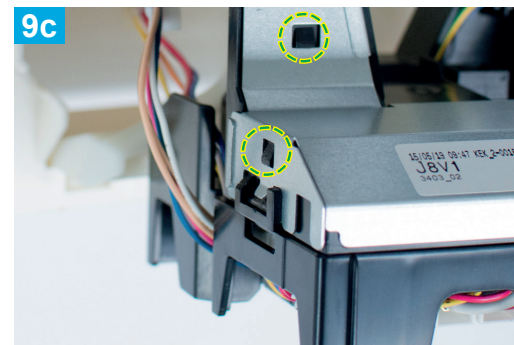
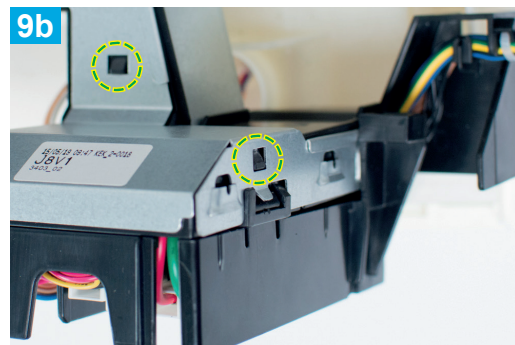
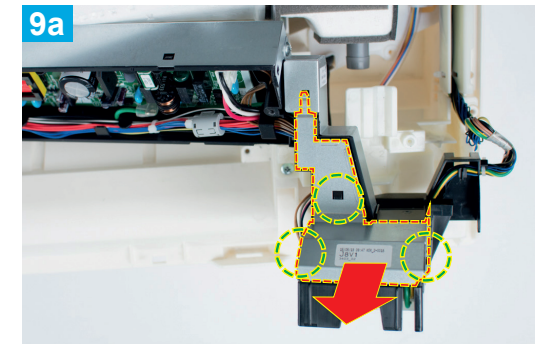
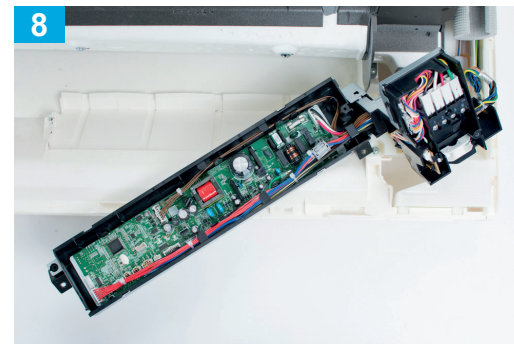
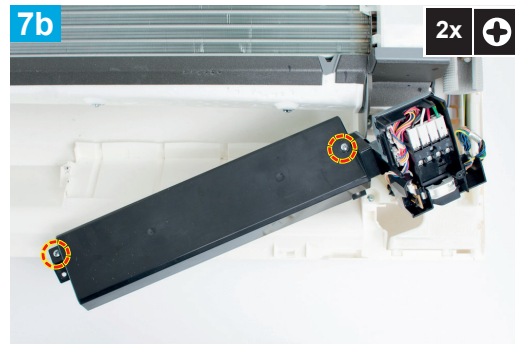
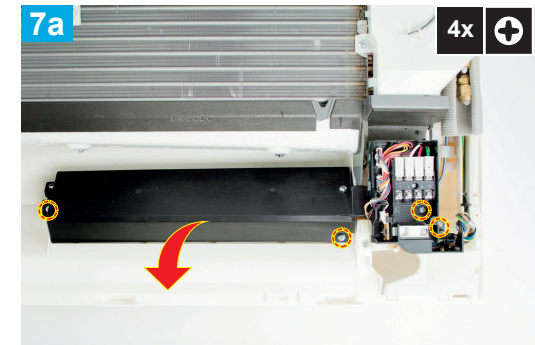
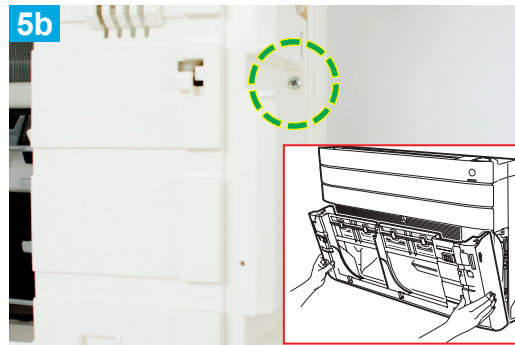



FVXG-K (25/35/50)

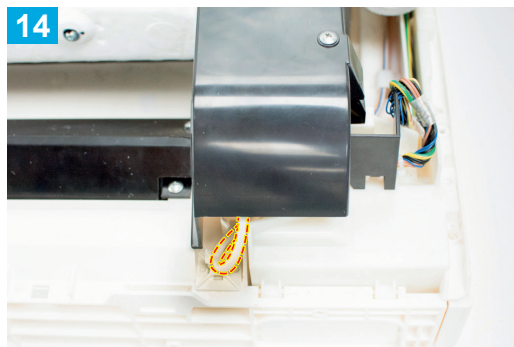
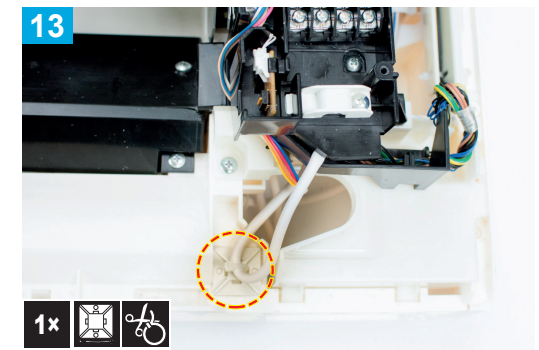
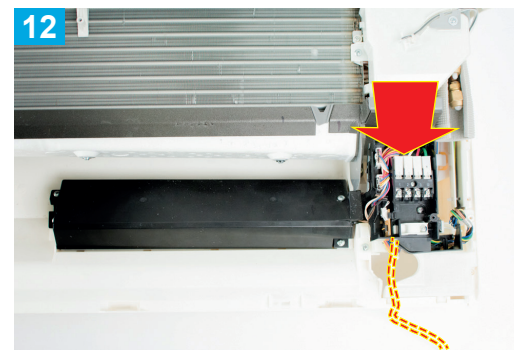
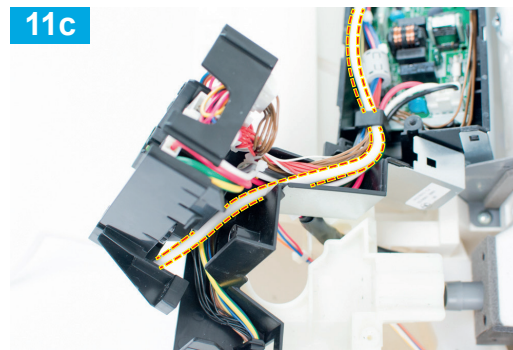
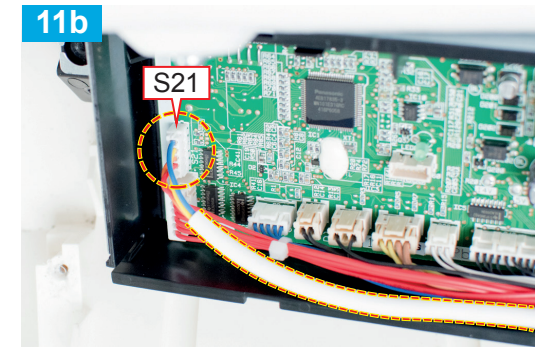
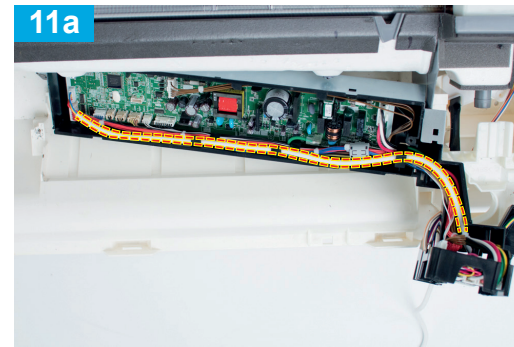
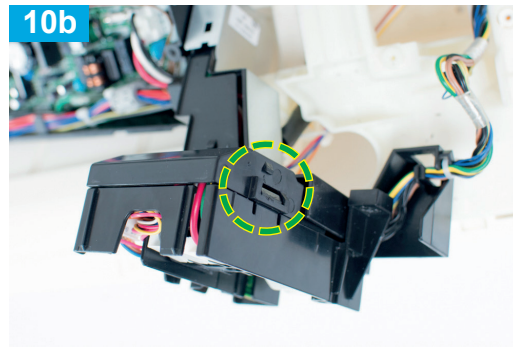

... 5 → 1 ...





FVXG-K (25/35/50)

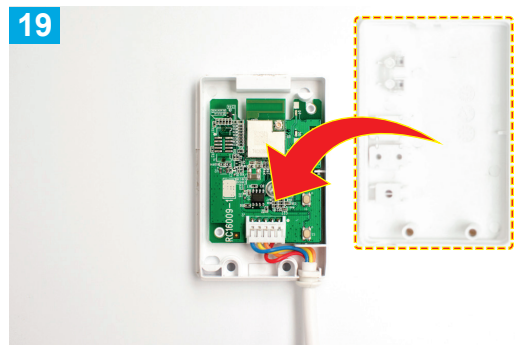
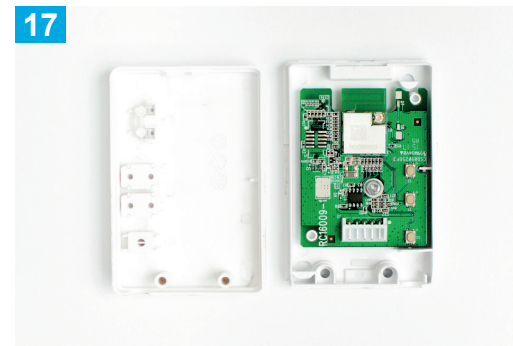
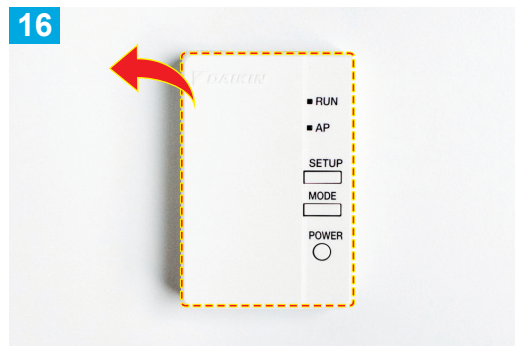

BRP069B42
DAIKIN MANUFACTURED IN THE CZECH REPUBLIC S.A. /
Příjem: Mladá Boleslav, Česká Republika
KčP: 0000097310
IČ: 000000000
Z.N. 0000000
DAIKIN GROUP
DAIKIN (EUROPE) LTD.





FVXG-K (25/35/50)

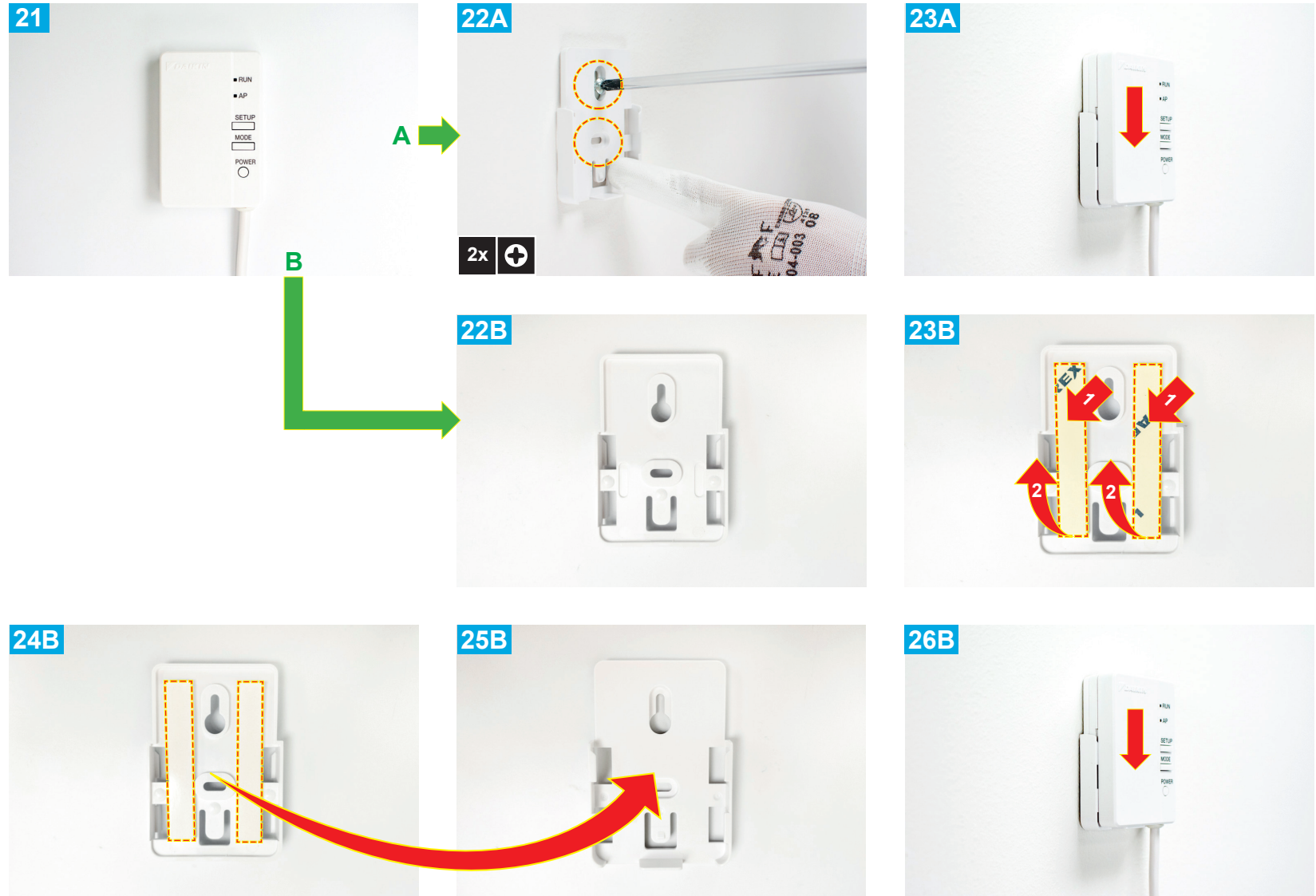



FVXS-F (25/35/50), FVXM-F (25/35/50)

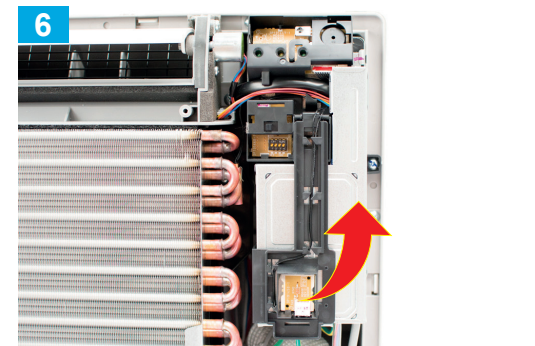
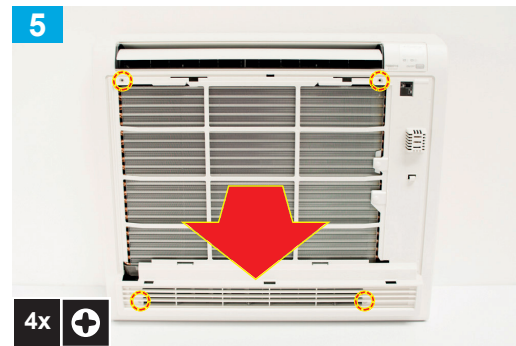
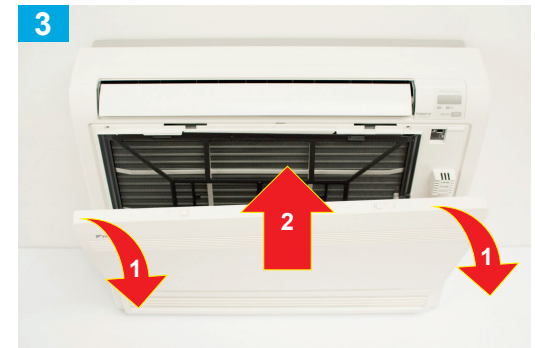
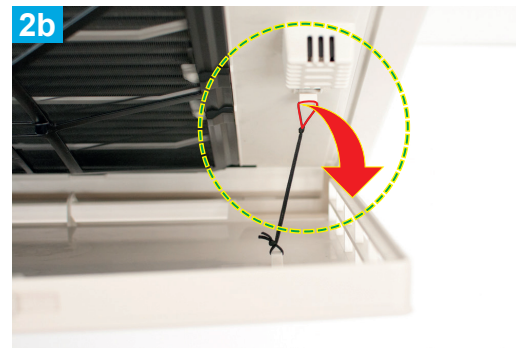
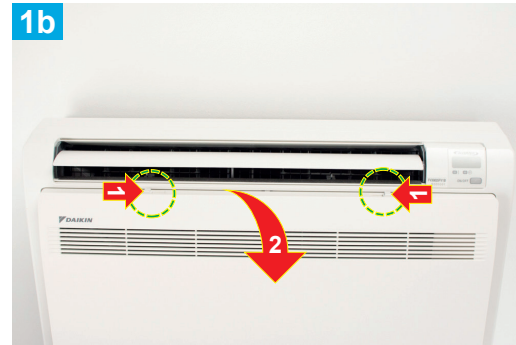
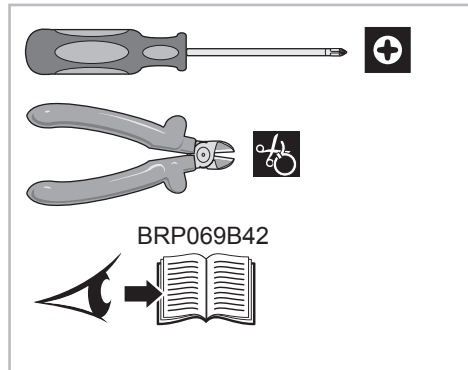
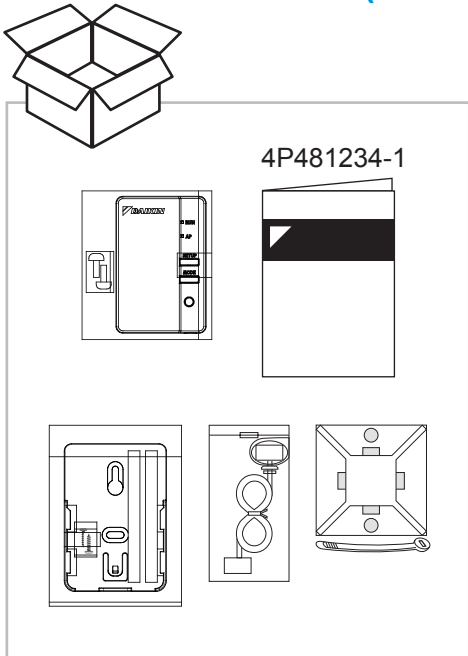



FVXS-F (25/35/50), FVXM-F (25/35/50)

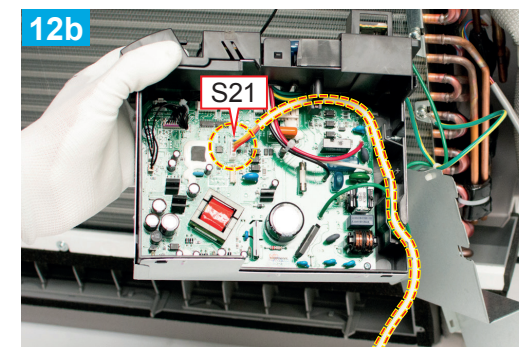
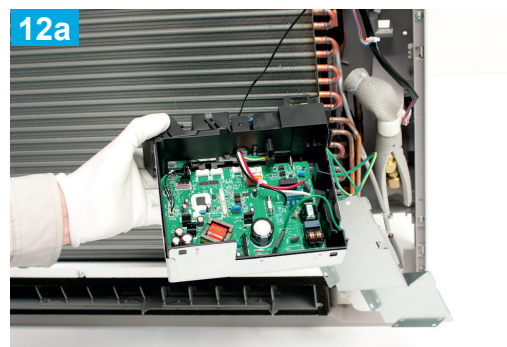
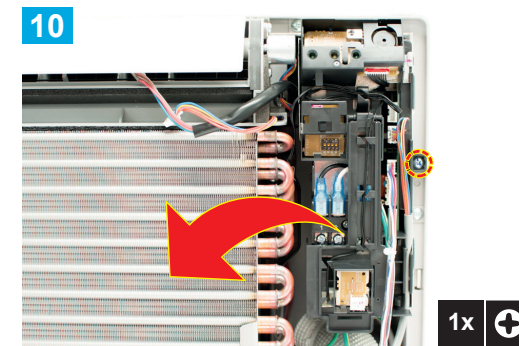
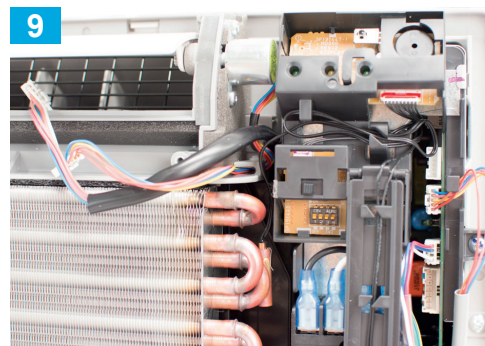
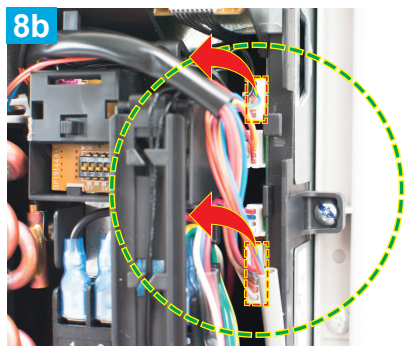
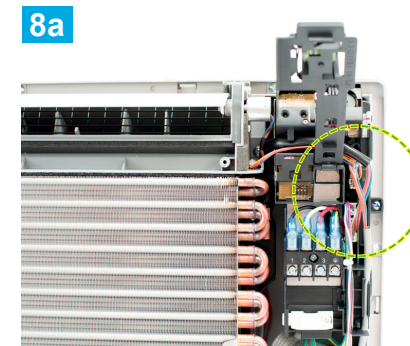
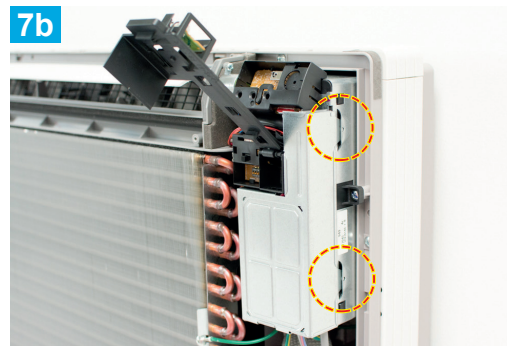
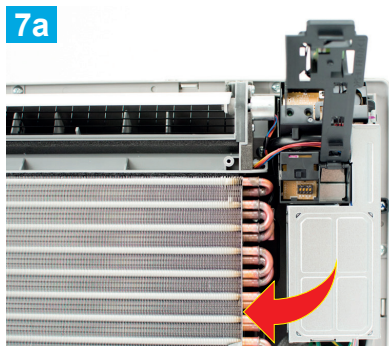



FVXS-F (25/35/50), FVXM-F (25/35/50)

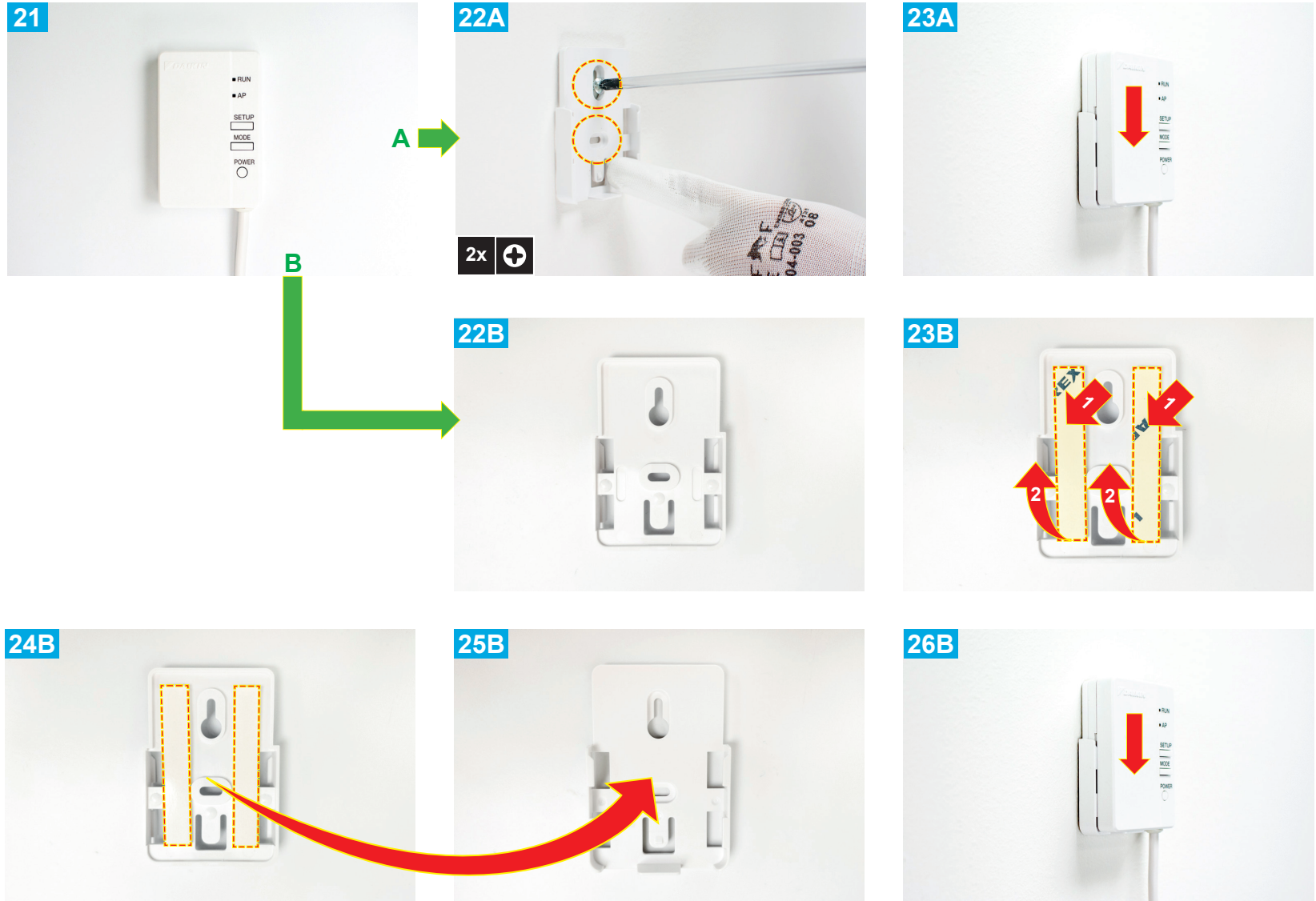



FLXS-B(9) (25/35/50)

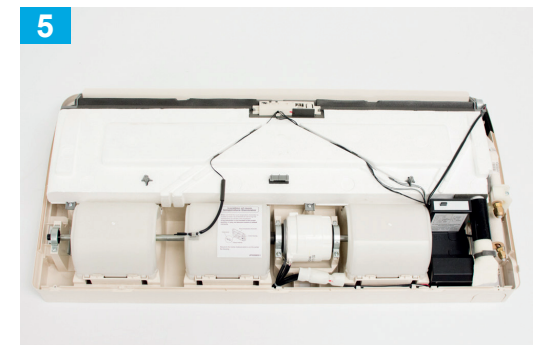
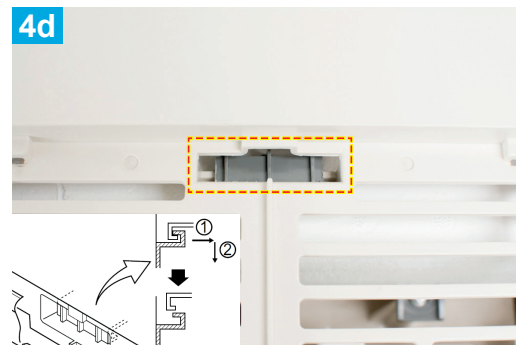
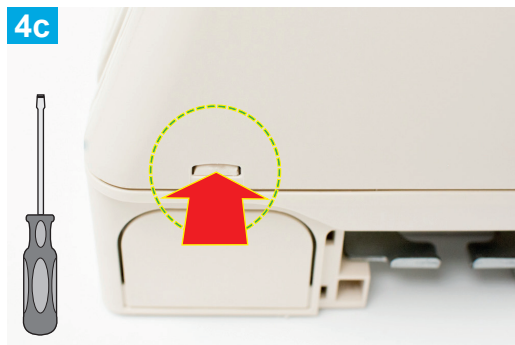
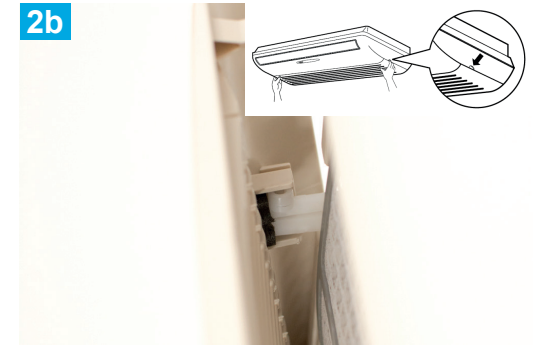
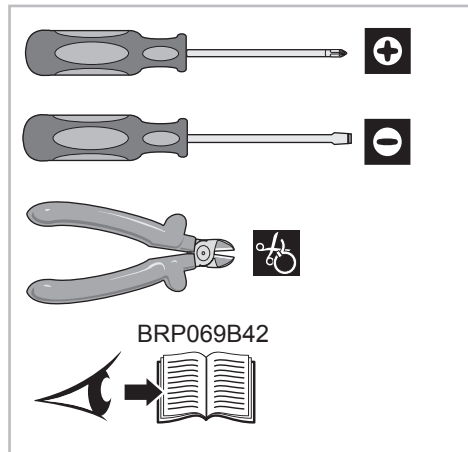
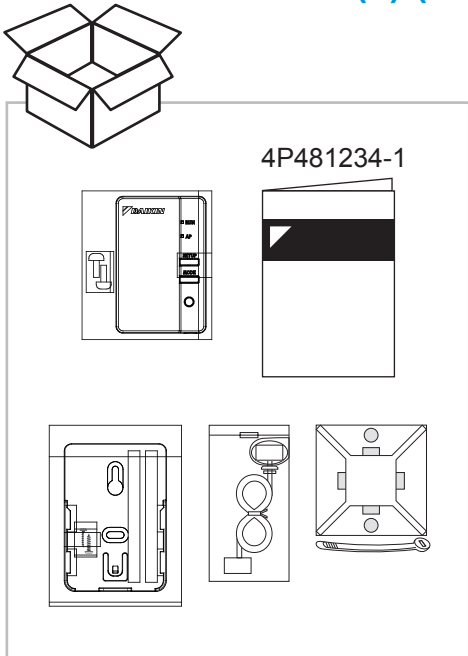



FLXS-B(9) (25/35/50)

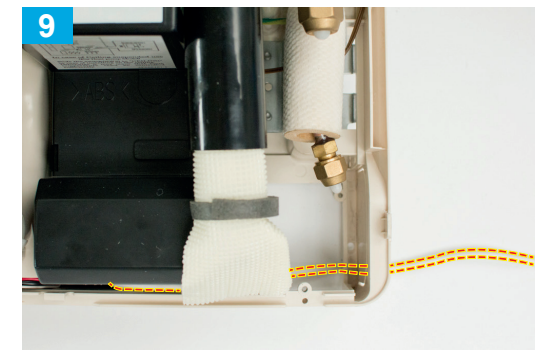
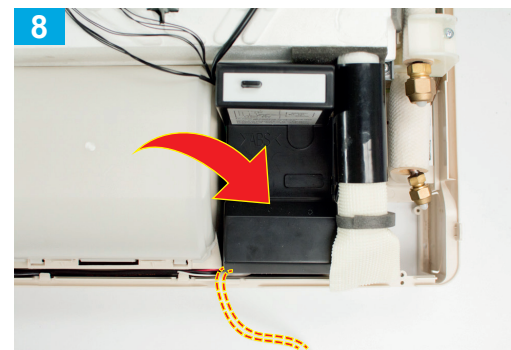
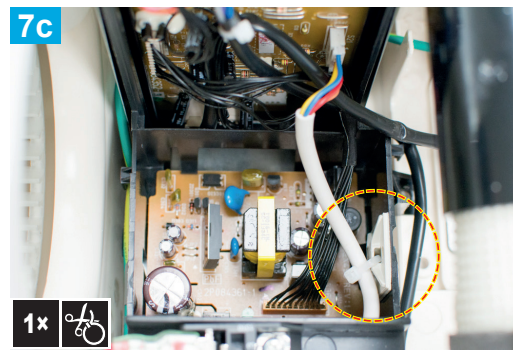
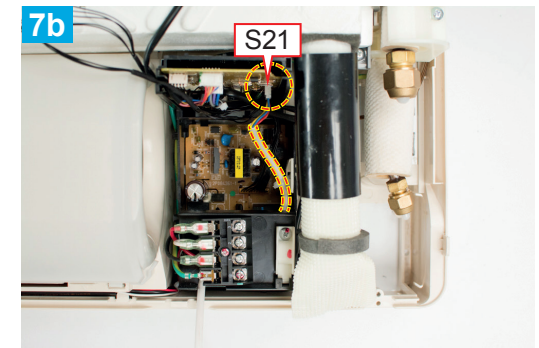
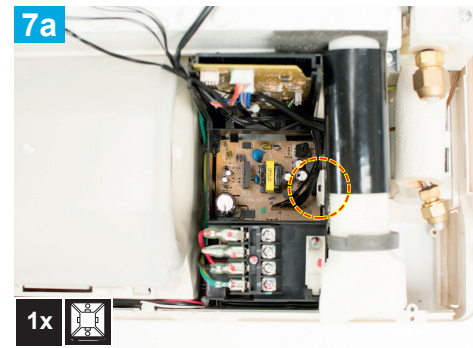

... 5 → 1 ...

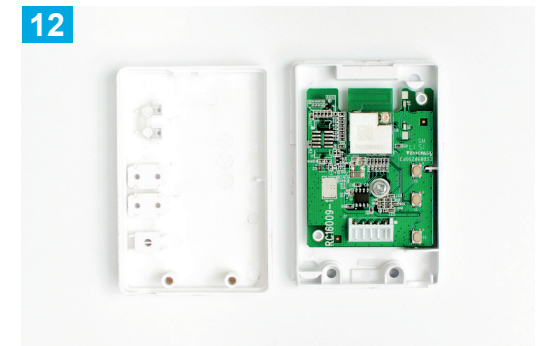
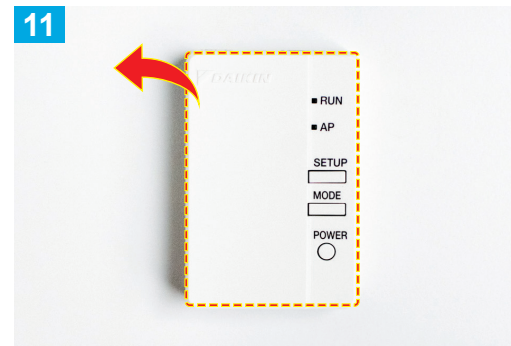



FLXS-B(9) (25/35/50)

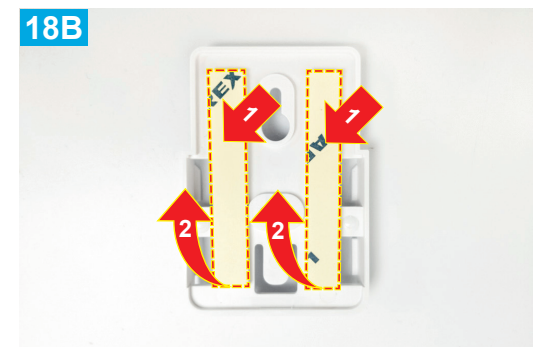
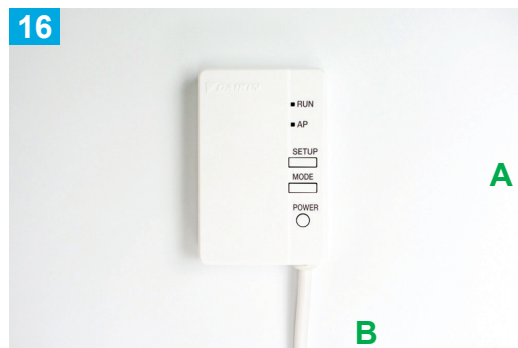
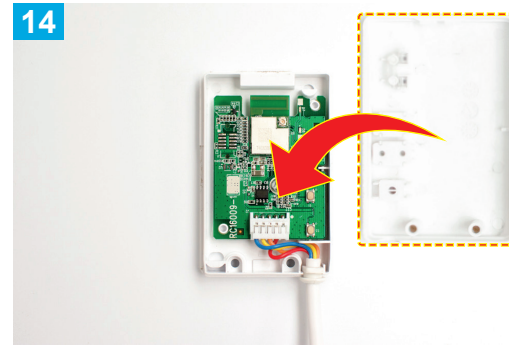
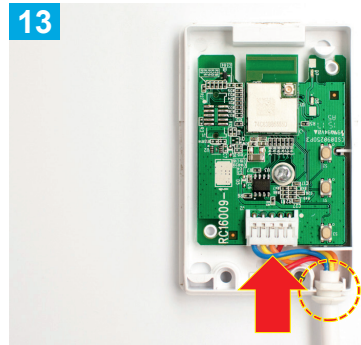



FLXS-B(9) (25/35/50)

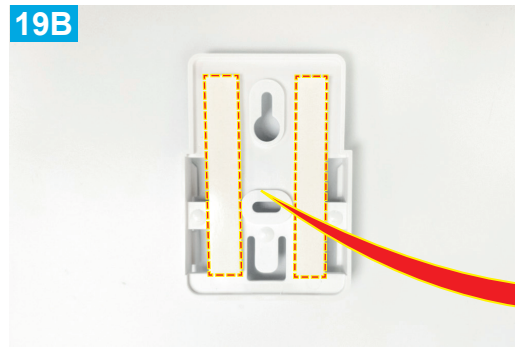



FTX-KN (25/35)

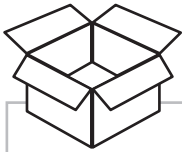

4P481234-1

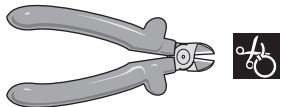
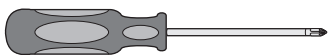
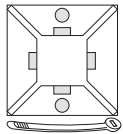
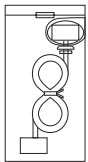
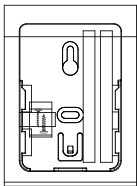
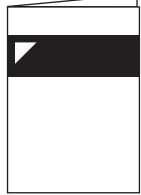
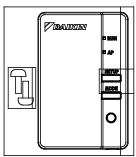

BRP069B42

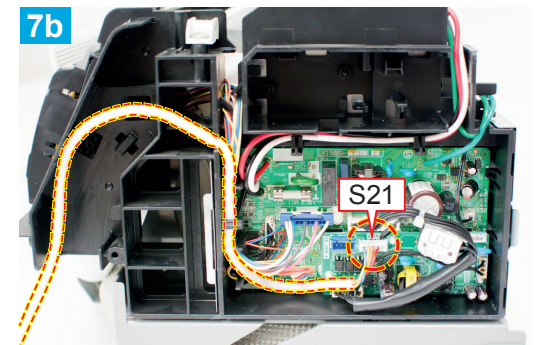
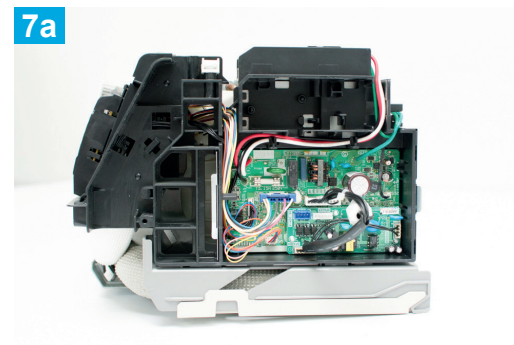
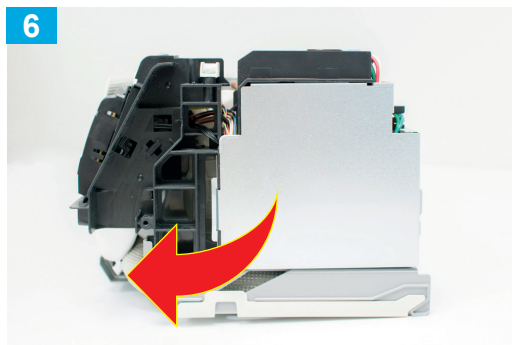
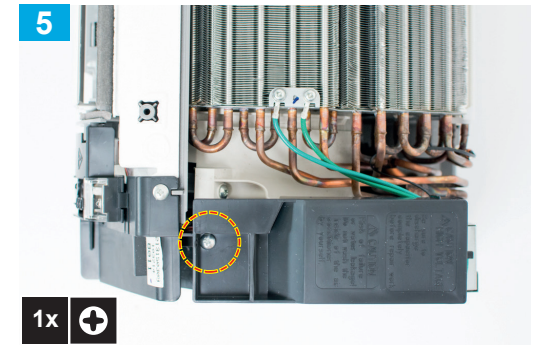
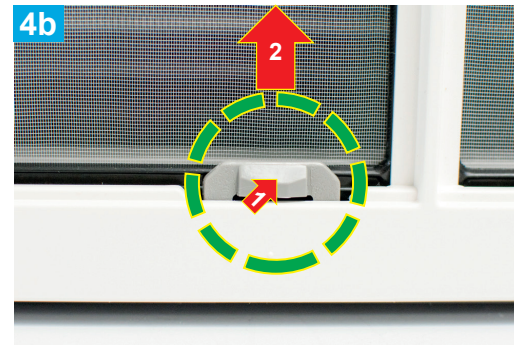
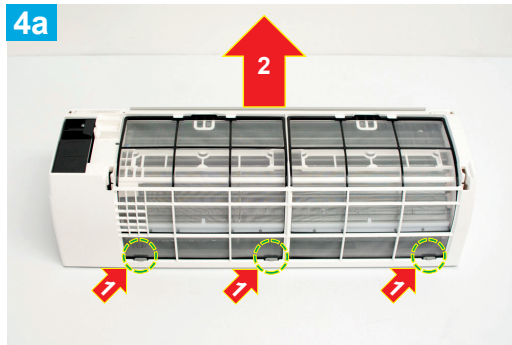
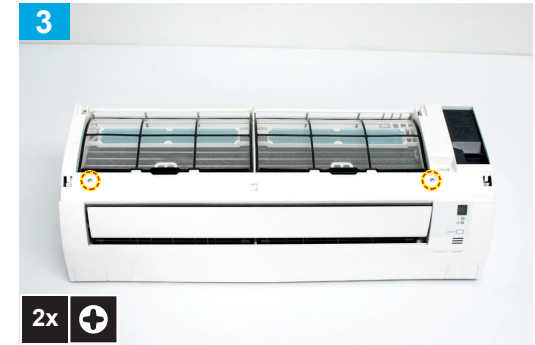
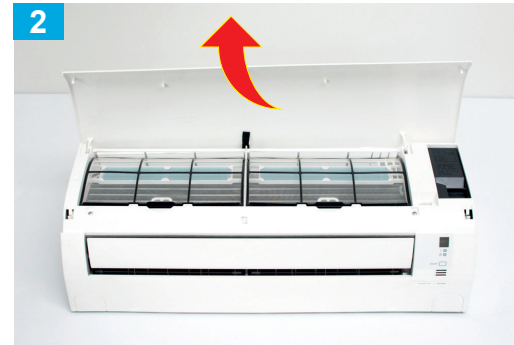



FTX-KN (25/35)

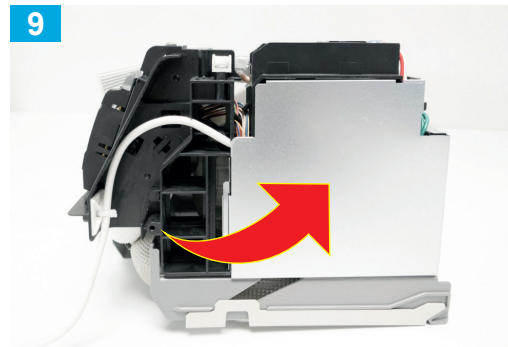
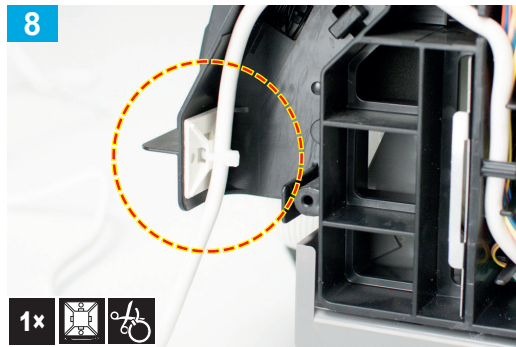

... 5 → 1 ...

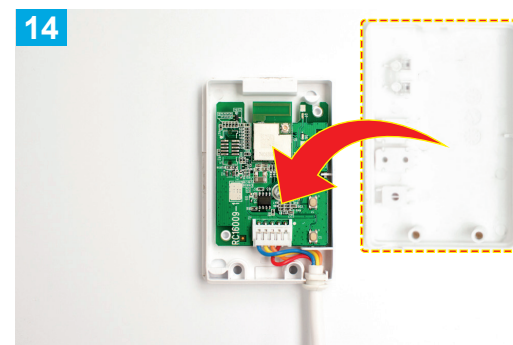
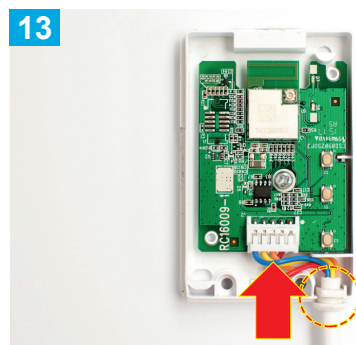
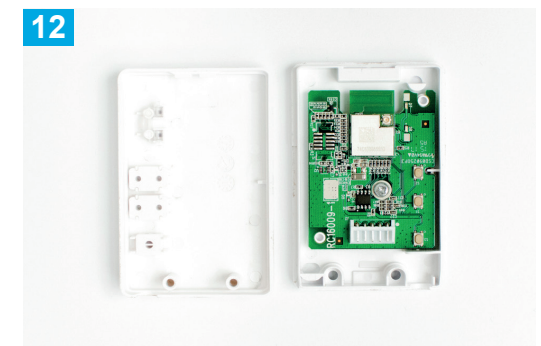
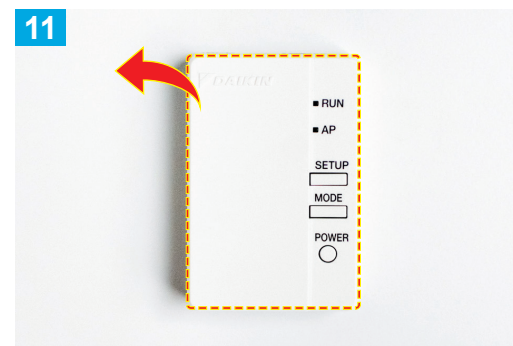
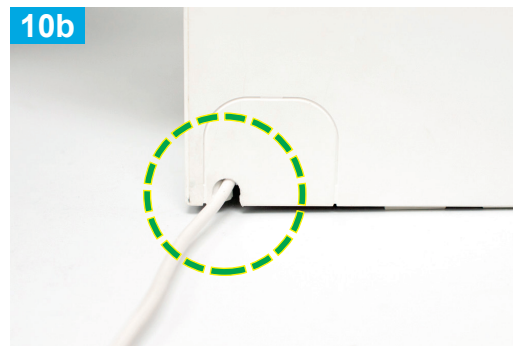



FTX-KN (25/35)

