



Air Conditioning Technical Data

Pair, Twin, Triple, double twin



EEDEN15-100B

RZQG-L9V1

TABLE OF CONTENTS

RZQG-L9V1

1	Features	2
2	Specifications	3
	Capacity and Power input	3
	Capacity and Power input	3
	Capacity and Power input	4
	Capacity and Power input	4
	Capacity and Power input	5
	Capacity and Power input	5
	Capacity and Power input	6
	Capacity and Power input	6
	Capacity and Power input	7
	Technical Specifications	7
	Electrical Specifications	8
3	Electrical data	10
4	Options	16
5	Combination table	17
6	Capacity tables	18
	Cooling Capacity Tables	18
	Cooling/Heating Capacity Tables	22
	Capacity Correction Factor	24
7	Dimensional drawings	25
8	Centre of gravity	26
9	Piping diagrams	28
	Piping Diagrams	28
	Piping Diagram Twin Application	29
	Piping Diagram Triple Application	30
	Piping Diagram Double Twin Application	31
10	Wiring diagrams	32
	Wiring Diagrams - Single Phase	32
11	Sound data	33
	Sound Power Spectrum	33
	Sound Pressure Spectrum - Cooling	35
	Sound Pressure Spectrum - Heating	37
	Sound Pressure Spectrum Quiet Mode	39
12	Installation	41
	Installation Method	41
13	Operation range	43

1 Features

Industry leading technology for commercial applications and even for technical rooms

- Top efficiency: - compressor that offers substantial efficiency improvements - control logic that optimises efficiency at the most frequently encountered operating conditions and that optimises the auxiliary modes (when the unit is not active) - heat exchangers that optimise the refrigerant flow at the most frequent operating conditions (temperature and load) - via improved nominal performances
- The perfect balance in efficiency and comfort thanks to Variable Refrigerant Temperature: top seasonal efficiency throughout most of the year and quick reaction speed on the hottest days.
- Suits high sensible, technical cooling applications (EDP)
- Extended operation range down to -20°C in heating
- Re-use of existing R-22 or R-407C technology
- With gas cooled PCB reliable cooling is guaranteed as it is not influenced by ambient temperature (1~)
- Maximum piping length up to 75m, minimum piping length is 5m.
- Outdoor units for pair, twin, triple, double twin application
- Daikin outdoor units are neat, sturdy and can easily be mounted on a roof or terrace or simply placed against an outside wall
- Compatibility with D-BACS
- Units optimized for seasonal efficiency give an indication on how efficient an air conditioner operates over an entire heating or cooling season.



Inverter



Auto cooling-
heating
changeover

2 Specifications

2-1 Capacity and Power input				FUQ71C/RZQG71L9V1	FUQ100C/RZQG71L9V1	FUQ100C/RZQG100L9V1	FUQ125C/RZQG125L9V1
Indoor unit				FUQ71C		FUQ100C	
Outdoor unit				RZQG71L9V1		RZQG100L9V1	
Cooling capacity	Nom.		kW	6.8	-	9.5	12.0
Heating capacity	Nom.		kW	7.5	-	10.8	13.5
Power input	Cooling	Nom.	kW	1.68	-	2.46	3.54
	Heating	Nom.	kW	1.84	-	2.73	3.95
Seasonal efficiency (according to EN14825)	Cooling	Energy label		A++			A+
		Pdesign	kW	6.80		9.50	12.00
		SEER		6.50		6.11	5.61
		Annual energy consumption	kWh	367		545	749
	Heating (Average climate)	Energy label		A+			
		Pdesign	kW	7.60		11.30	14.13
		SCOP		4.20		4.50	4.44
		Annual energy consumption	kWh	2,534		3,516	4,456
Ecolabel logo				no			
Nominal efficiency	EER			4.05	-	3.86	3.39
	COP			4.08	-	3.95	3.42
	Annual energy consumption		kWh	840	-	1,230	1,770
	Energy label	Cooling		A	-		A
Heating			A	-	A	B	

Notes

EER/COP according to Eurovent 2012, for use outside EU only

Nominal efficiency: cooling at 35°/27° nominal load, heating at 7°/20° nominal load

2-2 Capacity and Power input				FDQ125C/RZQG125L9V1			
Indoor unit				FDQ125C			
Outdoor unit				RZQG125L9V1			
Cooling capacity	Nom.		kW	12.0			
Heating capacity	Nom.		kW	13.5			
Power input	Cooling	Nom.	kW	3.20			
	Heating	Nom.	kW	3.53			
Seasonal efficiency (according to EN14825)	Cooling	Energy label		A+			
		Pdesign	kW	12.00			
		SEER		5.81			
		Annual energy consumption	kWh	723			
	Heating (Average climate)	Energy label		A+			
		Pdesign	kW	12.71			
		SCOP		4.21			
		Annual energy consumption	kWh	4,227			
Ecolabel logo				no			
Nominal efficiency	EER			3.75			
	COP			3.83			
	Annual energy consumption		kWh	1,600			
	Energy label	Cooling		A			
Heating			A				

Notes

EER/COP according to Eurovent 2012, for use outside EU only

Nominal efficiency: cooling at 35°/27° nominal load, heating at 7°/20° nominal load

2 Specifications

2-3 Capacity and Power input				FAQ71C/RZQG71L9V1	FAQ100C/RZQG71L9V1	FAQ100C/RZQG100L9V1	
Indoor unit				FAQ71C		FAQ100C	
Outdoor unit				RZQG71L9V1			RZQG100L9V1
Cooling capacity	Nom.	kW	6.8	-	9.5		
Heating capacity	Nom.	kW	7.5	-	10.8		
Power input	Cooling	Nom.	kW	2.00	-	2.63	
	Heating	Nom.	kW	2.03	-	3.00	
Seasonal efficiency (according to EN14825)	Cooling	Energy label		A++			
		Pdesign	kW	6.80	9.50		
		SEER		6.51	6.11		
		Annual energy consumption	kWh	366	545		
	Heating (Average climate)	Energy label		A+			
		Pdesign	kW	6.33	10.20		
		SCOP		4.02	4.01		
		Annual energy consumption	kWh	2,205	3,562		
Ecolabel logo				no			
Nominal efficiency	EER		3.40	-	3.62		
	COP		3.70	-	3.61		
	Annual energy consumption		kWh	1,000	-	1,315	
	Energy label	Cooling	A		-	A	
Heating		A		-	A		

Notes

EER/COP according to Eurovent 2012, for use outside EU only

Nominal efficiency: cooling at 35°/27° nominal load, heating at 7°/20° nominal load

2-4 Capacity and Power input				FBQ71D/RZQG71L9V1	FBQ100D/RZQG71L9V1	FBQ100D/RZQG100L9V1	FBQ140D/RZQG100L9V1	FBQ125D/RZQG125L9V1	FBQ140D/RZQG125L9V1	FBQ140D/RZQG140L9V1	
Indoor unit				FBQ71D	FBQ100D		FBQ140D	FBQ125D	FBQ140D		
Outdoor unit				RZQG71L9V1		RZQG100L9V1		RZQG125L9V1		RZQG140L9V1	
Cooling capacity	Nom.	kW	6.8 (1)	-	9.5 (1)	-	12.0 (1)	-	13.4 (1)		
Heating capacity	Nom.	kW	7.50 (1)	-	10.80 (1)	-	13.50 (1)	-	15.50 (1)		
Power input	Cooling	Nom.	kW	1.89 (1)	-	2.49 (1)	-	3.63 (1)	-	4.00 (1)	
	Heating	Nom.	kW	1.87 (1)	-	2.45 (1)	-	3.46 (1)	-	4.31 (1)	
Seasonal efficiency (according to EN14825)	Cooling	Energy label		A++		A+		A++		-	
		Pdesign	kW	6.80	9.50		12.00		-		
		SEER		6.16	5.87		6.11		-		
		Annual energy consumption	kWh	386	566		687		-		
	Heating (Average climate)	Energy label		A+		A++		A+		-	
		Pdesign	kW	6.00	11.30		12.70		-		
		SCOP		4.31	4.78		4.28		-		
		Annual energy consumption	kWh	1,949	3,310		4,154		-		
Ecolabel logo				no						-	
Nominal efficiency	EER		3.60 (2)	-	3.81 (2)	-	3.31 (2)	-	3.35 (2)		
	COP		4.01 (2)	-	4.41 (2)	-	3.90 (2)	-	3.60 (2)		
	Annual energy consumption		kWh	944	-	1,247	-	1,813	-	2,000	
	Energy label	Cooling	A		-	A	-	A	-		
Heating		A		-	A	-	A	-			

Notes

(1) Nominal efficiency: cooling at 35°/27° nominal load, heating at 7°/20° nominal load

(2) EER/COP according to Eurovent 2012, for use outside EU only

2 Specifications

2-5 Capacity and Power input			FCQHG71F/ RZQG71L9V1	FCQHG100F/ RZQG71L9V1	FCQHG100F/ RZQG100L9V 1	FCQHG140F/ RZQG100L9V 1	FCQHG125F/ RZQG125L9V 1	FCQHG140F/ RZQG125L9V 1	FCQHG140F/ RZQG140L9V 1		
Indoor unit			FCQHG71F	FCQHG100F		FCQHG140 F	FCQHG125 F	FCQHG140F			
Outdoor unit			RZQG71L9V1		RZQG100L9V1		RZQG125L9V1		RZQG140L 9V1		
Cooling capacity	Nom.	kW	6.8	-	9.5	-	12.0	-	13.4		
Heating capacity	Nom.	kW	7.5	-	10.8	-	13.5	-	15.5		
Power input	Cooling	Nom.	kW	1.66	-	2.15	-	3.00	4.00		
	Heating	Nom.	kW	1.56	-	2.16	-	3.07	3.77		
Seasonal efficiency (according to EN14825)	Cooling	Energy label		A++					-		
		Pdesign	kW	6.80		9.50		12.00		-	
		SEER		7.00					6.61		-
		Annual energy consumption	kWh	340		475		636		-	
	Heating (Average climate)	Energy label		A+		A++			-		
		Pdesign	kW	7.60		11.30		12.66		-	
		SCOP		4.54		4.80		4.63		-	
		Annual energy consumption	kWh	2,344		3,296		3,829		-	
Ecolabel logo			no					-			
Nominal efficiency	EER		4.09	-	4.42	-	4.00	-	3.35		
	COP		4.80	-	4.99	-	4.40	-	4.12		
	Annual energy consumption		kWh	830	-	1,075	-	1,500	2,000		
	Energy label	Cooling		A	-	A	-	A	-		
		Heating		A	-	A	-	A	-		

Notes

EER/COP according to Eurovent 2012, for use outside EU only

Nominal efficiency: cooling at 35°/27° nominal load, heating at 7°/20° nominal load

2-6 Capacity and Power input			FCQG71F/ RZQG71L9V1	FCQG100F/ RZQG71L9V1	FCQG100F/ RZQG100L9V 1	FCQG140F/ RZQG100L9V 1	FCQG125F/ RZQG125L9V 1	FCQG140F/ RZQG125L9V 1	FCQG140F/ RZQG140L9V 1		
Indoor unit			FCQG71F	FCQG100F		FCQG140F	FCQG125F	FCQG140F			
Outdoor unit			RZQG71L9V1		RZQG100L9V1		RZQG125L9V1		RZQG140L 9V1		
Cooling capacity	Nom.	kW	6.8	-	9.5	-	12.0	-	13.4		
Heating capacity	Nom.	kW	7.5	-	10.8	-	13.5	-	15.5		
Power input	Cooling	Nom.	kW	2.01	-	2.45	-	3.22	-		
	Heating	Nom.	kW	1.89	-	2.60	-	3.72	-		
Seasonal efficiency (according to EN14825)	Cooling	Energy label		A++			A+		-		
		Pdesign	kW	6.80		9.50		12.00		-	
		SEER		6.80					6.00		-
		Annual energy consumption	kWh	350		489		700		-	
	Heating (Average climate)	Energy label		A+		A++		A+		-	
		Pdesign	kW	6.33		11.30		12.66		-	
		SCOP		4.20		4.61		4.10		-	
		Annual energy consumption	kWh	2,110		3,432		4,323		-	
Ecolabel logo			no					-			
Nominal efficiency	EER		3.39	-	3.87	-	3.73	-	3.21		
	COP		3.97	-	4.15	-	3.63	-	3.61		
	Annual energy consumption		kWh	1,005	-	1,225	-	1,610	2,085		
	Energy label	Cooling		A	-	A	-	A	-		
		Heating		A	-	A	-	A	-		

2 Specifications

Notes

EER/COP according to Eurovent 2012, for use outside EU only

Nominal efficiency: cooling at 35°/27° nominal load, heating at 7°/20° nominal load

2

2-7 Capacity and Power input				FVQ71C/ RZQG71L9V1	FVQ100C/ RZQG71L9V1	FVQ100C/ RZQG100L9V 1	FVQ140C/ RZQG100L9V 1	FVQ125C/ RZQG125L9V 1	FVQ140C/ RZQG125L9V 1	FVQ140C/ RZQG140L9V 1
Indoor unit				FVQ71C	FVQ100C		FVQ140C	FVQ125C	FVQ140C	
Outdoor unit				RZQG71L9V1		RZQG100L9V1		RZQG125L9V1		RZQG140L9V1
Cooling capacity	Nom.	kW	6.8	-	9.5	-	12.0	-	13.4	
Heating capacity	Nom.	kW	7.5	-	10.8	-	13.5	-	15.5	
Power input	Cooling	Nom.	kW	2.02	-	2.49	-	3.74	-	4.17
	Heating	Nom.	kW	2.06	-	2.61	-	3.65	-	4.30
Seasonal efficiency (according to EN14825)	Cooling	Energy label		A++		A+				-
		Pdesign	kW	6.80		9.50		12.00		-
		SEER		6.31		5.61				-
		Annual energy consumption	kWh	378		593		749		-
	Heating (Average climate)	Energy label		A+		A				-
		Pdesign	kW	6.33		11.30				-
		SCOP		4.05		4.20		3.87		-
		Annual energy consumption	kWh	2,189		3,767		4,088		-
Ecolabel logo				no						-
Nominal efficiency	EER		3.37	-	3.81	-	3.21	-	3.21	
	COP		3.64	-	4.14	-	3.70	-	3.61	
	Annual energy consumption		kWh	1,010	-	1,245	-	1,870	-	2,085
	Energy label	Cooling	A	-	A	-	A	-		
Heating		A	-	A	-	A	-			

Notes

EER/COP according to Eurovent 2012, for use outside EU only

Nominal efficiency: cooling at 35°/27° nominal load, heating at 7°/20° nominal load

2-8 Capacity and Power input				FHQ71C/ RZQG71L9 V1	FHQ100C/ RZQG71L9 V1	FHQ100C/ RZQG100L 9V1	FHQ140C/ RZQG100L 9V1	FHQ125C/ RZQG125L 9V1	FHQ140C/ RZQG125L 9V1	FHQ71C/ RZQG125L 9V1	FHQ140C/ RZQG140L 9V1
Indoor unit				FHQ71C	FHQ100C		FHQ140C	FHQ125C	FCQG140 F	FHQ71C	FHQ140C
Outdoor unit				RZQG71L9V1		RZQG100L9V1		RZQG125L9V1		RZQG140L9V1	
Cooling capacity	Nom.	kW	6.8	-	9.5	-	12.0	-	13.4		
Heating capacity	Nom.	kW	7.5	-	10.8	-	13.5	-	15.5		
Power input	Cooling	Nom.	kW	1.78	-	2.49	-	3.58	-	4.05	
	Heating	Nom.	kW	1.82	-	2.60	-	3.48	-	4.27	
Seasonal efficiency (according to EN14825)	Cooling	Energy label		A++		A+		B			
		Pdesign	kW	6.80		9.50		12.00		-	
		SEER		6.95		6.11		6.01		5.10	-
		Annual energy consumption	kWh	343		545		699		824	-
	Heating (Average climate)	Energy label		A+		A++		A+		A	-
		Pdesign	kW	7.60		11.30		14.13		12.71	-
		SCOP		4.32		4.61		4.23		3.80	-
		Annual energy consumption	kWh	2,463		3,432		4,677		4,683	-
Ecolabel logo				no						-	

2 Specifications

2-8 Capacity and Power input			FHQ71C/ RZQG71L9 V1	FHQ100C/ RZQG71L9 V1	FHQ100C/ RZQG100L 9V1	FHQ140C/ RZQG100L 9V1	FHQ125C/ RZQG125L 9V1	FHQ140C/ RZQG125L 9V1	FHQ71C/ RZQG125L 9V1	FHQ140C/ RZQG140L 9V1
Nominal efficiency	EER		3.82	-	3.81	-	3.35	-	-	3.31
	COP		4.13	-	4.15	-	3.89	-	-	3.63
	Annual energy consumption	kWh	890	-	1,245	-	1,790	-	-	2,025
	Energy label	Cooling		A	-	A	-	A	-	-
Heating			A	-	A	-	A	-	-	-

Notes

EER/COP according to Eurovent 2012, for use outside EU only

Nominal efficiency: cooling at 35°/27° nominal load, heating at 7°/20° nominal load

2-9 Capacity and Power input			FNQ35A/ RZQG71L9V1	FNQ35A/ RZQG100L9V1	FNQ50A/ RZQG100L9V1	FNQ60A/ RZQG125L9V1	FNQ50A/ RZQG125L9V1	FNQ35A/ RZQG125L9V1		
Indoor unit			FNQ35A		FNQ50A	FNQ60A	FNQ50A	FNQ35A		
Outdoor unit			RZQG71L9V1	RZQG100L9V1		RZQG125L9V1				
Seasonal efficiency (according to EN14825)	Cooling	Energy label	B		A					
		Pdesign	kW	6.80	9.50		12.00			
		SEER		4.80	5.10					
		Annual energy consumption	kWh	496	652		824			
	Heating (Average climate)	Energy label	A							
		Pdesign	kW	6.00	10.74	11.30	12.71		11.30	
		SCOP		3.80						
		Annual energy consumption	kWh	2,211	3,957	4,164	4,683		4,164	
Ecolabel logo			no							
Nominal efficiency	EER		-							
	COP		-							
	Annual energy consumption	kWh	-							
	Energy label	Cooling	-							
Heating		-								

2-10 Technical Specifications				RZQG71L9V1	RZQG100L9V1	RZQG125L9V1	RZQG140L9V1	
Capacity control	Method			Inverter controlled				
Casing	Colour			Ivory white				
	Material			Painted galvanized steel plate				
Dimensions	Unit	Height	mm	990	1,430			
		Width	mm	940				
		Depth	mm	320				
	Packed unit	Height	mm	1,170	1,610			
		Width	mm	1,015				
		Depth	mm	422				
Weight	Unit		kg	69	95			
	Packed unit		kg	78	104			
Heat exchanger	Fin	Type		WF fin				
		Treatment		Anti-corrosion treatment (PE)				
Compressor	Quantity			1				
	Type			Hermetically sealed swing compressor				
	Starting method			Inverter driven				
Fan	Type			Propeller fan				
	Discharge direction			Horizontal				
	Quantity			1	2			
	Air flow rate	Cooling	Nom.	m³/min	59	70		84
			Super low	m³/min cfm	-			
		Heating	Nom.	m³/min	49	62		
Super low			m³/min cfm	-				

2 Specifications

2

2-10 Technical Specifications					RZQG71L9V1	RZQG100L9V1	RZQG125L9V1	RZQG140L9V1
Fan motor	Quantity				1	2		
	Model		Brushless DC motor					
	Output		W		94			
	Drive		Direct drive					
	Speed	Cooling	Super low	rpm	-			
Heating		Super low	rpm	-				
Sound power level	Cooling		dBA	64	66	67	69	
	Heating		dBA	-				
Sound pressure level	Cooling	Nom.	dBA	48	50	51	52	
	Heating	Nom.	dBA	50	52	53		
	Night quiet mode	Level 1	dBA	43	45			
Operation range	Cooling	Ambient	Min.	°CDB	-15			
			Max.	°CDB	50			
	Heating	Ambient	Min.	°CWB	-20			
			Max.	°CWB	15.5			
Refrigerant	Type		R-410A					
	Charge		kg	2.9	4.0			
			TCO _{2eq}	6.1	8.4			
	Control		Expansion valve (electronic type)					
	GWP		2,087.5					
	Circuits	Quantity		1				
Refrigerant oil	Type		FVC50K					
	Charged volume		l	0.9	1.35			
Piping connections	Liquid	Quantity		1				
		Type		Flare connection				
		OD	mm	9.52				
	Gas	Quantity		1				
		Type		Flare connection				
		OD	mm	15.9				
	Drain	Quantity		5				
		Type		Hole				
		ID	mm	-				
		OD	mm	26				
	Piping length	OU - IU	Min.	m	5 (1)			
			Max.	m	50	75		
		System	Equivalent	m	70	90		
			Chargeless	m	30			
	Additional refrigerant charge		kg/m	See installation manual				
Level difference	IU - OU	Max.	m	30.0				
	IU - IU	Max.	m	0.5				
Heat insulation		Both liquid and gas pipes						
Defrost method		Reversed cycle						
Defrost control		Sensor for outdoor heat exchanger temperature						
Safety devices	Item	01	High pressure switch					
		02	Low pressure switch					
		03	Fan driver overload protector					
		04	Fuse					

2-11 Electrical Specifications					RZQG71L9V1	RZQG100L9V1	RZQG125L9V1	RZQG140L9V1
Power supply	Name		V1					
	Phase		1~					
	Frequency		Hz	50				
	Voltage		V	220-240				
	Voltage range	Min.	%	-10				
		Max.	%	10				

2 Specifications

2-11 Electrical Specifications			RZQG71L9V1	RZQG100L9V1	RZQG125L9V1	RZQG140L9V1
Current - 50Hz	Maximum fuse amps (MFA)	A	-			
Current	Zmax	List	Complies to EN61000-3-11			
	Recommended fuses	A	25	40		
Current - 60Hz	Maximum fuse amps (MFA)	A	-			
Wiring connections	For power supply	Remark	See installation manual outdoor unit			
	For connection with indoor	Remark	See installation manual outdoor unit			
Power supply intake			Outdoor unit only			

Notes

(1) 3 with re-charging

PED: assembly = category I : excluded from scope of PED due to article 1, item 3.6 of 97/23/EC

Minimum Ssc (=Short-circuit power) value: Equipment complying with EN/IEC 61000-3-12: European/International Technical Standard setting the limits for harmonic currents produced by equipment connected to public low-voltage systems with input current $>16A$ and $\leq 75A$ per phase

See separate drawing for electrical data

Contains fluorinated greenhouse gases

3 Electrical data

3 - 1 Electrical Data

3

RZQG71-100L9V1

Indoor	Outdoor	Hz	Voltage	MCA	TOCA	MFA	Comp		OFM		IFM				
							MSC	RLA	kW	FLA	kW	FLA			
FCQHG71FVEB	RZQG71L9V1	50Hz 220-240V	Min. 198V Max. 264V	18.2	—	20	—	15.6	0.094	0.4	0.091	0.5			
FCQG35FVEB				x2	18.4	—	20	—	15.6	0.094	0.4	0.044x2	0.3x2		
FCQG71FVEB					18.1	—	20	—	15.6	0.094	0.4	0.054	0.4		
FFQ35C2VEB				x2	18.6	—	20	—	15.6	0.094	0.4	0.050x2	0.4x2		
FDXS35F2VEB				x2	18.4	—	20	—	15.6	0.094	0.4	0.034x2	0.3x2		
FBQ35C8VEB				x2	20.6	—	25	—	15.6	0.094	0.4	0.140x2	1.2x2		
FBQ71C8VEB					19.0	—	20	—	15.6	0.094	0.4	0.350	1.1		
FAQ71CVEB					18.1	—	20	—	15.6	0.094	0.4	0.048	0.4		
FVQ71CVEB					18.4	—	20	—	15.6	0.094	0.4	0.117	0.6		
FHQ35CAVEB				x2	19.1	—	20	—	15.6	0.094	0.4	0.060 x 2	0.6 x 2		
FHQ71CAVEB					18.6	—	20	—	15.6	0.094	0.4	0.091	0.8		
FUQ71CVEB					18.7	—	20	—	15.6	0.094	0.4	0.046	0.9		
FCQHG100FVEB				RZQG100L9V1	50Hz 220-240V	Min. 198V Max. 264V	29.1	—	32	—	24.2	0.094+0.094	0.4+0.4	0.221	1.3
FCQG35FVEB							x3	28.6	—	32	—	24.2	0.094+0.094	0.4+0.4	0.044x3
FCQG50FVEB	x2	28.3	—				32	—	24.2	0.094+0.094	0.4+0.4	0.039x2	0.3x2		
FCQG100FVEB		28.4	—				32	—	24.2	0.094+0.094	0.4+0.4	0.117	0.7		
FFQ35C2VEB	x3	29.0	—				32	—	24.2	0.094+0.094	0.4+0.4	0.050x3	0.4x3		
FFQ50C2VEB	x2	28.5	—				32	—	24.2	0.094+0.094	0.4+0.4	0.050x2	0.4x2		
FDXS35F2VEB	x3	28.6	—				32	—	24.2	0.094+0.094	0.4+0.4	0.034x3	0.3x3		
FDXS50F2VEB9	x2	28.8	—				32	—	24.2	0.094+0.094	0.4+0.4	0.06x2	0.5x2		
FBQ35C8VEB	x3	32.0	—				40	—	24.2	0.094+0.094	0.4+0.4	0.140x3	1.2x3		
FBQ50C8VEB	x2	30.5	—				32	—	24.2	0.094+0.094	0.4+0.4	0.140x2	1.2x2		
FBQ100C8VEB		29.5	—				32	—	24.2	0.094+0.094	0.4+0.4	0.350	1.6		
FAQ100CVEB		28.0	—				32	—	24.2	0.094+0.094	0.4+0.4	0.064	0.4		
FVQ100CVEB		29.0	—				32	—	24.2	0.094+0.094	0.4+0.4	0.238	1.2		
FHQ35CAVEB	x3	29.8	—				32	—	24.2	0.094+0.094	0.4+0.4	0.060 x 3	0.6 x 3		
FHQ50CAVEB	x2	29.0	—				32	—	24.2	0.094+0.094	0.4+0.4	0.060 x 2	0.6 x 2		
FHQ100CAVEB		29.1	—				32	—	24.2	0.094+0.094	0.4+0.4	0.150	1.3		
FUQ100CVEB		29.1	—	32	—	24.2	0.094+0.094	0.4+0.4	0.106	1.3					

SYMBOLS

MCA	: Min. Circuit Amps. (A)
TOCA	: Total Over-Current Amps. (A)
MFA	: Max. Fuse Amps. (See note 7) (A)
MSC	: Max. current during the starting compressor. (A)
RLA	: Rated Load Amps. (A)
OFM	: Outdoor Fan Motor. (A)
IFM	: Indoor Fan Motor.
FLA	: Full Load Amps.
kW	: Fan Motor Rated Output. (kW)

NOTES

- RLA is based on the following conditions:
Power supply: 50Hz 230V
Cooling
Indoor temperature 27.0°CDB/19.0°CWB
Outdoor temperature 35.0°CDB
Heating
Indoor temperature 20.0°CDB
Outdoor temperature 7.0°CDB / 6.0°CWB
- TOCA means the total value of each OC set.
- Voltage range
Units are suitable for use on electrical systems where voltage supplied to unit terminals is not below or above listed range limits.
- Maximum allowable voltage variation between phases is 2%.
- MCA represents maximum input current, MFA represents capacity which may accept MCA. (next lower standard fuse rating, min.15A)
- Select wire size based on the larger value of MCA or TOCA.
- MFA is used to select the circuit breaker and the ground fault circuit interrupter. (earth leakage circuit breaker)

3D090680

3 Electrical data

3 - 1 Electrical Data

RZQG125-140L9V1				Comp		OFM		IFM						
Indoor	Outdoor	Hz~	Voltage	MCA	TOCA	MFA	MSC	RLA	kW	FLA	kW	FLA		
FCQHG125FVEB		50Hz 220-240V	Min. 198V Max. 264V	29.3	—	32	—	24.2	0.094+0.094	0.4+0.4	0.244	1.4		
FCQG35FVEB	x4			29.0	—	32	—	24.2	0.094+0.094	0.4+0.4	0.044x4	0.3x4		
FCQG50FVEB	x3			28.6	—	32	—	24.2	0.094+0.094	0.4+0.4	0.039x3	0.3x3		
FCQG60FVEB	x2			28.3	—	32	—	24.2	0.094+0.094	0.4+0.4	0.044x2	0.3x2		
FCQG125FVEB						28.8	—	32	—	24.2	0.094+0.094	0.4+0.4	0.168	1.0
FFQ35C2VEB	x4					29.5	—	32	—	24.2	0.094+0.094	0.4+0.4	0.050x4	0.4x4
FFQ50B9V1B	x3					29.0	—	32	—	24.2	0.094+0.094	0.4+0.4	0.050x3	0.4x3
FFQ60B9V1B	x2					29.0	—	32	—	24.2	0.094+0.094	0.4+0.4	0.050x2	0.6x2
FDXS35F2VEB	x4					29.0	—	32	—	24.2	0.094+0.094	0.4+0.4	0.034x4	0.3x4
FDXS50F2VEB9	x3					29.4	—	32	—	24.2	0.094+0.094	0.4+0.4	0.06x3	0.5x3
FDXS60F2VEB	x2					28.8	—	32	—	24.2	0.094+0.094	0.4+0.4	0.060x2	0.5x2
FBQ35C8VEB	x4					33.5	—	40	—	24.2	0.094+0.094	0.4+0.4	0.140x4	1.2x4
FBQ50C8VEB	x3					32.0	—	40	—	24.2	0.094+0.094	0.4+0.4	0.140x3	1.2x3
FBQ60C8VEB	x2					30.3	—	32	—	24.2	0.094+0.094	0.4+0.4	0.350x2	1.1x2
FBQ125C8VEB						30.1	—	32	—	24.2	0.094+0.094	0.4+0.4	0.350	2.1
FHQ35BWW1B	x4					30.5	—	32	—	24.2	0.094+0.094	0.4+0.4	0.062x4	0.6x4
FHQ50BWW1B	x3					29.8	—	32	—	24.2	0.094+0.094	0.4+0.4	0.062x3	0.6x3
FHQ60BWW1B	x2					29.0	—	32	—	24.2	0.094+0.094	0.4+0.4	0.062x2	0.6x2
FHQG125CVEB						29.5	—	32	—	24.2	0.094+0.094	0.4+0.4	0.150	1.6
FUQ125BWW1B						28.8	—	32	—	24.2	0.094+0.094	0.4+0.4	0.289	1.0
FDQ125C7VEB						30.1	—	32	—	24.2	0.094+0.094	0.4+0.4	0.350	2.1
FVQ125CVEB						29.0	—	32	—	24.2	0.094+0.094	0.4+0.4	0.238	1.2
FHQ35CAVEB	x4					30.5	—	32	—	24.2	0.094+0.094	0.4+0.4	0.060 x 4	0.6 x 4
FHQ50CAVEB	x3					29.8	—	32	—	24.2	0.094+0.094	0.4+0.4	0.060 x 3	0.6 x 3
FHQ60CAVEB	x2					29.0	—	32	—	24.2	0.094+0.094	0.4+0.4	0.091 x 2	0.6 x 2
FHQ125CAVEB						29.4	—	32	—	24.2	0.094+0.094	0.4+0.4	0.150	1.5
FUQ125CVEB						29.3	—	32	—	24.2	0.094+0.094	0.4+0.4	0.106	1.4
FCQHG71FVEB	x2			50Hz 220-240V	Min. 198V Max. 264V	28.8	—	32	—	24.2	0.094+0.094	0.4+0.4	0.091x2	0.5x2
FCQHG140FVEB						29.3	—	32	—	24.2	0.094+0.094	0.4+0.4	0.244	1.4
FCQG35FVEB	x4					29.0	—	32	—	24.2	0.094+0.094	0.4+0.4	0.044x4	0.3x4
FCQG50FVEB	x3					28.6	—	32	—	24.2	0.094+0.094	0.4+0.4	0.039x3	0.3x3
FCQG71FVEB	x2					28.5	—	32	—	24.2	0.094+0.094	0.4+0.4	0.054x2	0.4x2
FCQG140FVEB						28.8	—	32	—	24.2	0.094+0.094	0.4+0.4	0.168	1.0
FFQ35C2VEB	x4					29.5	—	32	—	24.2	0.094+0.094	0.4+0.4	0.050x4	0.4x4
FFQ50C2VEB	x3	29.0	—			32	—	24.2	0.094+0.094	0.4+0.4	0.050x3	0.4x3		
FDXS35F2VEB	x4	29.0	—			32	—	24.2	0.094+0.094	0.4+0.4	0.034x4	0.3x4		
FDXS50F2VEB9	x3	29.4	—			33	—	25.2	0.094+0.094	0.4+0.4	0.06x3	0.5x3		
FBQ35C8VEB	x4	33.5	—			40	—	24.2	0.094+0.094	0.4+0.4	0.140x4	1.2x4		
FBQ50C8VEB	x3	32.0	—			40	—	24.2	0.094+0.094	0.4+0.4	0.140x3	1.2x3		
FBQ71C8VEB	x2	30.3	—			32	—	24.2	0.094+0.094	0.4+0.4	0.350x2	1.1x2		
FBQ140C8VEB		30.1	—			32	—	24.2	0.094+0.094	0.4+0.4	0.350	2.1		
FAQ71CVEB	x2	28.5	—			32	—	24.2	0.094+0.094	0.4+0.4	0.048x2	0.4x2		
FVQ140CVEB		29.3	—			32	—	24.2	0.094+0.094	0.4+0.4	0.276	1.4		
FHQ35CAVEB	x4	30.5	—			32	—	24.2	0.094+0.094	0.4+0.4	0.060 x 4	0.6 x 4		
FHQ50CAVEB	x3	29.8	—			32	—	24.2	0.094+0.094	0.4+0.4	0.060 x 3	0.6 x 3		
FHQ71CAVEB	x2	29.5	—			32	—	24.2	0.094+0.094	0.4+0.4	0.091 x 2	0.8 x 2		
FHQ140CAVEB		29.8	—			32	—	24.2	0.094+0.094	0.4+0.4	0.150	1.8		
FUQ71CVEB	x2	29.8	—			32	—	24.2	0.094+0.094	0.4+0.4	0.046 x 2	0.9 x 2		

SYMBOLS

- MCA : Min. Circuit Amps. (A)
- TOCA : Total Over-Current Amps. (A)
- MFA : Max. Fuse Amps. (See note 7) (A)
- MSC : Max. current during the starting compressor. (A)
- RLA : Rated Load Amps. (A)
- OFM : Outdoor Fan Motor. (A)
- IFM : Indoor Fan Motor.
- FLA : Full Load Amps.
- kW : Fan Motor Rated Output. (kW)

NOTES

- 1 RLA is based on the following conditions:
Power supply: 50Hz 230V
Cooling
Indoor temperature 27.0°CDB/19.0°CWB
Outdoor temperature 35.0°CDB
Heating
Indoor temperature 20.0°CDB
Outdoor temperature 7.0°CDB / 6.0°CWB
- 2 TOCA means the total value of each OC set.
- 3 Voltage range
Units are suitable for use on electrical systems where voltage supplied to unit terminals is not below or above listed range limits.
- 4 Maximum allowable voltage variation between phases is 2%.
- 5 MCA represents maximum input current. MFA represents capacity which may accept MCA. (next lower standard fuse rating, min.15A)
- 6 Select wire size based on the larger value of MCA or TOCA.
- 7 MFA is used to select the circuit breaker and the ground fault circuit interrupter. (earth leakage circuit breaker)

3D090680

3 Electrical data

3 - 1 Electrical Data

3

RZQG71-125L9V1

Unit combination restrictions		Power supply			COMP		OFM		IFM					
Indoor	Outdoor	①	②	③	MCA	MFA	RHz	RLA	kW	FLA	kW	FLA		
FBQ71D2VEB	RZQG71L9V1B	50	220-240V	MAX. 50Hz 264V MIN. 50Hz 198V	16,4	20	51	15,6	0,094	0,4	0,07	0,5		
2xFBQ35D2VEB	RZQG71L9V1B				17,1	20	-	15,6	0,094	0,4	2x0.089	2x0.6		
FBQ100D2VEB	RZQG100L9V1B				28,9	32	49	24,2	0,094 + 0,094	0,4 + 0,4	0,127	1,0		
2xFBQ50D2VEB	RZQG100L9V1B				29,1	32	-	24,2	0,094 + 0,094	0,4 + 0,4	2x0.089	2x0.6		
3xFBQ35D2VEB	RZQG100L9V1B				29,7	32	-	24,2	0,094 + 0,094	0,4 + 0,4	3x0.089	3x0.6		
FBQ125D2VEB	RZQG125L9V1B				29,5	32	64	24,2	0,094 + 0,094	0,4 + 0,4	0,187	1,5		
2xFBQ60D2VEB	RZQG125L9V1B				29	32	-	24,2	0,094 + 0,094	0,4 + 0,4	2x0.070	2x0.5		
3xFBQ50D2VEB	RZQG125L9V1B				29,8	32	-	24,2	0,094 + 0,094	0,4 + 0,4	3x0.089	3x0.6		

Notes

- The RLA is based on the following conditions.
Indoor temperature 27°C DB / 19°C WB
Outdoor temperature 35°C DB
- Select the wire size according to the MCA.
- The maximum allowable voltage that is unbalanced between phases is 2%.
- Use a circuit breaker instead of a fuse.

Symbols

- ① Hz
- ② Voltage
- ③ Voltage range
- MCA Minimum Circuit Ampere (A)
- MFA Maximum Fuse Ampere (A)
- RLA Rated load amps [A]
- OFM Outdoor fan motor
- IFM Indoor fan motor
- FLA Full Load Ampere (A)
- kW Fan motor rated output [kW]
- RHz Rated operating frequency [Hz]
- COMP Compressor

3D094863B

RZQG125-140L9V1

Unit combination restrictions		Power supply			COMP		OFM		IFM					
Indoor	Outdoor	①	②	③	MCA	MFA	RHz	RLA	kW	FLA	kW	FLA		
4xFBQ35D2VEB	RZQG125L9V1B	50	220-240V	MAX. 50Hz 264V MIN. 50Hz 198V	30,4	32	-	24,2	0,094 + 0,094	0,4 + 0,4	4x0.089	4x0.6		
FBQ140D2VEB	RZQG140L9V1B				29,5	32	68	24,2	0,094 + 0,094	0,4 + 0,4	0,187	1,5		
2xFBQ71D2VEB	RZQG140L9V1B				29	32	-	24,2	0,094 + 0,094	0,4 + 0,4	2x0.07	2x0.5		
3xFBQ50D2VEB	RZQG140L9V1B				29,8	32	-	24,2	0,094 + 0,094	0,4 + 0,4	3x0.089	3x0.6		
4xFBQ35D2VEB	RZQG140L9V1B				30,4	32	-	24,2	0,094 + 0,094	0,4 + 0,4	4x0.089	4x0.6		

Notes

- The RLA is based on the following conditions.
Indoor temperature 27°C DB / 19°C WB
Outdoor temperature 35°C DB
- Select the wire size according to the MCA.
- The maximum allowable voltage that is unbalanced between phases is 2%.
- Use a circuit breaker instead of a fuse.

Symbols

- ① Hz
- ② Voltage
- ③ Voltage range
- MCA Minimum Circuit Ampere (A)
- MFA Maximum Fuse Ampere (A)
- RLA Rated load amps [A]
- OFM Outdoor fan motor
- IFM Indoor fan motor
- FLA Full Load Ampere (A)
- kW Fan motor rated output [kW]
- RHz Rated operating frequency [Hz]
- COMP Compressor

3D094863B

3 Electrical data

3 - 1 Electrical Data

RZQG-L9V1

Unit combination restrictions		Power supply			COMP		OFM		IFM			
Indoor	Outdoor	①	②	③	MCA	MFA	RHz	RLA	kW	FLA	kW	FLA
2xFNQ35A2VEB	RZQG71L9V1B	50	220-240V	MAX. 50Hz 264V MIN. 50Hz 198V	17.2	20	-	15.6	0.094	0.4	2x0.034	2x0.3
2xFNQ50A2VEB	RZQG100L9V1B				28.9	32	-	24.2	0.094 + 0.094	0.4 + 0.4	2x0.06	2x0.5
3xFNQ35A2VEB	RZQG100L9V1B				28.8	32	-	24.2	0.094 + 0.094	0.4 + 0.4	3x0.034	3x0.3
2xFNQ60A2VEB	RZQG125L9V1B				29	32	-	24.2	0.094 + 0.094	0.4 + 0.4	2x0.06	2x0.5
3xFNQ50A2VEB	RZQG125L9V1B				29.5	32	-	24.2	0.094 + 0.094	0.4 + 0.4	3x0.06	3x0.5
4xFNQ35A2VEB	RZQG125L9V1B				29.2	32	-	24.2	0.094 + 0.094	0.4 + 0.4	4x0.034	4x0.3
3xFNQ50A2VEB	RZQG140L9V1B				29.5	32	-	24.2	0.094 + 0.094	0.4 + 0.4	3x0.06	3x0.5

Notes

- The RLA is based on the following conditions.
Indoor temperature 27°C DB / 19°C WB
Outdoor temperature 35°C DB
- Select the wire size according to the MCA.
- The maximum allowable voltage that is unbalanced between phases is 2%.
- Use a circuit breaker instead of a fuse.

- Symbols
- ① Hz
 - ② Voltage
 - ③ Voltage range
 - MCA Minimum Circuit Ampere (A)
 - MFA Maximum Fuse Ampere (A)
 - RLA Rated load amps [A]
 - OFM Outdoor fan motor
 - IFM Indoor fan motor
 - FLA Full Load Ampere (A)
 - kW Fan motor rated output [kW]
 - RHz Rated operating frequency [Hz]
 - COMP Compressor

3D096315C

RZQG140L9V1

Unit combination restrictions		Power supply			COMP		OFM		IFM			
Indoor	Outdoor	①	②	③	MCA	MFA	RHz	RLA	kW	FLA	kW	FLA
4xFNQ35A2VEB	RZQG140L9V1B	50	220-240V	MAX. 50Hz 264V MIN. 50Hz 198V	29.2	32	-	24.2	0.094 + 0.094	0.4 + 0.4	4x0.034	4x0.3

Notes

- The RLA is based on the following conditions.
Indoor temperature 27°C DB / 19°C WB
Outdoor temperature 35°C DB
- Select the wire size according to the MCA.
- The maximum allowable voltage that is unbalanced between phases is 2%.
- Use a circuit breaker instead of a fuse.

- Symbols
- ① Hz
 - ② Voltage
 - ③ Voltage range
 - MCA Minimum Circuit Ampere (A)
 - MFA Maximum Fuse Ampere (A)
 - RLA Rated load amps [A]
 - OFM Outdoor fan motor
 - IFM Indoor fan motor
 - FLA Full Load Ampere (A)
 - kW Fan motor rated output [kW]
 - RHz Rated operating frequency [Hz]
 - COMP Compressor

3D096315C

3 Electrical data

3 - 1 Electrical Data

3

RZQG71-100L9V1

Infrastructure Cooling

Indoor	Outdoor	Power supply	Voltage range	MCA	TOCA	MFA	Compressor		OFM		IFM	
							MSC	RLA	kW	FLA	kW	FLA
FCQHG100FVEB				19.2	—	20	—	15.6	0.094	0.4	0.221	1.3
FCQG35FVEB	x3			18.7	—	20	—	15.6	0.094	0.4	0.044 x3	0.3 x3
FCQG50FVEB	x2			18.4	—	20	—	15.6	0.094	0.4	0.039 x2	0.3 x2
FCQG100FVEB	x2			18.5	—	20	—	15.6	0.094	0.4	0.117	0.7
FFQ35C2VEB	x3			19.1	—	20	—	15.6	0.094	0.4	0.050 x3	0.4 x3
FFQ50C2VEB	x2			18.6	—	20	—	15.6	0.094	0.4	0.050 x2	0.4 x2
FBQ35D2VEB	x3			19.9	—	25	—	15.6	0.094	0.4	0.089 x3	0.6 x3
FBQ50D2VEB	x2			19.1	—	20	—	15.6	0.094	0.4	0.089 x2	0.6 x2
FBQ100D2VEB				18.9	—	20	—	15.6	0.094	0.4	0.127	1.0
FHQ35CAVEB	x3			19.9	—	25	—	15.6	0.094	0.4	0.060 x3	0.6 x3
FHQ50CAVEB	x2			19.1	—	20	—	15.6	0.094	0.4	0.060 x2	0.6 x2
FHQ100CAVEB				19.2	—	20	—	15.6	0.094	0.4	0.150	1.3
FVQ100CVEB				19.2	—	20	—	15.6	0.094	0.4	0.106	1.3
FAQ100CVEB				18.1	—	20	—	15.6	0.094	0.4	0.064	0.4
FVQ100CVEB				19.1	—	20	—	15.6	0.094	0.4	0.238	1.2
FDXS35F2VEB	x3			18.7	—	20	—	15.6	0.094	0.4	0.034 x3	0.3 x3
FDXS50F2VEB	x2			18.9	—	20	—	15.6	0.094	0.4	0.060 x2	0.5 x2
FCQHG71FVEB	x2			28.8	—	32	—	24.2	0.094+0.094	0.4+0.4	0.091 x2	0.5 x2
FCQHG140FVEB				29.3	—	32	—	24.2	0.094+0.094	0.4+0.4	0.244	1.4
FCQG35FVEB	x4			29.0	—	32	—	24.2	0.094+0.094	0.4+0.4	0.044 x4	0.3 x4
FCQG50FVEB	x3			28.6	—	32	—	24.2	0.094+0.094	0.4+0.4	0.039 x3	0.3 x3
FCQG71FVEB	x2			28.5	—	32	—	24.2	0.094+0.094	0.4+0.4	0.054 x2	0.4 x2
FCQ140FVEB				28.8	—	32	—	24.2	0.094+0.094	0.4+0.4	0.168	1.0
FFQ35C2VEB	x4			29.5	—	32	—	24.2	0.094+0.094	0.4+0.4	0.050 x4	0.4 x4
FFQ50C2VEB	x3			29.0	—	32	—	24.2	0.094+0.094	0.4+0.4	0.050 x3	0.4 x3
FBQ35D2VEB	x4			30.5	—	32	—	24.2	0.094+0.094	0.4+0.4	0.089 x4	0.6 x4
FBQ50D2VEB	x3			29.8	—	32	—	24.2	0.094+0.094	0.4+0.4	0.089 x3	0.6 x3
FBQ71D2VEB	x2			28.8	—	32	—	24.2	0.094+0.094	0.4+0.4	0.070 x2	0.5 x2
FBQ140D2VEB				29.4	—	32	—	24.2	0.094+0.094	0.4+0.4	0.187	1.5
FHQ35CAVEB	x4			30.5	—	32	—	24.2	0.094+0.094	0.4+0.4	0.060 x4	0.6 x4
FHQ50CAVEB	x3			29.8	—	32	—	24.2	0.094+0.094	0.4+0.4	0.060 x3	0.6 x3
FHQ71CAVEB	x2			29.5	—	32	—	24.2	0.094+0.094	0.4+0.4	0.091 x2	0.8 x2
FHQ140CAVEB				29.8	—	32	—	24.2	0.094+0.094	0.4+0.4	0.150	1.8
FVQ71CVEB	x2			29.8	—	32	—	24.2	0.094+0.094	0.4+0.4	0.046 x2	0.9 x2
FAQ71CVEB	x2			28.5	—	32	—	24.2	0.094+0.094	0.4+0.4	0.048 x2	0.4 x2
FVQ140CVEB				29.3	—	32	—	24.2	0.094+0.094	0.4+0.4	0.276	1.4
FDXS35F2VEB	x4			29.0	—	32	—	24.2	0.094+0.094	0.4+0.4	0.034 x4	0.3 x4
FDXS50F2VEB	x3			29.4	—	32	—	24.2	0.094+0.094	0.4+0.4	0.060 x3	0.5 x3

Symbols

- MCA: Minimum Circuit Ampere [A]
- TOCA: Total overcurrent amps [A]
- MFA: Maximum Fuse Ampere [A]
- MSC: Maximum current of the starting compressor [A]
- RLA: Rated load amps [A]
- OFM: Outdoor fan motor
- IFM: Indoor fan motor
- FLA: Full Load Ampere [A]
- KW: Fan motor rated output [kW]

Notes

1. The RLA is based on the following conditions.
 - Cooling
 - Indoor temperature 27.0°C DB / 19.0°C WB
 - Outdoor temperature 35.0°C DB
 - Heating
 - Indoor temperature 20.0°C DB
 - Outdoor temperature 7.0°C DB / 6.0°C WB
2. TOCA is the total value of each overcurrent set.
3. Voltage range
 - The units are suitable for use with electrical systems in which the voltage supplied to the unit terminals is not below or above the listed range limits.
4. The maximum allowable voltage that is unbalanced between phases is 2%.
5. MCA is the maximum input current.
 - The capacity of the MFA must be greater than that of the MCA.
 - Select the MFA according to the table.
6. Select the wire size according to the MCA.
7. MFA is used to select the circuit breaker and the ground fault circuit interruptor.
 - Earth leakage circuit breaker

3D098291

3 Electrical data

3 - 1 Electrical Data

RZQG125-140L9V1

Infrastructure Cooling

Indoor	Outdoor	Power supply	Voltage range	MCA	TOCA	MFA	Compressor		OFM		IFM		
							MSC	RLA	kW	FLA	kW	FLA	
FCQHG71FVEB	x2	RZQG125L9V1B	Minimum: 198 V Maximum: 264 V	28.8	—	32	—	24.2	0.094+0.094	0.4+0.4	0.091 x2	0.5 x2	
FCQHG140FVEB	x2	RZQG125L9V1B		29.3	—	32	—	24.2	0.094+0.094	0.4+0.4	0.244	1.4	
FCQG35FVEB	x4	RZQG125L9V1B		29.0	—	32	—	24.2	0.094+0.094	0.4+0.4	0.044 x4	0.3 x4	
FCQG50FVEB	x3	RZQG125L9V1B		28.6	—	32	—	24.2	0.094+0.094	0.4+0.4	0.039 x3	0.3 x3	
FCQG71FVEB	x2	RZQG125L9V1B		28.5	—	32	—	24.2	0.094+0.094	0.4+0.4	0.054 x2	0.4 x2	
FCQG140FVEB	x2	RZQG125L9V1B		28.8	—	32	—	24.2	0.094+0.094	0.4+0.4	0.168	1.0	
FFQ35C2VEB	x4	RZQG125L9V1B		29.5	—	32	—	24.2	0.094+0.094	0.4+0.4	0.050 x4	0.4 x4	
FFQ50C2VEB	x3	RZQG125L9V1B		29.0	—	32	—	24.2	0.094+0.094	0.4+0.4	0.050 x3	0.4 x3	
FBQ35D2VEB	x4	RZQG125L9V1B		30.5	—	32	—	24.2	0.094+0.094	0.4+0.4	0.089 x4	0.6 x4	
FBQ50D2VEB	x3	RZQG125L9V1B		29.8	—	32	—	24.2	0.094+0.094	0.4+0.4	0.089 x3	0.6 x3	
FBQ71D2VEB	x2	RZQG125L9V1B		28.8	—	32	—	24.2	0.094+0.094	0.4+0.4	0.070 x2	0.5 x2	
FBQ140D2VEB	x2	RZQG125L9V1B		29.4	—	32	—	24.2	0.094+0.094	0.4+0.4	0.187	1.5	
FHQ35CAVEB	x4	RZQG125L9V1B		30.5	—	32	—	24.2	0.094+0.094	0.4+0.4	0.060 x4	0.6 x4	
FHQ50CAVEB	x3	RZQG125L9V1B		29.8	—	32	—	24.2	0.094+0.094	0.4+0.4	0.060 x3	0.6 x3	
FHQ71CAVEB	x2	RZQG125L9V1B		29.5	—	32	—	24.2	0.094+0.094	0.4+0.4	0.091 x2	0.8 x2	
FHQ140CAVEB	x2	RZQG125L9V1B		29.8	—	32	—	24.2	0.094+0.094	0.4+0.4	0.150	1.8	
FUQ71CVEB	x2	RZQG125L9V1B		29.8	—	32	—	24.2	0.094+0.094	0.4+0.4	0.046 x2	0.9 x2	
FAQ71CVEB	x2	RZQG125L9V1B		28.5	—	32	—	24.2	0.094+0.094	0.4+0.4	0.048 x2	0.4 x2	
FVQ140CVEB	x2	RZQG125L9V1B		29.3	—	32	—	24.2	0.094+0.094	0.4+0.4	0.276	1.4	
FDXS35F2VEB	x4	RZQG125L9V1B		29.0	—	32	—	24.2	0.094+0.094	0.4+0.4	0.034 x4	0.3 x4	
FDXS50F2VEB9	x3	RZQG125L9V1B		29.4	—	32	—	24.2	0.094+0.094	0.4+0.4	0.060 x3	0.5 x3	
FCQHG71FVEB	x2	RZQG140L9V1B		Minimum: 198 V Maximum: 264 V	28.8	—	32	—	24.2	0.094+0.094	0.4+0.4	0.091 x2	0.5 x2
FCQHG140FVEB	x2	RZQG140L9V1B			29.3	—	32	—	24.2	0.094+0.094	0.4+0.4	0.244	1.4
FCQG35FVEB	x4	RZQG140L9V1B			29.0	—	32	—	24.2	0.094+0.094	0.4+0.4	0.044 x4	0.3 x4
FCQG50FVEB	x3	RZQG140L9V1B			28.6	—	32	—	24.2	0.094+0.094	0.4+0.4	0.039 x3	0.3 x3
FCQG71FVEB	x2	RZQG140L9V1B			28.5	—	32	—	24.2	0.094+0.094	0.4+0.4	0.054 x2	0.4 x2
FCQG140FVEB	x2	RZQG140L9V1B			28.8	—	32	—	24.2	0.094+0.094	0.4+0.4	0.168	1.0
FFQ35C2VEB	x4	RZQG140L9V1B			29.5	—	32	—	24.2	0.094+0.094	0.4+0.4	0.050 x4	0.4 x4
FFQ50C2VEB	x3	RZQG140L9V1B			29.0	—	32	—	24.2	0.094+0.094	0.4+0.4	0.050 x3	0.4 x3
FBQ35D2VEB	x4	RZQG140L9V1B			30.5	—	32	—	24.2	0.094+0.094	0.4+0.4	0.089 x4	0.6 x4
FBQ50D2VEB	x3	RZQG140L9V1B			29.8	—	32	—	24.2	0.094+0.094	0.4+0.4	0.089 x3	0.6 x3
FBQ71D2VEB	x2	RZQG140L9V1B			28.8	—	32	—	24.2	0.094+0.094	0.4+0.4	0.070 x2	0.5 x2
FBQ140D2VEB	x2	RZQG140L9V1B			29.4	—	32	—	24.2	0.094+0.094	0.4+0.4	0.187	1.5
FHQ35CAVEB	x4	RZQG140L9V1B	30.5		—	32	—	24.2	0.094+0.094	0.4+0.4	0.060 x4	0.6 x4	
FHQ50CAVEB	x3	RZQG140L9V1B	29.8		—	32	—	24.2	0.094+0.094	0.4+0.4	0.060 x3	0.6 x3	
FHQ71CAVEB	x2	RZQG140L9V1B	29.5		—	32	—	24.2	0.094+0.094	0.4+0.4	0.091 x2	0.8 x2	
FHQ140CAVEB	x2	RZQG140L9V1B	29.8		—	32	—	24.2	0.094+0.094	0.4+0.4	0.150	1.8	
FUQ71CVEB	x2	RZQG140L9V1B	29.8		—	32	—	24.2	0.094+0.094	0.4+0.4	0.046 x2	0.9 x2	
FAQ71CVEB	x2	RZQG140L9V1B	28.5		—	32	—	24.2	0.094+0.094	0.4+0.4	0.048 x2	0.4 x2	
FVQ140CVEB	x2	RZQG140L9V1B	29.3		—	32	—	24.2	0.094+0.094	0.4+0.4	0.276	1.4	
FDXS35F2VEB	x4	RZQG140L9V1B	29.0		—	32	—	24.2	0.094+0.094	0.4+0.4	0.034 x4	0.3 x4	
FDXS50F2VEB9	x3	RZQG140L9V1B	29.4		—	32	—	24.2	0.094+0.094	0.4+0.4	0.060 x3	0.5 x3	

Symbols

- MCA: Minimum Circuit Ampere [A]
- TOCA: Total overcurrent amps [A]
- MFA: Maximum Fuse Ampere [A]
- MSC: Maximum current of the starting compressor [A]
- RLA: Rated load amps [A]
- OFM: Outdoor fan motor
- IFM: Indoor fan motor
- FLA: Full Load Ampere [A]
- KW: Fan motor rated output [kW]

Notes

1. The RLA is based on the following conditions.
 - Cooling
 - Indoor temperature 27.0°C DB / 19.0°C WB
 - Outdoor temperature 35.0°C DB
 - Heating
 - Indoor temperature 20.0°C DB
 - Outdoor temperature 7.0°C DB / 6.0°C WB
2. TOCA is the total value of each overcurrent set.
3. Voltage range
 - The units are suitable for use with electrical systems in which the voltage supplied to the unit terminals is not below or above the listed range limits.
4. The maximum allowable voltage that is unbalanced between phases is 2%.
5. MCA is the maximum input current.
 - The capacity of the MFA must be greater than that of the MCA.
 - Select the MFA according to the table.
6. Select the wire size according to the MCA.
7. MFA is used to select the circuit breaker and the ground fault circuit interruptor.
 - Earth leakage circuit breaker

3D098291

4 Options

4 - 1 Options

RZQG-L9V1

Available options for RZQG models

Option	Option kit			
	RZQG71L9V1B	RZQG100L9V1B	RZQG125L9V1B	RZQG140L9V1B
Bottom plate heater	EKBP140L7			
Refrigerant branch piping	Twin	KHRQ22M20TA		
	Triple	-	KHRQ127H	
	Double twin	-	-	KHRQ22M20TA (3x)
Demand adaptor kit	SB.KRP58M51			

3D090356A

6 Capacity tables

6 - 1 Cooling Capacity Tables

6

RZQG71L9V1
RZQG71L8Y1

Performance characteristics for infrastructure cooling

Cooling

Indoor			Outdoor temperature [°C DB]																										
			-15			-10			-5			0			5			10			15			20					
RH [%]	*CWB	*CDB	TC kW	SHC kW	CPI	TC kW	SHC kW	CPI	TC kW	SHC kW	CPI	TC kW	SHC kW	CPI	TC kW	SHC kW	CPI	TC kW	SHC kW	CPI	TC kW	SHC kW	CPI	TC kW	SHC kW	CPI			
54.5	11	16	4.81	3.98	0.34	4.81	3.98	0.36	4.81	3.98	0.37	4.81	3.98	0.39	4.81	3.98	0.41	4.81	3.98	0.43	4.81	3.98	0.46	4.81	3.98	0.48	4.81	3.98	0.48
41.8	11	18	4.81	4.67	0.34	4.81	4.67	0.36	4.81	4.67	0.37	4.81	4.67	0.39	4.81	4.67	0.41	4.81	4.67	0.43	4.81	4.67	0.46	4.81	4.67	0.48	4.81	4.67	0.48
57	13		6.02	5.05	0.37	6.02	5.05	0.41	6.02	5.05	0.45	6.02	5.05	0.50	6.02	5.05	0.52	6.02	5.05	0.55	6.02	5.05	0.57	6.02	5.05	0.57	6.02	5.05	0.64
31.4	11	20	4.81	4.81	0.34	4.81	4.81	0.36	4.81	4.81	0.37	4.81	4.81	0.39	4.81	4.81	0.41	4.81	4.81	0.43	4.81	4.81	0.46	4.81	4.81	0.48	4.81	4.81	0.48
44.9	13		6.02	6.02	0.37	6.02	6.02	0.41	6.02	6.02	0.45	6.02	6.02	0.50	6.02	6.02	0.52	6.02	6.02	0.55	6.02	6.02	0.57	6.02	6.02	0.57	6.02	6.02	0.64
52	14	22	6.62	5.76	0.38	6.62	5.76	0.44	6.62	5.76	0.50	6.62	5.76	0.55	6.62	5.76	0.58	6.62	5.76	0.60	6.62	5.76	0.63	6.62	5.76	0.63	6.62	5.76	0.72
22.9	11		4.81	4.81	0.34	4.81	4.81	0.36	4.81	4.81	0.37	4.81	4.81	0.39	4.81	4.81	0.41	4.81	4.81	0.43	4.81	4.81	0.46	4.81	4.81	0.46	4.81	4.81	0.48
34.8	13	24	6.02	6.02	0.37	6.02	6.02	0.41	6.02	6.02	0.45	6.02	6.02	0.50	6.02	6.02	0.52	6.02	6.02	0.55	6.02	6.02	0.57	6.02	6.02	0.57	6.02	6.02	0.64
47.6	15		7.22	6.06	0.39	7.22	6.06	0.46	7.22	6.06	0.54	7.22	6.06	0.61	7.22	6.06	0.63	7.22	6.06	0.66	7.22	6.06	0.69	7.22	6.06	0.69	7.22	6.06	0.79
54.3	16	26	7.82	5.71	0.41	7.82	5.71	0.49	7.82	5.71	0.58	7.82	5.71	0.66	7.82	5.71	0.69	7.82	5.71	0.72	7.82	5.71	0.75	7.82	5.71	0.75	7.82	5.71	0.87
21.2	12		5.41	5.41	0.36	5.41	5.41	0.38	5.41	5.41	0.41	5.41	5.41	0.44	5.41	5.41	0.46	5.41	5.41	0.49	5.41	5.41	0.52	5.41	5.41	0.52	5.41	5.41	0.56
32.1	14	27	6.62	6.62	0.38	6.62	6.62	0.44	6.62	6.62	0.50	6.62	6.62	0.55	6.62	6.62	0.58	6.62	6.62	0.60	6.62	6.62	0.63	6.62	6.62	0.63	6.62	6.62	0.72
43.8	16		7.82	6.57	0.41	7.82	6.57	0.49	7.82	6.57	0.58	7.82	6.57	0.66	7.82	6.57	0.69	7.82	6.57	0.72	7.82	6.57	0.75	7.82	6.57	0.75	7.82	6.57	0.87
50	17	28	8.10	6.08	0.43	8.10	6.08	0.51	8.10	6.08	0.60	8.10	6.08	0.68	8.10	6.08	0.70	8.10	6.08	0.73	8.10	6.08	0.75	8.10	6.08	0.75	8.10	6.08	0.88
21.5	14		6.62	6.62	0.38	6.62	6.62	0.44	6.62	6.62	0.50	6.62	6.62	0.55	6.62	6.62	0.58	6.62	6.62	0.60	6.62	6.62	0.63	6.62	6.62	0.63	6.62	6.62	0.72
26.3	15	29	7.22	7.22	0.39	7.22	7.22	0.46	7.22	7.22	0.54	7.22	7.22	0.61	7.22	7.22	0.63	7.22	7.22	0.66	7.22	7.22	0.69	7.22	7.22	0.69	7.22	7.22	0.79
31.3	16		7.82	7.82	0.41	7.82	7.82	0.49	7.82	7.82	0.58	7.82	7.82	0.66	7.82	7.82	0.69	7.82	7.82	0.72	7.82	7.82	0.75	7.82	7.82	0.75	7.82	7.82	0.87
47.4	19	30	8.67	6.50	0.48	8.67	6.50	0.56	8.67	6.50	0.64	8.67	6.50	0.72	8.67	6.50	0.74	8.67	6.50	0.75	8.67	6.50	0.77	8.67	6.50	0.77	8.67	6.50	0.89
21.5	14		6.62	6.62	0.38	6.62	6.62	0.44	6.62	6.62	0.50	6.62	6.62	0.55	6.62	6.62	0.58	6.62	6.62	0.60	6.62	6.62	0.63	6.62	6.62	0.63	6.62	6.62	0.72

Notes

- The ratings shown are net capacities which include a deduction for indoor fan motor heat.
- The capacities are based on the following conditions:
Outdoor air: 85% RH
Corresponding refrigerant piping length: 5.0 m
Level difference: 0m
- CPI is a percentage value compared to the rated value which is 1.00.
- For EDP applications, it is recommended to use remote controller setting 16(26)-2-03.
- The error rate for this value is less than 5% and depends on the indoor unit type.
- The rated power input for each model is mentioned in the table below.

Pair	FCQHG100F	FCQG100F	FAQ100C	FVQ100C	FHQ100C	FUQ100C	FBQ100D
Cooling	1,66	2,01	2,00	2,02	1,78	1,67	1,89

Twin	FCQG50F x 2	FHQ50C x 2	FFQ50C x 2	FDXS50F9 x 2	FBQ50D x 2
Cooling	2,04	2,34	2,02	2,23	2,02

Triple	FCQG35F X 3	FHQ35CA X 3	FFQ35C X 3	FDXS35F x 3	FBQ35D X 3
Cooling	2,06	2,39	2,07	2,26	2,11

Symbols

- TC: Maximum total cooling capacity [kW]
- SHC: Sensible heat capacity [kW]
- CPI: Coefficient of the power input
- PI: Power input [kW]
compressor + indoor and outdoor fan motors
- RH: Relative humidity [%]

3D098206

6 Capacity tables

6 - 1 Cooling Capacity Tables

RZQG100L9V1
RZQG100L8Y1

Performance characteristics for infrastructure cooling

Cooling

Indoor			Outdoor temperature [°C DBI]																										
			-15			-10			-5			0			5			10			15			20					
RH [%]	°CWB	°CDB	TC	SHC	CPI	TC	SHC	CPI	TC	SHC	CPI	TC	SHC	CPI	TC	SHC	CPI	TC	SHC	CPI	TC	SHC	CPI	TC	SHC	CPI			
54.5	11	16	6.00	5.63	0.33	6.00	5.63	0.34	6.00	5.63	0.35	6.00	5.63	0.37	6.00	5.63	0.38	6.00	5.63	0.38	6.00	5.63	0.39	6.00	5.63	0.39			
41.8	11	18	6.00	6.00	0.33	6.00	6.00	0.34	6.00	6.00	0.35	6.00	6.00	0.37	6.00	6.00	0.38	6.00	6.00	0.38	6.00	6.00	0.39	6.00	6.00	0.39			
57.0	13		7.48	6.37	0.42	7.48	6.37	0.44	7.48	6.37	0.45	7.48	6.37	0.46	7.48	6.37	0.46	7.48	6.37	0.46	7.48	6.37	0.46	7.48	6.37	0.45	7.48	6.37	0.46
31.4	11	20	6.00	6.00	0.33	6.00	6.00	0.34	6.00	6.00	0.35	6.00	6.00	0.37	6.00	6.00	0.38	6.00	6.00	0.38	6.00	6.00	0.39	6.00	6.00	0.39			
44.9	13		7.48	7.25	0.42	7.48	7.25	0.44	7.48	7.25	0.45	7.48	7.25	0.46	7.48	7.25	0.46	7.48	7.25	0.46	7.48	7.25	0.45	7.48	7.25	0.46			
52.0	14	22	8.22	7.18	0.47	8.22	7.18	0.48	8.22	7.18	0.49	8.22	7.18	0.51	8.22	7.18	0.50	8.22	7.18	0.49	8.22	7.18	0.49	8.22	7.18	0.49			
22.9	11		6.00	6.00	0.33	6.00	6.00	0.34	6.00	6.00	0.35	6.00	6.00	0.37	6.00	6.00	0.38	6.00	6.00	0.38	6.00	6.00	0.39	6.00	6.00	0.39			
34.8	13	24	7.48	7.48	0.42	7.48	7.48	0.44	7.48	7.48	0.45	7.48	7.48	0.46	7.48	7.48	0.46	7.48	7.48	0.46	7.48	7.48	0.46	7.48	7.48	0.45	7.48	7.48	0.46
47.6	15		8.96	7.82	0.52	8.96	7.82	0.53	8.96	7.82	0.54	8.96	7.82	0.55	8.96	7.82	0.54	8.96	7.82	0.53	8.96	7.82	0.52	8.96	7.82	0.52			
54.3	16	27	9.70	7.54	0.56	9.70	7.54	0.58	9.70	7.54	0.59	9.70	7.54	0.60	9.70	7.54	0.59	9.70	7.54	0.57	9.70	7.54	0.55	9.70	7.54	0.55			
21.2	12		6.74	6.74	0.38	6.74	6.74	0.39	6.74	6.74	0.40	6.74	6.74	0.41	6.74	6.74	0.42	6.74	6.74	0.42	6.74	6.74	0.42	6.74	6.74	0.42			
32.1	14	24	8.22	8.22	0.47	8.22	8.22	0.48	8.22	8.22	0.49	8.22	8.22	0.51	8.22	8.22	0.50	8.22	8.22	0.49	8.22	8.22	0.49	8.22	8.22	0.49			
43.8	16		9.70	8.68	0.56	9.70	8.68	0.58	9.70	8.68	0.59	9.70	8.68	0.60	9.70	8.68	0.59	9.70	8.68	0.57	9.70	8.68	0.55	9.70	8.68	0.56			
50.0	17	27	9.98	7.86	0.58	9.98	7.86	0.59	9.98	7.86	0.60	9.98	7.86	0.61	9.98	7.86	0.60	9.98	7.86	0.60	9.98	7.86	0.60	9.98	7.86	0.58			
21.5	14		8.22	8.22	0.47	8.22	8.22	0.48	8.22	8.22	0.49	8.22	8.22	0.51	8.22	8.22	0.50	8.22	8.22	0.49	8.22	8.22	0.49	8.22	8.22	0.49			
26.3	15	27	8.96	8.96	0.52	8.96	8.96	0.53	8.96	8.96	0.54	8.96	8.96	0.55	8.96	8.96	0.54	8.96	8.96	0.53	8.96	8.96	0.52	8.96	8.96	0.52			
31.3	16		9.70	9.70	0.56	9.70	9.70	0.58	9.70	9.70	0.59	9.70	9.70	0.60	9.70	9.70	0.59	9.70	9.70	0.57	9.70	9.70	0.55	9.70	9.70	0.56			
47.4	19	27	10.53	8.53	0.60	10.53	8.53	0.61	10.53	8.53	0.61	10.53	8.53	0.63	10.53	8.53	0.63	10.53	8.53	0.66	10.53	8.53	0.68	10.53	8.53	0.68			

Notes

- The ratings shown are net capacities which include a deduction for indoor fan motor heat.
- The capacities are based on the following conditions:
Outdoor air: 85% RH
Corresponding refrigerant piping length: 5.0 m
Level difference: 0m
- For EDP applications, it is recommended to use remote controller setting 16(26)-2-03.
- CPI is a percentage value compared to the rated value which is 1.00.
- The error rate for this value is less than 5% and depends on the indoor unit type.
- The rated power input for each model is mentioned in the table below.

Pair

	FCQHG140F	FCQG140F	FVQ140C	FHQ140C	FBQ140D
Cooling	2,15	2,45	2,49	2,49	2,49

Twin

	FCQHG71Fx2	FCQG71F X 2	FHQ71C X 2	FUQ71C x 2	FAQ71C x 2	FBQ71D X 2
Cooling	2,14	2,35	2,94	2,34	2,64	2,83

Triple

	FCQG50F X 3	FHQ50C X 3	FFQ50C X 3	FDXS50F9 X 3	FBQ50D X 3
Cooling	2,33	2,98	2,70	2,54	2,96

Double twin

	FCQG35F X 4	FHQ35C X 4	FFQ35C X 4	FDXS35F X 4	FBQ35D x 4
Cooling	2,35	3,03	2,75	2,58	3,05

Symbols

- TC: Maximum total cooling capacity [kW]
- SHC: Sensible heat capacity [kW]
- CPI: Coefficient of the power input
- PI: Power input [kW]
compressor + indoor and outdoor fan motors
- RH: Relative humidity [%]

3D098207

6 Capacity tables

6 - 1 Cooling Capacity Tables

6

RZQG125L9V1
RZQG125L8V1

Performance characteristics for infrastructure cooling

Cooling

Indoor			Outdoor temperature [°C DB]																										
			-15			-10			-5			0			5			10			15			20					
RH [%]	°CWB	°CDB	TC	SHC	CPI	TC	SHC	CPI	TC	SHC	CPI	TC	SHC	CPI	TC	SHC	CPI	TC	SHC	CPI	TC	SHC	CPI	TC	SHC	CPI			
54.5	11.0	16	7.49	6.72	0.33	7.49	6.72	0.34	7.49	6.72	0.35	7.49	6.72	0.36	7.49	6.72	0.37	7.49	6.72	0.38	7.49	6.72	0.38	7.49	6.72	0.38	7.49	6.72	0.38
41.8	11.0	18	7.49	7.49	0.33	7.49	7.49	0.34	7.49	7.49	0.35	7.49	7.49	0.36	7.49	7.49	0.37	7.49	7.49	0.38	7.49	7.49	0.38	7.49	7.49	0.38	7.49	7.49	0.38
57.0	13.0		9.34	7.60	0.42	9.34	7.60	0.43	9.34	7.60	0.44	9.34	7.60	0.45	9.34	7.60	0.45	9.34	7.60	0.45	9.34	7.60	0.45	9.34	7.60	0.45	9.34	7.60	0.45
31.4	11.0	20	7.49	7.49	0.33	7.49	7.49	0.34	7.49	7.49	0.35	7.49	7.49	0.36	7.49	7.49	0.37	7.49	7.49	0.38	7.49	7.49	0.38	7.49	7.49	0.38	7.49	7.49	0.38
44.9	13.0		9.34	8.65	0.42	9.34	8.65	0.43	9.34	8.65	0.44	9.34	8.65	0.45	9.34	8.65	0.45	9.34	8.65	0.45	9.34	8.65	0.45	9.34	8.65	0.45	9.34	8.65	0.45
52.0	14.0	22	10.27	8.56	0.46	10.27	8.56	0.47	10.27	8.56	0.49	10.27	8.56	0.50	10.27	8.56	0.49	10.27	8.56	0.49	10.27	8.56	0.49	10.27	8.56	0.48	10.27	8.56	0.48
22.9	11.0		7.49	7.49	0.33	7.49	7.49	0.34	7.49	7.49	0.35	7.49	7.49	0.36	7.49	7.49	0.37	7.49	7.49	0.38	7.49	7.49	0.38	7.49	7.49	0.38	7.49	7.49	0.38
34.8	13.0	24	9.34	9.34	0.42	9.34	9.34	0.43	9.34	9.34	0.44	9.34	9.34	0.45	9.34	9.34	0.45	9.34	9.34	0.45	9.34	9.34	0.45	9.34	9.34	0.45	9.34	9.34	0.45
47.6	15.0		11.20	9.34	0.51	11.20	9.34	0.52	11.20	9.34	0.53	11.20	9.34	0.55	11.20	9.34	0.54	11.20	9.34	0.52	11.20	9.34	0.51	11.20	9.34	0.51	11.20	9.34	0.51
54.3	16.0	27	12.12	9.00	0.55	12.12	9.00	0.57	12.12	9.00	0.58	12.12	9.00	0.59	12.12	9.00	0.58	12.12	9.00	0.56	12.12	9.00	0.54	12.12	9.00	0.54	12.12	9.00	0.55
21.2	12.0		8.42	8.42	0.37	8.42	8.42	0.38	8.42	8.42	0.39	8.42	8.42	0.41	8.42	8.42	0.41	8.42	8.42	0.41	8.42	8.42	0.41	8.42	8.42	0.41	8.42	8.42	0.41
32.1	14.0	24	10.27	10.27	0.46	10.27	10.27	0.47	10.27	10.27	0.49	10.27	10.27	0.50	10.27	10.27	0.49	10.27	10.27	0.49	10.27	10.27	0.48	10.27	10.27	0.48	10.27	10.27	0.48
43.8	16.0		12.12	10.35	0.55	12.12	10.35	0.57	12.12	10.35	0.58	12.12	10.35	0.59	12.12	10.35	0.58	12.12	10.35	0.56	12.12	10.35	0.54	12.12	10.35	0.54	12.12	10.35	0.55
50.0	17.0	27	12.47	9.38	0.57	12.47	9.38	0.58	12.47	9.38	0.59	12.47	9.38	0.60	12.47	9.38	0.59	12.47	9.38	0.59	12.47	9.38	0.59	12.47	9.38	0.59	12.47	9.38	0.59
21.5	14.0		10.27	10.27	0.46	10.27	10.27	0.47	10.27	10.27	0.49	10.27	10.27	0.50	10.27	10.27	0.49	10.27	10.27	0.49	10.27	10.27	0.48	10.27	10.27	0.48	10.27	10.27	0.48
26.3	15.0	27	11.20	11.20	0.51	11.20	11.20	0.52	11.20	11.20	0.53	11.20	11.20	0.55	11.20	11.20	0.54	11.20	11.20	0.52	11.20	11.20	0.51	11.20	11.20	0.51	11.20	11.20	0.51
31.3	16.0		12.12	12.12	0.55	12.12	12.12	0.57	12.12	12.12	0.58	12.12	12.12	0.59	12.12	12.12	0.58	12.12	12.12	0.56	12.12	12.12	0.54	12.12	12.12	0.54	12.12	12.12	0.55
47.4	19.0	27	13.17	10.18	0.59	13.17	10.18	0.60	13.17	10.18	0.60	13.17	10.18	0.60	13.17	10.18	0.62	13.17	10.18	0.65	13.17	10.18	0.67	13.17	10.18	0.67	13.17	10.18	0.67

Notes

- The ratings shown are net capacities which include a deduction for indoor fan motor heat.
- The capacities are based on the following conditions:
Outdoor air: 85% RH
Corresponding refrigerant piping length: 5.0 m
Level difference: 0m
- For EDP applications, it is recommended to use remote controller setting 16(26)-2-03.
- CPI is a percentage value compared to the rated value which is 1.00.
- The error rate for this value is less than 5% and depends on the indoor unit type.
- The rated power input for each model is mentioned in the table below.

Pair

	FCQHG140F	FCQG140F	FVQ140C	FHQ140C	FBQ140D
Cooling	3,00	3,22	3,74	3,58	3,63

Twin

	FCQHG71Fx2	FCQG71F X 2	FHQ71C X 2	FUQ71C x 2	FAQ71C x 2	FBQ71D X 2
Cooling	2,97	3,17	3,67	3,44	3,69	4,10

Triple

	FCQG50F X 3	FHQ50C X 3	FFQ50C X 3	FDXS50F9 X 3	FBQ50D X 3
Cooling	3,17	3,66	3,23	3,45	3,97

Double twin

	FCQG35F X 4	FHQ35C X 4	FFQ35C X 4	FDXS35F X 4	FBQ35D x 4
Cooling	3,23	3,64	3,01	3,94	3,74

Symbols

- TC: Maximum total cooling capacity [kW]
- SHC: Sensible heat capacity [kW]
- CPI: Coefficient of the power input
- PI: Power input [kW]
compressor + indoor and outdoor fan motors
- RH: Relative humidity [%]

3D098208

6 Capacity tables

6 - 1 Cooling Capacity Tables

RZQG140L9V1
RZQG140LY1

Performance characteristics for infrastructure cooling

Cooling

Indoor			Outdoor temperature [°C DB]																										
			-15			-10			-5			0			5			10			15			20					
RH [%]	*CWB	*CDB	TC	SHC	CPI	TC	SHC	CPI	TC	SHC	CPI	TC	SHC	CPI	TC	SHC	CPI	TC	SHC	CPI	TC	SHC	CPI	TC	SHC	CPI			
54.5	11.0	16	8.24	7.27	0.32	8.24	7.27	0.33	8.24	7.27	0.34	8.24	7.27	0.35	8.24	7.27	0.37	8.24	7.27	0.37	8.24	7.27	0.37	8.24	7.27	0.37	8.24	7.27	0.38
41.8	11.0	18	8.24	8.24	0.32	8.24	8.24	0.33	8.24	8.24	0.34	8.24	8.24	0.35	8.24	8.24	0.37	8.24	8.24	0.37	8.24	8.24	0.37	8.24	8.24	0.37	8.24	8.24	0.38
57.0	13.0	18	10.28	8.22	0.41	10.28	8.22	0.42	10.28	8.22	0.43	10.28	8.22	0.45	10.28	8.22	0.45	10.28	8.22	0.44	10.28	8.22	0.44	10.28	8.22	0.44	10.28	8.22	0.44
31.4	11.0	20	8.24	8.24	0.32	8.24	8.24	0.33	8.24	8.24	0.34	8.24	8.24	0.35	8.24	8.24	0.37	8.24	8.24	0.37	8.24	8.24	0.37	8.24	8.24	0.37	8.24	8.24	0.38
44.9	13.0	20	10.28	9.35	0.41	10.28	9.35	0.42	10.28	9.35	0.43	10.28	9.35	0.45	10.28	9.35	0.45	10.28	9.35	0.44	10.28	9.35	0.44	10.28	9.35	0.44	10.28	9.35	0.44
52.0	14.0	20	11.30	9.26	0.45	11.30	9.26	0.47	11.30	9.26	0.48	11.30	9.26	0.49	11.30	9.26	0.49	11.30	9.26	0.48	11.30	9.26	0.47	11.30	9.26	0.47	11.30	9.26	0.47
22.9	11.0	22	8.24	8.24	0.32	8.24	8.24	0.33	8.24	8.24	0.34	8.24	8.24	0.35	8.24	8.24	0.37	8.24	8.24	0.37	8.24	8.24	0.37	8.24	8.24	0.37	8.24	8.24	0.38
34.8	13.0	22	10.28	10.28	0.41	10.28	10.28	0.42	10.28	10.28	0.43	10.28	10.28	0.45	10.28	10.28	0.45	10.28	10.28	0.44	10.28	10.28	0.44	10.28	10.28	0.44	10.28	10.28	0.44
47.6	15.0	22	12.32	10.10	0.50	12.32	10.10	0.51	12.32	10.10	0.52	12.32	10.10	0.54	12.32	10.10	0.53	12.32	10.10	0.51	12.32	10.10	0.50	12.32	10.10	0.50	12.32	10.10	0.50
54.3	16.0	22	13.33	9.73	0.54	13.33	9.73	0.56	13.33	9.73	0.57	13.33	9.73	0.58	13.33	9.73	0.57	13.33	9.73	0.55	13.33	9.73	0.53	13.33	9.73	0.53	13.33	9.73	0.54
21.2	12.0	24	9.26	9.26	0.37	9.26	9.26	0.38	9.26	9.26	0.39	9.26	9.26	0.40	9.26	9.26	0.41	9.26	9.26	0.41	9.26	9.26	0.41	9.26	9.26	0.41	9.26	9.26	0.41
32.1	14.0	24	11.30	11.30	0.45	11.30	11.30	0.47	11.30	11.30	0.48	11.30	11.30	0.49	11.30	11.30	0.49	11.30	11.30	0.48	11.30	11.30	0.47	11.30	11.30	0.47	11.30	11.30	0.47
43.8	16.0	24	13.33	11.20	0.54	13.33	11.20	0.56	13.33	11.20	0.57	13.33	11.20	0.58	13.33	11.20	0.57	13.33	11.20	0.55	13.33	11.20	0.53	13.33	11.20	0.53	13.33	11.20	0.54
50.0	17.0	24	13.72	10.15	0.56	13.72	10.15	0.57	13.72	10.15	0.58	13.72	10.15	0.59	13.72	10.15	0.58	13.72	10.15	0.58	13.72	10.15	0.58	13.72	10.15	0.58	13.72	10.15	0.58
21.5	14.0	27	11.30	11.30	0.45	11.30	11.30	0.47	11.30	11.30	0.48	11.30	11.30	0.49	11.30	11.30	0.49	11.30	11.30	0.48	11.30	11.30	0.47	11.30	11.30	0.47	11.30	11.30	0.47
26.3	15.0	27	12.32	12.32	0.50	12.32	12.32	0.51	12.32	12.32	0.52	12.32	12.32	0.54	12.32	12.32	0.53	12.32	12.32	0.51	12.32	12.32	0.50	12.32	12.32	0.50	12.32	12.32	0.50
31.3	16.0	27	13.33	13.33	0.54	13.33	13.33	0.56	13.33	13.33	0.57	13.33	13.33	0.58	13.33	13.33	0.57	13.33	13.33	0.55	13.33	13.33	0.53	13.33	13.33	0.53	13.33	13.33	0.54
47.4	19.0	27	14.48	11.01	0.58	14.48	11.01	0.59	14.48	11.01	0.59	14.48	11.01	0.59	14.48	11.01	0.61	14.48	11.01	0.64	14.48	11.01	0.66	14.48	11.01	0.66	14.48	11.01	0.66

Notes

- The ratings shown are net capacities which include a deduction for indoor fan motor heat.
- The capacities are based on the following conditions:
Outdoor air: 85% RH
Corresponding refrigerant piping length: 5.0 m
Level difference: 0m
- For EDP applications, it is recommended to use remote controller setting 16(26)-2-03.
- CPI is a percentage value compared to the rated value which is 1.00.
- The error rate for this value is less than 5% and depends on the indoor unit type.
- The rated power input for each model is mentioned in the table below.

Pair

	FCQHG140F	FCQG140F	FVQ140C	FHQ140C	FBQ140D
Cooling	4,00	4,17	4,17	4,05	4,00

Twin

	FCQHG71Fx2	FCQG71F X 2	FHQ71C X 2	FUQ71C x 2	FAQ71C x 2	FBO71D X 2
Cooling	3,94	4,11	3,59	3,35	3,81	3,75

Triple

	FCQG50F X 3	FHQ50C X 3	FFQ50C X 3	FDXS50F9 X 3	FBQ50D X 3
Cooling	4,12	4,25	4,15	4,26	3,75

Double twin

	FCQG35F X 4	FHQ35C X 4	FFQ35C X 4	FDXS35F X 4	FBQ35D x 4
Cooling	4,18	4,23	3,83	5,38	3,75

Symbols

- TC: Maximum total cooling capacity [kW]
- SHC: Sensible heat capacity [kW]
- CPI: Coefficient of the power input
- PI: Power input [kW]
compressor + indoor and outdoor fan motors
- RH: Relative humidity [%]

3D098209

6 Capacity tables

6 - 2 Cooling/Heating Capacity Tables

6

RZQG71L9V1 RZQG71L8Y1

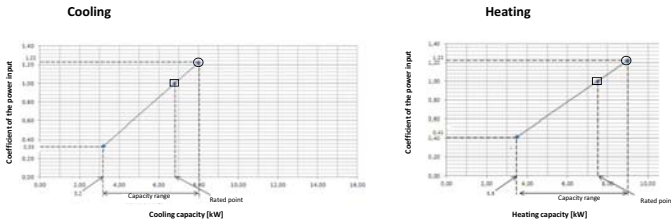

Indoor	Outdoor temperature (°C DB)												
	25			30			35			40			
	TC	SHC	CPI	TC	SHC	CPI	TC	SHC	CPI	TC	SHC	CPI	
°CWB	°CDB	kW	kW	—	kW	kW	—	kW	kW	—	kW	kW	—
16.0	22	8.03	5.45	1.00	7.76	5.32	1.11	7.48	5.20	1.21	7.21	5.06	1.32
18.0	25	8.40	5.45	1.00	8.11	5.32	1.11	7.83	5.19	1.22	7.54	5.05	1.33
19.0	27	8.59	5.44	1.01	8.30	5.32	1.12	8.00	5.18	1.22	7.70	5.05	1.33
19.5	27	8.68	5.43	1.01	8.39	5.31	1.12	8.09	5.17	1.22	7.79	5.05	1.33
22.0	30	9.15	5.38	1.01	8.84	5.25	1.12	8.52	5.13	1.23	8.21	4.99	1.34
24.0	32	9.53	5.31	1.03	9.20	5.19	1.13	8.87	5.06	1.25	8.54	4.92	1.35

Heating

Symbol
 AFR: Air flow rate (m³/min)
 BF: Bypass factor
 EWB: Entering wet-bulb temperature (°C WB)
 EDB: Entering dry-bulb temperature (°C DB)
 TC: Maximum total cooling/heating capacity (kW)
 SHC: Sensible heat capacity (kW)
 CPI: Coefficient of the power input
 PI: Power input (kW)
 compressor + indoor and outdoor fan motors

Indoor	Outdoor temperature (°C WB)																		
	-15.0			-10.0			-5.0			0.0			6.0			10.0			
	TC	CPI	PI	TC	CPI	PI	TC	CPI	PI	TC	CPI	PI	TC	CPI	PI	TC	CPI	PI	
°CWB	°CDB	kW	—	kW	—	kW	—	kW	—	kW	—	kW	—	kW	—	kW	—	kW	—
16	6.44	0.92	7.09	0.99	7.50	1.02	7.79	1.06	8.00	1.12	8.21	1.17	8.33	1.24	8.40	1.29	8.47	1.36	
18	6.43	0.98	7.38	1.03	7.64	1.07	7.78	1.10	8.00	1.17	8.21	1.24	8.33	1.31	8.39	1.38	8.46	1.45	
20	6.42	1.01	7.67	1.07	7.92	1.12	7.77	1.14	8.00	1.22	8.21	1.29	8.33	1.36	8.40	1.43	8.47	1.50	
21	6.42	1.02	7.67	1.09	7.92	1.13	7.77	1.16	8.00	1.24	8.21	1.31	8.33	1.38	8.40	1.45	8.47	1.52	
22	6.42	1.05	7.96	1.11	7.92	1.15	7.76	1.19	8.00	1.27	8.21	1.34	8.33	1.41	8.40	1.48	8.47	1.55	
24	6.41	1.09	7.95	1.15	7.91	1.20	7.76	1.25	8.00	1.32	8.21	1.39	8.33	1.46	8.40	1.53	8.47	1.58	

- Notes
- The ratings shown are net capacities which include a deduction for indoor fan motor heat.
 - = Maximum at standard conditions
□ = Rated capacity and rated coefficient of the power input
The maximum capacity is not guaranteed except at standard conditions.
 - SHC is based on indoor units EWB & EDB.
SHC* for other dry-bulb temperatures = SHC + SHC*
SHC* = SHC correction for other dry-bulb temperatures
= 0.02 × AFR (m³/min) × (1-BF) × (DB* - EDB)
 - The capacities are based on the following conditions:
Outdoor air: 85% RH
However, the outdoor ambient condition of the rated capacity during heating operation is 7°C DB / 6°C WB.
Corresponding refrigerant piping length: 5.0 m
Level difference: 0m
 - CPI is a percentage value compared to the rated value which is 1.00.
 - The error rate for this value is less than 5% and depends on the indoor unit type.
 - The heating performance takes into account the drop that occurs during defrost operation.
 - The air flow rate and bypass factor are mentioned in the table.

Pair	FC09071F	FC0707F	FR071C	FR071C	FR071C	FR071C	FR071C	FR071C
AFR (BF)	21.2 (0.2)	18.0 (0.14)	20.5 (0.08)	18.0 (0.13)	18.0 (0.16)	23.0 (0.13)	20.5 (0.24)	18.0 (0.13)

Pair	FC035F x 2	FR035C x 2	FR035C x 2	FR035C x 2	FR035F x 2	FR035F x 2	FR035A x 2
AFR (BF)	12.5 x 2 (0.4 x 2)	16 x 2 (0.15 x 2)	14 x 2 (0.17 x 2)	10 x 2 (0.25 x 2)	8.7 x 2 (0.17 x 2)	15 x 2 (0.08 x 2)	8.7 x 2 (0.17 x 2)

Pair	FC09071F	FC0707F	FR071C	FR071C	FR071C	FR071C	FR071C	FR071C	FR071C
Cooling	1.66	2.01	1.94	1.78	2.00	2.02	1.78	1.67	1.89
Heating	1.56	1.89	2.05	1.82	2.03	2.06	1.82	1.68	1.87

Pair	FC035F x 2	FR035C x 2	FR035C x 2	FR035C x 2	FR035F x 2	FR035F x 2	FR035A x 2
Cooling	2.04	1.98	2.24	2.02	2.23	2.01	2.23
Heating	1.92	2.16	2.70	1.88	2.55	2.08	2.55

3D076748F

RZQG100L9V1 RZQG100L8Y1

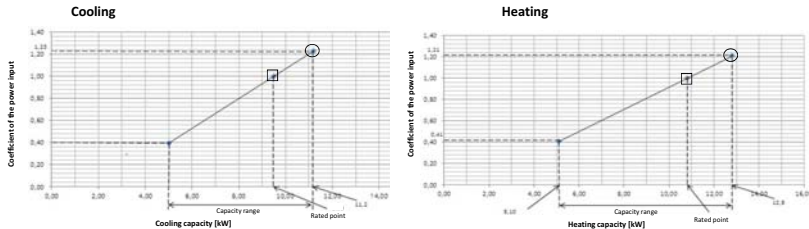

Indoor	Outdoor temperature (°C DB)												
	25			30			35			40			
	TC	SHC	CPI	TC	SHC	CPI	TC	SHC	CPI	TC	SHC	CPI	
°CWB	°CDB	kW	kW	—	kW	kW	—	kW	kW	—	kW	kW	—
16.0	22	11.20	7.61	1.01	10.85	7.44	1.11	10.50	7.29	1.22	10.11	7.09	1.32
18.0	25	11.80	7.59	1.01	11.37	7.49	1.12	11.00	7.27	1.23	10.55	7.09	1.33
19.0	27	12.00	7.57	1.02	11.62	7.44	1.12	11.20	7.26	1.23	10.80	7.04	1.33
19.5	27	12.15	7.50	1.02	11.74	7.37	1.13	11.43	7.24	1.23	10.91	7.04	1.34
22.0	30	12.80	7.52	1.02	12.37	7.36	1.13	11.90	7.16	1.24	11.52	7.03	1.35
24.0	32	13.30	7.42	1.03	12.88	7.27	1.14	12.40	7.06	1.25	11.97	6.91	1.36

Heating

Symbol
 AFR: Air flow rate (m³/min)
 BF: Bypass factor
 EWB: Entering wet-bulb temperature (°C WB)
 EDB: Entering dry-bulb temperature (°C DB)
 TC: Maximum total cooling/heating capacity (kW)
 SHC: Sensible heat capacity (kW)
 CPI: Coefficient of the power input
 PI: Power input (kW)
 compressor + indoor and outdoor fan motors

Indoor	Outdoor temperature (°C WB)																		
	-15.0			-10.0			-5.0			0.0			6.0			10.0			
	TC	CPI	PI	TC	CPI	PI	TC	CPI	PI	TC	CPI	PI	TC	CPI	PI	TC	CPI	PI	
°CWB	°CDB	kW	—	kW	—	kW	—	kW	—	kW	—	kW	—	kW	—	kW	—	kW	—
16	8.96	0.92	9.45	0.96	10.1	1.02	10.4	1.06	10.6	1.12	10.8	1.17	10.8	1.24	10.9	1.31	10.9	1.38	
18	8.67	0.97	9.44	1.02	10.0	1.06	10.3	1.09	10.8	1.16	10.8	1.23	10.9	1.30	10.9	1.37	10.9	1.44	
20	8.56	1.00	9.43	1.06	10.0	1.11	10.3	1.13	10.8	1.21	10.8	1.27	10.9	1.34	10.9	1.41	10.9	1.48	
21	8.56	1.02	9.42	1.08	10.0	1.12	10.3	1.15	10.8	1.22	10.8	1.28	10.9	1.35	10.9	1.42	10.9	1.49	
22	8.65	1.04	9.42	1.10	10.0	1.14	10.3	1.18	10.8	1.26	10.8	1.32	10.9	1.39	10.9	1.46	10.9	1.53	
24	8.64	1.08	9.41	1.14	10.0	1.19	10.3	1.22	10.8	1.31	10.8	1.37	10.9	1.44	10.9	1.51	10.9	1.58	

- Notes
- The ratings shown are net capacities which include a deduction for indoor fan motor heat.
 - = Maximum at standard conditions
□ = Rated capacity and rated coefficient of the power input
The maximum capacity is not guaranteed except at standard conditions.
 - SHC is based on indoor units EWB & EDB.
SHC* for other dry-bulb temperatures = SHC + SHC*
SHC* = SHC correction for other dry-bulb temperatures
= 0.02 × AFR (m³/min) × (1-BF) × (DB* - EDB)
 - The capacities are based on the following conditions:
Outdoor air: 85% RH
However, the outdoor ambient condition of the rated capacity during heating operation is 7°C DB / 6°C WB.
Corresponding refrigerant piping length: 5.0 m
Level difference: 0m
 - CPI is a percentage value compared to the rated value which is 1.00.
 - The error rate for this value is less than 5% and depends on the indoor unit type.
 - The heating performance takes into account the drop that occurs during defrost operation.
 - The air flow rate and bypass factor are mentioned in the table.

Pair	FC090100F	FC06100F	FR06100C	FR06100C	FR06100C	FR06100C	FR06100C	FR06100C
AFR (BF)	32.3 (0.17)	32.0 (0.17)	32.0 (0.13)	20.0 (0.09)	26.0 (0.10)	28.0 (0.20)	31.0 (0.09)	29.0 (0.20)

Pair	FC035F x 2	FR035C x 2	FR035C x 2	FR035C x 2	FR035F x 2	FR035F x 2	FR035A x 2
AFR (BF)	12.5 x 2 (0.22 x 2)	16 x 2 (0.16 x 2)	15 x 2 (0.18 x 2)	12 x 2 (0.16 x 2)	16 x 2 (0.11 x 2)	15 x 2 (0.13 x 2)	16 x 2 (0.11 x 2)

Pair	FC035F x 3	FR035C x 3	FR035C x 3	FR035C x 3	FR035F x 3	FR035F x 3	FR035A x 3
AFR (BF)	12.5 x 3 (0.4 x 3)	16 x 3 (0.15 x 3)	14 x 3 (0.17 x 3)	10 x 3 (0.25 x 3)	8.7 x 3 (0.17 x 3)	15 x 3 (0.08 x 3)	8.7 x 3 (0.17 x 3)

Pair	FC090100F	FC06100F	FR06100C	FR06100C	FR06100C	FR06100C	FR06100C	FR06100C
Cooling	2.15	2.45	2.44	2.49	2.63	2.49	2.49	2.33
Heating	2.16	2.60	2.57	2.60	3.00	2.61	2.60	2.45

Pair	FC035F x 2	FR035C x 2	FR035C x 2	FR035C x 2	FR035F x 2	FR035F x 2	FR035A x 2
Cooling	2.32	2.51	2.93	2.65	2.51	2.87	2.51
Heating	2.46	2.86	3.28	2.89	2.96	2.73	2.96

Pair	FC035F x 3	FR035C x 3	FR035C x 3	FR035C x 3	FR035F x 3	FR035F x 3	FR035A x 3
Cooling	2.38	2.51	2.91	2.45	2.81	2.68	2.81
Heating	2.51	2.86	3.20	2.59	3.68	2.70	3.68

3D076749F

6 Capacity tables

6 - 2 Cooling/Heating Capacity Tables

RZQG125L9V1 RZQG125L8Y1

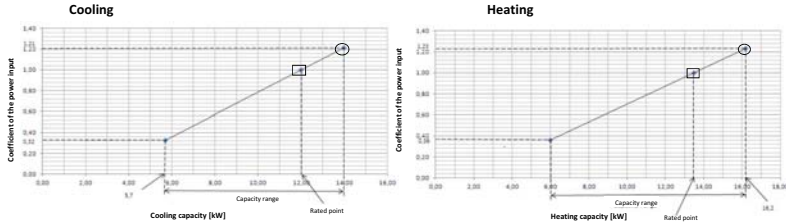

Symbols
 AFR: Air flow rate [m³/min]
 BF: Bypass factor
 EWB: Entering wet-bulb temperature (°C WB)
 EDB: Entering dry-bulb temperature (°C DB)
 TC: Maximum total cooling/heating capacity [kW]
 SHC: Sensible heat capacity [kW]
 CPI: Coefficient of the power input
 Pi: Power input [kW]
 compressor + indoor and outdoor fan motors

Indoor	Outdoor temperature (°C DB)												
	25			30			35			40			
TC	SHC	CPI	TC	SHC	CPI	TC	SHC	CPI	TC	SHC	CPI		
16.0	22	14.10	9.54	1.00	13.60	9.30	1.10	13.10	9.12	1.20	12.60	8.78	1.31
18.0	25	14.70	9.50	1.00	14.20	9.32	1.10	13.70	9.09	1.21	13.20	8.83	1.32
19.0	27	15.00	9.52	1.01	14.50	9.34	1.11	14.00	9.06	1.21	13.50	8.87	1.32
19.5	27	15.21	9.52	1.01	14.68	9.26	1.12	14.15	9.08	1.21	13.64	8.91	1.32
22.0	30	16.00	9.39	1.01	15.47	9.14	1.12	14.90	8.95	1.23	14.38	8.74	1.33
24.0	32	16.70	9.31	1.02	16.10	9.09	1.13	15.50	8.83	1.24	14.97	8.63	1.34

Indoor	Outdoor temperature (°C WB)																
	-15.0			-10.0			-5.0			0.0			6.0			10.0	
TC	CPI	TC	CPI	TC	CPI	TC	CPI	TC	CPI	TC	CPI	TC	CPI	TC	CPI	TC	CPI
16	11.0	0.94	12.1	1.00	12.9	1.00	13.2	1.06	16.2	1.13	17.5	1.20	18.1	1.26	19.5	1.32	20.9
18	11.0	1.00	12.1	1.00	12.9	1.00	13.2	1.11	16.2	1.18	17.5	1.25	18.1	1.31	19.5	1.38	20.9
20	11.0	1.02	12.0	1.00	12.9	1.12	13.2	1.15	16.2	1.22	17.5	1.30	18.1	1.35	19.5	1.42	20.9
21	11.0	1.04	12.0	1.10	12.9	1.14	13.2	1.17	16.2	1.25	17.5	1.32	18.1	1.37	19.5	1.44	20.9
22	11.0	1.06	12.0	1.12	12.9	1.16	13.2	1.20	16.2	1.28	17.4	1.34	18.1	1.39	19.4	1.46	20.9
24	11.0	1.10	12.0	1.16	12.9	1.21	13.2	1.24	16.2	1.33	17.4	1.39	18.1	1.44	19.4	1.50	20.9

- Notes
- The ratings shown are net capacities which include a deduction for indoor fan motor heat.
 - = Maximum at standard conditions
□ = Rated capacity and rated coefficient of the power input
The maximum capacity is not guaranteed except at standard conditions.
 - SHC is based on indoor units EWB & EDB.
SHC for other dry-bulb temperatures = SHC + SHC*
SHC* = SHC correction for other dry-bulb temperatures
= 0.02 x AFR (m³/min) x (1-BF) x (DB* - EDB)
 - The capacities are based on the following conditions:
Outdoor air: 85% RH
However, the outdoor ambient condition of the rated capacity during heating operation is 7°C DB / 6°C WB.
Corresponding refrigerant piping length: 5.0 m
Level difference: 0m
 - CPI is a percentage value compared to the rated value which is 1.00.
 - The error rate for this value is less than 5% and depends on the indoor unit type.
 - The heating performance takes into account the drop that occurs during defrost operation.
 - The air flow rate and bypass factor are mentioned in the table.

9. The rated power input for each model is mentioned in the table below.

Pair	FCQ0125H	FCQ0125F	FDQ125C	FDQ125C	FDQ125C	FDQ125C	FDQ125C	FDQ125C
Cooling	3.5	3.0	3.0	3.0	3.0	3.0	3.0	3.0
Heating	3.07	3.72	3.53	3.48	3.53	3.65	3.48	3.66

Pair	FCQ060F X 2	FBQ060 X 2	FDQ060 X 2	FDQ060 X 2	FDQ060 X 2	FDQ060 X 2	FDQ060 X 2
Cooling	3.14	3.28	3.67	3.61	3.75	4.10	3.75
Heating	3.64	3.74	4.11	4.10	4.20	3.85	4.20

Pair	FCQ090F X 3	FBQ090 X 3	FDQ090 X 3	FDQ090 X 3	FDQ090 X 3	FDQ090 X 3
Cooling	3.17	3.28	3.66	3.23	3.45	3.97
Heating	3.66	3.74	4.10	3.55	3.61	3.81

Pair	FCQ090F X 4	FBQ090 X 4	FDQ090 X 4	FDQ090 X 4	FDQ090 X 4	FDQ090 X 4
Cooling	3.23	3.28	3.64	3.01	3.94	3.74
Heating	3.72	3.74	4.00	3.30	4.05	3.78

3D076750F

RZQG140L9V1 RZQG140LY1

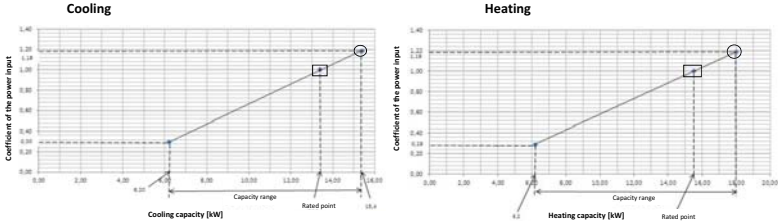

Symbols
 AFR: Air flow rate [m³/min]
 BF: Bypass factor
 EWB: Entering wet-bulb temperature (°C WB)
 EDB: Entering dry-bulb temperature (°C DB)
 TC: Maximum total cooling/heating capacity [kW]
 SHC: Sensible heat capacity [kW]
 CPI: Coefficient of the power input
 Pi: Power input [kW]
 compressor + indoor and outdoor fan motors

Indoor	Outdoor temperature (°C DB)												
	25			30			35			40			
TC	SHC	CPI	TC	SHC	CPI	TC	SHC	CPI	TC	SHC	CPI		
16.0	22	15.50	10.47	0.98	14.93	10.25	1.08	14.44	10.03	1.18	13.86	9.69	1.28
18.0	25	16.17	10.55	0.98	15.62	10.21	1.09	15.11	10.01	1.19	14.52	9.71	1.30
19.0	27	16.56	10.43	0.99	15.96	10.18	1.09	15.40	9.98	1.19	14.83	9.76	1.30
19.5	27	16.74	10.49	0.99	16.14	10.16	1.10	15.57	10.00	1.19	14.98	9.86	1.30
22.0	30	17.61	10.37	0.99	17.01	10.16	1.10	16.36	9.83	1.21	15.76	9.60	1.31
24.0	32	18.38	10.20	1.00	17.72	10.00	1.11	17.04	9.67	1.22	16.43	9.47	1.32

Indoor	Outdoor temperature (°C WB)																
	-15.0			-10.0			-5.0			0.0			6.0			10.0	
TC	CPI	TC	CPI	TC	CPI	TC	CPI	TC	CPI	TC	CPI	TC	CPI	TC	CPI	TC	CPI
16	11.6	0.91	12.7	0.97	13.6	1.00	13.9	1.03	18.0	1.09	19.4	1.16	18.0	1.14	19.4	1.21	18.0
18	11.6	0.95	12.7	1.00	13.6	1.04	13.9	1.07	18.0	1.14	19.4	1.21	18.0	1.19	19.4	1.26	18.0
20	11.6	0.99	12.7	1.05	13.5	1.09	13.9	1.11	18.0	1.19	19.4	1.26	18.0	1.24	19.4	1.30	18.0
21	11.5	1.00	12.7	1.06	13.5	1.11	13.9	1.13	18.0	1.21	19.4	1.28	18.0	1.26	19.4	1.33	18.0
22	11.5	1.02	12.7	1.08	13.5	1.12	13.9	1.16	18.0	1.24	19.4	1.30	18.0	1.28	19.4	1.35	18.0
24	11.5	1.07	12.6	1.12	13.5	1.17	13.9	1.20	18.0	1.29	19.4	1.35	18.0	1.33	19.4	1.38	18.0

- Notes
- The ratings shown are net capacities which include a deduction for indoor fan motor heat.
 - = Maximum at standard conditions
□ = Rated capacity and rated coefficient of the power input
The maximum capacity is not guaranteed except at standard conditions.
 - SHC is based on indoor units EWB & EDB.
SHC for other dry-bulb temperatures = SHC + SHC*
SHC* = SHC correction for other dry-bulb temperatures
= 0.02 x AFR (m³/min) x (1-BF) x (DB* - EDB)
 - The capacities are based on the following conditions:
Outdoor air: 85% RH
However, the outdoor ambient condition of the rated capacity during heating operation is 7°C DB / 6°C WB.
Corresponding refrigerant piping length: 5.0 m
Level difference: 0m
 - CPI is a percentage value compared to the rated value which is 1.00.
 - The error rate for this value is less than 5% and depends on the indoor unit type.
 - The heating performance takes into account the drop that occurs during defrost operation.
 - The air flow rate and bypass factor are mentioned in the table.

9. The rated power input for each model is mentioned in the table below.

Pair	FCQ0140H	FCQ0140F	FDQ140C	FDQ140C	FDQ140C	FDQ140C
Cooling	4.00	4.17	4.02	4.05	4.17	4.05
Heating	3.77	4.30	4.30	4.27	4.30	4.27

Pair	FCQ070F X 2	FBQ070 X 2	FDQ070 X 2	FDQ070 X 2	FDQ070 X 2	FDQ070 X 2
Cooling	3.94	4.11	3.75	3.58	3.81	3.59
Heating	3.71	4.34	4.70	4.47	4.68	4.47

Pair	FCQ090F X 3	FBQ090 X 3	FDQ090 X 3	FDQ090 X 3	FDQ090 X 3
Cooling	4.12	3.75	4.25	4.15	4.26
Heating	4.24	4.70	5.43	4.15	4.37

Pair	FCQ090F X 4	FBQ090 X 4	FDQ090 X 4	FDQ090 X 4	FDQ090 X 4
Cooling	4.18	3.75	4.23	3.83	3.38
Heating	4.30	4.70	5.33	3.81	3.85

3D076751F

6 Capacity tables

6 - 3 Capacity Correction Factor

6

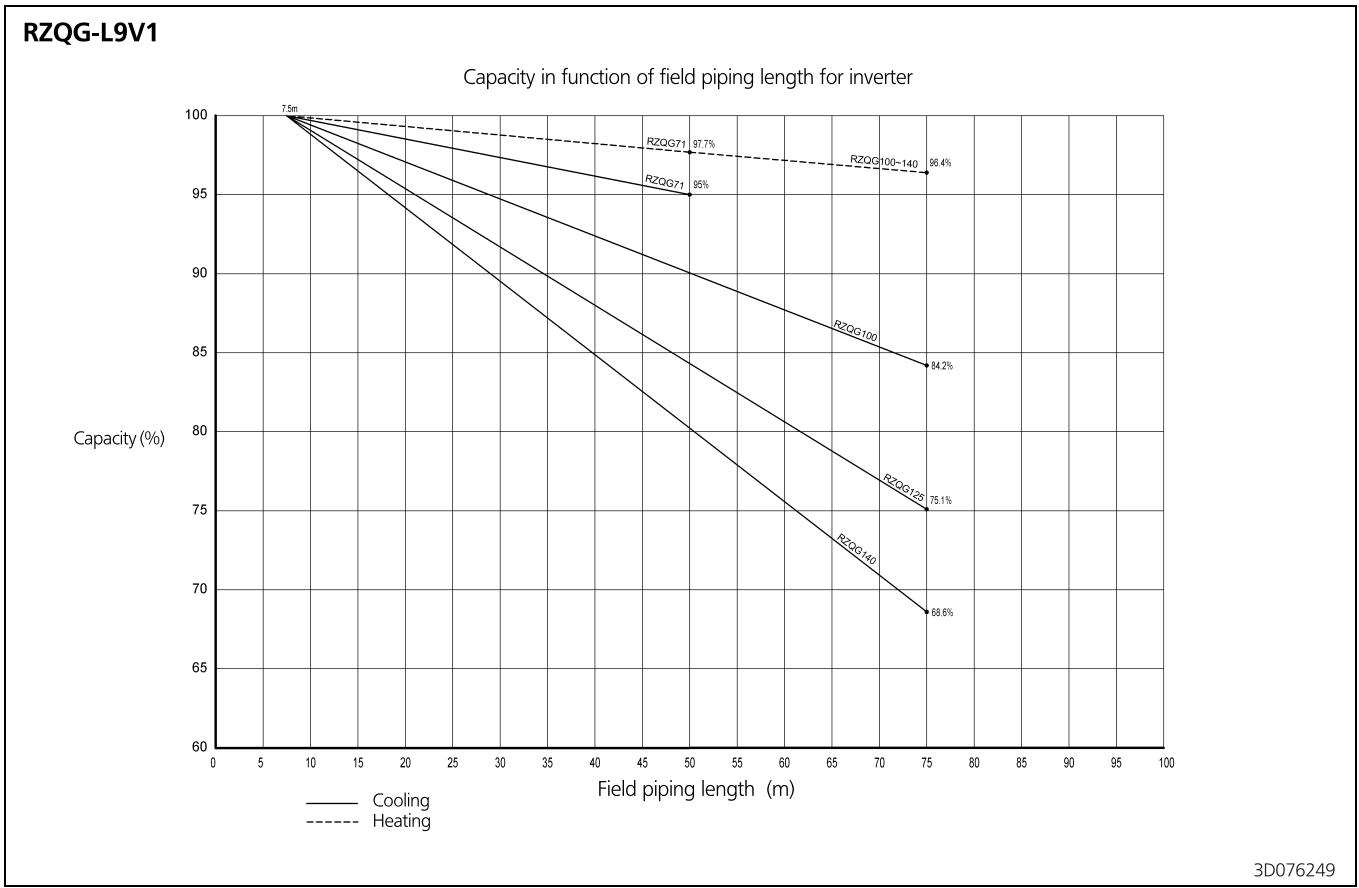

7 Dimensional drawings

7 - 1 Dimensional Drawings

RZQG71L9V1

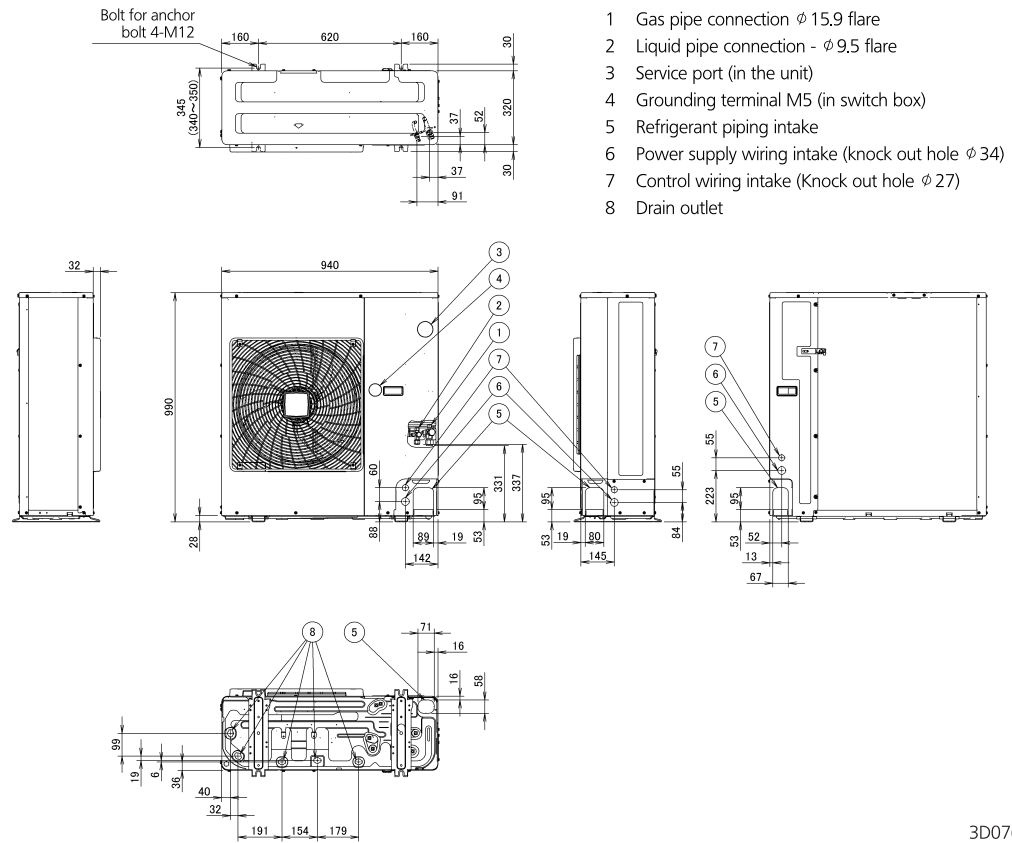

RZQG100-140L9V1

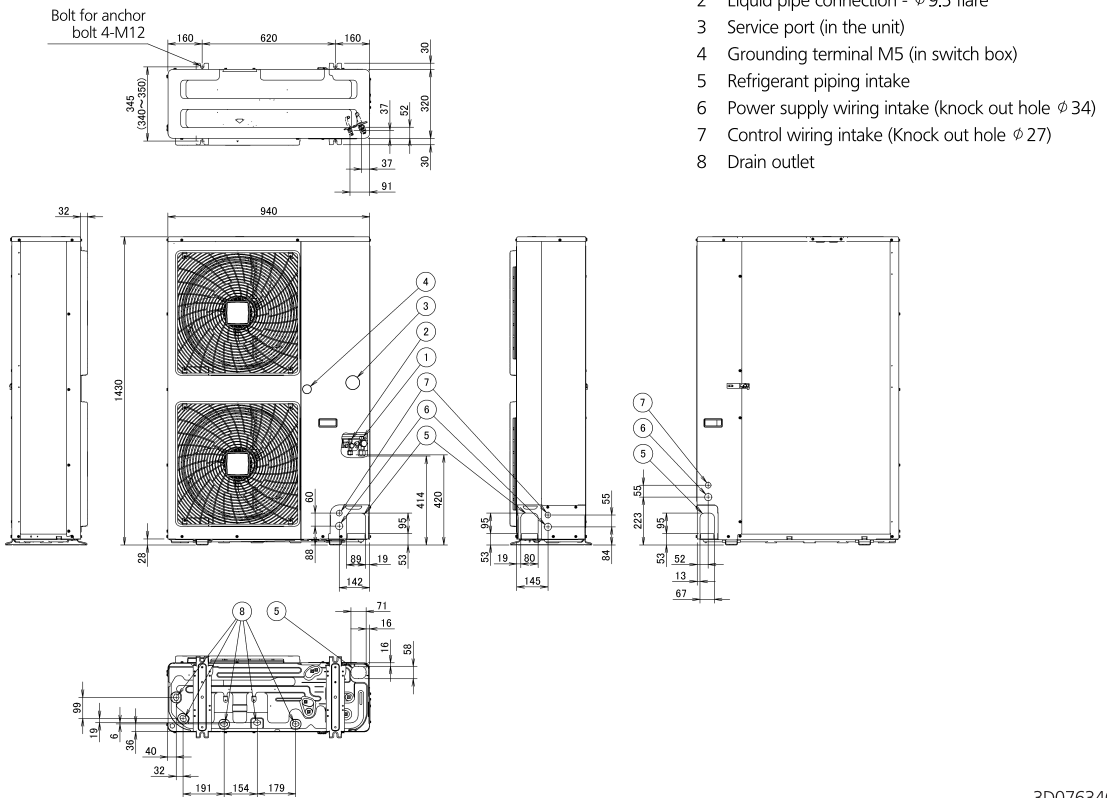

8 Centre of gravity

8 - 1 Centre of Gravity

RZQG71L9V1

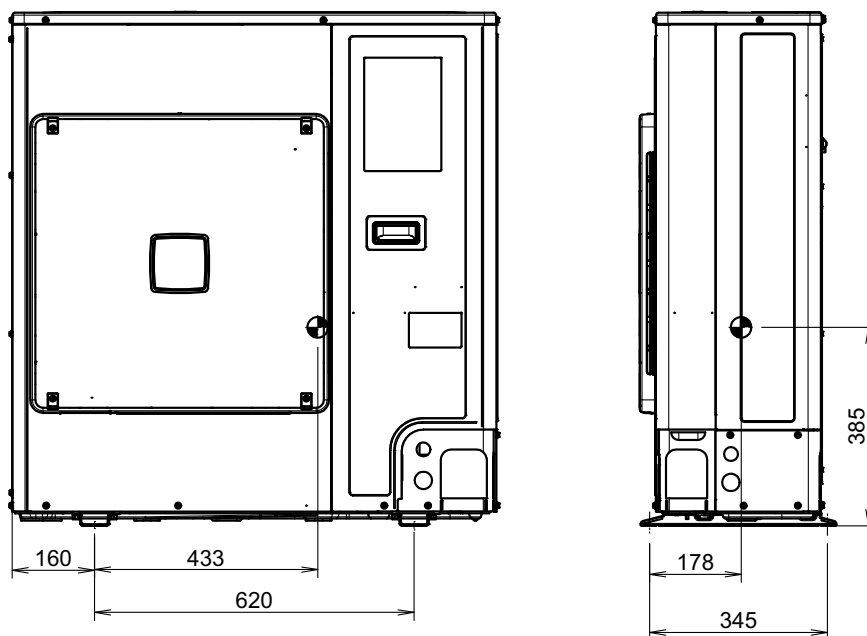

4D090895

8 Centre of gravity

8 - 1 Centre of Gravity

RZQG100-140L9V1

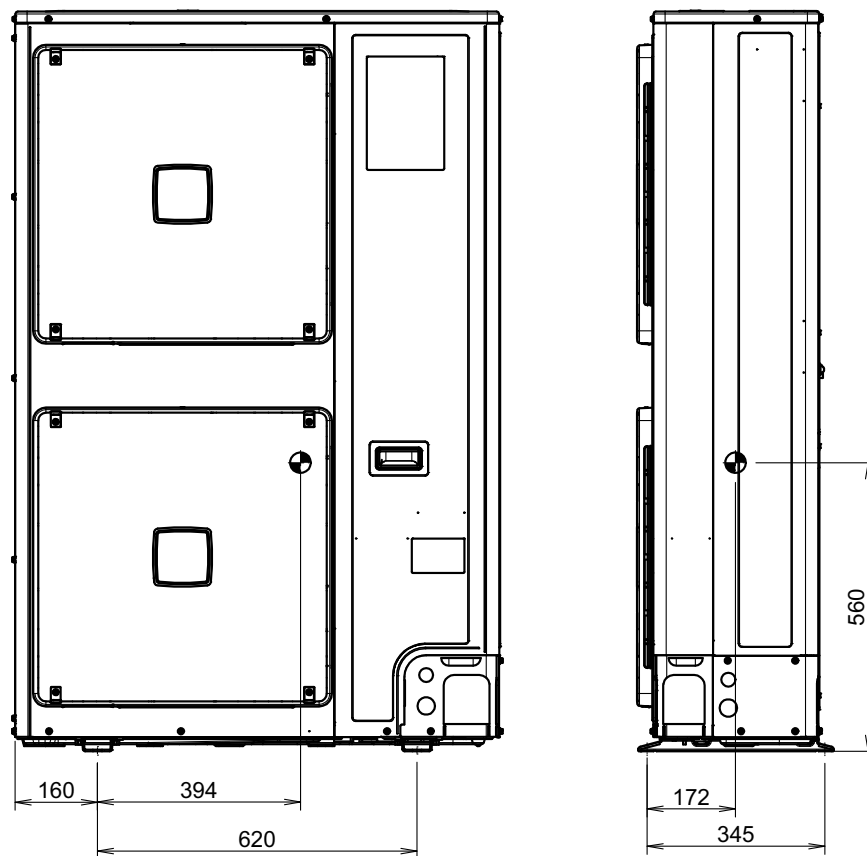

4D090897

9 Piping diagrams

9 - 1 Piping Diagrams

9

RZQG-L9V1 Pair application

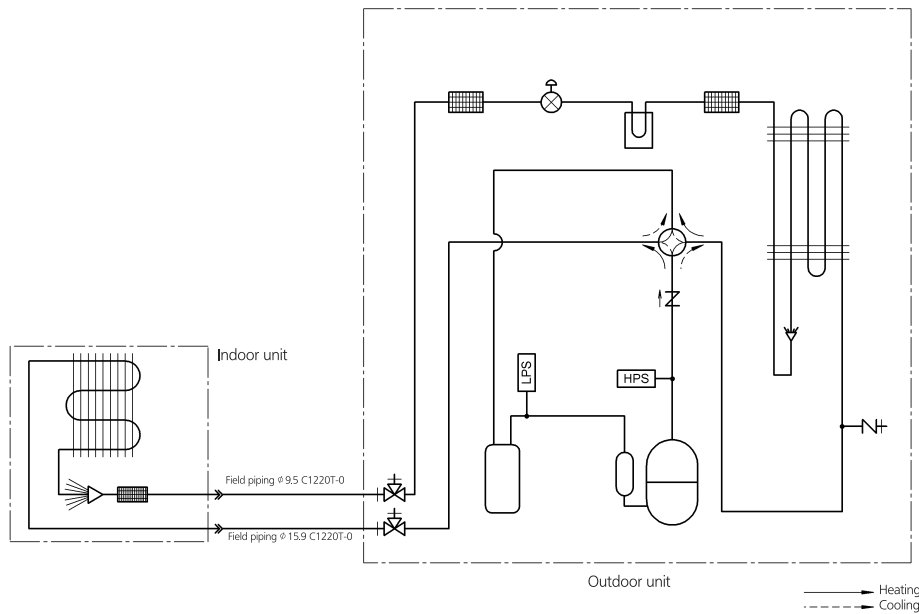

Notes:

- 1 The pipes between the branch and the indoor units should have the same size as the indoor connections.
- 2 The check valve is only present in following models: RZQG71L, RZQSG100L and RZQSG125L.

- Accumulator
- Heat exchanger
- Electronic expansion valve
- 4-way valve
-
- High pressure switch
- Low pressure switch
- Compressor
- Compressor Accumulator
- Stop valve
- Distributor
- PCB Cooling
- Check valve
- Filter

3D090340

9 Piping diagrams

9 - 2 Piping Diagram Twin Application

RZQG-L9V1 Twin application

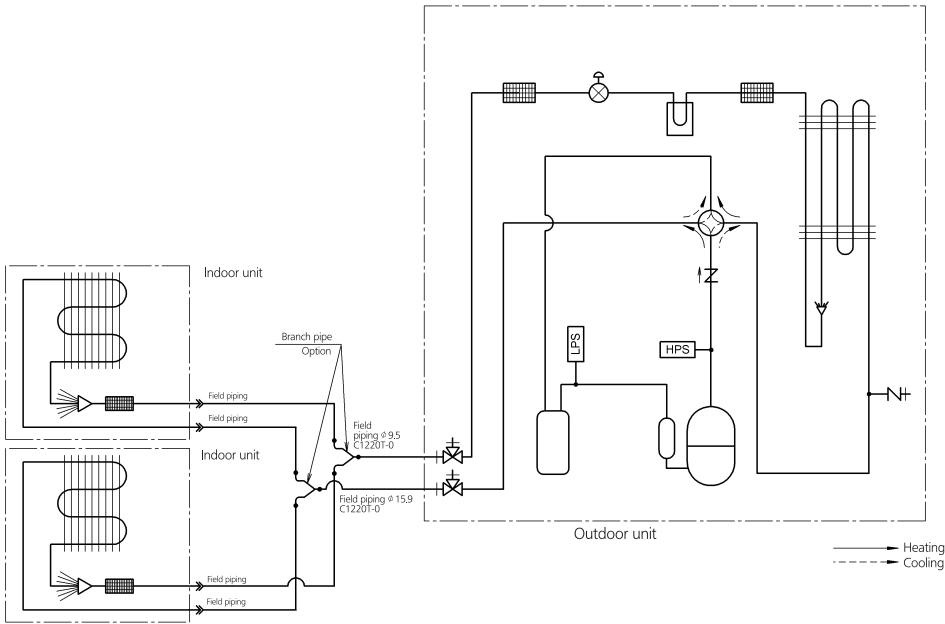

- Accumulator
- Heat exchanger
- Electronic expansion valve
- 4-way valve
- Service port 5/16" (flare)
- High pressure switch
- Low pressure switch
- Compressor
- Compressor Accumulator
- Stop valve
- Distributor
- PCB Cooling
- Check valve
- Filter

- Notes:
- 1 The pipes between the branch and the indoor units should have the same size as the indoor connections.
 - 2 The check valve is only present in following models: RZQG71L, RZQSG100L and RZQSG125L.

3D090341

9 Piping diagrams

9 - 3 Piping Diagram Triple Application

9

RZQG100-140L9V1 Triple application

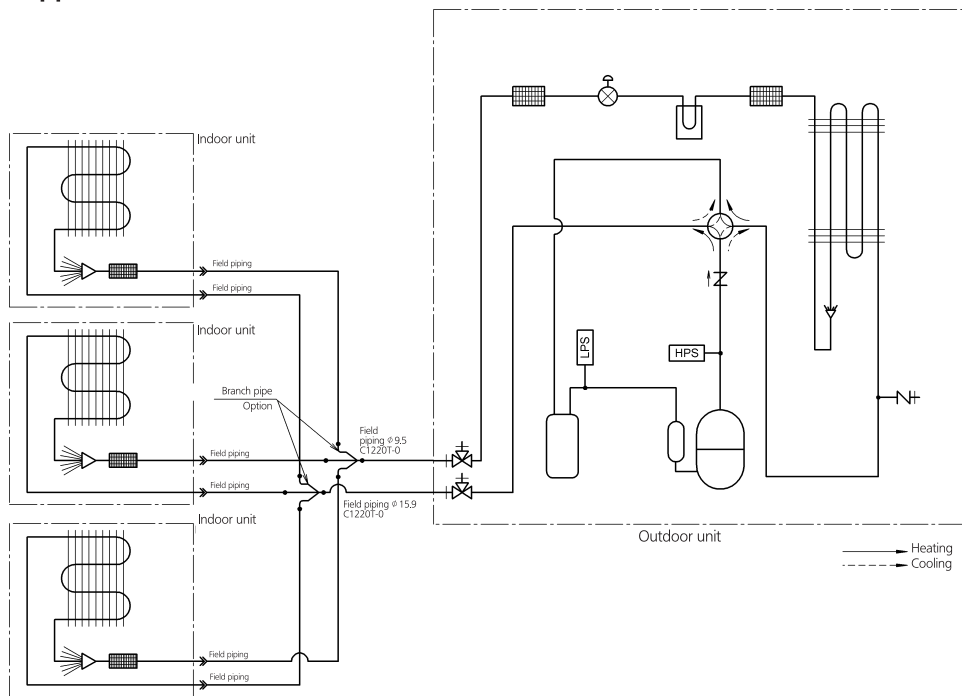

Notes:

- 1 The pipes between the branch and the indoor units should have the same size as the indoor connections.
- 2 The check valve is only present in following models: RZQSG100L and RZQSG125L.

3D090342

9 Piping diagrams

9 - 4 Piping Diagram Double Twin Application

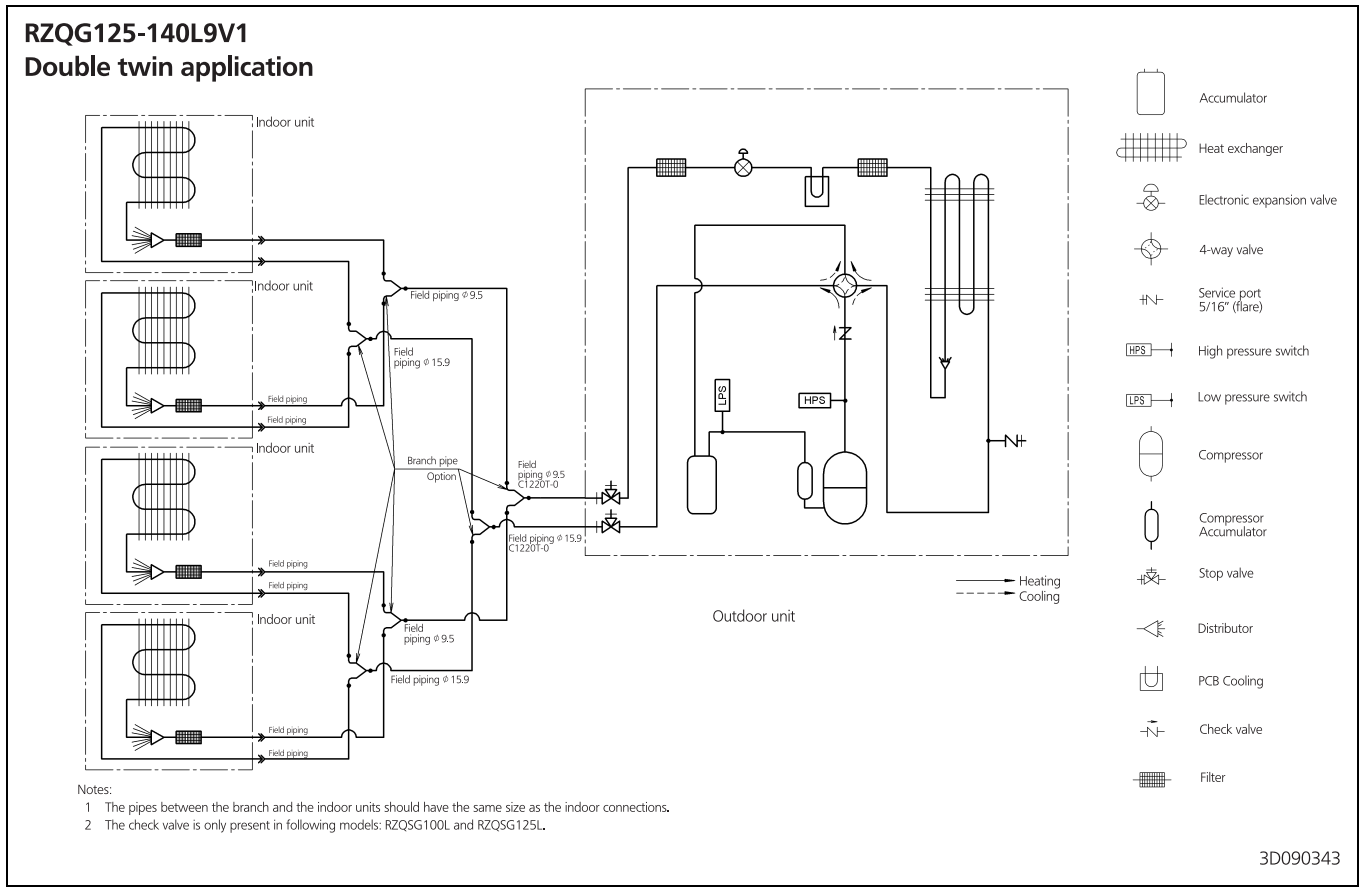

10 Wiring diagrams

10 - 1 Wiring Diagrams - Single Phase

10

RZQG71L9V1

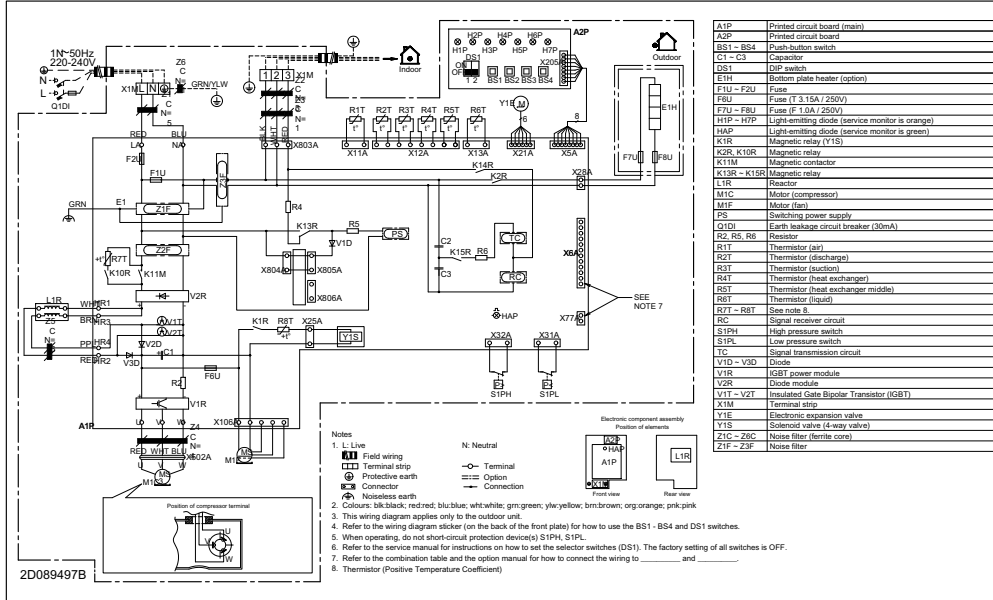

2D089497B

RZQG100-140L9V1

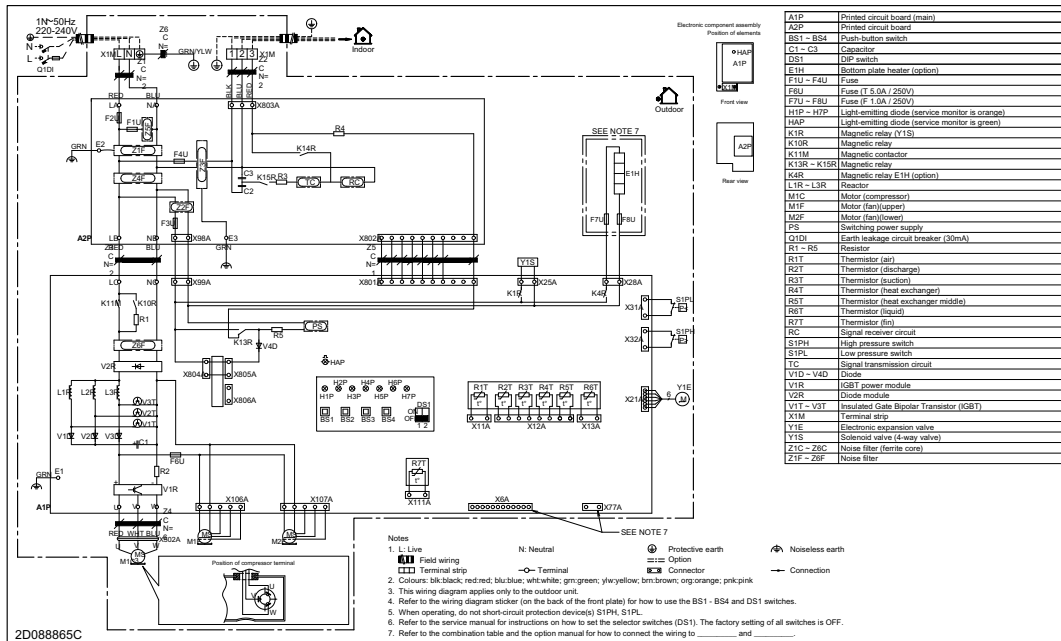

2D088865C

32

11 Sound data

11 - 1 Sound Power Spectrum

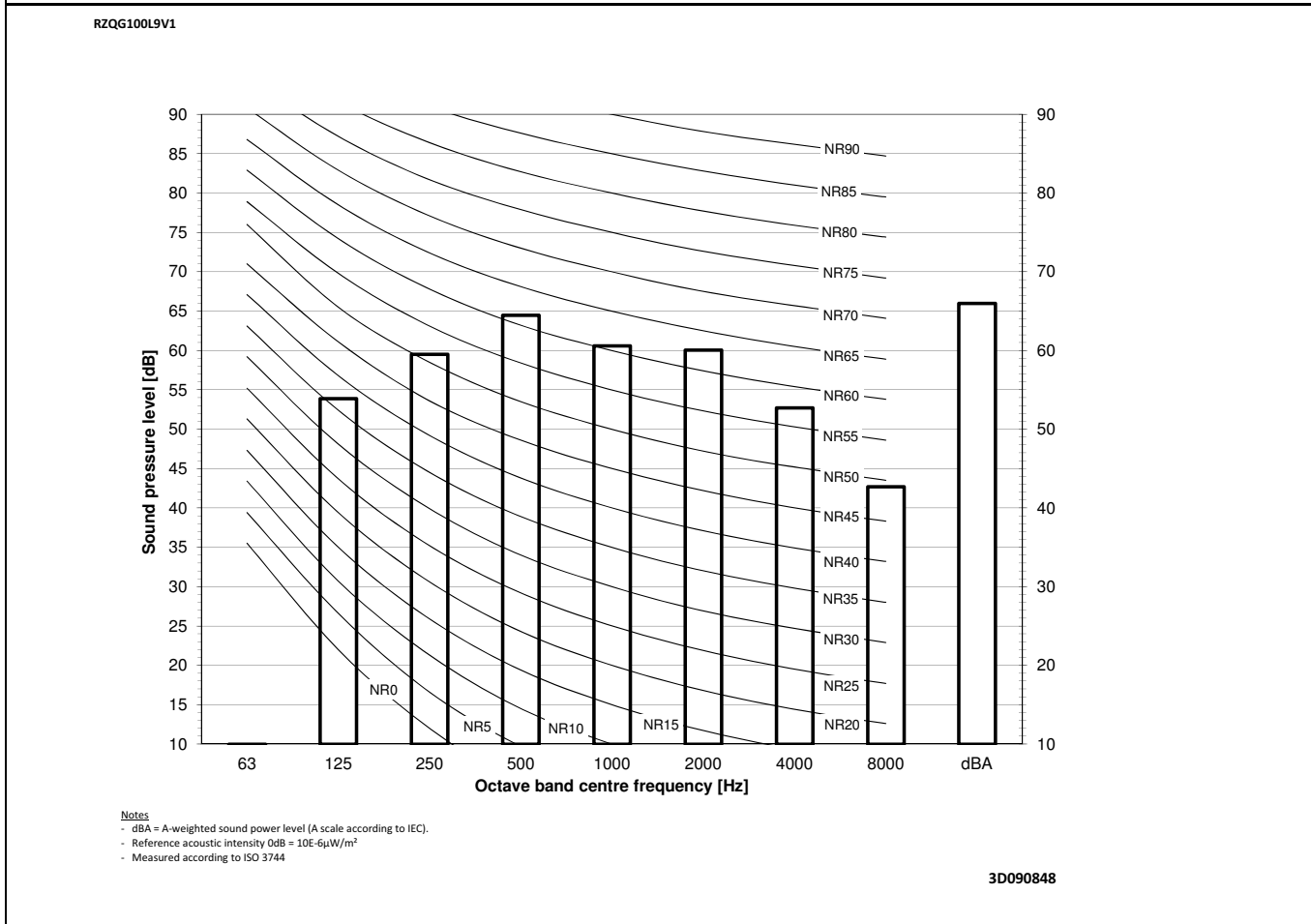
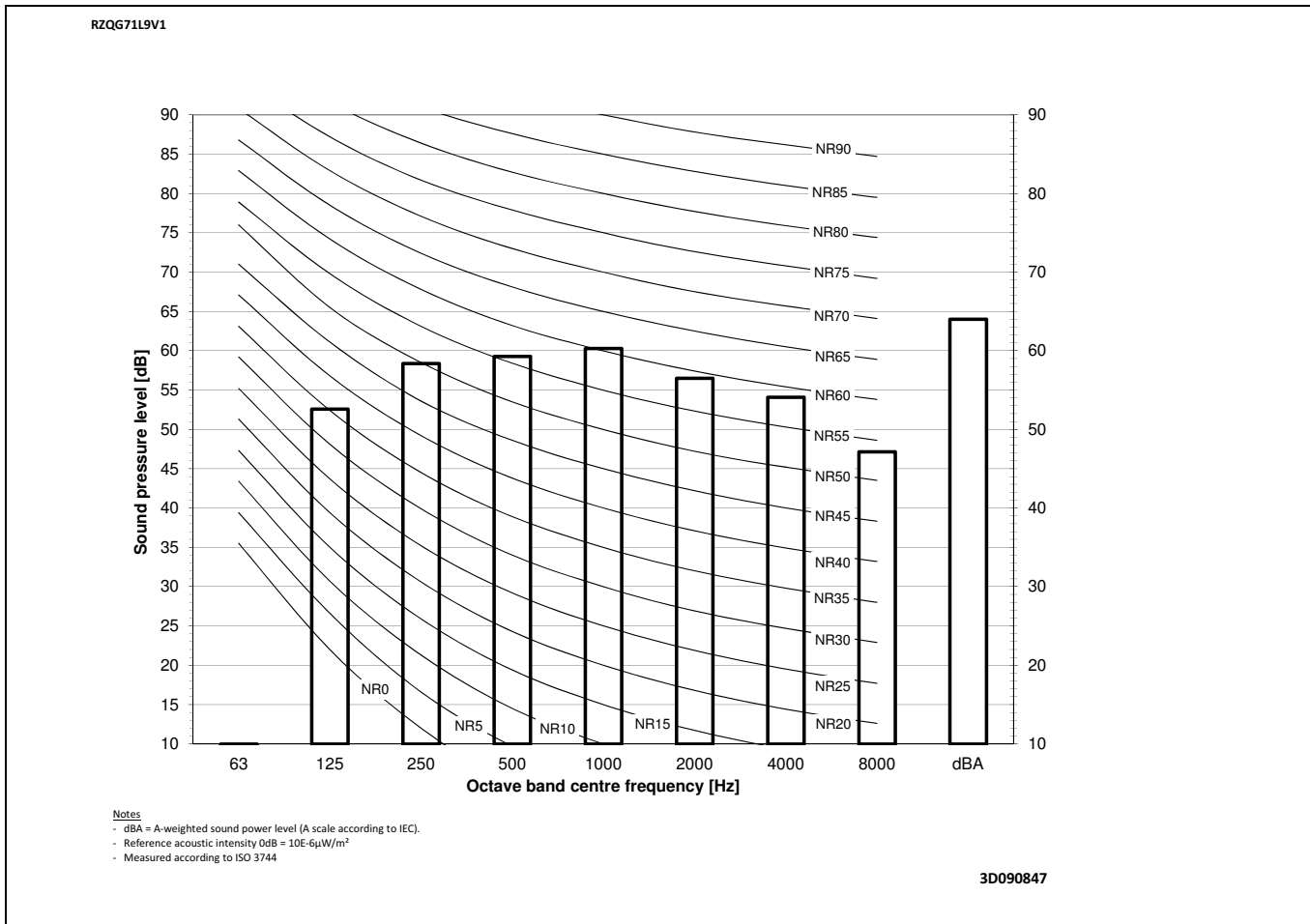

11 Sound data

11 - 1 Sound Power Spectrum

11

RZQG125L9V1

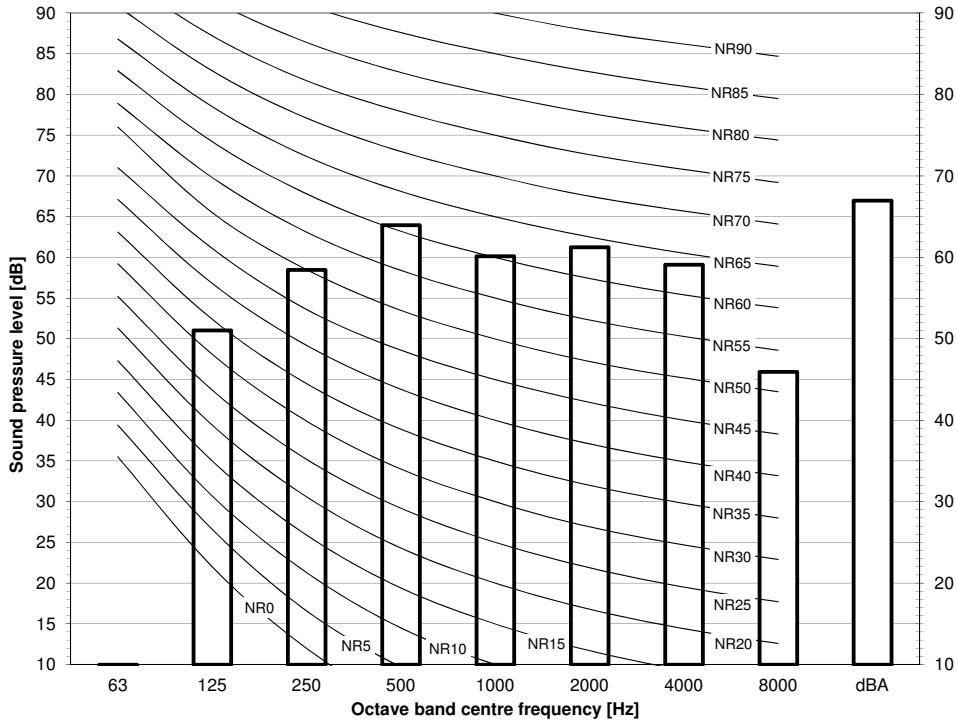

Notes
 - dBA = A-weighted sound power level (A scale according to IEC).
 - Reference acoustic intensity 0dB = 10E-6μW/m²
 - Measured according to ISO 3744

3D090849

RZQG140L9V1

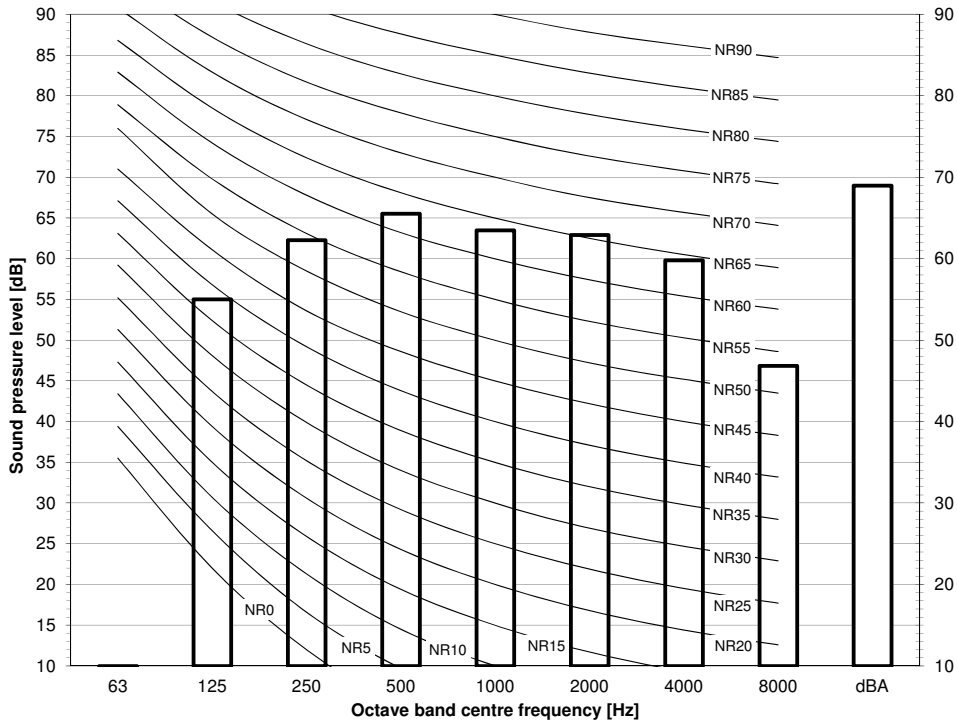

Notes
 - dBA = A-weighted sound power level (A scale according to IEC).
 - Reference acoustic intensity 0dB = 10E-6μW/m²
 - Measured according to ISO 3744

3D090850

11 Sound data

11 - 2 Sound Pressure Spectrum - Cooling

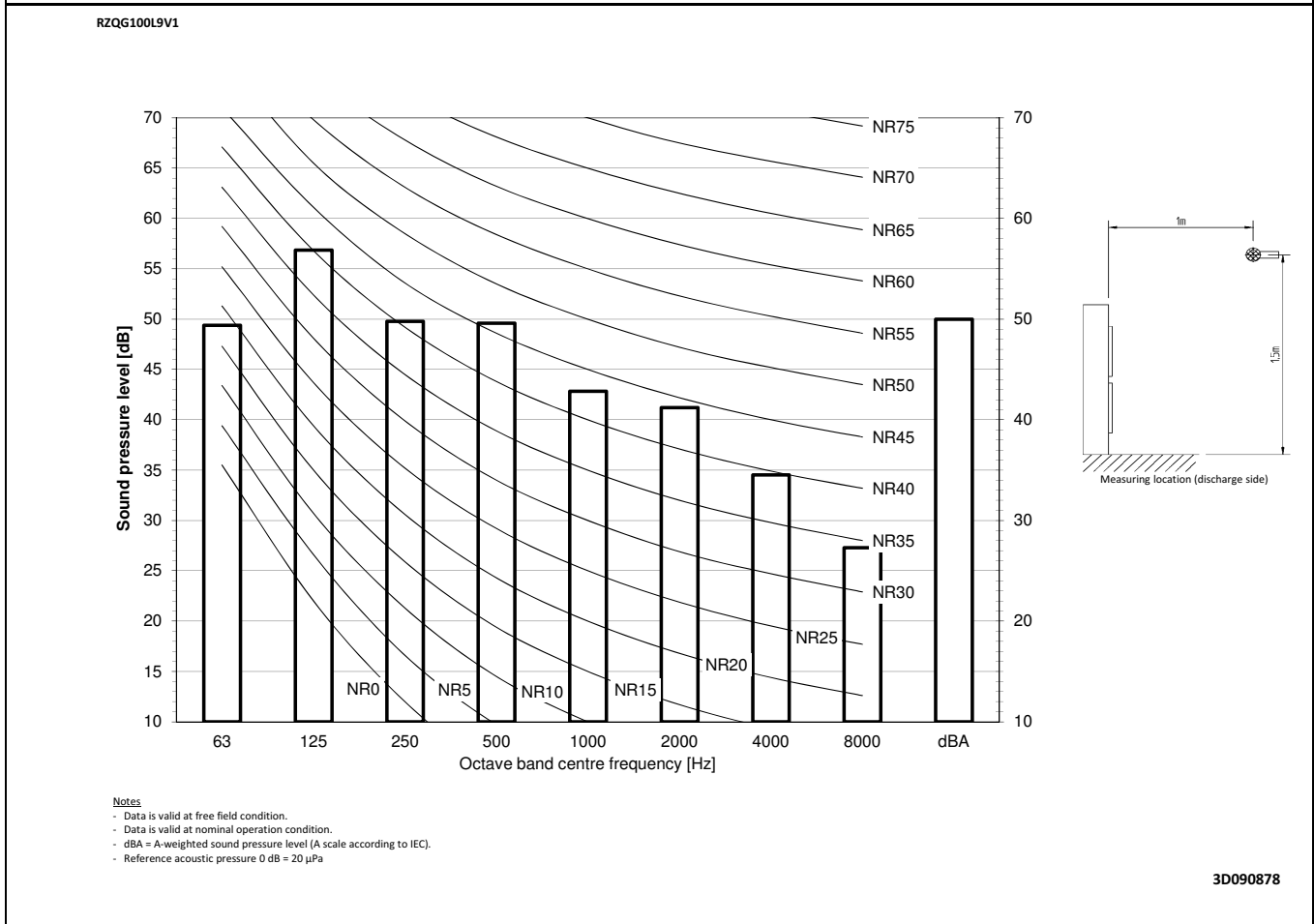
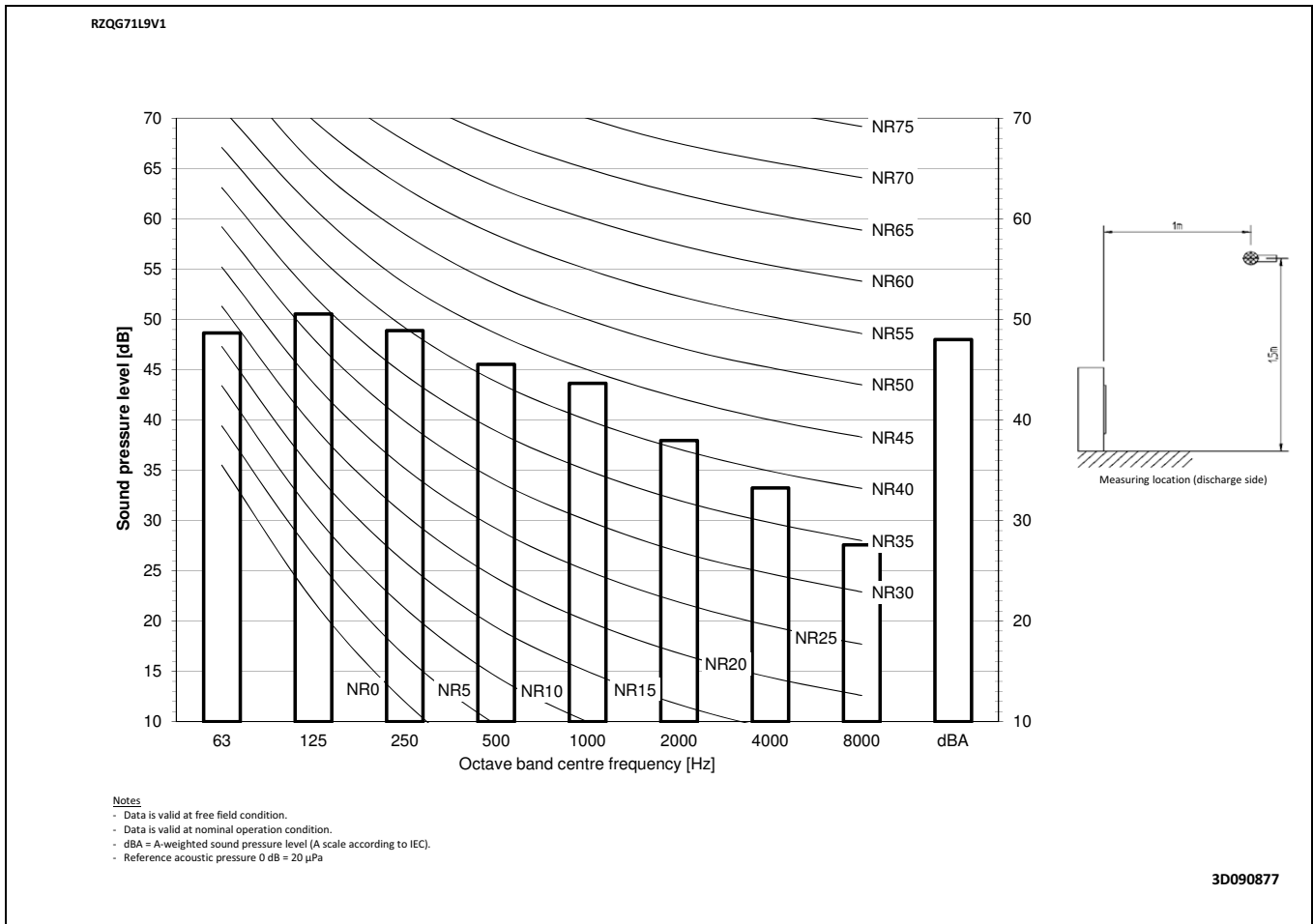

11 Sound data

11 - 2 Sound Pressure Spectrum - Cooling

11

RZQG125L9V1

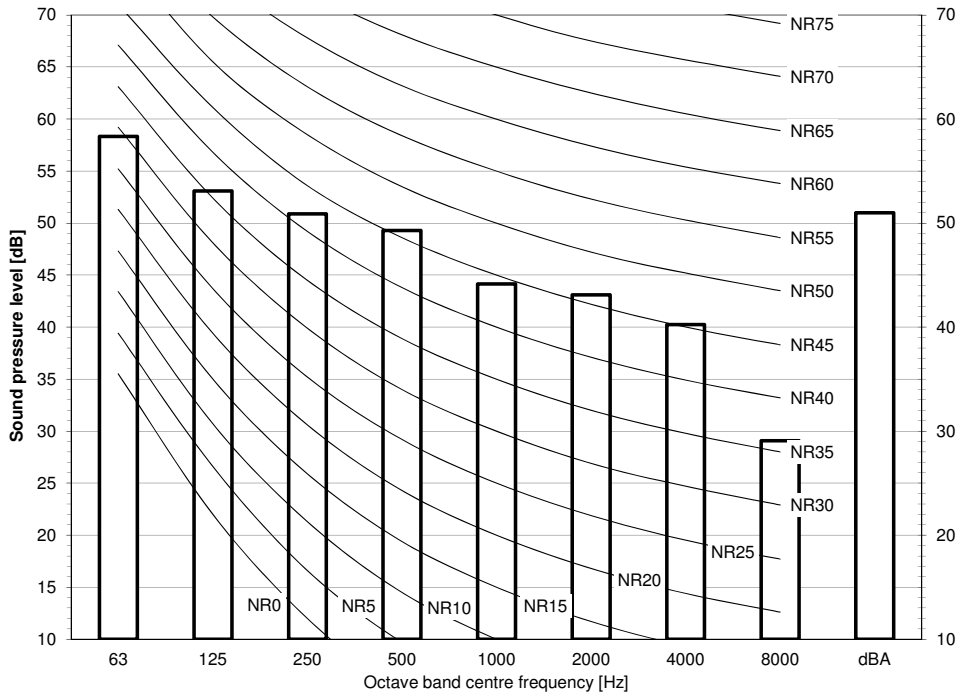

Notes

- Data is valid at free field condition.
- Data is valid at nominal operation condition.
- dBA = A-weighted sound pressure level (A scale according to IEC).
- Reference acoustic pressure 0 dB = 20 µPa

3D090879

RZQG140L9V1

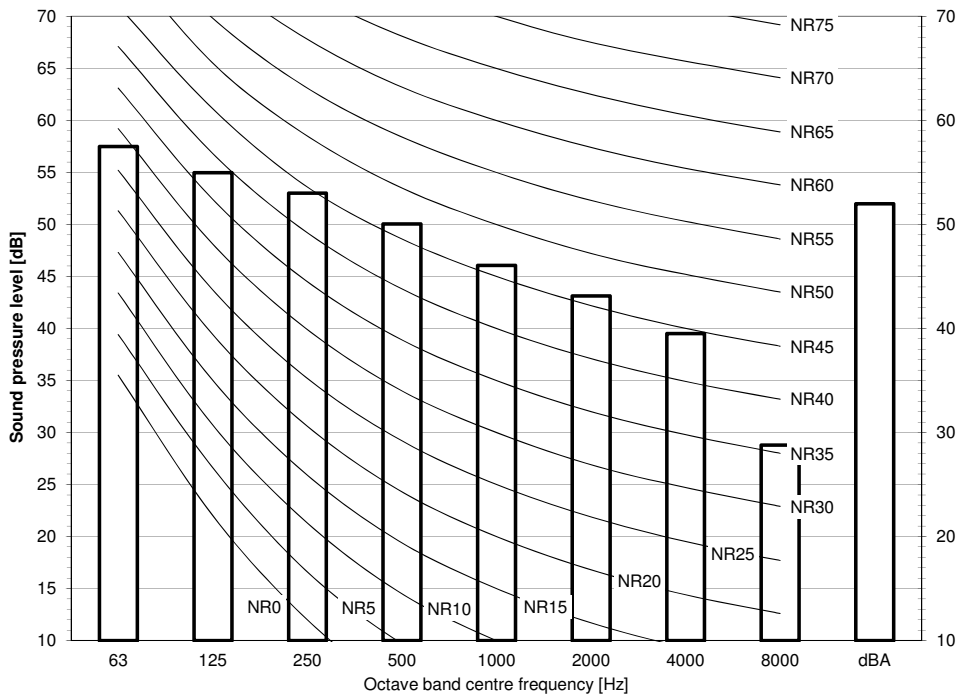

Notes

- Data is valid at free field condition.
- Data is valid at nominal operation condition.
- dBA = A-weighted sound pressure level (A scale according to IEC).
- Reference acoustic pressure 0 dB = 20 µPa

3D090880

11 Sound data

11 - 3 Sound Pressure Spectrum - Heating

RZQG71L9V1

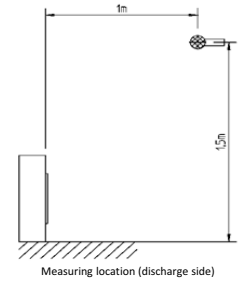
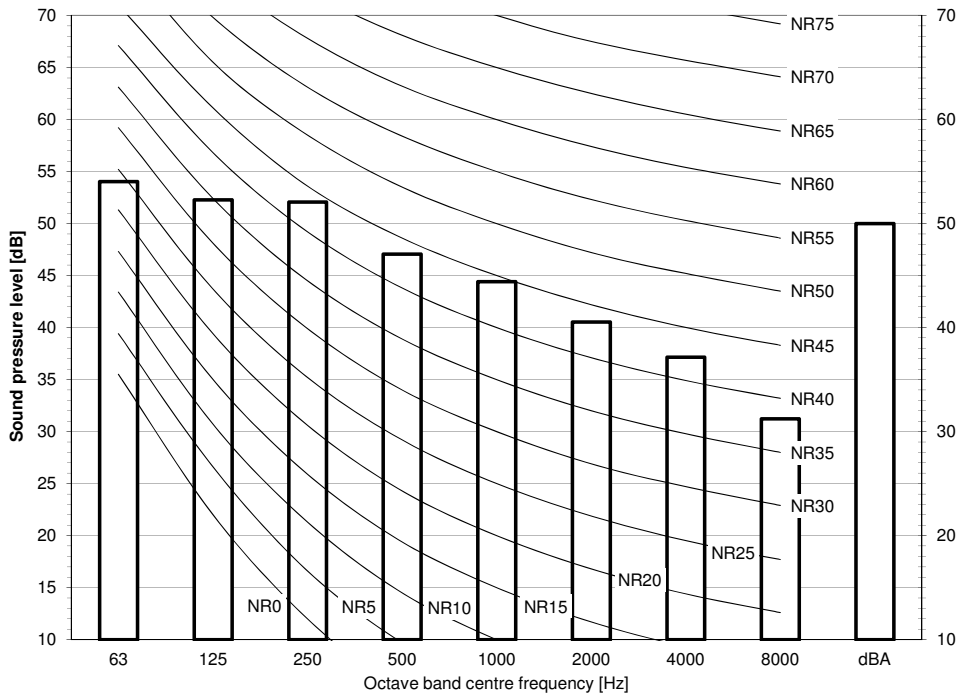

Notes
 - Data is valid at free field condition.
 - Data is valid at nominal operation condition.
 - dBA = A-weighted sound pressure level (A scale according to IEC).
 - Reference acoustic pressure 0 dB = 20 µPa

3D090867

RZQG100L9V1

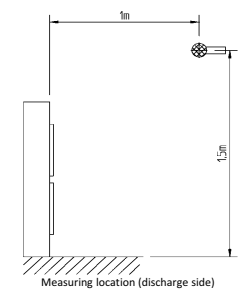
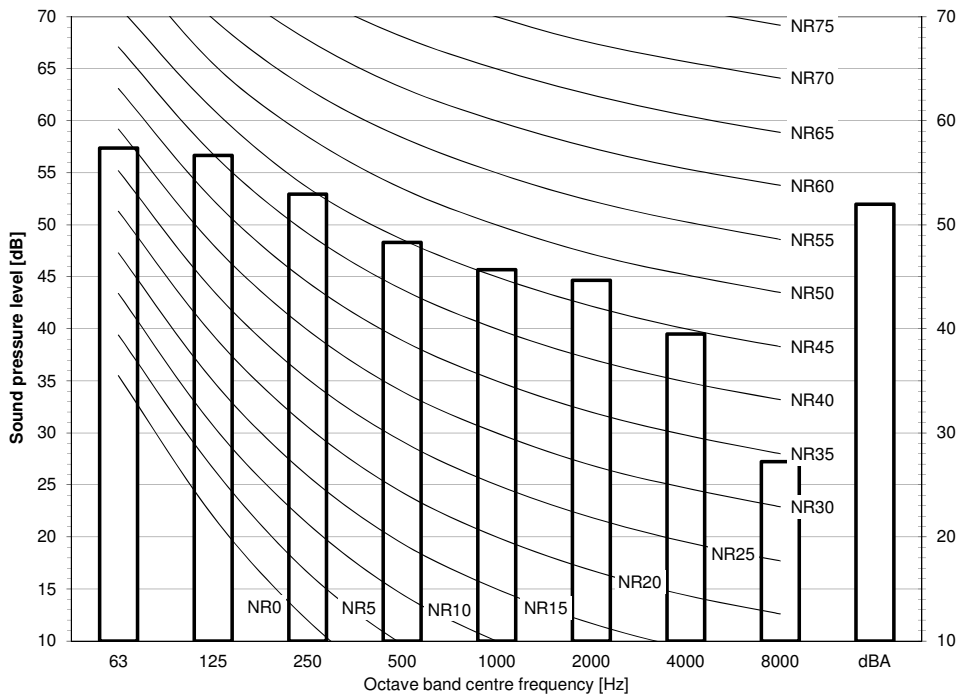

Notes
 - Data is valid at free field condition.
 - Data is valid at nominal operation condition.
 - dBA = A-weighted sound pressure level (A scale according to IEC).
 - Reference acoustic pressure 0 dB = 20 µPa

3D090868

11 Sound data

11 - 3 Sound Pressure Spectrum - Heating

RZQG125L9V1

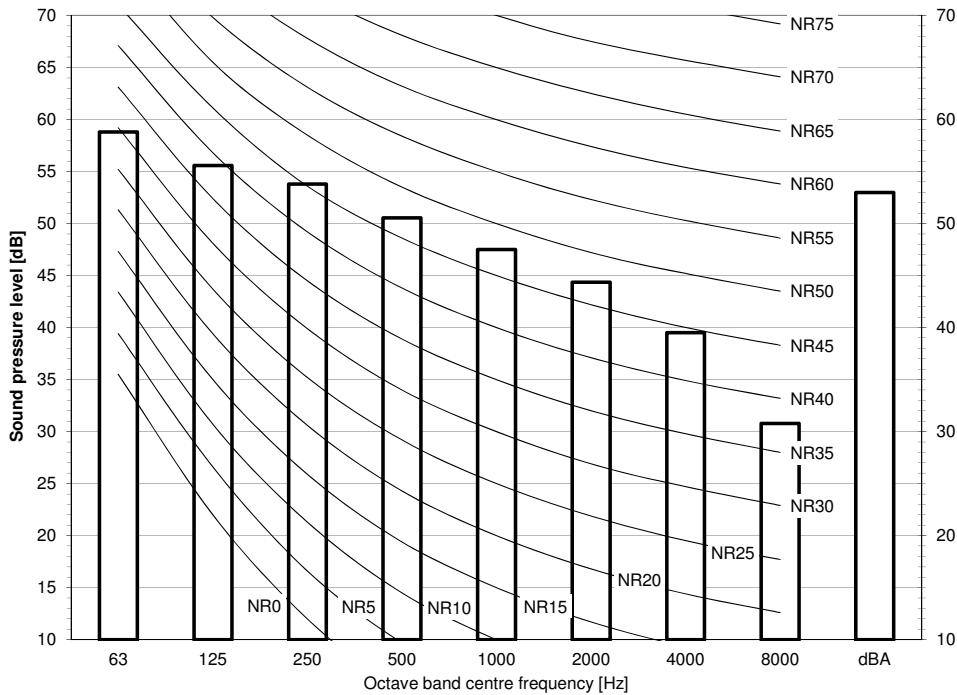

Notes

- Data is valid at free field condition.
- Data is valid at nominal operation condition.
- dBA = A-weighted sound pressure level (A scale according to IEC).
- Reference acoustic pressure 0 dB = 20 µPa

3D090869

RZQG140L9V1

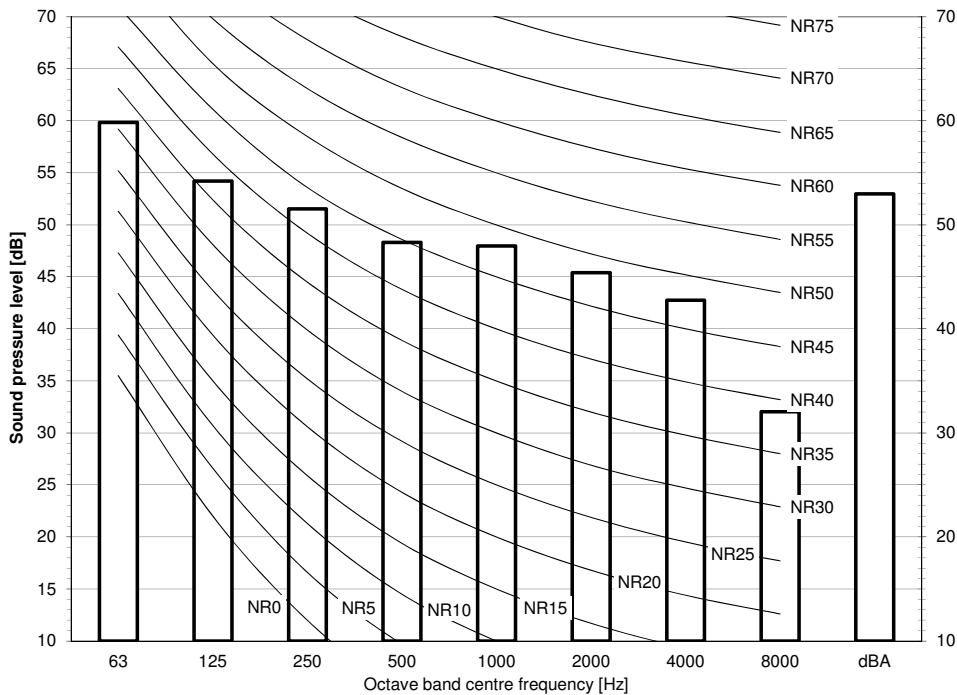

Notes

- Data is valid at free field condition.
- Data is valid at nominal operation condition.
- dBA = A-weighted sound pressure level (A scale according to IEC).
- Reference acoustic pressure 0 dB = 20 µPa

3D090870

11 Sound data

11 - 4 Sound Pressure Spectrum Quiet Mode

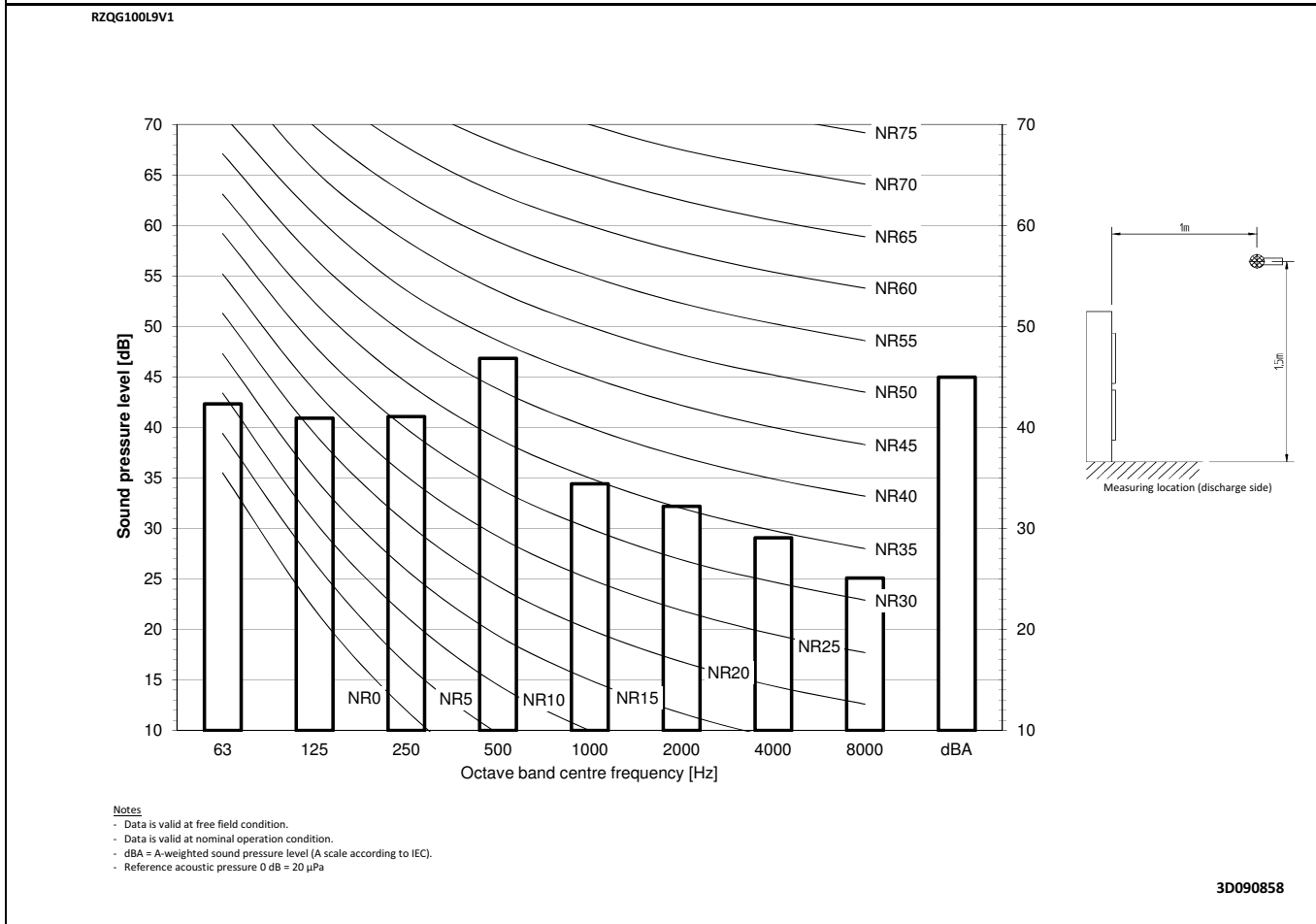
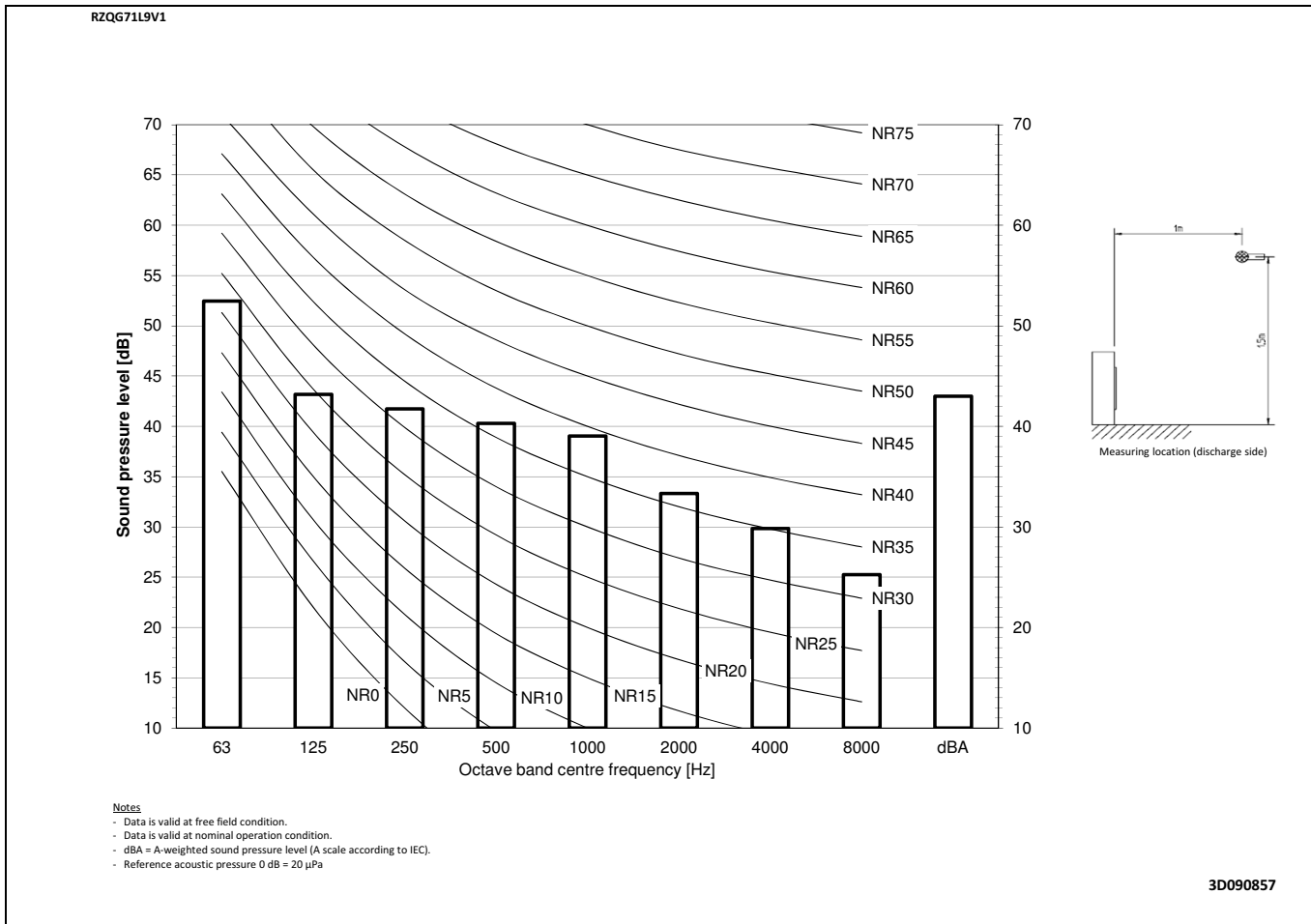

11 Sound data

11 - 4 Sound Pressure Spectrum Quiet Mode

RZQG125L9V1

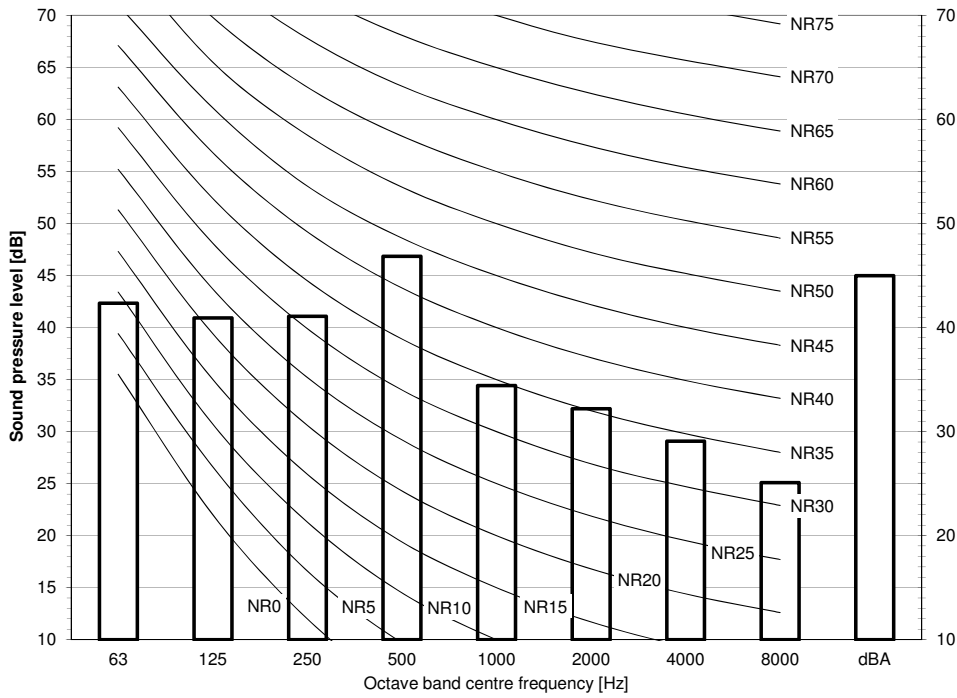

Notes

- Data is valid at free field condition.
- Data is valid at nominal operation condition.
- dBA = A-weighted sound pressure level (A scale according to IEC).
- Reference acoustic pressure 0 dB = 20 µPa

3D090859

RZQG140L9V1

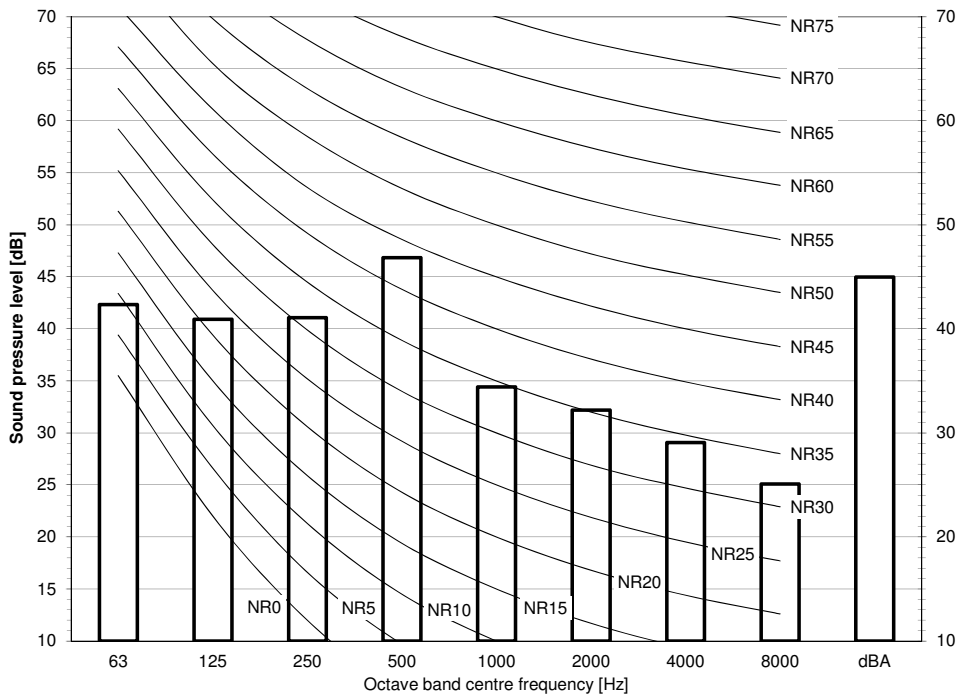

Notes

- Data is valid at free field condition.
- Data is valid at nominal operation condition.
- dBA = A-weighted sound pressure level (A scale according to IEC).
- Reference acoustic pressure 0 dB = 20 µPa

3D090860

12 Installation

12 - 1 Installation Method

RZQG-L9V1

Installation service space

The measure of these values is "mm".

(A) When there are obstacles on suction sides.

• No obstacle above

- ① Stand-alone installation
 - Obstacle on the suction side only

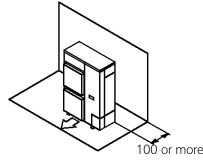

- Obstacle on both sides and suction side, too

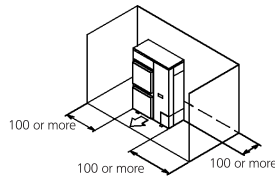

- ② Series installation (2 or more) (Note 1)
 - Obstacle on the suction side and both sides

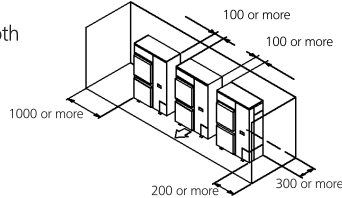

• Obstacle above, too.

- ① Stand-alone installation
 - Obstacle on the suction side, too

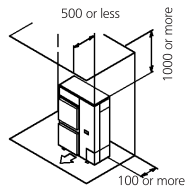

- Obstacle on both sides and suction side, too

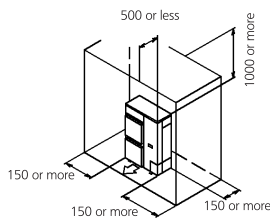

- ② Series installation (2 or more) (Note 1)
 - Obstacle on the suction side and both sides

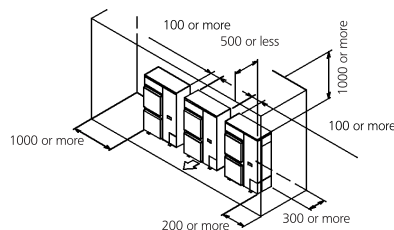

(B) When there are obstacles on discharge sides.

• No obstacle above

- ① Stand-alone installation
 - Obstacle on the discharge side only

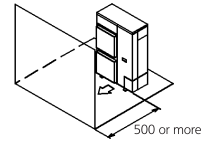

- ② Series installation (2 or more) (Note 1)
 - Obstacle on the discharge side only

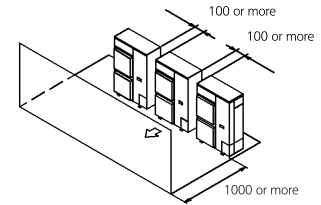

• Obstacle above, too

- ① Stand-alone installation
 - Obstacle on the discharge side only, too

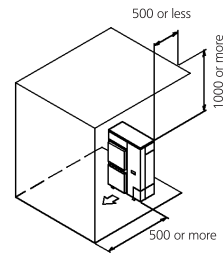

- ② Series installation (2 or more) (Note 1)
 - Obstacle on the discharge side

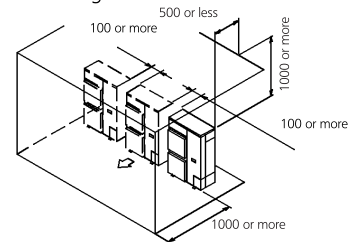

(C) When there are obstacles on both suction and discharge sides.:

Pattern 1

When the obstacles on the discharge side is higher than the unit. (L>H)
(There is no limit for the height of obstructions on the suction side.)

• No obstacle above

- ① Stand-alone installation
 - No obstacle above

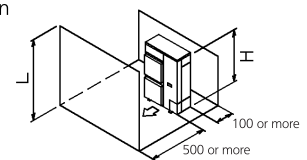

- ② Series installation (2 or more) (Note 1)
 - No obstacle above

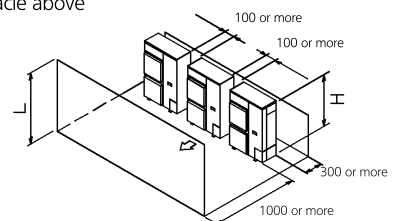

3D069554

12 Installation

12 - 1 Installation Method

RZQG-L9V1

● **Obstacle above, too**

① Stand-alone installation (Note 2)

- When there are obstacles on suction, discharge and top sides.

The relations between H, A and L are as follows.

	L	A
$L \leq H$	$L \leq 1/2 H$	750 or more
	$1/2 H < L \leq H$	1000 or more
$L > H$	Set the stand as : $L \leq H$ Refer to the column of $L \leq H$ for A	

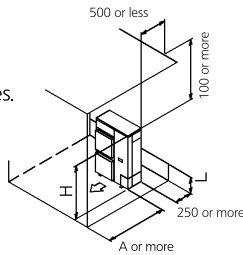

② Series installation (2 or more) (Note 1, 2)

- When there are obstacles on suction, discharge and top sides.

The relations between H, A and L are as follows.

	L	A
$L \leq H$	$L \leq 1/2 H$	1000 or more
	$1/2 H < L \leq H$	1250 or more
$L > H$	Set the stand as : $L \leq H$ Refer to the column of $L \leq H$ for A	

Limit of series installation is 2 units.

Pattern 2

When the obstacle on the discharge side is lower than the unit ($L \leq H$) (There is no limit for the height of obstructions on the suction side.)

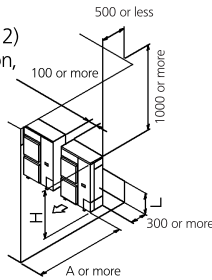

● **No obstacle above**

① Stand-alone installation

- No obstacle above

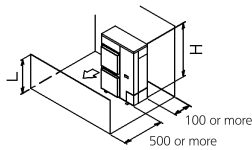

② Series installation (2 or more) (Note 1, 2)

- When there are obstacles on both suction and discharge sides.

The relations between H, A and L are as follows.

	L	A
$L \leq H$	$L \leq 1/2 H$	250 or more
	$1/2 H < L \leq H$	300 or more

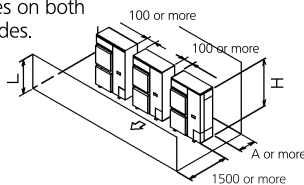

● **obstacle above**

① Stand-alone installation (Note 2)

- When there are obstacles on suction, discharge and top sides.

The relations between H, A and L are as follows.

	L	A
$L \leq H$	$L \leq 1/2 H$	100 or more
	$1/2 H < L \leq H$	200 or more
$L > H$	Set the stand as : $L \leq H$ Refer to the column of $L \leq H$ for A	

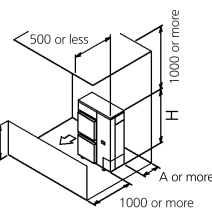

② Series installation (2 or more) (Note 1, 2)

- When there are obstacles on suction, discharge and top sides.

The relations between H, A and L are as follows.

	L	A
$L \leq H$	$L \leq 1/2 H$	250 or more
	$1/2 H < L \leq H$	300 or more
$L > H$	Set the stand as : $L \leq H$ Refer to the column of $L \leq H$ for A	

Limit of series installation is 2 units.

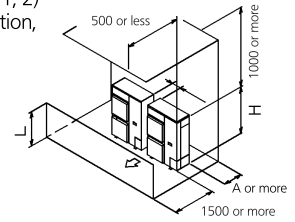

(D) Double-decker installation

① Obstacle on the discharge side. (1)

- Do not exceed two levels for stacked installation.
- Install a roof cover similar to A (field supply), as outdoor units with downward drainage are prone to dripping and freezing.
- Install the upper-level outdoor unit so that its bottom plate is a sufficient height above the roof cover. This is to prevent the buildup of ice on the underside of the bottom plate.

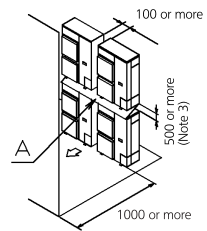

② Obstacle on the suction side. (1)

- Do not exceed two levels for stacked installation.
- Install a roof cover similar to A (field supply), as outdoor units with downward drainage are prone to dripping and freezing.
- Install the upper-level outdoor unit so that its bottom plate is a sufficient height above the roof cover. This is to prevent the buildup of ice on the underside of the bottom plate.

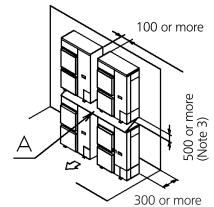

(E) Multiple rows of series installation (on the rooftop, etc.)

① One row of stand-alone installation

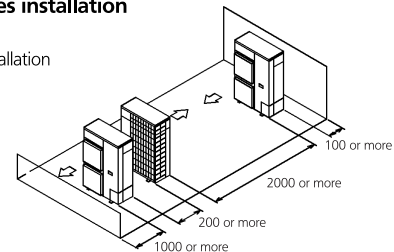

② Rows of series installation (2 or more)

The relations between H, A and L are as follows.

	L	A
$L \leq H$	$L \leq 1/2 H$	250 or more
	$1/2 H < L \leq H$	300 or more
$L > H$	Can not be installed	

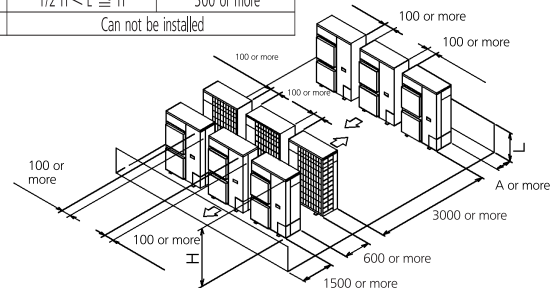

NOTES

- 1 In case of the sideways piping, make a 100mm gap between the unit above.
- 2 Close the bottom of the installation frame to prevent the discharged air from being bypassed.
- 3 It is not necessary to install a roof cover if there is no danger of drainage dripping and freezing. In this case, the space between the upper and lower outdoor units should be at least 100mm. Close off the gap between the upper and lower units so there is no re-intake of discharged air.

13 Operation range

13 - 1 Operation Range

RZQG-L9V1

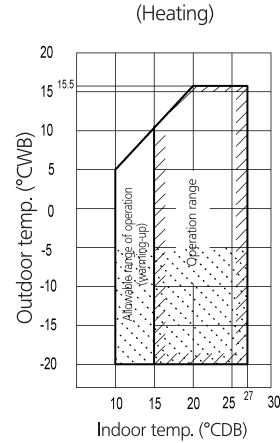
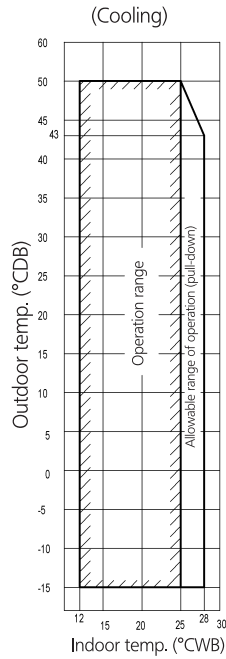

Notes:

- 1 Depending on operation and installation conditions, the indoor unit can change over to freeze-up operation (indoor de-icing).
- 2 To reduce the freeze-up operation (indoor de-icing) frequency, it is recommended to install the outdoor unit in a location not exposed to wind.
- 3 If the unit has to operate for 5 days in this operation range with 100% humidity, it is advisable to install the optional bottom plate heater.

3D076502

RZQG-L9V1 - EDP Room

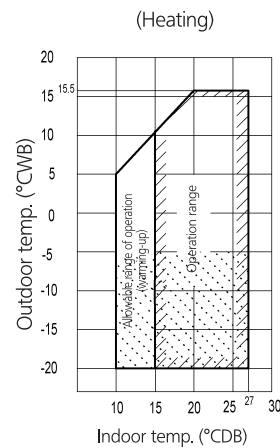
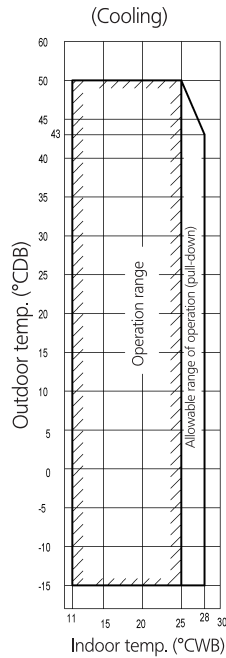

Notes:

- 1 Depending on operation and installation conditions, the indoor unit can change over to freeze-up operation (indoor de-icing).
- 2 To reduce the freeze-up operation (indoor de-icing) frequency, it is recommended to install the outdoor unit in a location not exposed to wind.
- 3 If the unit has to operate for 5 days in this operation range with 100% humidity, it is advisable to install the optional bottom plate heater.

3D076503



Daikin Europe N.V. participates in the Eurovent Certification programme for Liquid Chilling Packages (LCP), Air handling units (AHU), Fan coil units (FCU) and variable refrigerant flow systems (VRF) Check ongoing validity of certificate online: www.eurovent-certification.com or using: www.certiflash.com

The present leaflet is drawn up by way of information only and does not constitute an offer binding upon Daikin Europe N.V.. Daikin Europe N.V. has compiled the content of this leaflet to the best of its knowledge. No express or implied warranty is given for the completeness, accuracy, reliability or fitness for particular purpose of its content and the products and services presented therein. Specifications are subject to change without prior notice. Daikin Europe N.V. explicitly rejects any liability for any direct or indirect damage, in the broadest sense, arising from or related to the use and/or interpretation of this leaflet. All content is copyrighted by Daikin Europe N.V.

BARCODE

Daikin products are distributed by: