

DAIKIN

SiBE281013

R-410A

Service Manual

SkyAir

GQI-Eco Series Heat Pump R-410A 50Hz

RZQG71~140LV1B



SkyAir GQI-Eco Series Heat Pump R-410A 50Hz

1. Introduction	iv
1.1 Safety Cautions	iv
1.2 Used Icons	viii
1.3 Preface	ix
Part 1 General Information	1
1. Model Names of Indoor / Outdoor Units.....	2
2. External Appearance.....	3
Part 2 Functions.....	4
1. Functions.....	5
1.1 Indoor Unit.....	5
1.2 Outdoor Unit.....	5
Part 3 Specifications	6
1. Specifications	7
Part 4 Remote Controller	9
1. Wired Remote Controller.....	10
1.1 Applicable Models	10
1.2 Names and Functions	11
1.3 MAIN/SUB Setting when Using 2 Remote Controllers	15
1.4 Centralized Control Group No. Setting.....	16
2. Wireless Remote Controller	18
2.1 Applicable Models	18
2.2 Names and Functions	18
2.3 MAIN/SUB Setting.....	20
3. Service Mode	21
3.1 BRC1D528	21
4. Inspection Mode.....	23
4.1 BRC1D528	23
Part 5 Function and Control.....	24
1. Function of Main Components and Thermistors	25
2. Operation Flow Chart	27
2.1 Cooling / Dry Operation.....	27
2.2 Heating Operation	28
3. Function Details	29
3.1 Indoor Unit.....	29

3.2 Outdoor Unit.....	33
-----------------------	----

Part 6 Field Setting 49

1. Test Operation	50
1.1 Pre-run Checks	50
1.2 Remote Controller Confirmation.....	50
1.3 Test Run.....	51
1.4 Precautions Regarding Test Run	51
1.5 Failure Diagnosis at the Moment of First Installation	52
2. Field Setting from Remote Controller.....	53
2.1 Wired Remote Controller.....	53
2.2 Wireless Remote Controller	56
2.3 Settings Contents and Code No. for Indoor Units	57
2.4 Overview of the Field Setting on the Outdoor Units	62
2.5 Quiet (Low Noise) Operation.....	63
2.6 I-Demand Function.....	65
2.7 Setting for Low Humidity Application.....	66
2.8 Defrost Start Setting.....	70
3. Field Setting from Outdoor Unit PCB	71
3.1 Location of DIP Switch and BS Button	71
3.2 Field Setting for Outdoor Unit.....	72
4. Emergency Operation	77
4.1 Forced Operation	77

Part 7 Service Diagnosis..... 79

1. Maintenance Inspection	81
1.1 Overview	81
2. Symptom-based Troubleshooting	83
2.1 Overview	83
2.2 Equipment does not Operate	84
2.3 Indoor Unit Fan Operates, but Compressor does not Operate	86
2.4 Cooling / Heating Operation Starts but Stops Immediately	88
2.5 After Unit Shuts Down, It cannot be Restarted for a While	89
2.6 Equipment Operates but does not Provide Cooling	91
2.7 Equipment Operates but does not Provide Heating	93
2.8 Equipment Discharges White Mist	95
2.9 Equipment Produces Loud Noise or Vibration	96
2.10 Equipment Discharges Dust.....	97
2.11 Remote Controller LCD Displays "88"	98
2.12 Swing Flap does not Operate.....	99
3. Troubleshooting by LED Indications	101
3.1 Troubleshooting by LED on the Indoor Unit	101
3.2 Troubleshooting by LED on Outdoor Unit PCB.....	101
4. Troubleshooting by Remote Controller	102
4.1 Procedure of Self-diagnosis by Remote Controller	102
4.2 Error Codes and Description	106
4.3 Safety Devices	107
4.4 Indoor Unit PCB Abnormality	108
4.5 Drain Water Level System Abnormality.....	109
4.6 Indoor Unit Fan Motor Abnormality	111

4.7	Capacity Setting Abnormality	112
4.8	Transmission Error (between Indoor Unit PCB and Adaptor PCB)	113
4.9	Thermistor Abnormality	115
4.10	Humidity Sensor System Abnormality	116
4.11	Remote Controller Thermistor Abnormality	117
4.12	Outdoor Unit PCB Abnormality.....	118
4.13	High Pressure Abnormality (Detected by the High Pressure Switch)...	119
4.14	Actuation of Pressure Sensor.....	123
4.15	Compressor Motor Lock	125
4.16	Outdoor Unit Fan Motor Abnormality.....	126
4.17	Electronic Expansion Valve Abnormality	128
4.18	Discharge Pipe Temperature Control.....	131
4.19	High Pressure Switch System Abnormality	133
4.20	Thermistor System Abnormality	134
4.21	Outdoor Unit PCB Abnormality.....	135
4.22	Radiation Fin Temperature Rise	137
4.23	Output Overcurrent Detection	139
4.24	Electronic Thermal (Time Lag)	141
4.25	Stall Prevention (Time Lag).....	143
4.26	Transmission System Abnormality (between Control and Inverter PCB)	145
4.27	Open Phase or Power Supply Voltage Imbalance	146
4.28	Defective Capacity Setting	147
4.29	Refrigerant Shortage (Alert)	148
4.30	Refrigerant Shortage (Error).....	149
4.31	Power Supply Voltage Abnormality	151
4.32	Transmission Error between Indoor and Outdoor Unit.....	153
4.33	Transmission Error Between Remote Controller and Indoor Unit	156
4.34	Transmission Error between MAIN Remote Controller and SUB Remote Controller.....	157
4.35	Field Setting Switch Abnormality	158
4.36	"UL" Address Duplication of Centralized Controller	160
4.37	Transmission Error Between Centralized Controller and Indoor Unit.....	161
4.38	Transmission Error between Indoor and Outdoor Unit / Piping and Wiring Mismatch / Refrigerant Shortage	163
4.39	Check	165





Part 8 Appendix..... 178

1.	Piping Diagrams.....	179
1.1	RZQG71LV1B	179
1.2	RZQG100-140LV1B	179
2.	Wiring Diagrams.....	180
2.1	Indoor Unit.....	180
2.2	Outdoor Unit	181
3.	Precautions for New Refrigerant (R-410A)	182
3.1	Outline	182
3.2	Refrigerant Cylinders.....	184
3.3	Service Tools.....	185







1. Introduction



1.1 Safety Cautions









Cautions and Warnings

- Be sure to read the following safety cautions before conducting repair work.
- The caution items are classified into “ **Warning**” and “ **Caution**”. The “ **Warning**” items are especially important since they can lead to death or serious injury if they are not followed closely. The “ **Caution**” items can also lead to serious accidents under some conditions if they are not followed. Therefore, be sure to observe all the safety caution items described below.
- About the pictograms
 - △ This symbol indicates the item for which caution must be exercised.
The pictogram shows the item to which attention must be paid.
 - This symbol indicates the prohibited action.
The prohibited item or action is shown in the illustration or near the symbol.
 - This symbol indicates the action that must be taken, or the instruction.
The instruction is shown in the illustration or near the symbol.
- After the repair work is complete, be sure to conduct a test operation to ensure that the equipment operates normally, and explain the cautions for operating the product to the customer.











1.1.1 Cautions Regarding Safety of Workers





 Warning	
Be sure to disconnect the power cable plug from the plug socket before disassembling the equipment for repair. Working on the equipment that is connected to the power supply may cause an electrical shock. If it is necessary to supply power to the equipment to conduct the repair or inspecting the circuits, do not touch any electrically charged sections of the equipment.	
If the refrigerant gas is discharged during the repair work, do not touch the discharged refrigerant gas. The refrigerant gas may cause frostbite.	
When disconnecting the suction or discharge pipe of the compressor at the welded section, evacuate the refrigerant gas completely at a well-ventilated place first. If there is a gas remaining inside the compressor, the refrigerant gas or refrigerating machine oil discharges when the pipe is disconnected, and it may cause injury.	
If the refrigerant gas leaks during the repair work, ventilate the area. The refrigerant gas may generate toxic gases when it contacts flames.	
The step-up capacitor supplies high-voltage electricity to the electrical components of the outdoor unit. Be sure to discharge the capacitor completely before conducting repair work. A charged capacitor may cause an electrical shock.	
Do not start or stop the air conditioner operation by plugging or unplugging the power cable plug. Plugging or unplugging the power cable plug to operate the equipment may cause an electrical shock or fire.	







 Warning	
Be sure to wear a safety helmet, gloves, and a safety belt when working at a high place (more than 2 m). Insufficient safety measures may cause a fall accident.	
In case of R-410A refrigerant models, be sure to use pipes, flare nuts and tools for the exclusive use of the R-410A refrigerant. The use of materials for R-22 refrigerant models may cause a serious accident such as a damage of refrigerant cycle as well as an equipment failure.	





 Caution	
Do not repair the electrical components with wet hands. Working on the equipment with wet hands may cause an electrical shock.	
Do not clean the air conditioner by splashing water. Washing the unit with water may cause an electrical shock.	
Be sure to provide the grounding when repairing the equipment in a humid or wet place, to avoid electrical shocks.	
Be sure to turn off the power switch and unplug the power cable when cleaning the equipment. The internal fan rotates at a high speed, and cause injury.	
Be sure to conduct repair work with appropriate tools. The use of inappropriate tools may cause injury.	
Be sure to check that the refrigerating cycle section has cooled down enough before conducting repair work. Working on the unit when the refrigerating cycle section is hot may cause burns.	
Use the welder in a well-ventilated place. Using the welder in an enclosed room may cause oxygen deficiency.	

1.1.2 Cautions Regarding Safety of Users

 Warning	
<p>Be sure to use parts listed in the service parts list of the applicable model and appropriate tools to conduct repair work. Never attempt to modify the equipment. The use of inappropriate parts or tools may cause an electrical shock, excessive heat generation or fire.</p>	
<p>If the power cable and lead wires have scratches or deteriorated, be sure to replace them. Damaged cable and wires may cause an electrical shock, excessive heat generation or fire.</p>	
<p>Do not use a joined power cable or extension cable, or share the same power outlet with other electrical appliances, since it may cause an electrical shock, excessive heat generation or fire.</p>	
<p>Be sure to use an exclusive power circuit for the equipment, and follow the local technical standards related to the electrical equipment, the internal wiring regulations, and the instruction manual for installation when conducting electrical work. Insufficient power circuit capacity and improper electrical work may cause an electrical shock or fire.</p>	
<p>Be sure to use the specified cable for wiring between the indoor and outdoor units. Make the connections securely and route the cable properly so that there is no force pulling the cable at the connection terminals. Improper connections may cause excessive heat generation or fire.</p>	
<p>When wiring between the indoor and outdoor units, make sure that the terminal cover does not lift off or dismount because of the cable. If the cover is not mounted properly, the terminal connection section may cause an electrical shock, excessive heat generation or fire.</p>	
<p>Do not damage or modify the power cable. Damaged or modified power cable may cause an electrical shock or fire. Placing heavy items on the power cable, and heating or pulling the power cable may damage the cable.</p>	
<p>Do not mix air or gas other than the specified refrigerant (R-410A / R-22) in the refrigerant system. If air enters the refrigerating system, an excessively high pressure results, causing equipment damage and injury.</p>	
<p>If the refrigerant gas leaks, be sure to locate the leaking point and repair it before charging the refrigerant. After charging refrigerant, make sure that there is no refrigerant leak. If the leaking point cannot be located and the repair work must be stopped, be sure to perform pump-down and close the service valve, to prevent the refrigerant gas from leaking into the room. The refrigerant gas itself is harmless, but it may generate toxic gases when it contacts flames, such as fan and other heaters, stoves and ranges.</p>	
<p>When relocating the equipment, make sure that the new installation site has sufficient strength to withstand the weight of the equipment. If the installation site does not have sufficient strength and if the installation work is not conducted securely, the equipment may fall and cause injury.</p>	





 Warning	
Check to make sure that the power cable plug is not dirty or loose, then insert the plug into a power outlet securely. If the plug has dust or loose connection, it may cause an electrical shock or fire.	
Be sure to install the product correctly by using the provided standard installation frame. Incorrect use of the installation frame and improper installation may cause the equipment to fall, resulting in injury.	For unitary type only 
Be sure to install the product securely in the installation frame mounted on the window frame. If the unit is not securely mounted, it may fall and cause injury.	For unitary type only 
When replacing the coin battery in the remote controller, be sure to disposed of the old battery to prevent children from swallowing it. If a child swallows the coin battery, see a doctor immediately.	

 Caution	
Installation of a leakage breaker is necessary in some cases depending on the conditions of the installation site, to prevent electrical shocks.	
Do not install the equipment in a place where there is a possibility of combustible gas leaks. If the combustible gas leaks and remains around the unit, it may cause a fire.	
Check to see if the parts and wires are mounted and connected properly, and if the connections at the soldered or crimped terminals are secure. Improper installation and connections may cause excessive heat generation, fire or an electrical shock.	
If the installation platform or frame has corroded, replace it. Corroded installation platform or frame may cause the unit to fall, resulting in injury.	
Check the grounding, and repair it if the equipment is not properly grounded. Improper grounding may cause an electrical shock.	

 Caution	
Be sure to measure the insulation resistance after the repair, and make sure that the resistance is 1 MΩ or higher. Faulty insulation may cause an electrical shock.	
Be sure to check the drainage of the indoor unit after the repair. Faulty drainage may cause the water to enter the room and wet the furniture and floor.	
Do not tilt the unit when removing it. The water inside the unit may spill and wet the furniture and floor.	
Be sure to install the packing and seal on the installation frame properly. If the packing and seal are not installed properly, water may enter the room and wet the furniture and floor.	For unitary type only 

1.2 Used Icons

Icons are used to attract the attention of the reader to specific information. The meaning of each icon is described in the table below:

Icon	Type of Information	Description
 Note:	Note	A “note” provides information that is not indispensable, but may nevertheless be valuable to the reader, such as tips and tricks.
 Caution	Caution	A “caution” is used when there is danger that the reader, through incorrect manipulation, may damage equipment, lose data, get an unexpected result or has to restart (part of) a procedure.
 Warning	Warning	A “warning” is used when there is danger of personal injury.
	Reference	A “reference” guides the reader to other places in this binder or in this manual, where he/she will find additional information on a specific topic.

1.3 Preface

Thank you for your continued patronage of Daikin products.

This is the new service manual for Daikin's Year 2010 RZQG-L series Heat Pump System. Daikin offers a wide range of models to respond to building and office air conditioning needs. We are confident that customers will be able to find the models that best suit their needs.

This service manual contains information regarding the servicing of RZQG-L series R-410A Heat Pump System.

November, 2010

After Sales Service Division

Part 1

General Information

1. Model Names of Indoor / Outdoor Units.....	2
2. External Appearance.....	3

1. Model Names of Indoor / Outdoor Units

Model Series	Indoor Unit	Outdoor Unit	Power Supply
Ceiling Mounted Cassette Type	FCQG71EVEB	RZQG71LV1B	1 phase, 220-240V, 50Hz
	FCQG100EVEB	RZQG100LV1B	
	FCQG125EVEB	RZQG125LV1B	
	FCQG140EVEB	RZQG140LV1B	
Ceiling Suspended Type	FHQG71CVEB	RZQG71LV1B	
	FHQG100CVEB	RZQG100LV1B	
	FHQG125CVEB	RZQG125LV1B	
	FHQG140CVEB	RZQG140LV1B	

i **Note:** 1. Power supply intake: Outdoor unit

2. External Appearance

Indoor Units



FCQG-E



FHQG-C

Wired Remote Controller



BRC1D528



BRC1E51A7

Wireless Remote Controller



BRC7G63

Outdoor Units



RZQG71LV1B



RZQG100-125-140LV1B

Part 2

Functions

1. Functions.....	5
1.1 Indoor Unit.....	5
1.2 Outdoor Unit.....	5

1. Functions

1.1 Indoor Unit

Items	Features		FCQG-E	FHQG-C
			Heat Pump	Heat Pump
Control	Auto swing		○	○
	Swing pattern selection		○	○
	Switchable fan speed		○	○
	Program "Dry"		○	○
	High ceiling application		○	○(*1)
	Two selectable thermo. sensors	Wired type	○	○
		Wireless type	—	○
	Hot start		○	○
Timer selector		○	○	
Mould prevention	Mould resistant treatment for filter		○	○
	Mould-proofing drain pan		○	○
Work & servicing	Drain water lift-up mechanism		○	○
	Pre-charged for up to 30 m		○	○
	Long-life filter		○	○
	Filter sign		○	○
	Ceiling soiling prevention		○	—
	Emergency operation		○	○
	Self-diagnosis function		○	○
Control features	Auto-restart		○	○
	Auto cooling/heating change-over		○	○
	Control by 2 remote controllers		○	○
	Control by 1 remote controller		○	○
	External command control		○	○
	Centralized remote control		○	○
Option	Interlock control		○	○
	Fresh air intake kit		○	—

Note:

○ : Functions exist.

— : No functions

*1 : FHQG71C Installable on max. 3.5m high ceiling

FHQG100~140C Installable on max. 4.3m high ceiling

1.2 Outdoor Unit

Items	Functions		RZQG71L	RZQG100/125/140L
Control	Inverter Control (For Comfortable Air Conditioning)			○
	Night Time Quiet Operation Function for Cooling			○
	EDP Room Applicable			○
Work & Servicing	Low Gas Pressure Detection			○
Operation Range	Wide Operation Range	Cooling	-15~50°CDB	
		Heating	-20~15.5°CWB	
Others	PE Fin for Outdoor Unit			○

Note:

○ : Functions exist.

— : No functions

Part 3 Specifications

1. Specifications7

1. Specifications

FCQG (Ceiling Mounted Cassette Type - Round Flow -)

Model	Indoor unit		FCQG71EVEB	FCQG100EVEB	FCQG125EVEB	FCQG140EVEB
	Outdoor unit		RZQG71LV1B	RZQG100LV1B	RZQG125LV1B	RZQG140LV1B
Power Supply			1 phase, 220-240V, 50Hz			
Cooling capacity *1	kW		7.1	10.0	12.5	14.0
	Btu/h		24,200	34,100	42,700	47,800
	kcal/h		6,100	8,600	10,800	12,000
Heating capacity *1	kW		8.0	11.2	14.0	16.0
	Btu/h		27,300	38,200	47,800	54,600
	kcal/h		6,900	9,600	12,000	13,800
Cooling input *1	kW		1.85	2.47	3.61	4.36
Heating input *1	kW		1.70	2.38	3.30	3.99
EER	—		3.84	4.05	3.46	3.21
COP	—		4.71	4.71	4.24	4.01
SEER (by Feb-2010-Tool)	—		4.67	4.62	4.27	4.17
SCOP (Bivalent point-4°C)	—		3.74	3.78	3.59	3.53
Indoor unit			FCQG71EVEB	FCQG100EVEB	FCQG125EVEB	FCQG140EVEB
Colour			Galvanized steel plate			
Dimensions	HxWxD		mm			
			288x840x840			
Coil	Type		Cross fin coil (Multi louver fins and N-hix tubes)			
	RowxStagesxFin pitch		1x18x1.25,2x18x1.2			
	Face area		m ²			
Fan	Model		QTS48C15M			
	Type		Turbo Fan			
	Motor output		W		106	
	AFR		m ³ /min		(H)21.5 (M)16.5 (L)12.5 (H)32 (M)25.5 (L)19 (H)33 (M)27 (L)21	
Air filter			—			
Mass			kg			
Sound pressure (H/M/L)			dB		25	
Sound power			dB		45/41/37	
Piping Connections	Liquid		mm			
	Gas		mm			
	Drain		mm			
Remote controller (option)			Wired Wireless			
Decoration panel (option)	Model		BYCP125B-W1			
	Colour		Fresh White			
	Dimensions		HxWxD		mm	
	Air filter		Resin net (With mold resistant)			
	Mass		kg			
Outdoor unit			RZQG71LV1B	RZQG100LV1B	RZQG125LV1B	RZQG140LV1B
Colour			Ivory White			
Dimensions	HxWxD		mm			
			990x940x320		1,430x940x320 1,430x940x320 1,430x940x320	
Coil	Type		Cross fin coil (Waffle fins and Hi-XSL tubes)			
	RowxStagesxFin pitch		2x44x1.4		2x64x1.4	
	Face area		m ²		0.884 1.286	
Comp.	Model		2YC63FXD#D*		5VD420XAA21	
	Type		Hermetically sealed swing type		Hermetically sealed rotary type	
	Motor output		kW		1.62 2.14 2.90 3.60	
Fan	Model		P51J11F×1		P51J11F×2	
	Type		Propeller Fan			
	Motor output		W		94 94+94	
	AFR		m ³ /min		59 114	
Mass			kg			
Sound pressure (cooling / heating)			dB		77 99	
Sound power			dB		48/50 51/53	
Piping Connections	Liquid		mm			
	Gas		mm			
	Drain		mm			
Safety devices			High Pressure Switch, Fuse			
Capacity step			%			
Refrigerant control			100-0			
Ref. piping	Max. length		m		Electronic Expansion Valve	
	Max. height difference		m		75 (Equivalent Length 90m) 30	
Refrigerant	Model		R-410A			
	Charge		kg		3.5 (Charged for 30m) 4.0 (Charged for 30m)	
Ref. oil	Model		FVC50K		FV50S	
	Charge		L		0.9 1.3	
Drawing No.			C: 3D069662C			

Note:

*1. The above data based on the conditions shown in the table below.

Cooling	Heating	Piping length
Indoor : 27°CDB, 19.0°CWB Outdoor : 35°CDB, 24°CWB	Indoor : 20°CDB, 15°CWB Outdoor : 7°CDB, 6°CWB	5m (Horizontal)

FHQG (Ceiling Suspended Type)

Model	Indoor unit		FHQG71CVEB	FHQG100CVEB	FHQG125CVEB	FHQG140CVEB
	Outdoor unit		RZQG71LV1B	RZQG100LV1B	RZQG125LV1B	RZQG140LV1B
Power Supply	1 phase, 220-240V, 50Hz					
Cooling capacity *1	kW		7.1	10.0	12.5	14.0
	Btu/h		24,200	34,100	42,700	47,800
	kcal/h		6,100	8,600	10,800	12,000
Heating capacity *1	kW		8.0	11.2	14.0	16.0
	Btu/h		27,300	38,200	47,800	54,600
	kcal/h		6,900	9,600	12,000	13,800
Cooling input *1	kW		1.95	2.61	3.87	4.65
Heating input *1	kW		2.05	2.67	3.72	4.42
EER	—		3.64	3.83	3.23	3.01
COP	—		3.90	4.19	3.76	3.62
SEER (by Feb-2010-Tool)	—		4.41	4.53	4.11	3.66
SCOP (Bivalent point-4°C)	—		3.51	3.68	3.46	3.40
Indoor unit			FHQG71CVEB	FHQG100CVEB	FHQG125CVEB	FHQG140CVEB
Colour	Fresh White					
Dimensions	HxWxD	mm	235x1,270x690		235x1,590x690	
Coil	Type		Cross fin coil (Multi louver fins and N-hix tubes)			
	RowxStagesxFin pitch		3x14x1.5			
	Face area	m ²	0.303	0.398		
Fan	Model		3D15L1AA1	4D15L1AC1		
	Type		Sirocco Fan			
	Motor output	W	91	150		
	AFR	m ³ /min	(H) 20.5 (M) 17 (L) 14	(H) 28 (M) 24 (L) 20	(H) 31 (M) 27 (L) 23	(H) 34 (M) 29 (L) 24
Air filter	Resin net (With mold resistant)					
Mass	kg		32	38		
Sound pressure (H/M/L)	dB		38/36/34	42/38/34	44/41/37	46/42/38
Sound power	dB		55	60	62	64
Piping Connections	Liquid	mm	φ 9.5 (Flare)			
	Gas	mm	φ 15.9 (Flare)			
	Drain	mm	VP20 (External dia. 26)			
Remote controller (option)	Wired	BRC1E51A7/BRC1D528				
	Wireless	BRC7G63				
Outdoor unit			RZQG71LV1B	RZQG100LV1B	RZQG125LV1B	RZQG140LV1B
Colour	Ivory White					
Dimensions	HxWxD	mm	990x940x320		1,430x940x320	
Coil	Type		Cross fin coil (Waffle fins and Hi-XSL tubes)			
	RowxStagesxFin pitch		2x44x1.4			
	Face area	m ²	0.884	1.286		
Comp.	Model		2YC63FXD#D*	5VD420XAA21		
	Type		Hermetically sealed swing type	Hermetically sealed rotary type		
	Motor output	kW	1.62	2.14	2.90	3.60
Fan	Model		P51J11F×1	P51J11F×2		
	Type		Propeller Fan			
	Motor output	W	94	94+94		
	AFR	m ³ /min	59	114		
Mass	kg		77	99		
Sound pressure (cooling / heating)	dB		48/50	50/52	51/53	
Sound power	dB		64	66	67	68
Piping Connections	Liquid	mm	φ 9.5 (Flare)			
	Gas	mm	φ 15.9 (Flare)			
	Drain	mm	φ 26.0 (Hole)			
Safety devices	High Pressure Switch, Fuse					
Capacity step	%		100-0			
Refrigerant control	Electronic Expansion Valve					
Ref. piping	Max. length	m	50 (Equivalent Length 70m)		75 (Equivalent Length 90m)	
	Max. height difference	m	30			
Refrigerant	Model		R-410A			
	Charge	kg	3.5 (Charged for 30m)		4.0 (Charged for 30m)	
Ref. oil	Model		FVC50K		FV50S	
	Charge	L	0.9		1.3	
Drawing No.	C: 3D069663C					



Note:

*1. The above data based on the conditions shown in the table below.

Cooling	Heating	Piping length
Indoor : 27°CDB, 19.0°CWB Outdoor : 35°CDB, 24°CWB	Indoor : 20°CDB, 15°CWB Outdoor : 7°CDB, 6°CWB	5m (Horizontal)

Part 4

Remote Controller

1. Wired Remote Controller.....	10
1.1 Applicable Models	10
1.2 Names and Functions	11
1.3 MAIN/SUB Setting when Using 2 Remote Controllers	15
1.4 Centralized Control Group No. Setting.....	16
2. Wireless Remote Controller	18
2.1 Applicable Models	18
2.2 Names and Functions	18
2.3 MAIN/SUB Setting.....	20
3. Service Mode	21
3.1 BRC1D528	21
4. Inspection Mode.....	23
4.1 BRC1D528	23

1. Wired Remote Controller

1.1 Applicable Models

Model Series	FCQG-E	FHQG-C
Remote Controller	BRC1D528 BRC1E51A7	

1.2 Names and Functions

1.2.1 BRC1D528

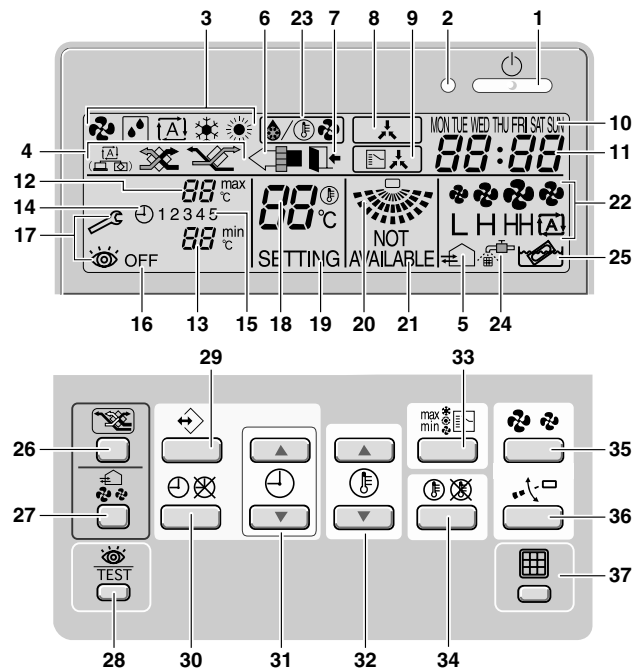

1. **ON/OFF BUTTON**

Press the ON/OFF button to start or stop the system.
2. **OPERATION LAMP**

The operation lamp lights up during operation or blinks if an error occurs.
3. **OPERATION MODE ICON**

These icons indicate the current operation mode (FAN, DRY, AUTOMATIC, COOLING, HEATING).
4. **VENTILATION MODE ICON**

These icons indicate the current ventilation mode (HRV only) (AUTOMATIC, HEAT EXCHANGE, BYPASS).
5. **VENTILATION ICON**

The ventilation icon appears when the ventilation is adjusted with the ventilation amount button (HRV only). Simultaneously, the ventilation amount is indicated by the fan speed icon.
6. **AIR CLEANING ICON**

This icon indicates that the air cleaning unit (option) is operational.
7. **LEAVE HOME ICON**

The leave home icon shows the status of the leave home function.



















ON	Leave home is enabled
FLASHING	Leave home is active
OFF	Leave home is disabled
8. **EXTERNAL CONTROL ICON**

This icon indicates that another controller with higher priority is controlling or disabling your installation.
9. **CHANGE-OVER UNDER CENTRALISED CONTROL ICON**

This icon indicates that the change-over of the installation is under centralised control assigned to another indoor unit or optional cool/heat selector connected to the outdoor unit (= Main remote controller).
10. **DAY OF THE WEEK INDICATOR**

The day of the week indicator shows the current week day (or the set day when reading or programming the schedule timer).
11. **CLOCK DISPLAY**

The clock display indicates the current time (or the action time when reading or programming the schedule timer).

12. MAXIMUM SET TEMPERATURE $88^{\circ\text{C max}}$
The maximum set temperature indicates the maximum set temperature when in limit operation.
13. MINIMUM SET TEMPERATURE $88^{\circ\text{C min}}$
The minimum set temperature indicates the minimum set temperature when in limit operation.
14. SCHEDULE TIMER ICON 
This icon indicates that the schedule timer is enabled.
15. ACTION ICONS $1\ 2\ 3\ 4\ 5$
These icons indicate the actions for each day of the schedule timer.
16. OFF ICON OFF
This icon indicates that the OFF action is selected when programming the schedule timer.
17. INSPECTION REQUIRED  and 
These icons indicate that inspection is required. Consult your installer.
18. SET TEMPERATURE DISPLAY $88^{\circ\text{C}}$
This indicates the current set temperature of the installation (not shown in LIMIT operation or in FAN or DRY mode).
19. SETTING SETTING
Not used, for service purposes only.
20. AIRFLOW DIRECTION ICON 
This icon indicates the airflow direction (only for installations with motorised airflow flaps).
21. NOT AVAILABLE $\frac{\text{NOT AVAILABLE}}{\text{NOT AVAILABLE}}$
is displayed whenever a non-installed option is addressed or a function is not available.
22. FAN SPEED ICON $\bullet\bullet\bullet\bullet$
This icon indicates the set fan speed.
23. DEFROST/HOTSTART MODE ICON 
This icon indicates that the defrost/hotstart mode is active.
24. AIR FILTER CLEANING TIME ICON 
This icon indicates the air filter must be cleaned. Refer to the manual of the indoor unit.
25. ELEMENT CLEANING TIME ICON 
This icon indicates the element must be cleaned (HRV only).
26. VENTILATION MODE BUTTON 
The ventilation mode button operates the HRV; refer to the manual for more details.
27. VENTILATION AMOUNT BUTTON 
This button sets the ventilation amount; refer to the manual for more details.
28. INSPECTION/TEST OPERATION BUTTON 
Not used, for service purposes only.
29. PROGRAMMING BUTTON 
This button is a multi-purpose button.
Depending on the previous manipulations of the user, the programming button can have various functions.
30. SCHEDULE TIMER BUTTON 
This button enables or disables the schedule timer.
31. TIME ADJUST BUTTON 
These buttons are used to adjust the clock or, when in programming mode, to adjust the programmed action time. Both buttons have an auto-repeat function.
32. TEMPERATURE ADJUST BUTTONS 
These buttons are used to adjust the current setpoint or, when in programming mode, to adjust the programmed setpoint temperature (step = 1°C). Both buttons are also used to adjust the day of the week.
33. OPERATION CHANGE/MIN-MAX BUTTON $\frac{\text{max}}{\text{min}}$
This button is a multi-purpose button. Depending on the previous manipulations of the user, it can have following functions:
1 select the operation mode of the installation (FAN, DRY, AUTOMATIC, COOLING, HEATING)
2 toggle between minimum temperature and maximum temperature when in limit operation
34. SETPOINT/LIMIT BUTTON 
This button toggles between setpoint, limit operation or OFF (programming mode only).
35. FAN SPEED BUTTON 
This button toggles between L (Low), H (High), HH (very High),  (Automatic).
36. AIRFLOW DIRECTION ADJUST BUTTON $\cdot\cdot\cdot\cdot$
This button enables to adjust the airflow direction.
37. AIR FILTER CLEANING TIME ICON RESET BUTTON 
This button is used to reset the air filter cleaning time icon.

1.2.2 BRC1E51A7

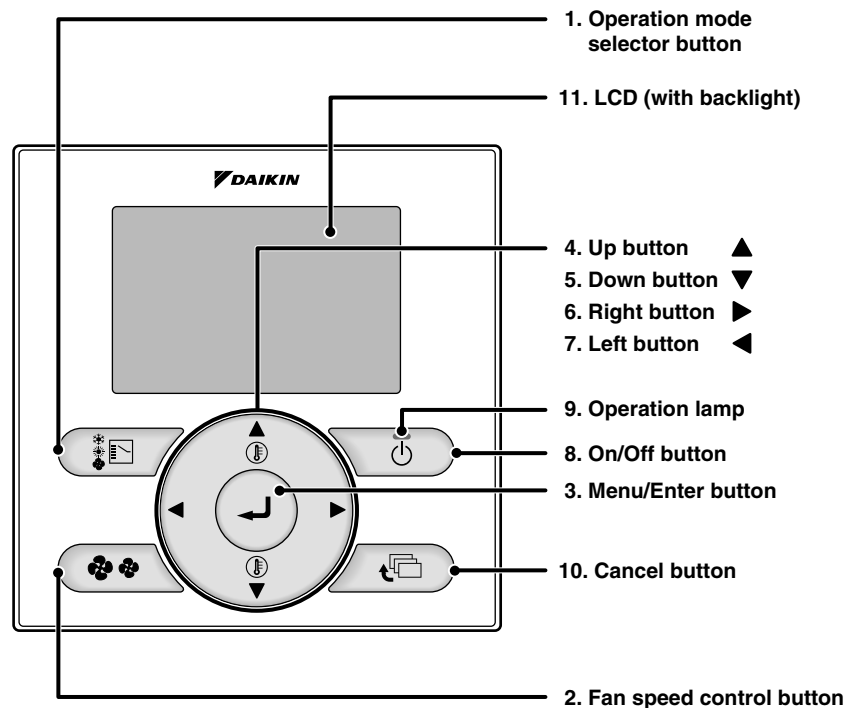

1. Operation mode selector button

- Press this button to select the operation mode of your preference.
*Available modes vary with the connecting model.

2. Fan speed control button

- Press this button to select the fan speed of your preference.
*Available fan speed vary with the connecting model.

3. Menu/Enter button

- Used to indicate the main menu.
- Used to enter the setting item selected.

4. Up button ▲ (Be sure to press the part with the symbol ▲)

- Used to raise the set temperature.
- The next items on the upper side will be highlighted.
(The highlighted items will be scrolled continuously when the button is kept pressed.)
- Used to change the item selected.

5. Down button ▼ (Be sure to press the part with the symbol ▼)

- Used to lower the set temperature.
- The next items on the lower side will be highlighted.
(The highlighted items will be scrolled continuously when the button is kept pressed.)
- Used to change the item selected.

6. Right button ► (Be sure to press the part with the symbol ►)

- Used to highlight the next items on the right-hand side.
- Each screen is scrolled in the right-hand direction.
- Home leave settings are enabled with this button kept pressed for at least four seconds.

7. Left button ◄ (Be sure to press the part with the symbol ◄)

- Used to highlight the next items on the left-hand side.
- Each screen is scrolled in the left-hand direction.
- Home leave settings are enabled with this button kept pressed for at least four seconds.

8. On/Off button

- Press this button and system will start.
- Press this button again and system will stop.

9. Operation lamp (Green)

- This lamp lights up during operation.
- This lamp blinks if an error occurs.

10. Cancel button

- Used to return to the previous screen.

11. LCD (with backlight)

- The backlight will be light for approximately 30 seconds by pressing any operation button. Operate buttons excluding the On/Off button while the backlight is lit.
- If two remote controllers are used to control a single indoor unit, the backlight of the remote controller operated earlier than the other one will be lit.

1.3 MAIN/SUB Setting when Using 2 Remote Controllers

Situation

The MAIN/SUB setting is necessary when 1 indoor unit is controlled by 2 remote controllers. When you use 2 remote controllers (control panel and separate remote controller), set one to MAIN and the other to SUB.

Setting

The remote controllers are factory set to MAIN, so you only have to change 1 remote controller from MAIN to SUB. To change a remote controller from MAIN to SUB, proceed as follows:

1.3.1 BRC1D528

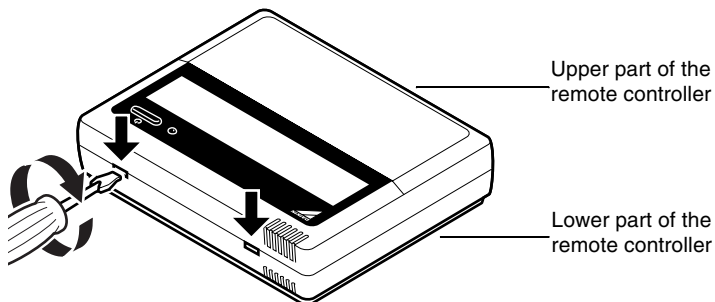
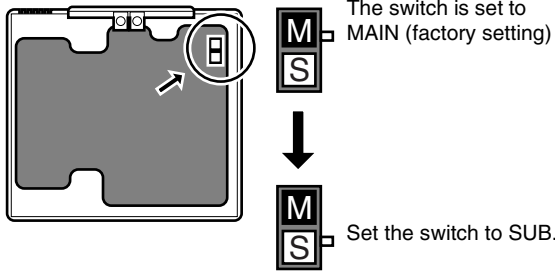
Step	Action
1	<p>Insert a flat-head screwdriver into the recess between the upper and lower part of the remote controller, as shown in the illustration below. Gently pry off the upper part of the controller, working from the 2 possible positions.</p> 
2	<p>Turn the MAIN/SUB changeover switch on the PCB to "S".</p> 

1.3.2 BRC1E51A7

The designation of the main and sub remote controllers can be swapped. Note that this change requires turning the power off and then on again.

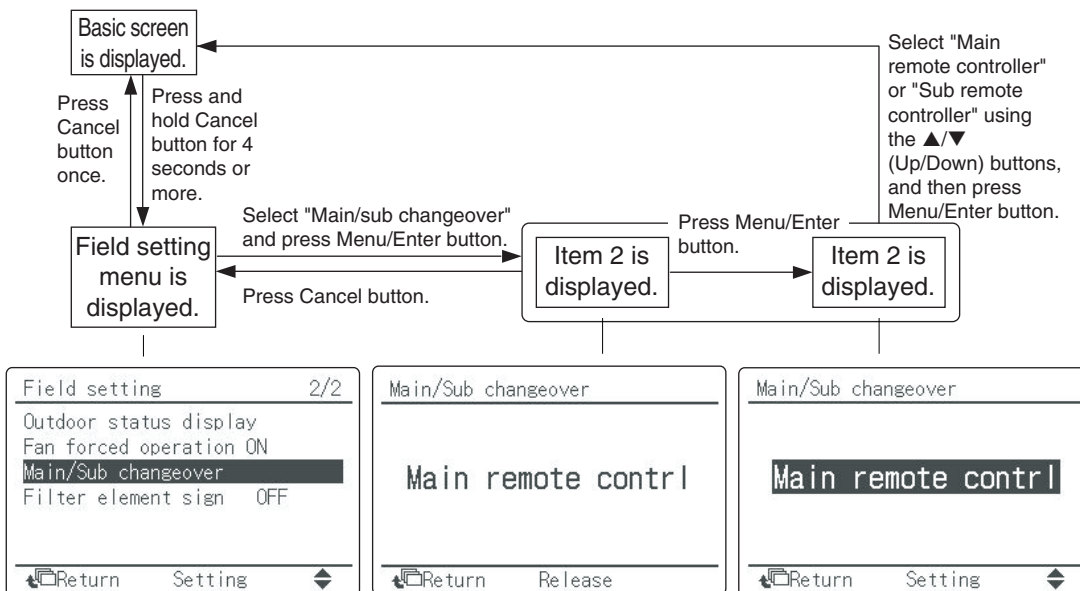







1.4 Centralized Control Group No. Setting

1.4.1 BRC1D528

In order to conduct the central remote control using the central remote controller and the unified ON/OFF controller, Group No. settings should be made by group using the operating remote controller.

Make Group No. settings for central remote control using the operating remote controller.

1. During normal mode, press and hold the “” button for 4 seconds or more to enter the "Field Setting Mode".
2. Select the Mode No. “00” with the “” button.
3. Select the Group No. for each group with the “” button.
(Group numbers increase in the order of 1-00, 1-01, ... 1-15, 2-00, ... 4-15.)
4. Press “” or “” button to set the selected Group No.
5. Press “” button to return to the normal mode.

BRC1D528

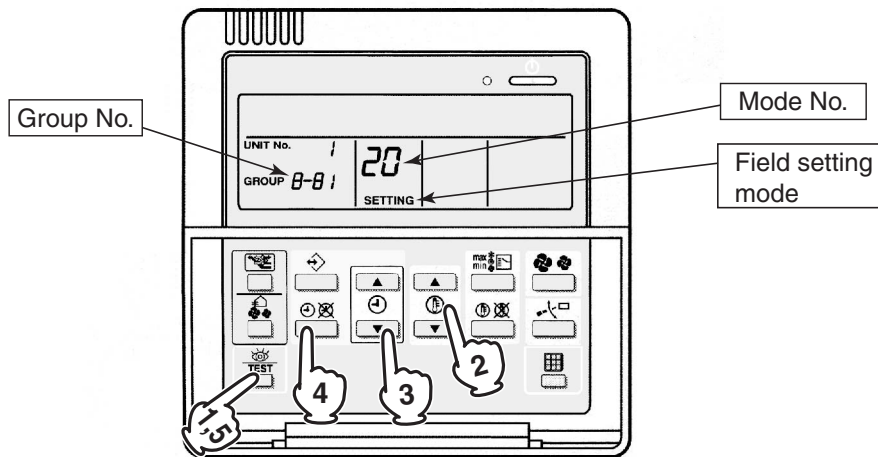

NOTICE

Enter the group No. and installation place of the indoor unit into the installation table. Be sure to keep the installation table with the operation manual for maintenance.

1.4.2 BRC1E51A7

In order to conduct the centralized remote control using the centralized remote controller and the unified ON/OFF controller, Group No. settings should be made by group using the operating remote controller.

Make Group No. settings for centralized remote control using the operating remote controller.

(1) <Basic screen>

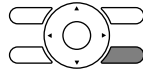
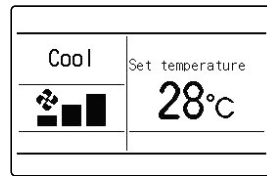

Press and hold Cancel button for 4 seconds or more.
Field setting menu is displayed.

(2) <Field setting menu screen>

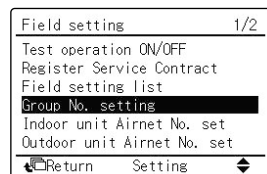

Select **Group No. setting** in the field setting menu, and press Menu/Enter button.

Group No. setting screen is displayed.

(3) <Group No. setting>

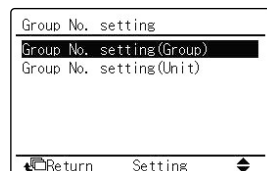

Select Group No. setting (Group), and press Menu/Enter button.

Group No. setting (Group) screen is displayed.

(4) <Group No. setting (Group)>

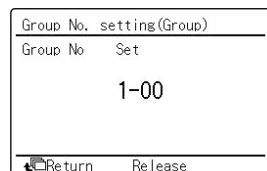

Select the group No. by using ▲▼ (Up/Down) button.
Press Menu/Enter button.

NOTICE

Enter the group No. and installation place of the indoor unit into the attached installation table.
Be sure to keep the installation table with the operation manual for maintenance.

2. Wireless Remote Controller

2.1 Applicable Models

Model Series	FCQG-E	FHQG-C
Remote Controller	—	BRC7G63

2.2 Names and Functions

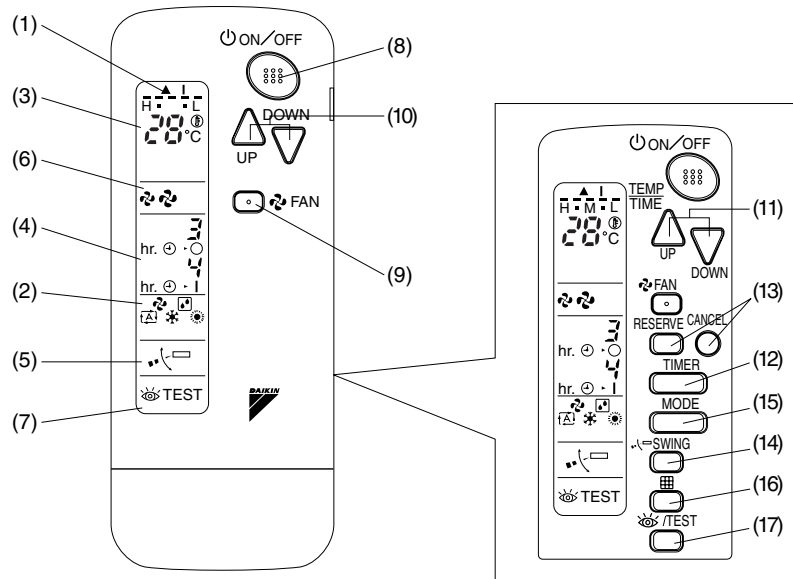





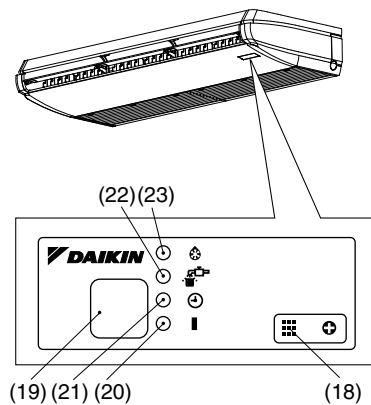

























Receiver

FHQG-C



3P107422-31W

1	DISPLAY “▲” (SIGNAL TRANSMISSION)	This lights up when a signal is being transmitted.	12	TIMER MODE START/STOP BUTTON	Refer to page 10.
	DISPLAY “” “” “” “” “” (OPERATION MODE)				
2	DISPLAY “” “” “” “” “” (OPERATION MODE)	This display shows the current OPERATION MODE.	13	TIMER RESERVE/CANCEL BUTTON	Refer to page 11.
	DISPLAY “” “” (SET TEMPERATURE)				
3	DISPLAY “” “” (SET TEMPERATURE)	This display shows the set temperature.	14	AIR FLOW DIRECTION ADJUST BUTTON	Refer to page 9.
	DISPLAY “ hr.  hr.  ” (PROGRAMMED TIME)				
4	DISPLAY “ hr.  hr.  ” (PROGRAMMED TIME)	This display shows PROGRAMMED TIME of the system start or stop.	15	OPERATION MODE SELECTOR BUTTON	Press this button to select OPERATION MODE. “  ” (COOL), “  ” (HEAT), “  ” (AUTO), “  ” (FAN), “  ” (DRY).
	DISPLAY “” “” “” (FAN SPEED)				
5	DISPLAY “” “” “” (FAN SPEED)	The display shows the set fan speed.	16	FILTER SIGN RESET BUTTON	Refer to the section of MAINTENANCE in the operation manual attached to the indoor unit.
	DISPLAY “ TEST” (INSPECTION/ TEST OPERATION)				
6	DISPLAY “ TEST” (INSPECTION/ TEST OPERATION)	When the INSPECTION/TEST OPERATION BUTTON is pressed, the display shows the system mode is in. Do not operate this button during normal use.	17	INSPECTION/TEST OPERATION BUTTON	This button is used only by qualified service persons for maintenance purposes.
	ON/OFF BUTTON				
7	ON/OFF BUTTON	Press the button and the system will start. Press the button again and the system will stop.	18	EMERGENCY OPERATION SWITCH	This switch is readily used if the remote controller does not work.
	FAN SPEED CONTROL BUTTON				
8	FAN SPEED CONTROL BUTTON	Press this button to select the fan speed, Low or Middle or High, of your choice.	19	RECEIVER	This receives the signals from the remote controller.
	TEMPERATURE SETTING BUTTON				
9	TEMPERATURE SETTING BUTTON	Use this button for SETTING TEMPERATURE.	20	OPERATING INDICATOR LAMP (Red)	This lamp stays lit while the air conditioner runs. It flashes when the unit is in trouble.
	TEMPERATURE ADJUSTMENT/ PROGRAMMING TIMER BUTTON				
10	TEMPERATURE ADJUSTMENT/ PROGRAMMING TIMER BUTTON	Use this button for temperature setting and programming “START and/or STOP” time. (Operates with the front cover of the remote controller opened.)	21	TIMER INDICATOR LAMP (Green)	This lamp stays lit while the timer is set.
	TEMPERATURE SETTING BUTTON				
11	TEMPERATURE SETTING BUTTON	Use this button for SETTING TEMPERATURE.	22	AIR FILTER CLEANING TIME INDICATOR LAMP (Red)	Lights up when it is time to clean the air filter.
	TEMPERATURE ADJUSTMENT/ PROGRAMMING TIMER BUTTON				
12	TEMPERATURE ADJUSTMENT/ PROGRAMMING TIMER BUTTON	Use this button for temperature setting and programming “START and/or STOP” time. (Operates with the front cover of the remote controller opened.)	23	DEFROST LAMP (Orange)	Lights up when the defrosting operation has started.
	TEMPERATURE SETTING BUTTON				

2.3 MAIN/SUB Setting



Introduction

To set the wireless remote controller, you have to set the address for:

- The receiver of the wireless remote controller
- The wireless remote controller.

Setting the Address for the Receiver

When using both a wired and a wireless remote controller for 1 indoor unit, the wired controller should be set to MAIN. Therefore, set the MAIN/SUB switch (SS1) of the receiver to SUB.

MAIN/SUB	MAIN	SUB
MAIN/SUB switch (SS1)		

3. Service Mode

3.1 BRC1D528

3.1.1 Display Service Data

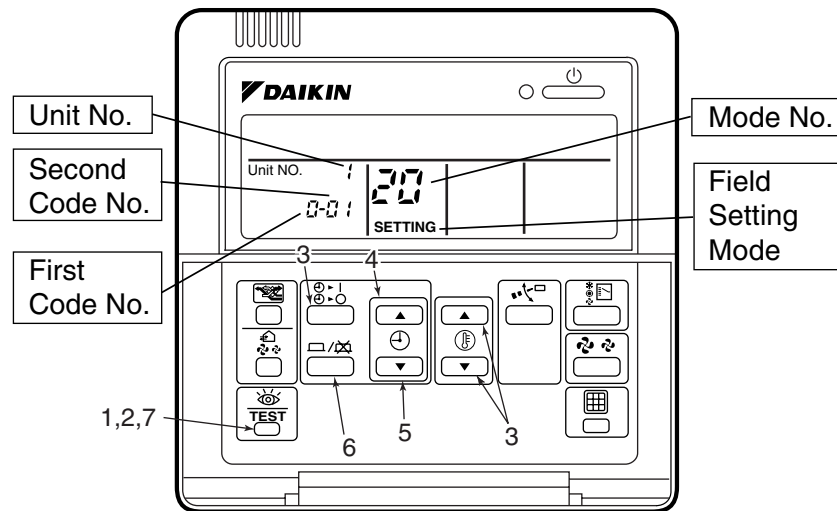

1. Enter the field setting mode.
Press the inspection / test operation button for 4 seconds or more.
2. Enter the service mode.
After having entered the field setting mode, press the inspection / test operation button for 4 seconds or more.
3. Select the mode No.
Set the desired mode No. with the up/down temperature setting button.
4. Select the unit No.
Select the indoor unit No. set with the time mode START/STOP button.
5. Select the desired error history No. or sensor data No. with or button.
6. Each data displays (Refer to the table below display)
7. Return to the normal operation mode.
Press the inspection / test operation button once.

Mode No.	Function	Content and Operation Method	Example of Remote Controller Display
40	Error History	You can change the history with the programming time up-down button.	
41	Sensor Data Display	Select the display thermistor with the programming time up-down button Display thermistor 00: Remote controller thermistor 01: Suction air thermistor 02: Heat exchanger thermistor	

3.1.2 Service Setting

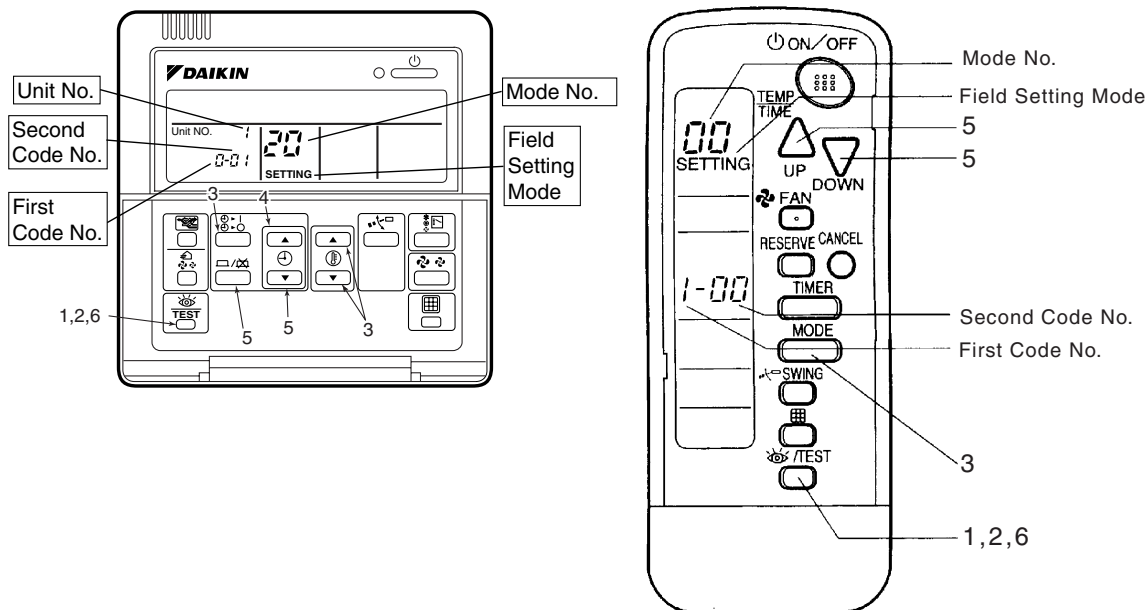

1. Enter the field setting mode.
Press the inspection / test operation button for 4 seconds or more.
2. Enter the maintenance mode.
After having entered the field setting mode, press the inspection / test operation button for a minimum of 4 seconds.
3. Select the mode No.
Set the desired mode No. with the up/down temperature setting button.
4. Select the unit No.
Select the indoor unit No. set with the time mode START/STOP button.
5. Carry out the necessary settings for each mode. (Mode 43 only possible for wireless remote controller)
 - In case of Mode 43
Press timer ON / OFF button to decide the forced Fan ON.
 - In case of Mode 44
Set "Fan speed" with fan speed control button and "Air flow direction" with air flow direction adjusting button, then press timer ON / OFF button to decide.
 - In case of Mode 45
Select the changed unit No. with or button, then press timer ON / OFF button to decide.
6. Return to the normal operation mode.
Press the inspection / test operation button 1 time.

Mode No.	Function	Content and Operation Method	Example of Remote Controller Display
43	Forced Fan ON	Turns the fan ON for each unit individually.	
44	Individual Setting	Sets fan speed and air flow direction for each unit individually when using group control. Settings are made using the "air flow direction adjust" and "fan speed adjust" buttons.	
45	Unit No. Change	Changes unit No. Set the unit No. after changing with the programming time up-down button.	

4. Inspection Mode

4.1 BRC1D528

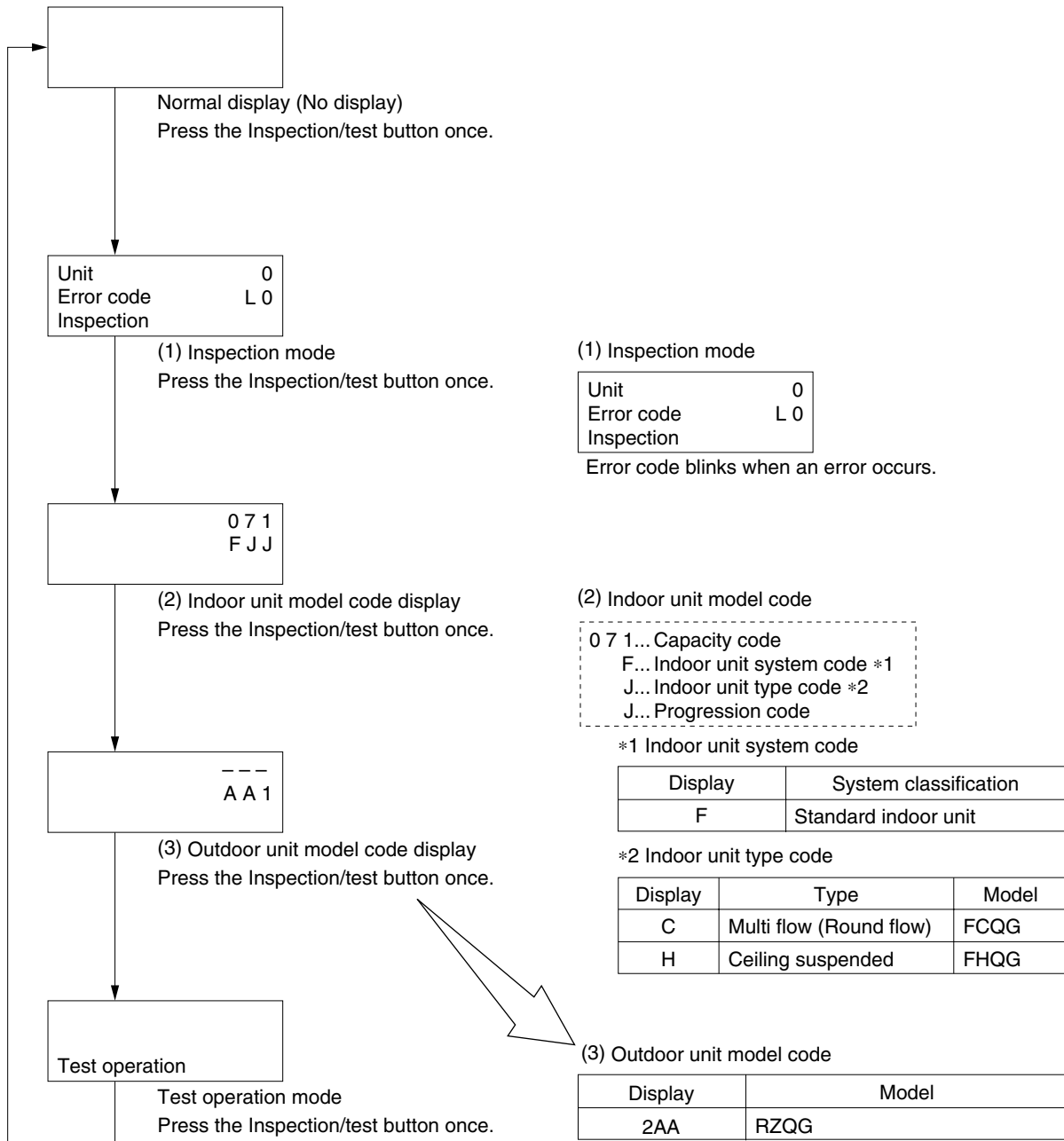

Note:

Inspection mode is not available for BRC1E51A7.

Part 5

Function and Control

1. Function of Main Components and Thermistors	25
2. Operation Flow Chart	27
2.1 Cooling / Dry Operation	27
2.2 Heating Operation	28
3. Function Details	29
3.1 Indoor Unit	29
3.2 Outdoor Unit	33

1. Function of Main Components and Thermistors

RZQG71L

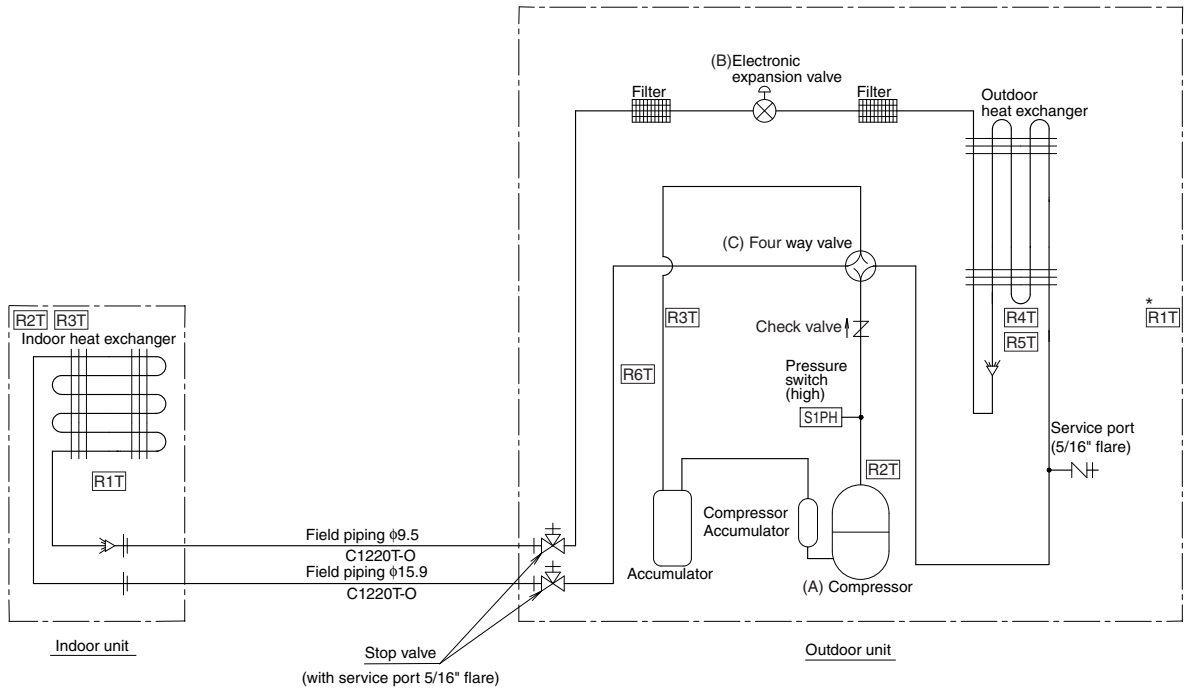

* This thermistor is near the el. compo. box.

C: 3D069535

RZQG100-140L

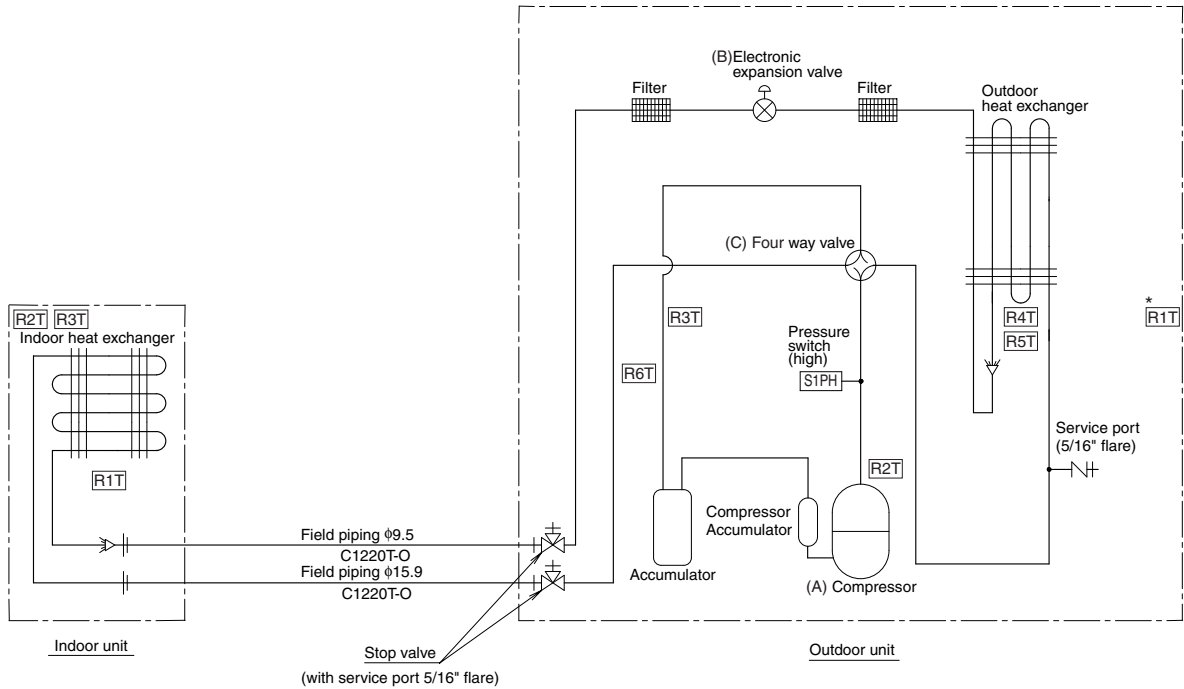

* This thermistor is near the el. compo. box.

C: 3D069536

■ Outdoor Unit

(A) Compressor (M1C)

Inverter drive unit varies compressor operating frequency to control capacity and other factors.

(B) Electronic Expansion Valve (Y1E)

Provides control to maintain optimum operating condition for high efficiency.

(C) Four Way Valve (Y1S)

Changes operation of cooling / heating.

- * Coil energized : heating
- Coil not energized : cooling

Outdoor Air Thermistor (R1T)

Used for startup condition control and defrost control.

Discharge Pipe Thermistor (R2T)

Used for discharge temperature protection during compression operation.

Suction Pipe Thermistor (R3T)

Used for suction super heat control by electronic expansion valve.

Heat Exchanger Distributor Pipe Thermistor (R4T)

- Used for calculation of outdoor heat exchanger subcooling during cooling operation.
- Used for judgement of the defrost IN and OUT condition.

Intermediate Heat Exchanger Thermistor (R5T)

Used for calculation of high pressure during cooling operation. (Calculate Pc by detected temperature and R-410A refrigerant characteristics)

Liquid Pipe Thermistor (R6T)

Used for calculation of indoor unit heat exchanger subcooling during heating operation.

Radiation Fin Thermistor (R10T)

- Used for outdoor fan speed control.
- Used for inverter radiation fin temperature control.
- Used for pressure difference control.

■ Indoor Unit

FCQG	FHQG	Thermistor
R1T	R1T	Suction air thermistor
R2T R3T	R2T R3T	Heat exchanger thermistor

Indoor Suction Air Thermistor

- Cooling:
- Thermostat control
 - PMV control
 - General frequency control
- Heating:
- Thermostat control
 - PMV control
 - General frequency control

Indoor Heat Exchanger Thermistor

- Cooling:
- Compressor frequency control (target Te)
 - Inverter current protection control
 - Freeze-up control
- Heating:
- Compressor frequency control (target Tc)
 - Inverter current protection control
 - Hot start control
 - Peak cut-off

2. Operation Flow Chart

2.1 Cooling / Dry Operation

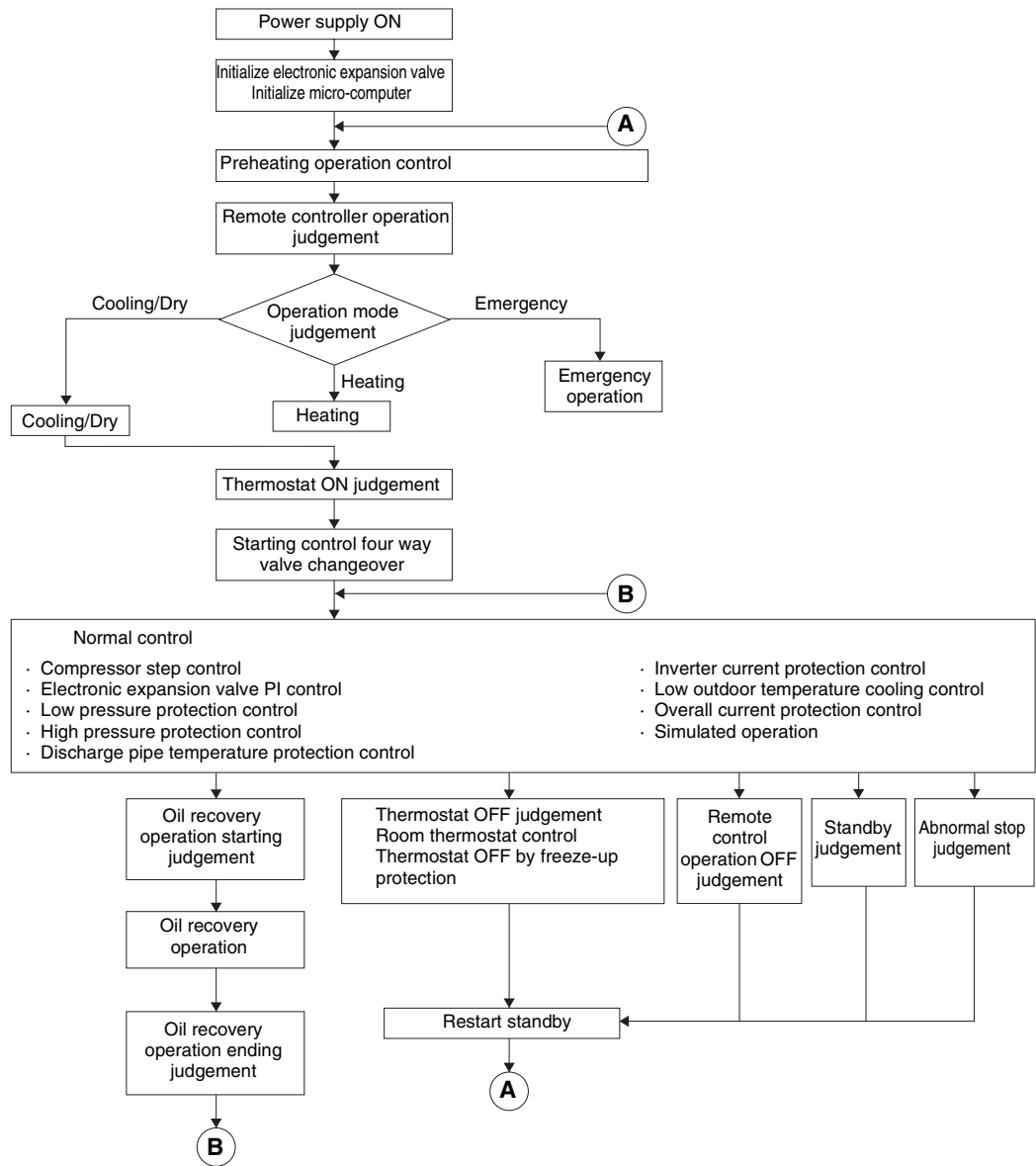

2.2 Heating Operation

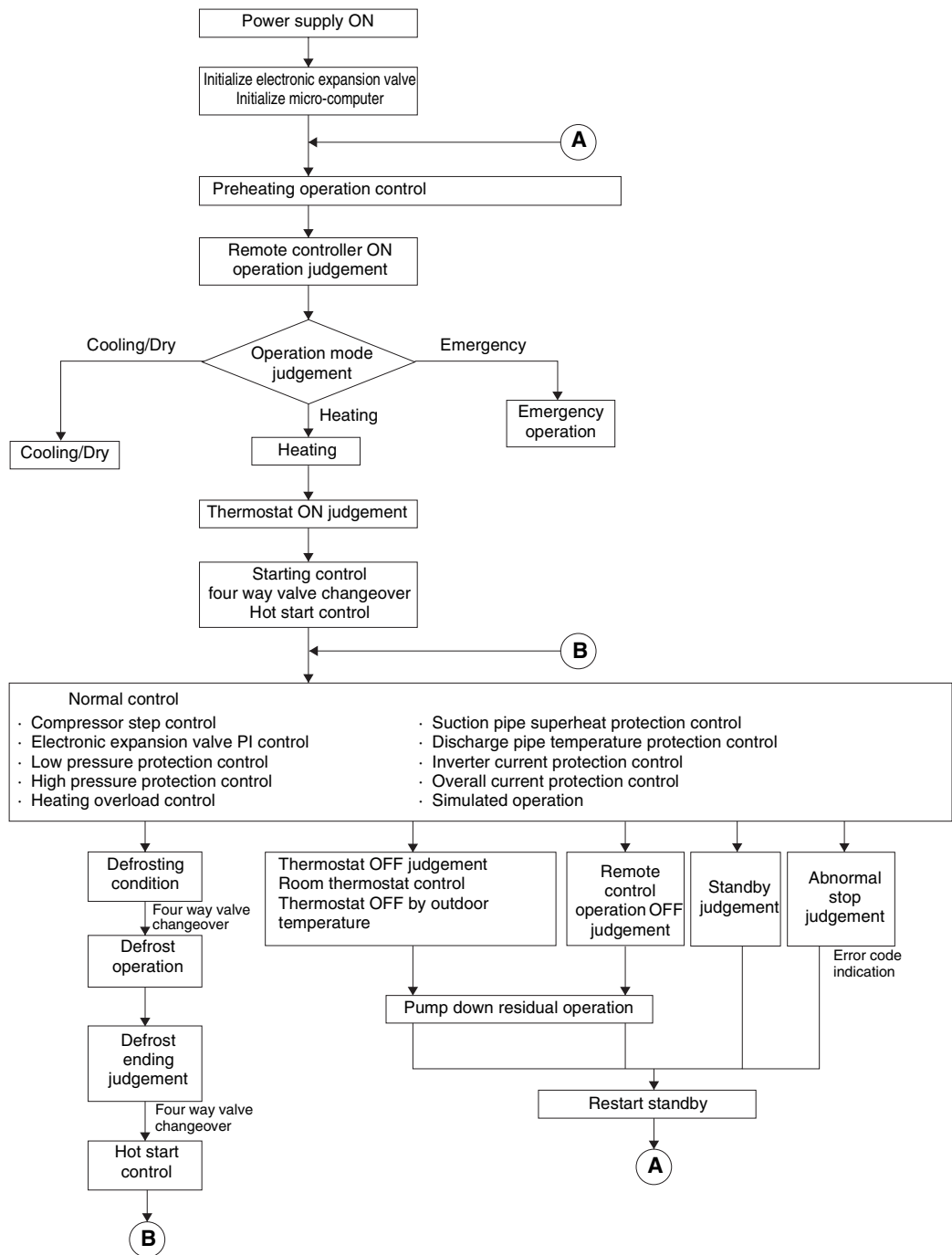

3. Function Details

3.1 Indoor Unit

3.1.1 Set Temperature and Control Temperature

The relationship between "Set temperature by remote controller" and "Control target temperature" is as shown below.

		14	15	16	17	18	19	20	21	22	23	24	25	26	27	28	29	30	31	32	33	34	35°C	
Cooling	Set temperature by remote controller											●			●									
	Control target temperature											●			●									
Heating	Set temperature by remote controller									●		●												
	Control target temperature											●												

The ● mark indicates the "Control target temperature" (°C) as an example when the "Set temperature by remote controller" is set there.

3.1.2 Thermostat Control

According to a difference between the temperature set by the remote controller and the actually detected room temperature (*1), the thermostat is turned ON or OFF.

ΔT : Detected room temperature - Temperature set by remote controller

T_{ro} : Room temperature detected when dry operation is started

T_r : Room temperature detected by thermistor

● In normal operation

In cooling

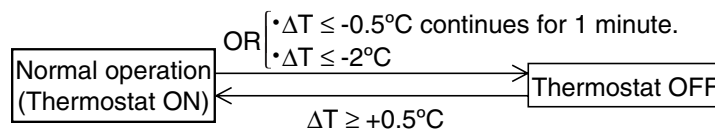

In heating

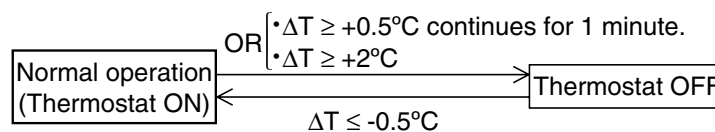

● In dry operation

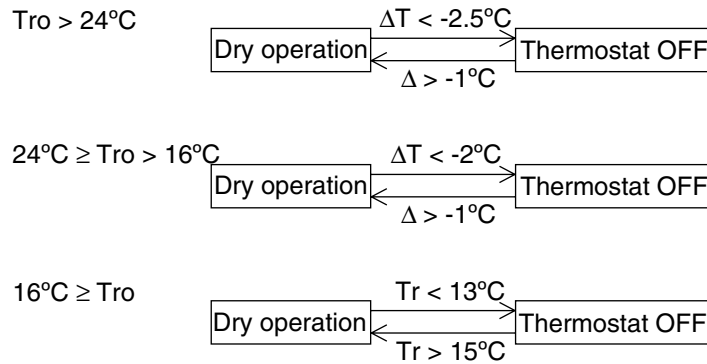

Note: *1: The thermistor to detect room temperature is as follows according to field setting.
 · Factory setting: Indoor unit suction air thermistor
 · When set to remote controller thermistor: Indoor air thermistor in the remote controller

3.1.3 Switchable Fan Speed

The setting airflow rate when the thermo. is turned on and off by operation mode is as shown below. The airflow rate when the thermo. is turned off can be changed in field setting. The table below shows the factory setting.

		Fan
Cooling	Thermostat ON	Set
	Thermostat OFF	Set
Program Dry	Thermostat ON	L
	Thermostat OFF	OFF
Heating	Thermostat ON	Set
	Thermostat OFF	LL
Fan		Set
Stop		OFF

3.1.4 Swing Pattern Selection

Swing flaps operate as shown in the table below.

			Fan
Cooling	Flap Set	Thermostat ON	Set
		Thermostat OFF	Set
	Swing Set	Thermostat ON	Swing
		Thermostat OFF	Swing
Program Dry	Flap Set	Thermostat ON	Set
		Thermostat OFF	Set
	Swing Set	Thermostat ON	Swing
		Thermostat OFF	Swing
Heating	Flap Set	Thermostat ON	Set
		Thermostat OFF	Horizontal
	Swing Set	Thermostat ON	Swing
		Thermostat OFF	Horizontal
Fan	Flap Set		Set
Stop	Swing Set		Swing

3.1.5 Drain Pump Control (Only for FCQG)

- Cooling / Dry Operation
Normally drain pump ON (Thermostat ON/OFF)

■ Heating

When the following condition consists by mounting the adaptor for wiring PCB, the drain pump is turned on.

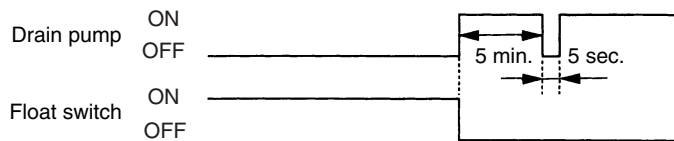

3.1.6 Control when the Operation Mode is Set to “Auto”

Setting the operation mode to “Auto” with the remote controller, the unit is controlled regarding the contents shown below.

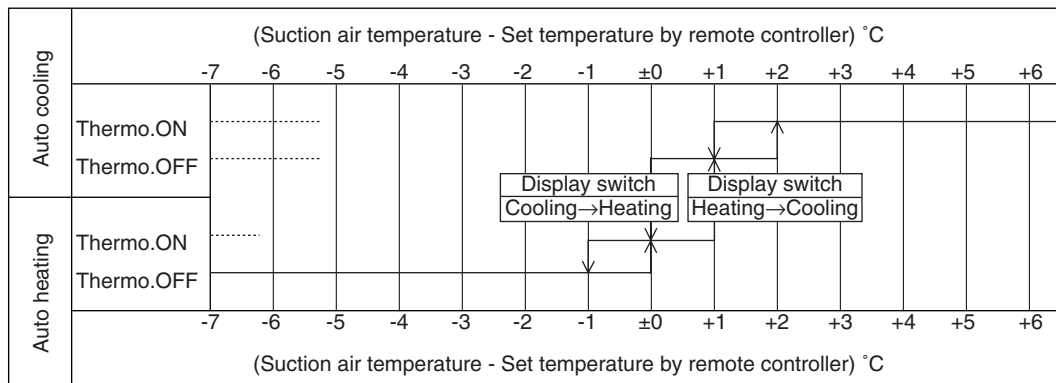

3.1.7 Dew Condensation Prevention Control

■ FCQG

When indoor unit humidity is high during the operation, the moving range of louvers is limited.

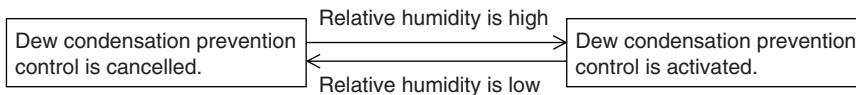

The operation of louvers while this control is activated is as shown below.

Indoor unit	Setting of louvers	Dew Condensation Prevention Control	
		Cancelled	Activated
<p>Position of louvers (when viewed from horizontal direction)</p>	P0	P0	P1
	P1	P1	P1
	P2	P2	P2
	P3	P3	P3
	P4	P4	P4
	Swing	P0~P4	P1~P4

■ FHQG

In cooling and dry operation, the following control is carried out in order to prevent dew condensation when the horizontal blade blows air downward.

Starting condition

- & (• Horizontal blade is set to downward flow (P3 or P4)
- Cooling operation (compressor operation) continues for 30 minutes.

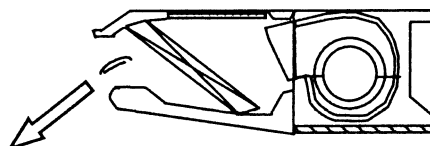

Dew condensation prevention control

Dry operation with horizontal airflow is carried out for 1 hour. (P2)

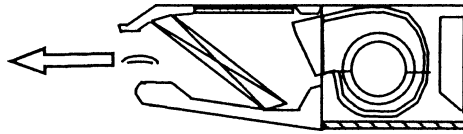

- i** **Note:** 1. When there is any change to heating/fan modes, airflow direction and operation ON/OFF state during dew condensation prevention control, this control is reset.

3.1.8 Freeze-up Prevention Control

The unit will perform the forced thermostat off function in following conditions:

Thermostat off due to freeze-up prevention.

Based on the judgement to prevent the indoor heat exchanger from freezing, the thermostat is forcibly turned OFF.

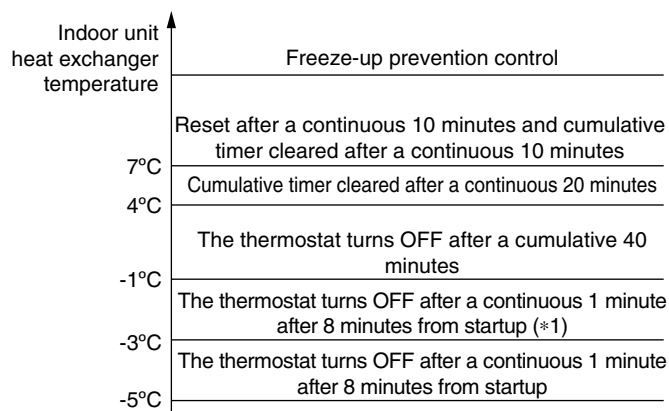

*1 FHQG Only

3.1.9 Monitoring Control

When the indoor unit fan is turned off while the thermo. for cooling, heating and drying is off, even if the indoor unit temperature recovers afterwards and becomes the one that turns the thermo. on, the thermistor cannot detect indoor unit temperature because the suction air thermistor of indoor unit is installed inside the machine.

In order to prevent such a condition, this monitoring control has the function of detecting indoor unit temperature by operating the fan at certain intervals when the fan is turned off while the thermo. is off.

3.1.10 Defrost Control

When the heating operation continues at a low outdoor air temperature, the frost adhered to the surface of outdoor heat exchanger deteriorates heating capacity.

When the amount of adhered frost exceeds a certain level, the operation will automatically switch to the cooling cycle to melt the frost.

When the frost is melted, the normal heating operation will be resumed.

3.1.11 Draft Avoidance Control

In order to prevent cold wind from directly blowing to the user when the indoor heat exchanger temperature is low, such as the timing that heating started and defrost ended, this control has the function of changing the airflow rate to LL tap and fixing the airflow direction to horizontal.

3.2 Outdoor Unit

3.2.1 Abnormal Stop

When the following items show abnormal values, the thermostat turns OFF and error is determined based on the number of retry in order to protect the compressor and other devices.

Item	Criteria	Number of retry
Low pressure	0.12 MPa or less continues for 5 minutes	10 times in 200 minutes
High pressure	HPS activated or over 3.92 MPa continues for 1 minute	15 times in 300 minutes
Discharge pipe temperature	RZQG71LV1B Temperature over 110°C continues for 15 minutes or temperature exceeds 125°C	10 times in 200 minutes
	RZQG100-140LV1B Temperature over 115°C continues for 10 minutes or temperature exceeds 125°C	
Power supply	Negative-phase-sequence power	None (No retry)

3.2.2 Restart Standby

To prevent compressor from frequent ON/OFF and equalize pressure in refrigerant line, conducts forced thermostat OFF for 3 minutes after compressor stopping. Moreover, outdoor unit fan conducts residual operation for a period of time to expedite equalization and prevent refrigerant from entering in evaporator.

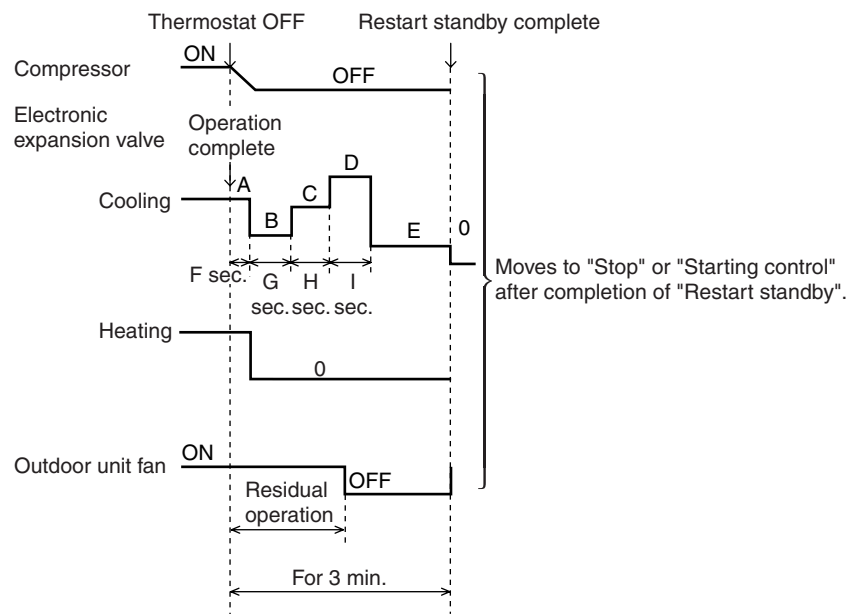

	RZQG71LV1B	RZQG100-140LV1B
A	480	480
B	480	480
C	480	480
D	480	480
E	480	480
F	60	10
G	60	30
H	30	30
I	30	30

3.2.3 Preheating Operation Control

After the compressor has been turned OFF, the preheating operation control will be activated in order to avoid refrigerant from dissolving in the compressor oil and quick increase of heating level during the heating operation.

Starting Conditions

- Compressor stopping
- & (
 - 6 hours or less after turning ON the power.
 - or (
 - 1 hour or more after turning OFF the compressor.
 - & (
 - Outdoor air temperature is not declining.
 - Discharge pipe temperature < 40°C

Ending Conditions

- Operation of thermostat is established.
- & (
 - 6 hours or more after turning ON the power.
 - or (
 - 1 hour or less after turning OFF the compressor.
 - & (
 - Outside temperature is declining.
 - Discharge pipe temperature > 43°C

3.2.4 Outdoor Unit Fan Control during Heating Thermostat OFF

In order to prevent the false detection of outdoor suction temperature while the heating thermo. is off (excluding the timing when the remote controller is off), the outdoor unit fan is turned on and off at certain intervals.

Starting condition: Outdoor air temperature > 25°C

Ending condition: Outdoor air temperature < 20°C

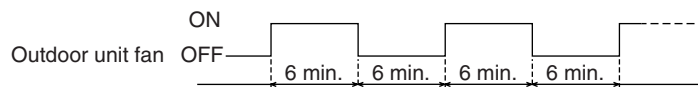

3.2.5 Starting Control

When compressor start up, the starting frequency is fixed for specified period of time at low frequency to prevent returning of refrigerant.

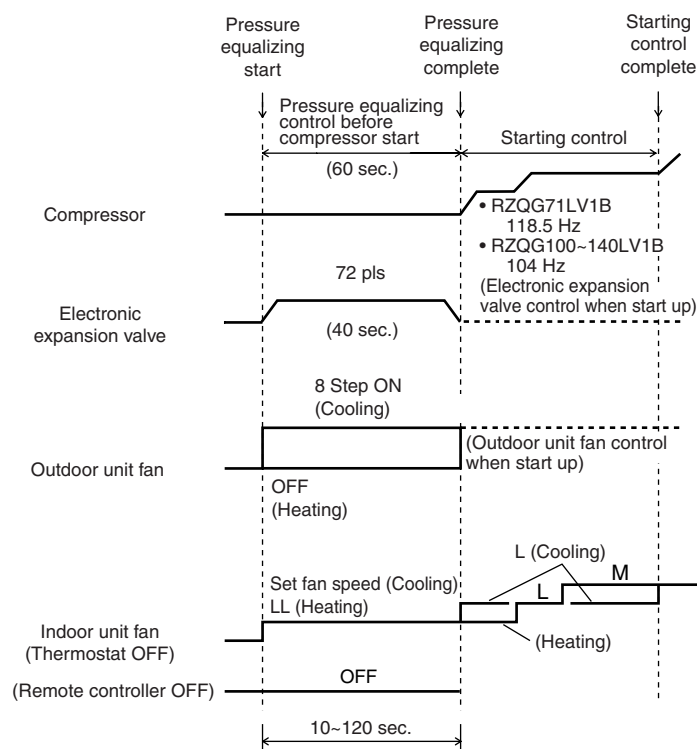

3.2.6 Room Thermostat Control

Based on the difference between the set temperature by remote controller and indoor unit suction air temperature, the thermo. is turned on and off.

ΔT = Indoor suction air temperature – temperature set by remote controller (Cooling)

ΔT = Temperature set by remote controller – indoor suction air temperature (Heating)

Thermostat ON Condition

$\Delta T > +0.5^{\circ}\text{C}$

Thermostat OFF Condition

- or
- $\Delta T \leq -0.5^{\circ}\text{C}$ continues for 1 minute (for RZQG71LV1B)
 - & (
 - $\Delta T \leq -0.5^{\circ}\text{C}$ continues for 1 minute
 - 5 minutes or more after start up (for RZQG100 - 140LV1B)
 - $\Delta T \leq -2^{\circ}\text{C}$ (Cooling)
 - $\Delta T \leq -2.5^{\circ}\text{C}$ (Heating)
- When changed suddenly from $\Delta T \geq +1.5^{\circ}\text{C}$ to $\Delta T \geq -0.5^{\circ}\text{C}$

3.2.7 Compressor Step

The compressor operation frequency is controlled in order to keep a constant evaporation temperature in cooling and a constant condensing temperature in heating.

Cooling

Δt cool = Remote controller set temperature - Indoor return air temperature.

Depending on Δt cool and the cooling load, the target evaporating temperature will be a value between 2°C and 20°C.

Heating

Δt heat = Indoor return air temperature - Remote controller set temperature.

Depending on Δt heat and the heating load, the target condensing temperature will be a value between 42°C and 54°C. (for RZQG100-140LV1B : 42°C and 50°C)

Step No.	Compressor operation frequency		
	RZQG71LV1B	RZQG100LV1B	RZQG125-140LV1B
1	—	30 Hz	30 Hz
2	—	33 Hz	33 Hz
3	57 Hz	36 Hz	36 Hz
4	61.5 Hz	40 Hz	40 Hz
5	66 Hz	44 Hz	44 Hz
6	72 Hz	48 Hz	48 Hz
7	78 Hz	52 Hz	52 Hz
8	85.5 Hz	56 Hz	56 Hz
9	93 Hz	60 Hz	60 Hz
10	102 Hz	65 Hz	65 Hz
11	109.5 Hz	70 Hz	70 Hz
12	118.5 Hz	76 Hz	76 Hz
13	127.5 Hz	82 Hz	82 Hz
14	136.5 Hz	89 Hz	89 Hz
15	145.5 Hz	96 Hz	96 Hz
16	151.5 Hz	104 Hz	104 Hz
17	154.5 Hz	112 Hz	112 Hz
18	174 Hz	121 Hz	121 Hz
19	183 Hz	129 Hz	129 Hz
20	192 Hz	137 Hz	137 Hz
21	201 Hz	144 Hz	144 Hz
22	211.5 Hz	—	151 Hz
23	222 Hz	—	159 Hz
24	232.5 Hz	—	167 Hz
25	243 Hz	—	175 Hz
26	253.5 Hz	—	180 Hz
27	265.5 Hz	—	—
28	277.5 Hz	—	—
29	289.5 Hz	—	—

: Maximum frequency in cooling

3.2.8 General Electronic Expansion Valve Control

When cooling/heating, PI control of electronic expansion valve is conducted to keep the heat exchanger outlet subcooling degree constant.

- Target heat exchanger outlet subcooling degree > actual heat exchanger outlet subcooling degree
→ The electronic expansion valve will close.
- Target heat exchanger outlet subcooling degree < actual heat exchanger outlet subcooling degree
→ The electronic expansion valve will open.
- * The value of target heat exchanger outlet subcooling degree varies depending on change of discharge pipe superheat degree of inverter compressor, etc.

3.2.9 Hot Start Control (Only in Heating Operation)

In heating, when performing a startup, or after the defrosting cycle has been completed, the indoor fan will be controlled in order to prevent cold air draft and secure the starting performance (quick pressure build-up).

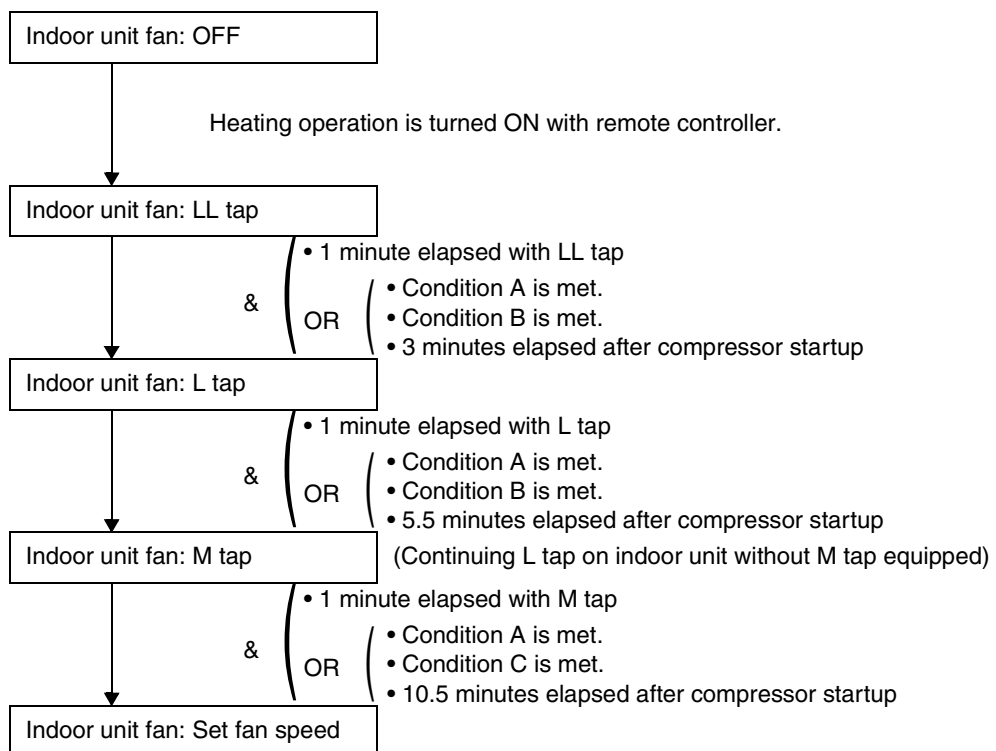

Condition	
A	Indoor unit heat exchanger temperature > 34°C
B	Indoor unit heat exchanger temperature > indoor suction air temperature +17°C (+12°C if outdoor air temperature is < 5°C)
C	Indoor unit heat exchanger temperature > indoor suction air temperature +22°C (+20°C if outdoor air temperature is < 5°C)

3.2.10 Night-time Quiet Operation

A. Setting by Remote Controller

Night-time quiet operation can be set by field setting from the wired remote controller. By estimating current time based on the change of outdoor air temperature, the low noise operation is automatically performed at night (from 22:00 to 8:00) by limiting the number of revolutions of outdoor unit fan and the operation frequency of the compressor. (The time at night is target.)

B. Setting by Demand Operation (Option)

Short circuit between COM-LNOP on terminal of demand adaptor.
Low sound running to be done with limited outdoor fan speed compressor running frequency.



Note: In the case of capacity priority setting
Setting the "Capacity priority setting" from the field setting mode of indoor remote controller, the capacity is prioritized in the operations of both A and B, and when the air conditioning load becomes high, the low noise operation stops and the normal operation starts. If you cancel the capacity priority setting when the low noise setting remains, the low noise setting is prioritized, and even if air conditioning load becomes high, the noise operation continues.

3.2.11 Low Pressure Protection Control

In order to prevent abnormal low pressures in the system, the below control function will be activated.

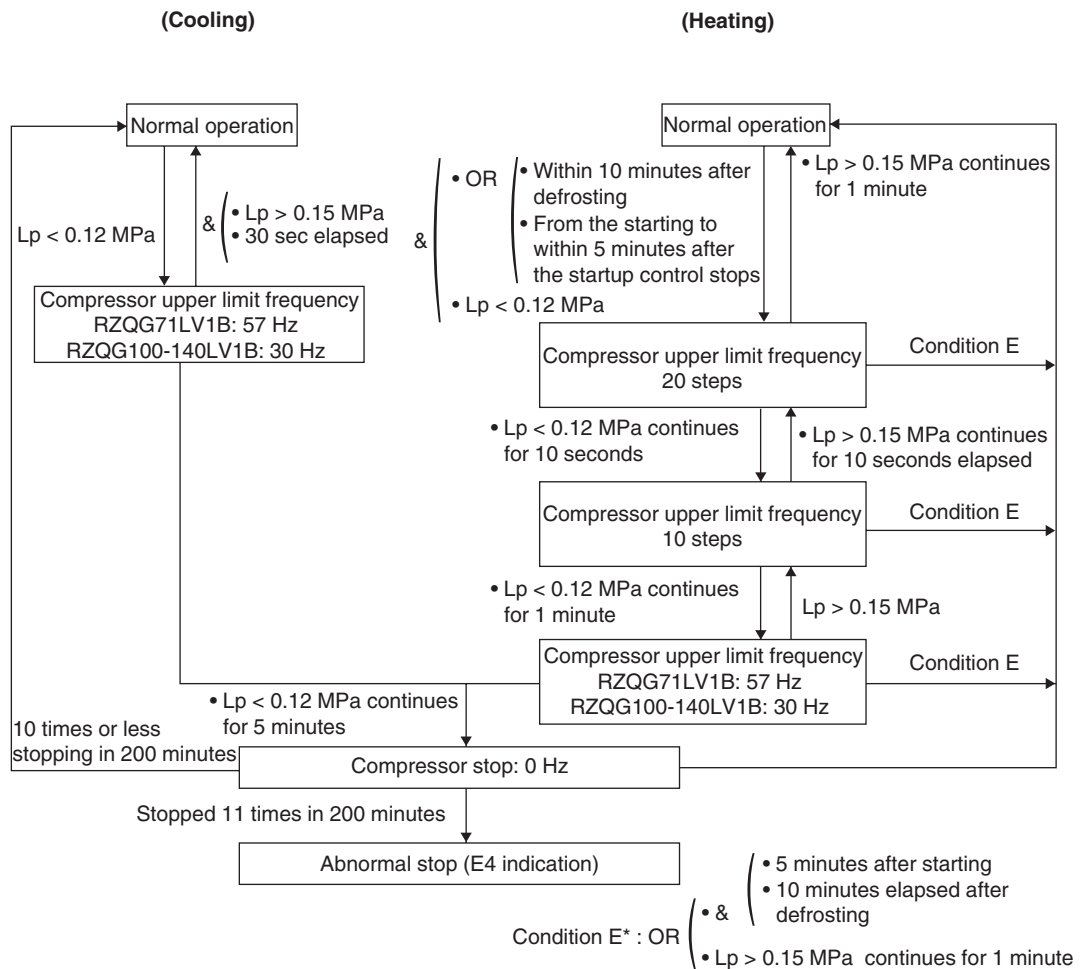

3.2.12 High Pressure Protection Control

In order to prevent abnormal high pressures in the system and hence avoiding activation of the high pressure safety device the below control function will be activated.

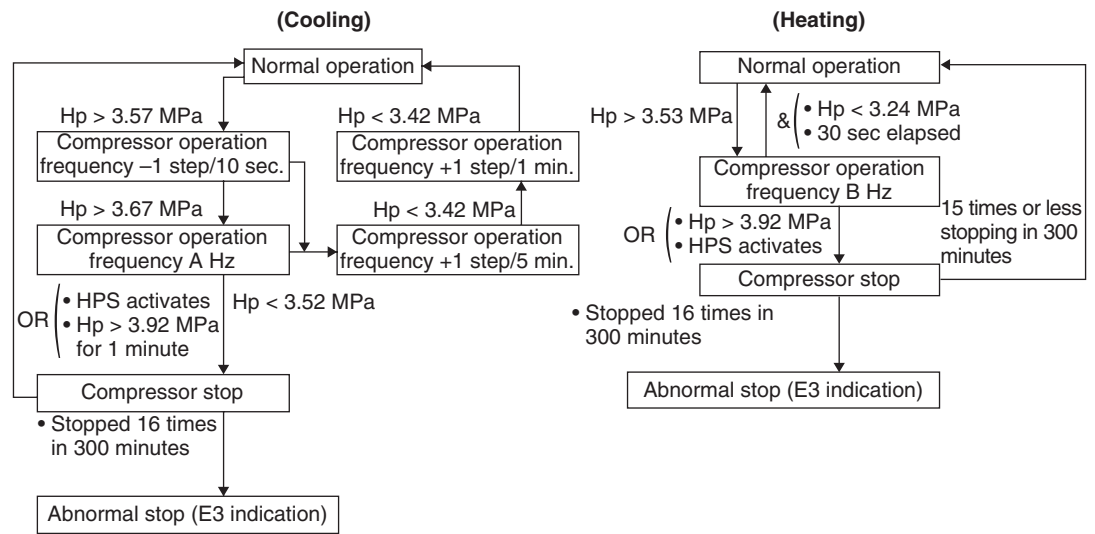

As the bearing resistance limit pressure decreases during slow operation of the compressor, the lower limit of frequency is restricted.

[In cooling/heating operation]

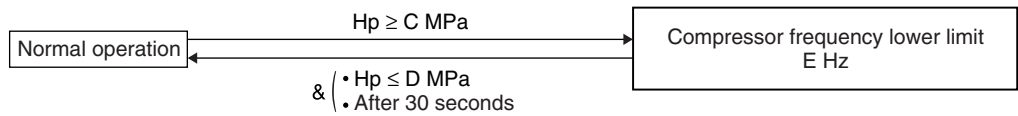

	RZQG71LV1B	RZQG100-140LV1B
A Hz	118.5 Hz	52 Hz
B Hz	57 Hz	52 Hz
C MPa	3.04 MPa	2.70 MPa
D MPa	2.84 MPa	2.60 MPa
E Hz	57 Hz	40 Hz

3.2.13 Heating Control at High Outdoor Air Temperature

Under the condition of heating overload, control the outdoor unit fan in order to secure the difference of elevation pressure and the pressure ratio of the compressor.

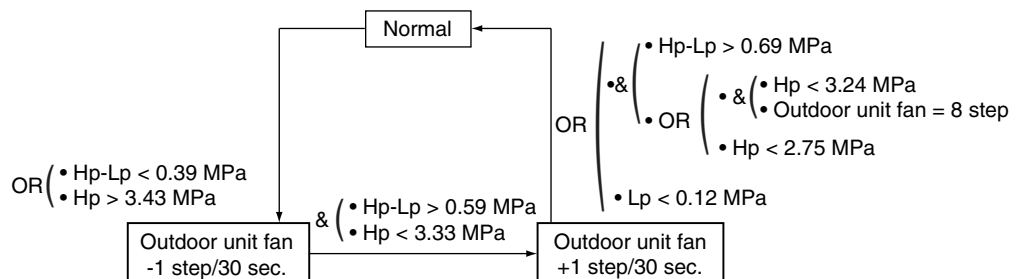

3.2.14 Suction Pipe Superheat Protection Control (Only in Heating Operation)

In case the suction superheat value in heating mode is too high, the oil return to the compressor will be insufficient. In order to avoid that the compressor oil will be accumulated in the outdoor unit heat exchanger, the upper limit frequency will be controlled.

SH: Superheat degree

EV: Electronic expansion valve

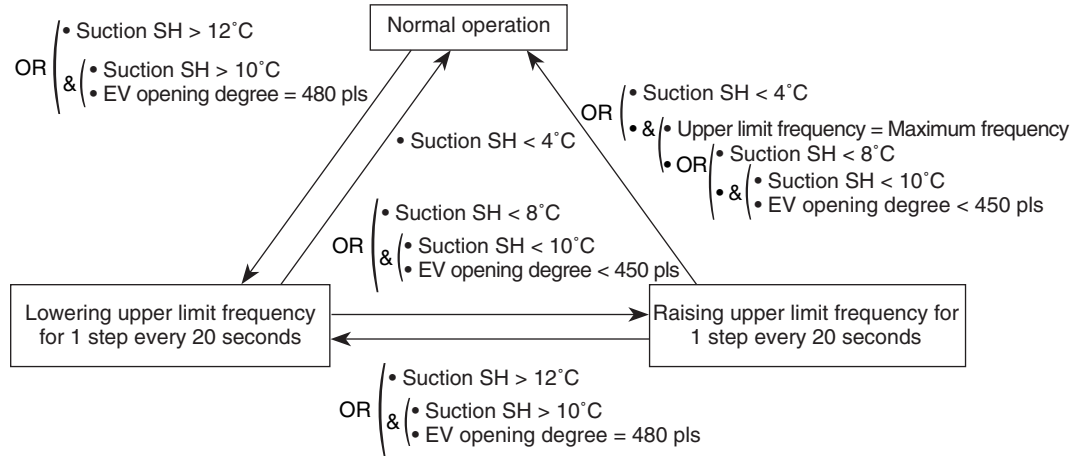

3.2.15 Discharge Pipe Temperature Protection Control

Electronic expansion valve opening degree and the compressor operating frequency will be controlled in order to avoid abnormal high compressor temperatures.

Td: Discharge pipe temperature

Compressor Operating Frequency Control

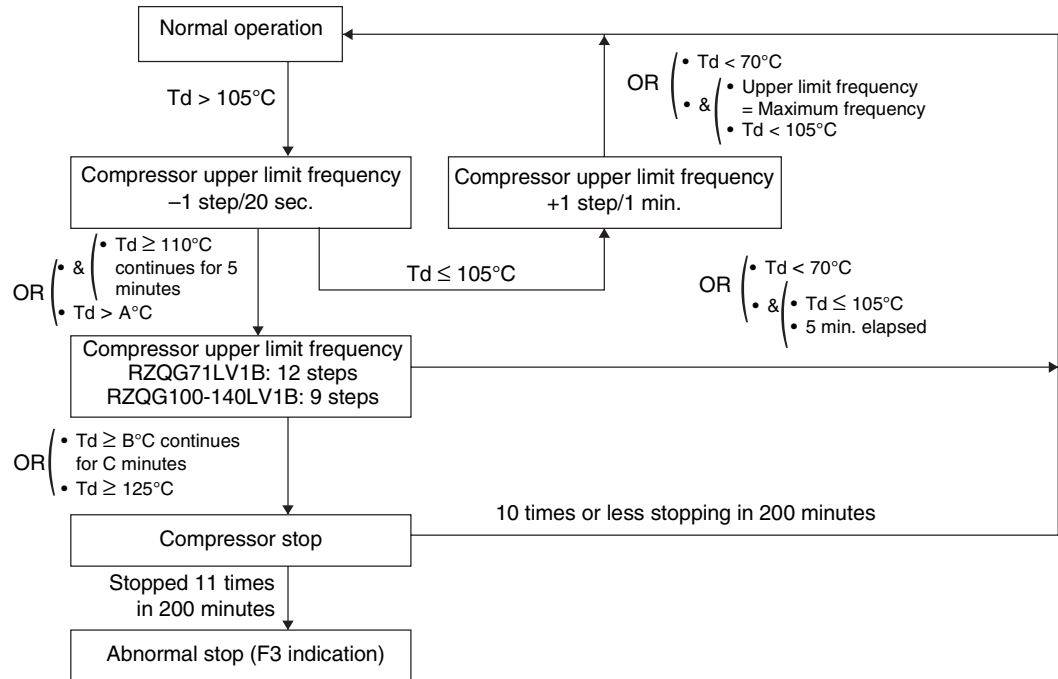

	RZQG71LV1B	RZQG100-140LV1B
A°C	100°C	115°C
B°C	110°C	115°C
C minutes	15 minutes	10 minutes

Electronic Expansion Valve Opening Degree Control

Td: Compressor discharge pipe temperature (°C)

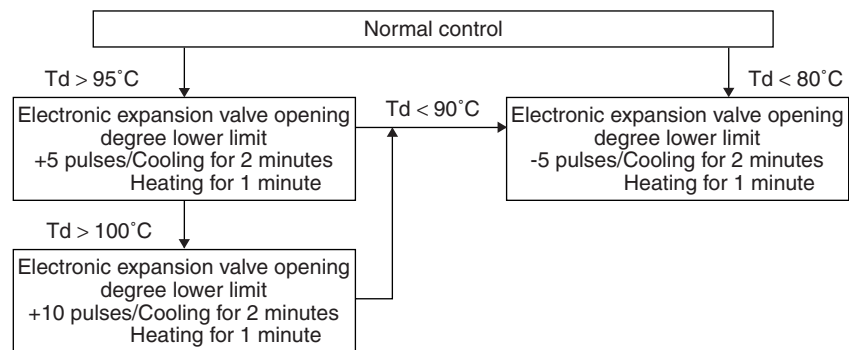

3.2.16 Capacitor Electric Discharge Control

After the operation stopped (the stop caused by the remote controller, an error, and the compressor and outdoor unit fan motor when retry thermo. is off), open phase waveform is output for about one minute for electric discharge of the capacitor.

Afterwards, electric discharge will continue due to discharge resistance until the capacitor voltage becomes 0 V. At this time, operation sound may be heard from the outdoor unit.

3.2.17 Thermostat OFF due to Outdoor Air Temperature (Only in Heating Operation)

If outdoor air temperature is high, the unit conducts forced thermostat OFF at the following temperature to protect the system.

Outdoor air temperature > 32°C

3.2.18 Inverter Current Protection Control

Restricts compressor operation frequency to prevent compressor from tripping due to inverter overcurrent.

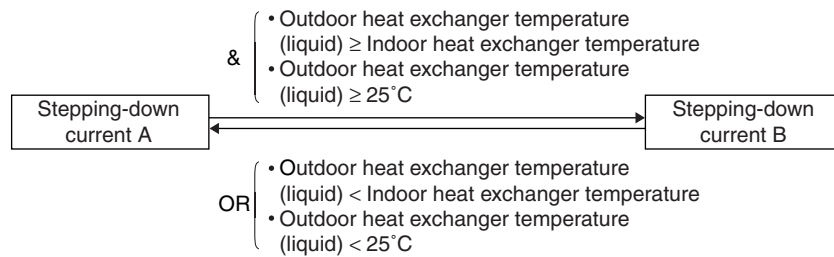
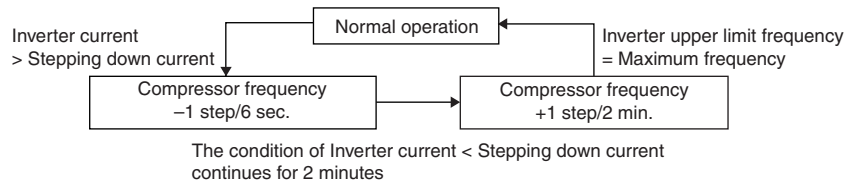

	RZQG71LV1B	RZQG100-140LV1B
A	11.0 A	14.0 A
B	13.7 A	20.0 A

3.2.19 Low Outdoor Air Temperature Control in Cooling Operation

Controls compressor and outdoor unit fan under low outdoor air temperature condition to secure pressure difference between high and low pressure.

Hp: High pressure
 Lp: Low pressure
 Ta: Outdoor air temperature
 Tfin: Inverter fin temperature

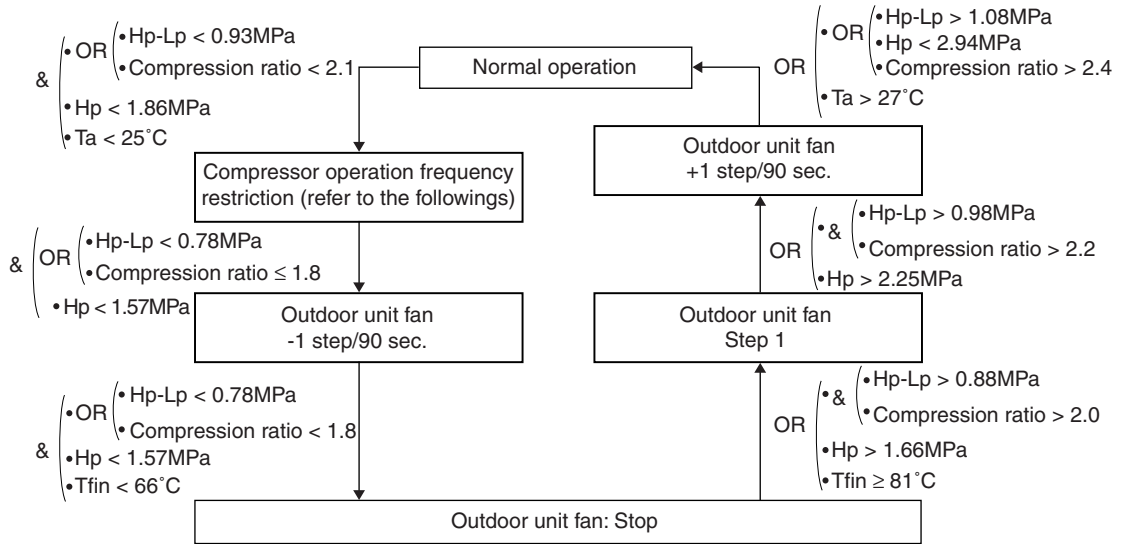

Frequency Restriction

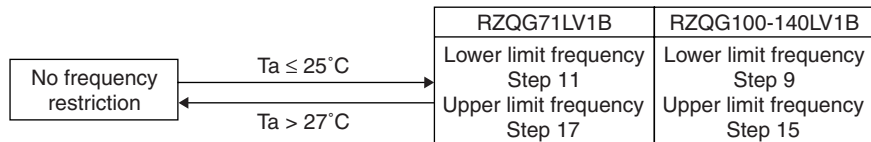

3.2.20 Protection Control by Overall Current

Monitors the overall current and restricts the upper limit compressor operating frequency to prevent circuit breakers from exceeding the rated capacity.

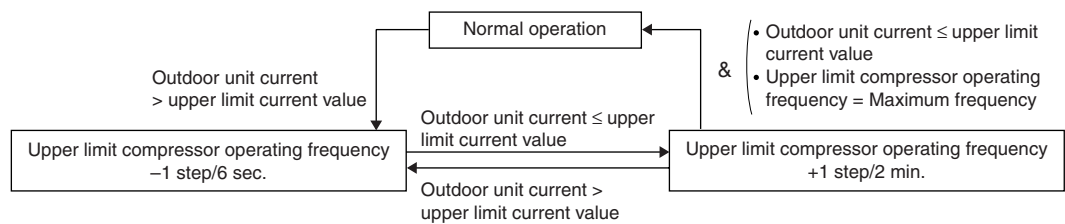

Upper limit current (A)

Takes the following values depending on the outside temperature. Also varies depending on model.

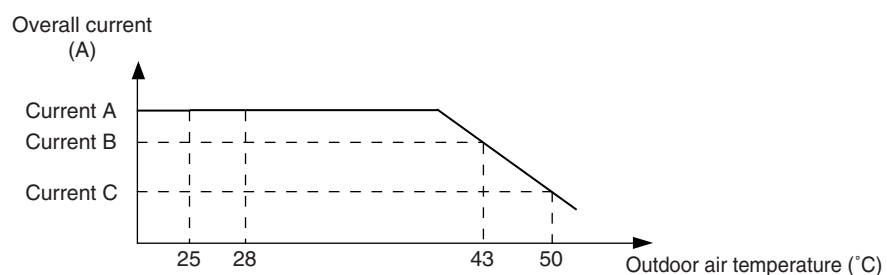

	RZQG71LV1B	RZQG71-140LV1B
A	16.0 A	25.0 A
B	8.9 A	22.0 A
C	6.0 A	20.0 A

3.2.21 Freeze-up Prevention Control

The thermostat turns OFF due to indoor unit heat exchanger temperature in order to avoid formation of ice on the indoor unit heat exchanger. (For details, refer to “Freeze-up Prevention Control”.)

3.2.22 Shortage of Refrigerant Detection Control

When judged that the deficiency in performance has been caused by the shortage of refrigerant, the abnormal stop is activated with the error code “U2” being displayed on the remote controller.

3.2.23 Piping and Wiring Incompatibility Detection Control

When the connecting pipe and the transmission connecting line are connected each to a differing outdoor unit, the abnormal stop is activated with the error code “U3” being displayed on the remote controller.

3.2.24 Pump Down Residual Operation (Only for RZQG100-140LV1B)

Conducts pump down residual operation when compressor stops to collect refrigerant in evaporator for preventing liquid refrigerant from remaining in the evaporator.

Contents of Control

Compressor: 70 Hz
Electronic expansion valve: 0 pls

Ending Condition

OR (• 30 seconds elapsed with residual operation
• $L_p < 0.2$ MPa

3.2.25 Oil Recovery Operation

When the compressor runs at low frequency for a long time, the failure of recovering oil may cause the shortage of oil level. Therefore, the oil recovery operation is performed by increasing the compressor operation frequency for five minutes.

* The more the unit operates at low frequency, the higher the frequency of oil recovery operation becomes.

3.2.26 Defrost Operation

When in heating mode, a defrost operation will be conducted in order to avoid ice formation on the outdoor unit heat exchanger.

Starting Conditions

Defrost will start when the following conditions have been realized:

- & (
- Integrated compressor running time is 25 minutes or more since the completion of the previous defrost operation.
- OR (
- Defrost upper limit time A is met.
 - Outdoor unit heat exchanger temperature is within the defrost request area.

Defrost conditions

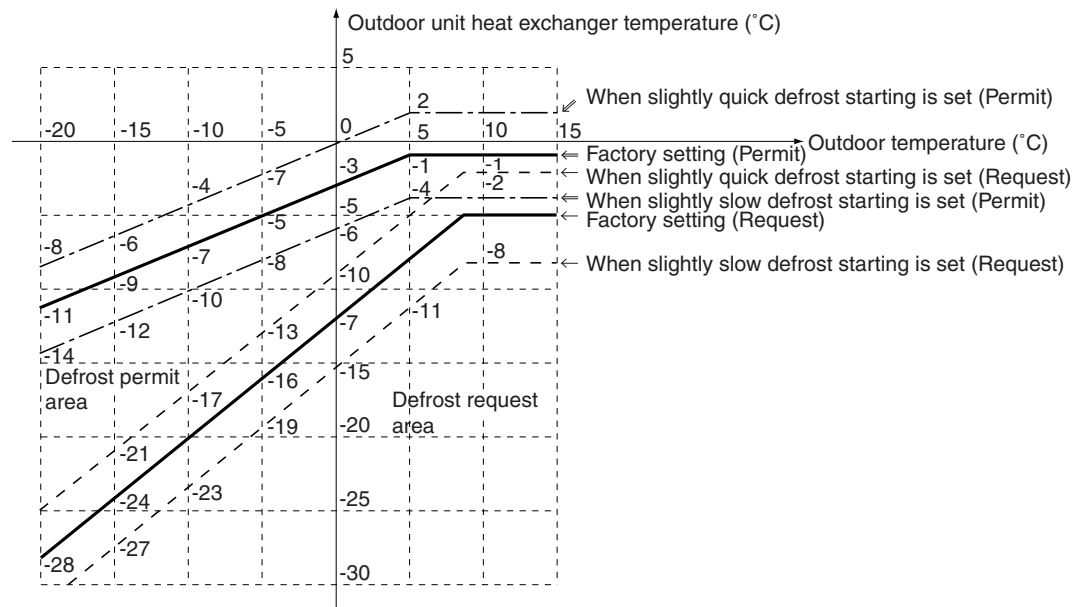

Defrost upper limit A

Depending on the defrost start setting (field setting mode of the indoor unit remote controller), frost upper limit time A becomes as shown in the table below.

	When quick defrost starting is set	Factory setting	When slow defrost starting is set
Outdoor air temperature > -5°C	40 minutes	2 hours	6 hours
Outdoor air temperature ≤ -5°C	40 minutes	6 hours	8 hours

Defrost Control

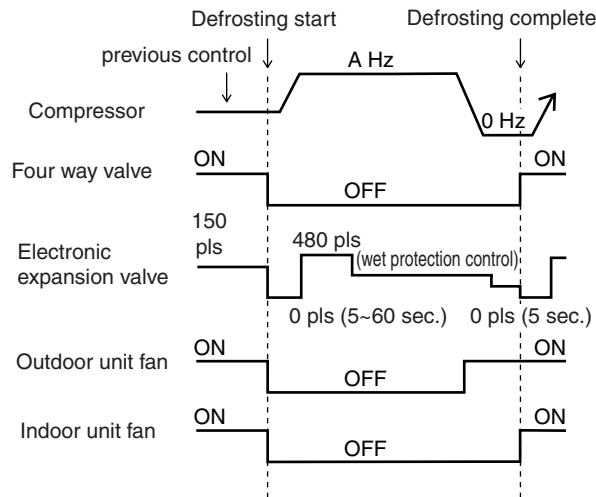

Model	A
RZQG71LV1B	Step 25
RZQG100-140LV1B	Step 20

Defrost Ending Conditions

Defrosting ends when the following conditions have been realized. Note that defrosting can be operated for 10 minutes at longest.

Hp: High pressure

Tb: Heat exchanger distributor pipe temperature

Tm: Intermediate heat exchanger temperature

- OR
 - &
 - Defrost Time > 10 sec.
 - Hp > 2.45 MPa
 - &
 - Defrost Time > 1 min.
 - Tb > 10°C
 - Tm > 12°C
 - &
 - Defrost Time > 9 min.
 - Tb > 8°C
 - Tm > 10°C

3.2.27 Outdoor Unit Fan Control when Frost is Adhered

During heating, when frost has adhered to the outdoor unit heat exchanger and the ventilation flue is blocked, the fan sound increases.

To prevent this fan noise from increasing, the number of revolutions of fan is lowered.

3.2.28 Emergency Operation

- No transmission is performed between indoor and outdoor unit.
- During cooling, the cycle of operation for 20 minutes and stop for 10 minutes is repeated.
- During heating, defrost is performed once every one hour.
- Under other conditions, the same control as the normal control is performed.

3.2.29 Simulated Operation Function

In case of a thermistor error, simulated operation is performed in two different ways as shown below even while the error is detected.

- A. Operation continues while the error code is displayed on the remote controller.
Applicable thermistors
- Outdoor air temperature thermistor
 - Heat exchanger distribution pipe thermistor (in cooling)
 - Intermediate heat exchanger thermistor (in heating)
 - Liquid pipe thermistor
 - Indoor suction air thermistor
 - Indoor heat exchanger thermistor
- B. Operation continues even the error is detected. The remote controller displays error code only when the "Inspection/Test Run" button is pressed.
Applicable thermistors
- Remote controller thermistor
 - Radiation fin thermistor



Note: In case of a thermistor error other than A and B above, an abnormal stop is made and no simulated operation is carried out.

- Applicable thermistors
- Suction pipe thermistor
 - Discharge pipe thermistor
 - Heat exchanger distribution pipe thermistor (in heating)
 - Intermediate heat exchanger thermistor (in cooling)

3.2.30 Test Operation Control

When operating in cooling mode for the first time after installation or operating in cooling mode by pressing the indoor unit inspection button, the unit will perform a test operation for about 3 minutes.

* Make sure that the initial operation after installation is performed by the cooling operation.

(Until the test run is complete, the heating operation cannot be performed.)

Even when the heating operation is performed by pressing the test run button of the indoor unit remote controller, "Test run mode" cannot be entered.

(The heating operation is performed with forced thermo. ON.)

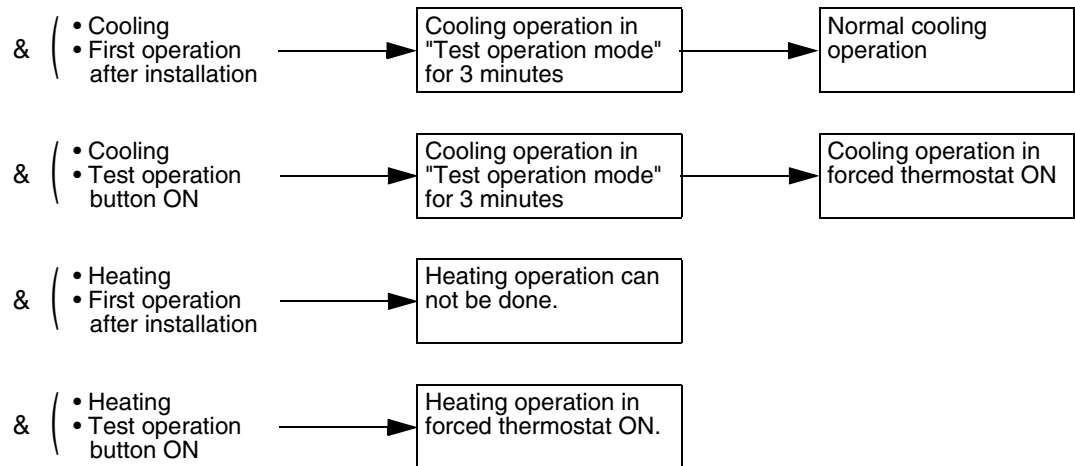

Note:

- In the "Test run mode", errors will be determined all at once in order to detect problems of field setting conditions such as a case that the opening of stop valve has been forgotten.
- During the test run, if the error code shown below is displayed, take measures according to the instructions.
 - (1) When the error code E3, E4 or L8 is displayed on the remote controller, there is possibility that either the stop valve is closed or the airflow outlet is obstructed.
 - (2) When the error code U2 is displayed on the remote controller, check for voltage imbalance.
 - (3) When the error code U4 or UF is displayed on the remote controller, check the inter unit branch wiring connection.
 - (4) When the error code L4 is displayed on the remote controller, there is possibility that the airflow passage is closed.
- When there is no error code display, cooling operation continues.
(However, this control is once again performed after refrigerant is recovered by pump down and at the time of the first * operation after the outdoor unit PCB replacement.)

Part 6

Field Setting

1. Test Operation	50
1.1 Pre-run Checks	50
1.2 Remote Controller Confirmation.....	50
1.3 Test Run.....	51
1.4 Precautions Regarding Test Run	51
1.5 Failure Diagnosis at the Moment of First Installation	52
2. Field Setting from Remote Controller.....	53
2.1 Wired Remote Controller.....	53
2.2 Wireless Remote Controller	56
2.3 Overview of the Field Setting on the Outdoor Units	57
2.4 Setting Contents and Code No. for Outdoor Units	62
2.5 Quiet (Low Noise) Operation.....	63
2.6 I-Demand Function.....	65
2.7 Setting for Low Humidity Application.....	66
2.8 Defrost Start Setting.....	70
3. Field Setting from Outdoor Unit PCB	71
3.1 Location of DIP Switch and BS Button	71
3.2 Field Setting for Outdoor Unit.....	72
4. Emergency Operation	77
4.1 Forced Operation	77

1. Test Operation



WARNING

Live parts can be easily touched by accident.

Never leave the unit unattended during installation or servicing when the service panel is removed.

Never perform a test run with the discharge piping thermistor (R2T) and suction piping thermistor (R3T) removed, as this might break the compressor.

Do not touch the drain pump or fan if the indoor unit is operated without attaching the decoration panel. (Doing so could result in an electric shock or other injury.)



Note:

Note that during the first running period of the unit, required power input may be higher. This phenomenon originates from the compressor that requires a 50-hour run-in period before reaching smooth operation and stable power consumption.

1.1 Pre-run Checks

Items to check	
Electrical wiring Inter-unit wiring Earth wire	<ul style="list-style-type: none"> ● Is the wiring as mentioned on the wiring diagram? Make sure no wiring has been forgotten and that there are no missing phases or reverse phases. ● Is the unit properly grounded? ● Is the wiring between units connected in series correct? ● Are any of the wiring attachment screws loose? ● Is the insulation resistance at least 1 MΩ? <ul style="list-style-type: none"> - Use a 500 V mega-tester when measuring insulation. - Do not use a mega-tester for low-voltage circuits.
Refrigerant piping	<ul style="list-style-type: none"> ● Is the size of the piping appropriate? ● Is the insulation material for the piping attached securely? Are both the liquid and gas pipes insulated? ● Are the stop valves for both the liquid side and the gas side open?
Extra refrigerant	<ul style="list-style-type: none"> ● Did you write down the extra refrigerant and the refrigerant piping length?
Indoor unit	<ul style="list-style-type: none"> ● Is the indoor unit fully installed? <ul style="list-style-type: none"> - When the test run is started, the fan automatically begins turning. If a decoration panel is not attached, make sure that no work is being done on the indoor unit. - If you are using the wireless remote controller, do the test run after attaching the decoration panel to the indoor unit.

- Be sure to perform a test run.
- Be sure to fully open the liquid-side and gas-side stop valves. If you operate the unit with stop valves closed, the compressor will break down.
- Be sure to execute the first test run of the installation in cooling mode operation.
- Never leave the unit unattended with an open front panel during test run.

1.2 Remote Controller Confirmation

- The settings of the remote controller for the BRC1D series should be made in accordance with the following procedure.
- The settings of the remote controller for the BRC1E series should be made in accordance with the attached manual.

1.3 Test Run

1. Make sure the liquid and gas stop valves are open.

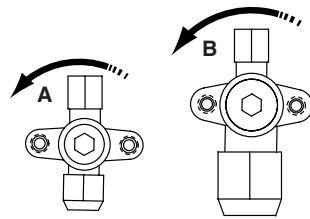

Opening direction

- A Liquid side
- B Gas side

Remove the cap and turn counterclockwise with a hex wrench until it stops

2. Be sure to close the front side panel before operation, as not doing so can cause electric shock.
3. Be sure to turn power on at least 6 hours before starting operation in order to protect the compressor.
4. Be sure to set the unit to cooling operation mode.
5. Press the inspection/test operation button of the remote controller 4 times (2 times in case of a wireless remote controller) to go into the test run mode.
6. Press the ON/OFF button within 10 seconds to start the test run and check the operation status for about 3 minutes. The refrigerant pressure may not rise immediately, even if the stop valve is opened after an air purge is performed using a vacuum pump. This is because the indoor unit refrigerant piping is closed off with electric valves inside. This will not create any problems during operation.
7. Push the air flow direction adjust button and check if the unit is responding to the new air flow direction position.
8. Press the inspection/test operation button of the remote controller 2 times to go into check mode and to make sure that the malfunction code displays "00" (=normal). In case the malfunction code does not display "00", refer to "Failure diagnosis at the moment of first installation" on page 52.
9. If the inspection/test operation button is pressed 4 times during a test run, the unit returns to normal operation.
10. Check all functions according to the operation manual.

1.4 Precautions Regarding Test Run

1. In order to detect stop valves failing to open, operation of the unit is compulsorily performed in cooling for 2-3 minutes during the first test run, even if the remote controller was set to heating operation. In this case, the remote controller will have kept displaying the heating symbol all the time and the unit will switch to heating operation automatically after elapse of that time.
2. In case you cannot operate the unit in test run mode for any unusual reason, refer to "Failure diagnosis at the moment of first installation" on page 52.
3. In case of a wireless remote controller, execute the test run only after having installed the indoor unit decoration panel with infrared receiver first.
4. In case the panels of indoor units are not yet installed to the indoor units, make sure to shut off the power supply after finishing the complete test run.
5. A complete test run surely includes shutting off power after having performed a normal operation stop on the remote controller. Do not stop operation by turning circuit breakers off.

1.5 Failure Diagnosis at the Moment of First Installation

- In case nothing is displayed on the remote controller (the current set temperature does not display), check for any of the following abnormalities before you can diagnose possible malfunction codes.
 - Disconnection or wiring error (between power supply and outdoor unit, between outdoor unit and indoor units, between indoor unit and remote controller).
 - The fuse on the outdoor unit PCB may have run out.
- If the malfunction code “E3”, “E4”, “L8” or “L9” is displayed on the remote controller, there is a possibility that the stop valves are closed.
- If the malfunction code “E3”, “E4”, “L4” or “L8” is displayed on the remote controller, there is a possibility that air inlet or air outlet are blocked.
- If the malfunction code “L2” is displayed on the remote controller, check for voltage imbalance.
- If the malfunction code “L4” or “L5” is displayed on the remote controller, check the inter-unit branch wiring connection.
- If the malfunction code “L8” is displayed on the remote controller, there is a possibility that connection is with incompatible indoor unit.

2. Field Setting from Remote Controller

Individual function of indoor unit can be changed from the remote controller. At the time of installation or after service inspection / repair, make the local setting in accordance with the following description.





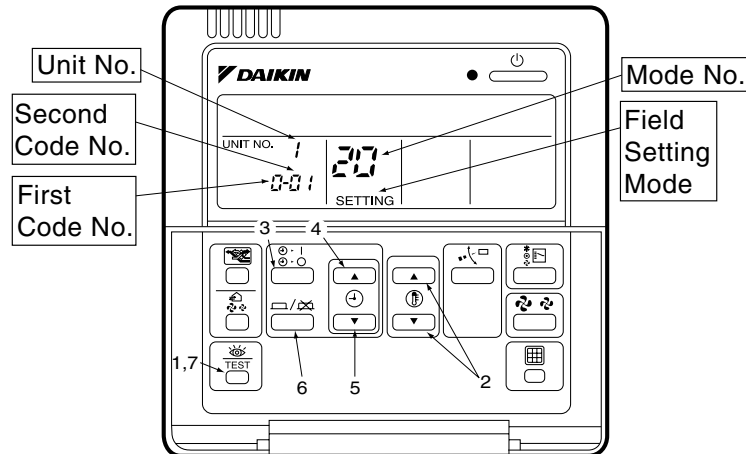

Wrong setting may cause error.

(When optional accessory is mounted on the indoor unit, setting for the indoor unit may be required to change. Refer to information in the option handbook.)

2.1 Wired Remote Controller

2.1.1 BRC1D528



1. When in the normal mode, press the “” button for 4 seconds or more, and the Field Set Mode is entered.
2. Select the desired Mode No. with the “” button (2).
3. During group control, when setting by each indoor unit (mode No. 20, 22 and 23 have been selected), press the “” button (3) and select the Indoor Unit No to be set. (This operation is unnecessary when setting by group.)
4. Press the “” upper button (4) and select First Code No.
5. Press the “” lower button (5) and select the Second Code No.
6. Press the “” button (6) once and the present settings are Set.
7. Press the “” button (7) to return to the Normal Mode.

(Example)

If during group setting and the time to clean air filter is set to Filter Contamination, Heavy, Set Mode No. to “10” First Code No. to “0”, and Second Code No. to “02”.

2.1.2 BRC1E51A7

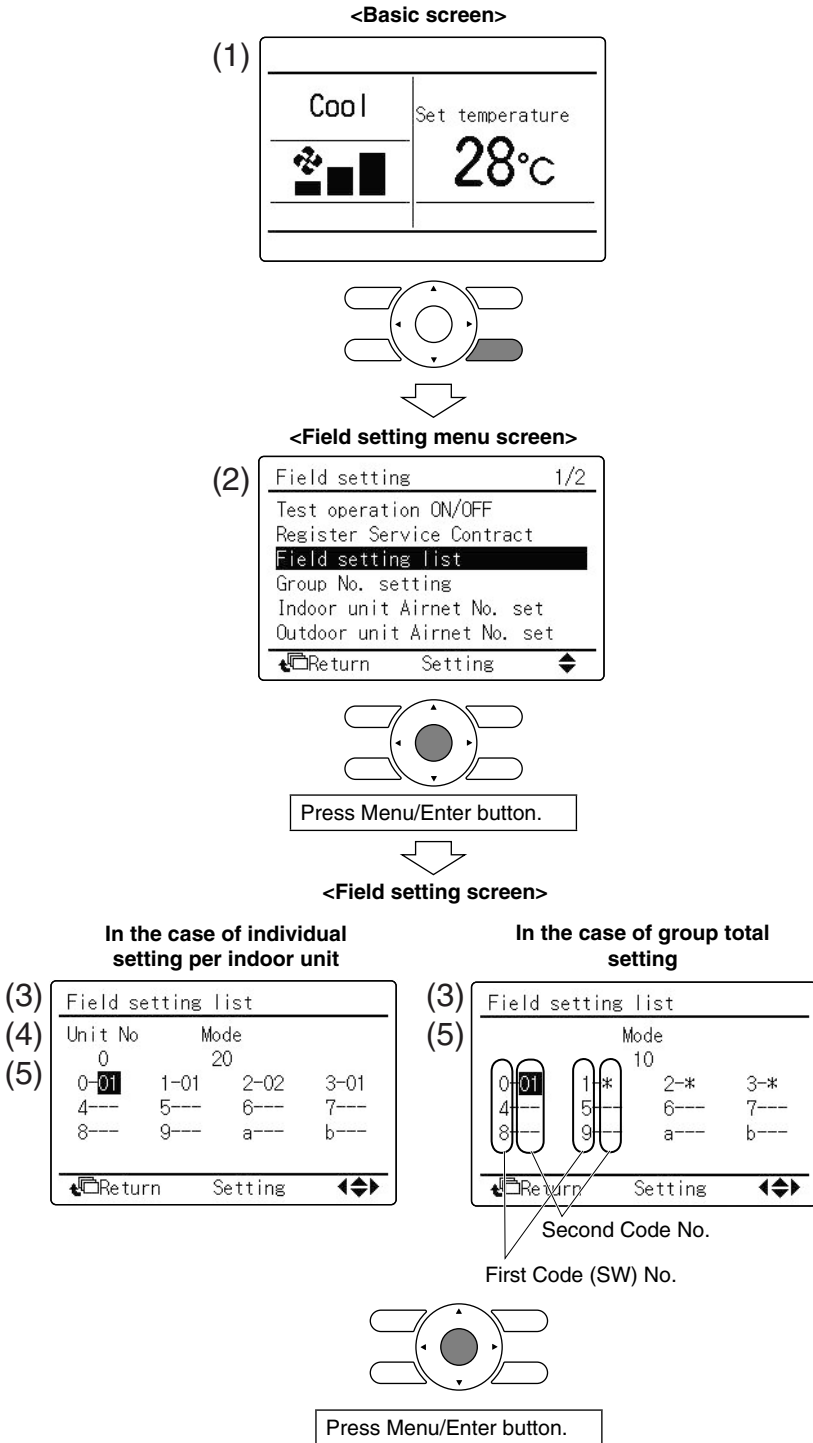

- 1 Press and hold Cancel button for 4 seconds or more.
Field setting menu is displayed.
- 2 Select **Field setting list** in the field setting menu, and press Menu/Enter button.
Field setting list screen is displayed.
- 3 Highlight the mode, and select desired "Mode No." by using ▲▼ (Up/Down) button.
- 4 In the case of setting per indoor unit during group control (When Mode No. such as **20**, **21**, **22**, **23**, **25** are selected), highlight the unit No. and select "Indoor unit No." to be set by using ▲▼ (Up/Down) button. (In the case of group total setting, this operation is not needed.)

In the case of individual setting per indoor unit, current settings are displayed. And, Second Code No. " - " means no function.
- 5 Highlight Second Code No. of the First Code No. to be changed, and select desired "Second Code No." by using ▲▼ (Up/Down) button. Multiple identical mode number settings are available.

In the case of group total setting, all of Second Code No. which may be set are displayed as " * ".
 " * " is changed to Second Code No. to be set. And, Second Code No. " - " means no function.

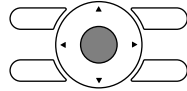
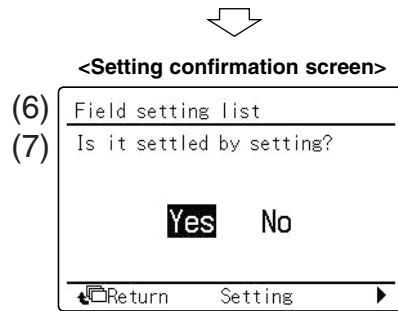

Press Menu/Enter button.



Setting confirmation

6 Press Menu/Enter button. Setting confirmation screen is displayed.

7 Select **Yes** and press Menu/Enter button. Setting details are determined and field setting list screen returns.

8 In the case of multiple setting changes, repeat “(3)” to “(7)”.

9 After all setting changes are completed, press Cancel button twice.

10 Backlight goes out, and “Connection under check Please wait for a moment” is displayed for initialization. After the initialization, the basic screen returns.

⚠ CAUTION

- When an optional accessory is installed on the indoor unit, settings of the indoor unit may be changed. See the manual of the optional accessory.
- For field setting details of the outdoor unit, see installation manual attached to the outdoor unit.

2.2 Wireless Remote Controller

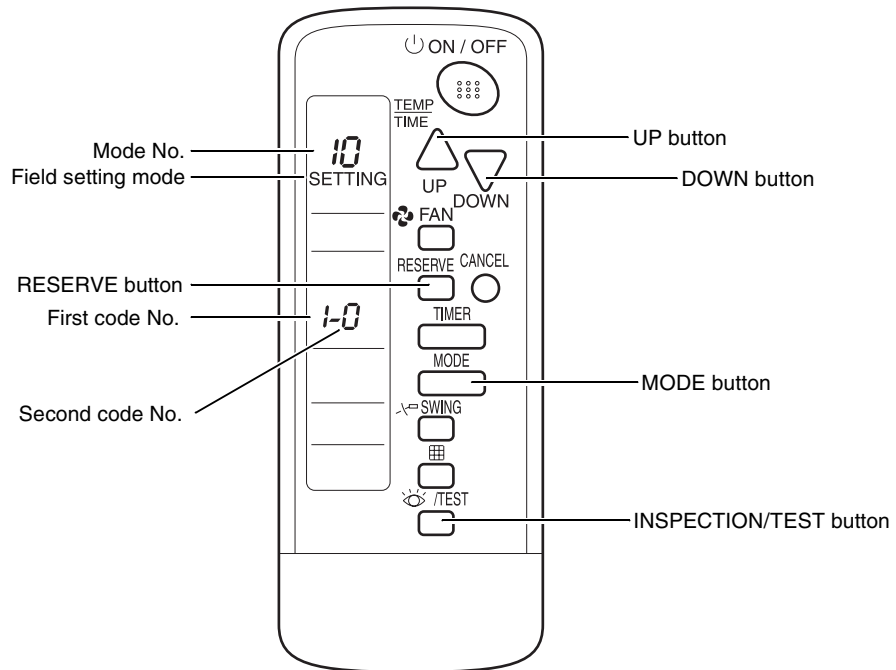

Setting

To set the field settings, you have to change:

- “Mode No.”
- “First code No.”
- “Second code No.”.

To change the field settings, proceed as follows:

Step	Action
1	Hold down the INSPECTION/TEST button for at least 4 s during normal mode to enter the “Field setting mode”.
2	Press the MODE button to select the desired “Mode No.”.
3	Press the UP button to select the “First code No.”.
4	Press the DOWN button to select the “Second code No.”.
5	Press the RESERVE button to set the present settings.
6	Press the INSPECTION/TEST button to return to the “Normal mode”.

2.3 Settings Contents and Code No. for Indoor Units

Mode No.	First Code No.	Description of Setting	Second Code No.			
			01	02	03	04
10 (20)	0	Filter cleaning sign interval Long life filter	2,500 hrs.	1,250 hrs.	—	—
	2	Remote controller thermistor	Enabled	Disabled	—	—
	3	Filter cleaning sign	Display	No display	—	—
11 (21)	2	Fan OFF at Thermostat OFF	Normal	OFF	—	—
	3	Airflow rate setting during heating	Standard	Slightly up	Up	—
	4	Automatic operation mode control	Available	Prohibition	—	—
12 (22)	3	Fan speed heating thermostat OFF	LL-speed	Set-speed	—	—
	5	Automatic restart after power failure reset	Disabled	Enabled	—	—
	6	Fan speed cooling thermostat OFF	LL-speed	Set-speed	—	—
13 (23)	0	High air outlet velocity (for high ceiling applications)	Standard	Slightly up	Up	—
	1	Selection of airflow direction	4-way flow	3-way flow	—	—
	4 (*2)	Airflow range setting	Upper	Normal	Lower	—
15 (25)	5	Individual setting of ventilation	Normal	Individual operation	—	—



- Note:**
- Settings are made simultaneously for the entire group, however, if you select the mode No. inside parentheses, you can also set by each individual unit. Setting changes however cannot be checked except in the individual mode for those in parentheses. (Even if the setting are made for the entire group, the display always indicates "01".)
 - *2. For FHQG, the second code No. of the "Airflow range setting is set at "03".
 - "88" may be displayed to indicate the remote controller is resetting when returning to the normal mode.

2.3.1 Detailed Explanation of Setting Modes

Filter Cleaning Sign Interval

When "Display" is selected in "Filter cleaning sign" after the unit runs for certain time, "Filter cleaning" will be displayed on the remote controller. This setting is used when the display interval of "Filter cleaning" needs to be changed on occasions such as when the filter has been heavily contaminated.

Mode No.	First Code No.	Second Code No.	Long Life Filter	Setting
10 (20)	0	01	2,500 hrs.	Contamination Light
		02	1,250 hrs.	Contamination Heavy

Remote Controller Thermistor

Select the thermistor to control room temperature.

Mode No.	First Code No.	Second Code No.	Thermistor that controls room temperature
10 (20)	2	01	Room temperature thermistor in remote controller and indoor unit suction air thermistor
		02	Indoor unit suction thermistor

The factory setting for the Second Code No. is "02" and room temperature is controlled by the indoor unit suction air thermistor.

When the Second Code No. is set to "01", room temperature is controlled by the indoor unit suction air thermistor and the room temperature thermistor in remote controller as following figures.

When using remote controller

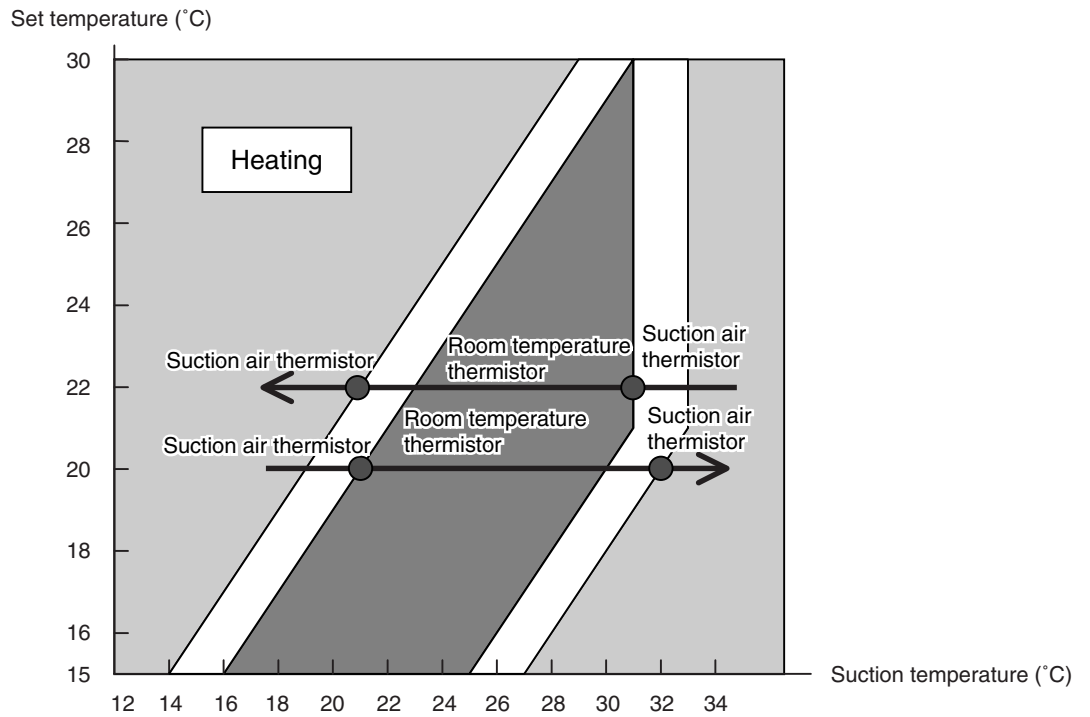
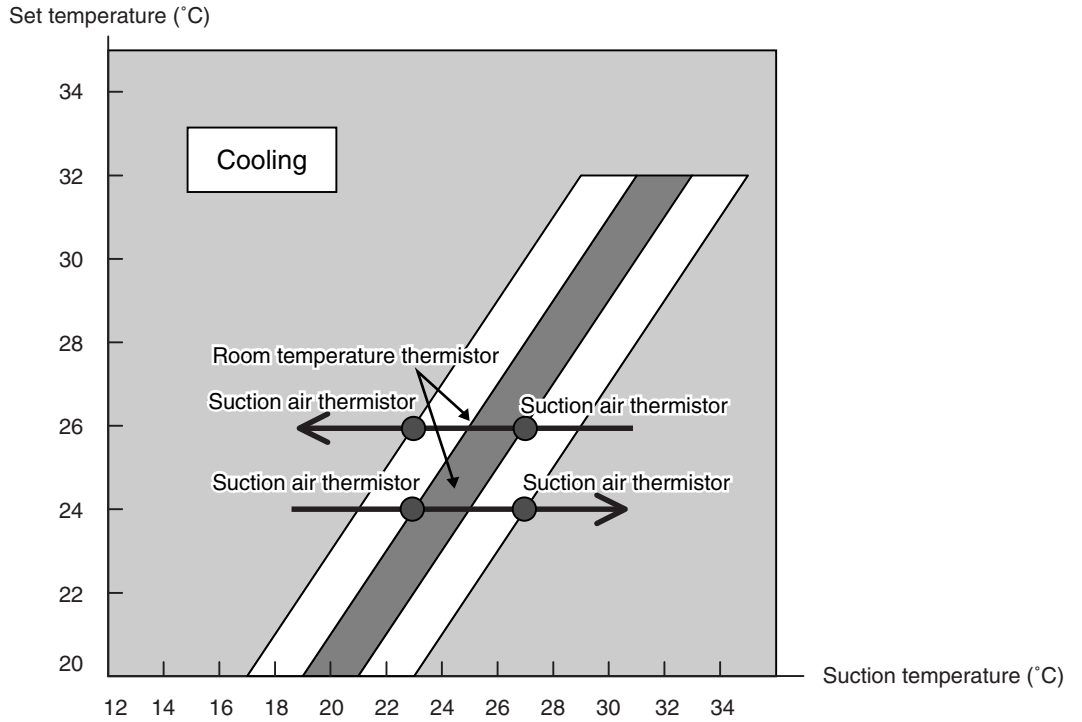

Filter Cleaning Sign

Whether or not to display "Filter Cleaning" after operation of certain duration can be selected.

Mode No.	First Code No.	Second Code No.	"Filter Cleaning" display
10 (20)	3	01	Display
		02	No display

Airflow Rate

Set the airflow when thermostat OFF by the combination of "Fan OFF at Thermostat OFF" 11(21)-2, "Fan speed heating thermostat OFF" 12(22)-3 and "Fan speed cooling thermostat OFF" 12(22)-6.

A : 6 minutes OFF / 1 minute LL

B : 6 minutes OFF / 1 minute setting airflow

C : 6 minutes OFF / 1 minute L

Set the airflow by the combination of 3 modes as below.

Mode No.	First Code No.	Second Code No.							
		Factory setting	Field setting						
11(21)	2	01	01	01	01	02	02	02	02
12(22)	3	01	01	02	02	01	01	02	02
12(22)	6	02	01	01	02	01	02	01	02
		↓	↓	↓	↓	↓	↓	↓	↓
Cooling	When thermostat OFF	Setting	LL	LL	Setting	A	B	A	B
Dry	When thermostat OFF	C	C	C	C	C	C	C	C
Heating	When thermostat OFF	LL	LL	Setting	Setting	A	A	Setting	Setting
	When defrost hot start	OFF	OFF	OFF	OFF	OFF	OFF	OFF	OFF

Airflow Rate Setting during Heating (FCQG Only)

For the purpose of securing airflow range during heating, the number of revolutions of fan during heating can be changed. Make the setting according to installation environment.

Mode No.	First Code No.	Second Code No.		
		01	02	03
11 (21)	3	Standard	Slightly up	Up

Automatic Operation Mode Control

When selecting “Automatic Operation Mode” with the remote controller, conducts the most comfortable operation in which you do not feel too cool or too hot.

- Outdoor air temperature
 - Indoor air temperature
 - Temperature set by remote controller
- } ⇒ Calculates and controls the optimum indoor temperature

Automatic Restart after Power Failure Reset

For the air conditioners with no setting for the function, the units will be left in the stop condition when the power supply is reset automatically after power failure reset or the main power supply is turned on again after once turned off. However, for the air conditioners with the setting (same as factory setting), the units may start automatically after power failure reset or the main power supply turned on again (return to the same operation condition as that of before power failure).

For the above reasons, when the unit is set enabling to utilize “Auto restart function after power failure reset”, utmost care should be paid for the occurrence of the following situation.



- Caution**
1. The air conditioner starts operation suddenly after power failure reset or the main power supply turned on again. Consequently, the user might be surprised (with question for the reason why).
 2. In the service work, for example, turning off the main power switch during the unit is in operation, and turning on the switch again after the work is completed start the unit operation (the fan rotates).

Setting of Normal Airflow

Make the following setting according to the ceiling height. The setting position No. is set to “01” at the factory.

■ FCQG71

Mode No.	First code No.	Second code No.	Ceiling height (m)
13 (23)	0	01	≤ 2.7
		02	2.7 - 3.0
		03	3.0 - 3.5

■ FCQG100-140

Mode No.	First code No.	Second code No.	Ceiling height (m)
13 (23)	0	01	≤ 3.2
		02	3.2 - 3.6
		03	3.6 - 4.2

■ FHQG71

Mode No.	First code No.	Second code No.	Ceiling height (m)
13(23)	0	01	≤ 2.7
		02	2.7 - 3.5

■ FHQG100-140

Mode No.	First code No.	Second code No.	Ceiling height (m)
13(23)	0	01	≤ 3.8
		02	3.8 - 4.3

Airflow Direction Setting

Set the air flow direction of indoor units as below. (Set when optional air outlet blocking pad has been installed.)

Mode No.	First Code No.	Second Code No.	Setting
13 (23)	1	01	F : 4-direction air flow
		02	T : 3-direction air flow

Airflow Range Setting

Make the following air flow direction setting according to the respective purpose.

Mode No.	First Code No.	Second Code No.	FCQG	FHQQ
13 (23)	4	01	Draft prevention (Upward)	Draft prevention (Upward)
		02	Standard	Dew condensation prevention (Upward)
		03	Ceiling soiling prevention (Downward)	Standard (Downward)

* Some indoor unit models are not equipped with draft prevention (upward) function.

Individual Setting of Ventilation

This is set to perform individual operation of heat reclaim ventilation using the remote controller/ central unit when heat reclaim ventilation is built in.

(Switch only when heat reclaim ventilation is built in.)

Mode No.	First Code No.	Second Code No.	Setting
15 (25)	5	01	—
		02	Individual operation of ventilation

2.4 Overview of the Field Setting on the Outdoor Units

Remote controller settings

The table below contains the remote controller settings.

Mode No.	First Code No.	Description	Second Code No.					Details
			01	02	03	04	05	
16 (26)	0	Night time low noise operation	Disabled (Factory setting)	Automatic low noise activation	Capacity preceding setting (when using KRP58 option)	Automatic low noise + capacity preceding	—	Refer to P63.
	1	Automatic low noise start and stop time	—	—	22h00 ~ 06h00	22h00 ~ 08h00 (Factory)	20h00 ~ 08h00	Refer to P63.
	2	EDP room setting	Disabled (Factory setting)	—	EDP room setting	EDP room setting + no freeze up	—	Refer to P66.
	3	Defrost starting setting	Standard (Factory setting)	Defrost slow starting setting	Defrost quick starting setting	—	—	Refer to P70.

Jumpers

The table below contains the jumper field settings.

Jumper	Label on PCB (A1P)	Function	Details
JX5	JX5	Set as Cooling Only, For RZQG71·100LV1B	For RZQG125·140LV1B, use the other PCB set as Cooling Only (no JX5)

Factory settings

The table below contains the factory settings of all outdoor units

Mode No.	First Code No.	Second Code No.
26	0	01
	1	04
	2	01
	3	01

2.5 Quiet (Low Noise) Operation

Purpose Lower the operation sound of the outdoor unit.

Setting Silent Operation can be activated by:

1. Automatic control (By field setting from remote controller)
2. External activation (from optional PCB KRP58M)

2.5.1 Quiet (Low Noise) Operation by Automatic Control

Table Silent operation can be set by field setting from the wired remote controller:

Description	Mode No.	First Code No.	Second Code No.				
			01	02	03	04	05
Silent Operation	16(26)	0	OFF	Low noise activation	—	Low noise + capacity priority	—
Low noise start & stop time		1	—	—	22h00 ~ 06h00	22h00 ~ 08h00	20h00 ~ 08h00

Method When setting mode 16(26)-0-02, quiet (low noise) operation will be carried out by presuming the current time in accordance with the outside temperature.
Automatic mode will start when the outdoor temperature is = average max of last 10 days -5°C and will be conducted for 10 hours.
The maximum outdoor temperature is supposed to occur at 14:00h.
As the time judgement is made in accordance with the outdoor temperature, the above mentioned timing is an estimation only.

Capacity Priority Setting When setting mode 16(26)-0-04, the low noise operation will be stopped when the heating or cooling load increases. In that case, the operation will return to normal operation. The unit will return to low-noise operation when the heating or cooling load decreases again.

Graph

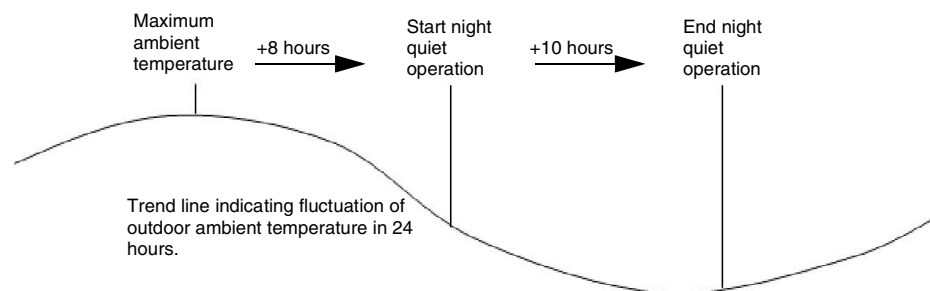

2.5.2 External Activation from Optional PCB

Graph

Quiet (low noise) operation can also be activated from the optional PCB.

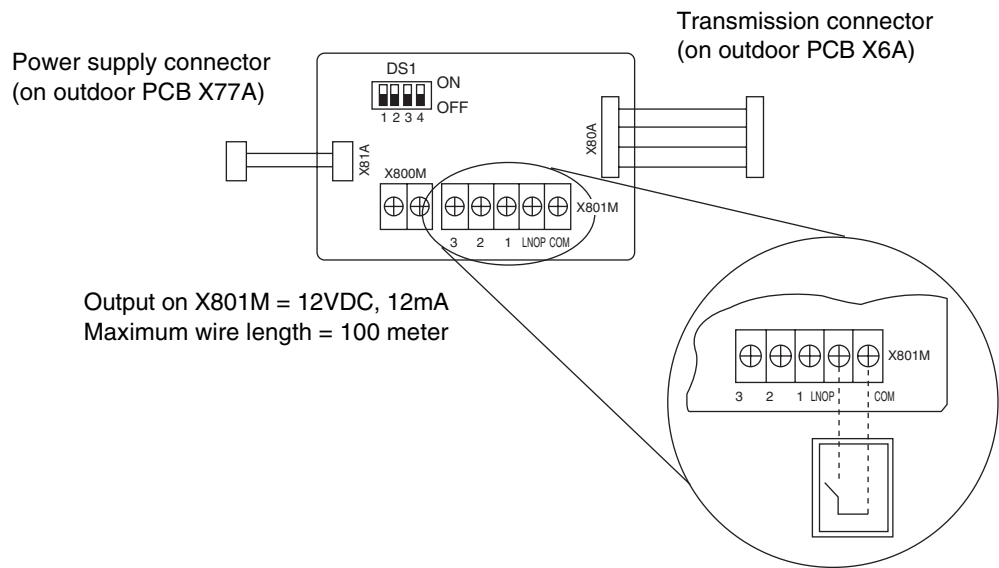

Quiet (low noise) operation will start when the contact on LNOP-COM is closed and will remain active as long as the contact is closed. No field setting on the outdoor unit or by remote controller is required.

Quiet (low noise) operation will be ended when the contact is re-opened.

Use of the KRP58M enables the use of an external time clock.

Capacity priority Setting

Same as with the automatic control, priority for capacity can be set. Priority for capacity will be activated by changing field setting 26-0-03 in combination with the closed contact on KRP58M.

Description	Mode No.	First Code No.	Second Code No.			
			01	02	03	04
Quiet (low noise) operation	16(26)	0	Factory setting	—	Capacity priority setting	—

Exceptions

The Quiet (low noise) operation will be overruled in the following conditions:

- Pump down residual operation
- Startup control
- Defrost operation
- Oil recovery

Sound reduction

Model	RZQG71	RZQG100	RZQG125	RZQG140
Sound reduction	4 dBA	4 dBA	5 dBA	5 dBA

2.6 I-Demand Function

Purpose Set a limitation towards the power consumption from the system.(e.g. budget control, limit power consumption during peak moments,..)

Setting 3 different demand setting can be selected by using terminal X801M:

- Demand 1 → Close contact between COM and contact 1
- Demand 2 → Close contact between COM and contact 2
- Demand 3 → Close contact between COM and contact 3

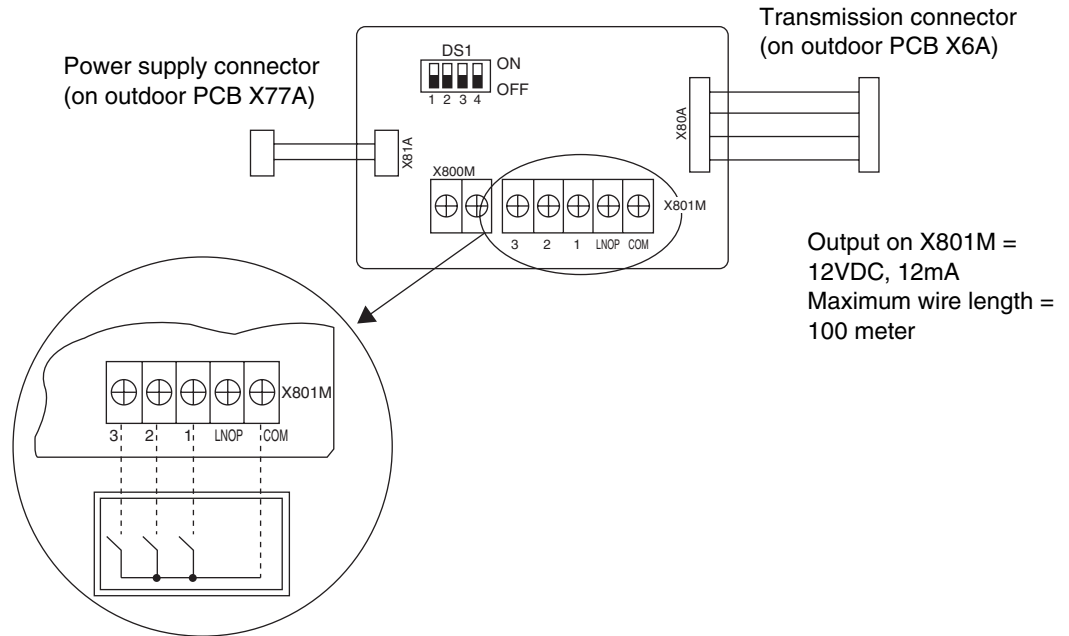

Demand 1

Power consumption limitation in function of setting on DS1:

DS1 Setting		ON OFF	Maximum Power Consumption
1	2		
OFF	OFF		60%
ON	OFF		70%
OFF	ON		80%
ON	ON		100%

Demand 2

Power consumption limitation set to 40%.

Demand 3

Forced thermostat OFF.

2.7 Setting for Low Humidity Application

Purpose Can be set when using the RZQG units for year round cooling in low humidity applications such as computer rooms (EDP rooms), technical rooms, etc...to increase the capacity of the unit.

Definition of Low Humidity Area

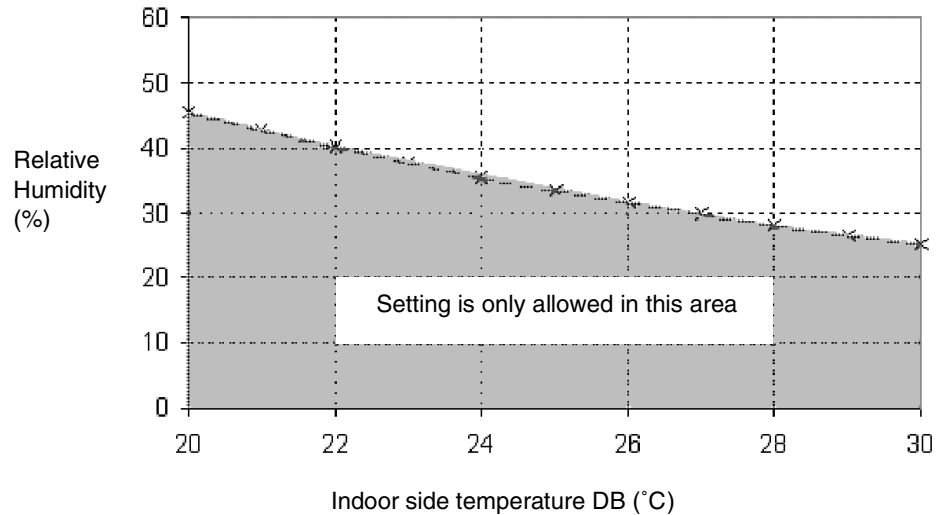

Caution When using the "LH settings" outside the "Low Humidity Area" there is an increased risk of ice accumulation on the indoor coil or water blowing out from the indoor unit.

Function details

		Factory setting	Low humidity application setting	Low humidity application + freeze up operation prevention
Field Setting		16(26)-2-01	16(26)-2-03	16(26)-2-04
Compressor control		<ul style="list-style-type: none"> The compressor frequency is controlled in function of the target evaporating temperature. The target evaporating temperature is controlled in function of the cooling load. 		
		Minimum target Te = 2°C	Minimum target Te = 0°C	Initial minimum target Te = 2°C, but can be changed in function of actual Te, to avoid freeze up activation: <ul style="list-style-type: none"> Te ≤ -1°C for 20 minutes accumulated => Change target Te ≥ 5°C Te ≤ -1°C for 30 minutes accumulated => Change target Te ≥ 8°C
		See graph 1	See graph 2	See graph 3
Freeze protection function	Start	Te ≤ -1°C for 40 minutes accumulated OR Te ≤ A°C for 1 minute continuous (Indoor decision)	Te ≤ -1°C for 40 minutes accumulated OR Te ≤ -3°C for 1 minute continuous (Outdoor decision)	Te ≤ -1°C for 40 minutes accumulated OR Te ≤ A°C for 1 minute continuous (Outdoor decision)
	End	Te > 7°C for 10 minutes continuously. (Indoor decision)	Te > 7°C for 3 minutes continuously OR Te > 4°C for 20 minutes continuously (Outdoor decision)	Te > 7°C for 3 minutes continuously OR Te > 4°C for 20 minutes continuously (Outdoor decision)

Parameters

	FCQG	FHQQ
A	-5°C	-3°C

Graph 1

Target evaporating temperature control in case of factory setting 16(26)-2-01:

Te target acceptable area

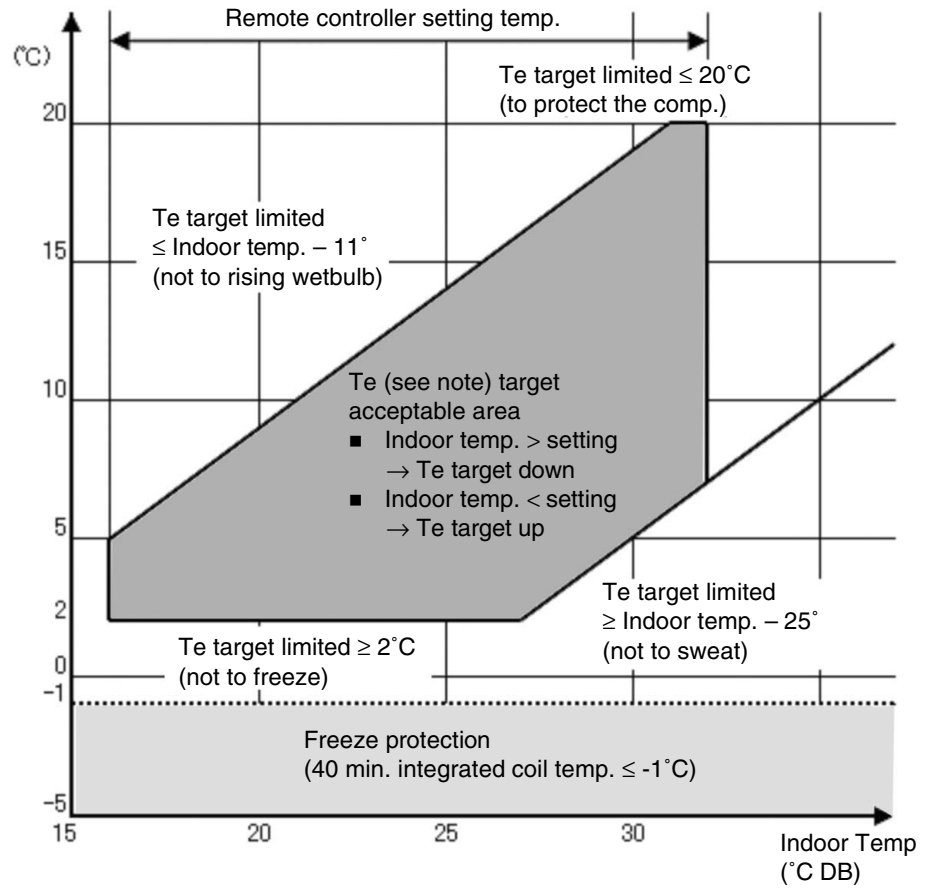

Note:

Te by LP sensor	RZQG Series
-----------------	-------------

Graph 2

Target evaporating temperature control when "low humidity application" is selected. Field setting 16(26)-2-03:

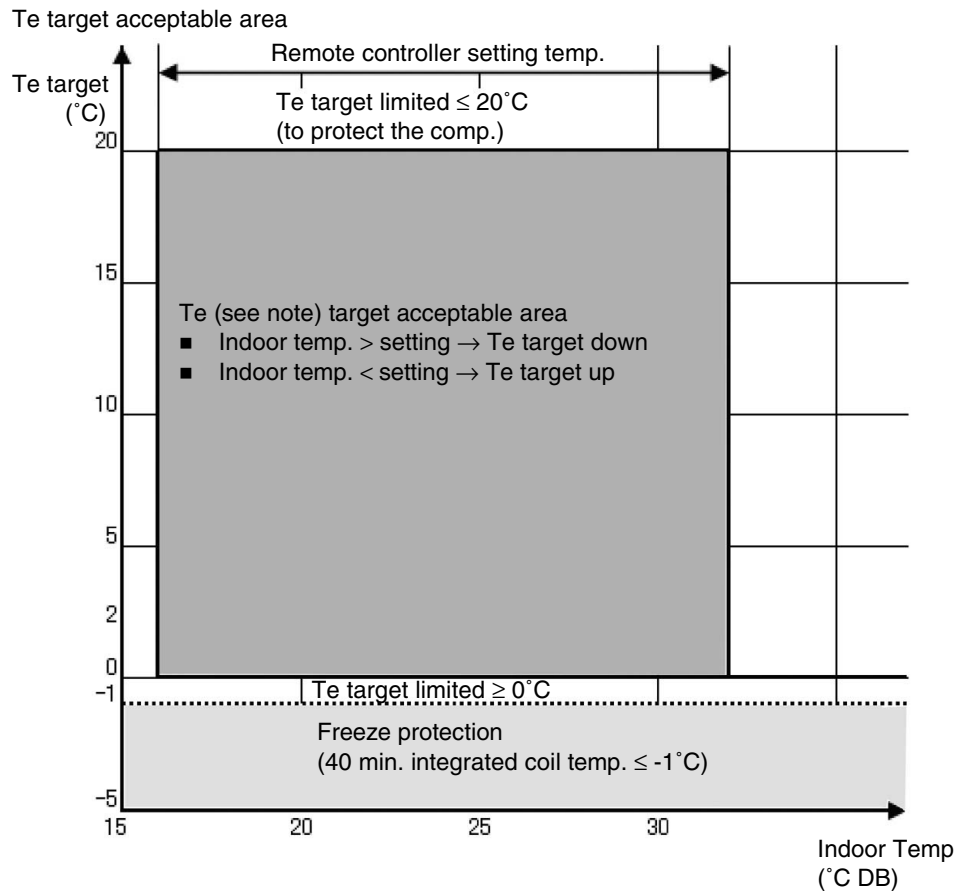

Note:

Te by LP sensor	RZQG Series
-----------------	-------------

Graph 3

Target evaporating temperature control when "low humidity application + freeze up operation prevention" is selected. Field setting 16(26)-2-04:

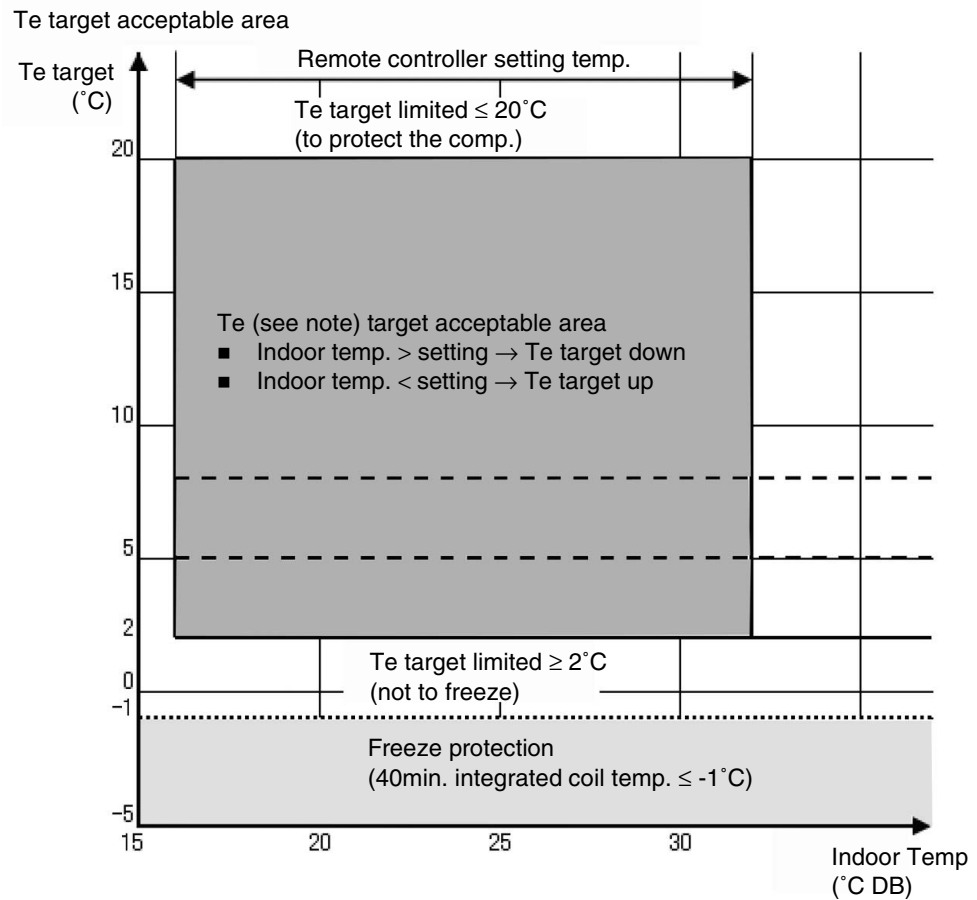
**Note:**

Te by LP sensor	RZQG Series
-----------------	-------------

Change thermostat control

In order to increase continuous operation of the unit in low latent heat applications and avoid the rise of temperature after thermostat OFF, the thermostat control will be changed when using field settings 16(26)-2-03 & 16(26)-2-04.

Thermostat ON

- $\Delta\text{Trs} \geq 0.5^{\circ}\text{C}$ (No change from standard setting)

Thermostat OFF

- $\Delta\text{Trs} \leq -2.0^{\circ}\text{C}$ for 5 minutes continuously.
- $\Delta\text{Trs} \leq 4.5^{\circ}\text{C}$

Capacity

When "low humidity application" is selected. Field setting 16(26)-2-03:

Outdoor Temp. (°C-DB)	Indoor Temp. (°C-WB)							
	11	14	16	18	19	20	22	24
	Capacity (% of standard point)							
-15	0.62	0.76	0.86	0.95	1.00	1.02	1.07	1.11
-10	0.62	0.76	0.86	0.95	1.00	1.02	1.07	1.11
-5	0.62	0.81	0.91	1.01	1.06	1.16	1.21	1.26
0	0.62	0.81	0.91	1.01	1.06	1.16	1.21	1.26
5	0.62	0.81	0.91	1.01	1.06	1.16	1.21	1.26
10	0.62	0.81	0.91	1.01	1.06	1.16	1.21	1.26
15	0.62	0.81	0.91	1.01	1.12	1.14	1.19	1.24
20	0.62	0.81	0.91	1.07	1.10	1.12	1.16	1.21
25	0.62	0.81	0.91	1.05	1.07	1.09	1.13	1.18
30	0.61	0.81	0.91	1.01	1.04	1.06	1.10	1.14
35	0.61	0.81	0.94	0.98	1.00	1.02	1.06	1.11
40	0.61	0.81	0.90	0.94	0.96	0.98	1.02	1.06

Capacity

When "low humidity application + freeze up operation prevention" is selected. Field setting 16(26)-2-04:

Outdoor Temp. (°C-DB)	Indoor Temp. (°C-WB)							
	11	14	16	18	19	20	22	24
	Capacity (% of standard point)							
-15	0.51	0.68	0.78	0.95	1.01	1.06	1.16	1.26
-10	0.51	0.68	0.78	0.95	1.01	1.06	1.16	1.26
-5	0.51	0.68	0.78	0.95	1.01	1.06	1.16	1.26
0	0.51	0.68	0.78	0.95	1.01	1.06	1.16	1.26
5	0.51	0.68	0.78	0.95	1.01	1.06	1.16	1.26
10	0.51	0.68	0.78	0.95	1.01	1.06	1.16	1.26
15	0.51	0.68	0.78	0.95	1.01	1.06	1.16	1.24
20	0.51	0.68	0.78	0.95	1.01	1.06	1.16	1.21
25	0.51	0.68	0.78	0.95	1.00	1.06	1.13	1.18
30	0.51	0.68	0.78	0.95	1.00	1.05	1.10	1.14
35	0.51	0.68	0.78	0.95	1.00	1.02	1.06	1.11
40	0.51	0.67	0.78	0.94	0.96	0.98	1.02	1.06



- Note:**
- Operation range on indoor side expanded from minimum 12°CWB to 11°CWB when using LH setting.
 - Do not use a setpoint below 20°C to avoid operation out of the indoor operation range (11°CWB).
 - Be sure to set the indoor fan to high speed.

2.8 Defrost Start Setting

Refer to 'Defrost Operation' on P45.

3. Field Setting from Outdoor Unit PCB

3.1 Location of DIP Switch and BS Button

Various settings are available by using the DIP switches and the BS buttons on the PCB.

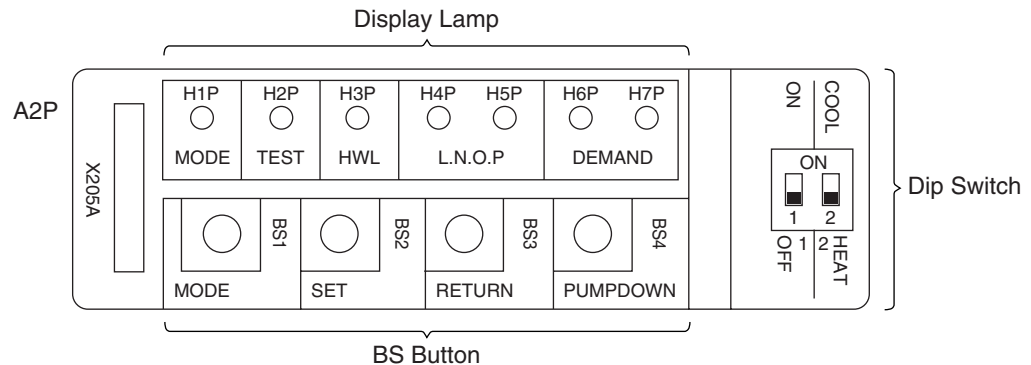

	Display		Function or Operating Procedure		
	Symbol	Name			
Display Lamp	H1P	MODE	During "Setting mode 1," the lamp is OFF (●).	During "Monitor mode," the lamp blinks (◐).	
	H2P	TEST	During test operation in "Setting mode 1," the lamp is ON (○).	During "Monitor mode," the lamp is OFF (●).	
	H3P	HWL	When an error occurs during "Setting mode 1," the lamp turns ON (○).		
	H4P	L.N.O.P	During "Setting mode 1," low noise level is displayed.	During "Monitor mode," various combinations of the lamp indicate the following conditions: <ul style="list-style-type: none"> • Indication of oil return operation • Indication of outdoor unit class • Indication of error code (the latest and up to 2 cycles before) • Indication of causes of stepping-down 	
	H5P				
	H6P	DEMAND	During "Setting mode 1," demand level is displayed.		
	H7P				
BS Button	BS1	MODE	Used to change "Setting mode".		
	BS2	SET	Used to change "Setting item" and "Setting condition".		
	BS3	RETURN	Used to decide "Setting item" and "Setting condition".		
	BS4	PUMP DOWN	Used for pump down operation, forced oil return operation and forced defrost operation.		
Dip Switch	DS1-1	ON	Switch from "OFF" to "ON" for emergency operation (forced operation).		
		OFF(*1)			
DS1-2	COOL	Maintain "HEAT" in case of heating in emergency operation, and switch to "COOL" in case of cooling in emergency operation.			
	HEAT(*1)				

*1. Factory settings: "OFF" and "HEAT"



Note:

BS button (Pump down / Forced defrosting)

Pressing the BS button forcibly operates the air conditioner in the cooling mode.

1. To conduct a pump-down operation (sending refrigerant to outdoor unit), press the BS button to forcibly operate the equipment in the cooling mode, then operate the unit for about 1 minute to stabilize the system. After stabilizing system, close the liquid pipe stop valve on the outdoor unit, and after the pressure decreases and the low pressure sensor activates, close the gas pipe stop valve.

2. Forced defrost

To activate the defrost operation during the heating operation, press the BS button. This will activate the forced defrost operation (cooling operation).

When the defrost cancel conditions are met, the equipment automatically switches off the defrost operation.

3.2 Field Setting for Outdoor Unit

3.2.1 Setting by BS Buttons

With "Setting mode 1," "Setting mode 2" and "Monitor mode," various settings and data can be checked.

(1) Setting mode 1

The initial status (normal operation) is "Setting mode 1." This mode indicates operating status - "TEST (test operation)," "HWL (error)," "L.N.O.P (night time quiet operation)" or "DEMAND (demand operation)."

(2) Setting mode 2

Each operating status can be modified.

(3) Monitor mode

This mode indicates "oil return operation," "outdoor unit class," "contents of retry," "contents of error," "causes of stepping-down operation," etc.

Using the MODE button, the modes can be changed as follows.

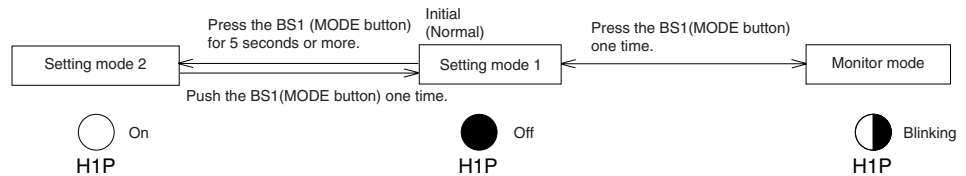

3.2.2 Setting Mode 1

In this mode, the following conditions can be checked:

- Current operating condition (normal/test operation/line inspection and normal/error)
- Night time quiet operation condition (normal/low noise level 1, 2, and)
- Demand operating condition (normal/30% demand/40% demand/50% demand)

These conditions above can be checked by performing the following steps:

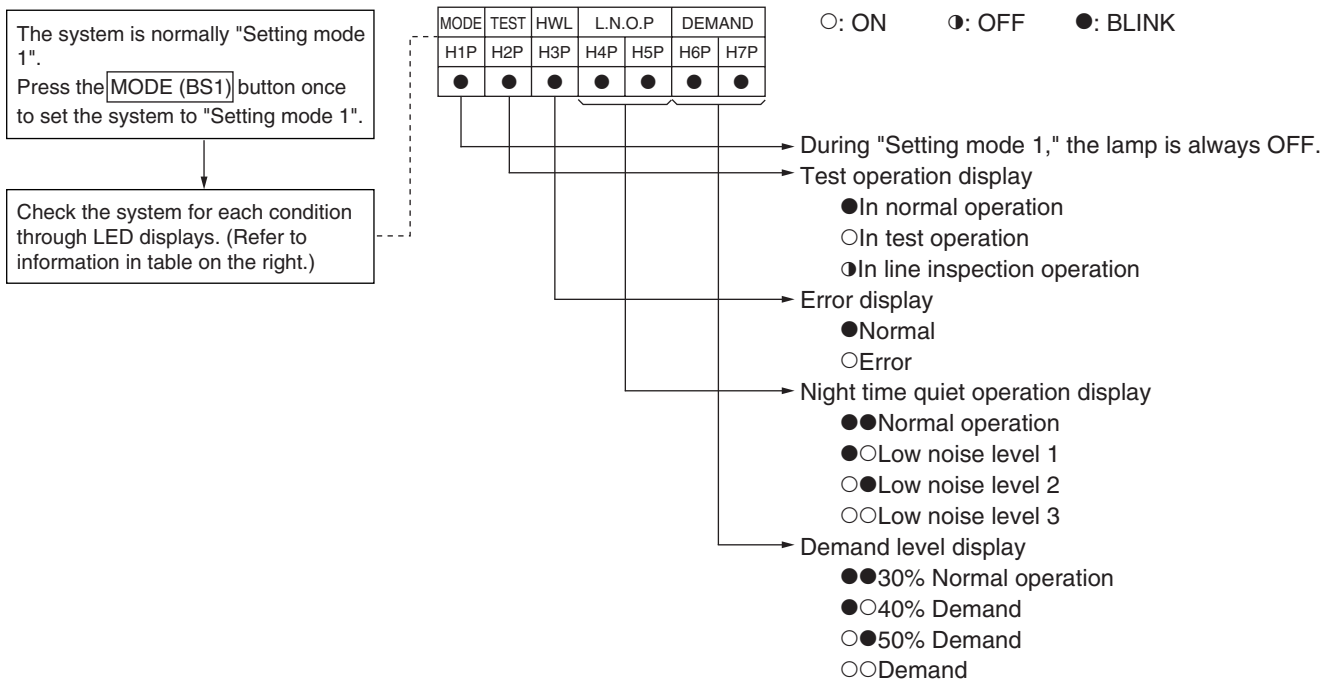

3.2.3 Setting Mode 2

In this mode, settings for the following items can be made.

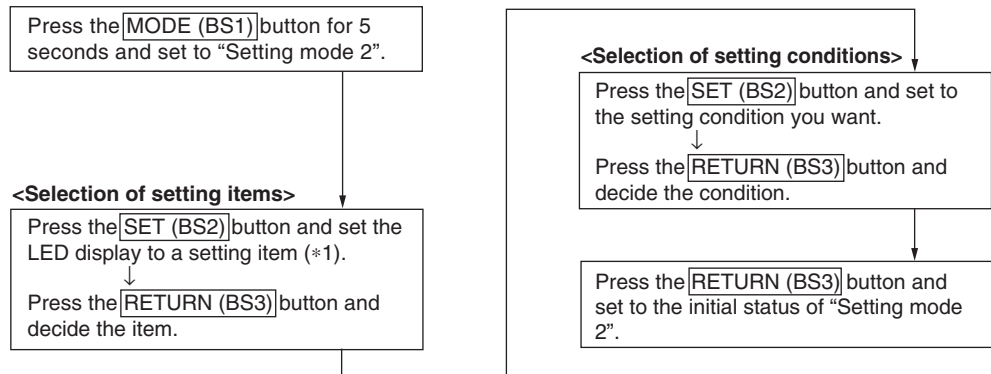

* If you become unsure of how to proceed, push the MODE (BS1) button and return to setting mode 1.

No.	Display of setting items							Display of setting condition								
	Setting item	LED display							Setting condition	LED display						
H1P		H2P	H3P	H4P	H5P	H6P	H7P	H1P		H2P	H3P	H4P	H5P	H6P	H7P	
3	Demand 2 operation	○	●	●	●	●	○	○	30% demand	○	●	●	●	○	●	●
		○	●	●	●	●	○	○	40% demand (factory setting)	○	●	●	●	●	○	●
		○	●	●	●	●	●	○	50% demand	○	●	●	●	●	●	○
28	Refrigerant recovery mode	○	●	○	○	○	●	●	OFF (factory setting)	○	●	●	●	●	○	○
		○	●	○	○	○	●	●	ON	○	●	●	●	●	○	○

↑ The figures in the columns under "No." represent the number of times to push the SET (BS2) button.

■ Setting of Demand 2 operation

With this setting, compressor operation can be controlled to reduce power consumption. (60% - 80% demand is available when a demand adapter (optional accessory) is used.)

Setting item	Setting condition	Description
Demand 2 operation	30% demand	Operates with 30% of rated power consumption.
	40% demand (factory setting)	Operates with 40% of rated power consumption.
	50% demand	Operates with 50% of rated power consumption.

[Work procedure]

●: OFF ○: BLINK ○: ON

Operating procedure	H1P	H2P	H3P	H4P	H5P	H6P	H7P
Push and hold the MODE (BS1) button of "Setting mode 1" for 5 seconds or more and set to "Setting mode 2."	○	●	●	●	●	●	●
Push the SET (BS2) button three times to set the LED display as shown in the table on the right.	○	●	●	●	●	○	○
Push the RETURN (BS3) button once. (Present settings are displayed.)	○	●	●	●	●	○	●
Push the SET (BS2) button to set the LED display as shown in the table on the right.	30% of rated power consumption	○	●	●	●	○	●
	40% of rated power consumption	○	●	●	●	●	○
	50% of rated power consumption	○	●	●	●	●	●
Push the RETURN (BS3) button once to make a decision.	30% of rated power consumption	○	●	●	●	○	●
	40% of rated power consumption	○	●	●	●	●	○
	50% of rated power consumption	○	●	●	●	●	○
Push the RETURN (BS3) button once again for execution. (The LED display is in the initial status of "Setting mode 2".)	○	●	●	●	●	●	●
Push the MODE (BS1) button once to return to Setting mode 1 (normal operation).	●	●	●	●	●	●	●

■ **Setting of Refrigerant Recovery Mode**

When a refrigerant recovery unit is connected onsite to recover refrigerant, fully open the expansion valve of the outdoor unit to help the recovery.

- (1) Stop operation.
- (2) Turn ON refrigerant recovery mode by performing the following steps.

●: OFF ○: BLINK ○: ON

Operating procedure	H1P	H2P	H3P	H4P	H5P	H6P	H7P
Press the MODE (BS1) button of "Setting mode 1" for 5 seconds or more and set to "Setting mode 2."	○	●	●	●	●	●	●
Press the SET (BS2) button 28 times to set the LED display as shown in the table on the right. (*1)	○	●	○	○	○	●	●
Press the RETURN (BS3) button once. (Present settings are displayed.)	○	●	●	●	●	●	○
Press the SET (BS2) button once to set the LED display as shown in the table on the right.	○	●	●	●	●	○	●
Press the RETURN (BS3) button once to make a decision.	○	●	●	●	●	○	●
When the RETURN (BS3) button is pressed once again, the electronic expansion valve opens fully.	○	●	●	●	●	●	●

- (3) Connect a refrigerant recovery unit to perform refrigerant recovery.
- (4) Upon completion of refrigerant recovery, turn OFF refrigerant recovery mode by taking the following steps or turning OFF the power of outdoor unit.

Operating procedure	H1P	H2P	H3P	H4P	H5P	H6P	H7P
Press the SET (BS2) button 28 times to set the LED display as shown in the table on the right. (*1)	○	●	○	○	○	●	●
Press the RETURN (BS3) button once. (Present settings are displayed.)	○	●	●	●	●	○	●
Press the SET (BS2) button once to set the LED display as shown in the table on the right.	○	●	●	●	●	●	○
Press the RETURN (BS3) button once to make a decision.	○	●	●	●	●	●	○
When the RETURN (BS3) button is pressed once again, the electronic expansion valve fully opens.	○	●	●	●	●	●	●



Note:

*1: If you become unsure how many times you have pushed the button, push the MODE (BS1) button once to return to "Setting mode 1" and start the operating procedure all over again.

3.2.4 Monitor Mode

In this mode, the following items can be checked by using the BS buttons.

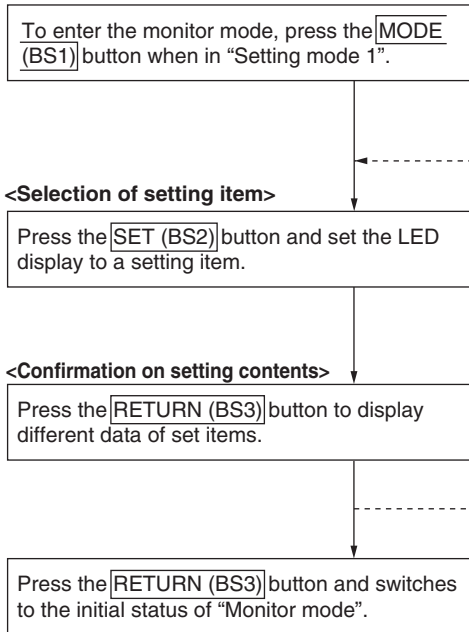

No.	Setting item	LED display							Data display
		H1P	H2P	H3P	H4P	H5P	H6P	H7P	
0	Indication of oil return operation	●	●	●	●	●	●	●	See Data display (1).
1	Indication of outdoor unit class	●	●	●	●	●	●	○	See Data display (2).
2	Contents of retry (the latest)	●	●	●	●	●	○	●	See "Malfunction code display" on the next page.
3	Contents of retry (1 cycle before)	●	●	●	●	●	○	○	
4	Contents of retry (2 cycle before)	●	●	●	●	○	●	●	
5	Contents of malfunction (the latest)	●	●	●	●	○	●	○	
6	Contents of malfunction (1 cycle before)	●	●	●	●	○	○	●	
7	Contents of malfunction (2 cycle before)	●	●	●	●	○	○	○	
10	Indication of causes of stepping-down operation	●	●	●	○	●	○	●	See Data display (3).

The numbers in the "No." column represent the number of times to press the **SET (BS2)** button.

* Press the **MODE (BS1)** button and returns to "Setting mode 1".

Data display (1)

Display contents	LED display						
	H1P	H2P	H3P	H4P	H5P	H6P	H7P
In normal operation	●	●	●	●	●	●	●
In oil return operation	●	●	●	●	●	●	○

Data display (2)

Display contents	LED display						
	H1P	H2P	H3P	H4P	H5P	H6P	H7P
No setting	●	●	●	●	●	●	○
RZQG71LV1B	●	●	●	●	○	○	○
RZQG100LV1B	●	●	●	○	●	●	●
RZQG125LV1B	●	●	●	○	●	●	○
RZQG140LV1B	●	●	●	○	●	○	●

Data display (3)

Display contents	LED display						
	H1P	H2P	H3P	H4P	H5P	H6P	H7P
Normal (not in stepping-down operation)	●	●	●	●	●	●	○
Low pressure stepping-down	●	●	●	●	●	○	●
High pressure stepping-down	●	●	●	●	●	○	○
Inverter discharge pipe stepping-down	●	●	●	●	○	●	●
Inverter current stepping-down	●	●	●	●	○	●	○
Radiation fin temperature stepping-down	●	●	●	●	○	○	●
Inverter stepping-down	●	●	●	●	○	○	○
Overall current stepping-down	●	●	●	○	●	●	●
Other stepping-down	●	●	●	○	●	●	○

3.2.5 List of Contents of Retry and Error

Take the following steps to check contents of retry and error.

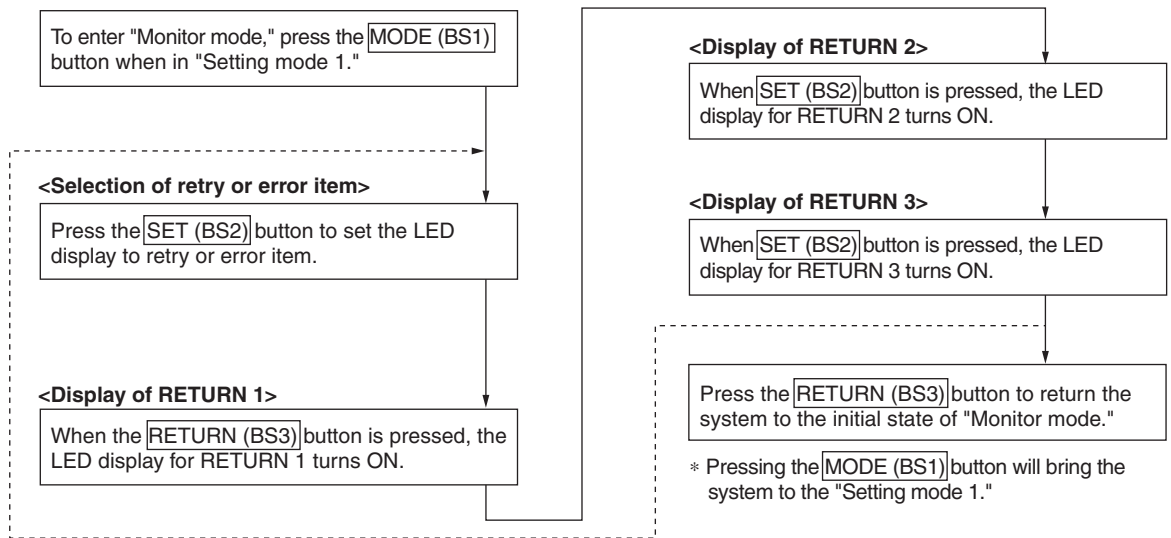

○: ON ●: OFF ◐: BLINK

Error code	Contents of retry or malfunction	Confirmation 1							Confirmation 2							Confirmation 3								
		H4P	H1P	H2P	H3P	H4P	H5P	H6P	H7P	H4P	H1P	H2P	H3P	H4P	H5P	H6P	H7P	H4P	H1P	H2P	H3P	H4P	H5P	H6P
C4	Indoor heat exchanger thermistor	◐	◐	○	●	●	●	◐	◐	◐	○	●	●	◐	◐	◐	◐	◐	○	○	●	●	●	●
E1	Faulty outdoor unit PCB	◐	◐	●	○	●	●	◐	◐	◐	○	●	●	◐	◐	◐	◐	◐	○	○	●	●	●	●
E3	Abnormal high pressure									◐	◐	○	●	●	◐	◐	◐	◐	○	○	●	●	●	●
E4	Abnormal low pressure									◐	◐	○	●	●	◐	◐	◐	◐	○	○	●	●	●	●
E5	Compressor motor lock									◐	◐	○	●	●	◐	◐	◐	◐	○	○	●	●	●	●
E7	Abnormal outdoor fan motor									◐	◐	○	●	●	◐	◐	◐	◐	○	○	●	●	●	◐
	DC motor 1 lock																		◐	◐	○	○	●	●
	DC motor 2 lock																		◐	◐	○	○	●	●
E9	Abnormal electronic expansion valve																		◐	◐	○	○	●	●
	Abnormal inverter transmission																		◐	◐	○	○	●	◐
F3	Abnormal discharge pipe temperature	◐	◐	●	○	●	◐	◐	◐	◐	○	●	●	◐	◐	◐	◐	◐	○	○	●	●	●	◐
	Disconnected discharge pipe thermistor																		◐	◐	○	○	●	●
H3	Abnormal high pressure switch	◐	◐	●	○	●	◐	◐	◐	◐	○	●	●	◐	◐	◐	◐	◐	○	○	●	●	●	●
H9	Abnormal outdoor air thermistor									◐	◐	○	●	●	◐	◐	◐	◐	○	○	●	●	●	●
J1	Abnormal pressure sensor	◐	◐	●	○	●	◐	◐	◐	◐	○	●	●	◐	◐	◐	◐	◐	○	○	●	●	●	●
J3	Abnormal discharge pipe thermistor									◐	◐	○	●	●	◐	◐	◐	◐	○	○	●	●	●	●
J5	Abnormal suction pipe thermistor									◐	◐	○	●	●	◐	◐	◐	◐	○	○	●	●	●	●
J6	Abnormal heat exchanger distributor pipe thermistor									◐	◐	○	●	●	◐	◐	◐	◐	○	○	●	●	●	●
J7	Abnormal intermediate heat exchanger thermistor									◐	◐	○	●	●	◐	◐	◐	◐	○	○	●	●	●	●
J8	Abnormal liquid pipe thermistor									◐	◐	○	●	●	◐	◐	◐	◐	○	○	●	●	●	●
L1	PCB failure	◐	◐	●	○	●	◐	◐	◐	◐	○	●	●	◐	◐	◐	◐	◐	○	○	●	●	●	●
L4	Elevated radiation fin temperature									◐	◐	○	●	●	◐	◐	◐	◐	○	○	●	●	●	●
L5	Compressor instantaneous overcurrent									◐	◐	○	●	●	◐	◐	◐	◐	○	○	●	●	●	●
L8	Compressor overload									◐	◐	○	●	●	◐	◐	◐	◐	○	○	●	●	●	●
L9	Compressor lock									◐	◐	○	●	●	◐	◐	◐	◐	○	○	●	●	●	●
LC	Abnormal transmission (between the control and the inverter)									◐	◐	○	●	●	◐	◐	◐	◐	○	○	●	●	●	●
P1	Unbalanced power supply voltage	◐	◐	●	○	●	◐	◐	◐	◐	○	●	●	◐	◐	◐	◐	◐	○	○	●	●	●	●
P4	Abnormal radiation fin thermistor									◐	◐	○	●	●	◐	◐	◐	◐	○	○	●	●	●	●
PJ	Faulty capacity setting									◐	◐	○	●	●	◐	◐	◐	◐	○	○	●	●	●	●
U0	Abnormal refrigerant shortage	◐	◐	●	○	●	◐	◐	◐	◐	○	●	●	◐	◐	◐	◐	◐	○	○	●	●	●	◐
	Refrigerant shortage warning																		◐	◐	○	○	●	●
U2	Abnormal power supply voltage									◐	◐	○	●	●	◐	◐	◐	◐	○	○	●	●	●	◐
	Inverter undervoltage and overvoltage																		◐	◐	○	○	●	●
U4	SP-PAM overvoltage																		◐	◐	○	○	●	●
UA	Abnormal transmission (between indoor and outdoor units)									◐	◐	○	●	●	◐	◐	◐	◐	○	○	●	●	●	●
UF	Faulty field setting switch									◐	◐	○	●	●	◐	◐	◐	◐	○	○	●	●	●	●
UF	Improper piping and improper communication wiring																		◐	◐	○	○	●	●

4. Emergency Operation

4.1 Forced Operation

As emergency operational methods, there are three methods as shown below. Choose the best method that is suitable for each purpose of use.

	Name	Application	Setting method	Operation				Remark
				Thermistor detection	Activation of protection device	Fan	Drain Pump	
(1)	Emergency operation (Forced operation)	Forced operation in service	By SS1 switch of indoor unit PCB	×	×	○	○	No temperature control
			By DS switch of outdoor unit PCB	×	×	○	—	
(2)	Test Operation	When checking the operation after installation	By Inspection / Test Operation button of the remote controller	×	○	○	○	No temperature control
			By Test Operation button of outdoor PCB					
(3)	Emergency operation	When the wireless remote controller is lost	Press the "Emergency operation" switch of the indoor unit panel.	○	○	○	○	Remote controller transmission stop, actuators such as fan and pump are ON

Emergency Operation (Forced operation)

1. Turn off the power supply.
2. Changeover the switch of indoor unit PCB (SS1) from NORM (Normal) to EMG (Emergency).

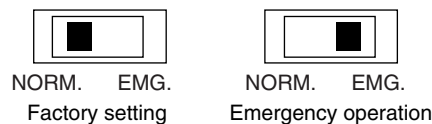

3. Changeover the switches of outdoor unit PCB (DS1) as shown below.

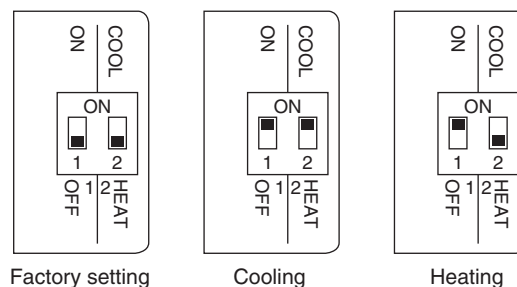

4. When the power is turned ON, the operation will be forcibly activated.

(Precautions)

1. Make sure that the power is turned off before changing the switch.
2. When returning to the normal operation, make sure that the power is turned off before returning each switch to the original position.
3. When the protection device is activated during the emergency operation, the unit stops the operation once and restarts three minutes later.
4. When there is an error on PCB, the emergency operation cannot be used.

Operation by the Test Operation Mode

As test run by the test operation mode, there are two methods as shown below.

<Test Operation by Wireless Remote Controller>

1. Press the Inspection / Test Operation button 4 times.

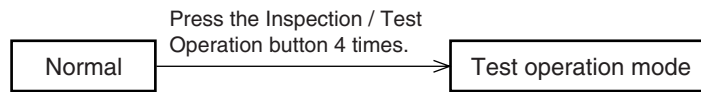

2. When you press the [ON / OFF] button after setting the test run mode, the test run starts.

<Test Operation by Outdoor Unit PCB>

1. Press the Test Operation (BS4) button on outdoor unit PCB for 5 seconds. After a while, the test operation starts.

(Reference)

- For the initial operation after installation of the unit, forced cooling operation continues for three minutes.
- For the second operation and afterwards after installation, the unit forcibly operates for 30 minutes in the set mode.

Part 7

Service Diagnosis

1. Maintenance Inspection	81
1.1 Overview	81
2. Symptom-based Troubleshooting	83
2.1 Overview	83
2.2 Equipment does not Operate	84
2.3 Indoor Unit Fan Operates, but Compressor does not Operate	86
2.4 Cooling / Heating Operation Starts but Stops Immediately	88
2.5 After Unit Shuts Down, It cannot be Restarted for a While	89
2.6 Equipment Operates but does not Provide Cooling	91
2.7 Equipment Operates but does not Provide Heating	93
2.8 Equipment Discharges White Mist	95
2.9 Equipment Produces Loud Noise or Vibration	96
2.10 Equipment Discharges Dust.....	97
2.11 Remote Controller LCD Displays "88"	98
2.12 Swing Flap does not Operate.....	99
3. Troubleshooting by LED Indications	101
3.1 Troubleshooting by LED on the Indoor Unit	101
3.2 Troubleshooting by LED on Outdoor Unit PCB.....	101
4. Troubleshooting by Remote Controller	102
4.1 Procedure of Self-diagnosis by Remote Controller	102
4.2 Error Codes and Description	106
4.3 Safety Devices	107
4.4 Indoor Unit PCB Abnormality	108
4.5 Drain Water Level System Abnormality.....	109
4.6 Indoor Unit Fan Motor Abnormality	111
4.7 Capacity Setting Abnormality	112
4.8 Transmission Error (between Indoor Unit PCB and Adaptor PCB)	113
4.9 Thermistor Abnormality	115
4.10 Humidity Sensor System Abnormality	116
4.11 Remote Controller Thermistor Abnormality	117
4.12 Outdoor Unit PCB Abnormality.....	118
4.13 High Pressure Abnormality (Detected by the High Pressure Switch)...	119
4.14 Actuation of Pressure Sensor.....	123
4.15 Compressor Motor Lock	125
4.16 Outdoor Unit Fan Motor Abnormality.....	126
4.17 Electronic Expansion Valve Abnormality.....	128
4.18 Discharge Pipe Temperature Control.....	131
4.19 High Pressure Switch System Abnormality	133
4.20 Thermistor System Abnormality	134
4.21 Outdoor Unit PCB Abnormality.....	135
4.22 Radiation Fin Temperature Rise	137
4.23 Output Overcurrent Detection	139
4.24 Electronic Thermal (Time Lag)	141
4.25 Stall Prevention (Time Lag).....	143

4.26 Transmission System Abnormality (between Control and Inverter PCB)	145
4.27 Open Phase or Power Supply Voltage Imbalance	146
4.28 Defective Capacity Setting	147
4.29 Refrigerant Shortage (Alert)	148
4.30 Refrigerant Shortage (Error).....	149
4.31 Power Supply Voltage Abnormality	151
4.32 Transmission Error between Indoor and Outdoor Unit.....	153
4.33 Transmission Error Between Remote Controller and Indoor Unit	156
4.34 Transmission Error between MAIN Remote Controller and SUB Remote Controller.....	157
4.35 Field Setting Switch Abnormality.....	158
4.36 “L” Address Duplication of Centralized Controller.....	160
4.37 Transmission Error Between Centralized Controller and Indoor Unit.....	161
4.38 Transmission Error between Indoor and Outdoor Unit / Piping and Wiring Mismatch / Refrigerant Shortage	163
4.39 Check	165

1. Maintenance Inspection

1.1 Overview

When performing maintenance, you should at least perform the following inspections:

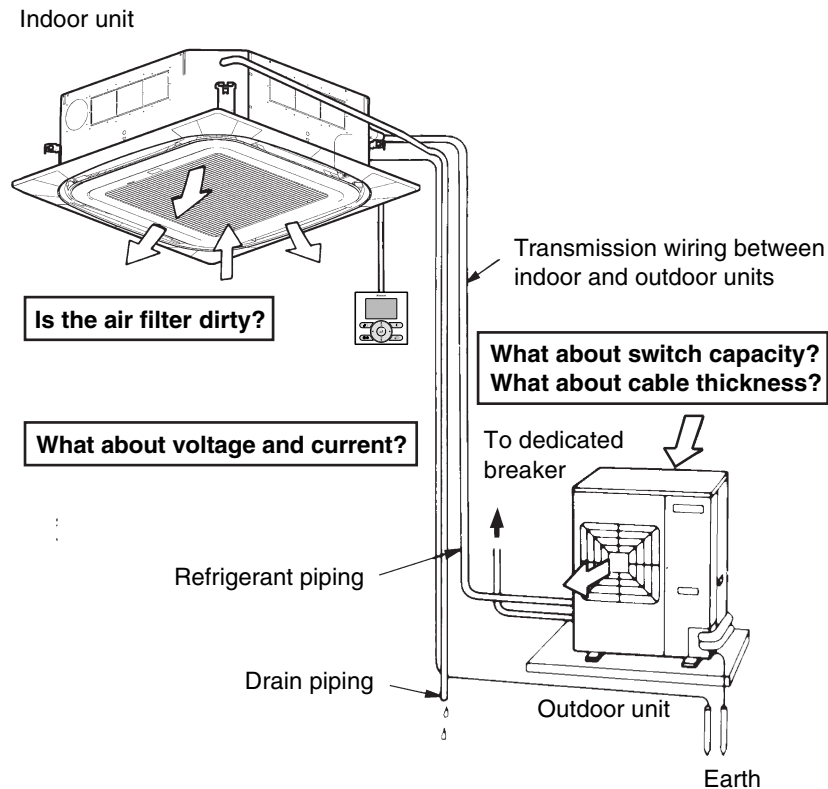

Guide Lines for Optimal Operation Condition

The operation value guide lines when operating under standard conditions by pushing the test operation button on the remote controller are as given in the table below.

Indoor unit fan: H tap

	High Pressure	Low Pressure	Discharge Pipe Temperature	Suction Temperature	Indoor Unit: Temperature Differential between Suction Air and Discharge Air	Outdoor Unit: Temperature Differential between Suction Air and Discharge Air
Cooling	2.62 MPa ~ 3.39 MPa	0.60 MPa ~ 0.98 MPa	60°C~100°C	-2°C~10°C	8°C~18°C	7°C~12°C
Heating	2.53 MPa ~ 3.27 MPa	0.53 MPa ~ 0.75 MPa	60°C~100°C	-6°C~2°C	14°C~30°C	2°C~6°C

Standard Conditions

	Indoor	Outdoor
Cooling Operation	27°CDB/19°CWB	35°CDB
Heating Operation	20°CDB	7°CDB/6°CWB

During or after maintenance, when the power supply is turned back on, operation restarts automatically by the "auto restart function." Please exercise the proper caution.

Correlation of Air-Conditioner's Operation Status and Pressure / Running Current

What happens in comparison to normal values is summarized in the table below.

(Measured for 15 ~ 20 minutes or more after operation starts.)

Cooling

Air-Conditioner Status	Low Pressure	High Pressure	Running Current
Air Filter Fouling	Lower	Lower	Lower
Short Circuit of Indoor Unit Inlet/Outlet Air	Lower	Lower	Lower
Outdoor Unit Fin Fouling	Higher	Higher	Higher
Short Circuit of Outdoor Unit Inlet/Outlet Air	Higher	Higher	Higher
Air Mixed in Refrigerant	Higher	Higher	Higher
Water Mixed in Refrigerant	Lower *1	Lower	Lower
Dirt Mixed in Refrigerant	Lower *2	Lower	Lower
Refrigerant Shortage	Lower	Lower	Lower
Unsatisfactory Compression	Higher *3	Lower	Lower

Heating

Air-Conditioner Status	Low Pressure	High Pressure	Running Current
Air Filter Fouling	Higher	Higher	Higher
Short Circuit of Indoor Unit Inlet/Outlet Air	Higher	Higher	Higher
Outdoor Unit Fin Fouling	Lower	Lower	Lower
Short Circuit of Outdoor Unit Inlet/Outlet Air	Lower	Lower	Lower
Air Mixed in Refrigerant	Higher	Higher	Higher
Water Mixed in Refrigerant	Lower *1	Lower	Lower
Dirt Mixed in Refrigerant	Lower *2	Lower	Lower
Refrigerant Shortage	Lower	Lower	Lower
Unsatisfactory Compression	Higher *3	Lower	Lower

**Note:**

- *1. Water in the refrigerant freezes inside the capillary tube or electronic expansion valve, and is basically the same phenomenon as pump down.
- *2. Dirt in the refrigerant clogs filters inside the piping, and is basically the same phenomenon as pump down.
- *3. Pressure differential between high and low pressure becomes low.

2. Symptom-based Troubleshooting

2.1 Overview

	Symptom	Details of Measures
1	Equipment does not operate.	Refer to P.84
2	Indoor fan operates, but compressor does not operate.	Refer to P.86
3	Cooling/heating operation starts but stops immediately.	Refer to P.88
4	After unit shuts down, it cannot be restarted for a while.	Refer to P.89
5	Equipment operates but does not provide cooling.	Refer to P.91
6	Equipment operates but does not provide heating.	Refer to P.93
7	Equipment discharges white mist.	Refer to P.95
8	Equipment produces loud noise or vibration.	Refer to P.96
9	Equipment discharges dust.	Refer to P.97
10	Remote controller LCD displays "88".	Refer to P.98
11	Indoor swing flap does not operate.	Refer to P.99
12	Equipment emits odor.	Room smell and cigarette odors accumulated inside the indoor unit are discharged with air. Inside of the indoor unit must be cleaned.
13	Flap operates when power is turned on.	It is normal. The flap initializes for accurate positioning.
14	Change of operation mode causes flap to move.	It is normal. There is a control function that moves the flap when operation mode is changed.
15	Fan operates in "M" tap during heating even if remote controller is set to "L" tap.	It is normal. It is caused by the activation of the overload control (airflow shift control).
16	Flap automatically moves during cooling.	It is normal. It is caused by the activation of the dew condensation prevention function or ceiling soiling prevention function.
17	Indoor unit fan operates in "L" tap for 1 minute in "program dry" mode even if compressor is not operating.	It is normal. The monitoring function forcibly operates the fan for 1 minute.
18	Indoor unit fan operates after heating operation stops.	It is normal. The fan operates in the "LL" tap for 60 to 100 seconds to dissipate the residual heat in the heater.
19	Drain pump operates when equipment is not operating.	It is normal. The drain pump continues to operate for several minutes after equipment is turned off.
20	Horizontal swing sends air to different directions in cooling and heating even if it is set to the same position.	It is normal. The airflow direction in cooling/dry operation is different from that in heating/fan operation.
21	Flap remains horizontal even if it is set to swing mode.	It is normal. The flap does not swing in the thermostat OFF mode.
22	When operating in remote control thermostat, the thermostat turns off before temperature of remote control reaches the set temperature.	Normal operation. The thermostat may be controlled with the suction temperature (body thermostat), concurrently with the set temperature.

2.2 Equipment does not Operate

Applicable Model All models of SkyAir series

Supposed Causes

- Fuse blown or disorder of contact in operation circuit
- Defective operation switch or contact point
- Defective high pressure switch
- Defective magnetic switch for fan motor
- Activation or fault of overcurrent relay for fan motor
- Defective overcurrent relay for compressor
- Defective compressor protection thermostat
- Insufficient insulation in electric system
- Defective contact point of magnetic switch for compressor
- Defective compressor
- Defective remote controller or low batteries (wireless)
- Incorrect address setting of wireless remote controller

Troubleshooting



Caution Be sure to turn off power switch before connect or disconnect connector, or parts damage may be occurred.

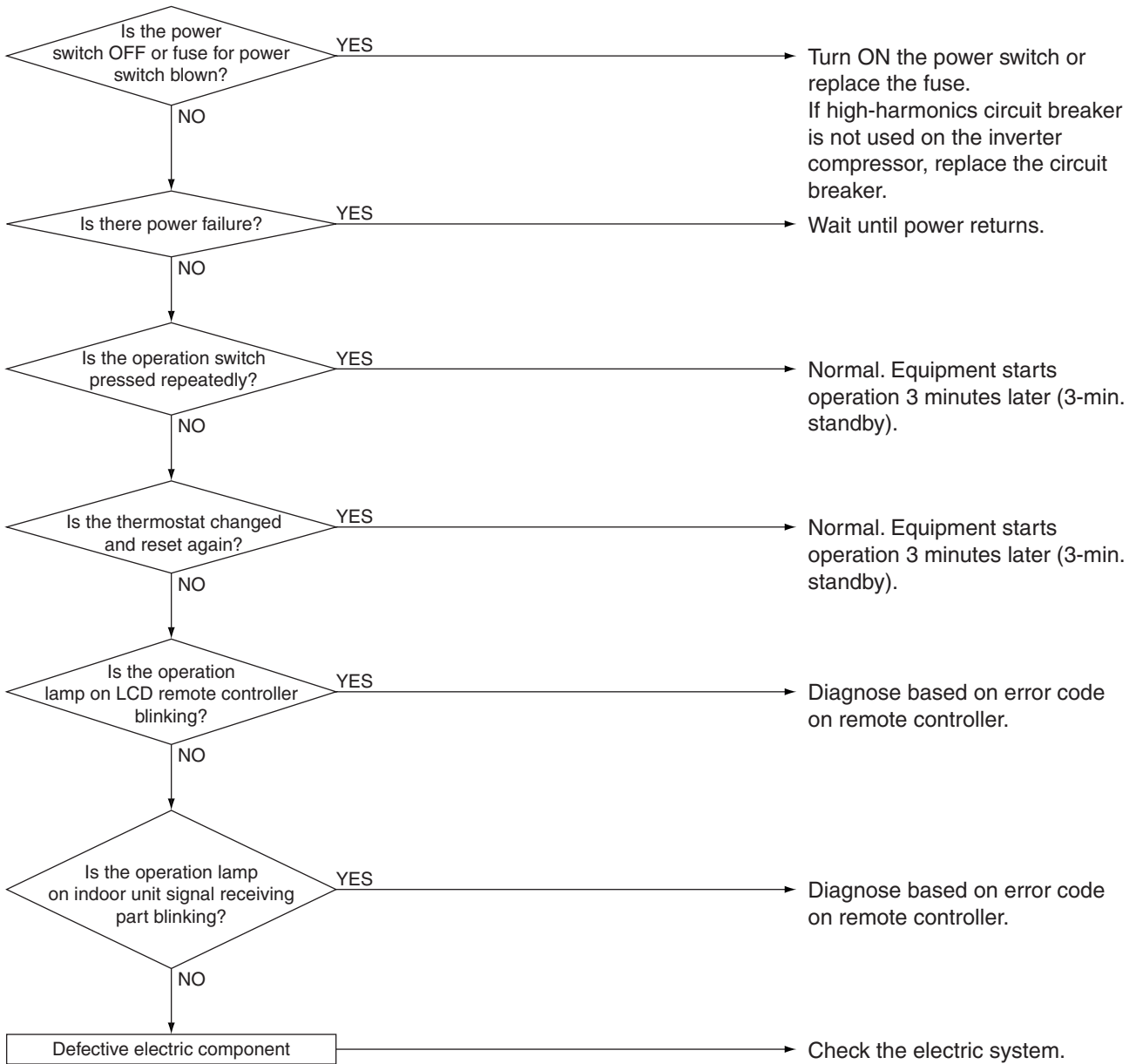

2.3 Indoor Unit Fan Operates, but Compressor does not Operate

Applicable Model All models of SkyAir series

Supposed Causes

- Fuse blown or disorder of contact in operation circuit
- Defective thermistor
- Defective indoor/outdoor unit PCB
- Defective magnetic switch
- Defective power transistor
- Defective compressor

Troubleshooting



Caution Be sure to turn off power switch before connect or disconnect connector, or parts damage may be occurred.

- Indoor unit fan runs at set airflow rate.
- (In cooling operation)
When suction air thermistor temperature is higher than set temperature
- (In heating operation)
When suction air thermistor temperature is lower than set temperature

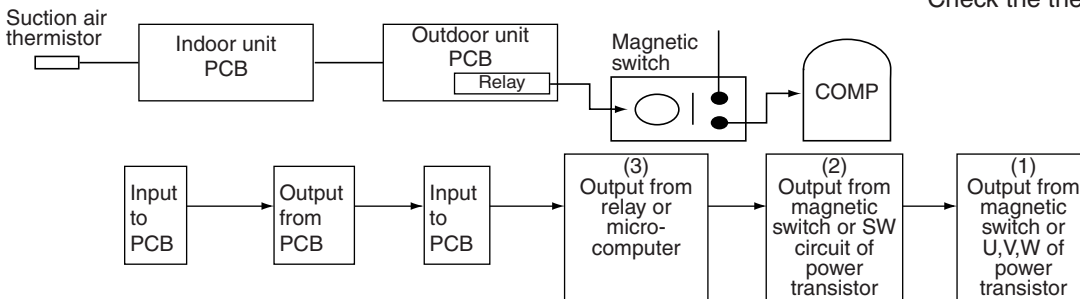
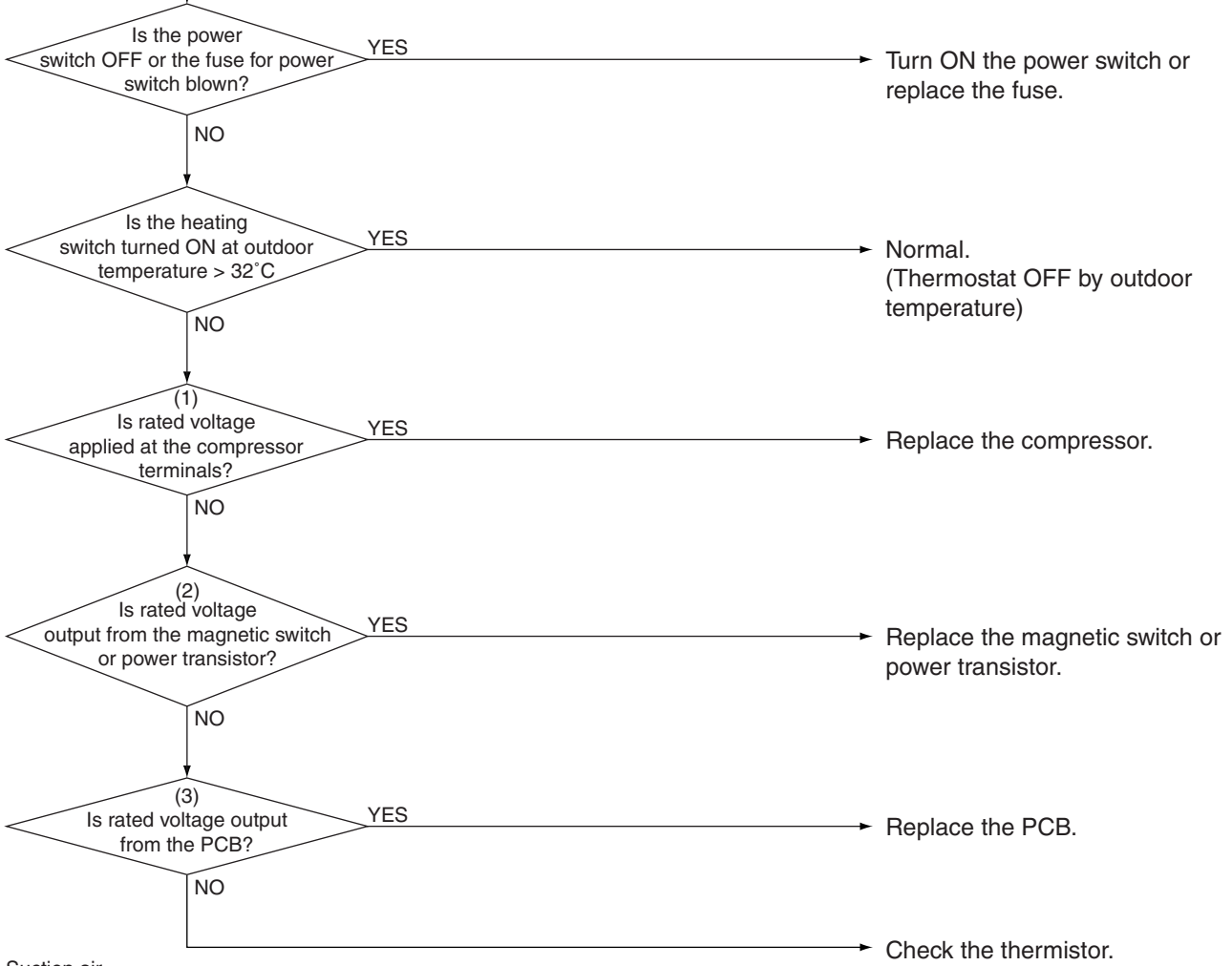

2.4 Cooling / Heating Operation Starts but Stops Immediately

Applicable Model All models of SkyAir series

Supposed Causes

- Overcharge of refrigerant
- Air mixed in refrigerant system
- Defective pressure switch
- Defective magnetic switch for outdoor unit fan motor
- Defective aux. relay for outdoor unit fan motor
- Soiled heat exchanger of outdoor unit
- There is an interfering item in airflow of outdoor unit.
- Defective outdoor unit fan
- Soiled air filter of indoor unit
- Soiled heat exchanger of indoor unit
- There is some interfering item in airflow of indoor unit.
- Defective indoor unit fan

Troubleshooting



Caution Be sure to turn off power switch before connect or disconnect connector, or parts damage may be occurred.

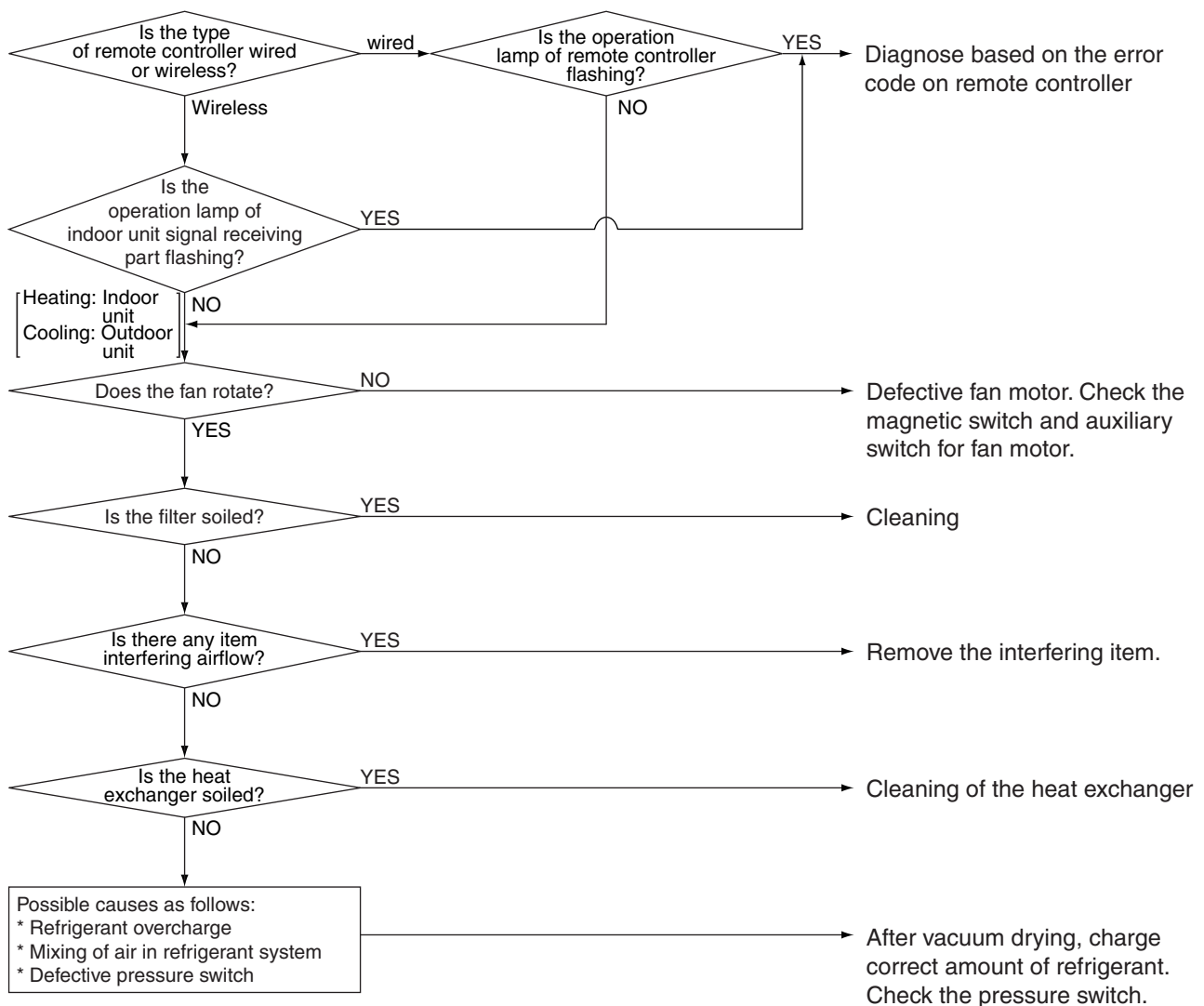

2.5 After Unit Shuts Down, It cannot be Restarted for a While

Applicable Model All models of SkyAir series

Supposed Causes

- Overcurrent relay (for compressor)
Overcurrent relay may act due to the following reasons
 - Lower voltage of power supply
 - Excess level of high pressure
 - Insufficient size of power cable
 - Defective compressor
- Compressor protection thermostat
Compressor protection thermostat may act due to the following reasons
 - Internal leakage of four way valve (There is no difference between suction and discharge temperature)
 - Insufficient compression of compressor
 - Incorrect refrigerant
 - Defective electronic expansion valve
 - Insufficient circulation of refrigerant

Troubleshooting



Caution Be sure to turn off power switch before connect or disconnect connector, or parts damage may be occurred.

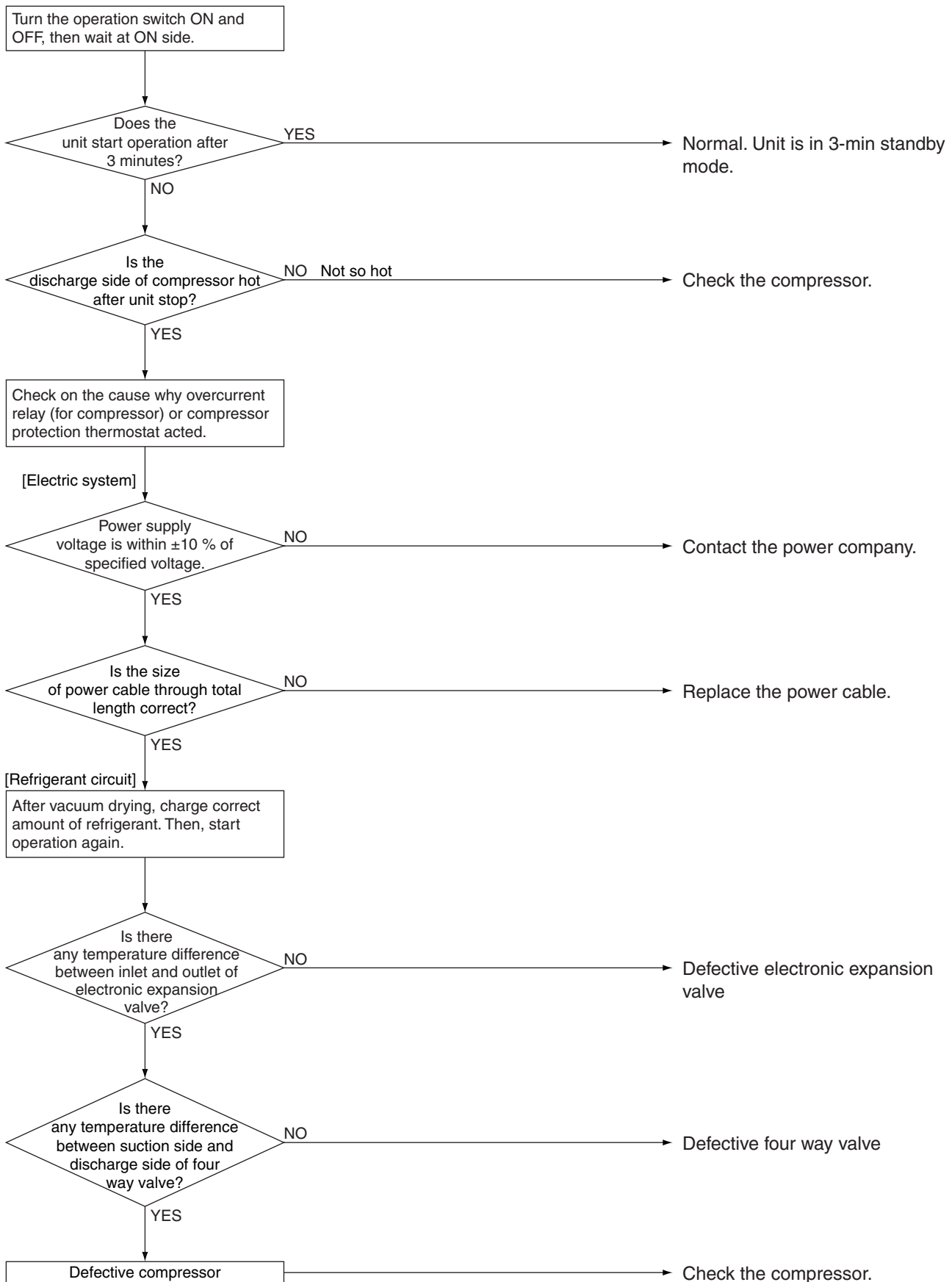

2.6 Equipment Operates but does not Provide Cooling

Applicable Model All models of SkyAir series

Supposed Causes

- Overcurrent relay (for compressor)
Overcurrent relay may act due to the following reasons
 - Lower voltage of power supply
 - Excess level of high pressure
 - Insufficient size of power cable
 - Defective compressor
- Compressor protection thermostat
Compressor protection thermostat may act due to the following reasons
Internal leakage of four way valve (There is no difference between suction and discharge temperature)
 - Insufficient compression of compressor
 - Incorrect refrigerant charge/leak
 - Defective electronic expansion valve
 - Insufficient circulation of refrigerant
- Defective thermistors or thermistor out of position

Troubleshooting



Caution Be sure to turn off power switch before connect or disconnect connector, or parts damage may be occurred.

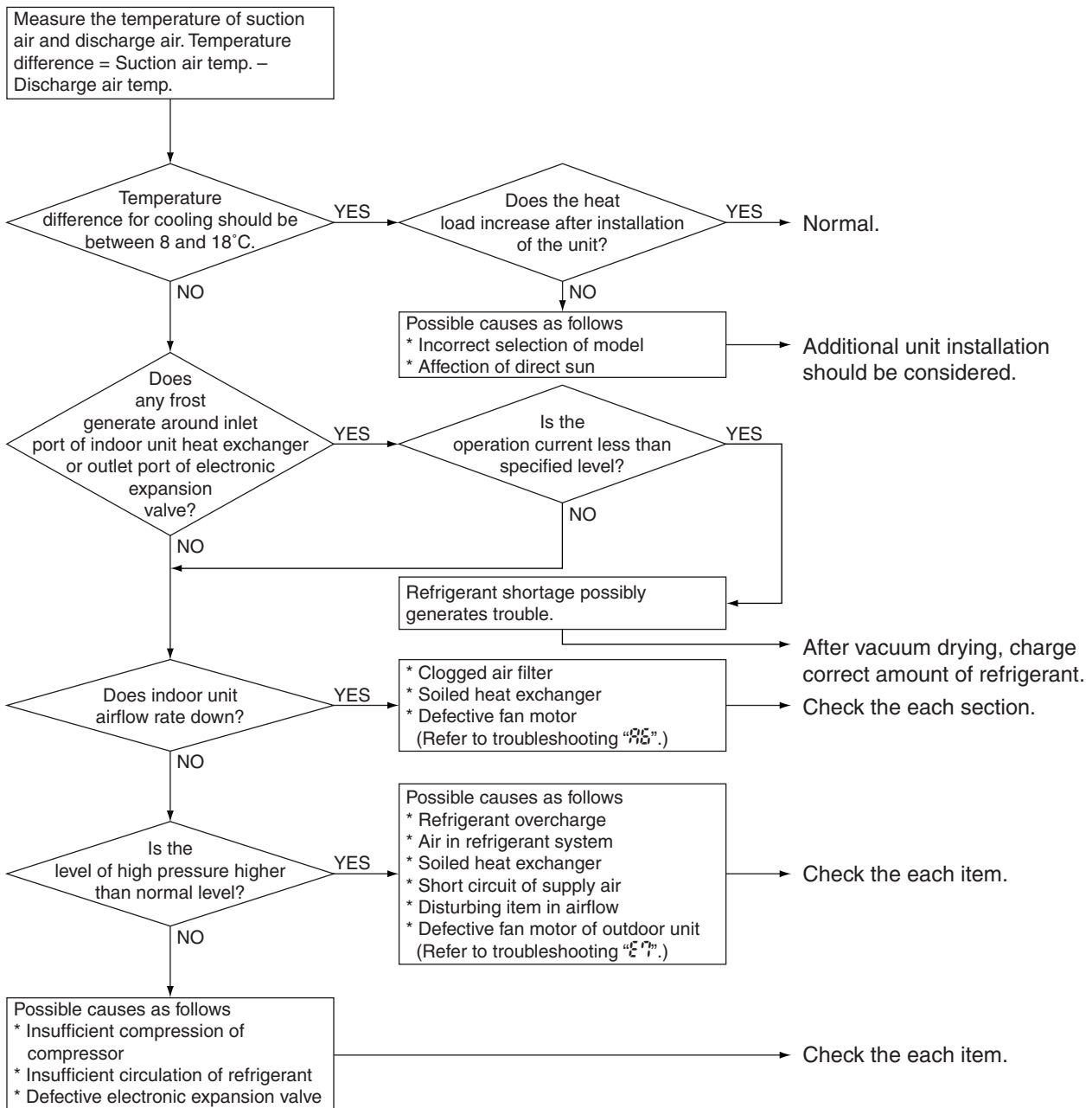

2.7 Equipment Operates but does not Provide Heating

Applicable Model All models of SkyAir series

Supposed Causes

- Overcharge of refrigerant
- Air mixed in refrigerant system
- Defective pressure switch
- Defective magnetic switch for outdoor unit fan motor
- Defective aux. relay for outdoor unit fan motor
- Soiled heat exchanger of outdoor unit
- There is an interfering item in airflow of outdoor unit.
- Defective outdoor unit fan
- Soiled air filter of indoor unit
- Soiled heat exchanger of indoor unit
- There is an interfering item in airflow of indoor unit.
- Defective indoor unit fan

Troubleshooting



Caution Be sure to turn off power switch before connect or disconnect connector, or parts damage may be occurred.

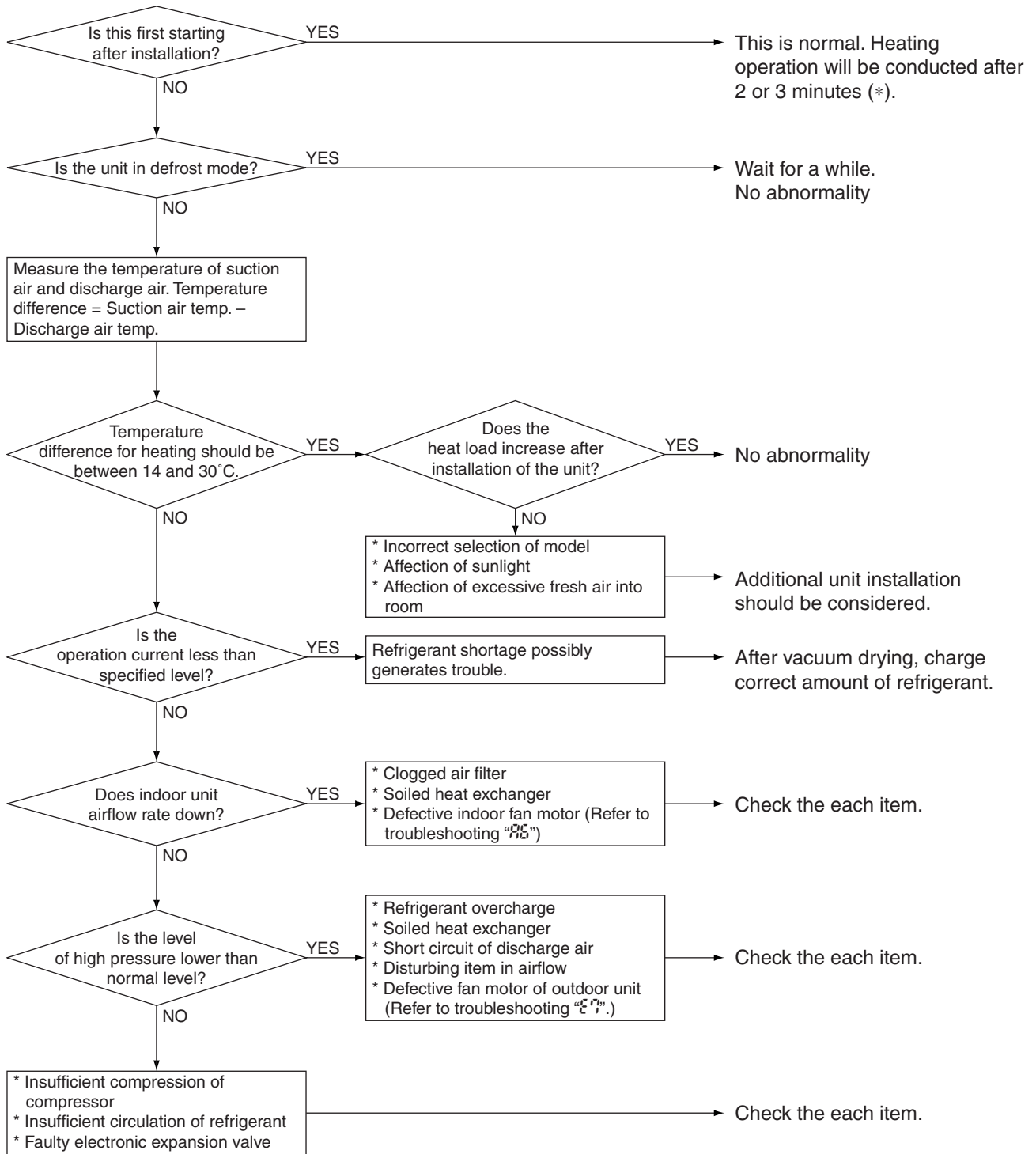

*: Refer to “Test Operation” on P.50.

2.8 Equipment Discharges White Mist

Applicable Model All models of SkyAir series

Supposed Causes

- Humid installation site
- Installation site is dirty and with dense oil mists.
- Soiled heat exchanger
- Clogged air filter
- Defective fan motor

Troubleshooting



Caution Be sure to turn off power switch before connect or disconnect connector, or parts damage may be occurred.

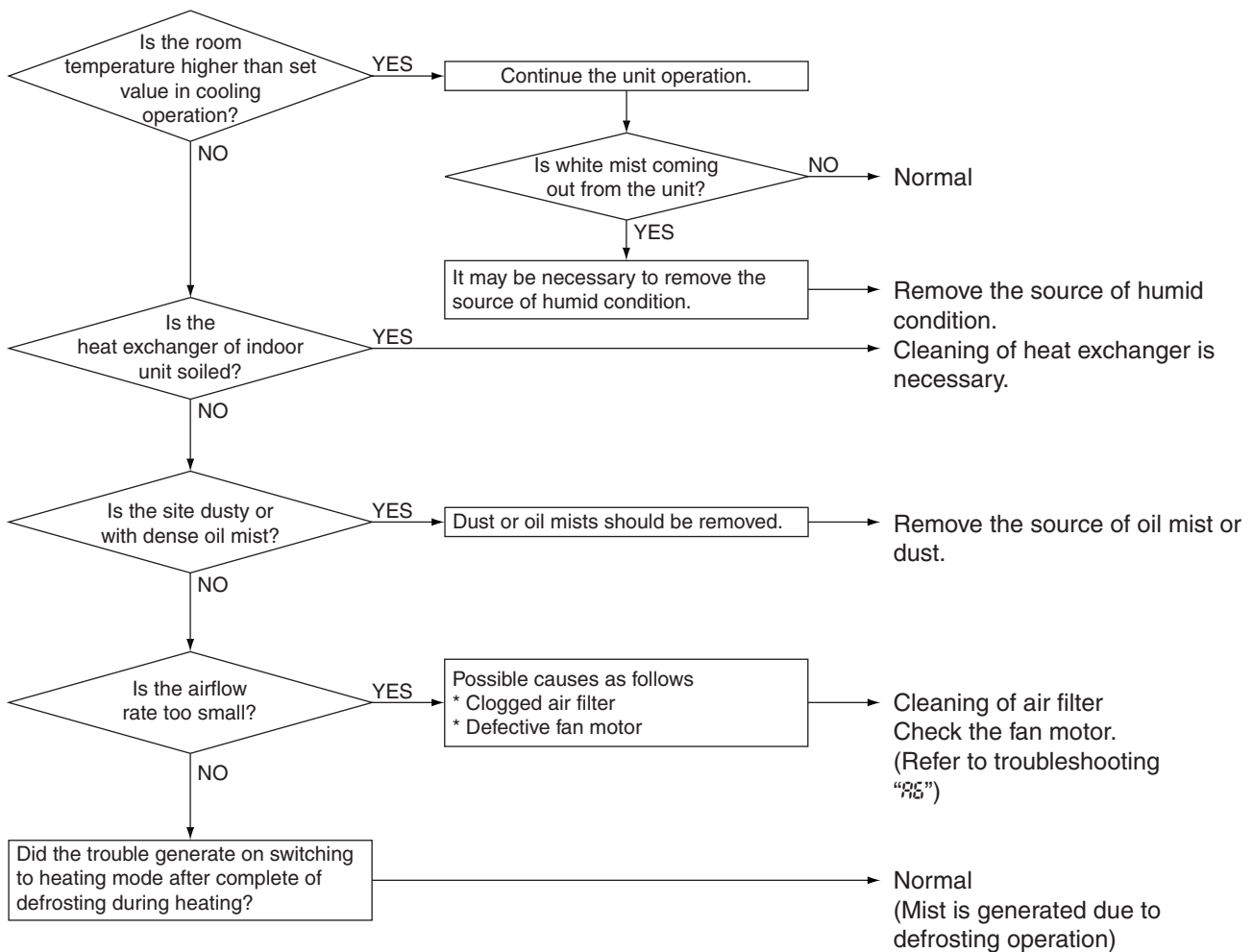

2.9 Equipment Produces Loud Noise or Vibration

Applicable Model All models of SkyAir series

Supposed Causes

- Defective installation
- Overcharge of refrigerant
- Air mixed in refrigerant system
- Flushing noise due to refrigerant shortage. (Sound of shoo...)

Troubleshooting



Caution Be sure to turn off power switch before connect or disconnect connector, or parts damage may be occurred.

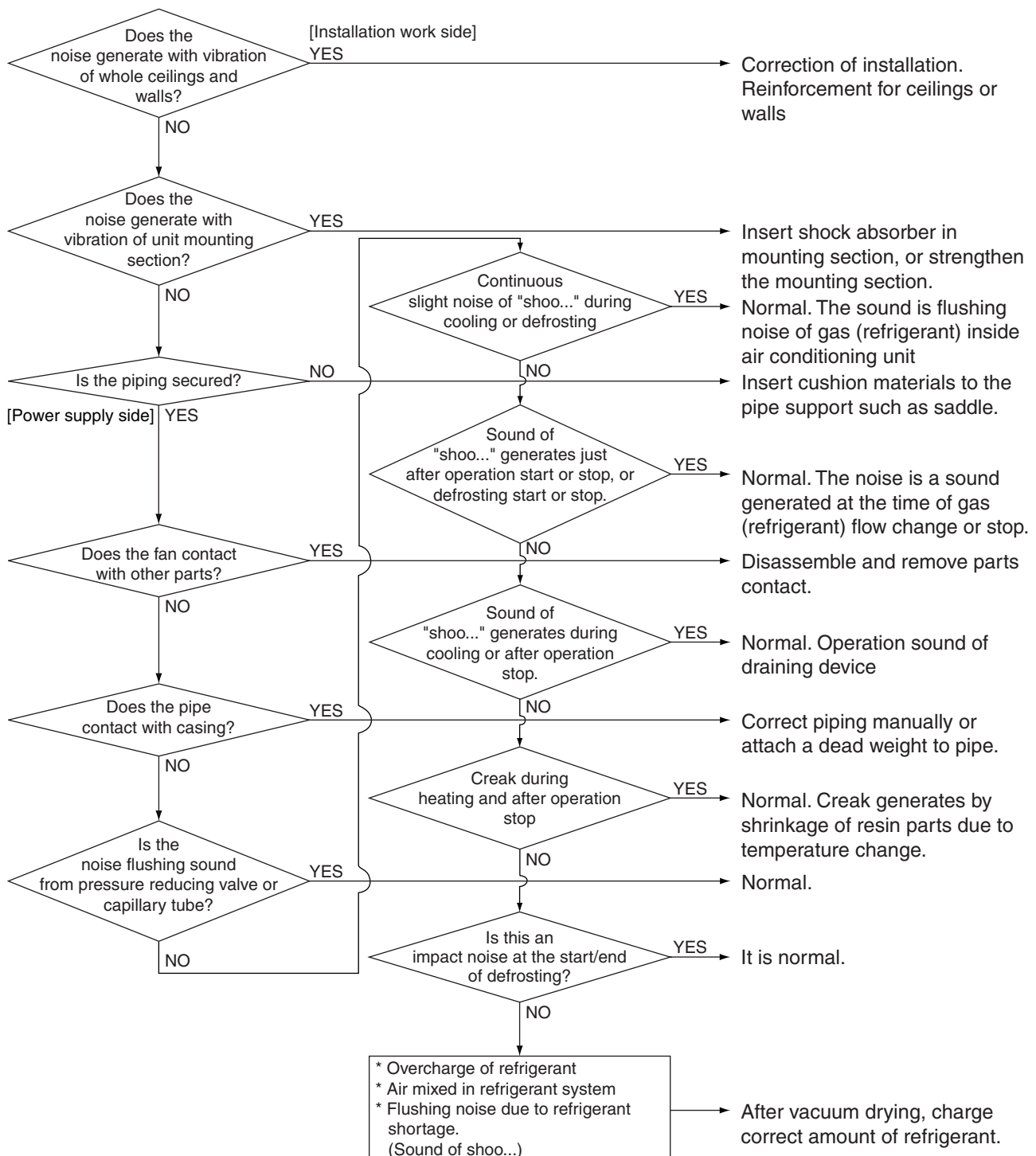

2.10 Equipment Discharges Dust

Applicable Model All models of SkyAir series

- Supposed Causes**
- Carpet
 - Animal hair
 - Application (cloth shop,...)

Troubleshooting



Caution Be sure to turn off power switch before connect or disconnect connector, or parts damage may be occurred.

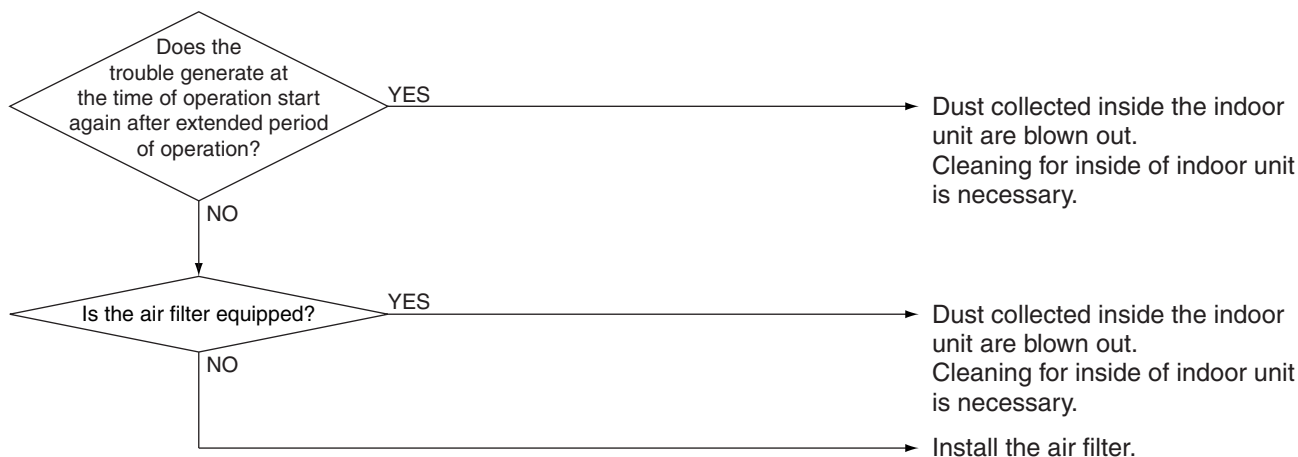

2.11 Remote Controller LCD Displays "88"

Applicable Model All models of SkyAir series

Supposed Causes

Troubleshooting



Caution Be sure to turn off power switch before connect or disconnect connector, or parts damage may be occurred.

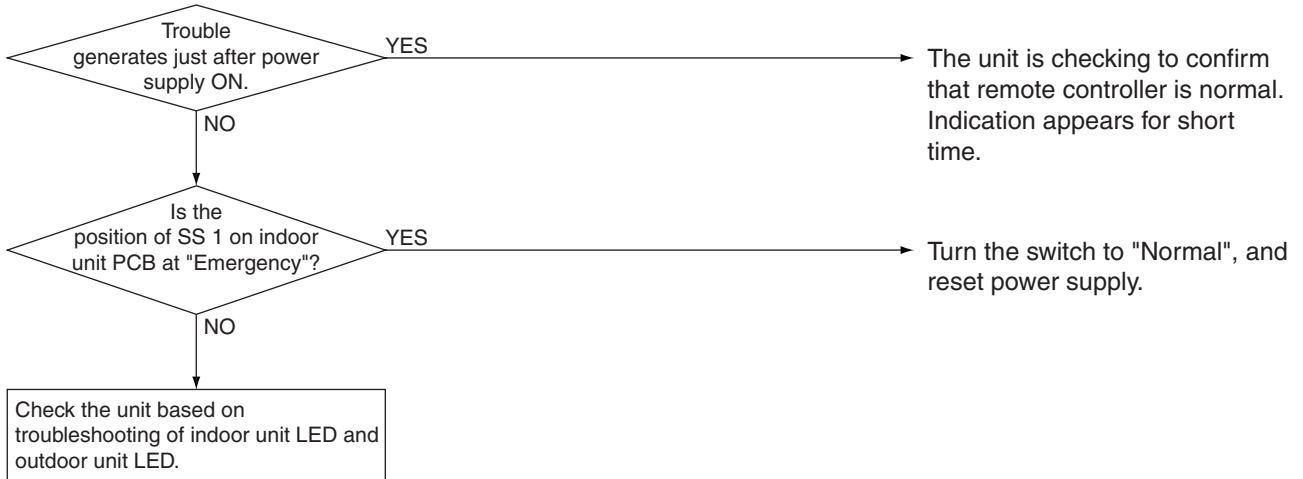

2.12 Swing Flap does not Operate

Applicable Models	All models of SkyAir series
Method of Error Detection	Visual check
Error Decision Conditions	When ON/OFF of the micro-switch for positioning cannot be reversed even through the swing flap motor for a specified amount of time (about 30 seconds).
Remark	<p>Some functions can force the swing flap into a fixed position, although swing mode is selected on the remote controller. This is not a unit error, but a control function to prevent draft to the customer.</p> <p>Before starting the troubleshooting, make sure the swing flap is not forced into such a fixed position. (e.g. Hot start, defrost operation, thermostat OFF in heating operation or freeze prevention in cooling operation. For details refer to "Swing Pattern Selection" on P.30.)</p>
Supposed Causes	<ul style="list-style-type: none"> ■ Faulty swing motor ■ Faulty micro-switch ■ Faulty connector connection ■ Faulty indoor unit PCB

Troubleshooting

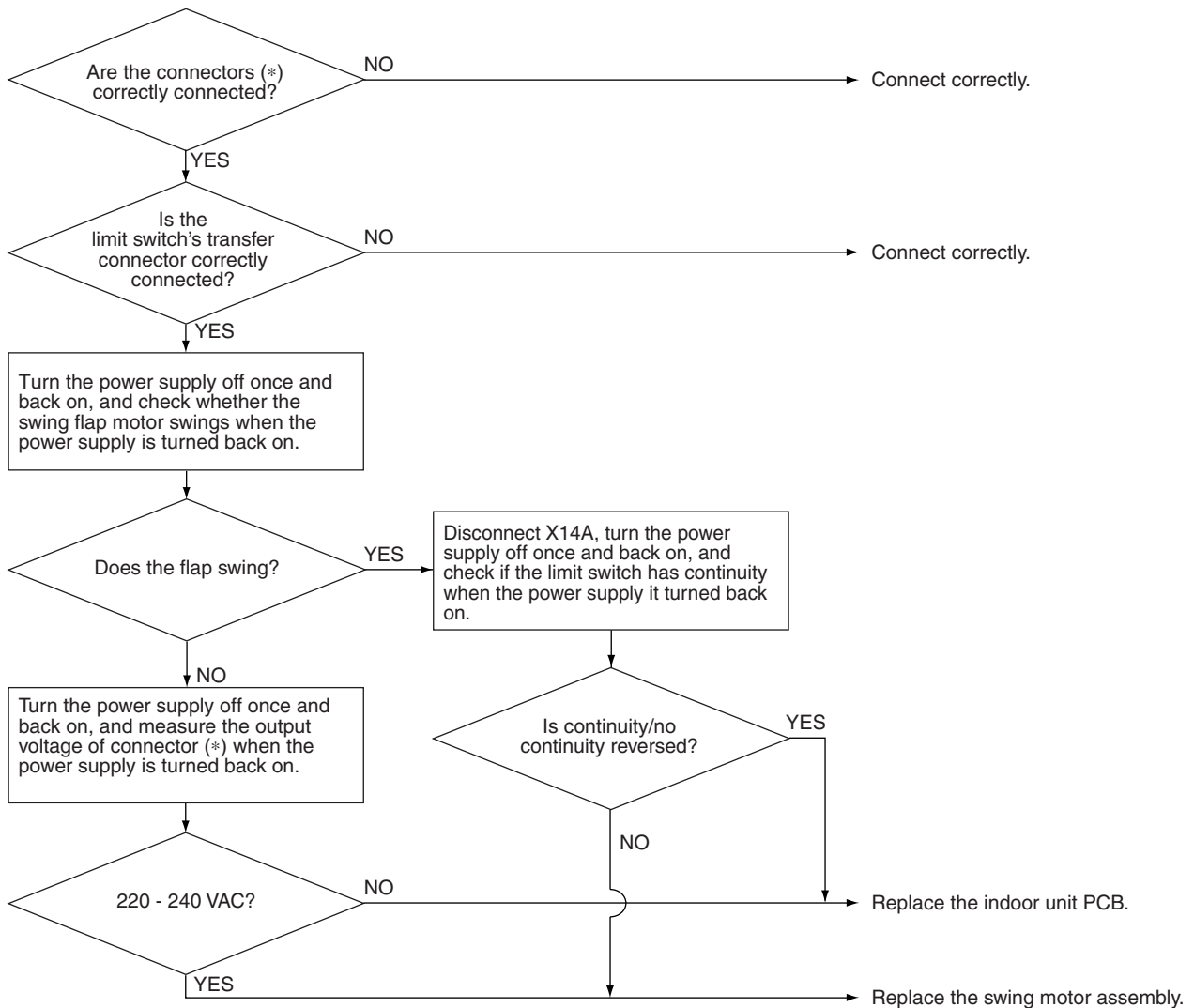

Caution Be sure to turn off power switch before connect or disconnect connector, or parts damage may be occurred.

**Note:**

*

Model	Connector for swing flap motor	PCB
FCQG	X9A	A2P
FHQG	X36A	A1P

3. Troubleshooting by LED Indications

3.1 Troubleshooting by LED on the Indoor Unit

Foreword

Troubleshooting can be carried out by service monitor LED (green). (Blinks when normal)

○ : LED on / ● : LED off / ◐ : LED blinks

Micro-computer Normal Monitor	Contents/Processing
HAP (LED-A)	
◐	Indoor unit normal → Outdoor unit troubleshooting
◐	Incorrect transmission wiring between indoor and outdoor unit If outdoor unit's LED-A is OFF, proceed outdoor unit's troubleshooting. If outdoor unit's LED-A blinks, defective wiring or indoor or outdoor unit PCB assy.
○	Defective indoor unit PCB assy
●	Defective power supply or defective PCB assy or broken transmission wire between indoor and outdoor unit.



Note:

1. When the INSPECTION/TEST button of remote controller is pushed, **INSPECTION** display blinks entering **INSPECTION** mode.
2. In the **INSPECTION** mode, when the ON/OFF button is pushed and held for 5 seconds or more, the aforementioned error history display is OFF. In this case, after the error code blinks 2 times, the code display turns to "00" (=Normal) and the unit No. turns to "0". The INSPECTION mode automatically switches to the normal mode (set temperature display).
3. Operation halts due to error depending on the model or condition.
4. Troubleshoot by turning OFF the power supply for a minimum of 5 seconds, turning it back ON, and then rechecking the LED display.

3.2 Troubleshooting by LED on Outdoor Unit PCB

The following diagnosis can be conducted by turning ON the power switch and checking the LED indication on PCB (A1P) of the outdoor unit.

○ : LED on / ● : LED off / ◐ : LED blinks

LED detection		Description
HAP	H1P	
(Green)	(Red)	
◐	●	Normal
○	—	Defective outdoor unit PCB (Note 1)
●	—	Power supply abnormality, or defective outdoor unit PCB (Note 2)
◐	○	Activation of protection device (Note 3)



Note:

1. Turn OFF the power supply, and turn it ON again after 5 seconds or more. Check the error condition, and diagnose the problem.
2. Turn OFF the power supply. After 5 seconds or more, disconnect the connection wire (2). Then turn ON the power supply. If the HAP on the outdoor unit PCB flashes after about 10 seconds, the indoor unit PCB is faulty.
3. Also check for open phase.

Remark:

The error detection monitor continues to indication the previously generated error until the power supply is turned OFF.

Be sure to turn OFF the power supply after inspection.

4. Troubleshooting by Remote Controller

4.1 Procedure of Self-diagnosis by Remote Controller

4.1.1 Wired Remote Controller — BRC1D528

If operation stops due to error, the remote controller's operation LED blinks, and error code is displayed. (Even if stop operation is carried out, error contents are displayed when the inspection mode is entered.) The error code enables you to tell what kind of error caused operation to stop. Refer to P.106 for error code and error contents.

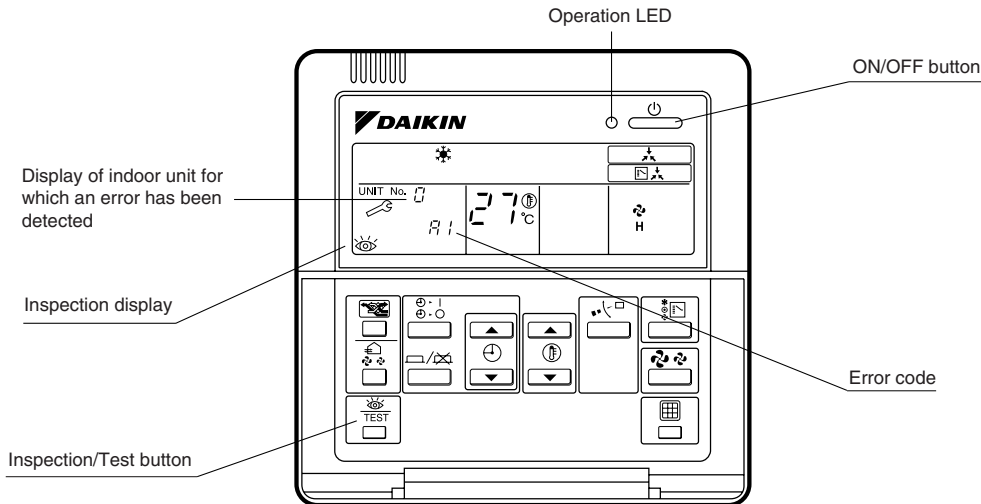

Note:

1. Pressing the INSPECTION/TEST button will blink the check indication.
2. While in service mode, holding down the ON/OFF button for a period of 5 seconds or more will clear the failure history indication shown above. In this case, on the codes display, the error code will blink twice and then change to "00" (=Normal), the Unit No. will change to "0", and the operation mode will automatically switch from service mode to normal mode (displaying the set temperature).

4.1.2 Wired Remote Controller — BRC1E51A7

The following will be displayed on the screen when a malfunction (or a warning) occurs during operation. Check the malfunction code and take the corrective action specified for the particular model.

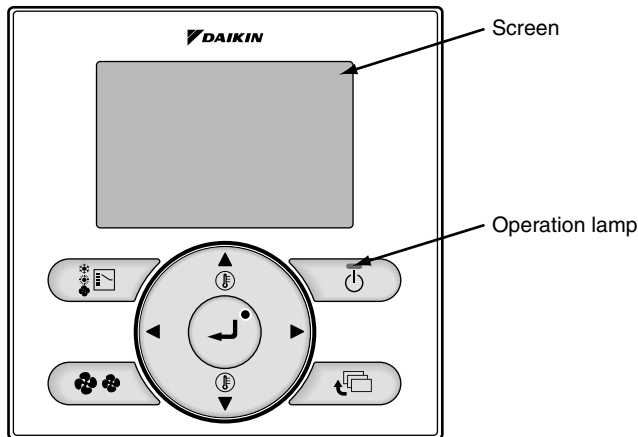

(1) Checking a malfunction or warning

	Operation Status	Display	
Abnormal shutdown	The system stops operating.	The operation lamp (green) starts to blink. The message "Error: Press Menu button" will appear and blink at the bottom of the screen.	
Warning	The system continues its operation.	The operation lamp (green) remains on. The message "Warning: Press Menu button" will appear and blink at the bottom of the screen.	

(2) Taking corrective action

- Press the Menu/Enter button to check the error code.



- Take the corrective action specific to the model.

Error code:A1

Contact address
0123-456-789

Indoor Unit FXMQ40PVE
Outdoor Unit RWEYQ10PY1

Return

— Error code

└─ Applicable model names

4.1.3 Wireless Remote Controller

If unit stops due to an error, the operation indicating LED on the signal receiving part of indoor unit flashes. The error code can be determined by following the procedure described below. (The error code is displayed when an operation error has occurred. In normal condition, the error code of the last problem is displayed.)

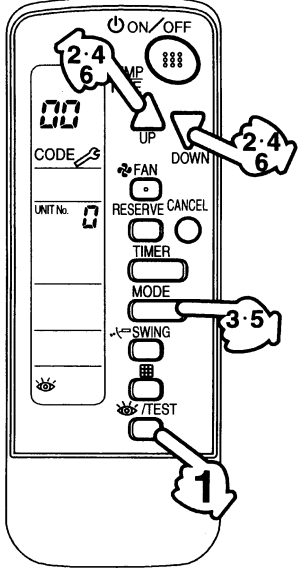
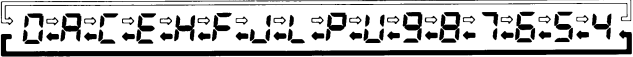
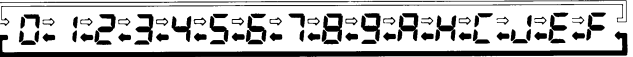
1	Press the INSPECTION/TEST button to select "inspection". The equipment enters the inspection mode. The "Unit" indication is displayed and the Unit No. display shows flashing "0" indication.	
2	Set the Unit No. Press the UP or DOWN button and change the Unit No. display until the buzzer (*1) is generated from the indoor unit. *1 Number of beeps 3 short beeps : Conduct all of the following operations. 1 short beep : Conduct steps 3 and 4. Continue the operation in step 4 until a buzzer remains ON. The continuous buzzer indicates that the error code is confirmed. Continuous beep : No abnormality.	
3	Press the MODE selector button. The left "0" (upper digit) indication of the error code flashes.	
4	Error code upper digit diagnosis Press the UP or DOWN button and change the error code upper digit until the error code matching buzzer (*2) is generated. ■ The upper digit of the code changes as shown below when the UP and DOWN buttons are pressed. <div style="text-align: center;">  <p>⇒ "UP" button ← "DOWN" button</p> </div> *2 Number of beeps Continuous beep : Both upper and lower digits matched. (Error code confirmed) 2 short beeps : Upper digit matched. 1 short beep : Lower digit matched.	
5	Press the MODE selector button. The right "0" (lower digit) indication of the error code flashes.	
6	Error code lower digit diagnosis Press the UP or DOWN button and change the error code lower digit until the continuous error code matching buzzer (*2) is generated. ■ The lower digit of the code changes as shown below when the UP and DOWN buttons are pressed. <div style="text-align: center;">  <p>⇒ "UP" button ← "DOWN" button</p> </div>	

Normal status
 Enters inspection mode from normal status when the INSPECTION/ TEST button is pressed.

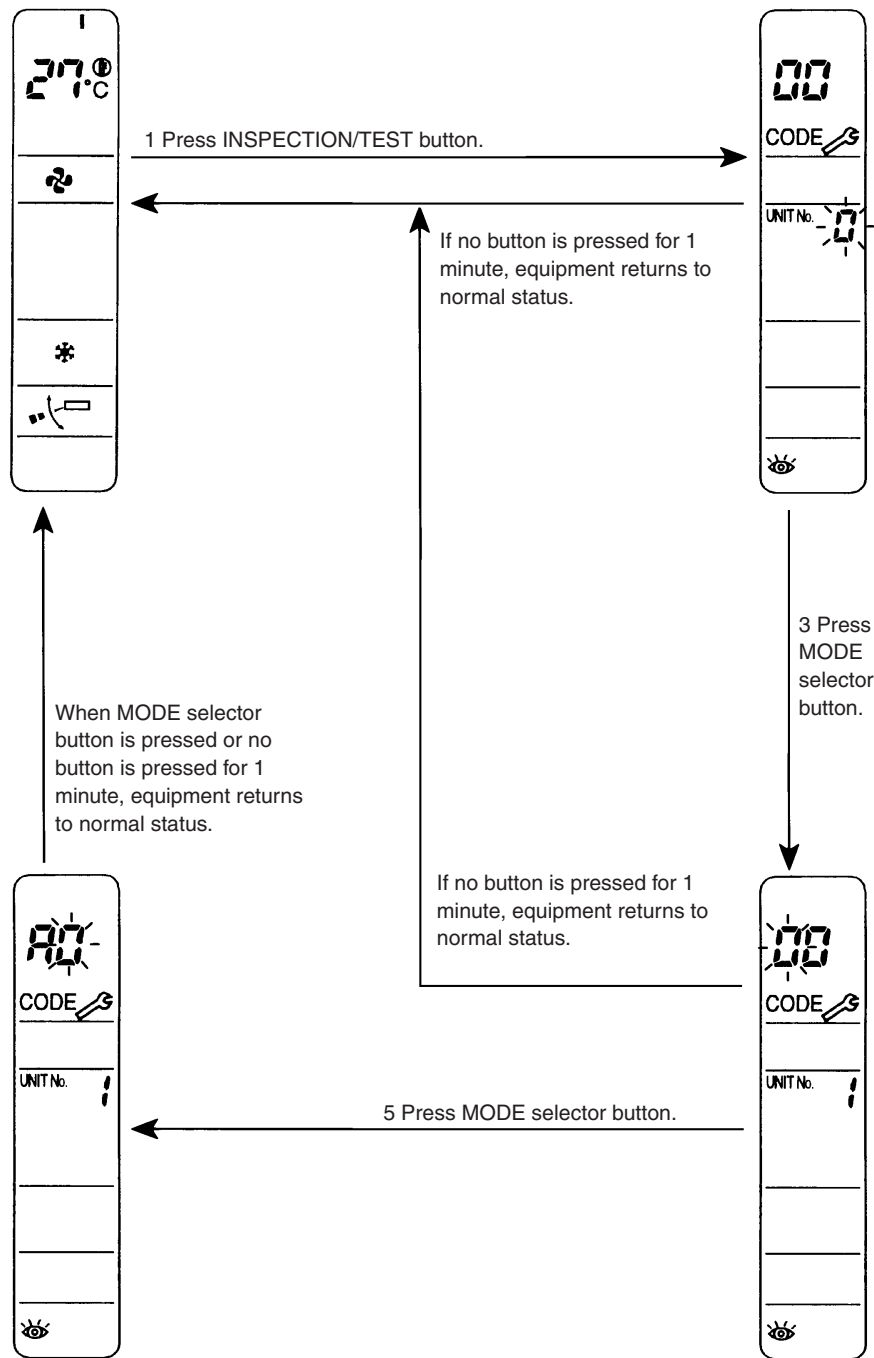

4.2 Error Codes and Description

	Remote Controller Display	Contents of Error	Reference Page
Indoor Unit	P1	Indoor unit PCB abnormality	108
	P3	Drain water level system abnormality	109
	P6	Indoor unit fan motor abnormality	111
	PJ	Capacity setting abnormality	112
	C1	Transmission Error (between indoor unit PCB and adaptor PCB)	113
	C4	Heat exchanger thermistor system abnormality	115
	C5	Intermediate heat exchanger thermistor system abnormality	115
	C9	Suction air thermistor system abnormality	115
	CC	Humidity sensor system abnormality	116
	CJ	Remote controller thermistor abnormality	117
Outdoor Unit	E1	Outdoor unit PCB abnormality	118
	E3	High pressure abnormality (detected by the high pressure switch)	119
	E4	Actuation of pressure sensor	123
	E5	Compressor motor lock	125
	E7	Outdoor unit fan motor abnormality	126
	E9	Electronic expansion valve abnormality	128
	F3	Discharge pipe temperature control	131
	H3	High pressure switch system abnormality	133
	H9	Outdoor air thermistor system abnormality	134
	J3	Discharge pipe thermistor system abnormality	134
	J5	Suction pipe thermistor system abnormality	134
	J6	Heat exchanger thermistor system abnormality	134
	J7	Intermediate heat exchanger thermistor system abnormality	134
	J8	Liquid pipe thermistor system abnormality	134
	L1	Outdoor unit PCB abnormality	135
	L4	Radiation fin temperature rise	137
	L5	Output overcurrent detection	139
	L8	Electronic thermal (time lag)	141
	L9	Stall prevention (time lag)	143
	LC	Transmission system abnormality (between control and inverter PCB)	145
	P1	Open phase or power supply voltage imbalance	146
	PJ	Defective capacity setting	147
	U0	Refrigerant shortage	148
	U2	Power supply voltage abnormality	151
System	U4	Transmission error between indoor and outdoor unit	153
	U5	Transmission error between remote controller and indoor unit	156
	UB	Transmission error between MAIN remote controller and SUB remote controller	157
	UR	Field setting switch abnormality	158
	UC	Address duplication of centralized controller	160
	UE	Transmission error between centralized controller and indoor unit	161
	UF	Transmission error between indoor and outdoor unit / piping and wiring mismatch / refrigerant shortage	163

4.3 Safety Devices

4.3.1 Outdoor Unit

Model	High pressure switch		Fuse
	Open	Close	
RZQG71L	4.0 MPa +0/- 0.15	3.0 MPa ± 0.15	6.3A/250V (F1U), 3.15A/250V (F6U)
RZQG100L			6.3A/250V (F1U, F2U, F3U), 5A/250V (F6U)
RZQG125L			
RZQG160L			

4.3.2 Indoor Unit

Model	Thermal protector		Fuse
	Abnormal	Reset (automatic)	
FCQG	—	—	N.A.
FHQG			3.15A/250V (F1U)

4.4 Indoor Unit PCB Abnormality

Remote Controller Display	
Applicable Models	All models of indoor unit
Method of Error Detection	Check data from E ² PROM.
Error Decision Conditions	<p>The error is generated when the data from the E²PROM is not received correctly.</p> <p>E²PROM (Electrically Erasable Programmable Read Only Memory): A memory chip that holds its content without power. It can be erased, either within the computer or externally and usually requires more voltage for erasure than the common +5 volts used in logic circuits. It functions like non-volatile RAM, but writing to E²PROM is slower than writing to RAM.</p>
Supposed Causes	<ul style="list-style-type: none"> ■ Defective indoor unit PCB ■ External factor (Noise, etc.)

Troubleshooting



Caution Be sure to turn off power switch before connect or disconnect connector, or parts damage may be occurred.



4.5 Drain Water Level System Abnormality

Remote Controller Display	83
Applicable Models	All models of indoor unit
Method of Error Detection	By float switch OFF detection
Error Decision Conditions	The error is generated when the water level reaches its upper limit and when the float switch turns OFF.
Supposed Causes	<ul style="list-style-type: none">■ Defective drain pump■ Improper drain piping work■ Drain piping clogging■ Defective float switch■ Defective indoor unit PCB■ Defective short circuit connector X15A on PCB

Troubleshooting



Caution Be sure to turn off power switch before connect or disconnect connector, or parts damage may be occurred.

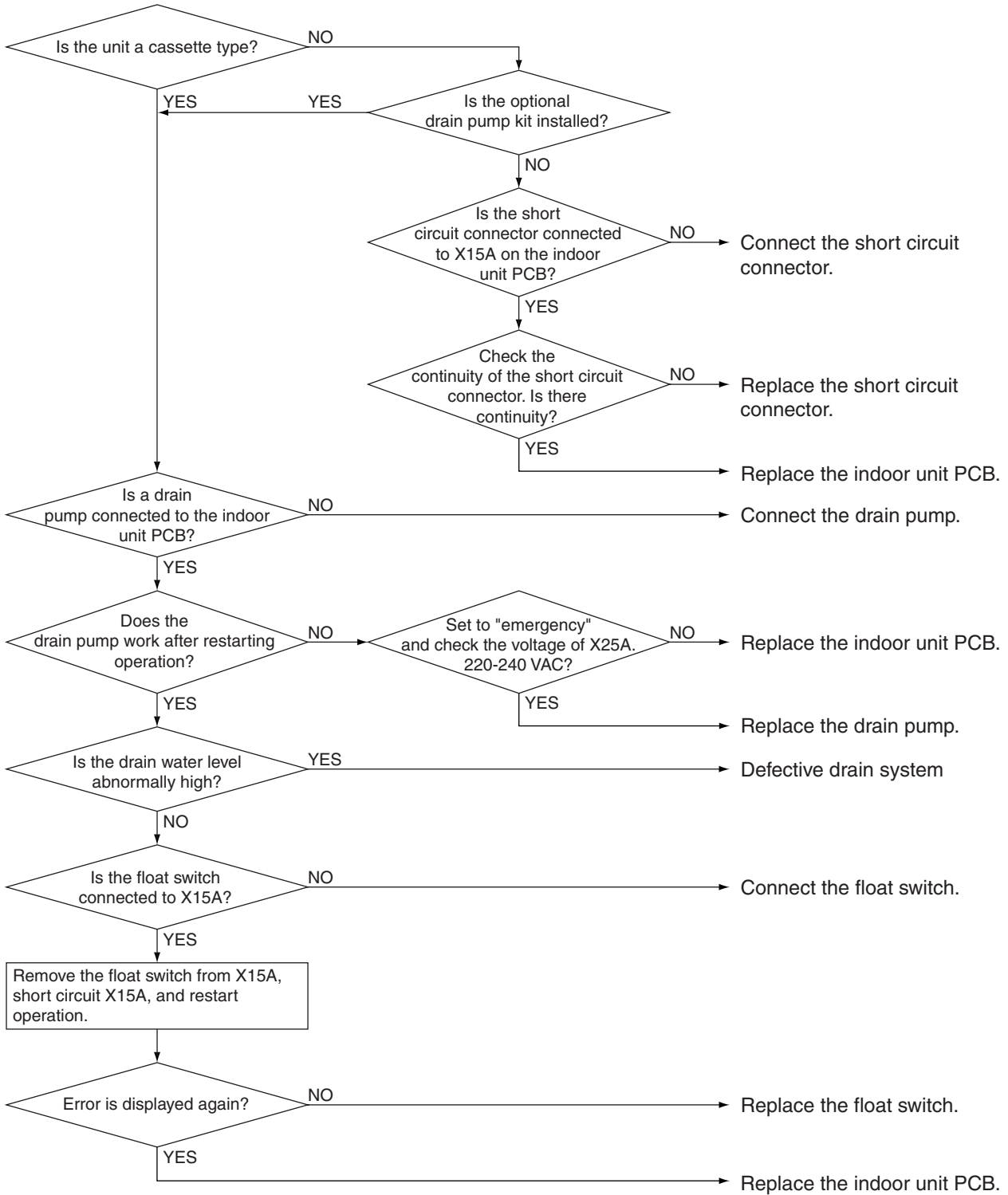

Note:
If "R3" is detected by a PCB without X15A, the PCB is defective.

4.6 Indoor Unit Fan Motor Abnormality

Remote Controller Display	
Applicable Models	All models of indoor unit
Method of Error Detection	Detection of abnormal rotation speed of fan motor by signal from the fan motor
Error Decision Conditions	The error is generated when the rotation speed of the fan motor are not detected while the output voltage to the fan is at its maximum.
Supposed Causes	<ul style="list-style-type: none"> ■ Defective indoor unit fan motor ■ Breaking or disconnection of wire ■ Defective contact ■ Defective indoor unit PCB

Troubleshooting



Caution Be sure to turn off power switch before connect or disconnect connector, or parts damage may be occurred.

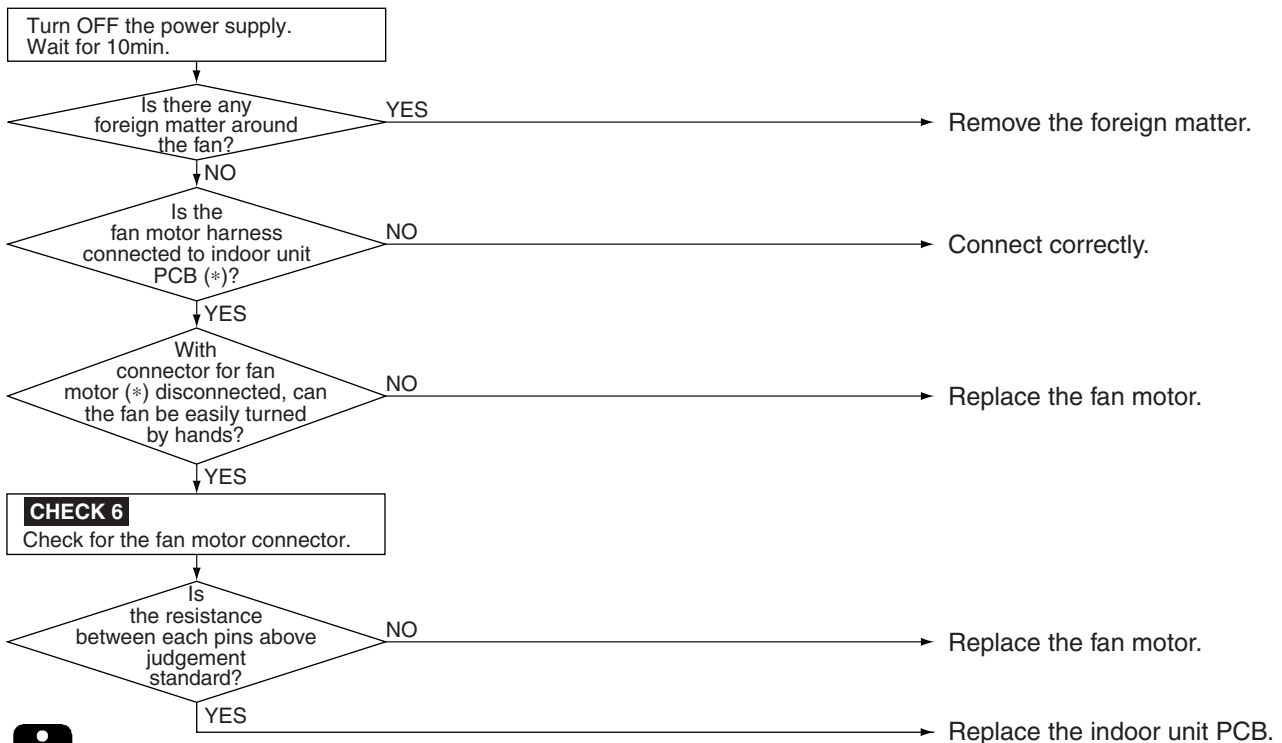

Note:

* Connector and indoor unit PCB

Model	Connector for fan motor	PCB
FCQG	X20A	A1P
FHQG	X20A	A1P



CHECK 6 Refer to P.172.

4.7 Capacity Setting Abnormality

Remote Controller Display							
Applicable Models	All models of indoor unit						
Method of Error Detection	Capacity is determined according to resistance of the capacity setting adaptor and the memory inside the IC memory on the indoor unit PCB, and whether the value is normal or abnormal is determined.						
Error Decision Conditions	<p>The error is generated when the following conditions are fulfilled:</p> <table border="1"> <thead> <tr> <th>Condition</th> <th>Description</th> </tr> </thead> <tbody> <tr> <td>1</td> <td> <ul style="list-style-type: none"> ● The unit is in operation. ● The PCB's memory IC does not contain the capacity code. ● The capacity setting adaptor is not connected. </td> </tr> <tr> <td>2</td> <td> <ul style="list-style-type: none"> ● The unit is in operation. ● The capacity that is set, does not exist for that unit. </td> </tr> </tbody> </table>	Condition	Description	1	<ul style="list-style-type: none"> ● The unit is in operation. ● The PCB's memory IC does not contain the capacity code. ● The capacity setting adaptor is not connected. 	2	<ul style="list-style-type: none"> ● The unit is in operation. ● The capacity that is set, does not exist for that unit.
Condition	Description						
1	<ul style="list-style-type: none"> ● The unit is in operation. ● The PCB's memory IC does not contain the capacity code. ● The capacity setting adaptor is not connected. 						
2	<ul style="list-style-type: none"> ● The unit is in operation. ● The capacity that is set, does not exist for that unit. 						
Supposed Causes	<ul style="list-style-type: none"> ■ Defective capacity setting adaptor connection ■ Defective indoor unit PCB 						
Capacity setting adaptor	<p>The capacity is set in the PCB's memory IC. A capacity setting adaptor that matches the capacity of the unit is required in the following case:</p> <p>In case the indoor PCB installed at the factory is for some reason changed at the installation site, the capacity will not be contained in the replacement PCB. To set the correct capacity for the PCB you have to connect a capacity setting adaptor with the correct capacity setting to the PCB. The capacity setting for the PCB will become the capacity setting of the adaptor because the capacity setting adaptor has priority.</p>						

Troubleshooting



Caution Be sure to turn off power switch before connect or disconnect connector, or parts damage may be occurred.

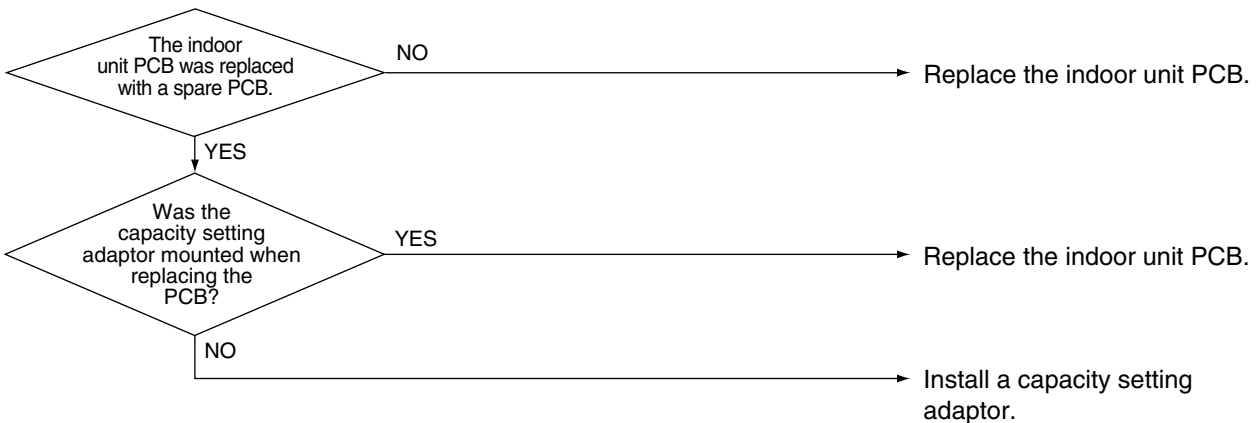

4.8 Transmission Error (between Indoor Unit PCB and Adaptor PCB)

Remote Controller Display	
Applicable Models	FCQG
Method of Error Detection	Check the condition of transmission between indoor unit PCB (A1P) and adaptor PCB (A2P) using micro-computer.
Error Decision Conditions	When normal transmission is not conducted for certain duration (15 seconds or more). After 60 seconds, error is display on the remote controller.
Supposed Causes	<ul style="list-style-type: none"> ■ Connection defect of the connector indoor unit PCB (A1P) and adaptor PCB (A2P) ■ Defective indoor unit PCB (A1P) ■ Defective adaptor PCB (A2P) ■ External factor (Noise, etc.)

Troubleshooting



Caution Be sure to turn off power switch before connect or disconnect connector, or parts damage may be occurred.

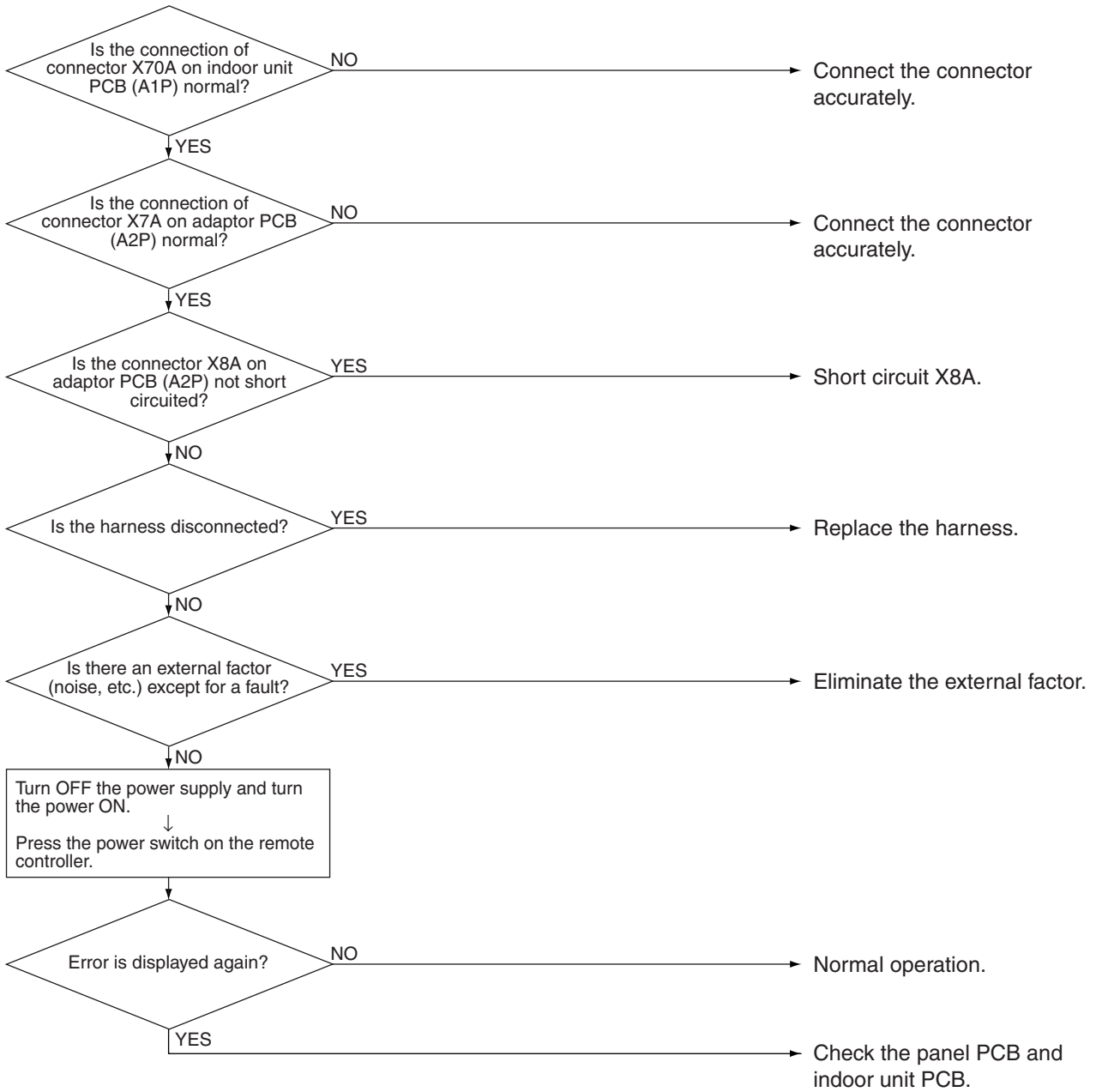

4.9 Thermistor Abnormality

Remote Controller Display	U4, U5, U9
Applicable Models	All models of indoor unit
Method of Error Detection	The error is detected by temperature detected by thermistor.
Error Decision Conditions	When the thermistor becomes disconnected or shorted while the unit is running.
Supposed Causes	<ul style="list-style-type: none"> ■ Defective connector connection ■ Defective thermistor ■ Defective indoor unit PCB ■ Broken or disconnected wire

Troubleshooting



Caution Be sure to turn off power switch before connect or disconnect connector, or parts damage may be occurred.

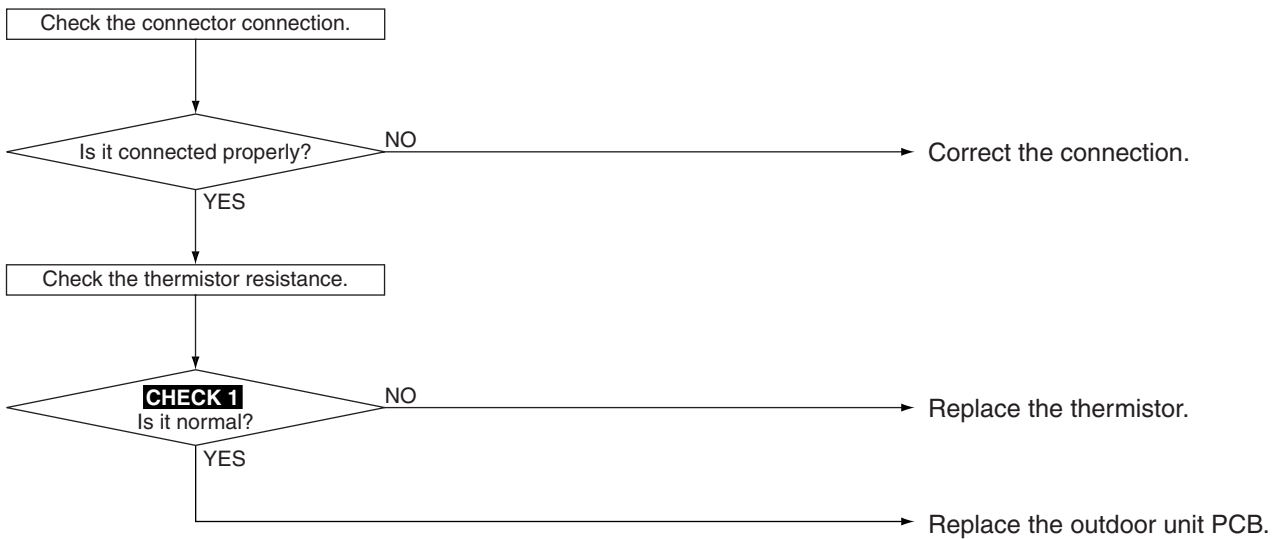

Error Code	Defective Thermistor	Symbol
U4	Heat exchanger thermistor	R2T
U5	Intermediate heat exchanger thermistor	R3T
U9	Suction air thermistor	R1T



CHECK 1 Refer to P.165.

4.10 Humidity Sensor System Abnormality

Remote Controller Display	
Applicable Models	FCQG
Method of Error Detection	Even if error occurs, operation still continue. The error is detected by humidity (output voltage) detected by humidity sensor.
Error Decision Conditions	The error is generated when the humidity sensor becomes disconnected or shorted when the unit is running.
Supposed Causes	<ul style="list-style-type: none"> ■ Defective sensor ■ Broken wire ■ External factor (Noise, etc.)

Troubleshooting



Caution Be sure to turn off power switch before connect or disconnect connector, or parts damage may be occurred.

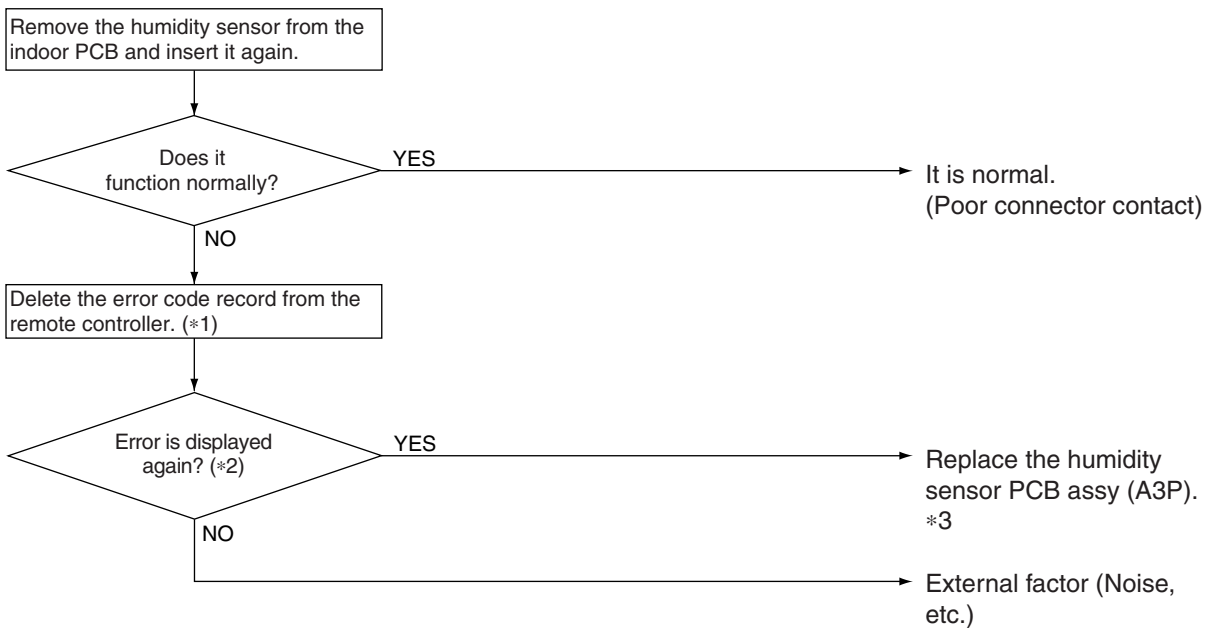

Note:

- *1 To delete the record, the ON/OFF button of the remote controller must be pushed and held for 5 seconds in the check mode.
- *2 To display the code, the Inspection/Test Operation button of the remote controller must be pushed and held in the normal mode.
- *3 If "E1" is displayed even after replacing the humidity sensor PCB assy (A3P) and taking the steps *1 and 2, replace the indoor PCB assy (A1P).

4.11 Remote Controller Thermistor Abnormality

Remote Controller Display	
Applicable Models	All models of indoor unit
Method of Error Detection	Even if remote controller thermistor is faulty, system is possible to operate by indoor unit suction air thermistor. The error is detected by temperature of remote controller thermistor.
Error Decision Conditions	The error is generated when the remote controller thermistor becomes disconnected or shorted when the unit is running. Even if the remote controller thermistor is error, the system can operate with the system thermistor.
Supposed Causes	<ul style="list-style-type: none"> ■ Defective thermistor ■ Broken wire ■ External factor (Noise, etc.)

Troubleshooting



Caution Be sure to turn off power switch before connect or disconnect connector, or parts damage may be occurred.

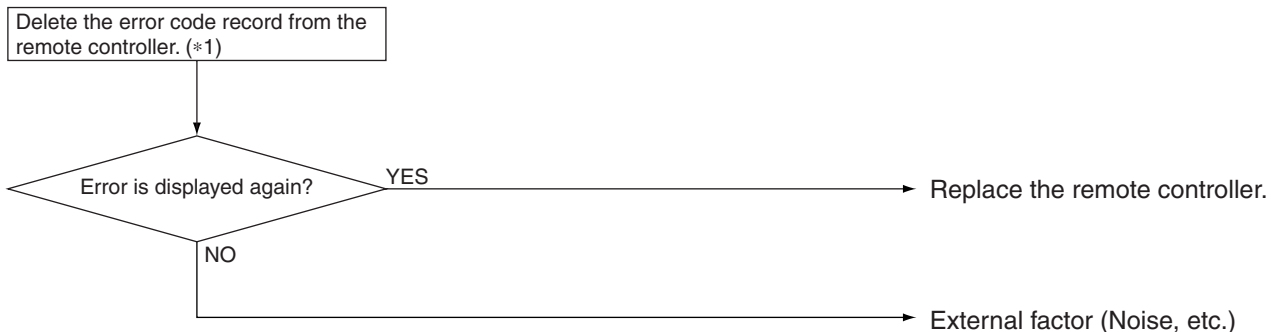

Note:

*1: To delete the record, the ON/OFF button of the remote controller must be pressed for 5 seconds in the check mode.

4.12 Outdoor Unit PCB Abnormality

Remote Controller Display	E1
Applicable Models	RZQG
Method of Error Detection	Micro-computer checks whether E ² PROM is normal.
Error Decision Conditions	When E ² PROM error when turning the power supply ON
Supposed Causes	<ul style="list-style-type: none"> ■ Defective outdoor unit PCB (A1P) ■ Defective fan motor ■ External factor (Noise, etc.)

Troubleshooting



Caution Be sure to turn off power switch before connect or disconnect connector, or parts damage may be occurred.

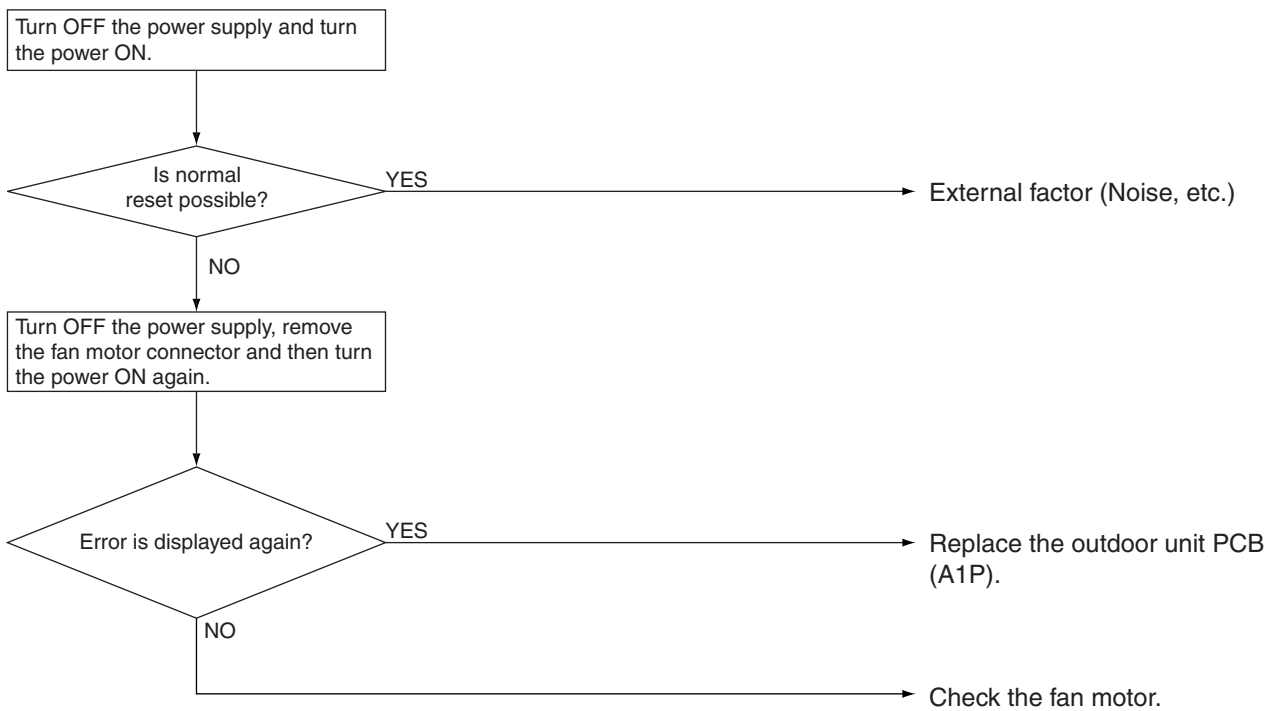

4.13 High Pressure Abnormality (Detected by the High Pressure Switch)

4.13.1 RZQG71, 100

Remote Controller Display	
Applicable Models	RZQG71, 100
Method of Error Detection	<p>[In cooling]</p> <ul style="list-style-type: none"> The error is detected by the outdoor unit intermediate heat exchanger thermistor (R5T). <p>[In heating]</p> <ul style="list-style-type: none"> The error is detected by the indoor unit intermediate heat exchanger thermistor (R3T).
Error Decision Conditions	<p>[In cooling]</p> <ul style="list-style-type: none"> When the outdoor unit intermediate thermistor (R5T) detects the pressure shown below. 3.92 MPa or more continuously for one minute (Reference: equivalent saturation temperature 62°C) <p>[In heating]</p> <ul style="list-style-type: none"> When the indoor unit intermediate thermistor (R3T) detects the pressure shown below. 3.92 MPa or more continuously for one minute (Reference: equivalent saturation temperature 62°C)
Supposed Causes	<ul style="list-style-type: none"> Dirt and blockage of the outdoor unit heat exchanger Defective outdoor unit fan motor Defective indoor unit fan motor Defective electronic expansion valve Overcharge of refrigerant Defective indoor unit PCB Defective outdoor inverter unit PCB

Troubleshooting



Caution Be sure to turn off power switch before connect or disconnect connector, or parts damage may be occurred.

[In cooling]

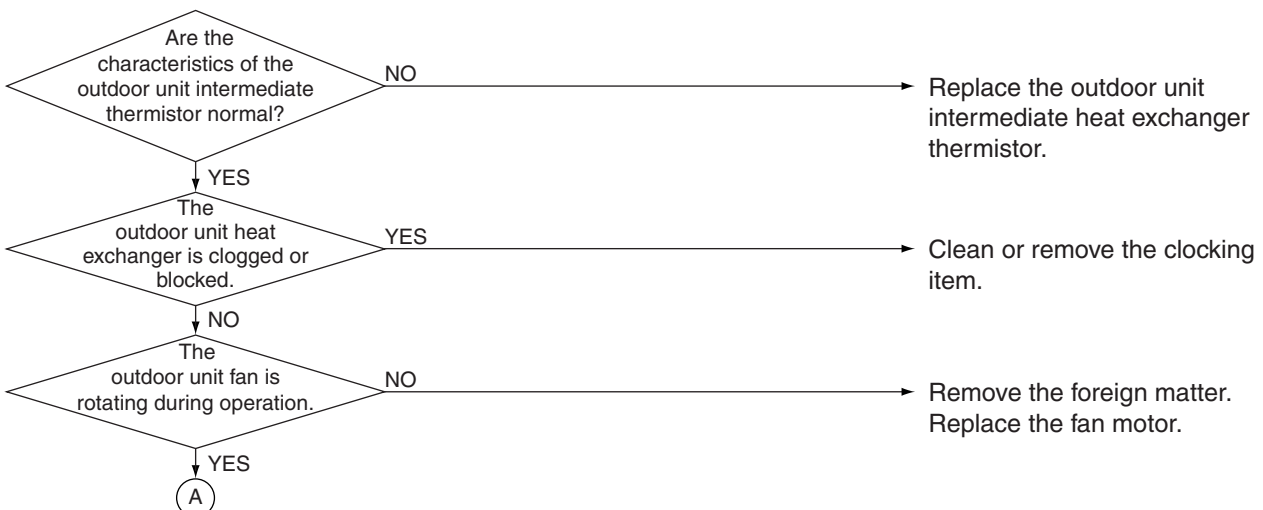

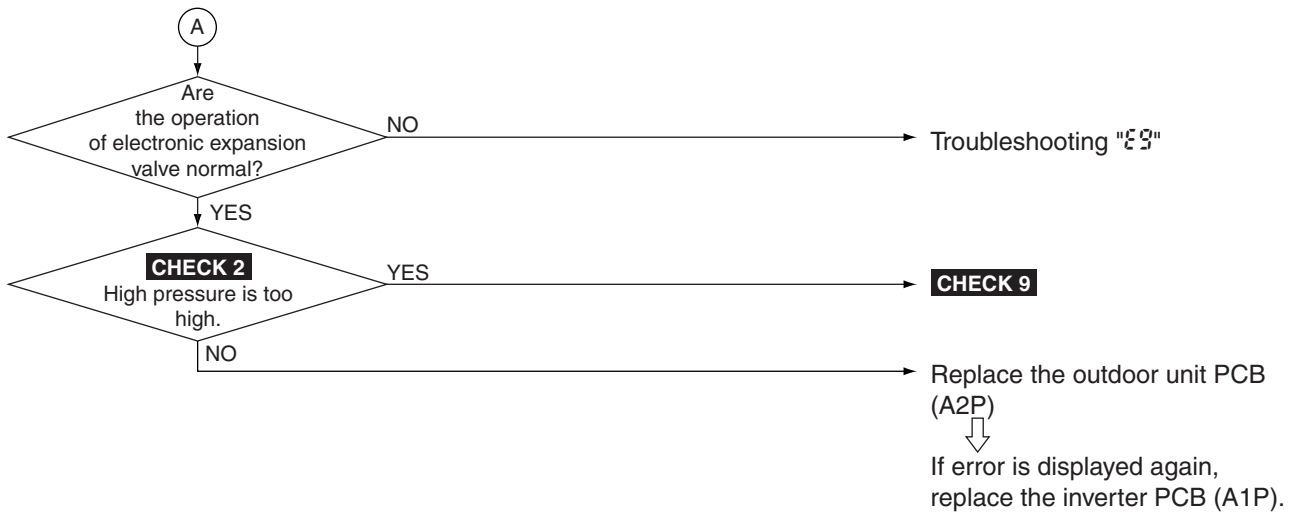

[In heating]

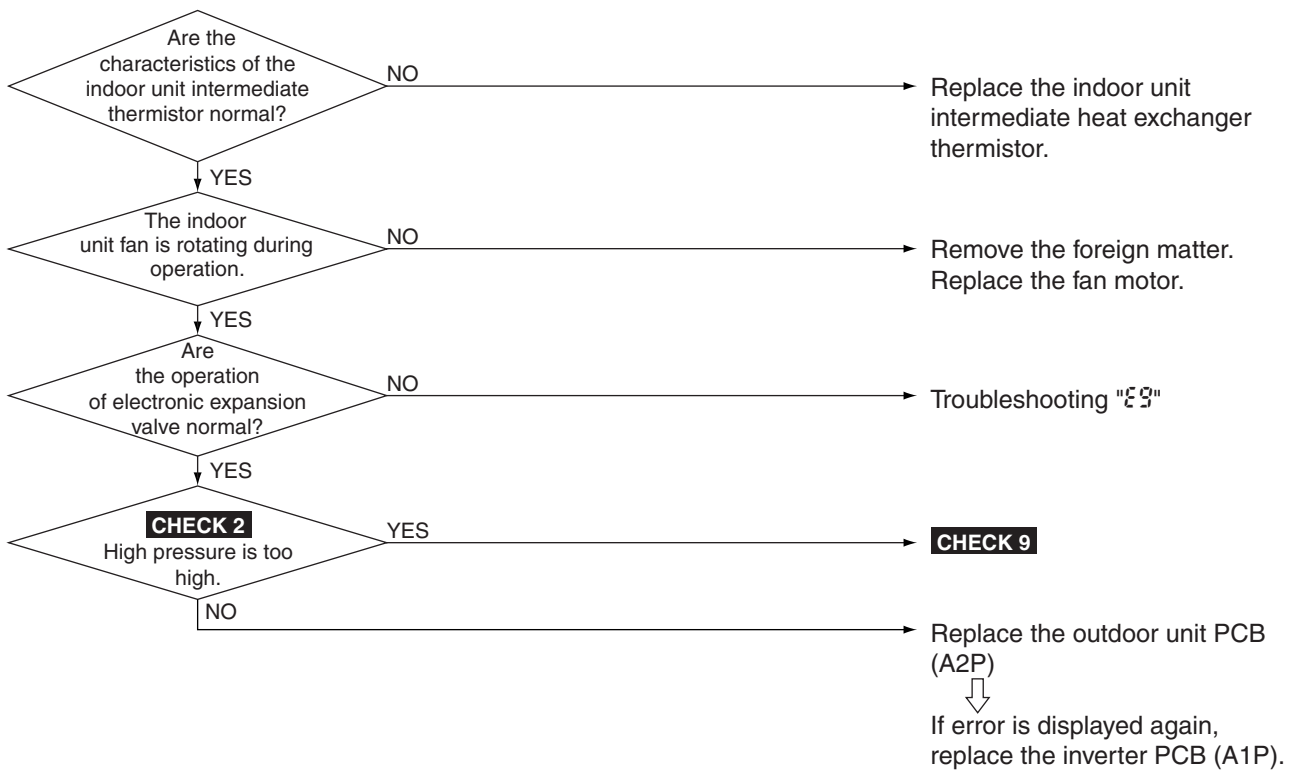

CHECK 2 Refer to P.168.

CHECK 9 Refer to P.174.

4.13.2 RZQG125, 140

Remote Controller Display	
Applicable Models	RZQG125, 140
Method of Error Detection	<p>[In cooling]</p> <ul style="list-style-type: none"> ■ Detect the continuity of high pressure switch (S1PH) with the protection device circuit. ■ The error is detected by the outdoor unit intermediate heat exchanger thermistor (R5T). <p>[In heating]</p> <ul style="list-style-type: none"> ■ Detect the continuity of high pressure switch (S1PH) with the protection device circuit. ■ The error is detected by the indoor unit intermediate heat exchanger thermistor (R3T).
Error Decision Conditions	<ul style="list-style-type: none"> ■ When the high pressure switch is activated (4.0 MPa) ■ When the outdoor unit intermediate thermistor (R5T) detects the pressure shown below. 3.92 MPa or more continuously for one minute (Reference: equivalent saturation temperature 62°C) ■ When the indoor unit intermediate thermistor (R3T) detects the pressure shown below. 3.92 MPa or more continuously for one minute (Reference: equivalent saturation temperature 62°C)
Supposed Causes	<ul style="list-style-type: none"> ■ Stop valve is not opened ■ Harness breaking or poor connector connection of the high pressure switch ■ Defective high pressure switch ■ Indoor unit suction filter is blocked (In heating) ■ Defective high pressure switch ■ Defective indoor unit fan (In heating) ■ Outdoor heat exchanger is dirt (In cooling) ■ Defective outdoor unit fan (In cooling) ■ Overcharge of refrigerant ■ Defective outdoor unit PCB (A2P) ■ Defective outdoor unit PCB (A1P)

Troubleshooting



Caution Be sure to turn off power switch before connect or disconnect connector, or parts damage may be occurred.

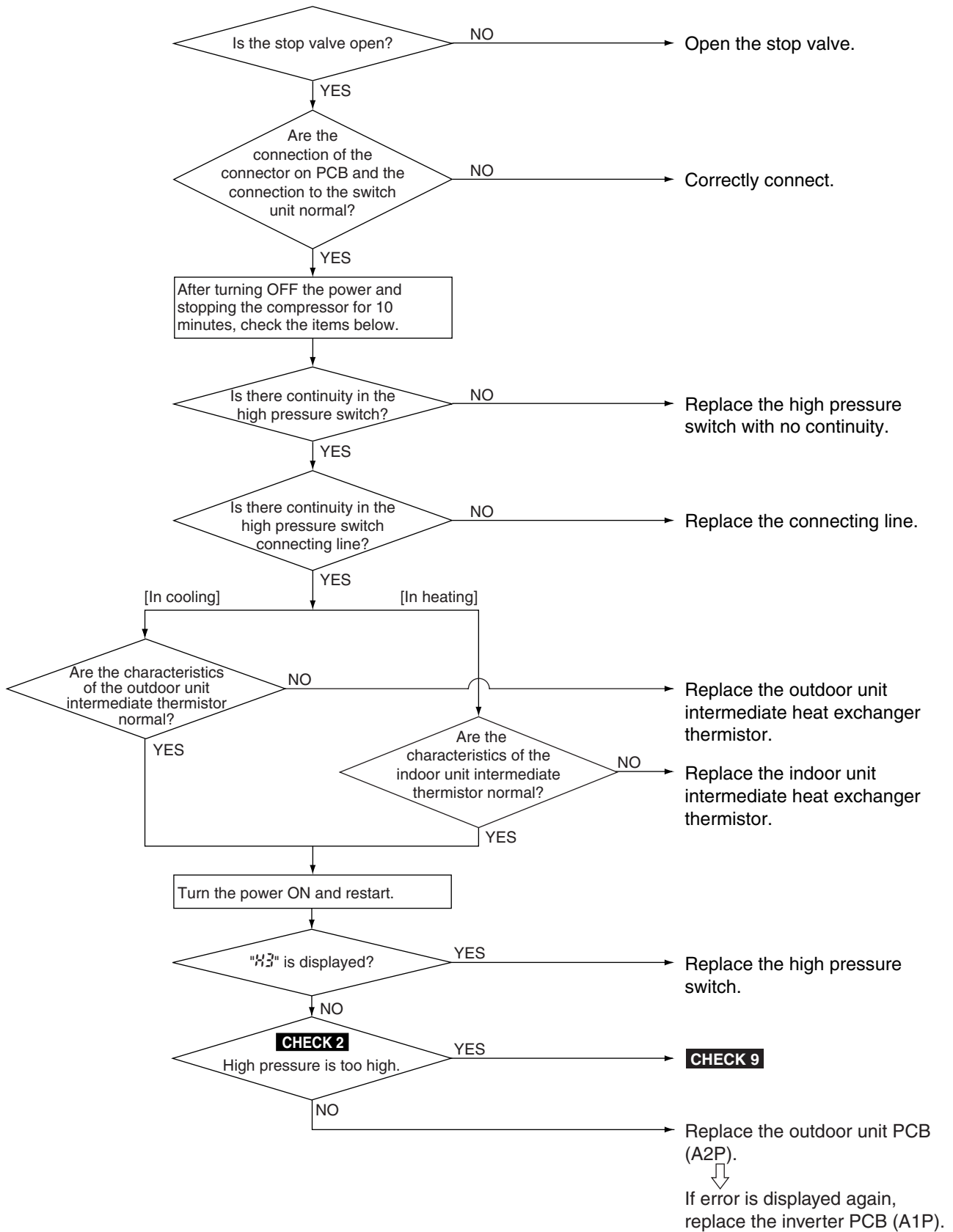

CHECK 2 Refer to P.168.

CHECK 9 Refer to P.174.

4.14 Actuation of Pressure Sensor

Remote Controller Display	E4
Applicable Models	RZQG
Method of Error Detection	<p>[In cooling]</p> <ul style="list-style-type: none"> ■ Detect error by the indoor unit intermediate thermistor (R3T). <p>[In heating]</p> <ul style="list-style-type: none"> ■ Detect error by the intermediate heat exchanger thermistor (R5T).
Error Decision Conditions	<p>[In cooling]</p> <ul style="list-style-type: none"> ■ When the detection pressure is the following value 0.12MPa or less continues for 5 minutes ■ When the saturated pressure equivalent temperature is -34°C
Supposed Causes	<ul style="list-style-type: none"> ■ The stop valve is not opened ■ Disconnection of outdoor unit intermediate thermistor ■ Disconnection of indoor unit intermediate thermistor ■ Defective thermistor ■ Defective outdoor unit PCB (A1P) ■ Abnormal drop of low pressure

Troubleshooting



Caution Be sure to turn off power switch before connect or disconnect connector, or parts damage may be occurred.

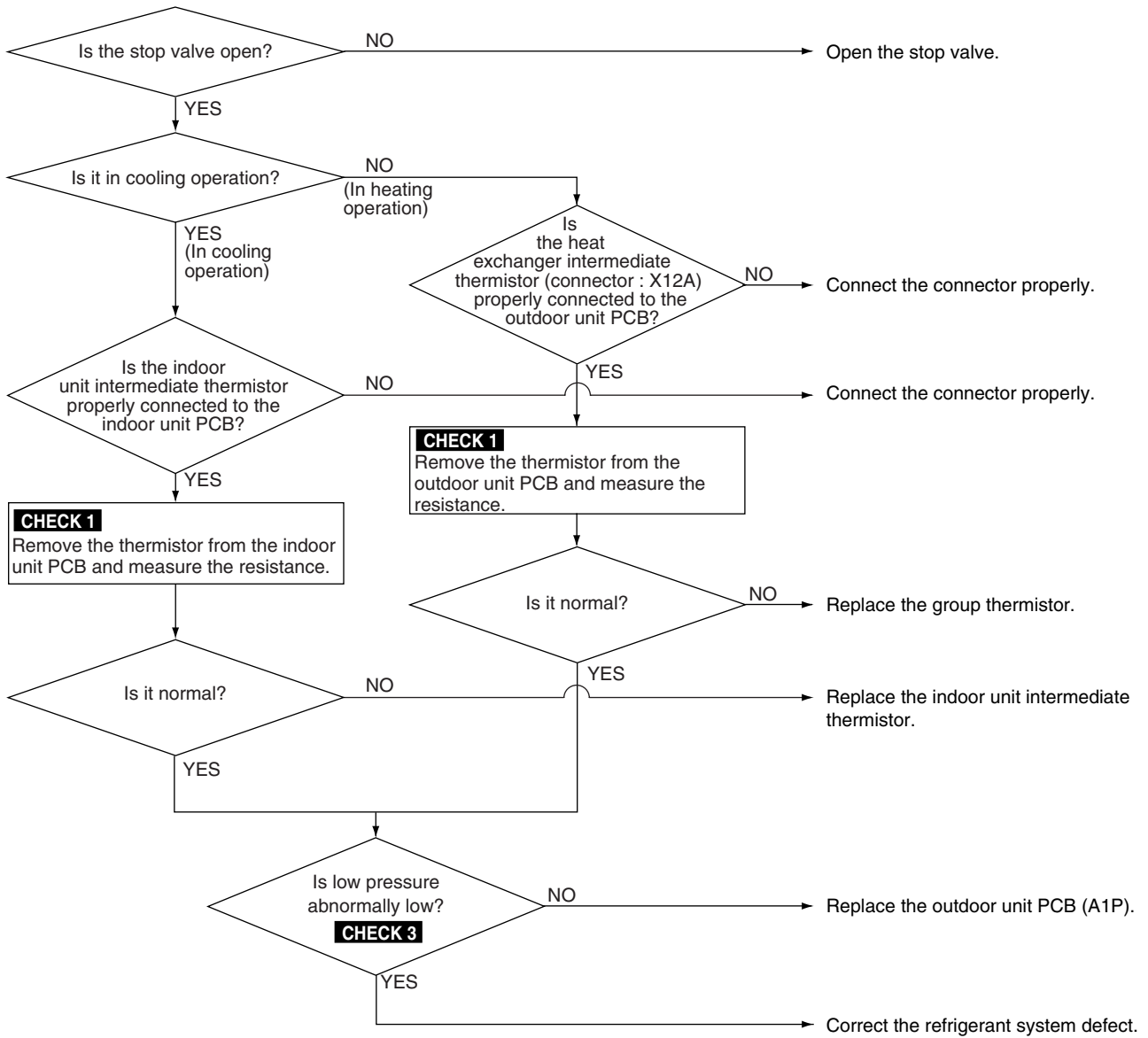

CHECK 1 Refer to P.165.

CHECK 3 Refer to P.169.

4.15 Compressor Motor Lock

Remote Controller Display	E5
Applicable Models	RZQG
Method of Error Detection	Detect the motor lock when the compressor is energized.
Error Decision Conditions	If the motor rotor does not rotate when the compressor is energized.
Supposed Causes	<ul style="list-style-type: none"> ■ Compressor lock ■ High differential pressure (2.6 MPa or more) starting ■ Stop valve is not opened

Troubleshooting



Caution Be sure to turn off power switch before connect or disconnect connector, or parts damage may be occurred.

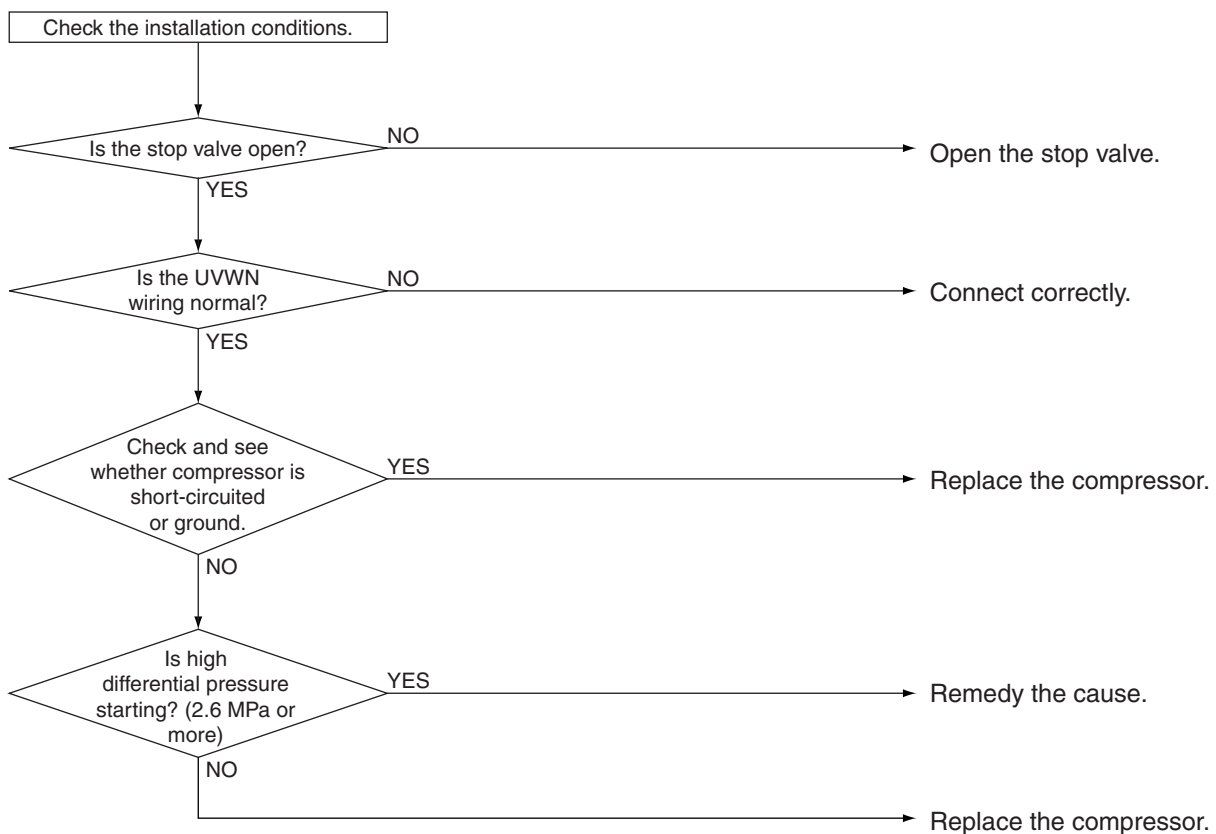

4.16 Outdoor Unit Fan Motor Abnormality

Remote Controller Display	E7
Applicable Models	RZQG
Method of Error Detection	Abnormality of fan motor system is detected according to the fan speed detected by hall IC when the fan motor runs.
Error Decision Conditions	<ul style="list-style-type: none"> ■ When the fan runs with speed less than a specified one for 15 seconds or more when the fan motor running conditions are met ■ When connector detecting fan speed is disconnected ■ When the error is generated 4 times, the system shuts down.
Supposed Causes	<ul style="list-style-type: none"> ■ Defective fan motor ■ The harness connector between fan motor and PCB is left in disconnected, or faulty connector ■ Fan does not run due to foreign matters tangled ■ Defective the outdoor PCB ■ Blowout of fuse ■ External factor (Noise, etc.)

Troubleshooting



Caution Be sure to turn off power switch before connect or disconnect connector, or parts damage may be occurred.



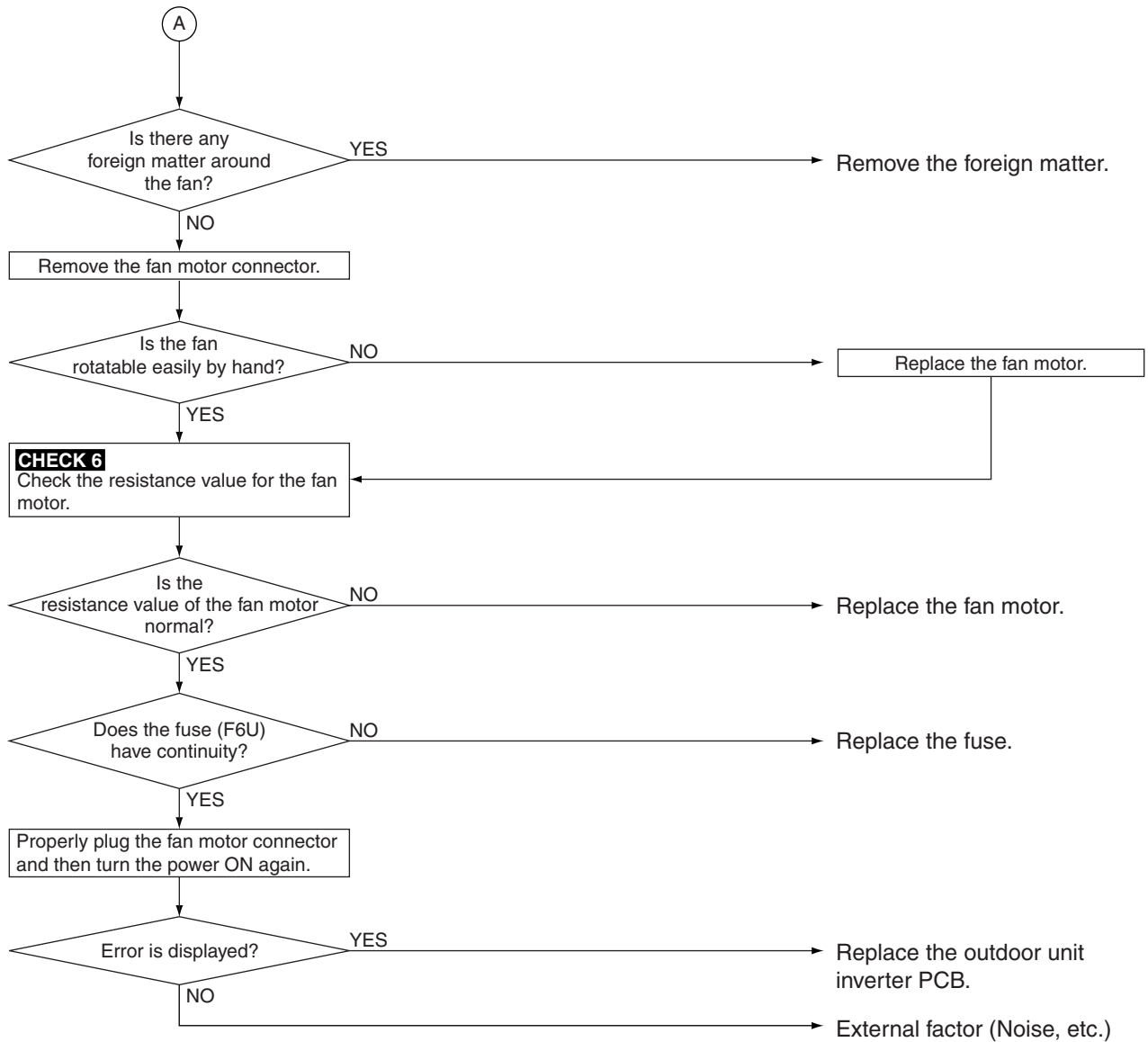

CHECK 6 Refer to P.172.

4.17 Electronic Expansion Valve Abnormality

Remote Controller Display	E9
Applicable Models	RZQG
Method of Error Detection	<ul style="list-style-type: none"> ■ The error is detected whether the continuity of electronic expansion valve exist or not. ■ The error is detected by the suction pipe superheat degree, discharge pipe superheat degree and electronic expansion valve opening degree.
Error Decision Conditions	<ul style="list-style-type: none"> ■ No common power supply when the power is ON. ■ When the following conditions are met <ul style="list-style-type: none"> • Suction pipe superheat degree < 4°C • Minimum electronic expansion valve opening degree • Discharge pipe superheat degree < 5°C
Supposed Causes	<ul style="list-style-type: none"> ■ Defective electronic expansion valve ■ Disconnection of electronic expansion valve harness ■ Defective connection of electronic expansion valve connector ■ Defective each thermistor and mounting thermistor ■ Defective pressure sensor ■ Defective outdoor unit PCB ■ Abnormal wet operation

Troubleshooting



Caution Be sure to turn off power switch before connect or disconnect connector, or parts damage may be occurred.

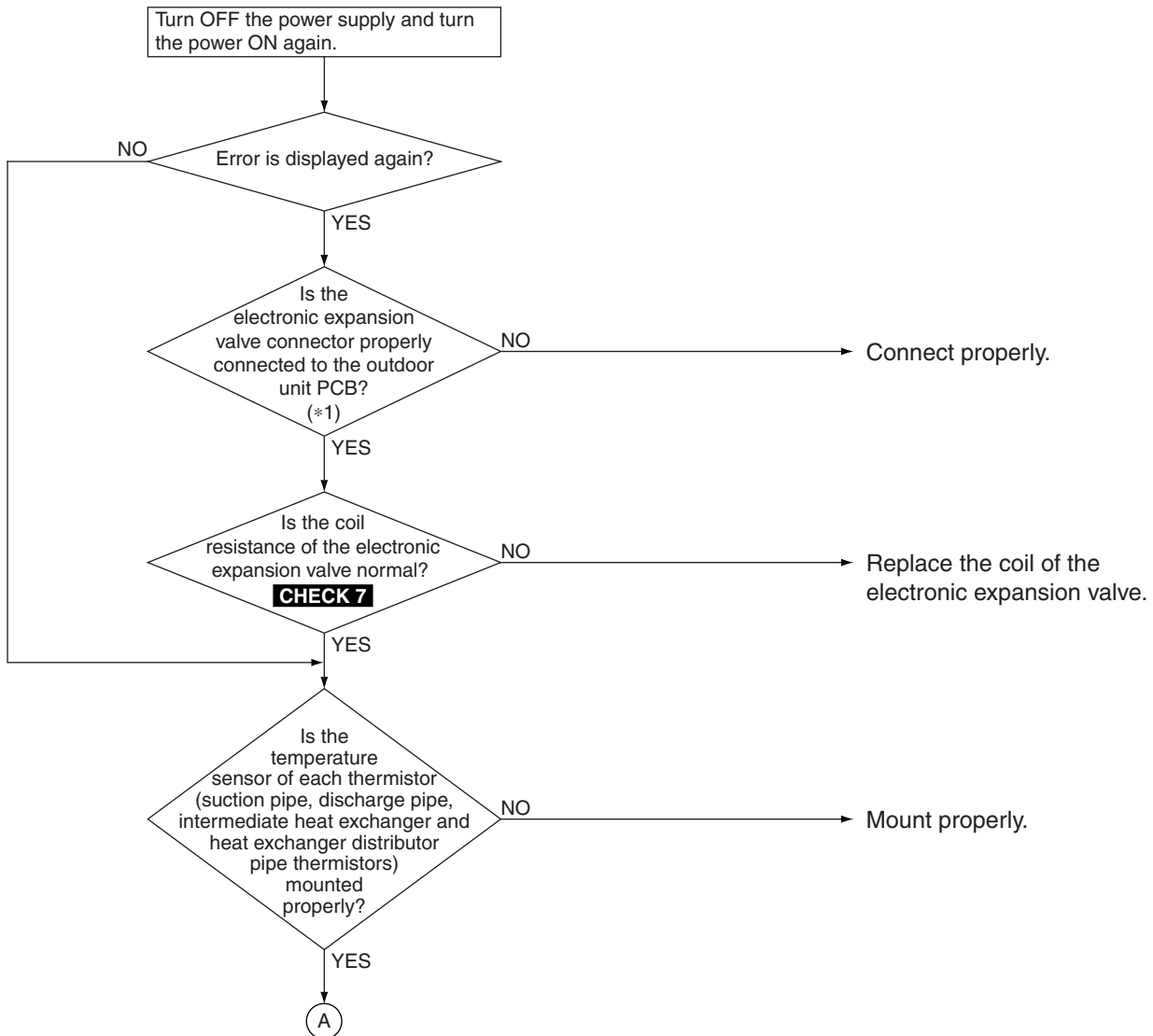

Note:

*1 Connector and indoor unit PCB

Model	Connector for electronic expansion valve	PCB
RZQG	X21A	A1P



CHECK 7 Refer to P.172.

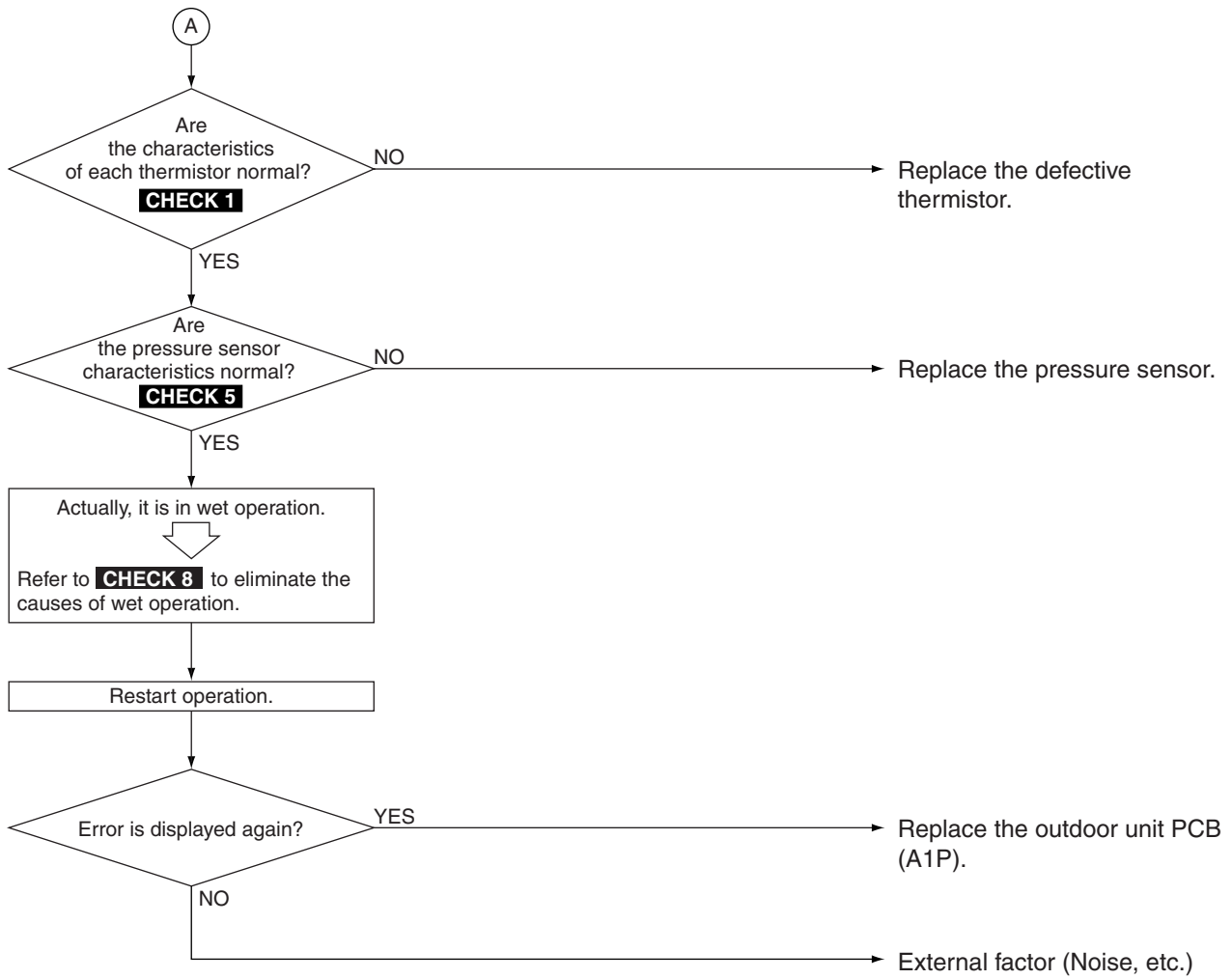

CHECK 1 Refer to P.165.

CHECK 5 Refer to P.171.

CHECK 8 Refer to P.173.

4.18 Discharge Pipe Temperature Control

Remote Controller Display	
Applicable Models	RZQG
Method of Error Detection	The error is detected according to the temperature detected by the discharge pipe temperature sensor.
Error Decision Conditions	<ul style="list-style-type: none">■ When the discharge pipe temperature rises to an abnormally high level■ When the discharge pipe temperature rises suddenly■ When the discharge pipe temperature does not rise after operation start
Supposed Causes	<ul style="list-style-type: none">■ Defective discharge pipe thermistor■ Defective connection of discharge pipe thermistor■ Refrigerant shortage■ Defective compressor■ Disconnection of discharge pipe thermistor■ Defective outdoor unit PCB

Troubleshooting



Caution Be sure to turn off power switch before connect or disconnect connector, or parts damage may be occurred.

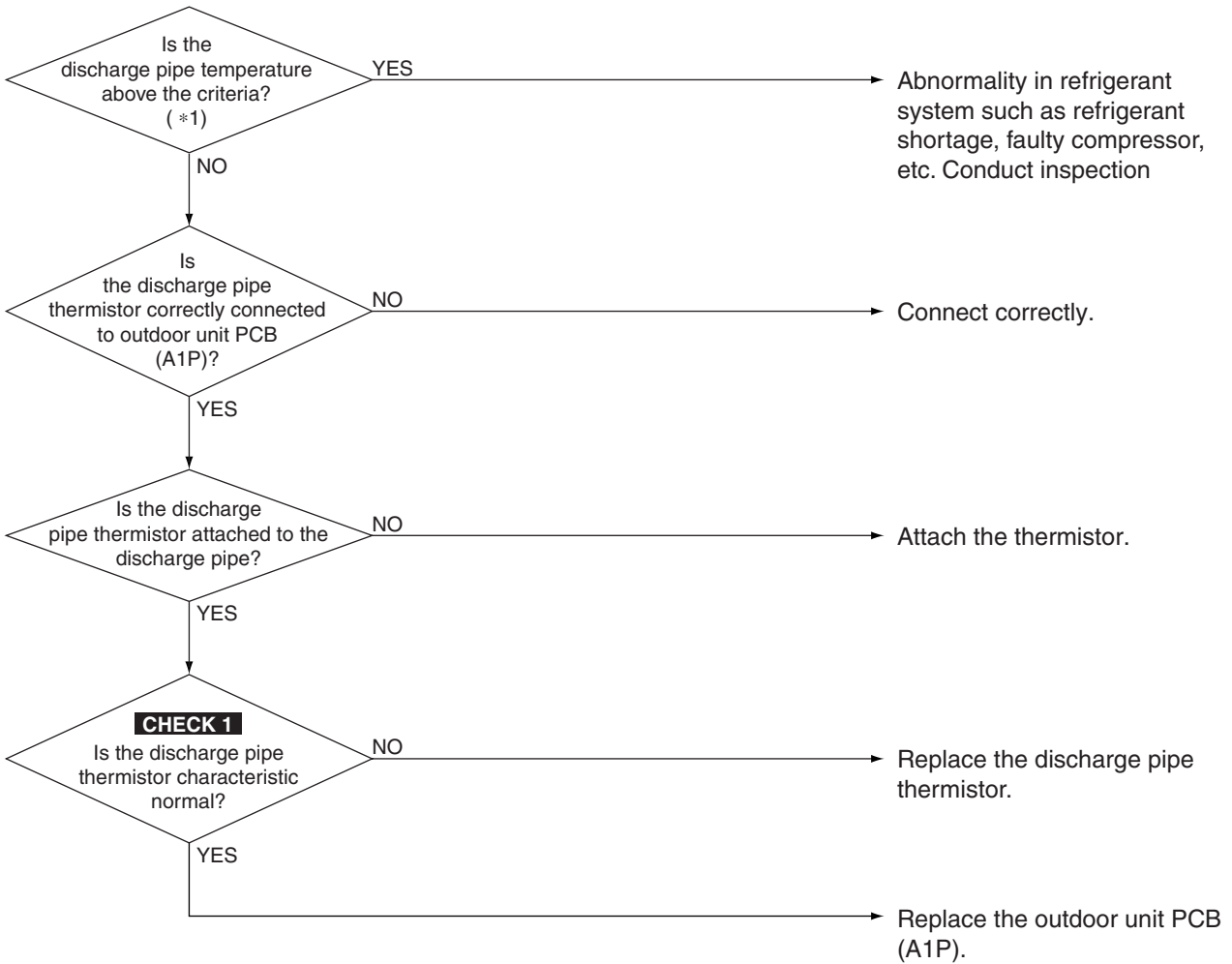

Note:

*1 Temperature varies depending on model type.

Model	Temperature
RZQG71	110 °C
RZQG100-140	115 °C



CHECK 1 Refer to P.165.

4.19 High Pressure Switch System Abnormality

Remote Controller Display	43
Applicable Models	RZQG125, 140
Method of Error Detection	The protection device circuit checks continuity in the high pressure switch (S1PH).
Error Decision Conditions	When there is no continuity in the high pressure switch during compressor stops operating.
Supposed Causes	<ul style="list-style-type: none"> ■ Incomplete high pressure switch ■ Defective connection of high pressure switch connector ■ Defective outdoor unit PCB ■ Disconnected lead wire

Troubleshooting



Caution Be sure to turn off power switch before connect or disconnect connector, or parts damage may be occurred.

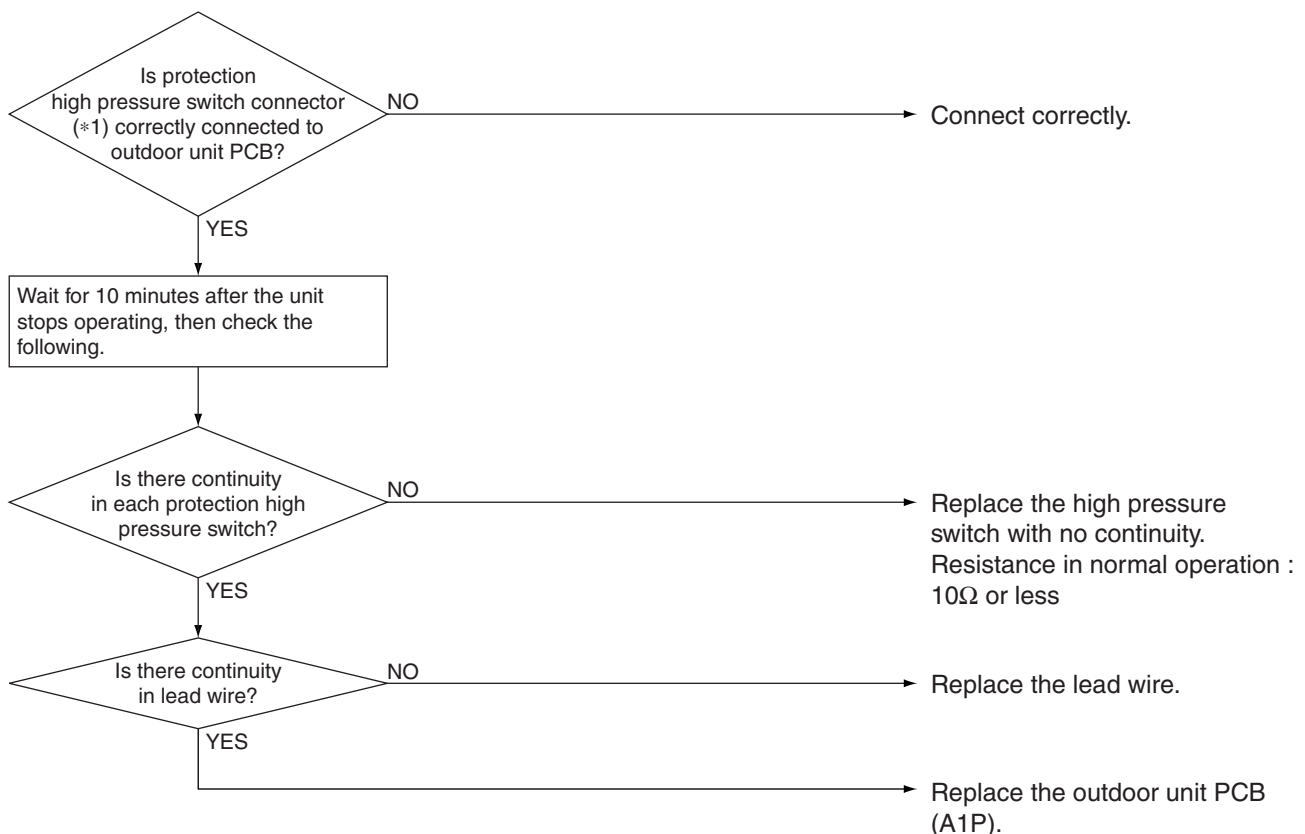

Note:

*1 Connector and indoor unit PCB

Model	Connector for high pressure switch	PCB
RZQG	X32A	A1P

4.20 Thermistor System Abnormality

Remote Controller Display	H9, U3, U5, U6, U7, U8
Applicable Models	RZQG
Method of Error Detection	The error is detected according to the temperature detected by each individual thermistor.
Error Decision Conditions	When thermistor is disconnected or short circuited during operation
Supposed Causes	<ul style="list-style-type: none"> ■ Defective thermistor ■ Defective connection of connector ■ Defective outdoor unit PCB (A1P)

Troubleshooting



Caution Be sure to turn off power switch before connect or disconnect connector, or parts damage may be occurred.

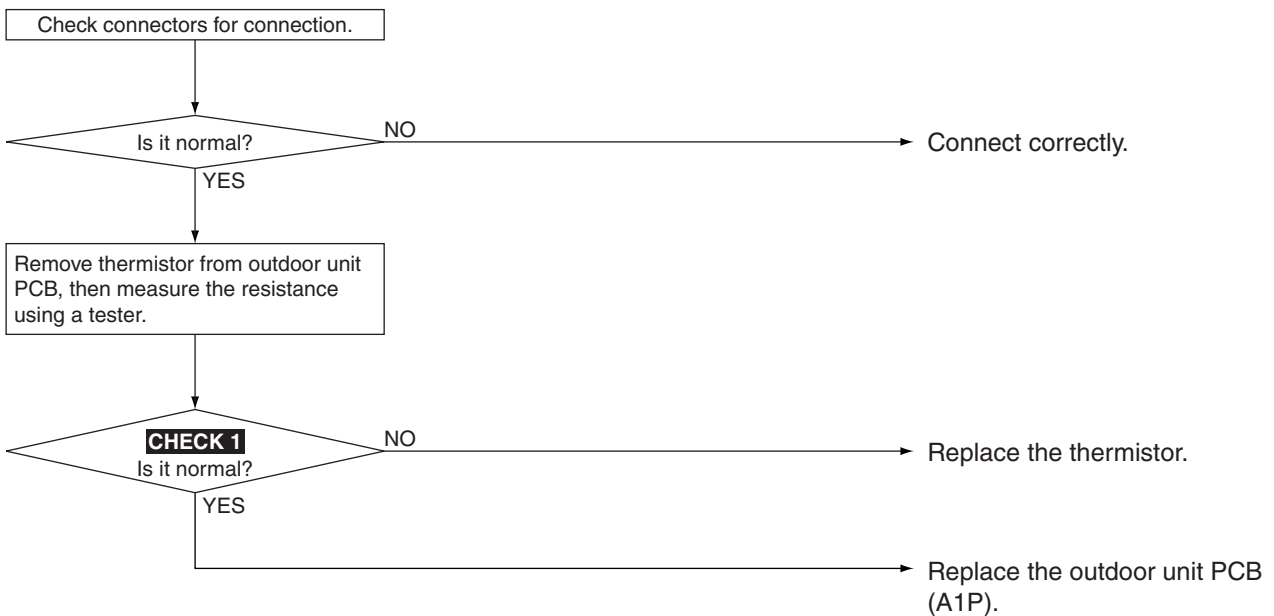

Error Code	Defective Thermistor	Symbol
H9	Outdoor air thermistor	R1T
U3	Discharge pipe thermistor	R2T
U5	Suction pipe thermistor	R3T
U6	Heat exchanger thermistor	R4T
U7	Intermediate heat exchanger thermistor	R5T
U8	Liquid pipe thermistor	R6T



CHECK 1 Refer to P.165.

4.21 Outdoor Unit PCB Abnormality

Remote Controller Display	L I
Applicable Models	RZQG
Method of Error Detection	<ul style="list-style-type: none"> ■ Detect error by current value during waveform output before compressor startup. ■ Detect error by current sensor value during synchronized operation at the time of startup. ■ Detect error using an MP-PAM series capacitor overvoltage sensor.
Error Decision Conditions	<ul style="list-style-type: none"> ■ When over-current is detected at the time of waveform output during operating the compressor ■ When the current sensor error during synchronized operation ■ When overvoltage occurs in MP-PAM ■ In case of IGBT error ■ In case of faulty in E²PROM
Supposed Causes	<ul style="list-style-type: none"> ■ External factor (Noise, etc.) ■ Defective outdoor unit fan motor ■ Broken fuse ■ Disconnection of compressor ■ Defective outdoor unit PCB (A1P) <ul style="list-style-type: none"> • IPM failure • Current sensor failure • MP-PAM failure • Defective IGBT or drive circuit • Defective inverter E²PROM

Troubleshooting



Caution Be sure to turn off power switch before connect or disconnect connector, or parts damage may be occurred.

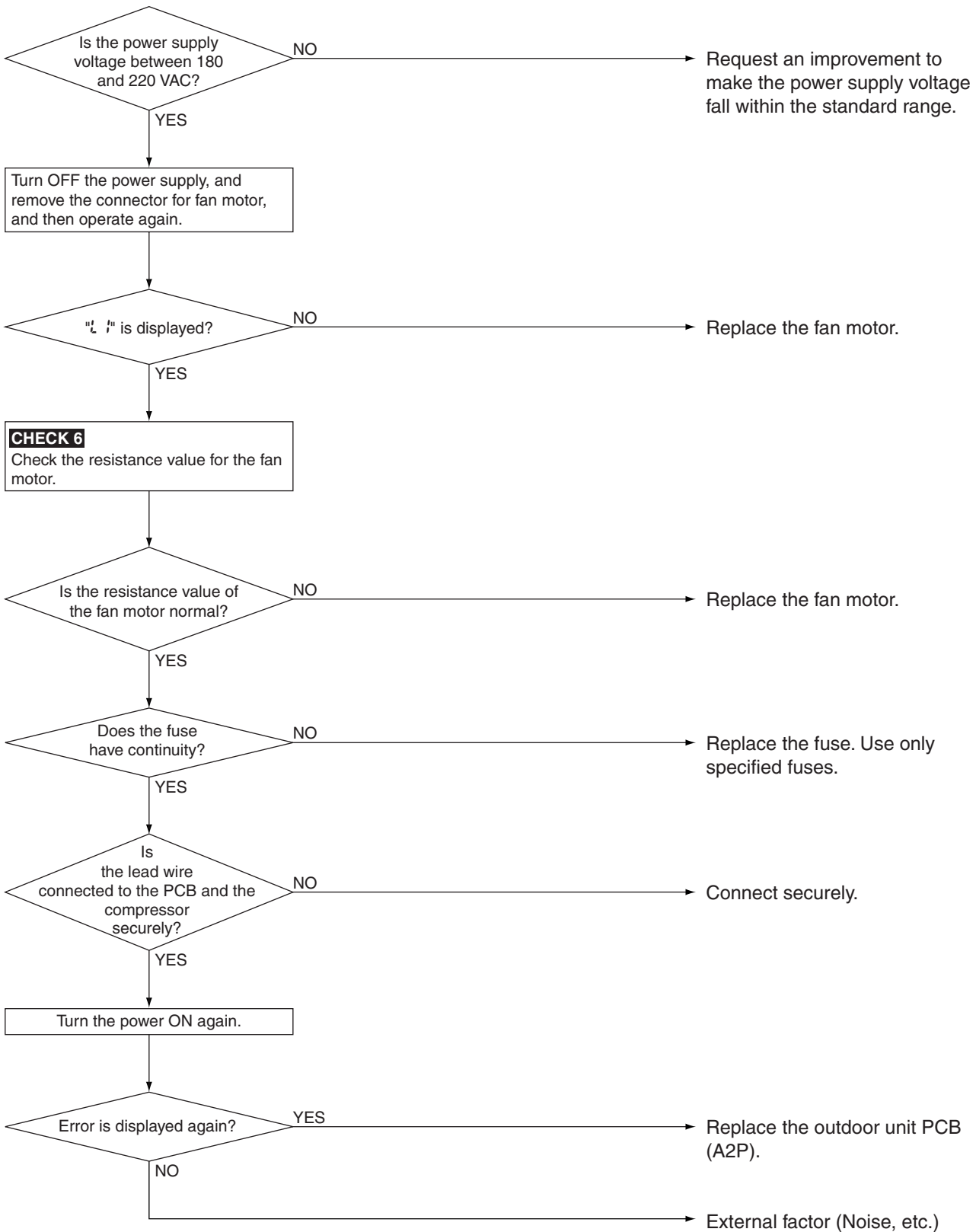

CHECK 6 Refer to P.172.

4.22 Radiation Fin Temperature Rise

Remote
Controller
Display

L4

Applicable
Models

RZQG

Method of Error
Detection

Radiation fin temperature is detected by the radiation fin thermistor.

Error Decision
Conditions

When the temperature of the inverter radiation fin rises abnormally due to faulty heat dissipation.

Supposed
Causes

- Actuation of fin thermal switch
- Insufficient cooling of inverter radiation fin
- High outdoor air temperature
- Blocked suction inlet
- Blocked discharge outlet
- Dirty radiation fin
- Disconnection of connector
- Defective radiation fin thermistor
- Defective outdoor unit inverter PCB

Troubleshooting



Caution Be sure to turn off power switch before connect or disconnect connector, or parts damage may be occurred.

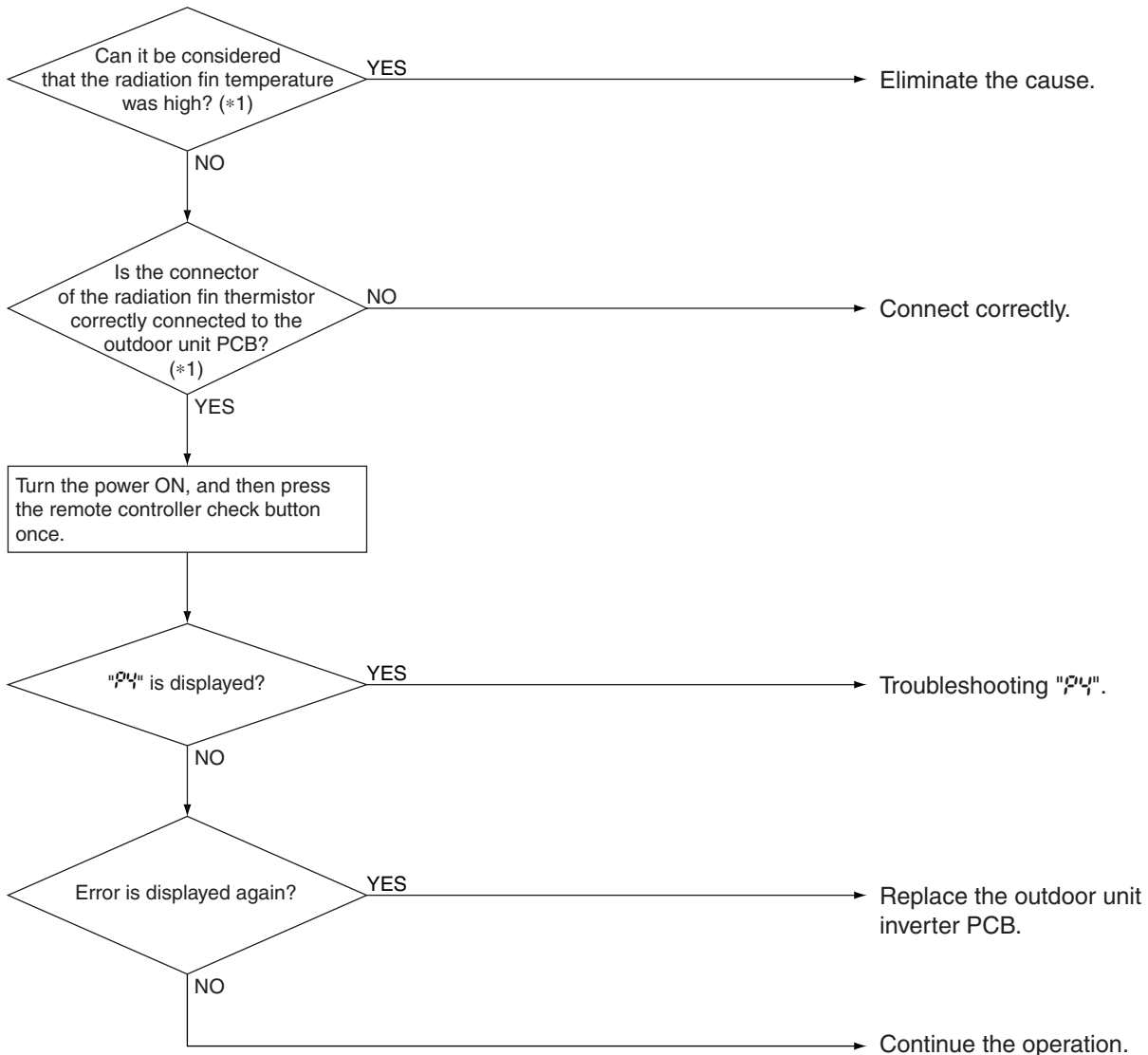

Note:

*1 Radiation fin temperature detection value

Model	Detection	Reset
RZQG71	85°C	75°C
RZQG100-140	89°C	79°C

4.23 Output Overcurrent Detection

Remote Controller Display	LS
Applicable Models	RZQG
Method of Error Detection	The error is detected by converting the current flowing to power transistor into voltage with CT1 (DC current sensor).
Error Decision Conditions	When overcurrent has run to power transistor. (Actuated even by instantaneous overcurrent)
Supposed Causes	<ul style="list-style-type: none"> ■ Defective compressor (mechanical lock, poor insulation) ■ Defective inverter PCB ■ Instantaneous fluctuation of power supply voltage ■ Defective compressor (if bearing is scratched) ■ Stop valve is not opened.

Troubleshooting



Caution Be sure to turn off power switch before connect or disconnect connector, or parts damage may be occurred.

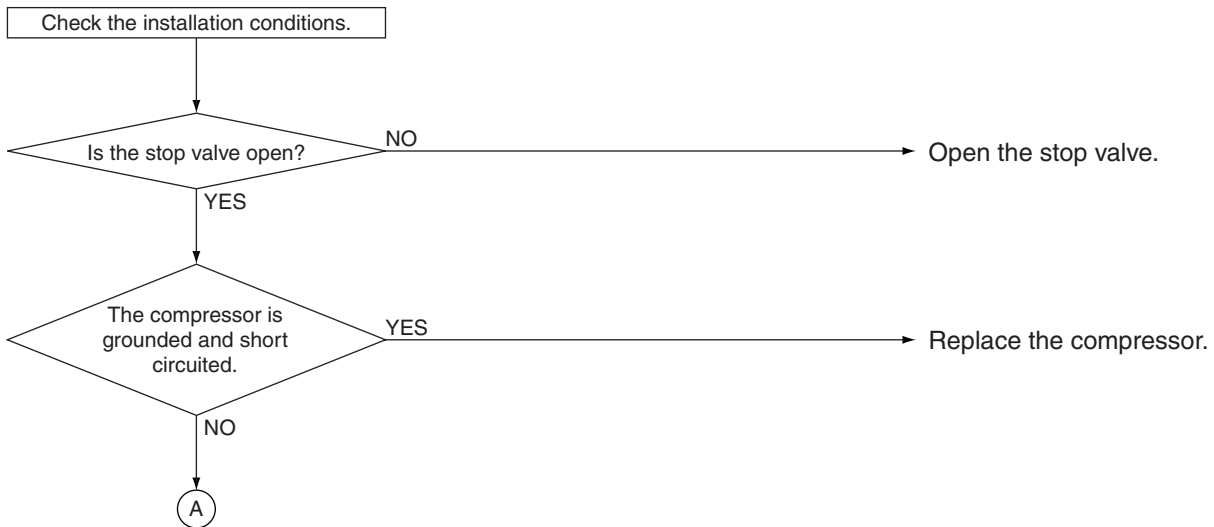

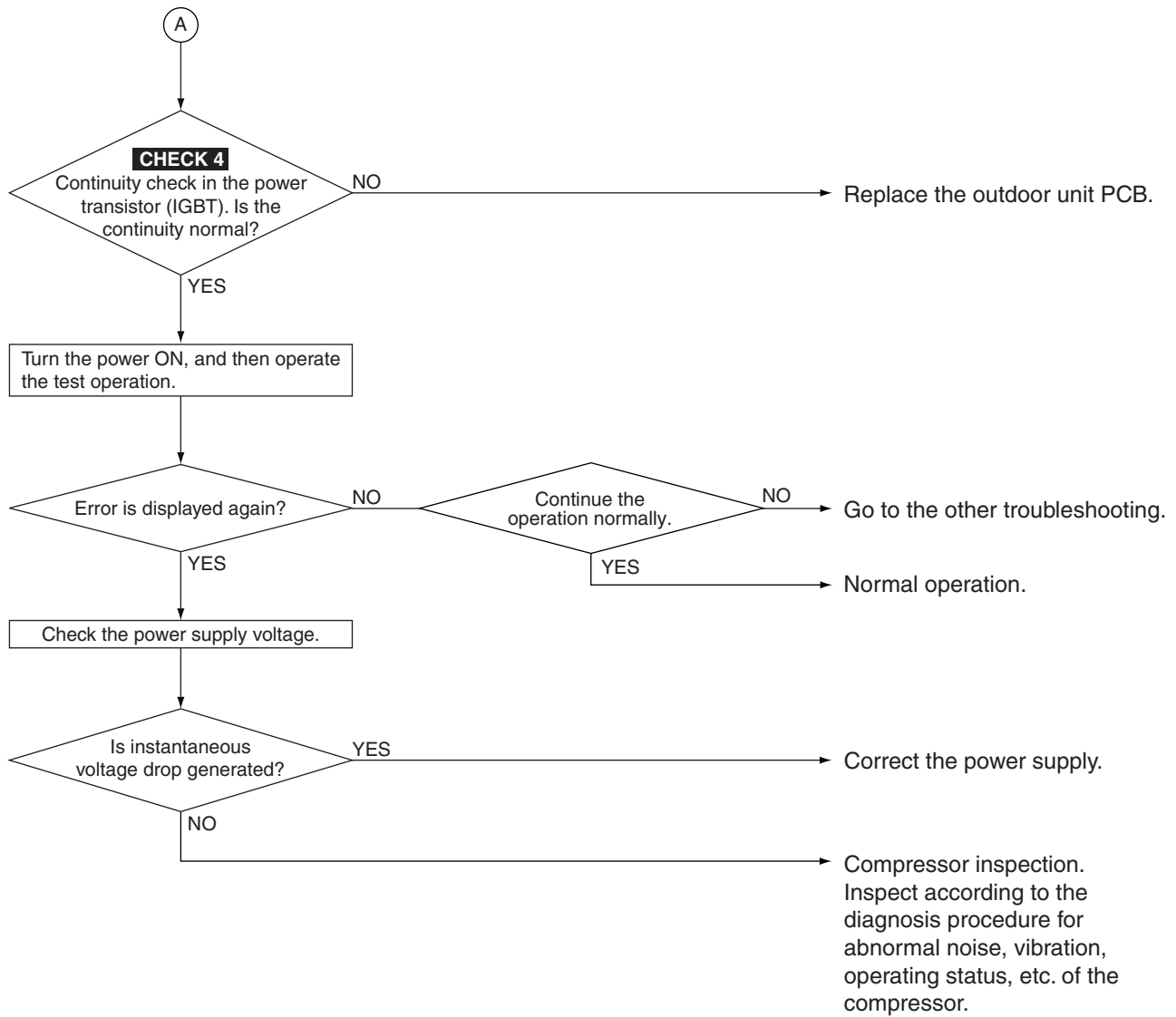

CHECK 4 Refer to P.170.

4.24 Electronic Thermal (Time Lag)

**Remote
Controller
Display**

L8

**Applicable
Models**

RZQG

**Method of Error
Detection**

The error is detected from the current flowing to power transistor into voltage with CT1 (DC current sensor).

**Error Decision
Conditions**

When compressor overload (except for when startup) is detected.

**Supposed
Causes**

- Disconnected compressor coil
- High pressure is abnormal high
- Defective compressor (if bearing is scratched)
- Defective outdoor unit PCB
- Stop valve is not opened

Troubleshooting



Caution Be sure to turn off power switch before connect or disconnect connector, or parts damage may be occurred.

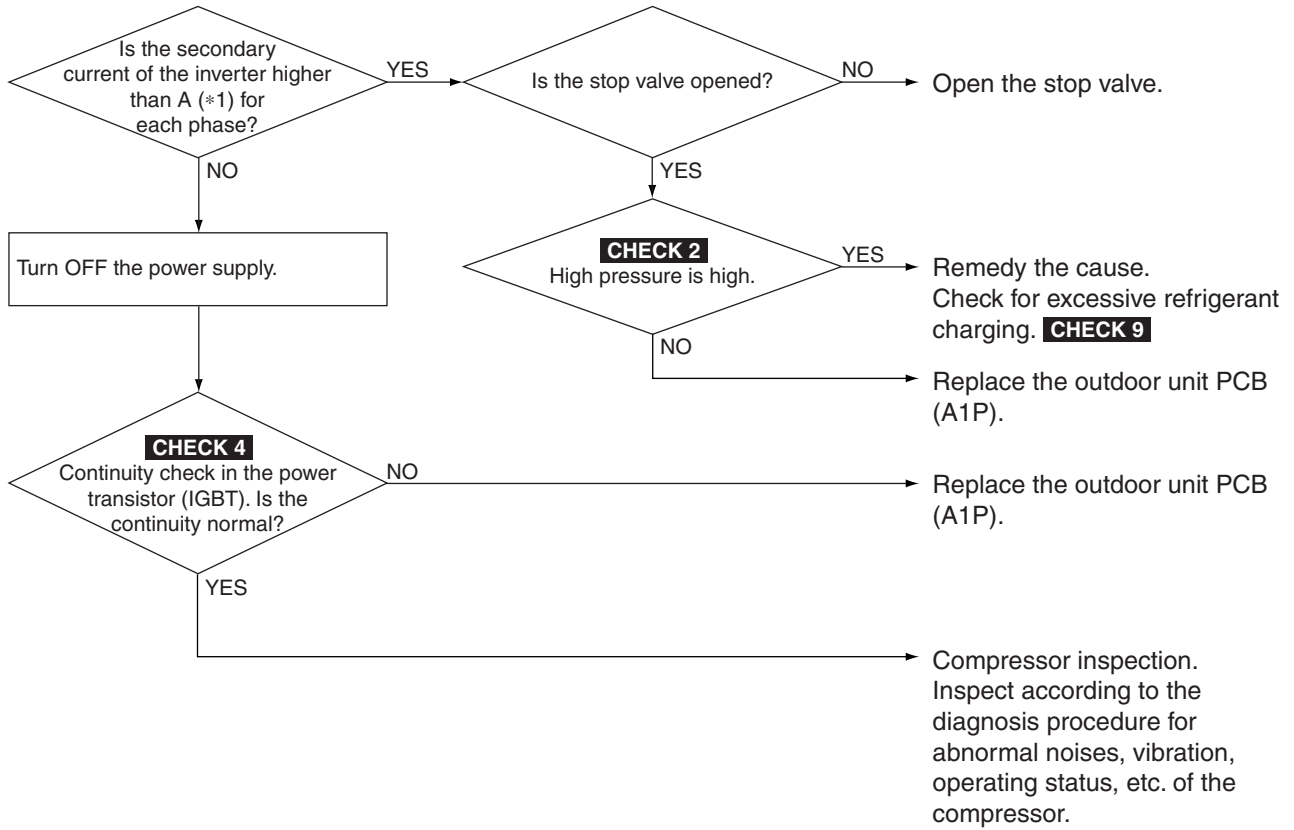

Note:

*1 Secondary electronic thermal detection value

Model		Detection value
RZQG71	Cooling	12.6 or 12.2A × 260 seconds
	Heating	14.8A × 260 seconds
RZQG100-140	Cooling	16.1A × 260 seconds
	Heating	22.1A × 260 seconds



CHECK 2 Refer to P.168.

CHECK 4 Refer to P.170.

CHECK 9 Refer to P.174.

4.25 Stall Prevention (Time Lag)

Remote Controller Display	L9
Applicable Models	RZQG
Method of Error Detection	The error is detected by converting the current flowing to power transistor into voltage with CT1 (DC current sensor). Inverter PCB detects the disorder of position signal.
Error Decision Conditions	When compressor overload and change of load are detected when startup
Supposed Causes	<ul style="list-style-type: none"> ■ Stop valve is not opened. ■ Pressure differential startup ■ Defective outdoor unit inverter PCB ■ Defective compressor (lock)

Troubleshooting



Caution Be sure to turn off power switch before connect or disconnect connector, or parts damage may be occurred.

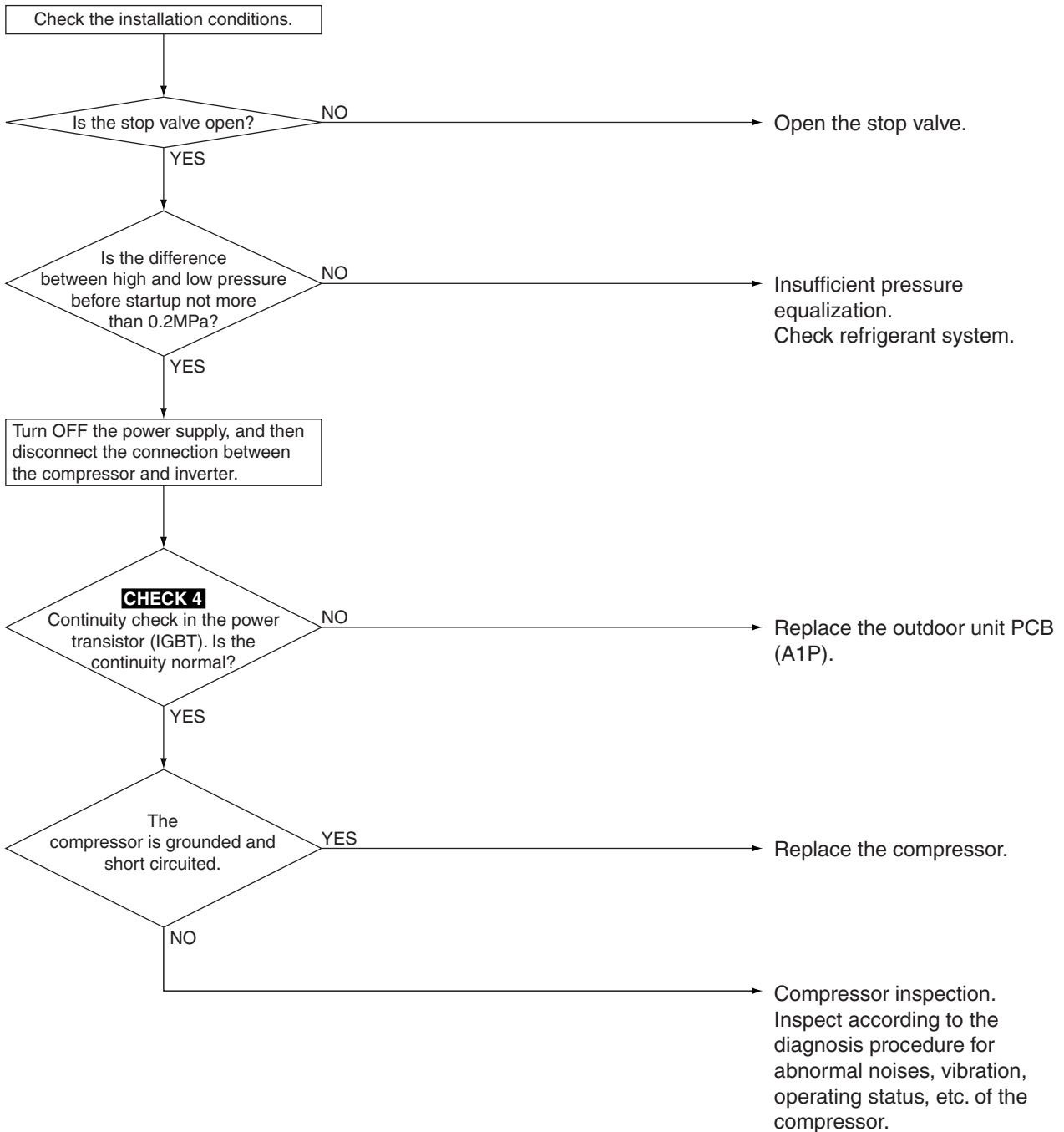

CHECK 4 Refer to P.170.

4.26 Transmission System Abnormality (between Control and Inverter PCB)

Remote
Controller
Display



Applicable
Models

RZQG

Method of Error
Detection

Check whether transmission between control and inverter PCB is carried out normally.

Error Decision
Conditions

When the transmission is not carried out in a specified period of time or longer

Supposed
Causes

- Defective outdoor fan motor
- Defective of fan motor connector contact
- Defective control and inverter PCB
- External factor (Noise, etc.)

Troubleshooting



Caution Be sure to turn off power switch before connect or disconnect connector, or parts damage may be occurred.

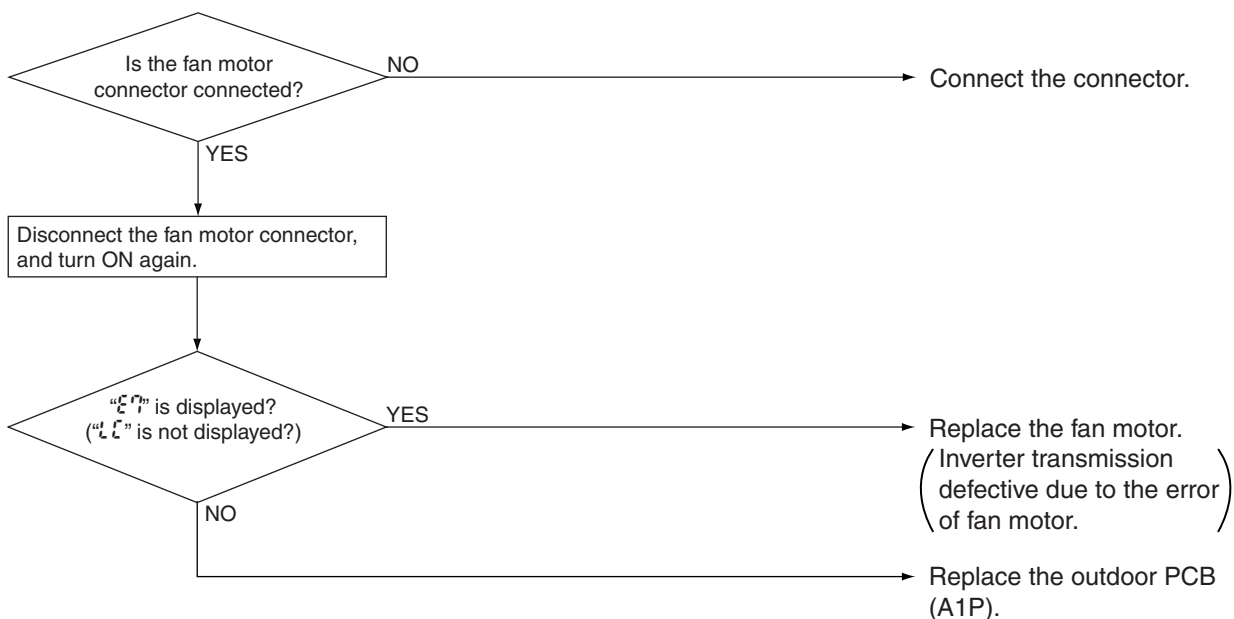

4.27 Open Phase or Power Supply Voltage Imbalance

Remote Controller Display	P1
Applicable Models	RZQG
Method of Error Detection	The error is detected according to the voltage waveform of main circuit capacitor built in inverter.
Error Decision Conditions	When the aforementioned voltage waveform becomes identical with the waveform of the power supply open phase.
Supposed Causes	<ul style="list-style-type: none"> ■ Open phase ■ Voltage imbalance between phases ■ Defective outdoor unit PCB <ul style="list-style-type: none"> • Defective main circuit capacitor • Power unit (Disconnection in diode module) • Defective magnetic relay (K1R, K10R) • Improper main circuit wiring

Troubleshooting



Caution Be sure to turn off power switch before connect or disconnect connector, or parts damage may be occurred.

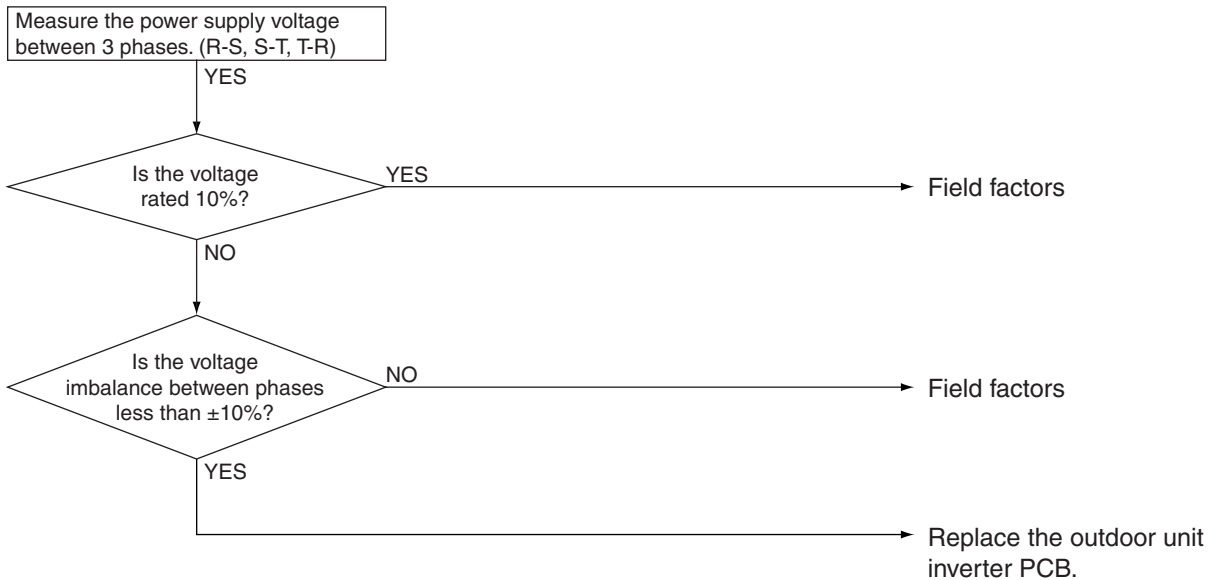

4.28 Defective Capacity Setting

Remote Controller Display	
Applicable Models	RZQG
Method of Error Detection	Check whether set value written in E ² PROM (at factory) or set value of capacity setting adaptor (for spare) is the same as outdoor unit capacity.
Error Decision Conditions	When the set value on E ² PROM differs from the outdoor unit capacity or a capacity setting adaptor except for PCB applicable models is installed. (Error decision is made only when turning the power supply ON.)
Supposed Causes	<ul style="list-style-type: none"> ■ Improper set value of E²PROM ■ Improper capacity setting adaptor ■ Mismatching of type of PCB

Troubleshooting



Caution Be sure to turn off power switch before connect or disconnect connector, or parts damage may be occurred.

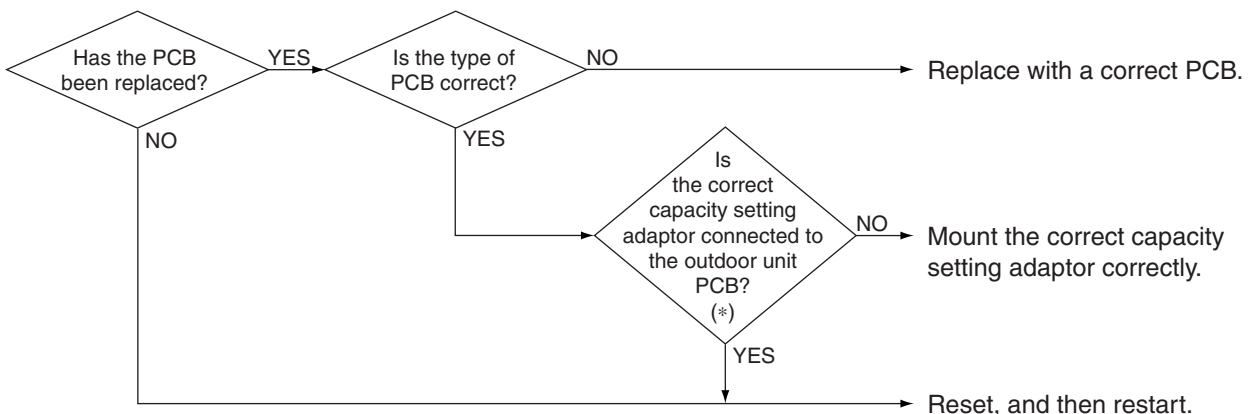

Note:

* Capacity setting adaptor is not connected at factory. (Capacity is written in E²PROM.) Capacity setting adaptor is required only when the PCB was replaced with a spare PCB.

4.29 Refrigerant Shortage (Alert)

Remote Controller Display	
Applicable Models	RZQG
Method of Error Detection	Refrigerant shortage is detected according to the electronic expansion valve opening degree and measured temperatures and pressures.
Error Decision Conditions	<p>(In cooling operation) When the electronic expansion valve opens fully and low pressure is below 0.25 MPa continuously for 30 seconds.</p> <p>(In heating operation) When the electronic expansion valve opens fully and the suction superheat is large (more than 20°C) continuously for 60 seconds.</p> <p>* Even if error occurs, operation will continue.</p>
Supposed Causes	<ul style="list-style-type: none"> ■ Stop valve is not opened ■ Insufficient refrigerant amount ■ Clogged refrigerant piping system

Troubleshooting



Caution Be sure to turn off power switch before connect or disconnect connector, or parts damage may be occurred.

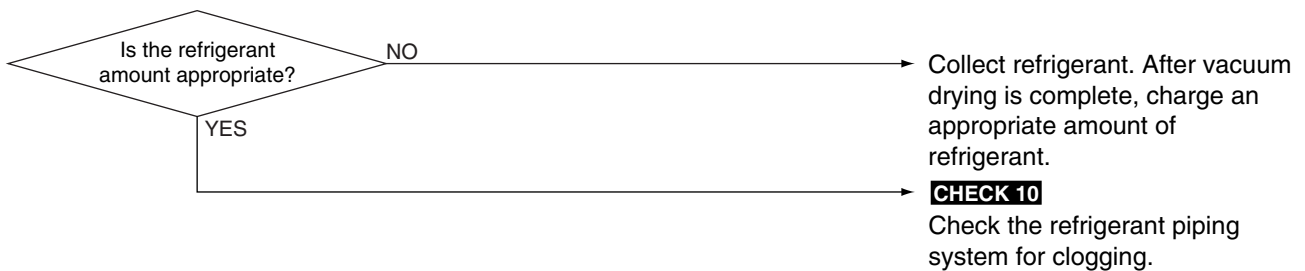

Note:

* Refrigerant shortage alarm is indicated but operation continues.



CHECK 10 Refer to P.175.

4.30 Refrigerant Shortage (Error)

Remote Controller Display	
Applicable Models	RZQG
Method of Error Detection	<p>(In cooling) Detection based on difference in temperature between temperature set by remote controller and indoor suction air temperature, electronic expansion valve opening degree, compressor frequency and low pressure.</p> <p>(In heating) Detection based on difference in temperature between temperature set by remote controller and indoor suction air temperature, electronic expansion valve opening degree during the control of suction air superheating, high pressure, indoor heat exchanger temperature and indoor suction air temperature.</p>
Error Decision Conditions	<p>(In cooling) When compressor frequency does not increase even though the load is heavy because the electronic expansion valve is opened to the fullest extent</p> <p>(In heating) When suction gas superheat degree is large, compressor frequency is low and the electronic expansion valve is opened to the fullest extent even though heating load is heavy [If high pressure is lower than saturated pressure for indoor heat exchanger temperature (or indoor suction air temperature), error is confirmed.]</p>
Supposed Causes	<ul style="list-style-type: none"> ■ Refrigerant shortage ■ Clogged refrigerant piping system ■ Mismatching of wiring and piping ■ Stop valve is not opened

Troubleshooting



Caution Be sure to turn off power switch before connect or disconnect connector, or parts damage may be occurred.

CHECK 10
Check for refrigerant shortage.

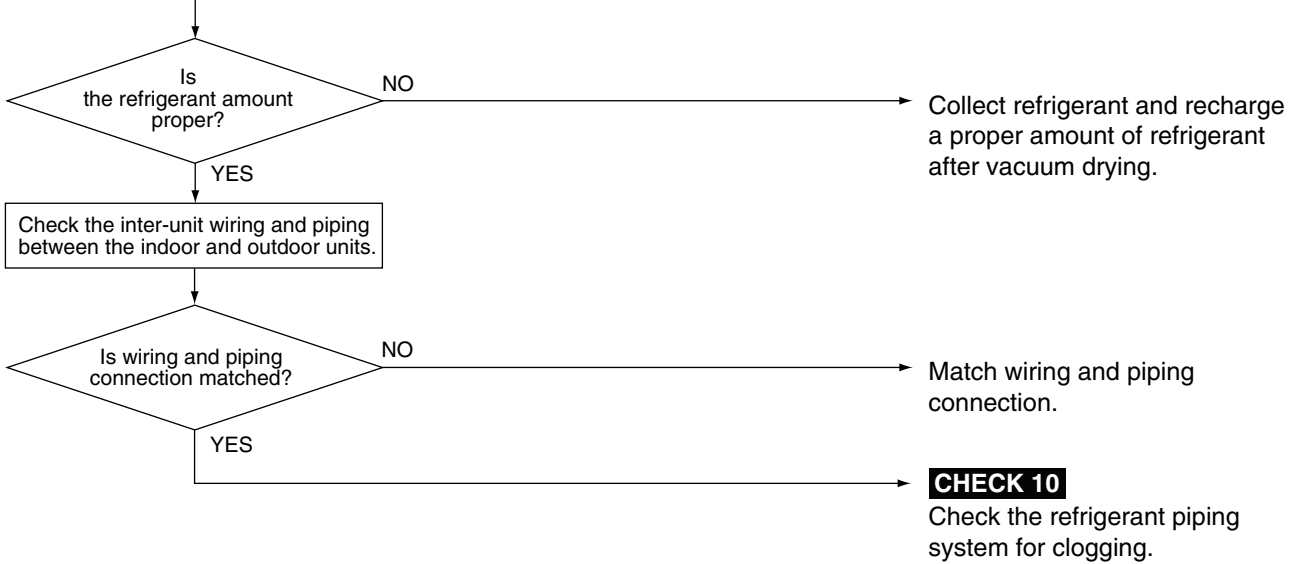

CHECK 10 Refer to P.175.

4.31 Power Supply Voltage Abnormality

Remote Controller Display	U2
Applicable Models	RZQG
Method of Error Detection	The error is detected according to the voltage of main circuit capacitor built in the inverter and power supply voltage.
Error Decision Conditions	When the voltage of main circuit capacitor built in the inverter and power supply voltage drop or when the power failure of several tens of ms or more is generated.
Supposed Causes	<ul style="list-style-type: none">■ Drop in power supply voltage■ Defective outdoor fan motor■ Instantaneous power failure■ Defective outdoor unit inverter PCB■ Main circuit parts damaged

Troubleshooting



Caution Be sure to turn off power switch before connect or disconnect connector, or parts damage may be occurred.

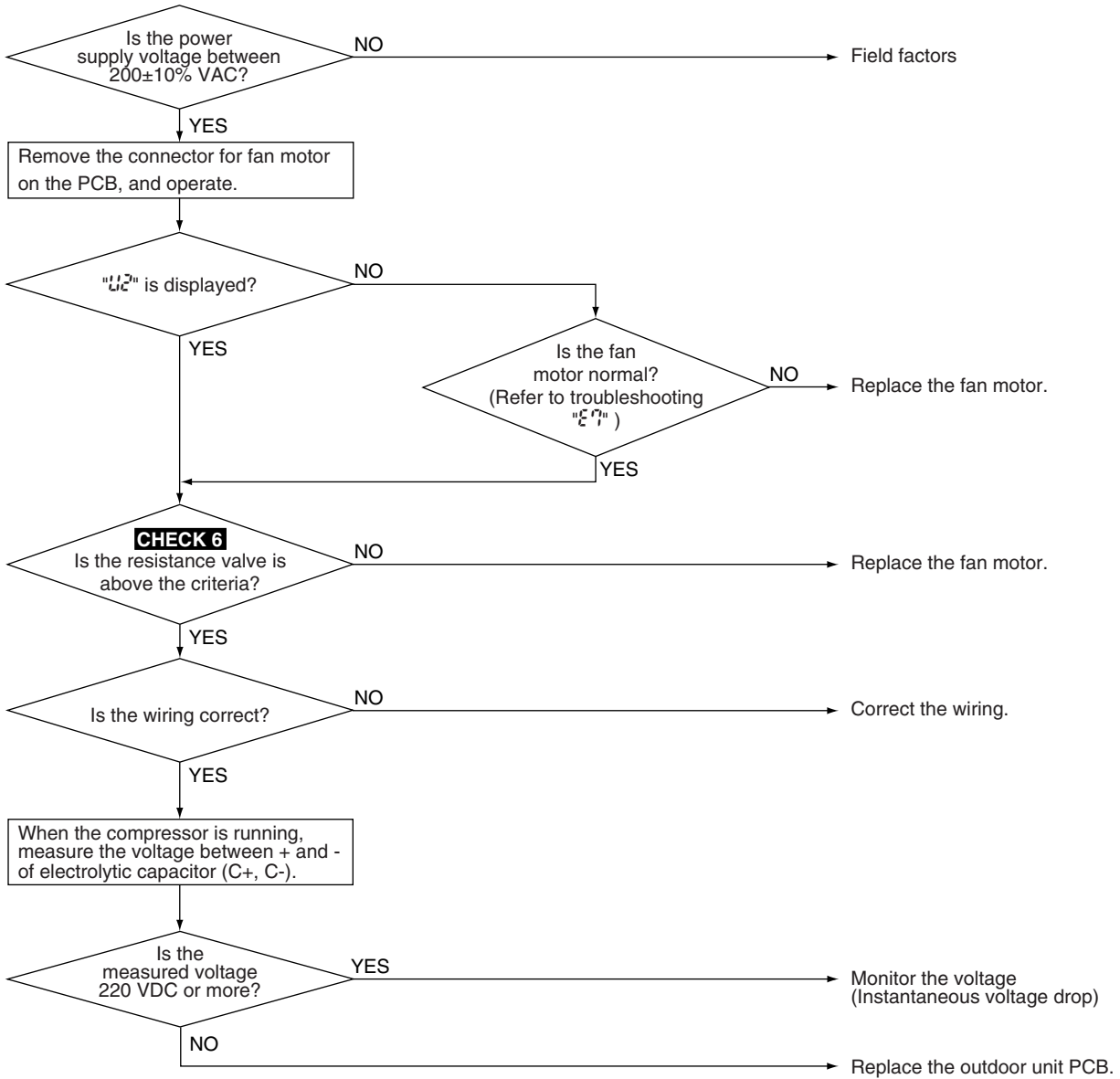

CHECK 6 Refer to P.172.

4.32 Transmission Error between Indoor and Outdoor Unit

Remote
Controller
Display

U4

Applicable
Models

RZQG

Method of Error
Detection

The error is generated when the micro-processor detects that the transmission between the indoor and the outdoor unit is not normal over a certain amount of time.

Error Decision
Conditions

When the transmission is not carried out normally over a certain amount of time.

Supposed
Causes

- Wiring indoor-outdoor transmission wire is incorrect
- Defective indoor unit PCB
- Defective outdoor unit PCB
- Burning out fuse
- Defective outdoor fan motor
- External factor (Noise, etc.)
- Defective power supply
- Disconnection of optional equipments

Troubleshooting



Caution Be sure to turn off power switch before connect or disconnect connector, or parts damage may be occurred.

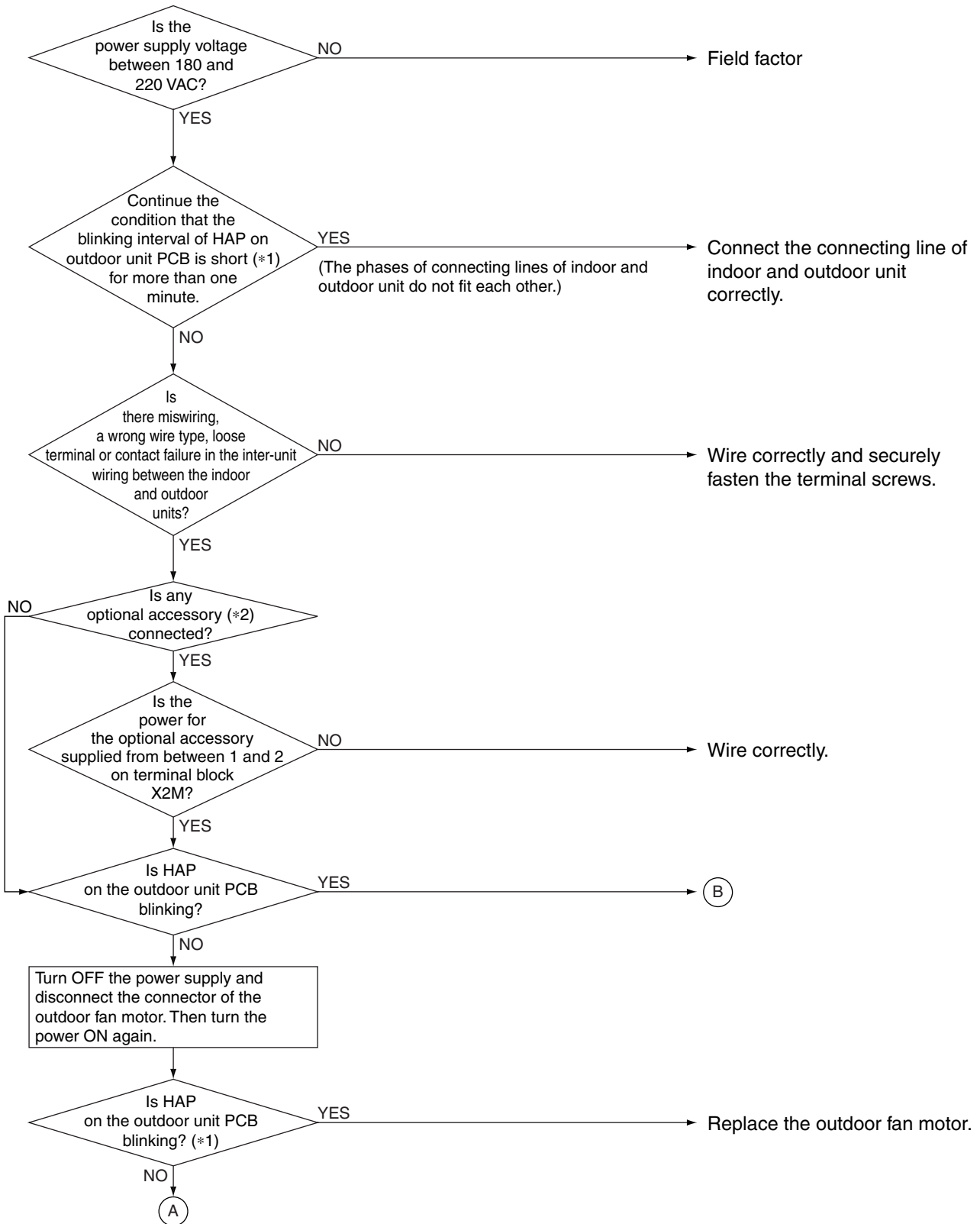

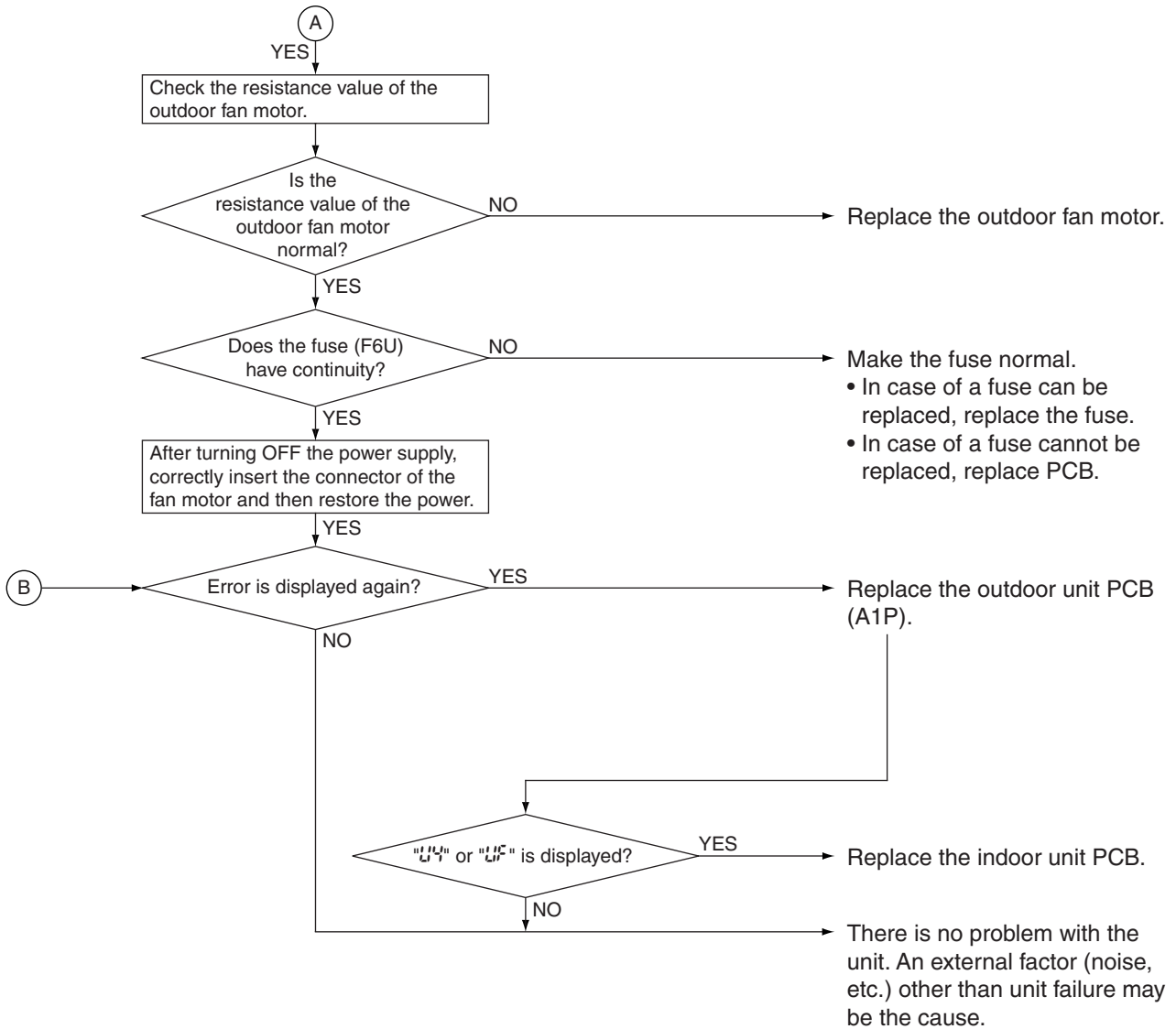
**Note:**

- *1 ON for 0.2 second and OFF for 0.2 second (Blink about 25 times for 10 seconds)
(Normally, ON for 0.4 second and OFF for 0.4 second (Blink about 12 times for 10 seconds))
- *2 Optional accessories refer to adaptor for wiring, auto grill and other accessories.

4.33 Transmission Error Between Remote Controller and Indoor Unit

Remote Controller Display	05
Applicable Models	All models of indoor unit
Method of Error Detection	The error is generated when the micro-computer detects that the transmission between the indoor and the outdoor unit is not normal over a certain amount of time.
Error Decision Conditions	Normal transmission does not continue for specified period.
Supposed Causes	<ul style="list-style-type: none"> ■ Connection of two main remote controllers (when using 2 remote controllers) ■ Defective remote controller ■ Defective of indoor unit PCB ■ External factor (Noise, etc.)

Troubleshooting



Caution Be sure to turn off power switch before connect or disconnect connector, or parts damage may be occurred.

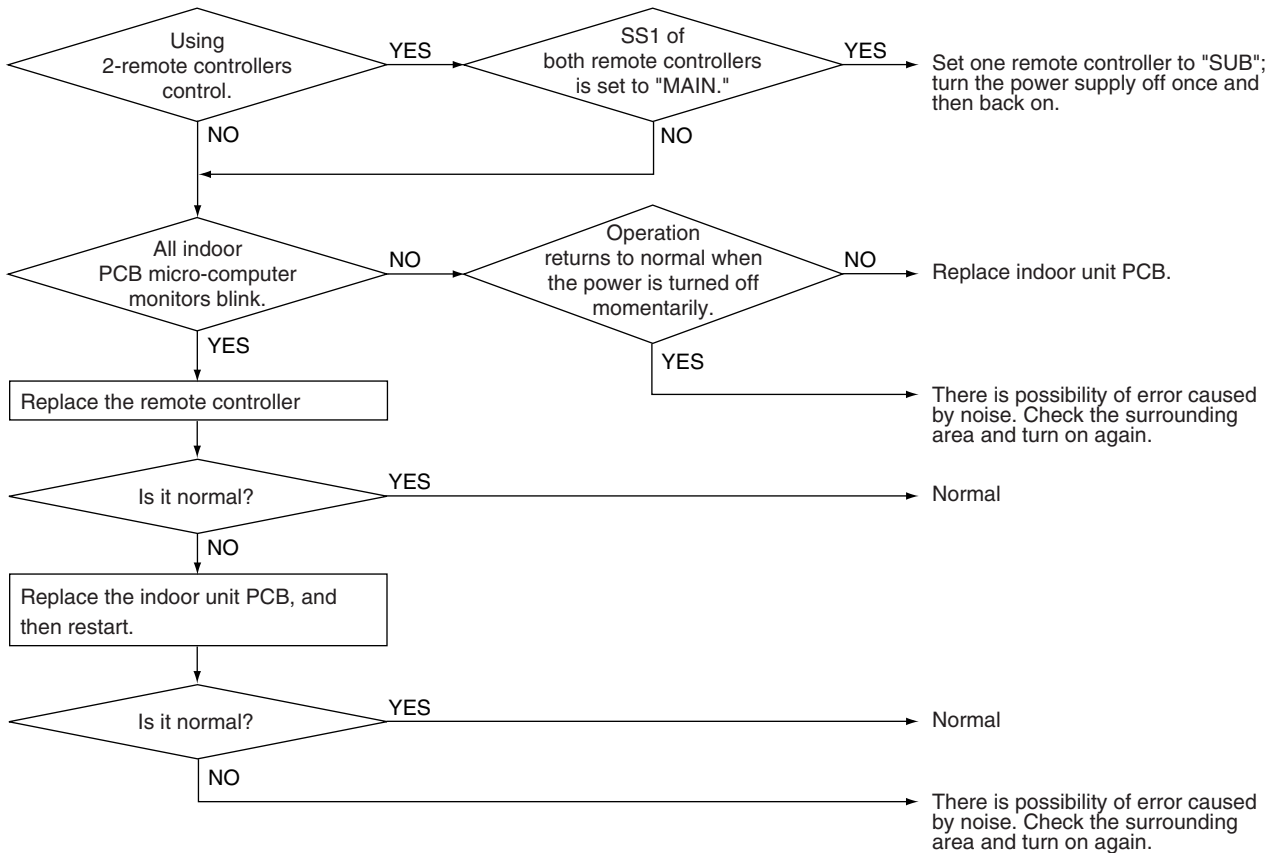

4.34 Transmission Error between MAIN Remote Controller and SUB Remote Controller

Remote Controller Display	
Applicable Models	All models of indoor units
Method of Error Detection	In case of controlling with 2- remote controller, check the system using micro-computer if signal transmission between indoor unit and remote controller (main and sub) is normal.
Error Decision Conditions	The error is generated when, in case of controlling with 2 remote controllers, the micro-processor detects that the transmission between the indoor unit and the remote controllers (MAIN and SUB) is not normal over a certain amount of time.
Supposed Causes	<ul style="list-style-type: none"> ■ Setting failure with remote controller ■ Connection among SUB remote controllers ■ Defective remote controller PCB ■ Disconnection of remote controller wiring

Troubleshooting



Caution Be sure to turn off power switch before connect or disconnect connector, or parts damage may be occurred.

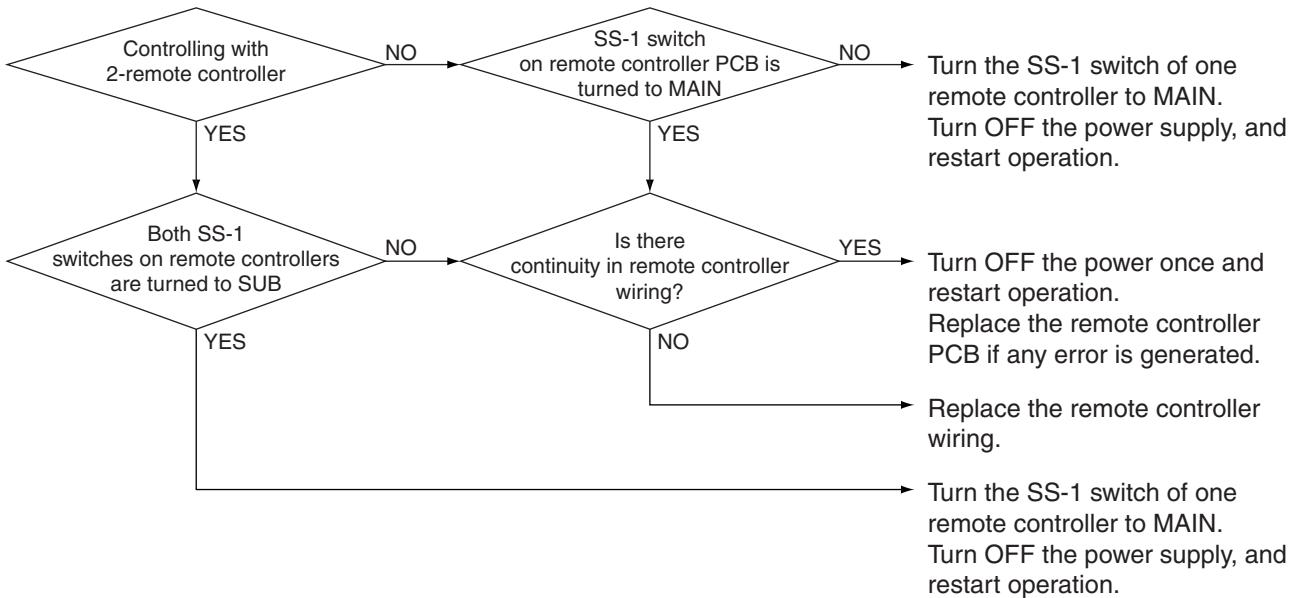

4.35 Field Setting Switch Abnormality

Remote Controller Display	
Applicable Models	All models of indoor unit
Method of Error Detection	
Error Decision Conditions	Incorrect combination indoor unit and outdoor unit Improper field setting
Supposed Causes	<ul style="list-style-type: none"> ■ Defective indoor unit PCB and wrong wiring ■ Defective power supply PCB connection ■ Indoor-outdoor, indoor-indoor unit transmission wiring ■ Defective remote controller wiring ■ Defective indoor unit PCB ■ Failure for setting the number of simultaneous multi-units ■ Wrong wiring of crossing transition wire ■ Defective multi remote controller connection ■ Faulty connection of optional equipment

Troubleshooting



Caution Be sure to turn off power switch before connect or disconnect connector, or parts damage may be occurred.

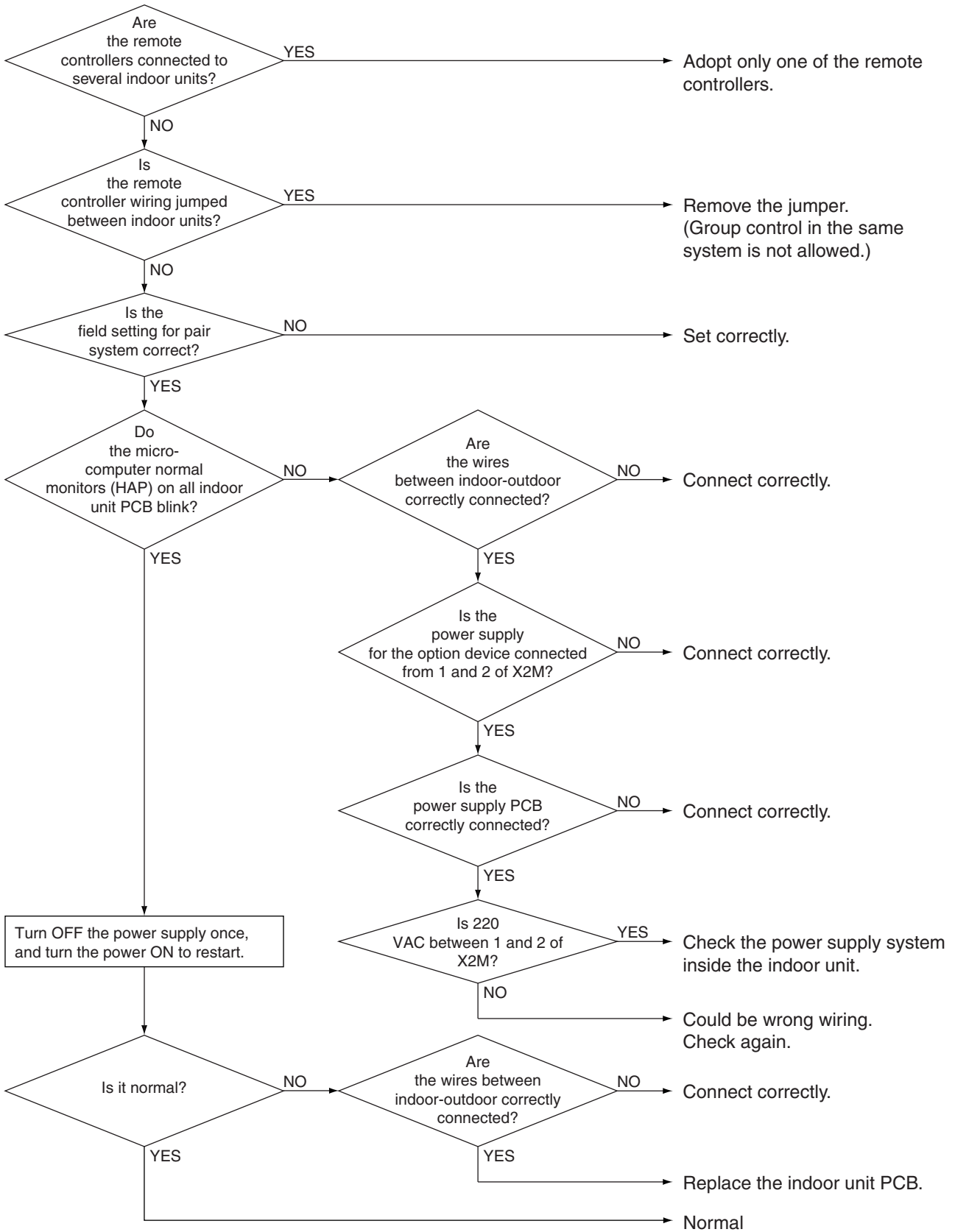

4.36 “U^U” Address Duplication of Centralized Controller

Remote Controller Display	U ^U
Applicable Models	All models of indoor unit Centralized controller
Method of Error Detection	The principal indoor unit detects the same address as that of its own on any other indoor unit.
Error Decision Conditions	The error decision is made as soon as the abnormality aforementioned is detected.
Supposed Causes	<ul style="list-style-type: none"> ■ Address duplication of centralized controller
Troubleshooting	



Caution Be sure to turn off power switch before connect or disconnect connector, or parts damage may be occurred.

The centralized address is duplicated.

Make setting change so that the centralized address will not be duplicated.

4.37 Transmission Error Between Centralized Controller and Indoor Unit

Remote Controller Display	UE
Applicable Models	All models of indoor units Centralized controller Schedule timer
Method of Error Detection	Micro-computer checks if transmission between indoor unit and centralized controller is normal.
Error Decision Conditions	When transmission is not carried out normally for a certain amount of time
Supposed Causes	<ul style="list-style-type: none"> ■ Transmission error between centralized control and indoor unit ■ Defective PCB for central remote controller ■ Defect of indoor unit PCB ■ Breaking and wrong wiring of connecting wire ■ Failure of the setting of group No. and address

Troubleshooting



Caution Be sure to turn off power switch before connect or disconnect connector, or parts damage may be occurred.

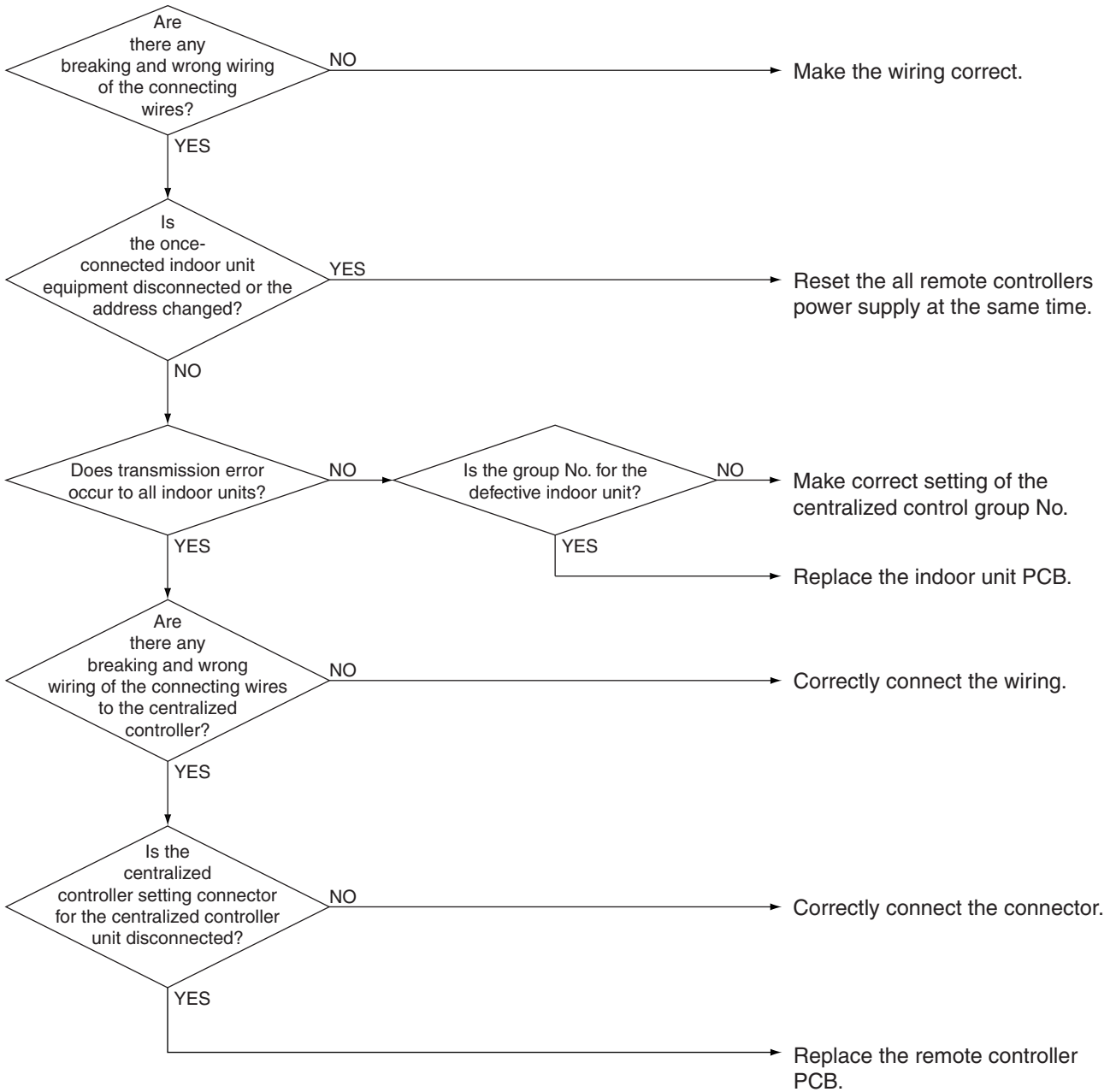

4.38 Transmission Error between Indoor and Outdoor Unit / Piping and Wiring Mismatch / Refrigerant Shortage

Remote Controller Display	UE
Applicable Models	RZQG
Method of Error Detection	<p>Check the transmission between the indoor and outdoor units with a micro-computer when the power turned ON.</p> <p>Detect by checking the following temperature differences during compressor operation.</p> <p>A: Difference in temperature detected by the indoor heat exchanger thermistor (R2T) and the indoor suction air thermistor (R1T)</p> <p>B: Difference in evaporation temperature (Te) (or condensation temperature (Tc) during heating operation) detected by the indoor heat exchanger thermistor (R2T) and the compressor sensor</p>
Error Decision Conditions	<p>When the inter-unit wiring between the indoor and outdoor units is incorrect</p> <p>When the following conditions continue for 20 minutes during compressor operation</p> <p>A: $R2T - R1T < 4^{\circ}\text{C}$, and</p> <p>B: $R2T - T_e$ (or T_c during heating operation) $> 14^{\circ}\text{C}$ (24°C during heating operation)</p>
Supposed Causes	<ul style="list-style-type: none"> ■ Defective inter-unit wiring between the indoor and outdoor units ■ Mismatching of wiring and piping ■ Refrigerant shortage (shortage of gas) ■ Clogged refrigerant piping system

Troubleshooting



Caution Be sure to turn off power switch before connect or disconnect connector, or parts damage may be occurred.

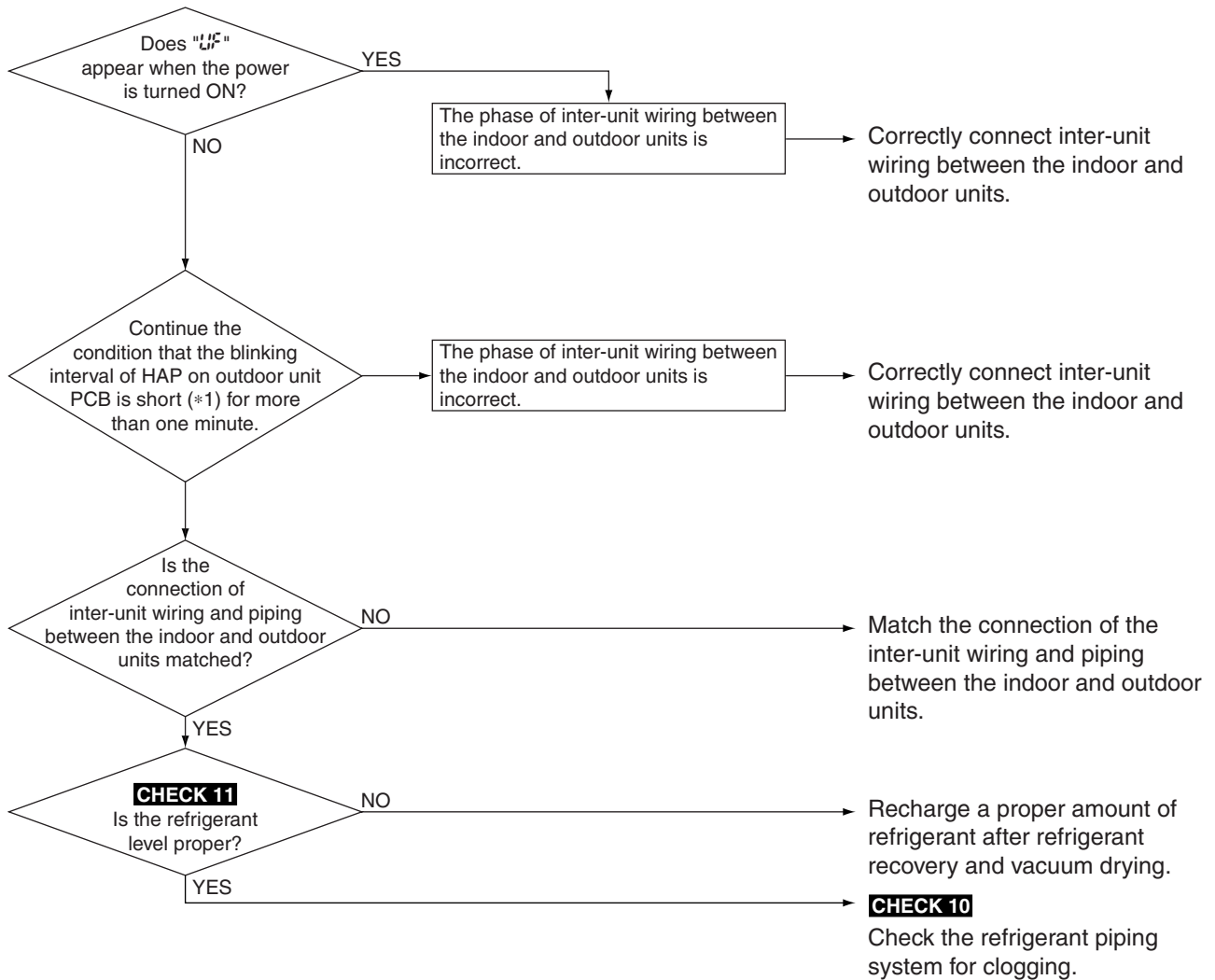

Note:

*1 ON for 0.2 second and OFF for 0.2 second (Blink about 25 times for 10 seconds)
 (Normally, ON for 0.4 second and OFF for 0.4 second (Blink about 12 times for 10 seconds))



CHECK 10 Refer to P.175.

CHECK 11 Refer to P.176.

4.39 Check

CHECK 1 Check the Thermistors

Thermistors

If the cause of the problem is related to the thermistors, then the thermistors should be checked prior to changing the PCB.

For more information about these thermistors, see:

- “Wiring Diagrams” on P.180
- “Functions of Main Components and Thermistors” on P.25

Overview of Thermistors

The table below contains an overview of the thermistors:

Indoor

FCQG, FHQG	Thermistor
R1T	Suction air thermistor
R2T	Heat exchanger thermistor
R3T	Intermediate heat exchanger thermistor

Outdoor

RZQG	Thermistor
R1T	Outdoor air thermistor
R2T	Discharge pipe thermistor
R3T	Suction pipe thermistor
R4T	Heat exchanger distributor pipe thermistor
R5T	Intermediate heat exchanger thermistor
R6T	Liquid pipe thermistor
R10T	Radiation fin thermistor

Checking

To check the thermistors, proceed as follows:

Step	Action
1	Disconnect the thermistor from the PCB
2	Read the temperature and the resistor value.
3	Check if the measured values correspond with the values in the table on the next pages.

Thermistor Resistance / Temperature Characteristics

Indoor unit	FCQG, FHQG	Thermistor
	R1T	Suction air thermistor
	R2T	Heat exchanger thermistor
	R3T	Intermediate heat exchanger thermistor

Outdoor unit	RZQG	Thermistor
	R1T	Outdoor air thermistor
	R3T	Suction pipe thermistor
	R4T	Heat exchanger distributor pipe
	R5T	Intermediate heat exchanger thermistor
	R6T	Liquid pipe thermistor
	R10T	Radiation fin thermistor

T°C	kΩ
-10	-
-8	-
-6	88.0
-4	79.1
-2	71.1
0	64.1
2	57.8
4	52.3
6	47.3
8	42.9
10	38.9
12	35.3
14	32.1
16	29.2
18	26.6
20	24.3
22	22.2
24	20.3
26	18.5
28	17.0
30	15.6
32	14.2
34	13.1
36	12.0
38	11.1
40	10.3
42	9.5
44	8.8
46	8.2
48	7.6
50	7.0
52	6.7
54	6.0
56	5.5
58	5.2
60	4.79
62	4.46
64	4.15
66	3.87
68	3.61
70	3.37
72	3.15
74	2.94
76	2.75
78	2.51
80	2.41
82	2.26
84	2.12
86	1.99
88	1.87
90	1.76
92	1.65
94	1.55
96	1.46
98	1.38

T°C	kΩ
-20	197.81
-19	186.53
-18	175.97
-17	166.07
-16	156.80
-15	148.10
-14	139.94
-13	132.28
-12	125.09
-11	118.34
-10	111.99
-9	106.03
-8	100.41
-7	95.14
-6	90.17
-5	85.49
-4	81.08
-3	76.93
-2	73.01
-1	69.32
0	65.84
1	62.54
2	59.43
3	56.49
4	53.71
5	51.09
6	48.61
7	46.26
8	44.05
9	41.95
10	39.96
11	38.08
12	36.30
13	34.62
14	33.02
15	31.50
16	30.06
17	28.70
18	27.41
19	26.18
20	25.01
21	23.91
22	22.85
23	21.85
24	20.90
25	20.00
26	19.14
27	18.32
28	17.54
29	16.80
30	16.10

T°C	kΩ
-19.5	192.08
-18.5	181.16
-17.5	170.94
-16.5	161.36
-15.5	152.38
-14.5	143.96
-13.5	136.05
-12.5	128.63
-11.5	121.66
-10.5	115.12
-9.5	108.96
-8.5	103.18
-7.5	97.73
-6.5	92.61
-5.5	87.79
-4.5	83.25
-3.5	78.97
-2.5	74.94
-1.5	71.14
-0.5	67.56
0.5	64.17
1.5	60.96
2.5	57.94
3.5	55.08
4.5	52.38
5.5	49.83
6.5	47.42
7.5	45.14
8.5	42.98
9.5	40.94
10.5	39.01
11.5	37.18
12.5	35.45
13.5	33.81
14.5	32.25
15.5	30.77
16.5	29.37
17.5	28.05
18.5	26.78
19.5	25.59
20.5	24.45
21.5	23.37
22.5	22.35
23.5	21.37
24.5	20.45
25.5	19.56
26.5	18.73
27.5	17.93
28.5	17.17
29.5	16.45
30.5	15.76

T°C	kΩ
30	16.10
31	15.43
32	14.79
33	14.18
34	13.59
35	13.04
36	12.51
37	12.01
38	11.52
39	11.06
40	10.63
41	10.21
42	9.81
43	9.42
44	9.06
45	8.71
46	8.37
47	8.05
48	7.75
49	7.46
50	7.18
51	6.91
52	6.65
53	6.41
54	6.18
55	5.95
56	5.74
57	5.54
58	5.34
59	5.14
60	4.96
61	4.79
62	4.62
63	4.46
64	4.30
65	4.16
66	4.01
67	3.88
68	3.75
69	3.62
70	3.50
71	3.38
72	3.27
73	3.16
74	3.06
75	2.96
76	2.86
77	2.77
78	2.68
79	2.60
80	2.51

T°C	kΩ
30.5	15.76
31.5	15.10
32.5	14.48
33.5	13.88
34.5	13.31
35.5	12.77
36.5	12.25
37.5	11.76
38.5	11.29
39.5	10.84
40.5	10.41
41.5	10.00
42.5	9.61
43.5	9.24
44.5	8.88
45.5	8.54
46.5	8.21
47.5	7.90
48.5	7.60
49.5	7.31
50.5	7.04
51.5	6.78
52.5	6.53
53.5	6.29
54.5	6.06
55.5	5.84
56.5	5.62
57.5	5.41
58.5	5.21
59.5	5.01
60.5	4.81
61.5	4.61
62.5	4.42
63.5	4.23
64.5	4.04
65.5	3.86
66.5	3.68
67.5	3.51
68.5	3.34
69.5	3.17
70.5	3.01
71.5	2.85
72.5	2.70
73.5	2.55
74.5	2.41
75.5	2.27
76.5	2.14
77.5	2.01
78.5	1.89
79.5	1.77
80.5	1.66

Outdoor unit	RZQG	Thermistor
	R2T	Discharge pipe thermistor

T°C	kΩ	T°C	kΩ	T°C	kΩ	T°C	kΩ	T°C	kΩ	T°C	kΩ
0	640.44	0.5	624.65	50	72.32	50.5	70.96	100	13.35	100.5	13.15
1	609.31	1.5	594.43	51	69.64	51.5	68.34	101	12.95	101.5	12.76
2	579.96	2.5	565.78	52	67.06	52.5	65.82	102	12.57	102.5	12.38
3	552.00	3.5	538.63	53	64.60	53.5	63.41	103	12.20	103.5	12.01
4	525.63	4.5	512.97	54	62.24	54.5	61.09	104	11.84	104.5	11.66
5	500.66	5.5	488.67	55	59.97	55.5	58.87	105	11.49	105.5	11.32
6	477.01	6.5	465.65	56	57.80	56.5	56.75	106	11.15	106.5	10.99
7	454.60	7.5	443.84	57	55.72	57.5	54.70	107	10.83	107.5	10.67
8	433.37	8.5	423.17	58	53.72	58.5	52.84	108	10.52	108.5	10.36
9	413.24	9.5	403.57	59	51.98	59.5	50.96	109	10.21	109.5	10.06
10	394.16	10.5	384.98	60	49.96	60.5	49.06	110	9.92	110.5	9.78
11	376.05	11.5	367.35	61	48.19	61.5	47.33	111	9.64	111.5	9.50
12	358.88	12.5	350.62	62	46.49	62.5	45.67	112	9.36	112.5	9.23
13	342.58	13.5	334.74	63	44.86	63.5	44.07	113	9.10	113.5	8.97
14	327.10	14.5	319.66	64	43.30	64.5	42.54	114	8.84	114.5	8.71
15	312.41	15.5	305.33	65	41.79	65.5	41.06	115	8.59	115.5	8.47
16	298.45	16.5	291.73	66	40.35	66.5	39.65	116	8.35	116.5	8.23
17	285.18	17.5	278.80	67	38.96	67.5	38.29	117	8.12	117.5	8.01
18	272.58	18.5	266.51	68	37.63	68.5	36.98	118	7.89	118.5	7.78
19	260.60	19.5	254.72	69	36.34	69.5	35.72	119	7.68	119.5	7.57
20	249.00	20.5	243.61	70	35.11	70.5	34.51	120	7.47	120.5	7.36
21	238.36	21.5	233.14	71	33.92	71.5	33.35	121	7.26	121.5	7.16
22	228.05	22.5	223.08	72	32.78	72.5	32.23	122	7.06	122.5	6.97
23	218.24	23.5	213.51	73	31.69	73.5	31.15	123	6.87	123.5	6.78
24	208.90	24.5	204.39	74	30.63	74.5	30.12	124	6.69	124.5	6.59
25	200.00	25.5	195.71	75	29.61	75.5	29.12	125	6.51	125.5	6.42
26	191.53	26.5	187.44	76	28.64	76.5	28.16	126	6.33	126.5	6.25
27	183.46	27.5	179.57	77	27.69	77.5	27.24	127	6.16	127.5	6.08
28	175.77	28.5	172.06	78	26.79	78.5	26.35	128	6.00	128.5	5.92
29	168.44	29.5	164.90	79	25.91	79.5	25.49	129	5.84	129.5	5.76
30	161.45	30.5	158.08	80	25.07	80.5	24.66	130	5.69	130.5	5.61
31	154.79	31.5	151.57	81	24.26	81.5	23.87	131	5.54	131.5	5.46
32	148.43	32.5	145.37	82	23.48	82.5	23.10	132	5.39	132.5	5.32
33	142.37	33.5	139.44	83	22.73	83.5	22.36	133	5.25	133.5	5.18
34	136.59	34.5	133.79	84	22.01	84.5	21.65	134	5.12	134.5	5.05
35	131.06	35.5	128.39	85	21.31	85.5	20.97	135	4.98	135.5	4.92
36	125.79	36.5	123.24	86	20.63	86.5	20.31	136	4.86	136.5	4.79
37	120.76	37.5	118.32	87	19.98	87.5	19.67	137	4.73	137.5	4.67
38	115.95	38.5	113.62	88	19.36	88.5	19.05	138	4.61	138.5	4.55
39	111.35	39.5	109.13	89	18.75	89.5	18.46	139	4.49	139.5	4.44
40	106.96	40.5	104.84	90	18.17	90.5	17.89	140	4.38	140.5	4.32
41	102.76	41.5	100.73	91	17.61	91.5	17.34	141	4.27	141.5	4.22
42	98.75	42.5	96.81	92	17.07	92.5	16.80	142	4.16	142.5	4.11
43	94.92	43.5	93.06	93	16.54	93.5	16.29	143	4.06	143.5	4.01
44	91.25	44.5	89.47	94	16.04	94.5	15.79	144	3.96	144.5	3.91
45	87.74	45.5	86.04	95	15.55	95.5	15.31	145	3.86	145.5	3.81
46	84.38	46.5	82.75	96	15.08	96.5	14.85	146	3.76	146.5	3.72
47	81.16	47.5	79.61	97	14.62	97.5	14.40	147	3.67	147.5	3.62
48	78.09	48.5	76.60	98	14.18	98.5	13.97	148	3.58	148.5	3.54
49	75.14	49.5	73.71	99	13.76	99.5	13.55	149	3.49	149.5	3.45
50	72.32	50.5	70.96	100	13.35	100.5	13.15	150	3.41	150.5	3.37

CHECK 2 Evaluation of Abnormal High Pressure

Abnormally high pressure level is mostly caused by the condenser side. The following contents are provided by service engineer based on their field checks. Further, the number is listed in the order of degree of influence.

In Cooling Operation

Check items (Possible causes)	Judgement
Does the outdoor unit fan run normally?	Visual inspection
Is the outdoor unit heat exchanger clogged?	Visual inspection
Is there clogging before or after the EV (capillary)?	Check if there is a temperature difference before and after EV (capillary). Check if the main valve unit of EV operates (by noise, vibration).
Is the check valve clogged?	Check if there is a temperature difference before and after check valve. → If YES, the check valve is caught.
Is the HPS normal? *	Check continuity by using a tester.
Is the outdoor unit installed under such conditions that short circuit easily occurs?	Visual inspection
Is the piping length 5 meters or less?	Visual inspection
Does air enter the refrigerant system?	Conduct refrigerant collection and vacuum drying, and then add proper amount refrigerant.
Is the refrigerant overcharged?	Conduct refrigerant collection and vacuum drying, and then add proper amount refrigerant.

In Heating Operation

Check items (Possible causes)	Judgement
Does the indoor unit fan run normally?	Visual inspection
Is the indoor unit heat exchanger clogged?	Visual inspection
Is the indoor unit installed under such conditions that short circuit easily occurs?	Visual inspection
Is there clogging before or after the EV (capillary)?	Check if there is a temperature difference before and after EV (capillary). Check if the main valve unit of EV operates (by noise, vibration).
Is the check valve clogged?	Check if there is a temperature difference before and after check valve. → If YES, the check valve is caught.
Is the HPS normal?	Check continuity using a tester.
Is the piping length 5 meters or less?	Visual inspection
Does air enter the refrigerant system?	Conduct refrigerant collection and vacuum drying, and then add proper amount refrigerant.
Is the refrigerant overcharged?	Conduct refrigerant collection and vacuum drying, and then add proper amount refrigerant.

CHECK 3 Evaluation of Abnormal Low Pressure

Abnormally low pressure level is mostly caused by the evaporator side. The following contents are provided based on field checking of service engineer. Further, the number is listed in the order of degree of influence.

In Cooling Operation

Check items (Possible causes)	Judgement
Does the outdoor unit fan run normally?	Visual inspection
Is the indoor unit filter clogged?	Visual inspection
Is there clogging before or after the EV (capillary)?	Check if there is a temperature difference before and after EV (capillary). Check if the main valve unit of EV operates (by noise, vibration).
Is the check valve clogged?	Check if there is a temperature difference before and after check valve. → If YES, the check valve is caught.
Is the indoor unit installed under such conditions that short circuit easily occurs?	Visual inspection
Is the refrigerant gas short?	Conduct refrigerant collection and vacuum drying, and then add proper amount refrigerant.

In Heating Operation

Check items (Possible causes)	Judgement
Does the outdoor unit fan run normally?	Visual inspection
Is the outdoor unit heat exchanger clogged?	Visual inspection
Is the outdoor unit installed under such conditions that short circuit easily occurs?	Visual inspection
Is there clogging before or after the EV (capillary)?	Check if there is a temperature difference before and after EV (capillary). Check if the main valve unit of EV operates (by noise, vibration).
Is the check valve clogged?	Check if there is a temperature difference before and after check valve. → If YES, the check valve is caught.
Is the refrigerant gas short?	Conduct refrigerant collection and vacuum drying, and then add proper amount refrigerant.

CHECK 4 Check for Power Transistor

Judgement according to the continuity check by using an analog tester:

- (1) Do not touch the charged area (high voltage) for 10 minutes after turning the power supply off.
- (2) If you must touch such an area, make sure that the power supply voltage of power transistor is 50 V or less.
- (3) Disconnect the connector of the outdoor unit fan motor.

When the outdoor unit fan is rotating against a strong wind, the condenser is charged and electric shock may result. Therefore, disconnect the connector from the outdoor unit fan motor after confirming that the outdoor unit fan has stopped.

- (4) Before measuring the continuity, disconnect the connection between compressor and power transistor.
- (5) Measure the continuity in the following procedure.

[Judgement] Normal if the continuity check results in the following.

Power transistor (on inverter PCB)

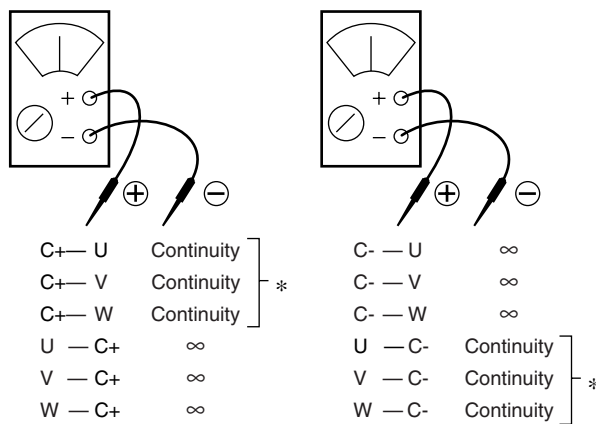

Note:

- * If there is continuity, the resistance should be the same as each phase.
- * If a digital tester is used for the measurement of continuity, ∞ and continuity may be reversed.

CHECK 5 Check Pressure Sensor

Measure the voltage (DC) between pins 1 and 3 of the connector.

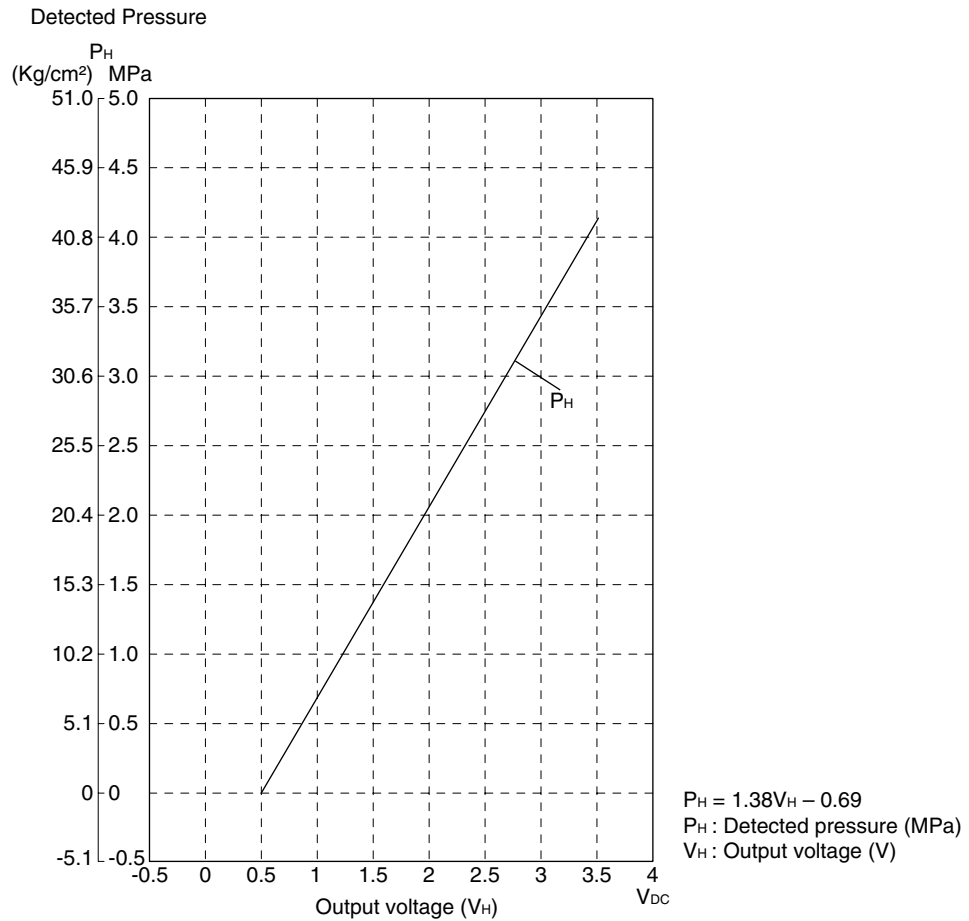
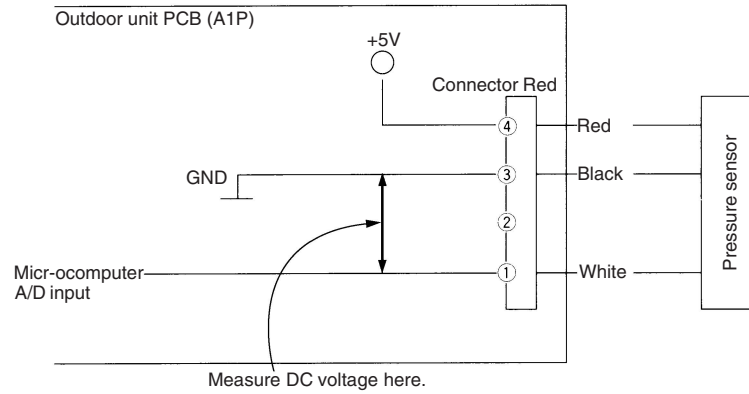

This graph is available for both high pressure sensor and low pressure sensor.

CHECK 6 Fan Motor Signal Line

- (1) Turn the power supply off.
- (2) With the fan motor connector disconnected, measure the resistance between each pin, then make sure that the resistance is more than the value mentioned in the following table.

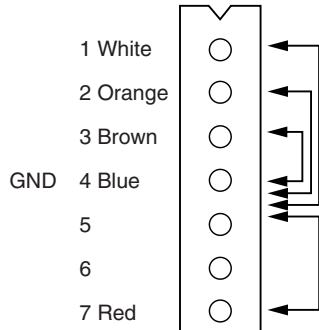

Measurement point	Judgement
1 - 4	1MΩ or more
2 - 4	100kΩ or more
3 - 4	100Ω or more
4 - 7	100kΩ or more

CHECK 7 Electronic expansion valve connector and coil resistance criteria

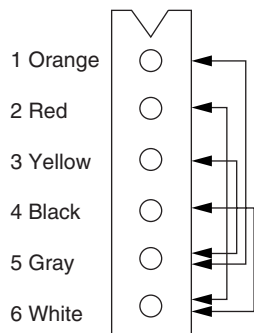

Measurement point	Judgement
1 - 5	40~50Ω
3 - 5	
2 - 6	
4 - 6	

CHECK 8 Check for Factors Causing Wet Operation

Referring to the Fault Tree Analysis (FTA) shown below, identify the faulty points.

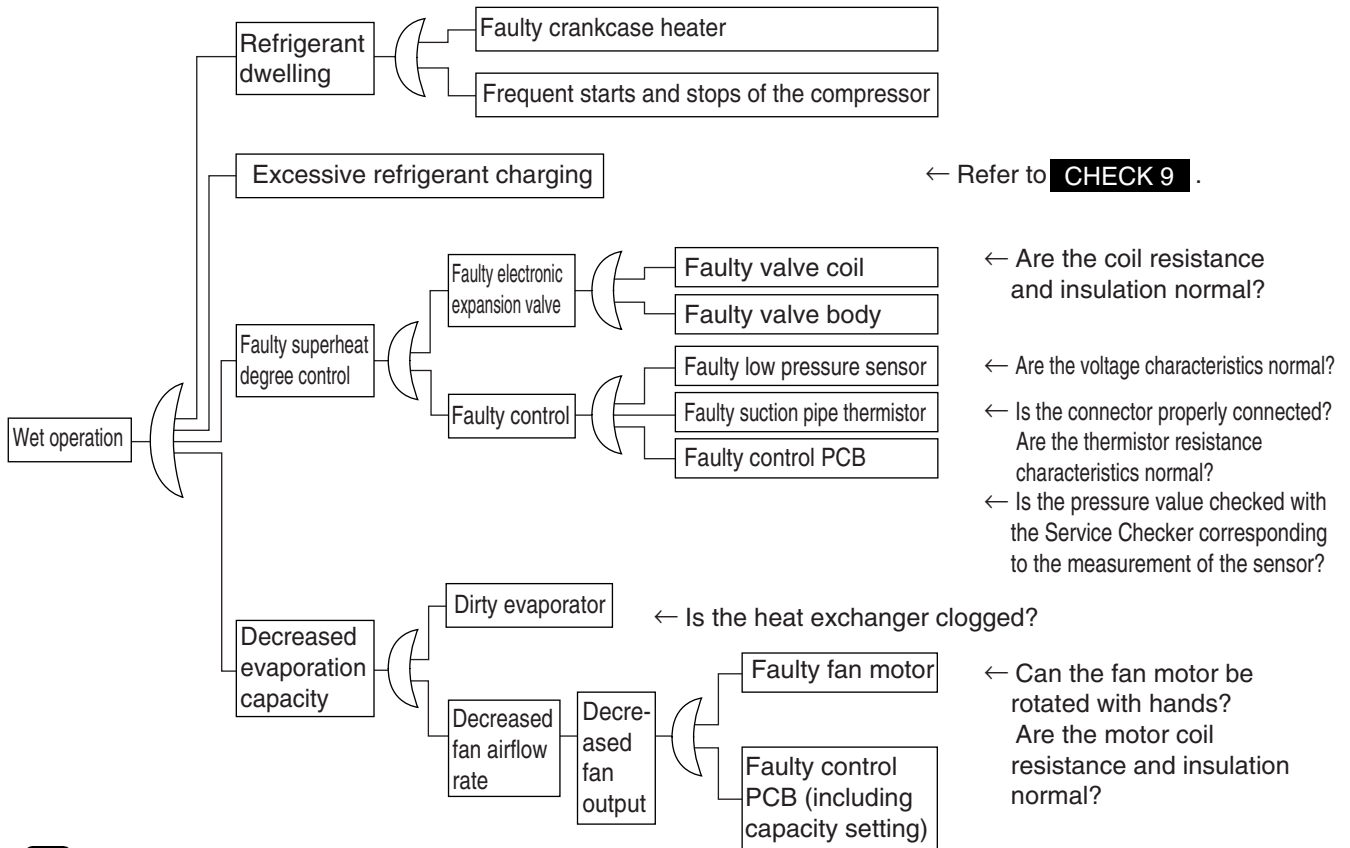

Note:

*: Reference values for superheat degree to be used in the judgement of wet operation

① Suction pipe superheat degree: 4°C or more ② Discharge pipe superheat degree: 5°C or less

(The values above must be used only for reference purposes. Even it is operated within the range above, operation may be normal in other conditions.)

CHECK 9 Check for Excessive Refrigerant Charging

As criteria for judging whether refrigerant is excessively charged or not, refer to the following operating conditions.

<Diagnosis of excessive refrigerant charging>

In cooling operation

- (1) Because high pressure rises due to excessive charging, overload control is carried out and capacity tends to run short.
- (2) Considering pressure load, compressor discharge pipe temperature is low.
- (3) Subcooled degree of condensate liquid becomes large. Therefore, temperature of blown air passing through subcooled part decreases in heating operation.

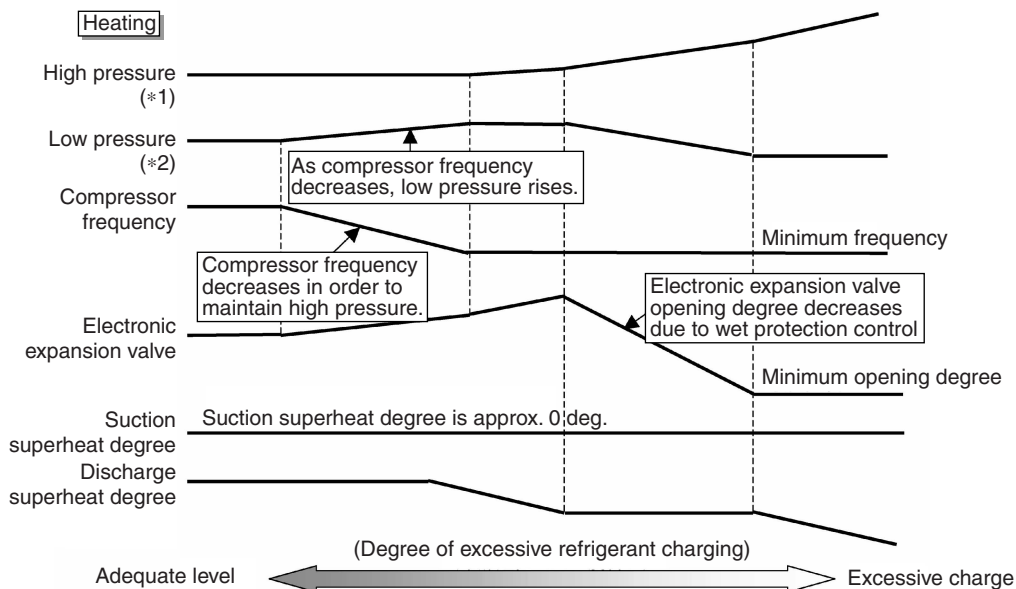
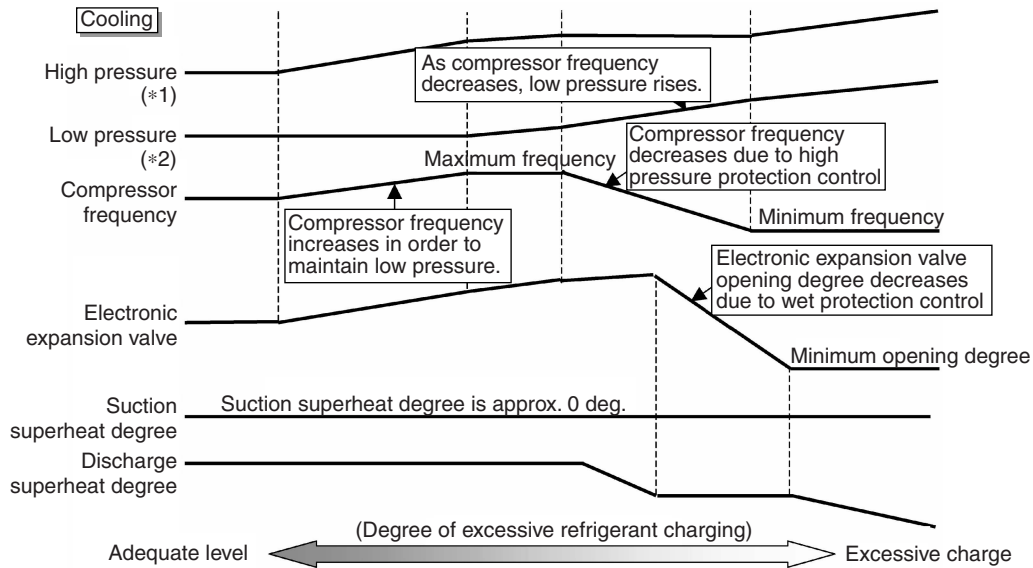

Cooling

*1 High Pressure	Intermediate heat exchanger thermistor (*3)
*2 Low Pressure	Pressure sensor

Heating

*1 High Pressure	Pressure sensor
*2 Low Pressure	Intermediate heat exchanger thermistor (*3)

*3 This measured temperature is used to calculate the equivalent saturation pressure of the refrigerant. (Refer to P.183.)

CHECK 10 Clogged Points

Temperature differences must occur before or after the clogged points!

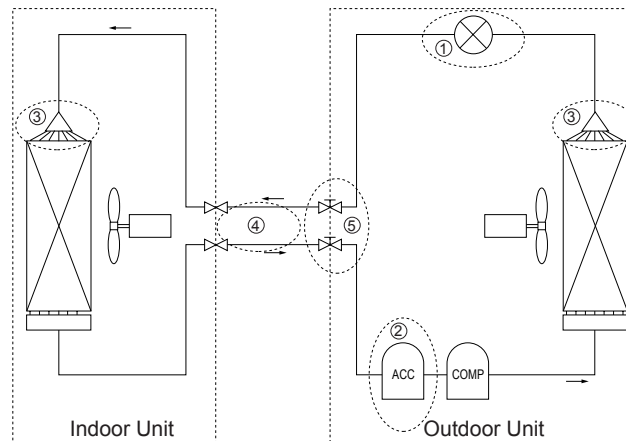

Check points		Check factor	Causes	Remedies
1	Around expansion mechanism	Temperature difference	<ul style="list-style-type: none"> ● Dust ● Choked moisture ● Reduced effective pipe diameter due to adherent contamination, etc. 	Replace the electronic expansion valve.
2	Accumulator	Frosting	<ul style="list-style-type: none"> ● Choked moisture 	Blow a nitrogen gas, and then replace the refrigerant.
3	Distributor	Temperature difference	<ul style="list-style-type: none"> ● Dust ● Choked moisture ● Reduced effective pipe diameter due to adherent contamination, etc. 	Replace the heat exchanger or distributor.
4	Field piping	Temperature difference	<ul style="list-style-type: none"> ● Collapsed pipe 	Replace the pipe.
5	Stop valve	Temperature difference	<ul style="list-style-type: none"> ● The stop valve is not fully open. 	Open the stop valve fully.

CHECK 11 Check for Inadequate Refrigerant

As criteria for judging whether refrigerant is inadequate or not, refer to the following operating conditions.

<Diagnosis of inadequate refrigerant>

In cooling operation

- (1) As suction superheat degree increases due to refrigerant shortage, the electronic expansion valve tends to open (opens fully) in order to avoid overheat operation.
- (2) In response to decreased evaporator capacity caused by refrigerant shortage, capacity is controlled in the inverter in order to maintain low pressure, which results in a decrease in frequency.
- (3) Because of (1) and (2) above, the compressor frequency decreases despite a large difference (large load) between temperature set by the remote controller and indoor suction temperature, resulting that cooling capacity becomes unavailable.
- (4) If refrigerant shortage worsens, the electronic expansion valve remains fully open and suction superheat degree further increases. In addition, because the compressor frequency drops to the level of the lowest frequency (52 Hz) and the refrigerant flow rate decrease, low pressure cannot be maintained.

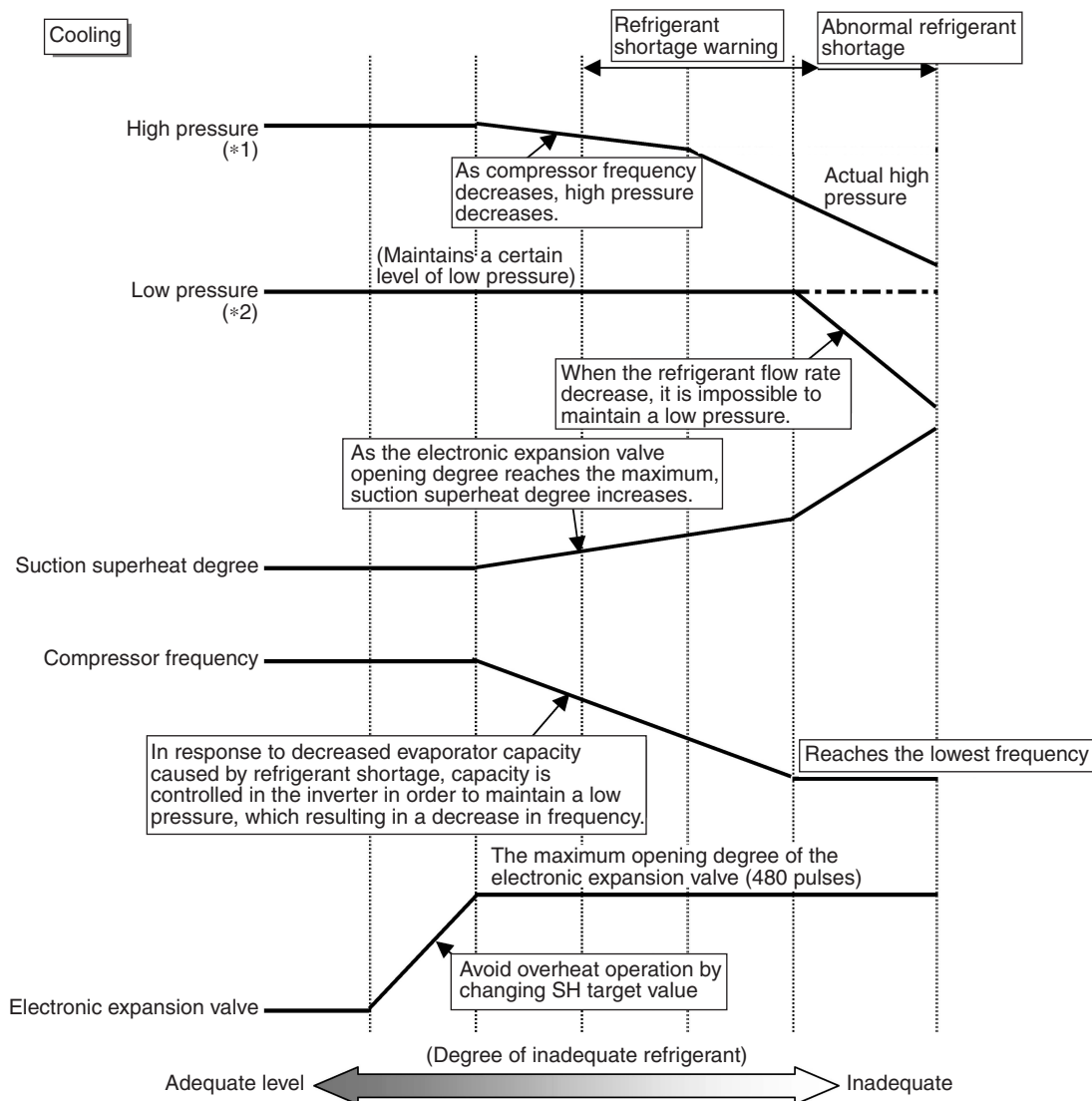

Cooling

*1 High Pressure	Intermediate heat exchanger thermistor (*3)
*2 Low Pressure	Pressure sensor

*3 This measured temperature is used to calculate the equivalent saturation pressure of the refrigerant. (Refer to P.183.)

<Diagnosis of inadequate refrigerant>

In heating operation

- (1) As suction superheat degree increases due to refrigerant shortage, the electronic expansion valve tends to open (opens fully) to avoid overheat operation.
- (2) As suction superheat degree increases due to refrigerant shortage, compressor frequency decreases because suction superheat degree is controlled in order to prevent oil to the outdoor heat exchanger from being retained.
- (3) Because of (1) and (2) above, evaporator capacity and compressor frequency decrease despite a large difference (large load) between temperature set by the remote controller and indoor suction temperature, resulting that high pressure cannot be maintained and heating capacity becomes unavailable. Also a decrease in evaporator capacity frequently puts the system in defrost operation.
- (4) If refrigerant shortage worsens, high pressure becomes smaller than saturated pressure equivalent to indoor heat exchanger temperature (or indoor suction temperature).

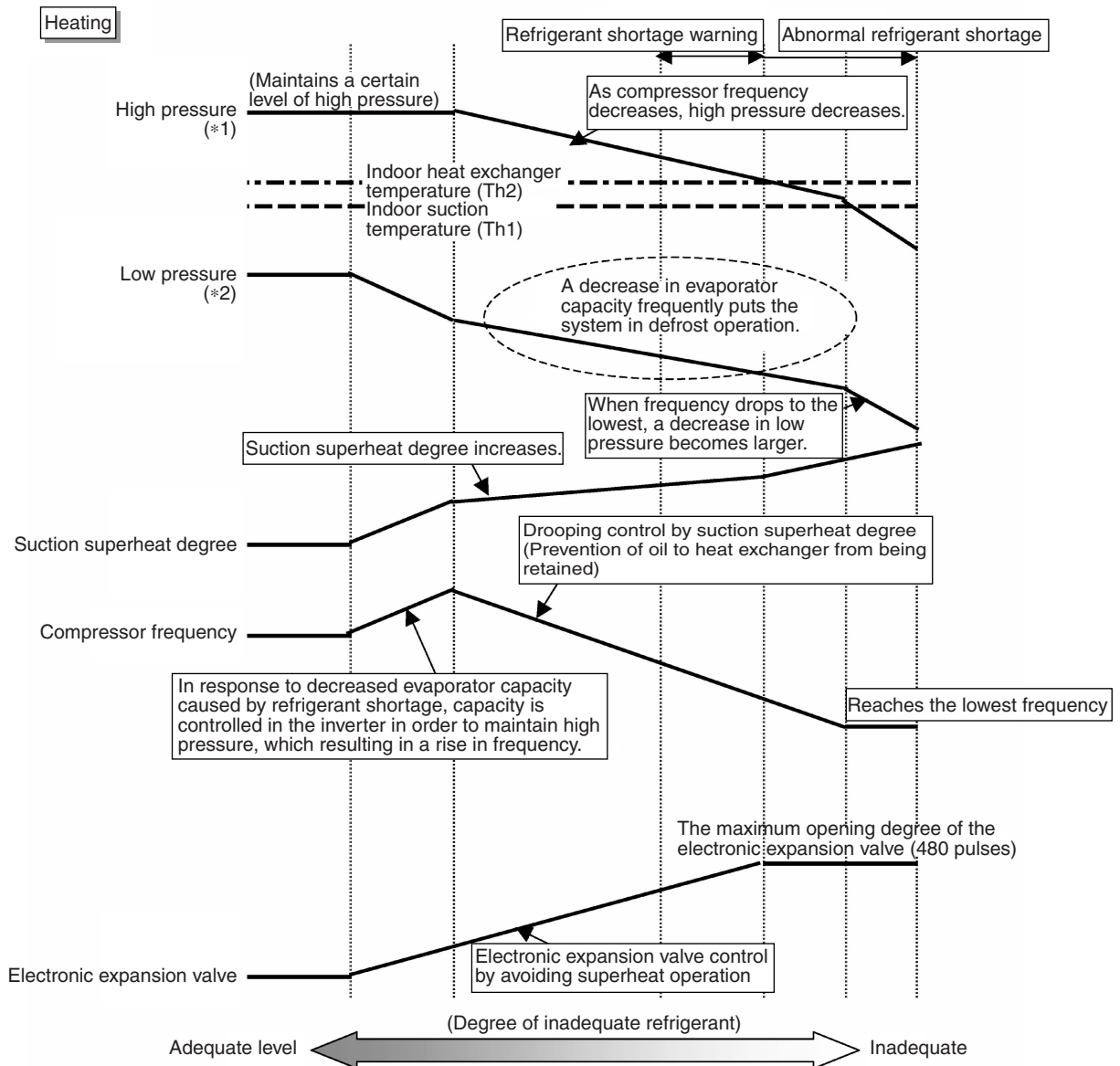

Heating

*1 High Pressure	Pressure sensor
*2 Low Pressure	Intermediate heat exchanger thermistor (*3)

*3 This measured temperature is used to calculate the equivalent saturation pressure of the refrigerant. (Refer to P.183.)

Part 8

Appendix

1. Piping Diagrams.....	179
1.1 RZQG71LV1B	179
1.2 RZQG100-140LV1B	179
2. Wiring Diagrams.....	180
2.1 Indoor Unit.....	180
2.2 Outdoor Unit.....	181
3. Precautions for New Refrigerant (R-410A)	182
3.1 Outline	182
3.2 Refrigerant Cylinders.....	184
3.3 Service Tools.....	185

1. Piping Diagrams

1.1 RZQG71LV1B

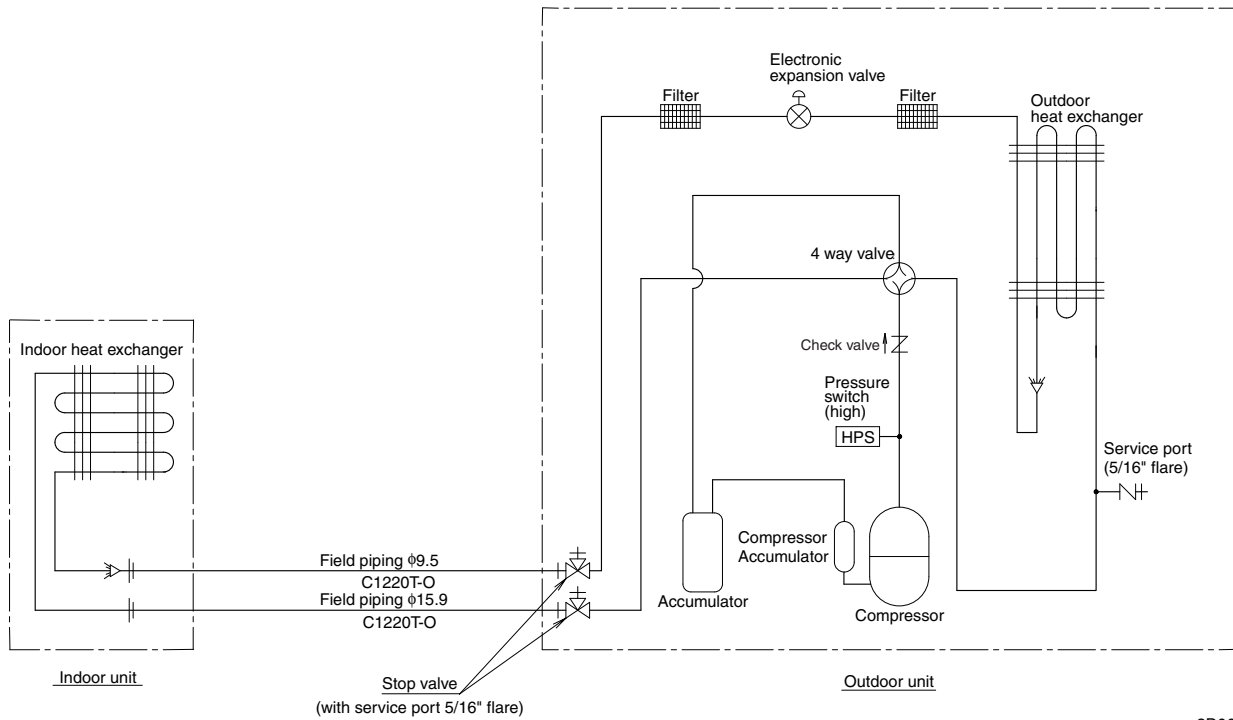

1.2 RZQG100-140LV1B

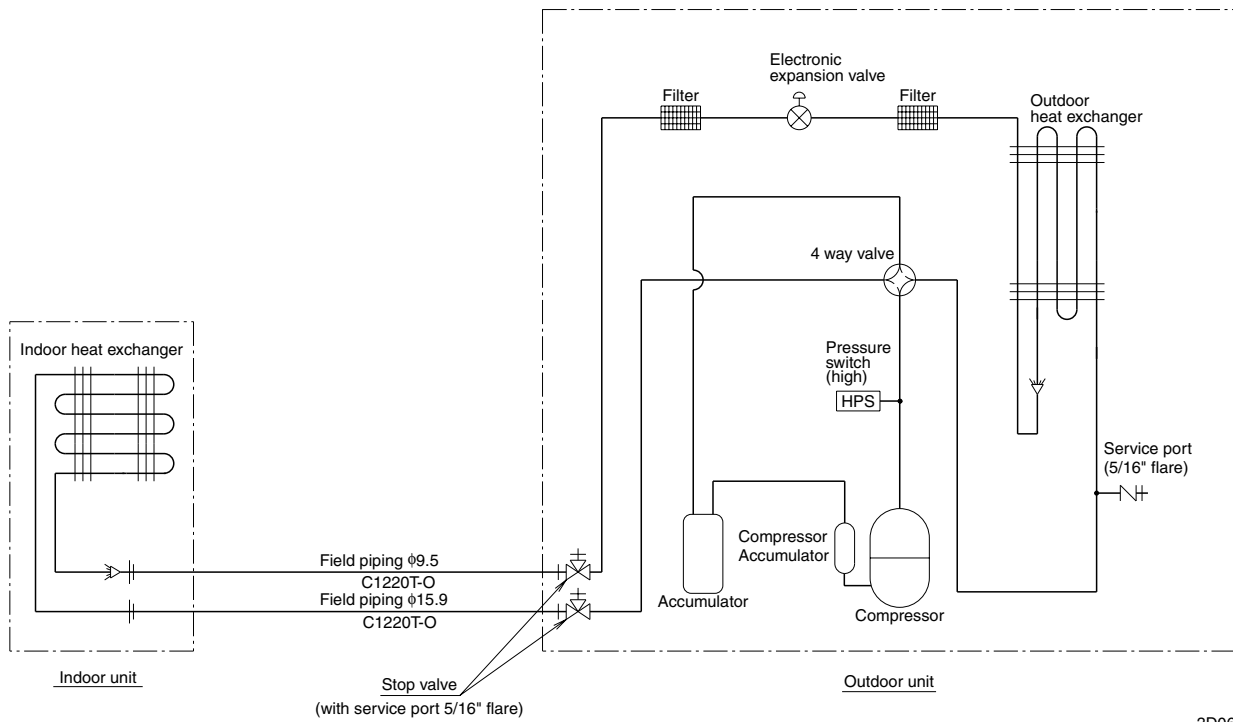

2. Wiring Diagrams

2.1 Indoor Unit

2.1.1 FCQG71-140EVEB

INDOOR UNIT	
A1P	PRINTED CIRCUIT BOARD
A2P	PRINTED CIRCUIT BOARD
A3P	PRINTED CIRCUIT BOARD (HUMIDITY SENSOR UNIT)
C21	CAPACITOR
C105	CAPACITOR
HAP	LIGHT EMITTING DIODE (SERVICE MONITOR GREEN)
M1F	MOTOR(INDOOR FAN)
M1P	MOTOR(DRAIN PUMP)
M1S	MOTOR(SWING FLAP)
M4S	MOTOR(SWING FLAP)
R1T	THERMISTOR(AIR)
R2T,R3T	THERMISTOR(COIL)
S1L	FLOAT SWITCH
SS1	SELECTOR SWITCH(EMERGENCY)
V1R	DIODE BRIDGE
X1M	TERMINAL STRIP
X2M	TERMINAL STRIP
Z1C	FERRITE CORE(NOISE FILTER)
Z1F	NOISE FILTER
(PS)	POWER SUPPLY CIRCUIT
(RC)	SIGNAL RECEIVER CIRCUIT
(TC)	SIGNAL TRANSMISSION CIRCUIT
WIRED REMOTE CONTROLLER	
R1T	THERMISTOR(AIR)
ADAPTOR FOR WIRING	
F1U	FUSE(⊕, 5A, 250V)
F2U	FUSE(⊕, 3.15A, 250V)
KCR	MAGNETIC RELAY
KFR	MAGNETIC RELAY
KHuR	MAGNETIC RELAY(Hu)
CONNECTOR FOR OPTIONAL PARTS	
X33A	CONNECTOR (ADAPTOR FOR WIRING)
X35A	CONNECTOR(GROUP CONTROL ADAPTOR)

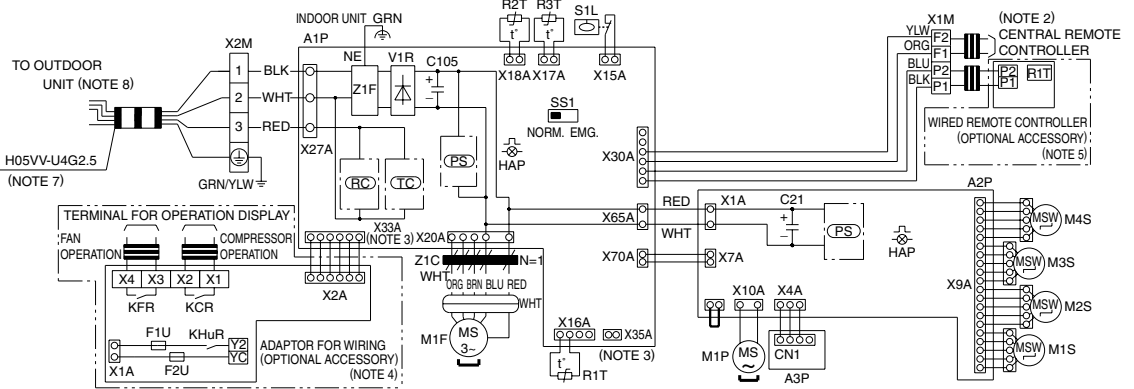

- NOTES
- : TERMINAL ⊕: CONNECTOR ⊕: FIELD WIRING
 - IN CASE USING CENTRAL REMOTE CONTROLLER, CONNECT IT TO THE UNIT IN ACCORDANCE WITH THE ATTACHED INSTALLATION MANUAL.
 - X33A, X35A ARE CONNECTED WHEN THE OPTIONAL ACCESSORIES ARE BEING USED.
 - CONNECT POWER OF ADAPTOR FOR WIRING TO TERMINAL BLOCK(X2M) OF INDOOR UNIT DIRECTLY.
 - IN CASE OF MAIN/SUB OVERCHARGE, SEE THE INSTALLATION MANUAL ATTACHED TO REMOTE CONTROLLER.
 - SYMBOLS SHOWS AS FOLLOWS: RED:RED BLK:BLACK WHT:WHITE YLW:YELLOW GRN:GREEN ORG:ORANGE BRN:BROWN PNK:PINK GRY:GRAY BLU:BLUE
 - SHOWS ONLY IN CASE OF PROTECTED PIPES. USE H07RN-F IN CASE OF NO PROTECTION.
 - MODEL OUTDOOR UNIT SHOWN IN THIS DIAGRAM SHOWS THE OUTLINE OF PRODUCT. FOR THE DETAIL, SEE WIRING DIAGRAM ATTACHED TO OUTDOOR UNIT.

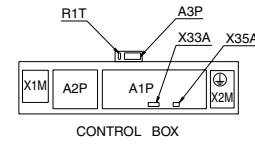

3D069625

2.1.2 FHQG71-140CVEB

INDOOR UNIT	
A1P	PRINTED CIRCUIT BOARD
A2P	PRINTED CIRCUIT BOARD
A3P	PRINTED CIRCUIT BOARD (HUMIDITY SENSOR UNIT)
C21	CAPACITOR
C105	CAPACITOR
F1U	FUSE(T.3, 1.5A, 250V)
F2U	FUSE(T.3, 1.5A, 250V)
HAP	LIGHT EMITTING DIODE (SERVICE MONITOR GREEN)
H3P	LIGHT EMITTING DIODE (FILTER SIGN-RED)
H4P	LIGHT EMITTING DIODE (DEFROST-ORANGE)
H5P	LIGHT EMITTING DIODE (ELEMENT WASHING-RED)
H6P	LIGHT EMITTING DIODE (VENTILATION CLEAN-GREEN)
M1F	MOTOR(INDOOR FAN)
M1S	MOTOR(SWING FLAP)
R1T	THERMISTOR(AIR)
R2T,R3T	THERMISTOR(COIL)
SS1	SELECTOR SWITCH
SS2	SELECTOR SWITCH (WIRELESS ADDRESS SET)
SS3	SELECTOR SWITCH(EMERGENCY)
V1R	DIODE BRIDGE
X1M	TERMINAL BLOCK
X2M	TERMINAL BLOCK
Z1C	FERRITE CORE(NOISE FILTER)
Z1F	NOISE FILTER
(PS)	POWER SUPPLY CIRCUIT
(RC)	SIGNAL RECEIVER CIRCUIT
(TC)	SIGNAL TRANSMISSION CIRCUIT
WIRED REMOTE CONTROLLER	
R1T	THERMISTOR(AIR)
WIRELESS REMOTE CONTROLLER (RECEIVER/DISPLAY UNIT)	
A2P	PRINTED CIRCUIT BOARD
A3P	PRINTED CIRCUIT BOARD
BS1	PUSH BUTTON(ON/OFF)
H1P	LIGHT EMITTING DIODE(ON-RED)
H2P	LIGHT EMITTING DIODE (TIMER-GREEN)

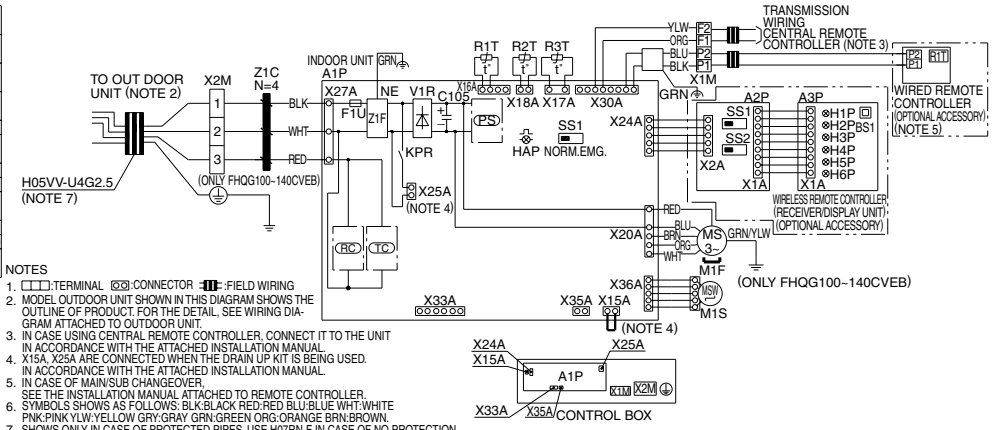

- NOTES
- : TERMINAL ⊕: CONNECTOR ⊕: FIELD WIRING
 - MODEL OUTDOOR UNIT SHOWN IN THIS DIAGRAM SHOWS THE OUTLINE OF PRODUCT. FOR THE DETAIL, SEE WIRING DIAGRAM ATTACHED TO OUTDOOR UNIT.
 - IN CASE USING CENTRAL REMOTE CONTROLLER, CONNECT IT TO THE UNIT IN ACCORDANCE WITH THE ATTACHED INSTALLATION MANUAL.
 - X15A, X25A ARE CONNECTED WHEN THE DRAIN UP KIT IS BEING USED. IN ACCORDANCE WITH THE ATTACHED INSTALLATION MANUAL.
 - IN CASE OF MAIN/SUB OVERCHARGE, SEE THE INSTALLATION MANUAL ATTACHED TO REMOTE CONTROLLER.
 - SYMBOLS SHOWS AS FOLLOWS: BLK:BLACK RED:RED BLU:BLUE WHT:WHITE PNK:PINK YLW:YELLOW GRY:GRAY GRN:GREEN ORG:ORANGE BRN:BROWN
 - SHOWS ONLY IN CASE OF PROTECTED PIPES. USE H07RN-F IN CASE OF NO PROTECTION.

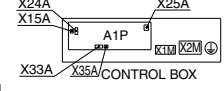

3D069266A

2.2 Outdoor Unit

2.2.1 RZQG71LV1B

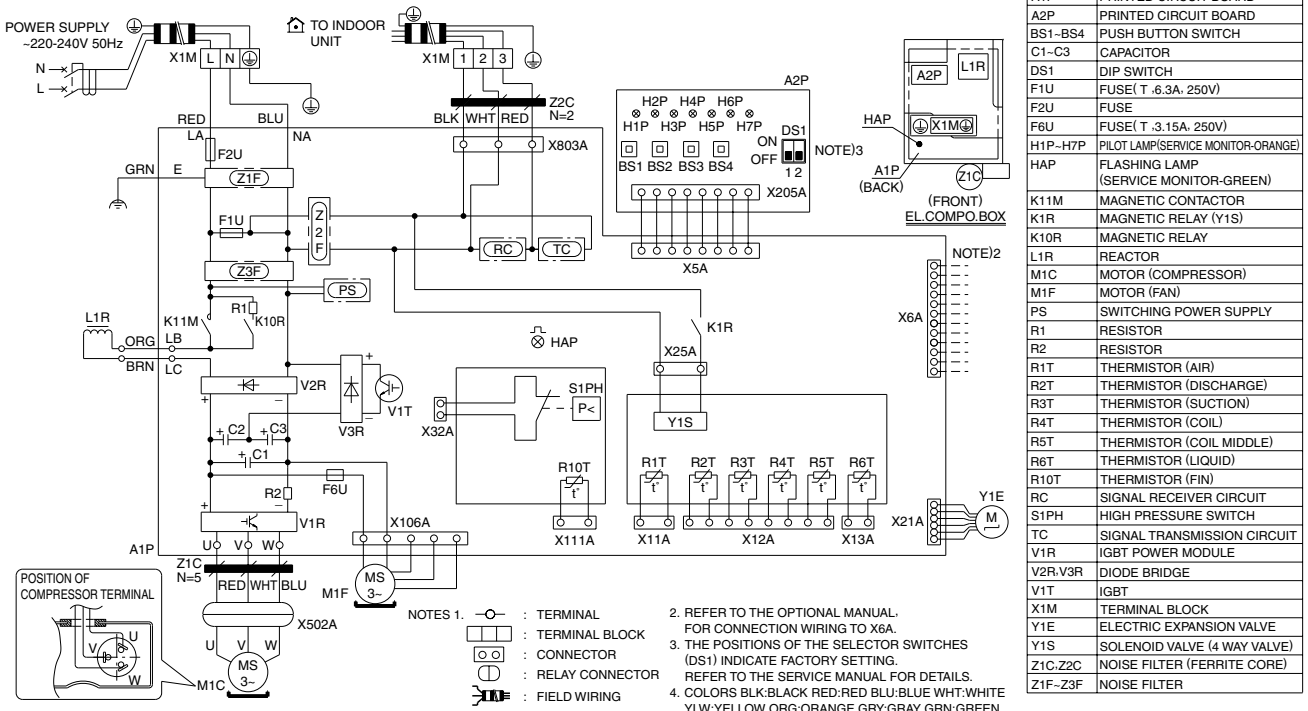

3D068608

2.2.2 RZQG100-140LV1B

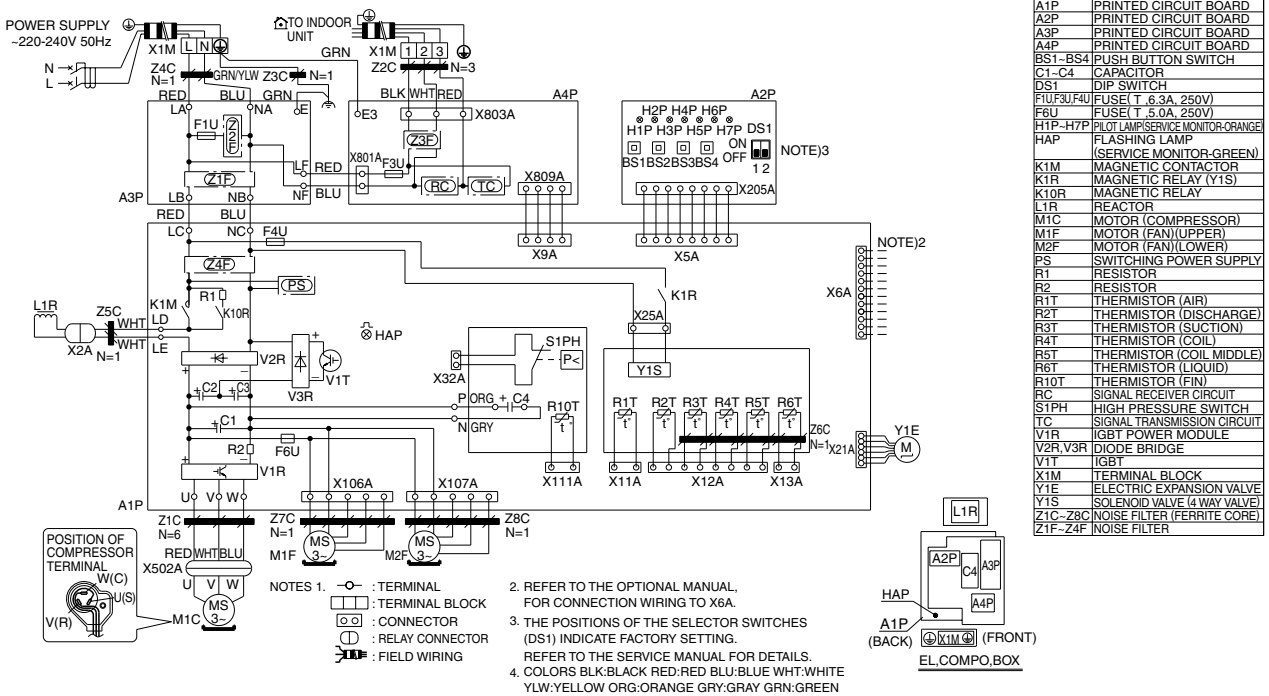

3D069265

3. Precautions for New Refrigerant (R-410A)

3.1 Outline

3.1.1 About Refrigerant R-410A

- Characteristics of new refrigerant, R-410A
 1. Performance
Almost the same performance as R-22 and R-407C
 2. Pressure
Working pressure is approx. 1.4 times more than R-22 and R-407C.
 3. Refrigerant composition
Few problems in composition control, since it is a Quasi-azeotropic mixture refrigerant.

	HFC units (Units using new refrigerants)		HCFC units
Refrigerant name	R-407C	R-410A	R-22
Composing substances	Non-azeotropic mixture of HFC32, HFC125 and HFC134a (*1)	Quasi-azeotropic mixture of HFC32 and HFC125 (*1)	Single-component refrigerant
Design pressure	3.2 MPa (gauge pressure) = 32.6 kgf/cm ²	4.0 MPa (gauge pressure) = 40.8 kgf/cm ²	2.75MPa (gauge pressure) = 28.0 kgf/cm ²
Refrigerant oil	Synthetic oil (Ether)		Mineral oil (Suniso)
Ozone destruction factor (ODP)	0	0	0.05
Combustibility	None	None	None
Toxicity	None	None	None

- *1. Non-azeotropic mixture refrigerant: mixture of 2 or more refrigerants having different boiling points.
- *2. Quasi-azeotropic mixture refrigerant: mixture of 2 or more refrigerants having similar boiling points.
- *3. The design pressure is different at each product. Please refer to the installation manual for each product.

(Reference) 1 MPa ≒ 10.19716 kgf / cm²

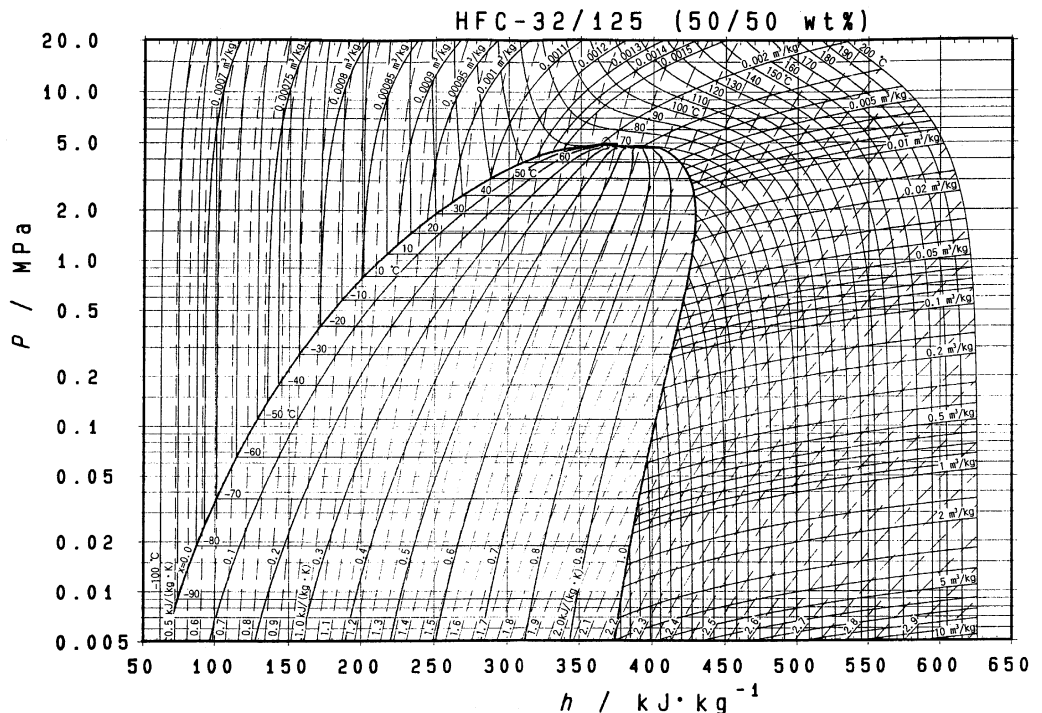

■ Thermodynamic characteristic of R-410A

DAIREP ver2.0

Temperature (°C)	Steam pressure (kPa)		Density (kg/m ³)		Specific heat at constant pressure (kJ/kgK)		Specific enthalpy (kJ/kg)		Specific entropy (kJ/KgK)	
	Liquid	Vapor	Liquid	Vapor	Liquid	Vapor	Liquid	Vapor	Liquid	Vapor
-70	36.13	36.11	1410.7	1.582	1.372	0.695	100.8	390.6	0.649	2.074
-68	40.83	40.80	1404.7	1.774	1.374	0.700	103.6	391.8	0.663	2.066
-66	46.02	45.98	1398.6	1.984	1.375	0.705	106.3	393.0	0.676	2.058
-64	51.73	51.68	1392.5	2.213	1.377	0.710	109.1	394.1	0.689	2.051
-62	58.00	57.94	1386.4	2.463	1.378	0.715	111.9	395.3	0.702	2.044
-60	64.87	64.80	1380.2	2.734	1.379	0.720	114.6	396.4	0.715	2.037
-58	72.38	72.29	1374.0	3.030	1.380	0.726	117.4	397.6	0.728	2.030
-56	80.57	80.46	1367.8	3.350	1.382	0.732	120.1	398.7	0.741	2.023
-54	89.49	89.36	1361.6	3.696	1.384	0.737	122.9	399.8	0.754	2.017
-52	99.18	99.03	1355.3	4.071	1.386	0.744	125.7	400.9	0.766	2.010
-51.58	101.32	101.17	1354.0	4.153	1.386	0.745	126.3	401.1	0.769	2.009
-50	109.69	109.51	1349.0	4.474	1.388	0.750	128.5	402.0	0.779	2.004
-48	121.07	120.85	1342.7	4.909	1.391	0.756	131.2	403.1	0.791	1.998
-46	133.36	133.11	1336.3	5.377	1.394	0.763	134.0	404.1	0.803	1.992
-44	146.61	146.32	1330.0	5.880	1.397	0.770	136.8	405.2	0.816	1.987
-42	160.89	160.55	1323.5	6.419	1.401	0.777	139.6	406.2	0.828	1.981
-40	176.24	175.85	1317.0	6.996	1.405	0.785	142.4	407.3	0.840	1.976
-38	192.71	192.27	1310.5	7.614	1.409	0.792	145.3	408.3	0.852	1.970
-36	210.37	209.86	1304.0	8.275	1.414	0.800	148.1	409.3	0.864	1.965
-34	229.26	228.69	1297.3	8.980	1.419	0.809	150.9	410.2	0.875	1.960
-32	249.46	248.81	1290.6	9.732	1.424	0.817	153.8	411.2	0.887	1.955
-30	271.01	270.28	1283.9	10.53	1.430	0.826	156.6	412.1	0.899	1.950
-28	293.99	293.16	1277.1	11.39	1.436	0.835	159.5	413.1	0.911	1.946
-26	318.44	317.52	1270.2	12.29	1.442	0.844	162.4	414.0	0.922	1.941
-24	344.44	343.41	1263.3	13.26	1.448	0.854	165.3	414.9	0.934	1.936
-22	372.05	370.90	1256.3	14.28	1.455	0.864	168.2	415.7	0.945	1.932
-20	401.34	400.06	1249.2	15.37	1.461	0.875	171.1	416.6	0.957	1.927
-18	432.36	430.95	1242.0	16.52	1.468	0.886	174.1	417.4	0.968	1.923
-16	465.20	463.64	1234.8	17.74	1.476	0.897	177.0	418.2	0.980	1.919
-14	499.91	498.20	1227.5	19.04	1.483	0.909	180.0	419.0	0.991	1.914
-12	536.58	534.69	1220.0	20.41	1.491	0.921	182.9	419.8	1.003	1.910
-10	575.26	573.20	1212.5	21.86	1.499	0.933	185.9	420.5	1.014	1.906
-8	616.03	613.78	1204.9	23.39	1.507	0.947	189.0	421.2	1.025	1.902
-6	658.97	656.52	1197.2	25.01	1.516	0.960	192.0	421.9	1.036	1.898
-4	704.15	701.49	1189.4	26.72	1.524	0.975	195.0	422.6	1.048	1.894
-2	751.64	748.76	1181.4	28.53	1.533	0.990	198.1	423.2	1.059	1.890
0	801.52	798.41	1173.4	30.44	1.543	1.005	201.2	423.8	1.070	1.886
2	853.87	850.52	1165.3	32.46	1.552	1.022	204.3	424.4	1.081	1.882
4	908.77	905.16	1157.0	34.59	1.563	1.039	207.4	424.9	1.092	1.878
6	966.29	962.42	1148.6	36.83	1.573	1.057	210.5	425.5	1.103	1.874
8	1026.5	1022.4	1140.0	39.21	1.584	1.076	213.7	425.9	1.114	1.870
10	1089.5	1085.1	1131.3	41.71	1.596	1.096	216.8	426.4	1.125	1.866
12	1155.4	1150.7	1122.5	44.35	1.608	1.117	220.0	426.8	1.136	1.862
14	1224.3	1219.2	1113.5	47.14	1.621	1.139	223.2	427.2	1.147	1.859
16	1296.2	1290.8	1104.4	50.09	1.635	1.163	226.5	427.5	1.158	1.855
18	1371.2	1365.5	1095.1	53.20	1.650	1.188	229.7	427.8	1.169	1.851
20	1449.4	1443.4	1085.6	56.48	1.666	1.215	233.0	428.1	1.180	1.847
22	1530.9	1524.6	1075.9	59.96	1.683	1.243	236.4	428.3	1.191	1.843
24	1615.8	1609.2	1066.0	63.63	1.701	1.273	239.7	428.4	1.202	1.839
26	1704.2	1697.2	1055.9	67.51	1.721	1.306	243.1	428.6	1.214	1.834
28	1796.2	1788.9	1045.5	71.62	1.743	1.341	246.5	428.6	1.225	1.830
30	1891.9	1884.2	1034.9	75.97	1.767	1.379	249.9	428.6	1.236	1.826
32	1991.3	1983.2	1024.1	80.58	1.793	1.420	253.4	428.6	1.247	1.822
34	2094.5	2086.2	1012.9	85.48	1.822	1.465	256.9	428.4	1.258	1.817
36	2201.7	2193.1	1001.4	90.68	1.855	1.514	260.5	428.3	1.269	1.813
38	2313.0	2304.0	989.5	96.22	1.891	1.569	264.1	428.0	1.281	1.808
40	2428.4	2419.2	977.3	102.1	1.932	1.629	267.8	427.7	1.292	1.803
42	2548.1	2538.6	964.6	108.4	1.979	1.696	271.5	427.2	1.303	1.798
44	2672.2	2662.4	951.4	115.2	2.033	1.771	275.3	426.7	1.315	1.793
46	2800.7	2790.7	937.7	122.4	2.095	1.857	279.2	426.1	1.327	1.788
48	2933.7	2923.6	923.3	130.2	2.168	1.955	283.2	425.4	1.339	1.782
50	3071.5	3061.2	908.2	138.6	2.256	2.069	287.3	424.5	1.351	1.776
52	3214.0	3203.6	892.2	147.7	2.362	2.203	291.5	423.5	1.363	1.770
54	3361.4	3351.0	875.1	157.6	2.493	2.363	295.8	422.4	1.376	1.764
56	3513.8	3503.5	856.8	168.4	2.661	2.557	300.3	421.0	1.389	1.757
58	3671.3	3661.2	836.9	180.4	2.883	2.799	305.0	419.4	1.403	1.749
60	3834.1	3824.2	814.9	193.7	3.191	3.106	310.0	417.6	1.417	1.741
62	4002.1	3992.7	790.1	208.6	3.650	3.511	315.3	415.5	1.433	1.732
64	4175.7	4166.8	761.0	225.6	4.415	4.064	321.2	413.0	1.450	1.722

3.2 Refrigerant Cylinders

- Cylinder specifications
 - The cylinder is painted refrigerant color (pink).
 - The cylinder valve is equipped with a siphon tube.

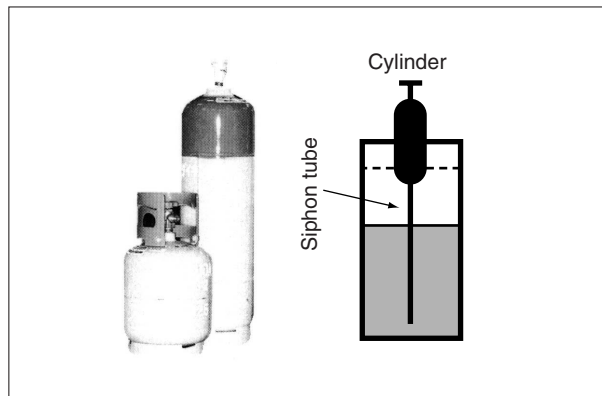

Refrigerant can be charged in liquid state with cylinder in upright position.

Caution: Do not lay cylinder on its side during charging, since it cause refrigerant in gas state to enter the system.

- Handling of cylinders

- (1) Laws and regulations

R-410A is liquefied gas, and the High Pressure Gas Safety Law must be observed in handling them. Before using, refer to the High Pressure Gas Safety Law.

The Law stipulates standards and regulations that must be followed to prevent accidents with high pressure gases. Be sure to follow the regulations.

- (2) Handling of vessels

Since R-410A is high pressure gas, it is contained in high pressure vessels.

Although those vessels are durable and strong, careless handling can cause damage that can lead to unexpected accidents. Do not drop vessels, let them fall, apply impact or roll them on the ground.

- (3) Storage

Although R-410A is not flammable, it must be stored in a well-ventilated, cool, and dark place in the same way as any other high pressure gases.

It should also be noted that high pressure vessels are equipped with safety devices that releases gas when the ambient temperature reaches more than a certain level (fusible plug melts) and when the pressure exceeds a certain level (spring-type safety valve operates).

3.3 Service Tools

R-410A is used under higher working pressure, compared to previous refrigerants (R-22, R-407C). Furthermore, the refrigerating machine oil has been changed from Suniso oil to Ether oil, and if oil mixing is occurred, sludge results in the refrigerants and causes other problems. Therefore, gauge manifolds and charge hoses that are used with a previous refrigerant (R-22, R-407C) can not be used for products that use new refrigerants.

Be sure to use dedicated tools and devices.

■ Tool compatibility

Tool	Compatibility			Reasons for change
	HFC		HCFC	
	R-410A	R-407C	R-22	
Gauge manifold Charge hose	×			<ul style="list-style-type: none"> Do not use the same tools for R-22 and R-410A. Thread specification differs for R-410A and R-407C.
Charging cylinder	×		○	<ul style="list-style-type: none"> Weighting instrument used for HFCs.
Gas detector	○		×	<ul style="list-style-type: none"> The same tool can be used for HFCs.
Vacuum pump (pump with reverse flow preventive function)		○		<ul style="list-style-type: none"> To use existing pump for HFCs, vacuum pump adaptor must be installed.
Weighting instrument		○		
Charge mouthpiece		×		<ul style="list-style-type: none"> Seal material is different between R-22 and HFCs. Thread specification is different between R-410A and others.
Flaring tool (Clutch type)		○		<ul style="list-style-type: none"> For R-410A, flare gauge is necessary.
Torque wrench		○		<ul style="list-style-type: none"> Torque-up for 1/2 and 5/8
Pipe cutter		○		
Pipe expander		○		
Pipe bender		○		
Pipe assembling oil		×		<ul style="list-style-type: none"> Due to refrigerating machine oil change. (No Suniso oil can be used.)
Refrigerant recovery device	Check your recovery device.			
Refrigerant piping	See the chart below.			<ul style="list-style-type: none"> Only f19.1 is changed to 1/2H material while the previous material is "O".

As for the charge mouthpiece and packing, 1/2UNF20 is necessary for mouthpiece size of charge hose.

■ Copper tube material and thickness

Pipe size	R-407C		R-410A	
	Material	Thickness t (mm)	Material	Thickness t (mm)
φ6.4	O	0.8	O	0.8
φ9.5	O	0.8	O	0.8
φ12.7	O	0.8	O	0.8
φ15.9	O	1.0	O	1.0
φ19.1	O	1.0	1/2H	1.0

* O: Soft (Annealed)

H: Hard (Drawn)

1. Flaring tool



- Specifications
- Dimension A

Unit:mm

Nominal size	Tube O.D. Do	A ⁺⁰ _{-0.4}	
		Class-2 (R-410A)	Class-1 (Conventional)
1/4	6.35	9.1	9.0
3/8	9.52	13.2	13.0
1/2	12.70	16.6	16.2
5/8	15.88	19.7	19.4
3/4	19.05	24.0	23.3

- Differences
- Change of dimension A

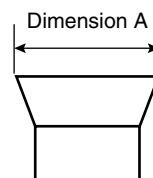

For class-1: R-407C
For class-2: R-410A

Conventional flaring tools can be used when the work process is changed.
(change of work process)

Previously, a pipe extension margin of 0 to 0.5 mm was provided for flaring. For R-410A air conditioners, perform pipe flaring with a pipe extension margin of 1.0 to 1.5 mm.
(For clutch type only)

Conventional tool with pipe extension margin adjustment can be used.

2. Torque wrench



■ Specifications

• Dimension B

Unit:mm

Nominal size	Class-1	Class-2	Previous
1/2	24	26	24
5/8	27	29	27

No change in tightening torque

No change in pipes of other sizes

■ Differences

- Change of dimension B
Only 1/2", 5/8" are extended

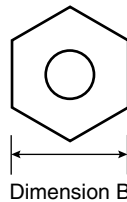

For class-1: R-407C
For class-2: R-410A

3. Vacuum pump with check valve

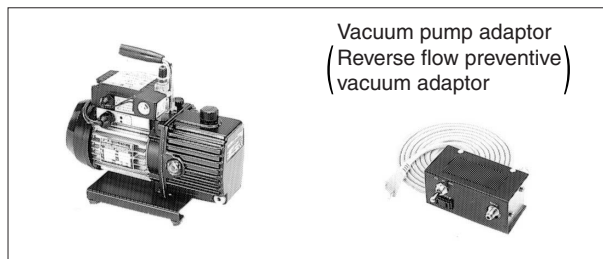

Vacuum pump adaptor
(Reverse flow preventive)
vacuum adaptor

■ Specifications

- Discharge speed
50 l/min (50 Hz)
60 l/min (60 Hz)
- Suction port UNF7/16-20(1/4 Flare)
UNF1/2-20(5/16 Flare) with adaptor
- Maximum degree of vacuum
Select a vacuum pump which is able to keep the vacuum degree of the system in excess of -100.7 kPa (5 torr – 755 mmHg).

■ Differences

- Equipped with function to prevent reverse oil flow
- Previous vacuum pump can be used by installing adaptor.

4. Leak tester



- Specifications
 - Hydrogen detecting type, etc.
 - Applicable refrigerants
R-410A, R-407C, R-404A, R-507A, R-134a, etc.
- Differences
 - Previous testers detected chlorine. Since HFCs do not contain chlorine, new tester detects hydrogen.

5. Refrigerant oil (Air compal)



- Specifications
 - Contains synthetic oil, therefore it can be used for piping work of every refrigerant cycle.
 - Offers high rust resistance and stability over long period of time.
- Differences
 - Can be used for R-410A and R-22 units.

6. Gauge manifold for R-410A



- Specifications
 - High pressure gauge
- 0.1 to 5.3 MPa (-76 cmHg to 53 kg/cm²)
 - Low pressure gauge
- 0.1 to 3.8 MPa (-76 cmHg to 38 kg/cm²)
 - 1/4" → 5/16" (2 min → 2.5 min)
 - No oil is used in pressure test of gauges.
→ For prevention of contamination

- Temperature scale indicates the relationship between pressure and temperature in gas saturated state.
- Differences
 - Change in pressure
 - Change in service port diameter

7. Charge hose for R-410A

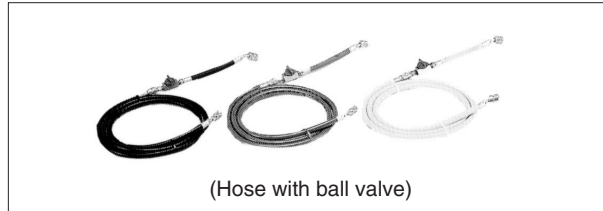

- Specifications
 - Working pressure 5.08 MPa (51.8 kg/cm²)
 - Rupture pressure 25.4 MPa (259 kg/cm²)
 - Available with and without hand-operate valve that prevents refrigerant from outflow.
- Differences
 - Pressure proof hose
 - Change in service port diameter
 - Use of nylon coated material for HFC resistance

8. Charging cylinder

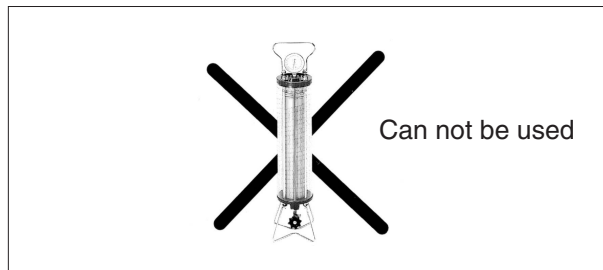

- Specifications
 - Use weigher for refrigerant charge listed below to charge directly from refrigerant cylinder.
- Differences
 - The cylinder can not be used for mixed refrigerant since mixing ratio is changed during charging.

When R-410A is charged in liquid state using charging cylinder, foaming phenomenon is generated inside charging cylinder.

9. Weigher for refrigerant charge



- Specifications
 - High accuracy
 - TA101A (for 10-kg cylinder) = $\pm 2\text{g}$
 - TA101B (for 20-kg cylinder) = $\pm 5\text{g}$
 - Equipped with pressure-resistant sight glass to check liquid refrigerant charging.
 - A manifold with separate ports for HFCs and previous refrigerants is equipped as standard accessories.
- Differences
 - Measurement is based on weight to prevent change of mixing ratio during charging.

10. Charge mouthpiece



- Specifications
 - For R-410A, 1/4" → 5/16" (2 min → 2.5 min)
 - Material is changed from CR to H-NBR.
- Differences
 - Change of thread specification on hose connection side (For the R-410A use)
 - Change of sealer material for the HFCs use.



- Daikin Industries, Ltd.'s products are manufactured for export to numerous countries throughout the world. Daikin Industries, Ltd. does not have control over which products are exported to and used in a particular country. Prior to purchase, please therefore confirm with your local authorised importer, distributor and/or retailer whether this product conforms to the applicable standards, and is suitable for use, in the region where the product will be used. This statement does not purport to exclude, restrict or modify the application of any local legislation.
- Ask a qualified installer or contractor to install this product. Do not try to install the product yourself. Improper installation can result in water or refrigerant leakage, electrical shock, fire or explosion.
- Use only those parts and accessories supplied or specified by Daikin. Ask a qualified installer or contractor to install those parts and accessories. Use of unauthorised parts and accessories or improper installation of parts and accessories can result in water or refrigerant leakage, electrical shock, fire or explosion.
- Read the User's Manual carefully before using this product. The User's Manual provides important safety instructions and warnings. Be sure to follow these instructions and warnings.

If you have any enquiries, please contact your local importer, distributor and/or retailer.

Cautions on product corrosion

1. Air conditioners should not be installed in areas where corrosive gases, such as acid gas or alkaline gas, are produced.
2. If the outdoor unit is to be installed close to the sea shore, direct exposure to the sea breeze should be avoided. If you need to install the outdoor unit close to the sea shore, contact your local distributor.



JMI-0107

Organization:
DAIKIN INDUSTRIES, LTD.
AIR CONDITIONING MANUFACTURING DIVISION

Scope of Registration:
THE DESIGN/DEVELOPMENT AND MANUFACTURE OF COMMERCIAL AIR CONDITIONING, HEATING, COOLING, REFRIGERATING EQUIPMENT, COMMERCIAL HEATING EQUIPMENT, RESIDENTIAL AIR CONDITIONING EQUIPMENT, HEAT RECLAIM VENTILATION, AIR CLEANING EQUIPMENT, MARINE TYPE CONTAINER REFRIGERATION UNITS, COMPRESSORS AND VALVES.



JQA-1452

Organization:
DAIKIN INDUSTRIES
(THAILAND) LTD.

Scope of Registration:
THE DESIGN/DEVELOPMENT AND MANUFACTURE OF AIR CONDITIONERS AND THE COMPONENTS INCLUDING COMPRESSORS USED FOR THEM



EC99J2044

All of the Daikin Group's business facilities and subsidiaries in Japan are certified under the ISO 14001 international standard for environment management.

Dealer

DAIKIN INDUSTRIES, LTD.

Head Office:
Umeda Center Bldg., 2-4-12, Nakazaki-Nishi,
Kita-ku, Osaka, 530-8323 Japan

Tokyo Office:
JR Shinagawa East Bldg., 2-18-1, Konan,
Minato-ku, Tokyo, 108-0075 Japan

http://www.daikin.com/global_ac/

© All rights reserved