

**DAIKIN**

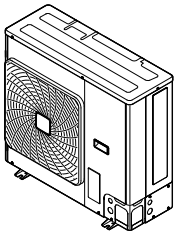

# Installer reference guide

## Sky Air Advance-series



**RZASG71M2V1B**  
**RZASG100M7V1B**  
**RZASG125M7V1B**  
**RZASG140M7V1B**

**RZASG100M7Y1B**  
**RZASG125M7Y1B**  
**RZASG140M7Y1B**









Installer reference guide  
Sky Air Advance-series



English

## Table of contents

<b>1</b>	<b>General safety precautions</b>	<b>2</b>	6.5.4	To check for leaks	16
1.1	About the documentation	2	6.5.5	To perform vacuum drying	17
1.1.1	Meaning of warnings and symbols	3	6.6	Charging refrigerant	17
1.2	For the installer	3	6.6.1	About charging refrigerant	17
1.2.1	General	3	6.6.2	About the refrigerant	18
1.2.2	Installation site	3	6.6.3	Precautions when charging refrigerant	18
1.2.3	Refrigerant	4	6.6.4	Definitions: L1~L7, H1, H2	18
1.2.4	Brine	4	6.6.5	To determine the additional refrigerant amount	18
1.2.5	Water	4	6.6.6	To determine the complete recharge amount	19
1.2.6	Electrical	5	6.6.7	Charging refrigerant: Setup	19
<b>2</b>	<b>About the documentation</b>	<b>5</b>	6.6.8	To charge additional refrigerant	19
2.1	About this document	5	6.6.9	To activate/deactivate the vacuum mode field setting	19
2.2	Installer reference guide at a glance	6	6.6.10	To completely recharge refrigerant	20
<b>3</b>	<b>About the box</b>	<b>6</b>	6.6.11	To fix the fluorinated greenhouse gases label	20
3.1	Overview: About the box	6	6.7	Connecting the electrical wiring	20
3.2	Outdoor unit	6	6.7.1	About connecting the electrical wiring	20
3.2.1	To unpack the outdoor unit	6	6.7.2	About electrical compliance	20
3.2.2	To handle the outdoor unit	6	6.7.3	Precautions when connecting the electrical wiring	20
3.2.3	To remove the accessories from the outdoor unit	6	6.7.4	Guidelines when connecting the electrical wiring	20
<b>4</b>	<b>About the units and options</b>	<b>7</b>	6.7.5	Specifications of standard wiring components	21
4.1	Overview: About the units and options	7	6.7.6	To connect the electrical wiring on the outdoor unit	21
4.2	Identification	7	6.8	Finishing the outdoor unit installation	22
4.2.1	Identification label: Outdoor unit	7	6.8.1	To finish the outdoor unit installation	22
4.3	Combining units and options	7	6.8.2	To close the outdoor unit	23
4.3.1	Possible options for the outdoor unit	7	6.8.3	To check the insulation resistance of the compressor	23
<b>5</b>	<b>Preparation</b>	<b>7</b>	<b>7</b>	<b>Commissioning</b>	<b>23</b>
5.1	Overview: Preparation	7	7.1	Overview: Commissioning	23
5.2	Preparing installation site	7	7.2	Precautions when commissioning	23
5.2.1	Installation site requirements of the outdoor unit	7	7.3	Checklist before commissioning	23
5.2.2	Additional installation site requirements of the outdoor unit in cold climates	9	7.4	To perform a test run	24
5.3	Preparing refrigerant piping	9	7.5	Error codes when performing a test run	24
5.3.1	Refrigerant piping requirements	9	<b>8</b>	<b>Hand-over to the user</b>	<b>25</b>
5.3.2	Refrigerant piping insulation	10	<b>9</b>	<b>Maintenance and service</b>	<b>25</b>
5.4	Preparing electrical wiring	10	9.1	Overview: Maintenance and service	25
5.4.1	About preparing electrical wiring	10	9.2	Maintenance safety precautions	25
<b>6</b>	<b>Installation</b>	<b>11</b>	9.2.1	To prevent electrical hazards	25
6.1	Overview: Installation	11	9.3	Checklist for yearly maintenance of the outdoor unit	26
6.2	Opening the units	11	<b>10</b>	<b>Troubleshooting</b>	<b>26</b>
6.2.1	About opening the units	11	10.1	Overview: Troubleshooting	26
6.2.2	To open the outdoor unit	11	10.2	Precautions when troubleshooting	26
6.3	Mounting the outdoor unit	11	<b>11</b>	<b>Disposal</b>	<b>26</b>
6.3.1	About mounting the outdoor unit	11	11.1	Overview: Disposal	26
6.3.2	Precautions when mounting the outdoor unit	11	11.2	About pump down	26
6.3.3	To provide the installation structure	11	11.3	To pump down	26
6.3.4	To install the outdoor unit	12	<b>12</b>	<b>Technical data</b>	<b>27</b>
6.3.5	To provide drainage	12	12.1	Overview: Technical data	27
6.3.6	To prevent the outdoor unit from falling over	12	12.2	Service space: Outdoor unit	27
6.4	Connecting the refrigerant piping	13	12.3	Piping diagram: Outdoor unit	28
6.4.1	About connecting the refrigerant piping	13	12.4	Wiring diagram: Outdoor unit	29
6.4.2	Precautions when connecting the refrigerant piping	13	<b>13</b>	<b>Glossary</b>	<b>30</b>
6.4.3	Guidelines when connecting the refrigerant piping	13	<b>1</b>	<b>General safety precautions</b>	
6.4.4	Pipe bending guidelines	14	<b>1.1</b>	<b>About the documentation</b>	
6.4.5	To flare the pipe end	14	<ul style="list-style-type: none"> <li>The original documentation is written in English. All other languages are translations.</li> <li>The precautions described in this document cover very important topics, follow them carefully.</li> <li>The installation of the system, and all activities described in the installation manual and the installer reference guide must be performed by an authorized installer.</li> </ul>		
6.4.6	To braze the pipe end	14			
6.4.7	Using the stop valve and service port	14			
6.4.8	To connect the refrigerant piping to the outdoor unit	15			
6.5	Checking the refrigerant piping	16			
6.5.1	About checking the refrigerant piping	16			
6.5.2	Precautions when checking the refrigerant piping	16			
6.5.3	Checking refrigerant piping: Setup	16			

## 1.1.1 Meaning of warnings and symbols



	<b>DANGER</b> Indicates a situation that results in death or serious injury.
	<b>DANGER: RISK OF ELECTROCUTION</b> Indicates a situation that could result in electrocution.
	<b>DANGER: RISK OF BURNING</b> Indicates a situation that could result in burning because of extreme hot or cold temperatures.
	<b>DANGER: RISK OF EXPLOSION</b> Indicates a situation that could result in explosion.
	<b>WARNING</b> Indicates a situation that could result in death or serious injury.
	<b>WARNING: FLAMMABLE MATERIAL</b>
	<b>CAUTION</b> Indicates a situation that could result in minor or moderate injury.
	<b>NOTICE</b> Indicates a situation that could result in equipment or property damage.
	<b>INFORMATION</b> Indicates useful tips or additional information.

Symbol	Explanation
	Before installation, read the installation and operation manual, and the wiring instruction sheet.
	Before performing maintenance and service tasks, read the service manual.
	For more information, see the installer and user reference guide.

## 1.2 For the installer

### 1.2.1 General

If you are not sure how to install or operate the unit, contact your dealer.

	<b>NOTICE</b> Improper installation or attachment of equipment or accessories could result in electric shock, short-circuit, leaks, fire or other damage to the equipment. Only use accessories, optional equipment and spare parts made or approved by Daikin.
	<b>WARNING</b> Make sure installation, testing and applied materials comply with applicable legislation (on top of the instructions described in the Daikin documentation).
	<b>CAUTION</b> Wear adequate personal protective equipment (protective gloves, safety glasses,...) when installing, maintaining or servicing the system.

	<b>WARNING</b> Tear apart and throw away plastic packaging bags so that nobody, especially children, can play with them. Possible risk: suffocation.
---	---

	<b>DANGER: RISK OF BURNING</b> <ul style="list-style-type: none"> <li>Do NOT touch the refrigerant piping, water piping or internal parts during and immediately after operation. It could be too hot or too cold. Give it time to return to normal temperature. If you must touch it, wear protective gloves.</li> <li>Do NOT touch any accidental leaking refrigerant.</li> </ul>
---	---

	<b>WARNING</b> Provide adequate measures to prevent that the unit can be used as a shelter by small animals. Small animals that make contact with electrical parts can cause malfunctions, smoke or fire.
---	--

	<b>CAUTION</b> Do NOT touch the air inlet or aluminium fins of the unit.
---	---

	<b>NOTICE</b> <ul style="list-style-type: none"> <li>Do NOT place any objects or equipment on top of the unit.</li> <li>Do NOT sit, climb or stand on the unit.</li> </ul>
---	--

	<b>NOTICE</b> Works executed on the outdoor unit are best done under dry weather conditions to avoid water ingress.
---	--

In accordance with the applicable legislation, it might be necessary to provide a logbook with the product containing at least: information on maintenance, repair work, results of tests, stand-by periods,...

Also, at least, following information must be provided at an accessible place at the product:

- Instructions for shutting down the system in case of an emergency
- Name and address of fire department, police and hospital
- Name, address and day and night telephone numbers for obtaining service

In Europe, EN378 provides the necessary guidance for this logbook.

### 1.2.2 Installation site

- Provide sufficient space around the unit for servicing and air circulation.
- Make sure the installation site withstands the unit's weight and vibration.
- Make sure the area is well ventilated. Do NOT block any ventilation openings.
- Make sure the unit is level.

Do NOT install the unit in the following places:

- In potentially explosive atmospheres.
- In places where there is machinery that emits electromagnetic waves. Electromagnetic waves may disturb the control system, and cause malfunction of the equipment.
- In places where there is a risk of fire due to the leakage of flammable gases (example: thinner or gasoline), carbon fibre, ignitable dust.
- In places where corrosive gas (example: sulphurous acid gas) is produced. Corrosion of copper pipes or soldered parts may cause the refrigerant to leak.

# 1 General safety precautions

## 1.2.3 Refrigerant

If applicable. See the installation manual or installer reference guide of your application for more information.

### NOTICE

Make sure refrigerant piping installation complies with applicable legislation. In Europe, EN378 is the applicable standard.

### NOTICE

Make sure the field piping and connections are not subjected to stress.

### WARNING

During tests, NEVER pressurize the product with a pressure higher than the maximum allowable pressure (as indicated on the nameplate of the unit).

### WARNING

Take sufficient precautions in case of refrigerant leakage. If refrigerant gas leaks, ventilate the area immediately. Possible risks:

- Excessive refrigerant concentrations in a closed room can lead to oxygen deficiency.
- Toxic gas may be produced if refrigerant gas comes into contact with fire.

### DANGER: RISK OF EXPLOSION

**Pump down – Refrigerant leakage.** If you want to pump down the system, and there is a leakage in the refrigerant circuit:

- Do NOT use the unit's automatic pump down function, with which you can collect all refrigerant from the system into the outdoor unit. **Possible consequence:** Self-combustion and explosion of the compressor because of air going into the operating compressor.
- Use a separate recovery system so that the unit's compressor does NOT have to operate.

### WARNING

Always recover the refrigerant. Do NOT release them directly into the environment. Use a vacuum pump to evacuate the installation.

### NOTICE

After all the piping has been connected, make sure there is no gas leak. Use nitrogen to perform a gas leak detection.

### NOTICE



- To avoid compressor breakdown, do NOT charge more than the specified amount of refrigerant.
- When the refrigerant system is to be opened, refrigerant must be treated according to the applicable legislation.

### WARNING

Make sure there is no oxygen in the system. Refrigerant may only be charged after performing the leak test and the vacuum drying.

- In case re-charge is required, refer to the nameplate of the unit. It states the type of refrigerant and necessary amount.
- The unit is factory charged with refrigerant and depending on pipe sizes and pipe lengths some systems require additional charging of refrigerant.

- Only use tools exclusively for the refrigerant type used in the system, this to ensure pressure resistance and prevent foreign materials from entering into the system.
- Charge the liquid refrigerant as follows:

If	Then
A siphon tube is present (i.e., the cylinder is marked with "Liquid filling siphon attached")	Charge with the cylinder upright. 
A siphon tube is NOT present	Charge with the cylinder upside down. 

- Open refrigerant cylinders slowly.
- Charge the refrigerant in liquid form. Adding it in gas form may prevent normal operation.

### CAUTION

When the refrigerant charging procedure is done or when pausing, close the valve of the refrigerant tank immediately. If the valve is not closed immediately, remaining pressure might charge additional refrigerant. **Possible consequence:** Incorrect refrigerant amount.

## 1.2.4 Brine

If applicable. See the installation manual or installer reference guide of your application for more information.

### WARNING

The selection of the brine MUST be in accordance with the applicable legislation.

### WARNING

Take sufficient precautions in case of brine leakage. If brine leaks, ventilate the area immediately and contact your local dealer.

### WARNING

The ambient temperature inside the unit can get much higher than that of the room, e.g. 70°C. In case of a brine leak, hot parts inside the unit can create a hazardous situation.

### WARNING

The use and installation of the application MUST comply with the safety and environmental precautions specified in the applicable legislation.

## 1.2.5 Water

If applicable. See the installation manual or installer reference guide of your application for more information.

### NOTICE

Make sure water quality complies with EU directive 98/83 EC.

### 1.2.6 Electrical



#### DANGER: RISK OF ELECTROCUTION

- Turn OFF all power supply before removing the switch box cover, connecting electrical wiring or touching electrical parts.
- Disconnect the power supply for more than 1 minute, and measure the voltage at the terminals of main circuit capacitors or electrical components before servicing. The voltage MUST be less than 50 V DC before you can touch electrical components. For the location of the terminals, see the wiring diagram.
- Do NOT touch electrical components with wet hands.
- Do NOT leave the unit unattended when the service cover is removed.



#### WARNING

If NOT factory installed, a main switch or other means for disconnection, having a contact separation in all poles providing full disconnection under overvoltage category III condition, MUST be installed in the fixed wiring.



#### WARNING

- ONLY use copper wires.
- Make sure the field wiring complies with the applicable legislation.
- All field wiring must be performed in accordance with the wiring diagram supplied with the product.
- NEVER squeeze bundled cables and make sure they do not come in contact with the piping and sharp edges. Make sure no external pressure is applied to the terminal connections.
- Make sure to install earth wiring. Do NOT earth the unit to a utility pipe, surge absorber, or telephone earth. Incomplete earth may cause electrical shock.
- Make sure to use a dedicated power circuit. NEVER use a power supply shared by another appliance.
- Make sure to install the required fuses or circuit breakers.
- Make sure to install an earth leakage protector. Failure to do so may cause electric shock or fire.
- When installing the earth leakage protector, make sure it is compatible with the inverter (resistant to high frequency electric noise) to avoid unnecessary opening of the earth leakage protector.



#### NOTICE

Precautions when laying power wiring:

- Do not connect wiring of different thicknesses to the power terminal block (slack in the power wiring may cause abnormal heat).
- When connecting wiring which is the same thickness, do as shown in the figure below.



- For wiring, use the designated power wire and connect firmly, then secure to prevent outside pressure being exerted on the terminal board.
- Use an appropriate screwdriver for tightening the terminal screws. A screwdriver with a small head will damage the head and make proper tightening impossible.
- Over-tightening the terminal screws may break them.



#### WARNING

- After finishing the electrical work, confirm that each electrical component and terminal inside the electrical components box is connected securely.
- Make sure all covers are closed before starting up the unit.



#### NOTICE

Only applicable if the power supply is three-phase, and the compressor has an ON/OFF starting method.

If there exists the possibility of reversed phase after a momentary black out and the power goes on and off while the product is operating, attach a reversed phase protection circuit locally. Running the product in reversed phase can break the compressor and other parts.

## 2 About the documentation

### 2.1 About this document

#### Target audience

Authorised installers



#### INFORMATION

This appliance is intended to be used by expert or trained users in shops, in light industry and on farms, or for commercial use by lay persons.

#### Documentation set

This document is part of a documentation set. The complete set consists of:

- **General safety precautions:**
  - Safety instructions that you must read before installing
  - Format: Paper (in the box of the outdoor unit)
- **Outdoor unit installation manual:**
  - Installation instructions
  - Format: Paper (in the box of the outdoor unit)

## 3 About the box

### • Installer reference guide:

- Preparation of the installation, reference data,...
- Format: Digital files on <http://www.daikineurope.com/support-and-manuals/product-information/>

Latest revisions of the supplied documentation may be available on the regional Daikin website or via your dealer.

The original documentation is written in English. All other languages are translations.

### Technical engineering data

- A **subset** of the latest technical data is available on the regional Daikin website (publicly accessible).
- The **full set** of latest technical data is available on the Daikin extranet (authentication required).

## 2.2 Installer reference guide at a glance

Chapter	Description
General safety precautions	Safety instructions that you must read before installing
About the documentation	What documentation exists for the installer
About the box	How to unpack the units and remove their accessories
About the units and options	<ul style="list-style-type: none"> <li>• How to identify the units</li> <li>• Possible combinations of units and options</li> </ul>
Preparation	What to do and know before going on-site
Installation	What to do and know to install the system
Commissioning	What to do and know to commission the system after it is installed
Hand-over to the user	What to give and explain to the user
Maintenance and service	How to maintain and service the units
Troubleshooting	What to do in case of problems
Disposal	How to dispose of the system
Technical data	Specifications of the system
Glossary	Definition of terms

## 3 About the box

### 3.1 Overview: About the box

This chapter describes what you have to do after the box with the outdoor unit is delivered on-site.

It contains information about:

- Unpacking and handling the units
- Removing the accessories from the units

Keep the following in mind:

- At delivery, the unit must be checked for damage. Any damage must be reported immediately to the carrier's claims agent.
- Bring the packed unit as close as possible to its final installation position to prevent damage during transport.

## 3.2 Outdoor unit

### 3.2.1 To unpack the outdoor unit

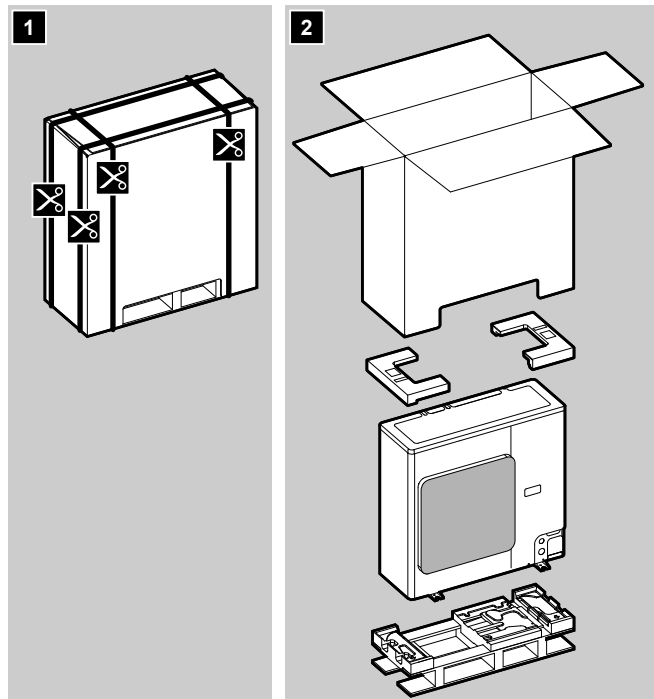

### 3.2.2 To handle the outdoor unit

Carry the unit slowly as shown:



#### CAUTION

To avoid injury, do NOT touch the air inlet or aluminium fins of the unit.

### 3.2.3 To remove the accessories from the outdoor unit

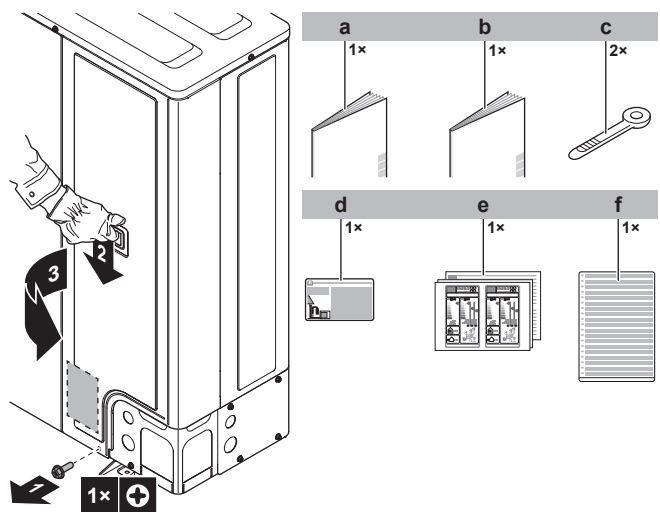

- a General safety precautions
- b Outdoor unit installation manual
- c Cable tie
- d Fluorinated greenhouse gases label
- e Energy label

f Multilingual fluorinated greenhouse gases label (only for RZASG71)

## 4 About the units and options

### 4.1 Overview: About the units and options

This chapter contains information about:

- Identifying the outdoor unit
- Combining the outdoor unit with options

### 4.2 Identification



#### NOTICE

When installing or servicing several units at the same time, make sure NOT to switch the service panels between different models.

#### 4.2.1 Identification label: Outdoor unit

##### Location

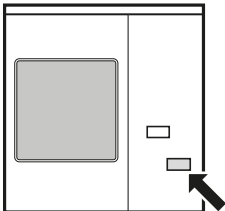

##### Model identification

Example: R Z A S G 140 M7 V1 B [\*]

Code	Explanation
R	Air-cooled split outdoor unit
Z	Inverter
A	Refrigerant R32
SG	Mid-end series
71~140	Capacity class
M7	Model series
V1	Power supply: 1~, 220~240 V, 50 Hz
Y1	Power supply: 3N~, 380~415 V, 50 Hz
B	European market
[*]	Minor model change indication



#### INFORMATION

This unit is not intended for use in high humidity, low ambient temperature regions. For these regions the RZAG model is recommended.

### 4.3 Combining units and options

#### 4.3.1 Possible options for the outdoor unit

##### Refrigerant branch kit

When connecting multiple indoor units to the outdoor unit, you need one or more refrigerant branch kits. The outdoor-indoor combination determines which and how many refrigerant branch kits to use.

Layout	Model name
Twin	KHRQ(M)58T

Layout	Model name
Triple	KHRQ(M)58H
Double twin	KHRQ(M)58T (3×)

For more selection details, see the catalogues. For installation instructions, see the installation manual of the refrigerant branch kit.

##### Demand adaptor kit (SB.KRP58M52)

- Includes the additional mounting plate (EKMKSA2)
- Can be used for the following:
  - Low noise: To lower the operation sound of the outdoor unit.
  - I-demand function: To limit the power consumption from the system (example: budget control, limit power consumption during peak moments...).
- For installation instructions, see the installation manual of the demand adaptor kit.

## 5 Preparation

### 5.1 Overview: Preparation

This chapter describes what you have to do and know before going on-site.

It contains information about:

- Preparing the installation site
- Preparing the refrigerant piping
- Preparing the electrical wiring

### 5.2 Preparing installation site

Do NOT install the unit in places often used as work place. In case of construction works (e.g. grinding works) where a lot of dust is created, the unit must be covered.

Choose the installation location with sufficient place for carrying the unit in and out of the site.



#### WARNING

The appliance shall be stored in a room without continuously operating ignition sources (example: open flames, an operating gas appliance or an operating electric heater).

#### 5.2.1 Installation site requirements of the outdoor unit



#### INFORMATION

Also read the following requirements:

- General installation site requirements. See the "General safety precautions" chapter.
- Service space requirements. See the "Technical data" chapter.
- Refrigerant piping requirements (length, height difference). See further in this "Preparation" chapter.



#### CAUTION

Appliance not accessible to the general public, install it in a secured area, protected from easy access.

This unit, both indoor and outdoor, is suitable for installation in a commercial and light industrial environment.

## 5 Preparation

### NOTICE

The equipment described in this manual may cause electronic noise generated from radio-frequency energy. The equipment complies to specifications that are designed to provide reasonable protection against such interference. However, there is no guarantee that interference will not occur in a particular installation.

It is therefore recommended to install the equipment and electric wires keeping proper distances away from stereo equipment, personal computers, etc.

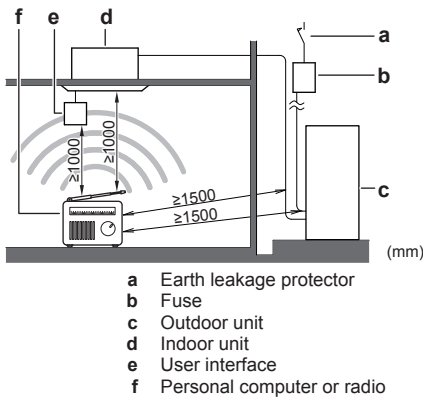

In places with weak reception, keep distances of 3 m or more to avoid electromagnetic disturbance of other equipment and use conduit tubes for power and transmission lines.

- Select a place where rain can be avoided as much as possible.
- Take care that in the event of a water leak, water cannot cause any damage to the installation space and surroundings.
- Choose a location where the hot/cold air discharged from the unit or the operation noise, will NOT disturb anyone.
- Heat exchanger fins are sharp and injury is possible. Choose an installation location where there is no risk for injury (especially in areas where children play).

Do NOT install the unit in the following places:

- Sound sensitive areas (e.g. near a bedroom), so that the operation noise will cause no trouble.  
Note: If the sound is measured under actual installation conditions, the measured value might be higher than the sound pressure level mentioned in Sound spectrum in the data book due to environmental noise and sound reflections.

### INFORMATION

The sound pressure level is less than 70 dBA.

- In places where a mineral oil mist, spray or vapour may be present in the atmosphere. Plastic parts may deteriorate and fall off or cause water leakage.

It is NOT recommended to install the unit in the following places because it may shorten the life of the unit:

- Where the voltage fluctuates a lot
- In vehicles or vessels
- Where acidic or alkaline vapour is present

**Seaside installation.** Make sure the outdoor unit is NOT directly exposed to sea winds. This is to prevent corrosion caused by high levels of salt in the air, which might shorten the life of the unit.

Install the outdoor unit away from direct sea winds.

**Example:** Behind the building.

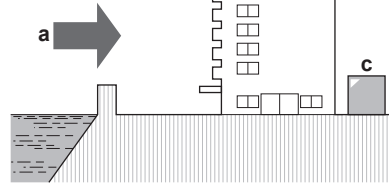

If the outdoor unit is exposed to direct sea winds, install a windbreaker.

- Height of windbreaker  $\geq 1.5 \times$  height of outdoor unit
- Mind the service space requirements when installing the windbreaker.

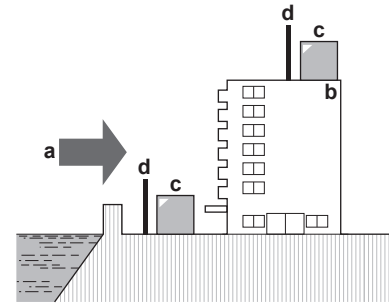

- a Sea wind
- b Building
- c Outdoor unit
- d Windbreaker

Strong winds ( $\geq 18$  km/h) blowing against the outdoor unit's air outlet causes short circuit (suction of discharge air). This may result in:

- deterioration of the operational capacity;
- frequent frost acceleration in heating operation;
- disruption of operation due to decrease of low pressure or increase of high pressure;
- a broken fan (if a strong wind blows continuously on the fan, it may start rotating very fast, until it breaks).

It is recommended to install a baffle plate when the air outlet is exposed to wind.

It is recommended to install the outdoor unit with the air inlet facing the wall and NOT directly exposed to the wind.

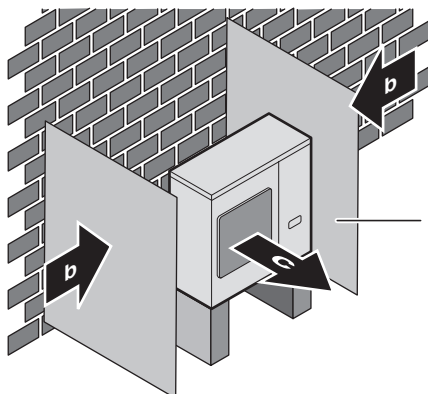

- a Baffle plate
- b Prevailing wind direction
- c Air outlet



## 5.2.2 Additional installation site requirements of the outdoor unit in cold climates

Protect the outdoor unit against direct snowfall and take care that the outdoor unit is NEVER snowed up.

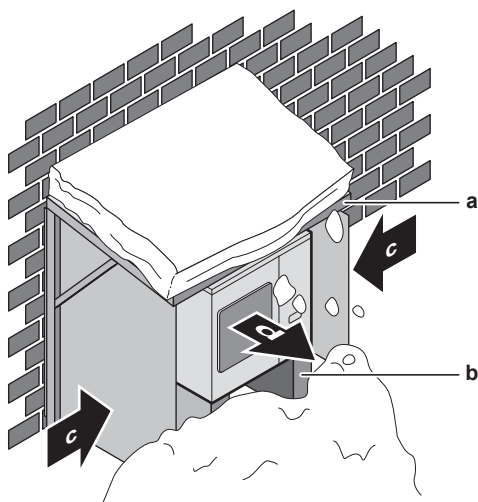

- a Snow cover or shed
- b Pedestal (minimum height=150 mm)
- c Prevailing wind direction
- d Air outlet

## 5.3 Preparing refrigerant piping

### 5.3.1 Refrigerant piping requirements

#### **i** INFORMATION

Also read the precautions and requirements in the "General safety precautions" chapter.

When connecting multiple indoor units to the outdoor unit, mind the following:

Refrigerant branch kit	One or more refrigerant branch kits are required. See "4.3.1 Possible options for the outdoor unit" on page 7.
Upward and downward piping	Perform upward and downward piping only on the main piping line (L1).
Branch pipes	<ul style="list-style-type: none"> <li>▪ Install the branch pipes horizontally (with a maximum inclination of 15°) or vertically.</li> <li>▪ Make the length of the branch pipes to the indoor units as short as possible.</li> <li>▪ Try to keep length of the branch pipes to the indoor units equal.</li> </ul>

#### Definitions: L1~L7, H1, H2

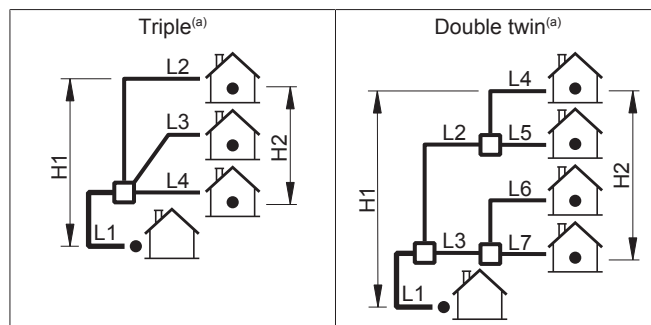
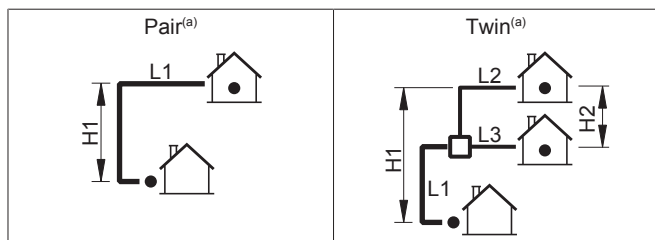

(a) Assume that the longest line in the illustration corresponds with the actual longest pipe, and the highest unit in the illustration corresponds with the actual highest unit.

- L1 Main piping
- L2~L7 Branch piping
- H1 Height difference between the highest indoor unit and the outdoor unit
- H2 Height difference between the highest and the lowest indoor unit
- Refrigerant branch kit

### Refrigerant piping material

- **Piping material:** Phosphoric acid deoxidised seamless copper.
- **Piping temper grade and thickness:**

Outer diameter (Ø)	Temper grade	Thickness (t) <sup>(a)</sup>	
6.4 mm (1/4")	Annealed (O)	≥0.8 mm	
9.5 mm (3/8")			
12.7 mm (1/2")			
15.9 mm (5/8")	Annealed (O)	≥1.0 mm	
19.1 mm (3/4")	Half hard (1/2H)		

(a) Depending on the applicable legislation and the unit's maximum working pressure (see "PS High" on the unit name plate), larger piping thickness might be required.

- **Flare connections:** Only use annealed material.

### Refrigerant piping diameter

The refrigerant piping diameters must comply with the following:

Piping	Diameter
L1 (pair, twin, triple, double twin)	See below.
L2,L3 (twin)	Use the same diameters as the connections (liquid, gas) on the indoor units.
L2~L4 (triple)	
L4~L7 (double twin)	
L2,L3 (double twin)	Liquid piping: Ø9.5 mm Gas piping: Ø15.9 mm

L1 (pair, twin, triple, double twin):

Model	New <sup>(a)</sup> / Existing <sup>(b)</sup>	L1 liquid piping	L1 gas piping
RZASG71	Standard	Ø9.5 mm	Ø15.9 mm
RZASG100~140	Standard	Ø9.5 mm	Ø15.9 mm

- (a) When installing **new piping**, use the same diameters as the connections on the outdoor units (i.e. **standard** diameters for liquid and gas piping).
- (b) When reusing **existing piping**, you may use the **size-up** or **size-down** diameters, but then capacity might decrease, and stricter piping length requirements are applicable. Assess these limitations in relation to the complete installation.

## 5 Preparation

### Refrigerant piping length and height difference

The piping lengths and height differences must comply with the following requirements:

Requirement		Limit	
		71+100	125+140
1	Minimum total one-way piping length	Pair: Limit $\leq L1$ Twin: Limit $\leq L1+L3$ Triple: Limit $\leq L1+L4$ Double twin: Limit $\leq L1+L3+L7$	5 m
2	Maximum total one-way piping length	Pair: $L1 \leq \text{Limit}$	50 m (70 m) <sup>(a)</sup>
		Twin and triple: $L1+L2 \leq \text{Limit}$	50 m (70 m) <sup>(a)</sup>
		Double twin: $L1+L2+L4 \leq \text{Limit}$	
3	Maximum allowable piping length	Pair: N/A	—
		Twin: $L1+L2+L3 \leq \text{Limit}$	50 m
		Triple: $L1+L2+L3+L4 \leq \text{Limit}$	50 m
		Double twin: $L1+L2+L3+L4+L5+L6+L7 \leq \text{Limit}$	—   50 m
4	Maximum branch piping length	Pair: N/A	20 m
		Twin and triple: $L2 \leq \text{Limit}$	
		Double twin: $L2+L4 \leq \text{Limit}$	
5	Maximum difference between branch lengths	Pair: N/A	—
		Twin: $L2-L3 \leq \text{Limit}$	10 m
		Triple: $L2-L4 \leq \text{Limit}$	10 m
		Double twin: • $L2-L3 \leq \text{Limit}$ • $L4-L5 \leq \text{Limit}$ • $L6-L7 \leq \text{Limit}$ • $(L2+L4)-(L3+L7) \leq \text{Limit}$	—   10 m
6	Maximum height between indoor and outdoor	Pair, twin, triple and double twin: $H1 \leq \text{Limit}$	30 m
7	Maximum height between indoors	Pair: N/A Twin, triple and double twin: $H2 \leq \text{Limit}$	0.5 m

(a) Parenthesised figure represents the equivalent length.

#### Example

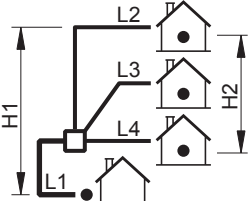
If the system layout is as follows...	Then the requirements are...	
<ul style="list-style-type: none"> <li>RZASG125</li> <li>Triple:</li> </ul>  <ul style="list-style-type: none"> <li>Ø standard</li> </ul>	1	$5 \text{ m} \leq L1+L4$
	2	$L1+L2 \leq 50 \text{ m (70 m)}$
	3	$L1+L2+L3+L4 \leq 50 \text{ m}$
	4	$L2 \leq 20 \text{ m}$
	5	$L2-L4 \leq 10 \text{ m}$
	6	$H1 \leq 30 \text{ m}$
	7	$H2 \leq 0.5 \text{ m}$

### 5.3.2 Refrigerant piping insulation

- Use polyethylene foam as insulation material:
  - with a heat transfer rate between 0.041 and 0.052 W/mK (0.035 and 0.045 kcal/mh°C)
  - with a heat resistance of at least 120°C
- Insulation thickness

Ambient temperature	Humidity	Minimum thickness
$\leq 30^\circ\text{C}$	75% to 80% RH	15 mm
$> 30^\circ\text{C}$	$\geq 80\%$ RH	20 mm

### 5.4 Preparing electrical wiring

#### 5.4.1 About preparing electrical wiring



#### INFORMATION

Also read the precautions and requirements in the "General safety precautions" chapter.



#### INFORMATION

Also read "6.7.5 Specifications of standard wiring components" on page 21.

**WARNING**

- If the power supply has a missing or wrong N-phase, equipment might break down.
- Establish proper earthing. Do NOT earth the unit to a utility pipe, surge absorber, or telephone earth. Incomplete earthing may cause electrical shock.
- Install the required fuses or circuit breakers.
- Secure the electrical wiring with cable ties so that the cables do NOT come in contact with sharp edges or piping, particularly on the high-pressure side.
- Do NOT use taped wires, stranded conductor wires, extension cords, or connections from a star system. They can cause overheating, electrical shock or fire.
- Do NOT install a phase advancing capacitor, because this unit is equipped with an inverter. A phase advancing capacitor will reduce performance and may cause accidents.

**WARNING**

- All wiring must be performed by an authorized electrician and must comply with the applicable legislation.
- Make electrical connections to the fixed wiring.
- All components procured on the site and all electrical construction must comply with the applicable legislation.

**WARNING**

ALWAYS use multicore cable for power supply cables.

## 6 Installation

### 6.1 Overview: Installation

This chapter describes what you have to do and know on-site to install the system.

#### Typical workflow

Installation typically consists of the following stages:

- Mounting the outdoor unit.
- Mounting the indoor units.
- Connecting the refrigerant piping.
- Checking the refrigerant piping.
- Charging refrigerant.
- Connecting the electrical wiring.
- Finishing the outdoor installation.
- Finishing the indoor installation.

**INFORMATION**

For installation of the indoor unit (mounting the indoor unit, connecting the refrigerant piping to the indoor unit, connecting the electrical wiring to the indoor unit ...), see the installation manual of the indoor unit.

### 6.2 Opening the units

#### 6.2.1 About opening the units

At certain times, you have to open the unit. **Example:**

- When connecting the refrigerant piping

- When connecting the electrical wiring
- When maintaining or servicing the unit

**DANGER: RISK OF ELECTROCUTION**

Do NOT leave the unit unattended when the service cover is removed.

#### 6.2.2 To open the outdoor unit

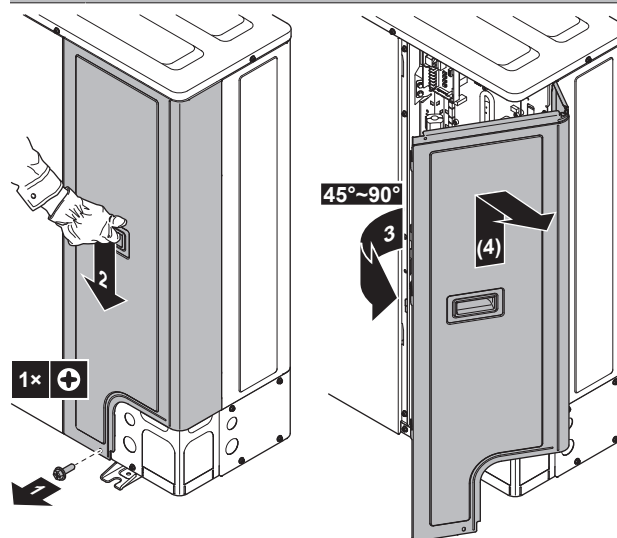
**DANGER: RISK OF ELECTROCUTION****DANGER: RISK OF BURNING**

### 6.3 Mounting the outdoor unit

#### 6.3.1 About mounting the outdoor unit

##### Typical workflow

Mounting the outdoor unit typically consists of the following stages:

- 1 Providing the installation structure.
- 2 Installing the outdoor unit.
- 3 Providing drainage.
- 4 Preventing the unit from falling over.
- 5 Protecting the unit against snow and wind by installing a snow cover and baffle plates. See "Preparing installation site" in "5 Preparation" on page 7.

#### 6.3.2 Precautions when mounting the outdoor unit

**INFORMATION**

Also read the precautions and requirements in the following chapters:

- General safety precautions
- Preparation

#### 6.3.3 To provide the installation structure

Check the strength and level of the installation ground so that the unit will not cause any operating vibration or noise.

Fix the unit securely by means of foundation bolts in accordance with the foundation drawing.

Prepare 4 sets of anchor bolts, nuts and washers (field supply) as follows:

## 6 Installation

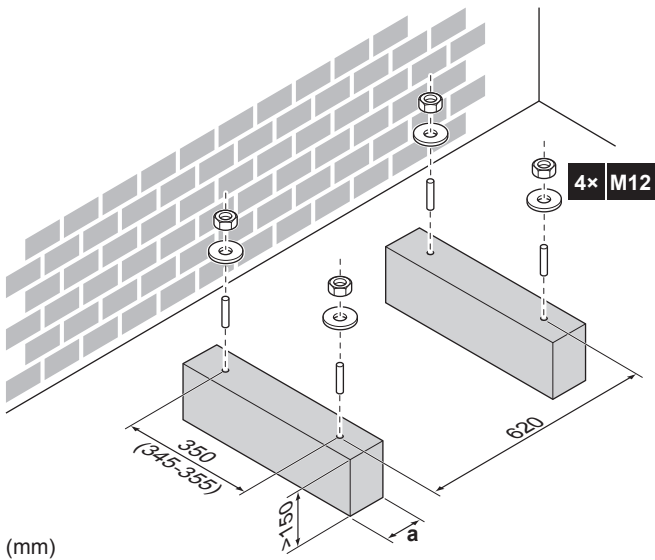

(mm)

- a Make sure not to cover the drain holes of the bottom plate of the unit.



### INFORMATION

The recommended height of the upper protruding part of the bolts is 20 mm.

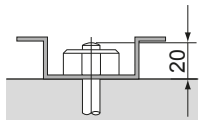

### NOTICE

Fix the outdoor unit to the foundation bolts using nuts with resin washers (a). If the coating on the fastening area is stripped off, the nuts rust easily.



### 6.3.4 To install the outdoor unit

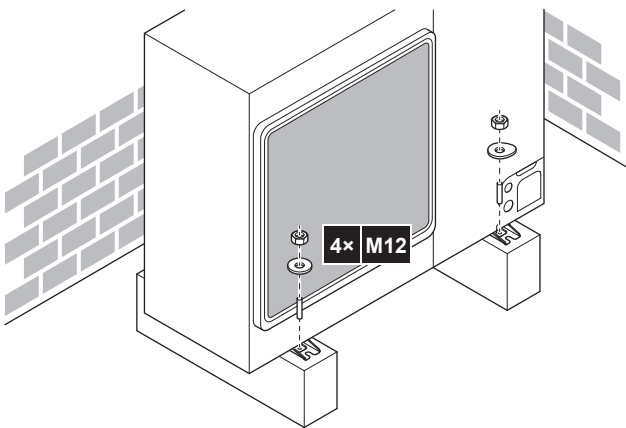

### 6.3.5 To provide drainage

- Make sure that condensation water can be evacuated properly.
- Install the unit on a base to make sure that there is a proper drainage in order to avoid ice accumulation.
- Prepare a water drainage channel around the foundation to drain waste water surrounding the unit.
- Avoid drain water flowing over the footpath, so that it does not become slippery in case of ambient freezing temperatures.

- If you install the unit on a frame, install a waterproof plate within 150 mm of the bottom side of the unit in order to prevent the invasion of water in the unit and to avoid the drain water dripping (see the following illustration).



### INFORMATION

If necessary, you can use a drain plug kit (field supply) to prevent drain water from dripping.



### NOTICE

If drain holes of the outdoor unit are covered by a mounting base or by floor surface, raise the unit to provide a free space of more than 150 mm under the outdoor unit.

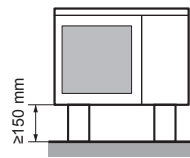

### Drain holes (dimensions in mm)

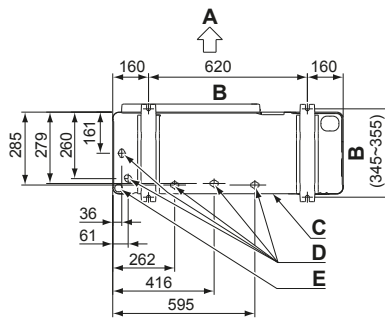

- A Discharge side  
B Distance between anchor points  
C Bottom frame  
D Drain holes  
E Knockout hole for snow

### Snow

In regions with snowfall, snow might build up and freeze between the heat exchanger and the external plate. This might decrease the operating efficiency. To prevent this:

- Drill (a, 4×) and remove the knockout hole (b).

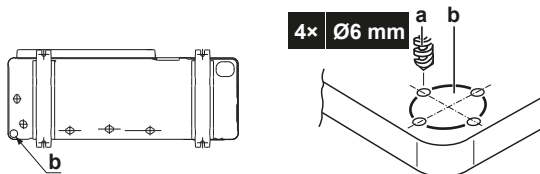

- Remove the burrs, and paint the edges and areas around the edges using repair paint to prevent rusting.

### 6.3.6 To prevent the outdoor unit from falling over

In case the unit is installed in places where strong wind can tilt the unit, take following measure:

- Prepare 2 cables as indicated in the following illustration (field supply).
- Place the 2 cables over the outdoor unit.

- 3 Insert a rubber sheet between the cables and the outdoor unit to prevent the cable from scratching the paint (field supply).
- 4 Attach the cable's ends. Tighten those ends.

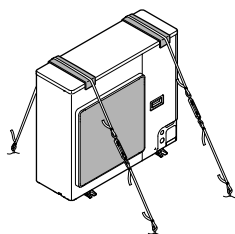

## 6.4 Connecting the refrigerant piping

### 6.4.1 About connecting the refrigerant piping

#### Before connecting the refrigerant piping

Make sure the outdoor and indoor unit are mounted.

#### Typical workflow

Connecting the refrigerant piping involves:

- Connecting the refrigerant piping to the outdoor unit
- Connecting the refrigerant piping to the indoor unit
- Installing oil traps
- Insulating the refrigerant piping
- Keeping in mind the guidelines for:
  - Pipe bending
  - Flaring pipe ends
  - Brazing
  - Using the stop valves

### 6.4.2 Precautions when connecting the refrigerant piping



#### INFORMATION

Also read the precautions and requirements in the following chapters:

- General safety precautions
- Preparation



#### DANGER: RISK OF BURNING



#### CAUTION

- Do NOT use mineral oil on flared part.
- Do NOT reuse piping from previous installations.
- NEVER install a drier to this R32 unit to guarantee its lifetime. The drying material may dissolve and damage the system.



#### NOTICE

Take the following precautions on refrigerant piping into account:

- Avoid anything but the designated refrigerant to get mixed into the refrigerant cycle (e.g. air).
- Only use R32 when adding refrigerant.
- Only use installation tools (e.g. manifold gauge set) that are exclusively used for R32 installations to withstand the pressure and to prevent foreign materials (e.g. mineral oils and moisture) from mixing into the system.
- Install the piping so that the flare is NOT subjected to mechanical stress.
- Protect the piping as described in the following table to prevent dirt, liquid or dust from entering the piping.
- Use caution when passing copper tubes through walls (see figure below).

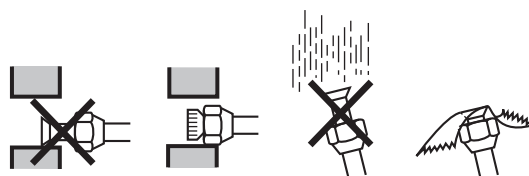

Unit	Installation period	Protection method
Outdoor unit	>1 month	Pinch the pipe
	<1 month	Pinch or tape the pipe
Indoor unit	Regardless of the period	



#### INFORMATION

Do NOT open the refrigerant stop valve before checking the refrigerant piping. When you need to charge additional refrigerant it is recommended to open the refrigerant stop valve after charging.

### 6.4.3 Guidelines when connecting the refrigerant piping

Take the following guidelines into account when connecting pipes:

- Coat the flare inner surface with ether oil or ester oil when connecting a flare nut. Tighten 3 or 4 turns by hand, before tightening firmly.

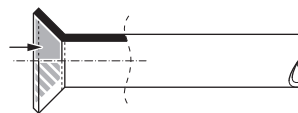

- Always use 2 wrenches together when loosening a flare nut.
- Always use a spanner and torque wrench together to tighten the flare nut when connecting the piping. This to prevent nut cracking and leaks.

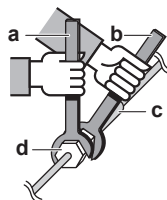

- a Torque wrench
- b Spanner
- c Piping union
- d Flare nut

## 6 Installation

Piping size (mm)	Tightening torque (N·m)	Flare dimensions (A) (mm)	Flare shape (mm)
Ø9.5	33~39	12.8~13.2	
Ø15.9	63~75	19.3~19.7	

### 6.4.4 Pipe bending guidelines

Use a pipe bender for bending. All pipe bends should be as gentle as possible (bending radius should be 30~40 mm or larger).

### 6.4.5 To flare the pipe end

#### CAUTION

- Incomplete flaring may cause refrigerant gas leakage.
- Do NOT re-use flares. Use new flares to prevent refrigerant gas leakage.
- Use flare nuts that are included with the unit. Using different flare nuts may cause refrigerant gas leakage.

- 1 Cut the pipe end with a pipe cutter.
- 2 Remove burrs with the cut surface facing down so that the chips do not enter the pipe.



- a Cut exactly at right angles.
- b Remove burrs.

- 3 Remove the flare nut from the stop valve and put the flare nut on the pipe.
- 4 Flare the pipe. Set exactly at the position as shown in the following illustration.

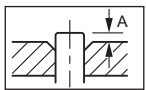

	Flare tool for R32 (clutch type)	Conventional flare tool	
		Clutch type (Ridgid-type)	Wing nut type (Imperial-type)
A	0~0.5 mm	1.0~1.5 mm	1.5~2.0 mm

- 5 Check that the flaring is properly made.

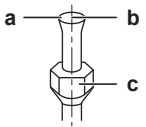

- a Flare's inner surface must be flawless.
- b The pipe end must be evenly flared in a perfect circle.
- c Make sure the flare nut is fitted.

### 6.4.6 To braze the pipe end

The indoor unit and outdoor unit have flare connections. Connect both ends without brazing. If brazing should be needed, take the following into account:

- When brazing, blow through with nitrogen to prevent creation of large quantities of oxidised film on the inside of the piping. This film adversely affects valves and compressors in the refrigerating system and prevents proper operation.
- Set the nitrogen pressure to 20 kPa (0.2 bar) (just enough so it can be felt on the skin) with a pressure-reducing valve.

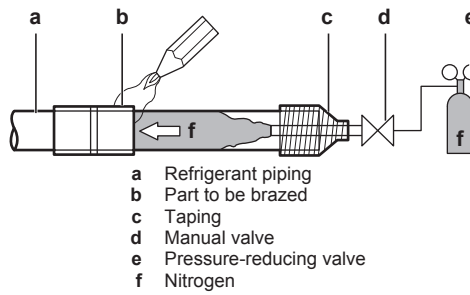

- Do NOT use anti-oxidants when brazing pipe joints. Residue can clog pipes and break equipment.
- Do NOT use flux when brazing copper-to-copper refrigerant piping. Use phosphor copper brazing filler alloy (BCuP), which does not require flux. Flux has an extremely harmful influence on refrigerant piping systems. For instance, if chlorine based flux is used, it will cause pipe corrosion or, in particular, if the flux contains fluorine, it will deteriorate the refrigerant oil.

### 6.4.7 Using the stop valve and service port

#### To handle the stop valve

Take the following guidelines into account:

- The stop valves are factory closed.
- The following illustration shows each part required in handling the valve.

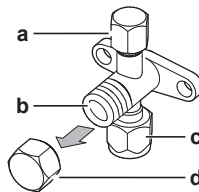

- a Service port and service port cap
- b Valve stem
- c Field piping connection
- d Stem cap

- Keep both stop valves open during operation.
- Do NOT apply excessive force to the valve stem. Doing so may break the valve body.
- Always make sure to secure the stop valve with a spanner, then loosen or tighten the flare nut with a torque wrench. Do NOT place the spanner on the stem cap, as this could cause a refrigerant leak.

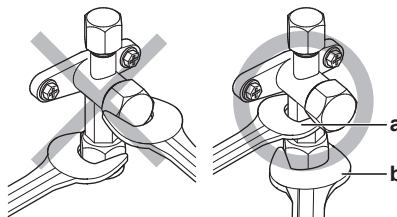

- a Spanner
- b Torque wrench

- When it is expected that the operating pressure will be low (e.g. when cooling will be performed while the outside air temperature is low), sufficiently seal the flare nut in the stop valve on the gas line with silicon sealant to prevent freezing.

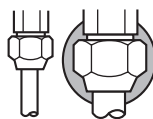

Silicon sealant, make sure there is no gap.

## To open/close the stop valve

- 1 Remove the valve cover.
- 2 Insert a hexagon wrench (liquid side: 4 mm, gas side: 6 mm) into the valve stem and turn the valve stem:

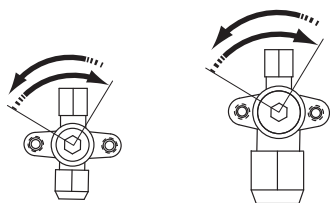

Counterclockwise to open.  
Clockwise to close.

- 3 When the valve stem cannot be turned any further, stop turning. The valve is now opened/closed.

## To handle the stem cap

- The stem cap is sealed where indicated with the arrow. Do NOT damage it.

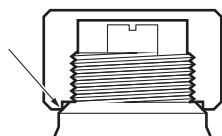

- After handling the stop valve, tighten the stem cap, and check for refrigerant leaks.

Item	Tightening torque (N·m)
Stem cap, liquid side	13.5~16.5
Stem cap, gas side	22.5~27.5

## To handle the service cap

- Always use a charge hose equipped with a valve depressor pin, since the service port is a Schrader type valve.
- After handling the service port, tighten the service port cap, and check for refrigerant leaks.

Item	Tightening torque (N·m)
Service port cap	11.5~13.9

## 6.4.8 To connect the refrigerant piping to the outdoor unit

- **Piping length.** Keep field piping as short as possible.
- **Piping protection.** Protect the field piping against physical damage.

- 1 Do the following:
  - Remove the service cover (a) with screw (b).
  - Remove the piping intake plate (c) with screw (d).

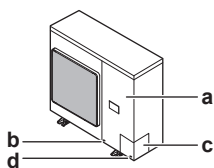

- 2 Choose a piping route (a, b, c or d).

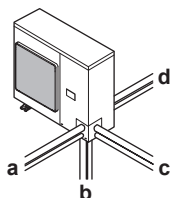

- 3 If you have chosen the downwards piping route:
  - Drill (a, 4×) and remove the knockout hole (b).
  - Cut out the slits (c) with a metal saw.

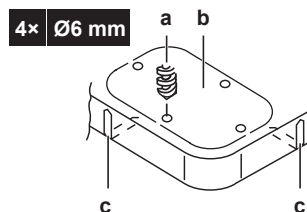

- 4 Do the following:
  - Connect the liquid pipe (a) to the liquid stop valve.
  - Connect the gas pipe (b) to the gas stop valve.

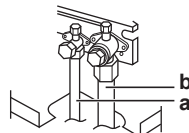

- 5 Do the following:
  - Insulate the liquid piping (a) and the gas piping (b).
  - Wind heat insulation around the curves, and then cover it with vinyl tape (c).
  - Make sure the field piping does not touch any compressor components (d).
  - Seal the insulation ends (sealant etc.) (e).

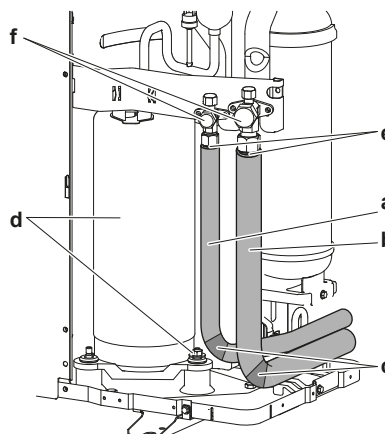

- 6 If the outdoor unit is installed above the indoor unit, cover the stop valves (f, see above) with sealing material to prevent condensed water on the stop valves from moving to the indoor unit.



### NOTICE

Any exposed piping might cause condensation.

- 7 Reattach the service cover and the piping intake plate.
- 8 Seal all gaps (example: a) to prevent snow and small animals from entering the system.

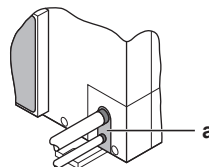

## 6 Installation



### NOTICE

Do not block the air vents. This could affect air circulation inside the unit.

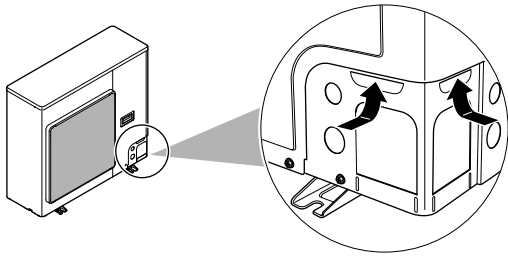

### WARNING

Provide adequate measures to prevent that the unit can be used as a shelter by small animals. Small animals that make contact with electrical parts can cause malfunctions, smoke or fire.



### NOTICE

Precautions when making knockout holes:

- Avoid damaging the casing.
- After making the knockout holes, we recommend you remove the burrs and paint the edges and areas around the edges using repair paint to prevent rusting.
- When passing electrical wiring through the knockout holes, wrap the wiring with protective tape to prevent damage.

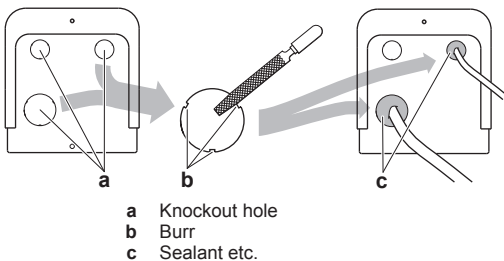

- a Knockout hole
- b Burr
- c Sealant etc.



### NOTICE

Make sure to open the stop valves after installing the refrigerant piping and performing vacuum drying. Running the system with the stop valves closed may break the compressor.

## 6.5 Checking the refrigerant piping

### 6.5.1 About checking the refrigerant piping

The outdoor unit's **internal** refrigerant piping has been factory tested for leaks. You only have to check the outdoor unit's **external** refrigerant piping.

#### Before checking the refrigerant piping

Make sure the refrigerant piping is connected between the outdoor unit and the indoor unit.

#### Typical workflow

Checking the refrigerant piping typically consists of the following stages:

- 1 Checking for leaks in the refrigerant piping.
- 2 Performing vacuum drying to remove all moisture, air or nitrogen from the refrigerant piping.

If there is a possibility of moisture being present in the refrigerant piping (for example, water may have entered the piping), first carry out the vacuum drying procedure below until all moisture has been removed.

### 6.5.2 Precautions when checking the refrigerant piping



#### INFORMATION

Also read the precautions and requirements in the following chapters:

- General safety precautions
- Preparation



#### NOTICE

Use a 2-stage vacuum pump with a non-return valve that can evacuate to a gauge pressure of  $-100.7 \text{ kPa}$  ( $-1.007 \text{ bar}$ )(5 Torr absolute). Make sure the pump oil does not flow oppositely into the system while the pump is not working.



#### NOTICE

Use this vacuum pump for R32 exclusively. Using the same pump for other refrigerants may damage the pump and the unit.



#### NOTICE

- Connect the vacuum pump to **both** the service port of the gas stop valve and the service port of the liquid stop valve to increase efficiency.
- Make sure that the gas stop valve and liquid stop valve are firmly closed before performing the leak test or vacuum drying.

### 6.5.3 Checking refrigerant piping: Setup

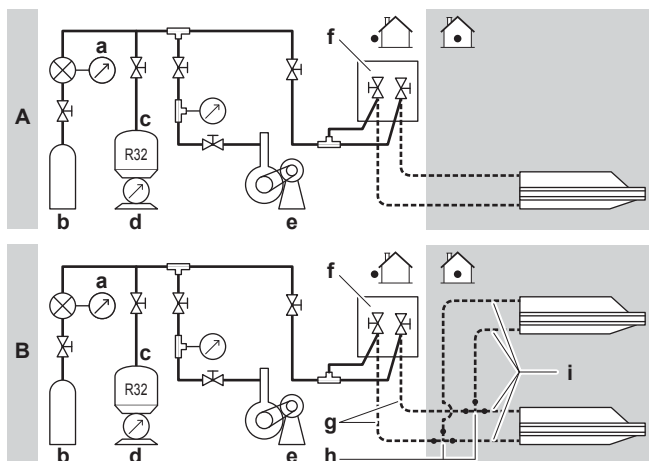

- A Setup in case of pair
- B Setup in case of twin
- a Pressure gauge
- b Nitrogen
- c Refrigerant
- d Weighing machine
- e Vacuum pump
- f Stop valve
- g Main piping
- h Refrigerant branch kit
- i Branch piping

### 6.5.4 To check for leaks



#### NOTICE

Do NOT exceed the unit's maximum working pressure (see "PS High" on the unit name plate).



**NOTICE**

Make sure to use a recommended bubble test solution from your wholesaler. Do not use soap water, which may cause cracking of flare nuts (soap water may contain salt, which absorbs moisture that will freeze when the piping gets cold), and/or lead to corrosion of flared joints (soap water may contain ammonia which causes a corrosive effect between the brass flare nut and the copper flare).

- 1 Charge the system with nitrogen gas up to a gauge pressure of at least 200 kPa (2 bar). It is recommended to pressurize to 3000 kPa (30 bar) in order to detect small leaks.
- 2 Check for leaks by applying the bubble test solution to all connections.
- 3 Discharge all nitrogen gas.

**6.5.5 To perform vacuum drying****NOTICE**

- Connect the vacuum pump to **both** the service port of the gas stop valve and the service port of the liquid stop valve to increase efficiency.
- Make sure that the gas stop valve and liquid stop valve are firmly closed before performing the leak test or vacuum drying.

- 1 Vacuum the system until the pressure on the manifold indicates  $-0.1$  MPa ( $-1$  bar).
- 2 Leave as is for 4-5 minutes and check the pressure:

If the pressure...	Then...
Does not change	There is no moisture in the system. This procedure is finished.
Increases	There is moisture in the system. Go to the next step.

- 3 Evacuate for at least 2 hours to a pressure on the manifold of  $-0.1$  MPa ( $-1$  bar).
- 4 After turning OFF the pump, check the pressure for at least 1 hour.
- 5 If you do NOT reach the target vacuum or cannot maintain the vacuum for 1 hour, do the following:
  - Check for leaks again.
  - Perform vacuum drying again.

**NOTICE**

Make sure to open the stop valves after installing the refrigerant piping and performing vacuum drying. Running the system with the stop valves closed may break the compressor.

**INFORMATION**

After opening the stop valve, it is possible that the pressure in the refrigerant piping does NOT increase. This might be caused by e.g. the closed state of the expansion valve in the outdoor unit circuit, but does NOT present any problem for correct operation of the unit.

**6.6 Charging refrigerant****6.6.1 About charging refrigerant**

The outdoor unit is factory charged with refrigerant, but in some cases the following might be necessary:

What	When
Charging additional refrigerant	When the total liquid piping length is more than specified (see later).
Completely recharging refrigerant	<b>Example:</b> <ul style="list-style-type: none"> <li>▪ When relocating the system.</li> <li>▪ After a leak.</li> </ul>

**Charging additional refrigerant**

Before charging additional refrigerant, make sure the outdoor unit's **external** refrigerant piping is checked (leak test, vacuum drying).

**INFORMATION**

Depending on the units and/or the installation conditions, it might be necessary to connect electrical wiring before you can charge refrigerant.

Typical workflow – Charging additional refrigerant typically consists of the following stages:

- 1 Determining if and how much you have to charge additionally.
- 2 If necessary, charging additional refrigerant.
- 3 Filling in the fluorinated greenhouse gases label, and fixing it to the inside of the outdoor unit.

**Completely recharging refrigerant**

Before completely recharging refrigerant, make sure the following is done:

- 1 All refrigerant is recovered from the system.
- 2 The outdoor unit's **external** refrigerant piping is checked (leak test, vacuum drying).
- 3 Vacuum drying on the outdoor unit's **internal** refrigerant piping is performed.

**NOTICE**

Before completely recharging, perform vacuum drying on the outdoor unit's **internal** refrigerant piping as well.

**NOTICE**

To perform vacuum drying or a complete recharge of the outdoor unit's internal refrigerant piping it is necessary to activate the vacuum mode (see "[6.6.9 To activate/deactivate the vacuum mode field setting](#)" on page 19) which will open required valves in the refrigerant circuit so the vacuuming process or recharge of refrigerant can be done properly.

- Before vacuum drying or recharging, activate field setting "vacuum mode".
- After finishing vacuum drying or recharging, deactivate field setting "vacuum mode".

**WARNING**

Some sections of the refrigerant circuit may be isolated from other sections caused by components with specific functions (e.g. valves). The refrigerant circuit therefore features additional service ports for vacuuming, pressure relief or pressurizing the circuit.

In case it is required to perform **brazing** on the unit, ensure that there is no pressure remaining inside the unit. Internal pressures need to be released with ALL the service ports indicated on the figures below opened. The location is depending on model type.

Location of service ports:

## 6 Installation

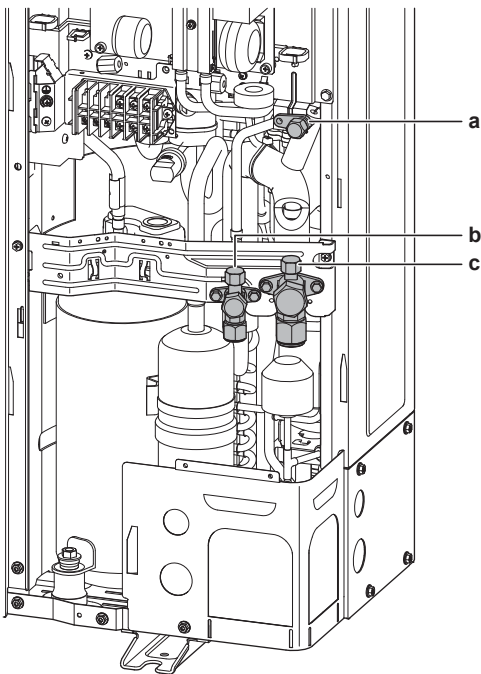

- a Internal service port
- b Stop valve with service port (liquid)
- c Stop valve with service port (gas)

Typical workflow – Completely recharging refrigerant typically consists of the following stages:

- 1 Determining how much refrigerant to charge.
- 2 Charging refrigerant.
- 3 Filling in the fluorinated greenhouse gases label, and fixing it to the inside of the outdoor unit.

### 6.6.2 About the refrigerant

This product contains fluorinated greenhouse gases. Do NOT vent gases into the atmosphere.

Refrigerant type: R32

Global warming potential (GWP) value: 675



#### WARNING: FLAMMABLE MATERIAL

The refrigerant inside this unit is mildly flammable.



#### WARNING

The appliance shall be stored in a room without continuously operating ignition sources (example: open flames, an operating gas appliance or an operating electric heater).



#### WARNING

- Do NOT pierce or burn refrigerant cycle parts.
- Do NOT use cleaning materials or means to accelerate the defrosting process other than those recommended by the manufacturer.
- Be aware that the refrigerant inside the system is odourless.



#### WARNING

The refrigerant inside the unit is mildly flammable, but normally does not leak. If the refrigerant leaks in the room and comes in contact with fire from a burner, a heater, or a cooker, this may result in fire, or the formation of a harmful gas.

Turn off any combustible heating devices, ventilate the room, and contact the dealer from which you purchased the unit.

Do not use the unit until a service person confirms that the portion from which the refrigerant leaked is repaired.

### 6.6.3 Precautions when charging refrigerant



#### INFORMATION

Also read the precautions and requirements in the following chapters:

- General safety precautions
- Preparation

### 6.6.4 Definitions: L1~L7, H1, H2

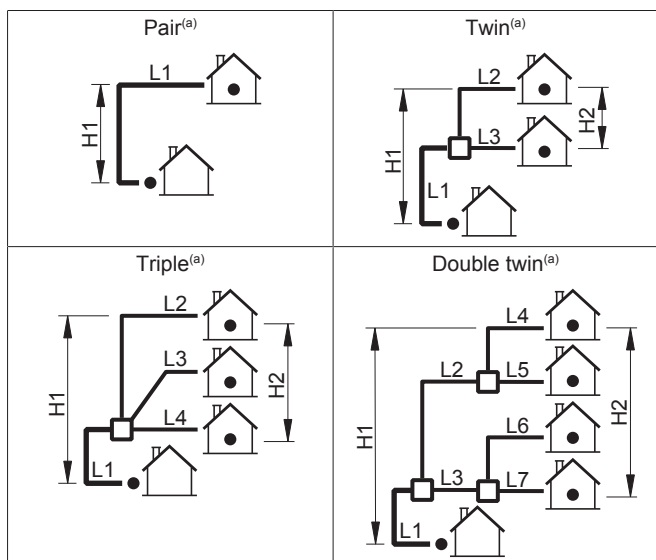

(a) Assume that the longest line in the illustration corresponds with the actual longest pipe, and the highest unit in the illustration corresponds with the actual highest unit.

- L1 Main piping
- L2~L7 Branch piping
- H1 Height difference between the highest indoor unit and the outdoor unit
- H2 Height difference between the highest and the lowest indoor unit
- Refrigerant branch kit

### 6.6.5 To determine the additional refrigerant amount

To determine if adding additional refrigerant is necessary

If	Then
$(L1+L2+L3+L4+L5+L6+L7) \leq 30$ m (chargeless length)	You do not have to add additional refrigerant.
$(L1+L2+L3+L4+L5+L6+L7) > 30$ m (chargeless length)	You must add additional refrigerant.  For future servicing, encircle the selected amount in the tables below.

## **i** INFORMATION

Piping length is the largest one way length of liquid piping.

To determine the additional refrigerant amount (R in kg) (in case of pair)

	L1 (m)	
L1:	30~40 m	40~50 m
R:	0.35 kg	0.7 kg

To determine the additional refrigerant amount (R in kg) (in case of twin, triple and double twin)

- Determine R1 and R2.

If	Then
G1>30 m	Use the table below to determine R1
G1≤30 m (and G1+G2>30 m)	R1=0.0 kg. Use the table below to determine R2.

	Length (total length of liquid piping~30 m)				
	0~10 m	10~20 m	20~30 m	30~40 m	40~45 m
R1:	0.35 kg	0.7 kg	1.05 kg <sup>(a)</sup>	1.4 kg <sup>(a)</sup>	
R2:	0.2 kg	0.4 kg	0.6 kg	0.8 kg <sup>(a)</sup>	1 kg <sup>(b)</sup>

(a) Only for RZASG100~140.

(b) Only for RZASG100+125.

- Determine the additional refrigerant amount: R=R1+R2.

### Examples

Layout	Additional refrigerant amount (R)
	Case: Twin, standard liquid pipe size
	1 G1 Total Ø9.5 => G1=35 m
	G2 Total Ø6.4 => G2=7+5=12 m
	Case: G1>30 m
	R1 Length=G1-30 m=5 m => R1=0.35 kg
	R2 Length=G2=12 m => R2=0.4 kg
3 R R=R1+R2=0.35+0.4=0.75 kg	
	Case: Triple, standard liquid pipe size
	1 G1 Total Ø9.5 => G1=5 m
	G2 Total Ø6.4 => G2=15+12+17=44 m
	Case: G1≤30 m (and G1+G2>30 m)
	R1 R1=0.0 kg
	R2 Length=G1+G2-30 m = 5+44-30=19 m => R2=0.4 kg
3 R R=R1+R2=0.0+0.4=0.4 kg	

## 6.6.6 To determine the complete recharge amount

To determine the complete recharge amount (kg)

Model	Length <sup>(a)</sup>		
	5~30 m	30~40 m	40~50 m
RZASG71	2.45 kg	2.8 kg	3.15 kg
RZASG100-125	2.6 kg	2.95 kg	3.3 kg
RZASG140	2.9 kg	3.25 kg	3.6 kg

(a) Length=L1 (pair); L1+L2 (twin, triple); L1+L2+L4 (double twin)

## 6.6.7 Charging refrigerant: Setup

See "6.5.3 Checking refrigerant piping: Setup" on page 16.

## 6.6.8 To charge additional refrigerant



### WARNING

- Only use R32 as refrigerant. Other substances may cause explosions and accidents.
- R32 contains fluorinated greenhouse gases. Its global warming potential (GWP) value is 675. Do NOT vent these gases into the atmosphere.
- When charging refrigerant, always use protective gloves and safety glasses.



### CAUTION

To avoid compressor breakdown, do NOT charge more than the specified amount of refrigerant.

**Prerequisite:** Before charging refrigerant, make sure the refrigerant piping is connected and checked (leak test and vacuum drying).

- Connect the refrigerant cylinder to both the service port of the gas stop valve and the service port of the liquid stop valve.
- Charge the additional refrigerant amount.
- Open the stop valves.

If pump down is needed in case of dismantling or relocating the system, see "11.3 To pump down" on page 26 for more details.

## 6.6.9 To activate/deactivate the vacuum mode field setting

### Description

To perform vacuum drying or a complete recharge of the outdoor unit's internal refrigerant piping it is necessary to activate the vacuum mode which will open required valves in the refrigerant circuit so the vacuuming process or recharge of refrigerant can be done properly.

### To activate vacuum mode:

Activating the vacuum mode is done by operating the push buttons BS\* on the PCB (A1P) and reading the feedback from the 7-segment displays.

Operate the switches and push buttons with an insulated stick (such as a closed ball-point pen) to avoid touching of live parts.



- When the unit is powered on and not running, hold down the BS1 pushbutton for 5 seconds.

**Result:** You will reach the setting mode, the 7 segment display will show '2 0 0'.

- Press the BS2 button until you reach page 2-28.
- When 2-28 is reached, press the BS3 button once.
- Change the setting to '1' by pressing the BS2 button once .
- Push the BS3 button once
- When the display is not blinking anymore, press the BS3 button again to activate vacuum mode.

### To deactivate vacuum mode:

After charging or vacuuming the unit, please deactivate the vacuum mode by changing the setting back to '0'.

Make sure to reattach the electronic component box cover and to install the front cover after the job is finished.

## 6 Installation

### NOTICE

Make sure that all outside panels, except for the service cover on the electrical component box, are closed while working.

Close the lid of the electrical component box firmly before turning on the power.

### 6.6.10 To completely recharge refrigerant

#### WARNING

- Only use R32 as refrigerant. Other substances may cause explosions and accidents.
- R32 contains fluorinated greenhouse gases. Its global warming potential (GWP) value is 675. Do NOT vent these gases into the atmosphere.
- When charging refrigerant, always use protective gloves and safety glasses.

#### CAUTION

To avoid compressor breakdown, do NOT charge more than the specified amount of refrigerant.

**Prerequisite:** Before completely recharging refrigerant, make sure the system is pumped down, the outdoor unit's **external** refrigerant piping is checked (leak test, vacuum drying) and vacuum drying on the outdoor unit's **internal** refrigerant piping is performed.

- 1 If not already done (for vacuum drying of the unit), activate the vacuum mode (see "6.6.9 To activate/deactivate the vacuum mode field setting" on page 19)
- 2 Connect the refrigerant cylinder to the service port of the liquid stop valve.
- 3 Open the liquid stop valve.
- 4 Charge the complete refrigerant amount.
- 5 Deactivate the vacuum mode (see "6.6.9 To activate/deactivate the vacuum mode field setting" on page 19).
- 6 Open the gas stop valve.

### 6.6.11 To fix the fluorinated greenhouse gases label

- 1 Fill in the label as follows:

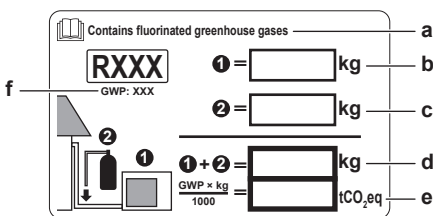

- If a multilingual fluorinated greenhouse gases label is delivered with the unit (see accessories), peel off the applicable language and stick it on top of **a**.
- Factory refrigerant charge: see unit name plate
- Additional refrigerant amount charged
- Total refrigerant charge
- Greenhouse gas emissions** of the total refrigerant charge expressed as tonnes CO<sub>2</sub>-equivalent
- GWP = Global warming potential

### NOTICE

In Europe, the **greenhouse gas emissions** of the total refrigerant charge in the system (expressed as tonnes CO<sub>2</sub>-equivalent) is used to determine the maintenance intervals. Follow the applicable legislation.

**Formula to calculate the greenhouse gas emissions:**  
GWP value of the refrigerant × Total refrigerant charge [in kg] / 1000

- 2 Fix the label on the inside of the outdoor unit. There is a dedicated place for it on the wiring diagram label.

## 6.7 Connecting the electrical wiring

### 6.7.1 About connecting the electrical wiring

#### Typical workflow

Connecting the electrical wiring typically consists of the following stages:

- 1 Making sure the power supply system complies with the electrical specifications of the units.
- 2 Connecting the electrical wiring to the outdoor unit.
- 3 Connecting the electrical wiring to the indoor units.
- 4 Connecting the main power supply.

### 6.7.2 About electrical compliance

#### RZASG71M2V1B + RZASG100~140M7V1B

Equipment complying with EN/IEC 61000-3-12 (European/International Technical Standard setting the limits for harmonic currents produced by equipment connected to public low-voltage systems with input current >16 A and ≤75 A per phase.)

#### RZASG100~140M7Y1B

Equipment complying with EN/IEC 61000-3-2 (European/International Technical Standard setting the limits for harmonic currents produced by equipment connected to public low-voltage systems with input current ≤16 A per phase.)

### 6.7.3 Precautions when connecting the electrical wiring

#### INFORMATION

Also read the precautions and requirements in the following chapters:

- General safety precautions
- Preparation

#### DANGER: RISK OF ELECTROCUTION

#### WARNING

ALWAYS use multicore cable for power supply cables.

#### CAUTION

For use of units in applications with temperature alarm settings it is recommended to foresee a delay of 10 minutes for signalling the alarm in case the alarm temperature is exceeded. The unit may stop for several minutes during normal operation for "defrosting the unit", or when in "thermostat stop" operation.

#### WARNING

Do not interchange the supply conductors L and the neutral conductor N.

### 6.7.4 Guidelines when connecting the electrical wiring

Keep the following in mind:

- If stranded conductor wires are being used, install a round crimp-style terminal on the tip. Place the round crimp-style terminal on the wire up to the covered part and fasten the terminal with the appropriate tool.

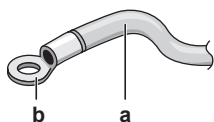

- a Stranded conductor wire
- b Round crimp-style terminal

Use the following methods for installing wires:

Wire type	Installation method
Single core wire	<ul style="list-style-type: none"> <li>a Curled single core wire</li> <li>b Screw</li> <li>c Flat washer</li> </ul>

Wire type	Installation method
Stranded conductor wire with round crimp-style terminal	<ul style="list-style-type: none"> <li>a Terminal</li> <li>b Screw</li> <li>c Flat washer</li> </ul>

### Tightening torques

Item	Tightening torque (N•m)
M4 (X1M)	1.2~1.8
M4 (earth)	1.2~1.4
M5 (X1M)	2.0~3.0
M5 (earth)	2.4~2.9

If limited space is available at the wire terminal, use bended crimp-style ring terminals.

### 6.7.5 Specifications of standard wiring components

Component		V1				Y1	
		71	100	125	140	100	125+140
Power supply cable	MCA <sup>(a)</sup>	19.4 A	24.3 A	31.3 A	30.5 A	15.9 A	16.9 A
	Voltage range	220~240 V				380~415 V	
	Phase	1~				3N~	
	Frequency	50 Hz					
	Wire sizes	Must comply with applicable legislation					
Interconnection cables		Minimum cable section of 2.5 mm <sup>2</sup> and applicable for 230 V					
Recommended field fuse		20 A	25 A	32 A		16 A	20 A
Earth leakage circuit breaker		Must comply with applicable legislation					

(a) MCA=Minimum circuit ampacity. Stated values are maximum values (see electrical data of combination with indoor units for exact values).

### 6.7.6 To connect the electrical wiring on the outdoor unit



#### NOTICE

- Follow the wiring diagram (delivered with the unit, located at the inside of the service cover).
- Make sure the electrical wiring does NOT obstruct proper reattachment of the service cover.

1 Remove the service cover. See "6.2.2 To open the outdoor unit" on page 11.

2 Strip insulation (20 mm) from the wires.

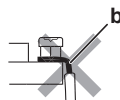
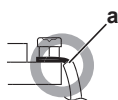

- a Strip wire end to this point
- b Excessive strip length may cause electrical shock or leakage.

3 Connect the interconnection cables and power supply as follows:

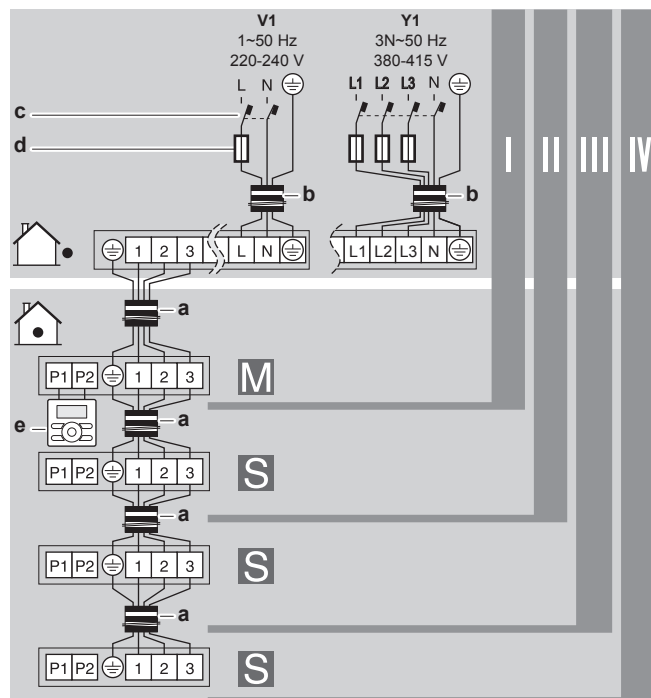

- I, II, III, IV Pair, twin, triple, double twin
- M, S Master, slave
- a Interconnection cables
- b Power supply cable
- c Earth leakage circuit breaker
- d Fuse
- e User interface

## 6 Installation

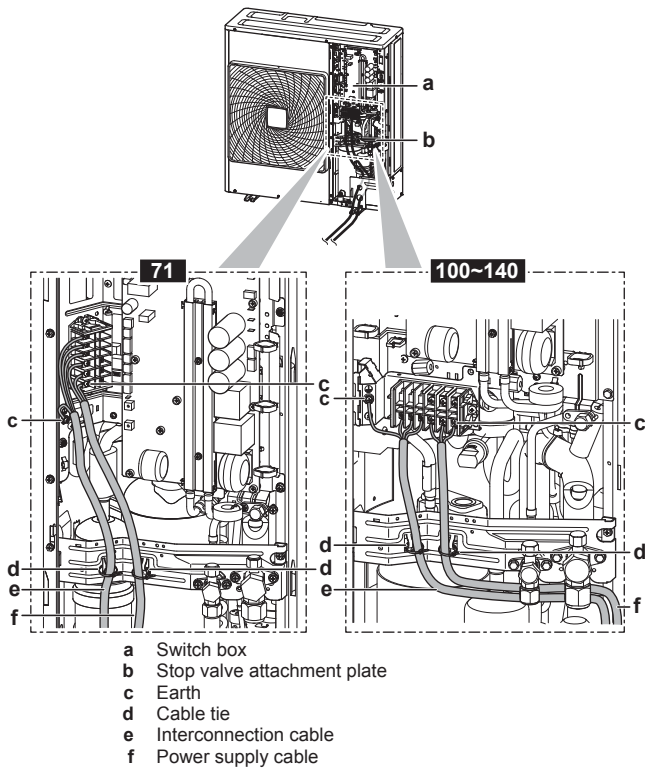

- Fix the cables (power supply and interconnection cable) with a cable tie to the stop valve attachment plate and route the wiring according to the illustration above.
- Route the wiring through the frame and connect the wiring to the frame at the knockout hole.

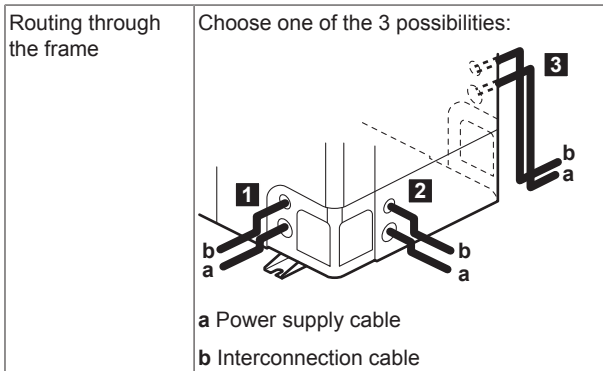

Connecting to the frame

When cables are routed from the unit, a protection sleeve for the conduits (PG insertions) can be inserted at the knockout hole.

When you do not use a wire conduit, protect the wires with vinyl tubes to prevent the edge of the knockout hole from cutting the wires.

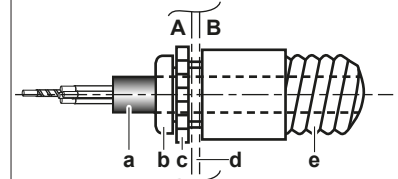

A Inside of the outdoor unit

B Outside of the outdoor unit

a Wire

b Bush

c Nut

d Frame

e Hose

- Reattach the service cover. See "6.8.2 To close the outdoor unit" on page 23.
- Connect an earth leakage circuit breaker and fuse to the power supply line.

## 6.8 Finishing the outdoor unit installation

### 6.8.1 To finish the outdoor unit installation

- Insulate and fix the refrigerant piping and interconnection cable as follows:

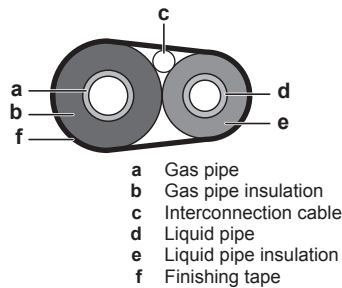

- Install the service cover.

### 6.8.2 To close the outdoor unit

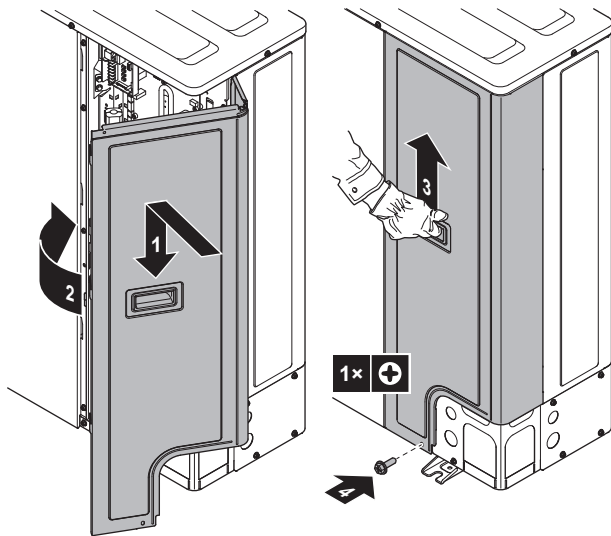

### 6.8.3 To check the insulation resistance of the compressor

#### ! NOTICE

If, after installation, refrigerant accumulates in the compressor, the insulation resistance over the poles can drop, but if it is at least 1 MΩ, then the unit will not break down.

- Use a 500 V mega-tester when measuring insulation.
- Do not use a mega-tester for low-voltage circuits.

- 1 Measure the insulation resistance over the poles.

If	Then
≥1 MΩ	Insulation resistance is OK. This procedure is finished.
<1 MΩ	Insulation resistance is not OK. Go to the next step.

- 2 Turn ON the power and leave it on for 6 hours.

**Result:** The compressor will heat up and evaporate any refrigerant in the compressor.

- 3 Measure the insulation resistance again.

## 7 Commissioning

### 7.1 Overview: Commissioning

This chapter describes what you have to do and know to commission the system after it is installed.

#### Typical workflow

Commissioning typically consists of the following stages:

- 1 Checking the "Checklist before commissioning".
- 2 Performing a test run for the system.

### 7.2 Precautions when commissioning

#### ! INFORMATION

During the first running period of the unit, the required power may be higher than stated on the nameplate of the unit. This phenomenon is caused by the compressor, that needs a continuous run time of 50 hours before reaching smooth operation and stable power consumption.

#### ! NOTICE

Before starting up the system, the unit **MUST** be energised for at least 6 hours. The crankcase heater needs to heat up the compressor oil to avoid oil shortage and compressor breakdown during startup.

#### ! NOTICE

**NEVER** operate the unit without thermistors and/or pressure sensors/switches. Burning of the compressor might result.

#### ! NOTICE

Do **NOT** operate the unit until the refrigerant piping is complete (when operated this way, the compressor will break).

#### ! NOTICE

**Cooling operation mode.** Perform the test run in cooling operation mode so that stop valves failing to open can be detected. Even if the user interface was set to heating operation mode, the unit will run in cooling operation mode during 2-3 minutes (although the user interface will display the heating icon), and then automatically switch to heating operation mode.

#### ! NOTICE

If you cannot operate the unit in test run, see ["7.5 Error codes when performing a test run" on page 24](#).

#### ! WARNING

If the panels on the indoor units are not installed yet, make sure to power OFF the system after finishing the test run. To do so, turn OFF operation via the user interface. Do **NOT** stop operation by turning OFF the circuit breakers.

### 7.3 Checklist before commissioning

Do **NOT** operate the system before the following checks are OK:

<input type="checkbox"/>	You read the complete installation instructions, as described in the <b>installer reference guide</b> .
<input type="checkbox"/>	The <b>indoor units</b> are properly mounted.
<input type="checkbox"/>	In case a wireless user interface is used: The <b>indoor unit decoration panel</b> with infrared receiver is installed.
<input type="checkbox"/>	The <b>outdoor unit</b> is properly mounted.
<input type="checkbox"/>	The following <b>field wiring</b> has been carried out according to this document and the applicable legislation: <ul style="list-style-type: none"> <li>• Between the local supply panel and the outdoor unit</li> <li>• Between the outdoor unit and the indoor unit (master)</li> <li>• Between the indoor units</li> </ul>
<input type="checkbox"/>	There are <b>NO missing phases or reversed phases</b> .
<input type="checkbox"/>	The system is properly <b>earthed</b> and the earth terminals are tightened.

## 7 Commissioning

<input type="checkbox"/>	The <b>fuses</b> or locally installed protection devices are installed according to this document, and have not been bypassed.
<input type="checkbox"/>	The <b>power supply voltage</b> matches the voltage on the identification label of the unit.
<input type="checkbox"/>	There are <b>NO loose connections</b> or damaged electrical components in the switch box.
<input type="checkbox"/>	The <b>insulation resistance</b> of the compressor is OK.
<input type="checkbox"/>	There are <b>NO damaged components</b> or <b>squeezed pipes</b> on the inside of the indoor and outdoor units.
<input type="checkbox"/>	There are <b>NO refrigerant leaks</b> .
<input type="checkbox"/>	The correct pipe size is installed and the <b>pipes</b> are properly insulated.
<input type="checkbox"/>	The <b>stop valves</b> (gas and liquid) on the outdoor unit are fully open.

### 7.4 To perform a test run

This task is only applicable when using the BRC1E52 user interface.

- When using BRC1E51, see the installation manual of the user interface.
- When using BRC1D, see the service manual of the user interface.

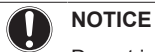

#### NOTICE

Do not interrupt the test run.





#### INFORMATION

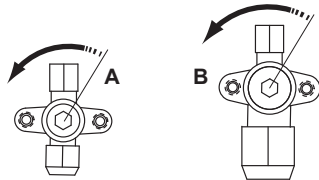

**Backlight.** To perform an ON/OFF action on the user interface, the backlight does not need to be lit. For any other action, it needs to be lit first. The backlight is lit for ±30 seconds when you press a button.

#### 1 Perform introductory steps.

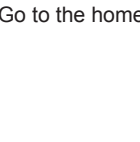
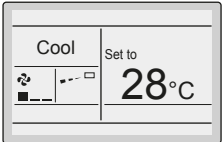
#	Action
1	Open the liquid stop valve (A) and gas stop valve (B) by removing the stem cap and turning counterclockwise with a hex wrench until it stops. 
2	Close the service cover to prevent electric shocks.
3	Turn ON power for at least 6 hours before starting operation to protect the compressor.
4	On the user interface, set the unit to cooling operation mode.



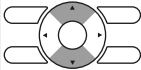
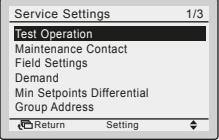
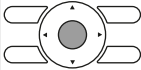
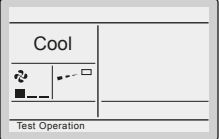

#### 2 Start the test run.

#	Action	Result
1	Go to the home menu. 	
2	Press at least 4 seconds. 	The Service Settings menu is displayed.

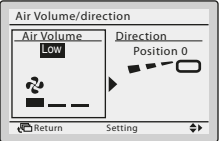

#	Action	Result
3	Select Test Operation. 	
4	Press. 	Test Operation is displayed on the home menu. 
5	Press within 10 seconds. 	Test run starts.

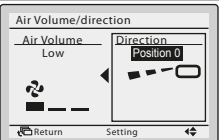
#### 3 Check operation for 3 minutes.

#### 4 Check operation of the airflow direction.

#	Action	Result
1	Press. 	
2	Select Position 0. 	
3	Change the position. 	If the airflow flap of the indoor unit moves, operation is OK. If not, operation is not OK.
4	Press. 	The home menu is displayed.

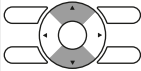
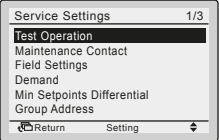
#### 5 Stop the test run.

#	Action	Result
1	Press at least 4 seconds. 	The Service Settings menu is displayed.
2	Select Test Operation. 	
3	Press. 	The unit returns to normal operation, and the home menu is displayed.

### 7.5 Error codes when performing a test run

If the installation of the outdoor unit has NOT been done correctly, the following error codes may be displayed on the user interface:



Error code	Possible cause
Nothing displayed (the currently set temperature is not displayed)	<ul style="list-style-type: none"> <li>The wiring is disconnected or there is a wiring error (between power supply and outdoor unit, between outdoor unit and indoor units, between indoor unit and user interface).</li> <li>The fuse on the outdoor unit PCB has blown out.</li> </ul>
E3, E4 or L8	<ul style="list-style-type: none"> <li>The stop valves are closed.</li> <li>The air inlet or air outlet is blocked.</li> </ul>
E7	<p>There is a missing phase in case of three-phase power supply units.</p> <p><b>Note:</b> Operation will be impossible. Turn OFF the power, recheck the wiring, and switch two of the three electrical wires.</p>
L4	The air inlet or air outlet is blocked.
U0	The stop valves are closed.
U2	<ul style="list-style-type: none"> <li>There is a voltage imbalance.</li> <li>There is a missing phase in case of three-phase power supply units. <b>Note:</b> Operation will be impossible. Turn OFF the power, recheck the wiring, and switch two of the three electrical wires.</li> </ul>
U4 or UF	The inter-unit branch wiring is not correct.
UA	The outdoor and indoor unit are incompatible.

**NOTICE**

- The reversed phase protection detector of this product only functions when the product starts up. Consequently reversed phase detection is not performed during normal operation of the product.
- The reversed phase protection detector is designed to stop the product in the event of an abnormality when the product is started up.
- Replace 2 of the 3 phases (L1, L2, and L3) during reverse-phase protection abnormality.

## 8 Hand-over to the user

Once the test run is finished and the unit operates properly, please make sure the following is clear for the user:

- Make sure that the user has the printed documentation and ask him/her to keep it for future reference. Inform the user that he can find the complete documentation on the url as earlier described in this manual.
- Explain the user how to properly operate the system and what to do in case of problems.
- Show the user what to do in relation to maintaining the unit.

## 9 Maintenance and service

**NOTICE**

Maintenance must be done by an authorised installer or service agent.

We recommend to do maintenance at least once a year. However, applicable legislation might require shorter maintenance intervals.

**NOTICE**

In Europe, the **greenhouse gas emissions** of the total refrigerant charge in the system (expressed as tonnes CO<sub>2</sub>-equivalent) is used to determine the maintenance intervals. Follow the applicable legislation.

**Formula to calculate the greenhouse gas emissions:**  
GWP value of the refrigerant × Total refrigerant charge [in kg] / 1000

### 9.1 Overview: Maintenance and service

This chapter contains information about:

- The yearly maintenance of the outdoor unit

### 9.2 Maintenance safety precautions



**DANGER: RISK OF ELECTROCUTION**



**DANGER: RISK OF BURNING**



**NOTICE: Risk of electrostatic discharge**

Before performing any maintenance or service work, touch a metal part of the unit in order to eliminate static electricity and to protect the PCB.

#### 9.2.1 To prevent electrical hazards

When performing service to inverter equipment:

- Do not open the electrical component box cover for 10 minutes after the power supply is turned off.
- Measure the voltage between terminals on the terminal block for power supply with a tester and confirm that the power supply is shut off. In addition, measure points as shown in the figure below, with a tester and confirm that the voltage of the capacitor in the main circuit is less than 50 V DC.

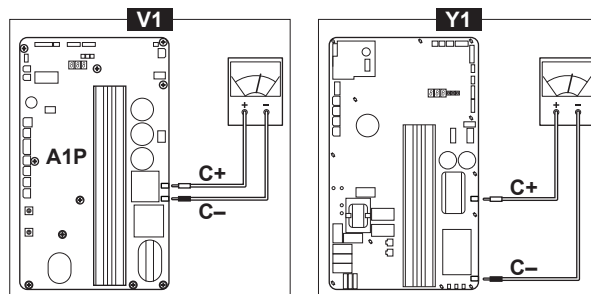

- To prevent damaging the PCB, touch a non-coated metal part to eliminate static electricity before pulling out or plugging in connectors.
- Pull out junction connectors for the fan motors in the outdoor unit before starting service operation on the inverter equipment. Be careful not to touch the live parts. (If a fan rotates due to strong wind, it may store electricity in the capacitor or in the main circuit and cause electric shock.)

Junction connectors	X106A for M1F X107A for M2F
---------------------	--------------------------------

- After the service is finished, plug the junction connector back in. Otherwise the malfunction code E7 will be displayed and normal operation will not be performed.

For details refer to the wiring diagram labelled on the back of the service cover.

## 10 Troubleshooting

- Never directly connect power supply cables to compressors (U, V, W). This can result in a compressor burnout.

### 9.3 Checklist for yearly maintenance of the outdoor unit

Check the following at least once a year:

- Outdoor unit heat exchanger.

The heat exchanger of the outdoor unit can get blocked up due to dust, dirt, leaves, etc. It is recommended to clean the heat exchanger yearly. A blocked heat exchanger can lead to too low pressure or too high pressure leading to worse performance.

## 10 Troubleshooting

### 10.1 Overview: Troubleshooting

In case of problems:

- See "7.5 Error codes when performing a test run" on page 24.
- See the service manual.

This section provides useful information for diagnosing and correcting certain problems which may occur with the unit. This troubleshooting and related corrective actions may only be carried out by the installer or service agent.

#### Before troubleshooting

Carry out a thorough visual inspection of the unit and look for obvious defects such as loose connections or defective wiring.

### 10.2 Precautions when troubleshooting

#### WARNING

- When carrying out an inspection on the switch box of the unit, always make sure that the unit is disconnected from the mains. Turn off the respective circuit breaker.
- When a safety device was activated, stop the unit and find out why the safety device was activated before resetting it. NEVER bridge safety devices or change their values to a value other than the factory default setting. If you are unable to find the cause of the problem, call your dealer.

#### DANGER: RISK OF ELECTROCUTION

#### WARNING

Prevent hazard due to the inadvertent resetting of the thermal cut-out: this appliance must NOT be supplied through an external switching device, such as a timer, or connected to a circuit that is regularly turned ON and OFF by the utility.

#### DANGER: RISK OF BURNING

## 11 Disposal

#### NOTICE

Do not try to dismantle the system yourself: the dismantling of the system, treatment of the refrigerant, oil and other parts must comply with applicable legislation. Units must be treated at a specialised treatment facility for reuse, recycling and recovery.

### 11.1 Overview: Disposal

#### Typical workflow

Disposing of the system typically consists of the following stages:

- Pumping down the system.
- Bringing the system to a specialized treatment facility.

#### INFORMATION

For more details, see the service manual.

### 11.2 About pump down

The unit is equipped with an automatic pump down function, with which you can collect all refrigerant from the system into the outdoor unit.

#### NOTICE

The outdoor unit is equipped with a low pressure switch or a low pressure sensor to protect the compressor by turning it OFF. NEVER short-circuit the low pressure switch during pump down operation.

### 11.3 To pump down

#### DANGER: RISK OF EXPLOSION

**Pump down – Refrigerant leakage.** If you want to pump down the system, and there is a leakage in the refrigerant circuit:

- Do NOT use the unit's automatic pump down function, with which you can collect all refrigerant from the system into the outdoor unit. **Possible consequence:** Self-combustion and explosion of the compressor because of air going into the operating compressor.
- Use a separate recovery system so that the unit's compressor does NOT have to operate.

#### CAUTION

Do not use the unit's automatic pump down function if the total piping length exceeds the chargeless length. A fraction of the refrigerant could be left in the circuit.

- Turn ON the main power supply switch.
- Make sure the liquid stop valve and the gas stop valve are open.
- Press the pump down button (BS2) for at least 8 seconds. BS2 is located on the PCB in the outdoor unit (see wiring diagram).

**Result:** The compressor and outdoor unit fan start automatically, and the indoor unit fan might start automatically.

- ±2 minutes after the compressor started, close the **liquid stop valve**. If it is not closed properly during compressor operation, the system cannot be pumped down.
- Once the compressor stops (after 2~5 minutes), close the **gas stop valve** within 3 minutes after the compressor has stopped.

**Result:** The pump down operation is finished. The user interface may display "U4" and the indoor pump may continue operating. This is NOT a malfunction. Even if you press the ON button on the user interface, the unit will NOT start. To restart the unit, turn OFF the main power supply switch and turn it ON again.

- Turn OFF the main power supply switch.

#### NOTICE

Make sure to reopen both stop valves before restarting the unit.

## 12 Technical data

A **subset** of the latest technical data is available on the regional Daikin website (publicly accessible). The **full set** of latest technical data is available on the Daikin extranet (authentication required).

### 12.1 Overview: Technical data

This chapter contains information about:

- Service space
- Piping diagram
- Wiring diagram

### 12.2 Service space: Outdoor unit

<b>Suction side</b>	In the illustrations below, the service space at the suction side is based on 35°C DB and cooling operation. Foresee more space in the following cases: <ul style="list-style-type: none"> <li>• When the suction side temperature regularly exceeds this temperature.</li> <li>• When the heat load of the outdoor units is expected to regularly exceed the maximum operating capacity.</li> </ul>
<b>Discharge side</b>	Take refrigerant piping work into account when positioning the units. If your layout does not match with any of the layouts below, contact your dealer.

Single unit (□) | Single row of units (◀◀◀)

	A~E	H <sub>B</sub> H <sub>D</sub> H <sub>U</sub>	(mm)								
			a	b	c	d	e	e <sub>B</sub>	e <sub>D</sub>		
	B	—		≥100							
	A, B, C	—		≥250	≥100	≥100					
	B, E	—			≥100			≥1000		≤500	
	A, B, C, E	—		≥250	≥150	≥150		≥1000		≤500	
	D	—						≥500			
	D, E	—						≥500	≥1000	≤500	
	B, D	—			≥100			≥500			
	B, D, E	H <sub>B</sub> <H <sub>D</sub>	H <sub>B</sub> ≤½H <sub>U</sub>		≥250			≥750	≥1000		≤500
			½H <sub>U</sub> <H <sub>B</sub> ≤H <sub>U</sub>		≥250			≥1000	≥1000		≤500
			H <sub>B</sub> >H <sub>U</sub>		⊘						
H <sub>B</sub> >H <sub>D</sub>	H <sub>D</sub> ≤½H <sub>U</sub>		≥100				≥1000	≥1000		≤500	
	½H <sub>U</sub> <H <sub>D</sub> ≤H <sub>U</sub>		≥200				≥1000	≥1000		≤500	
	H <sub>D</sub> >H <sub>U</sub>		⊘								
	A, B, C	—		≥250	≥300	≥1000					
	A, B, C, E	—		≥250	≥300	≥1000		≥1000		≤500	
	D	—						≥1000			
	D, E	—						≥1000	≥1000	≤500	
	B, D	H <sub>D</sub> >H <sub>U</sub>			≥300				≥1000		
			H <sub>D</sub> ≤½H <sub>U</sub>		≥250				≥1500		
			½H <sub>U</sub> <H <sub>D</sub> ≤H <sub>U</sub>		≥300				≥1500		
	B, D, E	H <sub>B</sub> <H <sub>D</sub>	H <sub>B</sub> ≤½H <sub>U</sub>		≥300				≥1000	≥1000	≤500
			½H <sub>U</sub> <H <sub>B</sub> ≤H <sub>U</sub>		≥300				≥1250	≥1000	≤500
			H <sub>B</sub> >H <sub>U</sub>		⊘						
H <sub>B</sub> >H <sub>D</sub>		H <sub>D</sub> ≤½H <sub>U</sub>		≥250				≥1000	≥1000		≤500
	½H <sub>U</sub> <H <sub>D</sub> ≤H <sub>U</sub>		≥300				≥1000	≥1000		≤500	
	H <sub>D</sub> >H <sub>U</sub>		⊘								

- A,B,C,D Obstacles (walls/baffle plates)
- E Obstacle (roof)
- a,b,c,d,e Minimum service space between the unit and obstacles A, B, C, D and E
- e<sub>B</sub> Maximum distance between the unit and the edge of obstacle E, in the direction of obstacle B
- e<sub>D</sub> Maximum distance between the unit and the edge of obstacle E, in the direction of obstacle D
- H<sub>U</sub> Height of the unit
- H<sub>B</sub>,H<sub>D</sub> Height of obstacles B and D
- 1 Seal the bottom of the installation frame to prevent discharged air from flowing back to the suction side through the bottom of the unit.
- 2 Maximum two units can be installed.
- ⊘ Not allowed

## 12 Technical data

### Multiple rows of units ( )

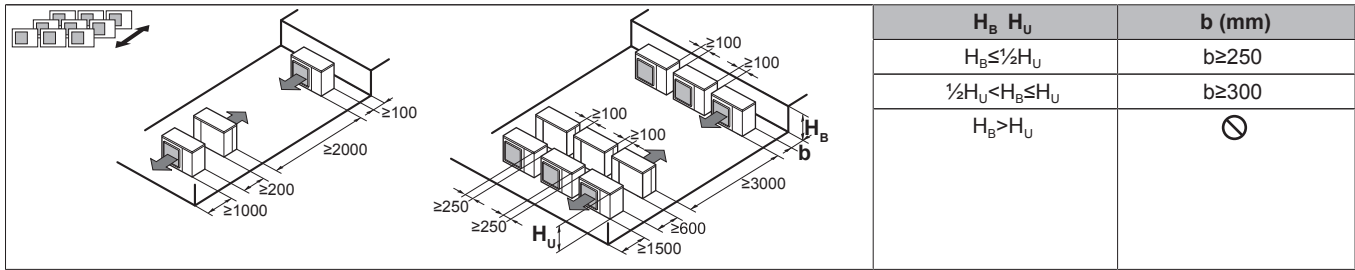



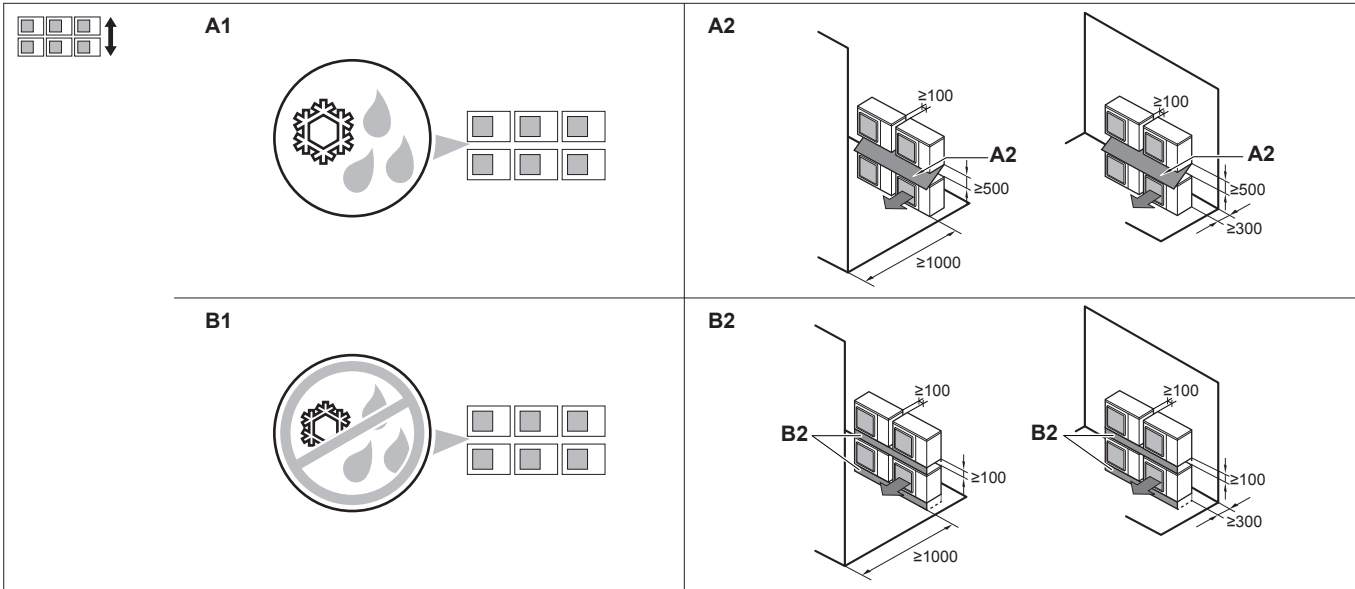

### Stacked units (max. 2 levels) ( )



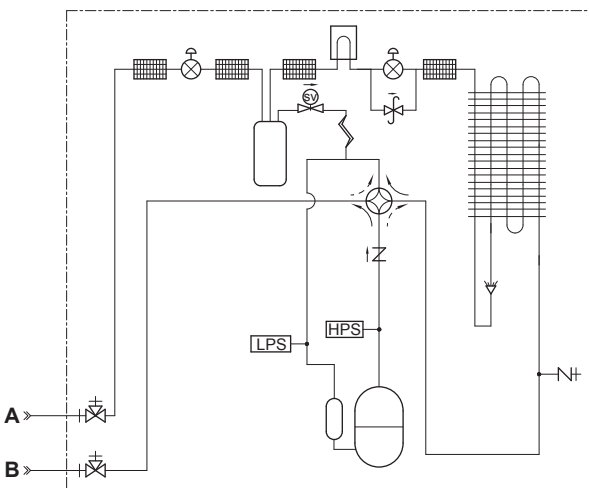









- A1=>A2** (A1) If there is danger of drainage dripping and freezing between the upper and lower units...  
 (A2) Then install a **roof** between the upper and lower units. Install the upper unit high enough above the lower unit to prevent ice buildup at the upper unit's bottom plate.
- B1=>B2** (B1) If there is no danger of drainage dripping and freezing between the upper and lower units...  
 (B2) Then it is not required to install a roof, but **seal the gap** between the upper and lower units to prevent discharged air from flowing back to the suction side through the bottom of the unit.

## 12.3 Piping diagram: Outdoor unit



-  Charge port / Service port (with 5/16" flare)
-  Stop valve
-  Filter

-  Check valve
-  Pressure relief valve
-  Solenoid valve
-  Heat sink (PCB)
-  Capillary tube
-  Electronic expansion valve
-  4-way valve
-  High pressure switch
-  Low pressure switch
-  Compressor accumulator
-  Heat exchanger

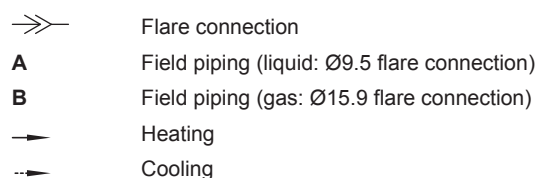
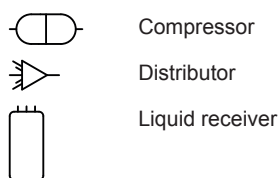

## 12.4 Wiring diagram: Outdoor unit

The wiring diagram is delivered with the unit, located at the inside of the service cover.

### (1) Connection diagram

English	Translation
Connection diagram	Connection diagram
Only for ***	Only for ***
See note ***	See note ***
Outdoor	Outdoor
Indoor	Indoor
Upper	Upper
Lower	Lower
Fan	Fan
ON	ON
OFF	OFF

### (2) Layout

English	Translation
Layout	Layout
Front	Front
Back	Back
Position of compressor terminal	Position of compressor terminal

### (3) Notes

English	Translation
Notes	Notes
	Connection
X1M	Indoor/outdoor communication
-----	Earth wiring
-----	Field supply
①	Several wiring possibilities
	Protective earth
	Field wire
	Wiring depending on model
	Option
	Switch box
	PCB

#### NOTES:

- 1 Refer to the wiring diagram sticker (on the back of the front plate) for how to use the BS1~BS3 and DS1 switches.
- 2 When operating, do not short-circuit protective devices S1PH, S1PL and Q1E.
- 3 Refer to the combination table and the option manual for how to connect the wiring to X6A, X28A and X77A.
- 4 Colours: BLK: black, RED: red, BLU: blue, WHT: white, GRN: green

### (4) Legend

English	Translation
Legend	Legend
Field supply	Field supply
Optional	Optional
Part n°	Part n°
Description	Description

A1P	Printed circuit board (main)
A2P	Printed circuit board (noise filter)
BS1~BS3 (A1P)	Push button switch
C1~C5 (A1P) (Y1 only)	Capacitor
DS1 (A1P)	Dipswitch
E1H	Bottom plate heater (option)
F*U	Fuse
HAP (A1P)	Light-emitting diode (service monitor is green)
K1M, K3M (A1P) (Y1 only)	Magnetic contactor
K1R (A1P)	Magnetic relay (Y1S)
K2R (A1P)	Magnetic relay (Y2S)
K4R (A1P)	Magnetic relay (E1H)
K10R, K13R~K15R (A1P)	Magnetic relay
K11M (A1P) (V1 only)	Magnetic contactor
L1R (Y1 only)	Reactor
M1C	Compressor motor
M1F~M2F	Fan motor
PFC (A1P) (V1 only)	Power factor correction
PS (A1P)	Switching power supply
Q1DI	Earth leakage circuit breaker (30 mA)
Q1E	Overload protection
R1~R8 (A1P) (Y1 only)	Resistor
R1T	Thermistor (air)
R2T	Thermistor (discharge)
R3T	Thermistor (suction)
R4T	Thermistor (heat exchanger)
R5T	Thermistor (heat exchanger middle)
R6T	Thermistor (liquid)
R7T	Thermistor (fin)
R8 (A1P) (V1 only)	Resistor
RC (A1P) (Y1 only)	Signal receiver unit
S1PH	High pressure switch
S1PL	Low pressure switch
SEG1~SEG3	7-segment display

## 13 Glossary

---

TC1 (A1P) (V1 only)	Signal transmission circuit
TC (A1P) (Y1 only)	Signal transmission circuit
V1 (V1 only)	Varistor
V1D (A1P) (V1 only)	Diode
V1D~V2D (A1P) (Y1 only)	Diode
V*R (V1 only)	Diode module
V1R, V2R (A1P) (Y1 only)	Diode module
V3R~V5R (A1P) (Y1 only)	IGBT power module
X1M	Terminal strip
Y1E~Y3E	Electronic expansion valve
Y1S~Y2S	Solenoid valve (4-way valve)
Z*C	Noise filter (ferrite core)
Z*F	Noise filter
L*, L*A, L*B, NA, NB, E*, U, V, W, X*A (A1P~A2P)	Connector

### Field supply

Equipment not made by Daikin that can be combined with the product according to the instructions in the accompanying documentation.

## 13 Glossary

### Dealer

Sales distributor for the product.

### Authorized installer

Technical skilled person who is qualified to install the product.

### User

Person who is owner of the product and/or operates the product.

### Applicable legislation

All international, European, national and local directives, laws, regulations and/or codes that are relevant and applicable for a certain product or domain.

### Service company

Qualified company which can perform or coordinate the required service to the product.

### Installation manual

Instruction manual specified for a certain product or application, explaining how to install, configure and maintain it.

### Operation manual

Instruction manual specified for a certain product or application, explaining how to operate it.

### Maintenance instructions

Instruction manual specified for a certain product or application, which explains (if relevant) how to install, configure, operate and/or maintain the product or application.

### Accessories

Labels, manuals, information sheets and equipment that are delivered with the product and that need to be installed according to the instructions in the accompanying documentation.

### Optional equipment

Equipment made or approved by Daikin that can be combined with the product according to the instructions in the accompanying documentation.



ERC

Copyright 2017 Daikin