SPLIT SYSTEM
VRV* SYSTEM*Air Conditioners**
Air Conditioners

MODELS
(4-Way Blow Ceiling Suspended type)

SPLIT SYSTEM**VRV SYSTEM**

FUQ71CVEB
FUQ100CVEB
FUQ125CVEB

FXUQ71AVEB
FXUQ100AVEB

English

Deutsch

Français

Español

Italiano

Ελληνικά

Nederlands

Português

Русский

Türkçe

Thank you for purchasing this product.
Carefully read this operation manual to ensure proper operation.
After reading the manual, file it away for future reference.
Furthermore, make certain that this operation manual is handed to a new user when he takes over the operation.
As this operation manual is dedicated for the indoor unit, refer to also the operation manuals attached to the outdoor unit and the remote controller.

Vielen Dank für den Kauf dieses Produktes.
Lesen Sie diese Betriebsanleitung sorgfältig um einwandfreien Gebrauch zu garantieren.
Nach dem Lesen der Bedienungsanleitung, bewahren Sie diese an einem sicheren Ort auf um ggf. darauf zurück zu greifen.
Bitte händigen Sie diese Betriebsanleitung an jede neue Person aus, die für den Betrieb verantwortlich ist.
Diese Betriebsanleitung ist für das Innenaggregat. Dem Außenaggregat und der Fernbedienung liegt eine separate Betriebsanleitung bei.

Merci d'avoir acheté ce produit.
Veuillez lire attentivement ce manuel de fonctionnement pour être sûr d'utiliser le produit correctement.
Après avoir lu le manuel d'utilisation, conservez-le afin de pouvoir vous y reporter ultérieurement.
En outre, assurez-vous que le manuel de fonctionnement soit transmis au nouvel opérateur lorsqu'il reprend l'exploitation du produit.
Puisque ce manuel de fonctionnement concerne uniquement l'unité intérieure, reportez-vous également aux manuels de fonctionnement joints à l'unité extérieure et à la télécommande.

Gracias por adquirir este producto.
A fin de garantizar un funcionamiento correcto, lea detenidamente este manual de instrucciones.
Una vez leído, guárdelo para futuras consultas.
Asimismo, asegúrese de entregar este manual de instrucciones a un nuevo usuario.
Debido a que este manual de instrucciones está dedicado a la unidad interior, deberá consultar, también, los manuales de instrucciones facilitados con la unidad exterior y el mando a distancia.

Vi ringraziamo per aver acquistato questo prodotto.
Per garantire un corretto funzionamento del dispositivo, si prega di leggere attentamente questo manuale d'uso.
Dopo aver letto il manuale, conservarlo per riferimento futuro.
Assicurarsi inoltre di consegnare questo manuale d'uso ad un nuovo utente che provi a utilizzare il dispositivo.
Dal momento che questo manuale d'uso concerne l'unità interna, si prega di consultare anche i manuali d'uso forniti unitamente all'unità esterna e al comando a distanza.

Σας ευχαριστούμε που αγοράσατε αυτό το προϊόν.
Διαβάστε προσεκτικά αυτό το εγχειρίδιο λειτουργίας για να διασφαλιστεί η σωστή λειτουργία.
Μετά την ανάγνωση του εγχειριδίου, φυλάξτε το για μελλοντική αναφορά.
Επιπλέον, βεβαιωθείτε ότι το παρόν εγχειρίδιο χρήσης μεταβιβάζεται στο νέο χρήστη, όταν αυτός αναλαμβάνει τη λειτουργία.
Επειδή το παρόν εγχειρίδιο λειτουργίας αφορά στην εσωτερική μονάδα, ανατρέξτε επίσης στα συνοδευτικά εγχειρίδια λειτουργίας της εξωτερικής μονάδας και του τηλεχειριστηρίου.

Hartelijk dank voor uw aankoop van dit product.
Lees deze bedieningshandleiding zorgvuldig door om een goede werking te garanderen.
Bewaar de handleiding, zodat u deze later nog kunt raadplegen.
Vergeet niet deze bedieningshandleiding door te geven aan een nieuwe gebruiker wanneer deze de bediening overneemt.
Deze bedieningshandleiding heeft betrekking op de binneneenheid. Zie ook de bedieningshandleidingen voor de buiteneenheid en de afstandsbediening.

Obrigado por ter adquirido este produto.
Leia atentamente este manual do funcionamento para garantir uma operação adequada.
Depois de ler o manual guarde-o para referência futura.
Além disso, certifique-se de que este manual do funcionamento é entregue a um novo utilizador quando este fica encarregue da operação.
Como este manual de funcionamento é específico para a unidade interior, consultar também os manuais de funcionamento, que acompanham a unidade exterior e o controlo remoto.

Спасибо, что выбрали нашу продукцию.
Для правильной эксплуатации устройства внимательно прочтите данное руководство.
Сохраните руководство для дальнейшего использования.
Кроме того, данное руководство по эксплуатации следует передать новому пользователю, если эксплуатировать устройство будет другой человек.
Поскольку данное руководство по эксплуатации посвящено только внутреннему блоку, см. также руководства по эксплуатации, имеющиеся в комплекте с внешним блоком и пультом дистанционного управления.

Bu ürünü satın aldığınız için teşekkür ederiz.
Düzgün çalıştırma için bu kullanım kılavuzunu dikkatlice okuyun.
Kılavuzu okuduktan sonra daha sonra bakmak üzere kaldırın.
Ayrıca, ürünü başka bir kullanıcıya satarsanız bu kullanım kılavuzunu da verdiğinizden emin olun.
Bu kullanım kılavuzu bir iç ünite ile ilgili olduğundan, dış ünite ve uzaktan kumanda ile ilgili kullanım kılavuzlarına da bakın.

■ DISPOSAL REQUIREMENTS ■ VORSCHRIFTEN ZUR ENTSORGUNG ■ INSTRUCTIONS D'ÉLIMINATION
■ REQUISITOS PARA LA ELIMINACIÓN ■ SPECIFICHE DI SMALTIMENTO ■ ΠΡΟΫΠΟΘΕΣΕΙΣ ΑΠΟΡΡΙΨΗΣ
■ VEREISTEN VOOR HET OPRUIJEN ■ REQUISITOS PARA A ELIMINAÇÃO

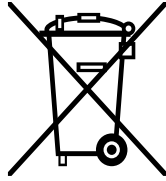

(GB) Disposal requirements

Your air conditioning product is marked with this symbol. This means that electrical and electronic products shall not be mixed with unsorted household waste.

Do not try to dismantle the system yourself: the dismantling of the air conditioning system, treatment of the refrigerant, of oil and of other parts must be done by a qualified installer in accordance with relevant local and national legislation.

Air conditioners must be treated at a specialized treatment facility for re-use, recycling and recovery. By ensuring this product is disposed of correctly, you will help to prevent potential negative consequences for the environment and human health. Please contact the installer or local authority for more information.

Batteries must be removed from the remote controller and disposed of separately in accordance with relevant local and national legislation.

(D) Vorschriften zur Entsorgung

Ihre Klimaanlage ist mit diesem Symbol gekennzeichnet. Das bedeutet, dass elektrische und elektronische Produkte nicht mit unsortiertem Haushaltsabfall entsorgt werden dürfen.

Versuchen Sie auf keinen Fall das System selbst zu demontieren. Die Demontage des Klimaanlage-Systems sowie die Handhabung von Kältemitteln, Öl und möglichen weiteren Teilen muss von einem qualifizierten Monteur gemäß den entsprechenden örtlichen und staatlichen Bestimmungen vorgenommen werden.

Klimaanlagen müssen bei einer fachkundigen Einrichtung für Wiederverwendung, Recycling und Wiedergewinnung aufbereitet werden. Indem Sie dieses Produkt korrekt entsorgen, helfen Sie potenzielle negative Folgen für die Umwelt und die Gesundheit der Menschen zu vermeiden. Nehmen Sie bitte hinsichtlich weiterer Informationen Kontakt auf mit dem Monteur oder den örtlichen Behörden.

Die Batterien müssen aus der Fernbedienung entfernt werden und gemäß den entsprechenden örtlichen und staatlichen Vorschriften separat entsorgt werden.

(F) Instructions d'élimination

Cet appareil de conditionnement d'air porte le symbole ci-joint. Ce symbole signifie que les appareils électriques et électroniques doivent être éliminés séparément des ordures ménagères non triées.

N'essayez pas de démonter vous-même l'appareil : le démontage de l'appareil de conditionnement d'air ainsi que le traitement du réfrigérant, de l'huile et d'autres composants doivent être effectués par un installateur qualifié, en accord avec les réglementations locales et nationales en vigueur.

Les appareils de conditionnement d'air doivent être traités dans des installations spécialisées de dépannage, réutilisation ou recyclage. En vous assurant que cet appareil est éliminé correctement, vous contribuez à éviter les conséquences potentiellement néfastes sur l'environnement et la santé. Veuillez contacter votre installateur ou les autorités locales pour plus d'information.

Les piles de la télécommande doivent être enlevées et éliminées séparément, conformément aux réglementations locales et nationales en vigueur.

(E) Requisitos para la eliminación

Su acondicionador de aire está marcado con este símbolo. Esto significa que los productos eléctricos y electrónicos no deben mezclarse con el resto de residuos domésticos no clasificados.

No intente desmontar el sistema usted mismo: El desmantelamiento del acondicionador de aire, así como el tratamiento del refrigerante, aceite y otros componentes, debe ser efectuado por un instalador competente de acuerdo con las normas locales y nacionales aplicables.

Los acondicionadores de aire deben ser tratados en instalaciones especializadas para su reutilización, reciclaje y recuperación. Al asegurarse de desechar este producto de la forma correcta, está contribuyendo a evitar posibles consecuencias negativas para el entorno y para la salud de las personas. Contacte, por favor, con el instalador o con las autoridades locales para obtener más información.

Las pilas del control remoto deben extraerse y eliminarse por separado y de acuerdo con la normativa local y nacional aplicable.

(I) Specifiche di smaltimento

Il climatizzatore è contrassegnato con questo simbolo, ciò significa che i prodotti elettrici ed elettronici non possono essere smaltiti insieme ai rifiuti domestici non differenziati.

Non cercare di rimuovere il sistema da soli: la rimozione del sistema di condizionamento, nonché il recupero del refrigerante, dell'olio e di qualsiasi altra parte devono essere eseguiti da un installatore qualificato in conformità alla legislazione locale e nazionale vigente in materia.

I climatizzatori devono essere trattati presso una struttura specializzata nel riutilizzo, riciclaggio e recupero dei materiali. Il corretto smaltimento del prodotto eviterà le possibili conseguenze negative all'ambiente e alla salute dell'uomo. Per maggiori informazioni contattare l'installatore o le autorità locali.

Le batterie devono essere tolte dal telecomando e smaltite separatamente conformemente alla legislazione locale e nazionale vigente in materia.

(GR) Προϋποθέσεις απόρριψης

Το κλιματιστικό σας επισημαίνεται με αυτό το σύμβολο. Αυτό σημαίνει ότι οι ηλεκτρικές και ηλεκτρονικές συσκευές πρέπει να απορρίπτονται χωριστά από τα οικιακά απορρίμματα.

Μην προσπαθήσετε να αποσυναρμολογήσετε μόνοι σας το σύστημα: Η αποσυναρμολόγηση της μονάδας κλιματισμού, ο χειρισμός του ψυκτικού μέσου, του λαδιού και των άλλων μερών θα πρέπει να γίνεται από κάποιο ειδικευμένο τεχνικό, σύμφωνα με τη σχετική τοπική και εθνική νομοθεσία.

Για την εκ νέου χρήση, την ανακύκλωση και την επισκευή, οι μονάδες κλιματισμού θα πρέπει να υφίστανται επεξεργασία σε ειδικές εγκαταστάσεις. Επιβεβαιώνοντας ότι αυτό το προϊόν απορρίπτεται σωστά, θα αποφύγετε ενδεχόμενες αρνητικές συνέπειες για το περιβάλλον και την υγεία. Παρακαλώ επικοινωνήστε με τον τεχνικό εγκατάστασης ή τις τοπικές αρχές για περισσότερες πληροφορίες. Οι μπαταρίες θα πρέπει να αφαιρούνται από το τηλεχειριστήριο και να απορρίπτονται ξεχωριστά, σύμφωνα με τη σχετική τοπική και εθνική νομοθεσία.

(NL) Vereisten voor het opruimen

Uw airconditioningproduct draagt dit symbool. Dit betekent dat u geen elektrische en elektronische producten mag mengen met niet-gesorteed huishoudelijk afval.

Probeer niet zelf het systeem te ontmantelen: het ontmantelen van het airconditioningsysteem, behandelen van het koelmiddel, olie en andere onderdelen moet worden uitgevoerd door een bevoegd installateur in overeenstemming met de relevante lokale en nationale reglementeringen.

Airconditioners moeten bij een gespecialiseerd behandlingsbedrijf worden behandeld voor hergebruik, recyclage en terugwinning. Door ervoor te zorgen dat dit product op de correcte manier wordt opgeruimd, helpt u potentiële negatieve gevolgen voor het milieu en de gezondheid te voorkomen.

Voor meer informatie, gelieve contact op te nemen met de installateur of de lokale overheid.

De batterijen moeten uit de afstandsbediening worden verwijderd en afzonderlijk opgeruimd in overeenstemming met de relevante lokale en nationale reglementeringen.

(P) Requisitos para a eliminação

O equipamento de ar condicionado que possui está marcado com este símbolo. Significa que os produtos eléctricos e electrónicos não devem ser misturados com o lixo doméstico indiferenciado.

Não tente desmontar pessoalmente o sistema: o desmantelamento do sistema de ar condicionado e o tratamento do líquido de refrigeração, do óleo e de outros componentes têm de ser feitos por um instalador qualificado, cumprindo a legislação nacional relevante e regulamentos locais aplicáveis.

Os equipamentos de ar condicionado têm de ser processados numa estação de tratamento especializada, para reutilização, reciclagem ou recuperação. Ao certificar-se de que este produto é eliminado correctamente, está a contribuir para evitar as potenciais consequências negativas para o ambiente e para a saúde humana. Contacte o seu instalador ou as autoridades locais, para obter mais informações.

As pilhas do controlo remoto têm de ser retiradas e eliminadas separadamente, cumprindo a legislação nacional e os regulamentos locais aplicáveis.

CONTENTS

1. SAFETY PRECAUTIONS.....	1
2. WHAT TO DO BEFORE OPERATION.....	3
3. OPERATION RANGE.....	5
4. INSTALLATION SITE.....	5
5. OPERATION PROCEDURE.....	6
6. OPERATION CHARACTERISTICS.....	6
7. OPTIMUM OPERATION.....	8
8. MAINTENANCE (FOR SERVICE PERSONNEL).....	9
9. NOT MALFUNCTION OF THE AIR CONDITIONER.....	12
10. TROUBLE SHOOTING.....	14

The original instructions are written in English. All other languages are translations of the original instructions.

Important information regarding the refrigerant used

This product contains fluorinated greenhouse gases covered by the Kyoto Protocol.

Refrigerant type : R410A

GWP⁽¹⁾ value : 1975

⁽¹⁾GWP = global warming potential

Periodical inspections for refrigerant leaks may be required depending on European or local legislation. Please contact your local dealer for more information.

1. SAFETY PRECAUTIONS

To gain full advantage of the air conditioner's functions and to avoid malfunction due to mishandling, please read this operation manual carefully before use.

This product comes under the term "appliances not accessible to the general public".

This appliance is intended to be used by expert or trained users in shops, in light industry and on farms, or for commercial use by lay persons.

This appliance can be used by children aged from 8 years and above and persons with reduced physical, sensory or mental capabilities or lack of experience and knowledge if they have been given supervision or instruction concerning use of the appliance in a safe way and understand the hazards involved. Children shall not play with the appliance. Cleaning and user maintenance shall

only be done by persons described in manual.

The appliance is not intended for use by unattended young children or persons who are incompetent to operate air conditioners.

It may result in injury or electric shocks.

- **This manual classifies the precautions into WARNINGS and CAUTIONS. Be sure to follow all the precautions below: They are all important for ensuring safety.**

⚠ WARNING Indicates a potentially hazardous situation which, if not avoided, could result in death or serious injury.

⚠ CAUTION Indicates a potentially hazardous situation which, if not avoided, may result in minor or moderate injury.
It may also be used to alert against unsafe practices.

- **After reading, keep this manual in a convenient place so that you can refer to it whenever necessary. If the equipment is transferred to a new user, be sure also to hand over the manual.**

⚠ WARNING

When the air conditioner is malfunctioning (giving off a burning odor, etc.), turn off the power to the air conditioner and contact your local dealer.

Continued operation under such circumstances may result in a failure, electric shocks or a fire.

Consult your local dealer regarding modification, repair and maintenance of the air conditioner.

Improper workmanship may result in water leakage, electric shocks or a fire.

Be sure to use fuses with the correct ampere reading.

Do not use improper fuses, copper or other wiring as a substitute, as this may result in electric shocks, a fire, injury or damage to the air conditioner.

Consult your local dealer if the air conditioner submerges owing to a natural disaster, such as a flood or typhoon.

Do not operate the air conditioner in that case, or otherwise a malfunction, electric shocks, or a fire may result.

Start or stop the air conditioner with the remote controller. Never use the power circuit breaker for this purpose.

Otherwise, it may cause a fire or water leakage. Furthermore, if an automatic restart control is provided against power failure and the power is recovered, the fan will rotate suddenly and may cause injury.

Do not use the air conditioner in the atmosphere contaminated with oil vapor, such as cooking oil or machine oil vapor.

Oil vapor may cause crack damage to the air conditioner, electric shocks, or a fire.

Do not use flammable materials (e.g., hairspray or insecticide) near the air conditioner.

Do not clean the air conditioner with organic solvents such as paint thinner.

The use of organic solvents may cause crack damage to the air conditioner, electric shocks, or a fire.

Do not use the air conditioner in places with excessive oily smoke, such as cooking rooms, or in places with flammable gas, corrosive gas, or metal dust.

Using the air conditioner in such places may cause a fire or air conditioner failures.

Beware of a fire in case of refrigerant leakage.

If the air conditioner is not operating correctly, i.e. not generating cool or warm air, refrigerant leakage could be the cause. Consult your local dealer for assistance. The refrigerant used for the air conditioner is safe and normally does not leak. However, if the refrigerant leaks and gets in contact with a naked burner, heater or cooker, it may generate hazardous compounds. Turn off the air conditioner and call your local dealer. Turn on the air conditioner after the qualified service person makes sure to confirm that the leakage is repaired.

Do not place objects, including rods, your fingers, etc., in the air inlet or outlet.

Injury may result due to contact with the air conditioner's highspeed fan blades.

Consult your local dealer regarding cleaning the inside of the air conditioner.

Improper cleaning may cause breakage of plastic parts, water leakage and other damage as well as electric shocks.

Be aware that prolonged, direct exposure to cool or warm air from the air conditioner, or to air that is too cool or too warm can be harmful to your physical condition and health.

Consult your local dealer about installation work.

Doing the work yourself may result in water leakage, electric shocks or a fire.

Contact professional personnel about attachment of accessories and be sure to use only accessories specified by the manufacturer.

If a defect results from your own workmanship, it may result in water leakage, electric shocks or a fire.

Consult your local dealer regarding relocation and reinstallation of the air conditioner.

Improper installation work may result in leakage, electric shocks or a fire.

Be sure to earth the air conditioner.

Do not earth the air conditioner to a utility piping, lightning conductor or telephone earth lead.

Imperfect earthing may result in electric shocks or a fire. A high surge current from lightning or other sources may cause damage to the air conditioner.

Be sure to install an earth leakage breaker.

Failure to install an earth leakage breaker may result in electric shocks or a fire.

Be sure to use a dedicated power supply for the air conditioner.

The use of any other power supply may cause heat generation, a fire, or air conditioner failures.

Consult your local dealer regarding what to do in case of refrigerant leakage.

When the air conditioner is installed in a small room, it is necessary to take proper measures so that the amount of any leaked refrigerant does not exceed the concentration limit in the event of a leakage. Otherwise, this may lead to an accident due to oxygen depletion.

CAUTION

Children should be watched so that they do not play with the indoor unit or its remote controller.

Accidental operation by a child may result in injury or electric shocks.

Do not allow a child to mount on the outdoor unit or avoid placing any object on it.

Falling or tumbling may result in injury.

Do not let children play on or around the outdoor unit.

If they touch the unit carelessly, injury may be caused.

Be sure that children, plants or animals are not exposed directly to airflow from the indoor unit, as adverse effects may ensue.

Do not place flammable sprays or operate spray containers near the air conditioner as this may result in a fire.

Do not wash the air conditioner or the remote controller with water, as this may result in electric shocks or fire.

Do not place water containers (flower vases, etc.) on the indoor unit, as this may result in electric shocks or a fire.

Do not put flammable containers, such as spray cans, within 1 m from the air outlet.

The containers may explode because the warm air from the indoor or outdoor unit will affect them.

Turn off the power when the air conditioner is not used for long periods of time.

Otherwise, the air conditioner may get hot or catch on a fire due to dust accumulation.

Do not place objects in direct proximity of the outdoor unit and do not let leaves and other debris accumulate around the unit.

Leaves are a hotbed for small animals which can enter the unit. Once in the unit, such animals can cause malfunctions, smoke or a fire when making contact with electrical parts.

Before cleaning, be sure to stop the air conditioner operation, turn the power circuit breaker off.

Otherwise, an electric shocks and injury may result.

To avoid electric shocks, do not operate with wet hands.

Never touch the internal parts of the remote controller.

Touching certain internal parts will cause electric shocks and damage to the remote controller. Consult your local dealer about checking and adjustment of internal parts.

To avoid oxygen deficiency, ensure that the room is adequately ventilated if equipment such as a burner is used together with the air conditioner.

Do not leave the remote controller wherever there is a risk of wetting.

If water gets into the remote controller there is a risk of electrical leakage and damage to electronic components.

Watch your steps at the time of air filter cleaning or inspection.

High-place work is required, to which utmost attention must be paid.

If the scaffold is unstable, you may fall or topple down, thus causing injury.

Do not remove the outdoor unit's outlet side grille.

The grille protects against the unit's high speed fan, which may cause injury.

To avoid injury, do not touch the air inlet or aluminum fins of the air conditioner.

Do not place objects that are susceptible to moisture directly beneath the indoor or outdoor units.

Under certain conditions, condensation on the unit or refrigerant piping, air filter dirt or drain blockage may cause dripping, resulting in fouling or failure of the object concerned.

Do not place heaters directly below the indoor unit, as resulting heat can cause deformation.

Do not place appliances that produce naked flames in places exposed to the airflow from the air conditioner as this may impair combustion of the burner.

Do not block air inlets nor outlets.

Impaired airflow may result in insufficient performance or trouble.

Do not use the air conditioner for purposes other than those for which it is intended.

Do not use the air conditioner for cooling precision instruments, food, plants, animals or works of art as this may adversely affect the performance, quality and/or longevity of the object concerned.

Do not install the air conditioner at any place where there is a danger of flammable gas leakage.

In the event of a gas leakage, build-up of gas near the air conditioner may result in a fire.

Carry out drain piping properly to ensure complete drainage.

If drain piping is not carried out properly, drain will not flow out. Then, dirt and debris may be accumulated in the drain piping and may cause water leakage. If it occurs, stop the air conditioner and call your local dealer for assistance.

• NOTE TO SERVICE PERSONNEL

⚠ WARNING

⚠ RISK OF ELECTRIC SHOCKS OR A FIRE

- When checking the electric components (such as the inside of the control box, fan motor, drain pump, etc.), make sure to shut off all power supply for the air conditioner (including both indoor and outdoor units).
- When cleaning the heat exchanger, make sure to remove the electronic components above (If they get cleaning agent, there is a risk that the components will burn out because of insulation degradation).

⚡ CAUTION! DANGER OF ELECTRIC SHOCKS

- Shut off power supply before work.
- Never open the control box lid for 10 minutes after shutting off the power supply because there is residual voltage.
- After opening the control box lid, measure residual voltage between the points shown **Fig. 1** on the Printed Circuit Board by the tester without

touching the live part and confirm that the residual voltage is DC50V or below.

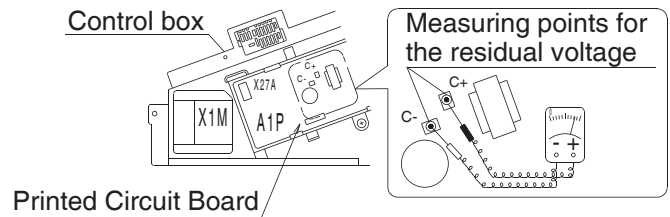

Fig. 1

- After power failure, operation will restart automatically.

2. WHAT TO DO BEFORE OPERATION

This operation manual is for the following systems with standard control.

Before initiating operation, contact your local dealer for the operation that corresponds to your system.

2-1. FUQ

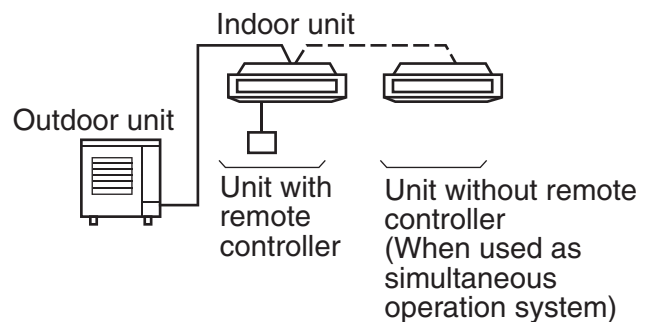

NOTE

- Read the operation manual attached to the remote controller you are using.

When using a wireless remote controller, refer to the operation manual attached to the wireless remote controller kit.

If your installation has a customized control system, ask your local dealer for the operation that corresponds to your system.

- Heat pump type
This system provides COOLING, HEATING, AUTOMATIC, PROGRAM DRY, and FAN OPERATION modes.
- Cooling only type
This system provides COOLING, PROGRAM DRY, and FAN OPERATION modes.

PRECAUTIONS FOR GROUP CONTROL SYSTEM OR TWO REMOTE CONTROLLERS CONTROL SYSTEM

This system provides two other control systems beside individual control (one remote controller controls one indoor unit) system. Confirm the following if your unit is the following control system type.

- **Group control system**

One remote controller controls up to 16 indoor units. All indoor units are equally set.

- **Two remote controllers control system**

Two remote controllers control one indoor unit (In case of group control system, one group of indoor units).

NOTE 

- Contact your local dealer in case of changing the combination or setting of group control and two remote controllers control systems.
- Please do not change the combination and settings for the group operation and two remote controllers control systems by yourself, but be sure to ask your local dealer.

2-2. FXUQ

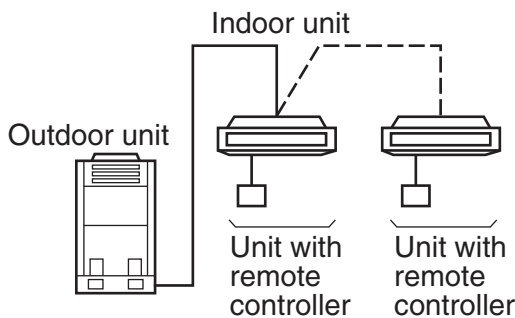

NOTE 

- Read the operation manual attached to the outdoor unit and remote controller you are using.

When using a wireless remote controller, refer to the operation manual attached to the wireless remote controller kit.

If your installation has a customized control system, ask your local dealer for the operation that corresponds to your system.

PRECAUTIONS FOR GROUP CONTROL SYSTEM OR TWO REMOTE CONTROLLER CONTROL SYSTEM

This system provides two other control systems beside individual control (one remote controller controls one indoor unit) system. Confirm the following if your unit is the following control system type.

- **Group control system**

One remote controller controls up to 16 indoor units. Each indoor unit uses its respective inlet temperature sensor to individually control the temperature according to the set temperature on the remote controller.

- **Two remote controllers control system**

Two remote controllers control one indoor unit (In case of group control system, one group of indoor units).

The unit is individually operated.

NOTE 

- Contact your local dealer in case of changing the combination or setting of group control and two remote controllers control systems.
- Please do not change the combination and settings for the group operation and two remote controllers control systems by yourself, but be sure to ask your local dealer.

Names and functions of parts

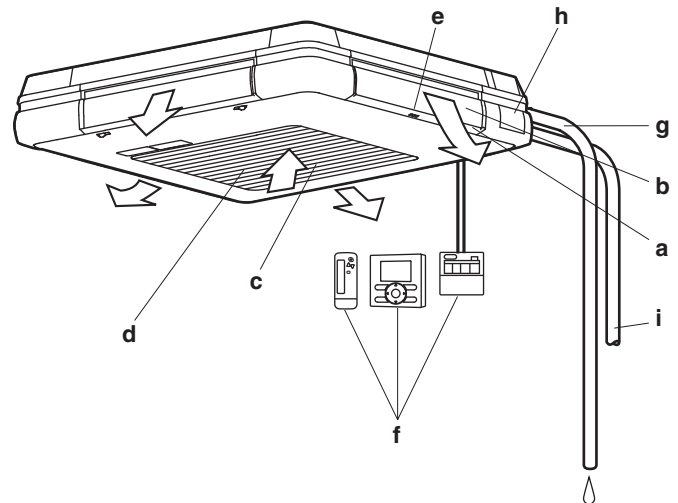

a	Air outlet
b	Horizontal blade (inside air outlet)
c	Suction grille (Refer to “8. MAINTENANCE” on page 9)
d	Air filter (inside suction grille) (Refer to “8. MAINTENANCE” on page 9)
e	Air outlet identification mark (□, □□, □□□, □□□□) Use this mark as a reference for setting the airflow direction. (only for BRC1E52)
f	Remote controller (optional part) The remote controller may not be needed depending on the system configuration.
g	Drain piping
h	Draining device (built-in) It drains moisture in the room removed during the cooling operation.
i	Refrigerant piping Transmission wiring Power supply wiring (only for FXUQ) Earth wiring (Note) (Note) It is a wiring to let electricity flow from the indoor unit to the earth for prevention of electric shocks or a fire in case of emergency.

3. OPERATION RANGE

If the temperature or the humidity is beyond the following conditions, safety devices may work and the air conditioner may not operate, or sometimes, water may drop from the indoor unit.

3-1. FUQ

COOLING [°C]

OUTDOOR UNIT	INDOOR		OUTDOOR TEMPERATURE
	TEMPERATURE	HUMIDITY	
RZQG71·100·125·140	DB	18 to 37	DB -15 to 50
	WB	12 to 28	
RZQ200	DB	21 to 37	DB -5 to 46
	WB	14 to 28	

HEATING [°C]

OUTDOOR UNIT	INDOOR TEMPERATURE		OUTDOOR TEMPERATURE	
RZQG71·100·125·140	DB	10 to 27	DB	-19.5 to 21
			WB	-20 to 15.5
RZQ200	DB	10 to 27	DB	-14 to 21
			WB	-15 to 15

*To avoid condensation and water dripping out the indoor unit.

DB: Dry bulb temperature

WB: Wet bulb temperature

The setting temperature range of the remote controller is 16°C to 32°C.

3-2. FXUQ

Read the operation manual attached to the outdoor unit.

4. INSTALLATION SITE

Regarding places for installation

- **Is the air conditioner installed at a well-ventilated place where there are no obstacles around?**
- **Do not use the air conditioner in the following places.**
 - a. Filled with much mineral oil such as cutting oil
 - b. Where there is much salt such as a beach area
 - c. Where sulfured gas exists such as a hot-spring resort
 - d. Where there are considerable voltage fluctuations such as a factory or plant
 - e. Vehicles and vessels
 - f. Where there is much spray of oil and vapor such as a cookery, etc.
 - g. Where there are machines generating electromagnetic waves
 - h. Filled with acid and/or alkaline steam or vapor
- **Is a snow protection measure taken?**
For details, consult your local dealer about snow protection hoods, etc.

Regarding wiring

- **All wiring must be performed by an qualified personnel.**
To do wiring, ask your local dealer. Never do it by yourself.
- **Make sure that a separate power supply circuit is provided for this air conditioner and that all electrical work is carried out by qualified personnel according to local laws and regulations.**

Pay attention to running noises, too

- **Are the following places selected?**
 - a. A place that can sufficiently withstand the mass of the air conditioner with less running noises and vibrations.
 - b. A place where the hot wind discharged from the air outlet of the outdoor unit and the running noises do not cause a nuisance to neighbours.

- **Are you sure that there are no obstacles near the air outlet of the outdoor unit?**
Such obstacles may result in declined performance and increased running noises.
- **If abnormal noises occur in use, stop the operation of the air conditioner, consult your local dealer.**

Regarding drainage of drain piping

- **Is the drain piping carried out properly to ensure complete drainage?**
If drain piping is not carried out properly, dirt and debris may be accumulated in the drain piping and cause water leakage. If it occurs, stop the air conditioner and consult with your local dealer for assistance.

5. OPERATION PROCEDURE

- Operating procedure varies with heat pump type and cooling only type. Contact your local dealer to confirm your system type.
- To protect the air conditioner, turn on the main power switch 6 hours before operation.
- Do not shut off the power supply during seasonal use of the air conditioner.
This is required in order to activate the air conditioner smoothly.
- If the main power supply is turned off during operation, operation will restart automatically after the power turns back on again.

5-1. FUQ

Read the operation manual attached to the remote controller.

5-2. FXUQ

Read the operation manual attached to the outdoor unit and remote controller.

6. OPERATION CHARACTERISTICS

■ CHARACTERISTICS OF THE COOLING OPERATION (COOLING OPERATION AND AUTOMATIC COOLING OPERATION)

- If the COOLING OPERATION is used when the indoor temperature is low, frost adheres to the heat exchanger of the indoor unit.
This can decrease the cooling capacity. In this case, the air conditioner automatically switches to the DEFROST OPERATION for a while.

During the DEFROST OPERATION, the low fan speed or a gentle wind is used to prevent the discharge of melt water.

(The remote controller displays the fan speed that is set.)

- When the outdoor temperature is high, it takes some time until the indoor temperature reaches the set temperature.

■ CHARACTERISTICS OF THE HEATING OPERATION (HEATING OPERATION AND AUTOMATIC HEATING OPERATION)

START OF OPERATION

- It generally takes a longer time for indoor temperature of the HEATING OPERATION to reach the set temperature compared to the COOLING OPERATION.

It is advisable to start operation in advance using the TIMER OPERATION.

Perform the following operation to prevent heating capacity decrease and discharge of cool air.

AT THE START OF OPERATION AND AFTER THE DEFROST OPERATION

- A warm air circulating system is employed, and therefore it takes some time until the entire room is warmed up after the start of operation.
- The indoor fan runs to discharge a gentle wind automatically until the temperature inside the air conditioner reaches a certain level. At this time, the remote controller displays “”. Leave it as it stands and wait for a while.
(The remote controller displays the fan speed that is set.)
- The airflow direction becomes horizontal to prevent a draft of cool air to the inhabitants. (The remote controller displays the set airflow direction that is set.)

DEFROST OPERATION

(Frost removal operation for the outdoor unit)

- As the frost on the coil of an outdoor unit increase, heating effect decreases and the air conditioner goes into the DEFROST OPERATION.
- The indoor unit fan stops and the remote controller display shows “”.
With the wireless remote controller, the warm air stops, and the DEFROST OPERATION lamp on the light receiving unit turn on.
(The remote controller displays the fan speed that is set.)
- After maximum 10 minutes of the DEFROST OPERATION, the air conditioner returns to the HEATING OPERATION.

- The airflow direction becomes horizontal. (The remote controller displays the airflow direction that is set.)
- During or after the DEFROST OPERATION, white mist comes out from the air inlet or outlet of the air conditioner.
(Refer to “VI.” on page 13.)
- A hissing and “Shuh” sound may be heard during this particular operation.

Regarding outside air temperature and heating capacity

- The heating capacity of the air conditioner declines as the outside air temperature falls. In such a case, use the air conditioner in combination with other heating systems.
(When a combustion appliance is used, ventilate the room regularly.)
Do not use the combustion appliance where the air from the air conditioner is blown directly toward it.
- When the warm air stays under the ceiling and your feet are cold, we recommend that you use a circulator (a fan to circulate the air inside the room).
For details, consult your local dealer.
- When the indoor temperature exceeds the set temperature, the indoor unit discharges a gentle breeze (switches to gentle wind). The airflow direction becomes horizontal. (The remote controller displays the fan speed and airflow direction that are set.)

■ CHARACTERISTICS OF THE PROGRAM DRY OPERATION

- This operation lowers the humidity without lowering the indoor temperature. The indoor temperature when the operation button is pressed will be the set temperature. At this time, the fan speed and temperature are set automatically, so the remote controller does not display the fan speed and set temperature.
To efficiently lower the indoor temperature and humidity, first use the COOLING OPERATION to lower the indoor temperature, and then use the PROGRAM DRY OPERATION. When the indoor temperature is lowered, airflow from the indoor unit may stop.
- When operating continuously at downward airflow direction, air blows in the automatic set direction for a period of time to prevent condensation on the horizontal blades. (The remote controller displays the airflow direction that is set.)

- If the PROGRAM DRY OPERATION is used when the indoor temperature is low, frost forms the heat exchanger of the indoor unit. In this case, the air conditioner automatically switches to the DEFROST OPERATION for a while.
The low fan speed or a gentle wind is used to prevent the discharge of melt water.

■ SOUND PRESSURE LEVEL

- Sound pressure level is less than 70 dB(A).

AIRFLOW DIRECTION ADJUST

Airflow direction adjust can be individually set for each air outlet. (BRC1E52 only)

- Check the air outlet identification mark (refer to page 5), and use the remote controller to set the airflow direction. (For details, refer to the operation manual attached to the remote controller.)
- The horizontal blades at the air outlet are closed while the indoor unit stops.



AIRFLOW DIRECTION ADJUST

Press the AIRFLOW DIRECTION ADJUST/SETTING button to adjust the airflow direction.

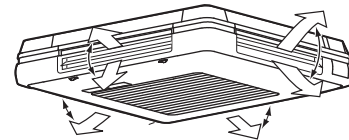

Up and down adjustment

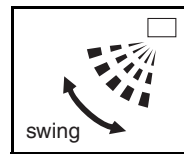

The AIRFLOW DIRECTION display swings as shown left and the airflow direction continuously varies. (Automatic swing setting)



Press AIRFLOW DIRECTION ADJUST/SETTING button to select the air direction of your choice.

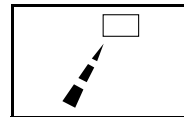

The AIRFLOW DIRECTION display stops swinging and the airflow direction is fixed (Fixed airflow direction setting).

MOVEMENT OF THE HORIZONTAL BLADE

For the following conditions, micro computer controls the airflow direction so it may be different from the display.

Operation mode	<ul style="list-style-type: none"> • COOLING • AUTOMATIC COOLING • PROGRAM DRY 	<ul style="list-style-type: none"> • HEATING • AUTOMATIC HEATING
Up and down direction	<p>Air blows in the automatic set direction for a period of time to prevent condensation on the horizontal blades.</p> <ul style="list-style-type: none"> • When operating continuously at downward airflow direction 	<p>The airflow direction becomes horizontal so that it does not blow directly toward your body.</p> <ul style="list-style-type: none"> • When room temperature is higher than the set temperature • When the HEATING OPERATION starts or during the DEFROST OPERATION (if frost forms on the outdoor unit)

NOTE (In case of FUQ)

- When group control is performed on the simultaneous operation system (twin and triple), airflow direction cannot be individually set on the slave units.

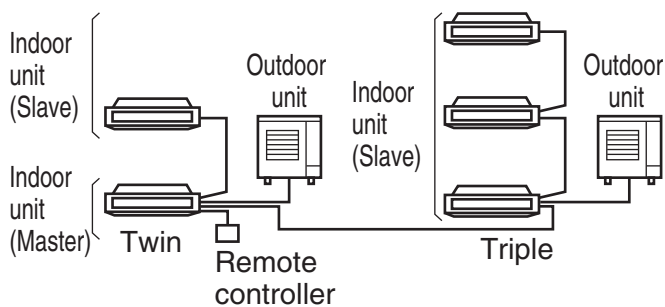

Recommended airflow direction positions

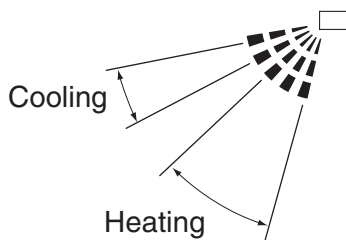

We recommend using the airflow in the position listed above when fixing the airflow direction.

7. OPTIMUM OPERATION

Observe the following precautions to ensure the air conditioner operates.

- Prevent direct sunlight from the window by using curtains or blinds during the COOLING OPERATION.
- Keep doors and windows closed. If the doors and windows remain open, room air will flow out and decrease the effect of cooling and heating.
- Never place objects near the air inlet and the air outlet of the air conditioner. It may decrease the effect or stop the operation.
- Adjust the room temperature properly for a comfortable environment. Avoid excessive heating or cooling. Not doing so wastes electricity.
- When the display shows “” or “Time to clean filter”, ask a qualified service person to clean the filters. (Refer to “8. MAINTENANCE” on page 9.) Operating the indoor unit with stained air filter may decrease capacity or cause malfunction.
- Install TVs, radios, and stereos 1 m or more away from the indoor unit and remote controller. Images may become fuzzy and noise may be generated.
- Turn off the power circuit breaker when it is not in use for a long period. When the power circuit breaker is turned on, small amount of power is consumed even if the air conditioner is not in operation. (*1) Turn off the power circuit breaker for saving energy. When reoperating, turn on the power circuit breaker 6 hours before operation for smooth running. (Refer to “8. MAINTENANCE” on page 9.) (*2)
- *1 The consumed power while the outdoor unit is not in operation depends on the model.
- *2 The setting before the power circuit breaker is cut off is stored. (The timer setting is cleared.)
- Fully use the function of airflow direction adjust. Cold air gathers on the floor, and warm air gathers under the ceiling. Set the air direction to horizontal during the COOLING or PROGRAM DRY OPERATION, and set it downwards during the HEATING OPERATION. Do not let the air blow directly to a person.
- Use the TIMER OPERATION effectively. It takes some time until the indoor temperature reaches the set temperature. It is advisable to start operation in advance using the TIMER OPERATION.

8. MAINTENANCE (FOR SERVICE PERSONNEL)

ONLY A QUALIFIED SERVICE PERSON IS ALLOWED TO PERFORM MAINTENANCE

⚠ WARNING

- Do not use flammable gas (such as hair sprays and insecticides) near the air conditioner.
- Do not wipe the air conditioner with benzine or thinner.
It may cause cracks, electric shocks or a fire.
- Never put your fingers or rods in the air inlet, air outlet or horizontal blade. The fan is rotating at high speed, so you would get injured.

⚠ CAUTION

- Do not wash the air conditioner with water.
It may cause electric shocks or a fire due to leakage.
- Make sure to turn off the air conditioner when taking care of the air conditioner and disconnect the power supply breaker.
Unless the power supply is disconnected, it may cause electric shocks and injuries.
- When working at a high place, give caution to your footing.
If the scaffold is unstable, it may cause injuries due to fall and stumbling.

NOTE

- Do not remove the air filter unless for cleaning. It may cause failure.
- Do not attach substance (such as paper towels) other than the specified air filter to the air inlet. The performance may drop and cause freeze-up/water leakage.

HOW TO CLEAN THE AIR FILTER

When the remote controller indicates “” or “Time to clean filter”, clean the air filter.

- It indicates after running for a certain time.

NOTE

- You may change the time of indication “” or “Time to clean filter”.
If the indoor unit is used in a space where the air is more contaminated, ask your local dealer for solution.

Contamination	Time until indication is displayed
Normal	2500 hours (equivalent to one year)
More contaminated	1250 hours (equivalent to a half year)

- If it becomes difficult to remove contamination from the air filter, replace the air filter.
(Air filter for replacement is an optional accessory)

1. Open the suction grille.

Simultaneously slide the two knobs, slowly down the suction grille.

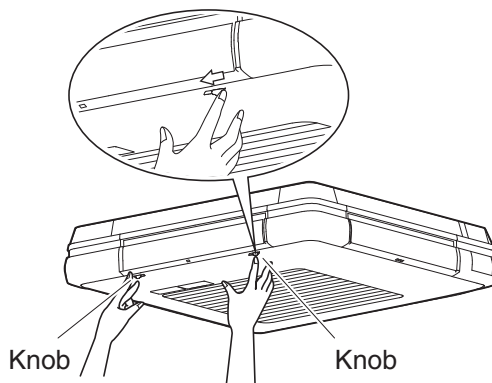

2. Take out the air filter.

Carry out the work in the order mentioned below.

- 1 Pull the air filter end inclined downward and unhook the hooking hole of the air filter from the projection of the grille. (both right and left)
- 2 Lift the air filter and unhook the hooking hole of the air filter from the projection at the grille upper part. (both left and right)

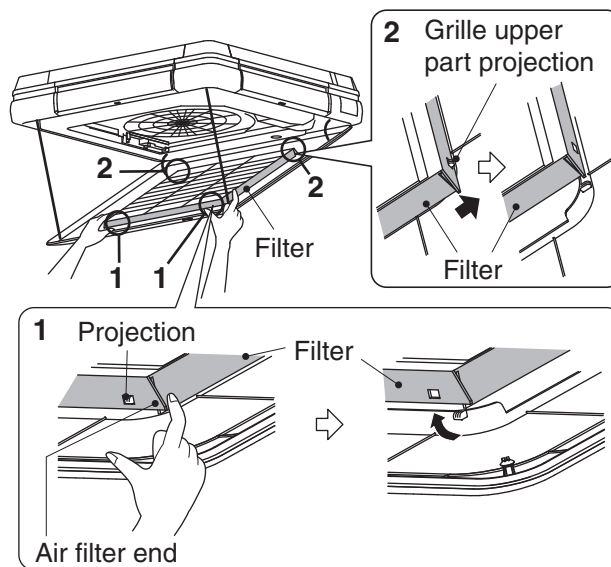

3. Clean the filter.

Clean the contamination with a vacuum cleaner or wash it with water.

If the air filter is extremely contaminated, wash it with neutral detergent using a soft brush.



After dewatering, dry the air filter in the shade.

NOTE 

- Do not wash the air filter with water of 50°C or higher.
It may cause decolorization and deformation.
- Do not heat the filter with fire.
It may cause burning.

4. Attach the air filter.

Attach the air filter in the reverse order mentioned in the clause 2 (page 9).

5. Close the suction grille.

Simultaneously slide the two knobs, slowly lift the suction grille and securely fix it in the reverse order mentioned in the clause 1 (page 9).

6. Turn off the indication “” or “Time to clean filter” displayed on the remote controller after turning on the power.

- For details, refer to the operation manual attached to the remote controller.
The indication can be turned off whether in operation or at stop.

NOTE 

- When closing the suction grille, the strap is likely to be sandwiched.
Before closing the suction grille, confirm if the strap is not sticking out from the side of the suction grille.

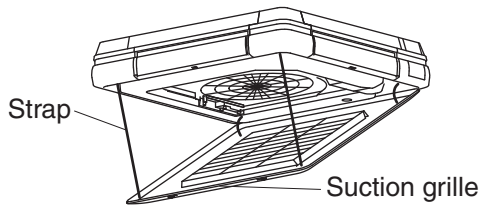

HOW TO CLEAN THE SUCTION GRILLE

1. Open the suction grille.

Simultaneously slide the two knobs, slowly down the suction grille.

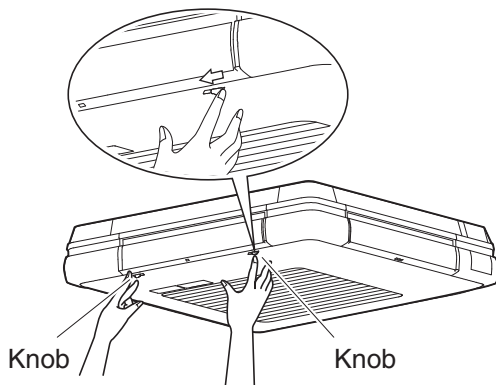

2. Remove the suction grille.

1 Remove the 4 straps attached to the indoor unit. (Refer to the figure shown below.)

2 Open the suction grille to 45° and lift it. Then, unhook it from the place to hook. (3 places)

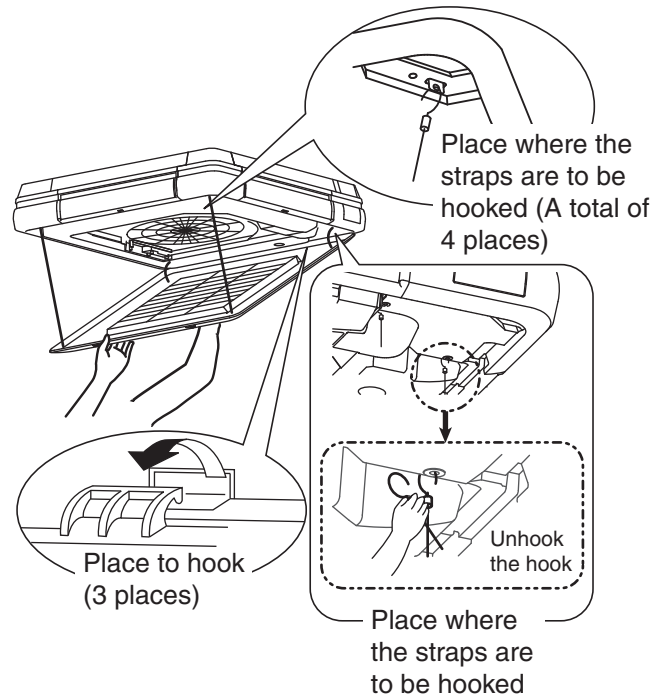

3. Take out the air filter.

Refer to the clause 2 for “HOW TO CLEAN THE AIR FILTER”. (page 9)

4. Clean the suction grille.

Wash the suction grille with neutral detergent using a soft brush and then dewater.

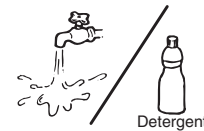

When the suction grille is extremely contaminated

- Spray the detergent for a ventilating fans and ranges directly to the suction grille, and keep it under that condition for about 10 minutes.
After that, carefully wash the suction grille with water.

NOTE 

- Do not wash the suction grille with warm water of 50°C or higher.
It may cause discoloration and deformation.
- When drying the suction grille, do not heat it with fire. It may cause burning.
- Do not use such as gasoline, benzene, thinner, polishing powder and liquid insecticide sold in the market.
It may cause discoloration and deformation.

5. Attach the air filter.

Refer to the clause 4 for “HOW TO CLEAN THE AIR FILTER”. (page 10)

6. Attach the suction grille.

Attach the suction grille in the reverse order mentioned in the clause 2.

7. Close the suction grille.

Simultaneously slide the 2 knobs in the reverse order mentioned in the clause 1, slowly lift the suction grille and securely fix it.

HOW TO CLEAN OUTSIDE PANELS AND REMOTE CONTROLLER

- Wipe them with a dry soft cloth.
- When the stain cannot be wiped off, dip the cloth in the neutral detergent diluted with water and twist the cloth.
After wiping off stain with this cloth, wipe them with dry cloth.

NOTE

- Do not use such as gasoline, benzene, thinner, polishing powder and liquid insecticide sold in the market.
It may cause discoloration and deformation.
- Do not wash them with warm water of 50°C or higher.
It may cause discoloration and deformation.

■ CLEANING BEFORE AND AFTER SEASONAL USE

WHAT TO DO WHEN START UP AFTER A LONG STOP

Confirm the following.

- Check that the air inlet and outlet of indoor and outdoor unit are not blocked.
Remove any obstacle.
Obstacles decrease the fan speed, and cause performance decrease and breakage of the devices.

Clean the air filter.

- After cleaning the air filter, make sure to attach it. (Refer to “8. MAINTENANCE” on page 9.)
For information on how to install, remove, or clean an optional sold air filter, refer to the user’s manual attached to the air filter.
- Turn off the indication “” or “Time to clean filter” displayed on the remote controller after turning on the power.
- For details, refer to the operation manual attached to the remote controller.
The indication can be turned off whether in operation or at stop.

Turn on the power circuit breaker at least 6 hours before operation.

- This is required in order to activate the air conditioner smoothly, and to protect the air conditioner.

- The display on the remote controller will be shown when the power circuit breaker is turned on.

HEATING OPERATION within 6 hours after power is supplied to the air conditioner.

Some model series perform the following operation to protect the devices.

If the HEATING OPERATION is performed within 6 hours after power is supplied to the air conditioner, the indoor fan stops for about 10 minutes during the outdoor unit operation to protect the devices.

The above operation is performed not only for installation, but every time the power circuit breaker is turned off/on.

For comfortable use, do not turn off the power circuit breaker during seasonal use of the HEATING OPERATION.

WHAT TO DO WHEN STOPPING THE AIR CONDITIONER FOR A LONG PERIOD

Turn on FAN OPERATION for a half day on the fine day and dry the indoor unit.

- This can prevent the causes of mould.

Turn off the power circuit breaker.

- During the power circuit breaker is turned on, some watts of electricity is being used even if the air conditioner is not operating.
Turn off the power circuit breaker for saving energy.
- The display on the remote controller will vanish when the power circuit breaker is turned off.

Clean the air filter.

- Be sure to replace the air filter to its original place after cleaning.
(Refer to “8. MAINTENANCE” on page 9.)
For information on how to install, remove, or clean an optional sold air filter, refer to the user’s manual attached to the air filter.

NOTE

The inside of the air conditioner may become contaminated after several seasons of use, potentially causing performance degradation and water leakage.

Ask your local dealer for details on cleaning the inside of the indoor unit. This operation requires a qualified service person.

9. NOT MALFUNCTION OF THE AIR CONDITIONER

9-1. FUQ

The following symptoms do not indicate air conditioner malfunction

- **HEATING OPERATION** within 6 hours after the power is supplied to the air conditioner.
Some model series perform the following operation to protect the devices.
If the HEATING OPERATION is performed within 6 hours after the power is supplied to the air conditioner, the indoor fan stops for about 10 minutes during the outdoor unit operation to protect the devices. The above operation is performed not only for installation, but every time the power circuit breaker is turned off/on.

For comfortable use, do not turn off the power circuit breaker during seasonal use of the HEATING OPERATION.

I. THE AIR CONDITIONER DOES NOT OPERATE

- **The air conditioner does not restart immediately after the ON/OFF button is pressed.**
- **The air conditioner does not restart immediately when TEMPERATURE SETTING button is returned to the former position after pushing the button.**

If the OPERATION lamp lights, the air conditioner is in normal condition.

It does not restart immediately because a safety device operates to prevent overload of the air conditioner.

After 3 minutes, the air conditioner will start again automatically.

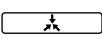
- **The air conditioner does not start when the display shows “” and it flashes for few seconds after pressing an operation button.**

This is because the air conditioner is under centralized control.

Flashes on the display indicates that the air conditioner cannot be controlled by the remote controller.

- **HEATING OPERATION** within 6 hours after power is supplied to the air conditioner.

Some model series perform the following operation to protect the devices.

If the HEATING OPERATION is performed within 6 hours after power is supplied to the air conditioner, the indoor fan stops for about 10 minutes during the outdoor unit operation to protect the devices.

The above operation is performed not only for installation, but every time the power circuit breaker is turned off/on.

For comfortable use, do not turn off the power circuit breaker during seasonal use of the HEATING OPERATION.

- **The outdoor unit stops.**

This is because the indoor temperature has reached the set temperature.

The indoor unit is in the FAN OPERATION.

COOLING OPERATION

(AUTOMATIC COOLING OPERATION):

Lower the set temperature.

HEATING OPERATION

(AUTOMATIC HEATING OPERATION):

Raise the set temperature.

The operation starts after a while when the air conditioner is in normal condition.

- **The remote controller displays “”, and airflow stops.**

This is because the air conditioner automatically switches to the DEFROST OPERATION to prevent a decrease in heating capacity when frost on the outdoor unit increases.

After maximum 10 minutes, the air conditioner returns to its original operation.

II. THE OPERATION SOMETIMES STOPS

- **The remote controller displays “U4” and “U5”, and the operation stops. However, it will restart in a few minutes.**

This is because communication between the indoor and outdoor units or indoor units and remote controllers is shut off and stopped due to noise caused by devices other than the air conditioner.

When the electrical noise decreases, the air conditioner automatically restarts.

III. THE FAN SPEED IS DIFFERENT FROM THE SETTING

- **Pressing the fan speed control button does not change the fan speed.**

During the COOLING OPERATION, the low fan speed or a gentle wind is used to prevent the discharge of melt water.

During the DEFROST OPERATION (HEATING OPERATION), the wind from the air conditioner stops to prevent air discharge directly toward your body. After a while, the fan speed can be changed.

(The fan speed cannot be set for the PROGRAM DRY OPERATION.)

When the room temperature reaches the set temperature during the HEATING OPERATION, the outdoor unit stops and the indoor unit goes into gentle wind.

It takes some time until the fan speed changes. Raise the set temperature.

After a while, the fan speed changes.

IV. THE AIRFLOW DIRECTION IS DIFFERENT FROM THE SETTING, OR THE AIRFLOW DIRECTION IS DIFFERENT FROM THE DISPLAY ON THE REMOTE CONTROLLER

- **The horizontal blades do not swing when the remote controller displays the swing operation.**

<HEATING OPERATION>

This is because the airflow direction is controlled so it is horizontal direction after the operation starts or when the indoor temperature is higher than the set temperature to prevent air discharge directly toward your body. After a while, the swing operation starts. (Refer to “**MOVEMENT OF THE HORIZONTAL BLADE**” on page 8.)

- **The airflow direction display of the remote controller differs from the actual operation of the horizontal blades.**

<COOLING and PROGRAM DRY OPERATIONS>

When the operation in a downward airflow direction is set, the airflow direction differs from the display for a period of time to prevent condensation on the horizontal blades.

<HEATING OPERATION>

This is because the airflow direction is controlled so it is horizontal direction after the operation starts or when the indoor temperature is higher than the set temperature to prevent air discharge directly toward your body.

After a while, the airflow direction changes to the set direction.

(Refer to “**MOVEMENT OF THE HORIZONTAL BLADE**” page 8.)

V. HORIZONTAL BLADES DO NOT CLOSE

- **The horizontal blades do not close even when operation stops.**

This is because the horizontal blades close once airflow from the air conditioner stops. After a while, the horizontal blades close.

VI. WHITE MIST COMES OUT OF THE AIR CONDITIONER

- **When humidity is high during the COOLING OPERATION. (In oily or dusty places)**

If the inside of an indoor unit is extremely contaminated, the temperature distribution inside a room becomes uneven.

It is necessary to clean the inside of the indoor unit.

Ask your local dealer for details on cleaning the indoor unit.

This cleaning requires a qualified service person.

Check the usage environment.

- **When the air conditioner is changed over to the HEATING OPERATION after the DEFROST OPERATION and in the DEFROST OPERATION.**

Moisture generated by defrost becomes steam and exists.

When the remote controller display shows “”, DEFROST OPERATION is being used.

VII. NOISE OF AIR CONDITIONERS

- **A ringing sound after the indoor unit is started.**

This sound is generated when the motors for driving the horizontal blades are working. It will quiet down after about a minute.

- **A low continuous flow “Shuh” sound which is heard when the air conditioner is in the COOLING or DEFROST OPERATION or a trickling sound which is heard when the air conditioner is in the DEFROST OPERATION.**

This is the sound of refrigerant gas flowing through both indoor and outdoor units.

- **A “Shuh” sound which is heard at the start or immediately after the stop of operation or which is heard at the start or immediately after the stop of the DEFROST OPERATION.**

This is the noise of refrigerant caused by flow stop and flow change.

During the HEATING OPERATION, the air conditioner switches to the DEFROST OPERATION automatically.

The remote controller shows “”.

After maximum 10 minutes, the air conditioner returns to its original operation.

- **A continuous flow “Shah” sound is heard when the air conditioner is in the COOLING OPERATION or at a stop.**

The noise is heard when the drain pump is in operation.

Liquid removed from the indoor air during the COOLING OPERATION is discharged.

- **A “Pishi-pishi” squeaking sound is heard when the air conditioner is in operation or after the stop of operation.**

Expansion and contraction of resin parts caused by temperature change makes this noise.

VIII. DUST FROM THE INDOOR UNITS

- **Dust may blow out from the unit after starting operation from long resting time.**

Dust absorbed by the unit blows out.

IX. THE INDOOR UNITS GIVE OFF ODORS

• During operation

The unit absorbs the smell of rooms, furniture, cigarettes, etc., and then emits them. If odor is a concern, set the fan speed to no airflow when the indoor temperature reaches the set temperature.

For details, contact your local dealer.

X. THE AIR CONDITIONER DOES NOT COOL EFFECTIVELY

• The air conditioner is operating in PROGRAM DRY OPERATION.

This is because program dry mode operates so that the indoor temperature decreases as little as possible.

Lower the indoor temperature using the COOLING OPERATION, and then use the PROGRAM DRY OPERATION.

(Refer to “CHARACTERISTICS OF THE PROGRAM DRY OPERATION” on page 7.)

• Read through characteristics of the COOLING OPERATION, characteristics of the HEATING OPERATION, and characteristics of the PROGRAM DRY OPERATION on page 6-7.

9-2. FXUQ

Read the operation manual attached to the outdoor unit.

10. TROUBLE SHOOTING

10-1. FUQ

Please check before requesting a service.

1. If the air conditioner does not operate at all.

- Check if fuse has blown.
Turn off the power supply.
- Check if the power circuit breaker is blown.
If the tab of power circuit breaker is in the OFF position, turn the power on with the power circuit breaker switch.
If the tab of power circuit breaker is in the trip position, do not turn the power on with the power circuit breaker switch.
Contact your local dealer.

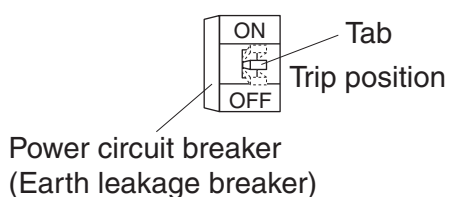

- Check if there is a power failure.
Wait until power is restored. If power failure occurs during operation, the air conditioner automatically restarts immediately after the power supply recovers.

2. If the air conditioner stops after operating the air conditioner.

- Check if the air inlet or outlet of outdoor or indoor unit is blocked by obstacles.
Remove the obstacle and make it well-ventilated.
The horizontal blades at the air outlet are closed while the indoor stops.
- Check if the air filter is clogged.
Ask a qualified service person to clean the air filters.
A decrease in the airflow volume of the air conditioner will result and the performance of the air conditioner will be degraded and power consumption will increase if the air filter is clogged with dust or dirt.
In addition, this may cause dew condensation at the air outlet.
(Refer to “8. MAINTENANCE” on page 9.)

3. The air conditioner operates but it does not sufficiently cool or heat.

- Check if the air inlet or outlet of outdoor or indoor unit is blocked by obstacles.
Remove the obstacle and make it well-ventilated.
The horizontal blades at the air outlet are closed while the indoor unit stops.
Obstacles decrease the fan speed, and cause performance decrease and breakage when discharged air is suctioned.
They cause a waste of electricity, and that may stop the devices.
- Check if the air filter is clogged.
Ask a qualified service person to clean the air filters.
A decrease in the airflow volume of the air conditioner will result and the performance of the air conditioner will be degraded and power consumption will increase if the air filter is clogged with dust or dirt.
In addition, this may cause dew condensation at the air outlet.
(Refer to “8. MAINTENANCE” on page 9.)
- Check if the set temperature is not proper.
Set to an appropriate temperature, fan speed, and airflow direction.
- Check if the FAN SPEED button is set to LOW SPEED.
Set to an appropriate temperature, fan speed, and airflow direction.

- Check if the airflow direction is not proper. Set to an appropriate temperature, fan speed, and airflow direction.
- Check if the doors or the windows are open. Shut doors or windows to prevent wind from coming in.
- Check if direct sunlight enters the room (when cooling). Use curtains or blinds.
- When there are too many inhabitants in the room (when cooling).
- Check if the heat source of the room is excessive (when cooling).

4. Operation was performed or stopped although the on/off button was not pressed.

- Are you sure that the ON/OFF timer operation is not used?
Turn off the ON/OFF timer.
Please refer to operation manual attached to the remote controller.
- Are you sure that any remote control device is not connected?
Contact the central control room that directed the stop.
- Are you sure that the display for centralized control is not lit?
Contact the central control room that directed the stop.

If the problem is not solved after checking the above points, please do not try to repair it yourself.

In such cases, always ask your local dealer. At this time, please tell the symptom and model name (written on the model name plate).

If one of the following malfunctions occurs, take the measures shown below and contact your local dealer.

The air conditioner must be repaired by a qualified service person.

⚠ WARNING

When the air conditioner is malfunctioning (giving off a burning odor, etc.), turn off power to the air conditioner and contact your local dealer.

Continued operation under such circumstances may result in a failure, electric shocks or a fire. Contact your local dealer.

- If a safety device such as a fuse, a power circuit breaker or an earth leakage breaker frequently actuates;
Measure: Do not turn on the main power switch.
- If the ON/OFF switch does not properly work;
Measure: Turn off the main power switch.
- If water leaks from the indoor unit.
Measure: Stop the operation.
- If the display “

Measure: Notify your local dealer and inform malfunction code of the display.

10-2. FXUQ

Read the operation manual attached to the outdoor unit.

DAIKIN INDUSTRIES, LTD.

Head office:
Umeda Center Bldg., 2-4-12, Nakazaki-Nishi,
Kita-ku, Osaka, 530-8323 Japan

Tokyo office:
JR Shinagawa East Bldg., 2-18-1, Konan,
Minato-ku, Tokyo, 108-0075 Japan

DAIKIN EUROPE N.V.

Zandvoordestraat 300, B-8400 Oostende, Belgium