

Service Manual

Inverter Pair Wall Mounted Type J-Series



[Applied Models]

- Inverter Pair : Heat Pump

Inverter Pair Wall Mounted Type J-Series

●Heat Pump

Indoor Units

FTX20JV1B
FTX25JV1B
FTX35JV1B

ATX20JV1B
ATX25JV1B
ATX35JV1B

Outdoor Units

RX20JV1B
RX25JV1B
RX35JV1B

ARX20JV1B
ARX25JV1B
ARX35JV1B

1. Introduction	v
1.1 Safety Cautions	v
1.2 Used Icons	ix
Part 1 List of Functions	1
1. Functions.....	2
Part 2 Specifications	3
1. Specifications	4
Part 3 Printed Circuit Board Connector Wiring Diagram	8
1. Printed Circuit Board Connector Wiring Diagram.....	9
1.1 Indoor Unit.....	9
1.2 Outdoor Unit.....	11
Part 4 Function and Control.....	13
1. Main Functions.....	14
1.1 Frequency Principle.....	14
1.2 Airflow Direction Control.....	16
1.3 Fan Speed Control for Indoor Units.....	17
1.4 Program Dry Operation	18
1.5 Automatic Operation.....	19
1.6 Thermostat Control.....	20
1.7 NIGHT SET Mode	21
1.8 ECONO Operation	22
1.9 Inverter POWERFUL Operation	23
1.10 Other Functions.....	24
2. Function of Thermistor	25
3. Control Specification	26
3.1 Mode Hierarchy	26
3.2 Frequency Control.....	27
3.3 Controls at Mode Changing / Start-up.....	29
3.4 Discharge Pipe Temperature Control.....	30
3.5 Input Current Control.....	31
3.6 Freeze-up Protection Control	32
3.7 Heating Peak-cut Control	32
3.8 Outdoor Fan Control.....	33
3.9 Liquid Compression Protection Function.....	33
3.10 Defrost Control	34
3.11 Electronic Expansion Valve Control	35
3.12 Malfunctions	38
3.13 Forced Operation Mode	39
Part 5 Operation Manual	40
1. System Configuration.....	41
2. Operation Manual.....	42
2.1 Remote Controller	42
2.2 AUTO · DRY · COOL · HEAT · FAN Operation	43

2.3	Adjusting the Airflow Direction.....	45
2.4	POWERFUL Operation	47
2.5	ECONO Operation	48
2.6	TIMER Operation	49

Part 6 Service Diagnosis..... 51

1.	Caution for Diagnosis.....	52
1.1	Troubleshooting with LED	52
2.	Problem Symptoms and Measures	53
3.	Service Check Function	54
4.	Troubleshooting	57
4.1	Error Codes and Description	57
4.2	Indoor Unit PCB Abnormality	58
4.3	Freeze-up Protection Control or Heating Peak-cut Control.....	59
4.4	Fan Motor (DC Motor) or Related Abnormality.....	61
4.5	Thermistor or Related Abnormality (Indoor Unit).....	63
4.6	Signal Transmission Error (between Indoor and Outdoor Unit)	64
4.7	Unspecified Voltage (between Indoor and Outdoor Unit).....	65
4.8	Outdoor Unit PCB Abnormality.....	66
4.9	OL Activation (Compressor Overload)	67
4.10	Compressor Lock	68
4.11	DC Fan Lock	69
4.12	Input Overcurrent Detection	70
4.13	Four Way Valve Abnormality	71
4.14	Discharge Pipe Temperature Control.....	73
4.15	High Pressure Control in Cooling	74
4.16	Compressor System Sensor Abnormality	75
4.17	Position Sensor Abnormality	76
4.18	DC Voltage / Current Sensor Abnormality.....	78
4.19	Thermistor or Related Abnormality (Outdoor Unit).....	79
4.20	Electrical Box Temperature Rise.....	81
4.21	Radiation Fin Temperature Rise	83
4.22	Output Overcurrent Detection	85
4.23	Refrigerant Shortage	87
4.24	Low-voltage Detection or Over-voltage Detection.....	89
5.	Check	90
5.1	How to Check.....	90

Part 7 Removal Procedure..... 100

1.	Indoor Unit.....	101
1.1	Removal of Air Filter	101
1.2	Removal of Horizontal Blades / Fan Guard.....	103
1.3	Removal of Front Panel.....	105
1.4	Removal of Front Grille	106
1.5	Removal of Electrical Box / Vertical Blades	108
1.6	Removal of PCB / Swing Motor.....	111
1.7	Removal of Indoor Heat Exchanger	115
1.8	Removal of Fan Rotor	118
1.9	Exchange of Drain Hose	121

2. Outdoor Unit.....	122
2.1 Removal of Panels	122
2.2 Removal of Outdoor Fan / Fan Motor.....	124
2.3 Removal of Electrical Box / Control PCB	125
2.4 Removal of Sound Blanket.....	132
2.5 Removal of Four Way Valve.....	134
2.6 Removal of Compressor.....	137

Part 8 Others 138

1. Others	139
1.1 Trial Operation.....	139
1.2 Field Settings.....	140
1.3 Application of Silicon Grease to a Power Transistor and a Diode Bridge.....	141





Part 9 Appendix..... 142

1. Piping Diagrams.....	143
1.1 Indoor Unit.....	143
1.2 Outdoor Unit.....	144
2. Wiring Diagrams.....	145
2.1 Indoor Unit.....	145
2.2 Outdoor Unit.....	145







1. Introduction



1.1 Safety Cautions









Cautions and Warnings

- Be sure to read the following safety cautions before conducting repair work.
- The caution items are classified into “ **Warning**” and “ **Caution**”. The “ **Warning**” items are especially important since they can lead to death or serious injury if they are not followed closely. The “ **Caution**” items can also lead to serious accidents under some conditions if they are not followed. Therefore, be sure to observe all the safety caution items described below.
- About the pictograms
 - △ This symbol indicates the item for which caution must be exercised.
The pictogram shows the item to which attention must be paid.
 - This symbol indicates the prohibited action.
The prohibited item or action is shown in the illustration or near the symbol.
 - This symbol indicates the action that must be taken, or the instruction.
The instruction is shown in the illustration or near the symbol.
- After the repair work is complete, be sure to conduct a test operation to ensure that the equipment operates normally, and explain the cautions for operating the product to the customer.











1.1.1 Cautions Regarding Safety of Workers





 Warning	
Be sure to disconnect the power cable plug from the plug socket before disassembling the equipment for repair. Working on the equipment that is connected to the power supply may cause an electrical shock. If it is necessary to supply power to the equipment to conduct the repair or inspecting the circuits, do not touch any electrically charged sections of the equipment.	
If the refrigerant gas is discharged during the repair work, do not touch the discharged refrigerant gas. The refrigerant gas may cause frostbite.	
When disconnecting the suction or discharge pipe of the compressor at the welded section, evacuate the refrigerant gas completely at a well-ventilated place first. If there is a gas remaining inside the compressor, the refrigerant gas or refrigerating machine oil discharges when the pipe is disconnected, and it may cause injury.	
If the refrigerant gas leaks during the repair work, ventilate the area. The refrigerant gas may generate toxic gases when it contacts flames.	
The step-up capacitor supplies high-voltage electricity to the electrical components of the outdoor unit. Be sure to discharge the capacitor completely before conducting repair work. A charged capacitor may cause an electrical shock.	
Do not start or stop the air conditioner operation by plugging or unplugging the power cable plug. Plugging or unplugging the power cable plug to operate the equipment may cause an electrical shock or fire.	







 Warning	
Be sure to wear a safety helmet, gloves, and a safety belt when working at a high place (more than 2 m). Insufficient safety measures may cause a fall accident.	
In case of R-410A refrigerant models, be sure to use pipes, flare nuts and tools for the exclusive use of the R-410A refrigerant. The use of materials for R-22 refrigerant models may cause a serious accident such as a damage of refrigerant cycle as well as an equipment failure.	





 Caution	
Do not repair the electrical components with wet hands. Working on the equipment with wet hands may cause an electrical shock.	
Do not clean the air conditioner by splashing water. Washing the unit with water may cause an electrical shock.	
Be sure to provide the grounding when repairing the equipment in a humid or wet place, to avoid electrical shocks.	
Be sure to turn off the power switch and unplug the power cable when cleaning the equipment. The internal fan rotates at a high speed, and cause injury.	
Be sure to conduct repair work with appropriate tools. The use of inappropriate tools may cause injury.	
Be sure to check that the refrigerating cycle section has cooled down enough before conducting repair work. Working on the unit when the refrigerating cycle section is hot may cause burns.	
Use the welder in a well-ventilated place. Using the welder in an enclosed room may cause oxygen deficiency.	

1.1.2 Cautions Regarding Safety of Users

 Warning	
<p>Be sure to use parts listed in the service parts list of the applicable model and appropriate tools to conduct repair work. Never attempt to modify the equipment. The use of inappropriate parts or tools may cause an electrical shock, excessive heat generation or fire.</p>	
<p>If the power cable and lead wires have scratches or deteriorated, be sure to replace them. Damaged cable and wires may cause an electrical shock, excessive heat generation or fire.</p>	
<p>Do not use a joined power cable or extension cable, or share the same power outlet with other electrical appliances, since it may cause an electrical shock, excessive heat generation or fire.</p>	
<p>Be sure to use an exclusive power circuit for the equipment, and follow the local technical standards related to the electrical equipment, the internal wiring regulations, and the instruction manual for installation when conducting electrical work. Insufficient power circuit capacity and improper electrical work may cause an electrical shock or fire.</p>	
<p>Be sure to use the specified cable for wiring between the indoor and outdoor units. Make the connections securely and route the cable properly so that there is no force pulling the cable at the connection terminals. Improper connections may cause excessive heat generation or fire.</p>	
<p>When wiring between the indoor and outdoor units, make sure that the terminal cover does not lift off or dismount because of the cable. If the cover is not mounted properly, the terminal connection section may cause an electrical shock, excessive heat generation or fire.</p>	
<p>Do not damage or modify the power cable. Damaged or modified power cable may cause an electrical shock or fire. Placing heavy items on the power cable, and heating or pulling the power cable may damage the cable.</p>	
<p>Do not mix air or gas other than the specified refrigerant (R-410A / R-22) in the refrigerant system. If air enters the refrigerating system, an excessively high pressure results, causing equipment damage and injury.</p>	
<p>If the refrigerant gas leaks, be sure to locate the leaking point and repair it before charging the refrigerant. After charging refrigerant, make sure that there is no refrigerant leak. If the leaking point cannot be located and the repair work must be stopped, be sure to perform pump-down and close the service valve, to prevent the refrigerant gas from leaking into the room. The refrigerant gas itself is harmless, but it may generate toxic gases when it contacts flames, such as fan and other heaters, stoves and ranges.</p>	
<p>When relocating the equipment, make sure that the new installation site has sufficient strength to withstand the weight of the equipment. If the installation site does not have sufficient strength and if the installation work is not conducted securely, the equipment may fall and cause injury.</p>	





 Warning	
Check to make sure that the power cable plug is not dirty or loose, then insert the plug into a power outlet securely. If the plug has dust or loose connection, it may cause an electrical shock or fire.	
Be sure to install the product correctly by using the provided standard installation frame. Incorrect use of the installation frame and improper installation may cause the equipment to fall, resulting in injury.	For unitary type only 
Be sure to install the product securely in the installation frame mounted on the window frame. If the unit is not securely mounted, it may fall and cause injury.	For unitary type only 
When replacing the coin battery in the remote controller, be sure to disposed of the old battery to prevent children from swallowing it. If a child swallows the coin battery, see a doctor immediately.	

 Caution	
Installation of a leakage breaker is necessary in some cases depending on the conditions of the installation site, to prevent electrical shocks.	
Do not install the equipment in a place where there is a possibility of combustible gas leaks. If the combustible gas leaks and remains around the unit, it may cause a fire.	
Check to see if the parts and wires are mounted and connected properly, and if the connections at the soldered or crimped terminals are secure. Improper installation and connections may cause excessive heat generation, fire or an electrical shock.	
If the installation platform or frame has corroded, replace it. Corroded installation platform or frame may cause the unit to fall, resulting in injury.	
Check the grounding, and repair it if the equipment is not properly grounded. Improper grounding may cause an electrical shock.	

 Caution	
Be sure to measure the insulation resistance after the repair, and make sure that the resistance is 1 MΩ or higher. Faulty insulation may cause an electrical shock.	
Be sure to check the drainage of the indoor unit after the repair. Faulty drainage may cause the water to enter the room and wet the furniture and floor.	
Do not tilt the unit when removing it. The water inside the unit may spill and wet the furniture and floor.	
Be sure to install the packing and seal on the installation frame properly. If the packing and seal are not installed properly, water may enter the room and wet the furniture and floor.	For unitary type only 

1.2 Used Icons

Icons are used to attract the attention of the reader to specific information. The meaning of each icon is described in the table below:

Icon	Type of Information	Description
 Note:	Note	A “note” provides information that is not indispensable, but may nevertheless be valuable to the reader, such as tips and tricks.
 Caution	Caution	A “caution” is used when there is danger that the reader, through incorrect manipulation, may damage equipment, lose data, get an unexpected result or has to restart (part of) a procedure.
 Warning	Warning	A “warning” is used when there is danger of personal injury.
	Reference	A “reference” guides the reader to other places in this binder or in this manual, where he/she will find additional information on a specific topic.

Part 1

List of Functions

1. Functions.....2

1. Functions

Category	Functions	FTX20/25/35JV1B RX20/25/35JV1B	ATX20/25/35JV1B ARX20/25/35JV1B	Category	Functions	FTX20/25/35JV1B RX20/25/35JV1B	ATX20/25/35JV1B ARX20/25/35JV1B	
Basic Function	Inverter (with Inverter Power Control)	○	○	Health & Clean	Air-Purifying Filter	—	—	
	Operation Limit for Cooling (°CDB)	10 ~46	10 ~46		Photocatalytic Deodorizing Filter	—	—	
	Operation Limit for Heating (°CWB)	-15 ~20	-15 ~20		Air-Purifying Filter with Photocatalytic Deodorizing Function	—	—	
	PAM Control	○	○		Titanium Apatite Photocatalytic Air-Purifying Filter	○	○	
	Standby Electricity Saving	○	○		Air Filter (Pre-Filter)	○	○	
Compressor	Oval Scroll Compressor	—	—	Wipe-Clean Flat Panel	○	○		
	Swing Compressor	○	○	Washable Grille	—	—		
	Rotary Compressor	—	—	Mold Proof Operation	—	—		
	Reluctance DC Motor	○	○	Heating Dry Operation	—	—		
Comfortable Airflow	Power-Airflow Flap	○	○	Good-Sleep Cooling Operation	—	—		
	Power-Airflow Dual Flaps	—	—	Timer	WEEKLY TIMER Operation	—	—	
	Power-Airflow Diffuser	—	—		24-Hour ON/OFF TIMER	○	○	
	Wide-Angle Louvers	○	○		NIGHT SET Mode	○	○	
	Vertical Auto-Swing (Up and Down)	○	○	Worry Free "Reliability & Durability"	Auto-Restart (after Power Failure)	○	○	
	Horizontal Auto-Swing (Right and Left)	—	—		Self-Diagnosis (Digital, LED) Display	○	○	
	3-D Airflow	—	—		Wiring Error Check	—	—	
	COMFORT AIRFLOW Operation	○	○		Anti-Corrosion Treatment of Outdoor Heat Exchanger	○	○	
Comfort Control	Auto Fan Speed	○	○	Flexibility	Multi-Split / Split Type Compatible Indoor Unit	—	—	
	Indoor Unit Quiet Operation	○	○		Flexible Voltage Correspondence	—	—	
	NIGHT QUIET Mode (Automatic)	—	—		High Ceiling Application	—	—	
	OUTDOOR UNIT QUIET Operation (Manual)	—	—		Chargeless	10 m	10 m	
	INTELLIGENT EYE Operation	—	—		Either Side Drain (Right or Left)	○	○	
	Quick Warming Function (Preheating Operation)	○	○		Power Selection	—	—	
	Hot-Start Function	○	○		Remote Control	5-Rooms Centralized Controller (Option)	—	—
	Automatic Defrosting	○	○			Remote Control Adaptor (Normal Open Pulse Contact) (Option)	—	—
Operation	Automatic Operation	○	○	Remote Control Adaptor (Normal Open Contact) (Option)		—	—	
	Program Dry Operation	○	○	DIII-NET Compatible (Adaptor) (Option)	—	—		
	Fan Only	○	○	Remote Controller	Wireless	○	○	
Lifestyle Convenience	New POWERFUL Operation (Non-Inverter)	—	—		Wired (Option)	○	○	
	Inverter POWERFUL Operation	○	○					
	Priority-Room Setting	—	—					
	COOL / HEAT Mode Lock	—	—					
	HOME LEAVE Operation	—	—					
	ECONO Operation	○	○					
	Indoor Unit ON/OFF Button	○	○					
	Signal Receiving Sign	○	○					
R / C with Back Light	—	—						
Temperature Display	—	—						

Note: ○ : Holding Functions
— : No Functions

Part 2 Specifications

1. Specifications4

1. Specifications

50 Hz, 230 V

Model	Indoor Units		FTX20JV1B		FTX25JV1B	
	Outdoor Units		RX20JV1B		RX25JV1B	
			Cooling	Heating	Cooling	Heating
Capacity Rated (Min. ~ Max.)	kW		2.0 (1.3 ~ 2.6)	2.5 (1.3 ~ 3.5)	2.5 (1.3 ~ 3.0)	2.8 (1.3 ~ 4.0)
	Btu/h		6,800 (4,400 ~ 8,900)	8,500 (4,400 ~ 1,1600)	8,500 (4,400 ~ 10,200)	9,600 (4,400 ~ 13,600)
Running Current (Rated)	A		2.7	3.0	3.7	3.2
	kcal/h		1,720 (1,120 ~ 2,240)	2,150 (1,120 ~ 3,010)	2,150 (1,120 ~ 2,580)	2,410 (1,120 ~ 3,440)
Power Consumption Rated (Min. ~ Max.)	W		550 (310 ~ 720)	590 (250 ~ 950)	730 (310 ~ 1,050)	690 (250 ~ 1,110)
Power Factor (Rated)	%		88.6	91.6	85.8	93.8
COP Rated (Min. ~ Max.)	W/W		3.64 (4.19 ~ 3.61)	4.24 (5.2 ~ 3.68)	3.42 (4.19 ~ 2.86)	4.06 (5.2 ~ 3.60)
Piping Connections	Liquid	mm	φ 6.4		φ 6.4	
	Gas	mm	φ 9.5		φ 9.5	
	Drain	mm	φ 18.0		φ 18.0	
Heat Insulation			Both Liquid and Gas Pipes		Both Liquid and Gas Pipes	
Max. Interunit Piping Length	m		15		15	
Max. Interunit Height Difference	m		12		12	
Chargeless	m		10		10	
Amount of Additional Charge of Refrigerant	g/m		20		20	
Indoor Unit			FTX20JV1B		FTX25JV1B	
Front Panel Color			White		White	
Airflow Rate	m³/min (cfm)	H	9.1 (321)	9.4 (331)	9.2 (325)	9.7 (342)
		M	7.4 (261)	7.8 (276)	7.6 (268)	8.0 (283)
		L	5.9 (208)	6.3 (222)	6.0 (212)	6.3 (222)
		SL	4.7 (166)	5.5 (194)	4.8 (169)	5.5 (194)
Fan	Type		Cross Flow Fan		Cross Flow Fan	
	Motor Output	W	16		16	
	Speed	Steps	5 Steps, Quiet, Auto		5 Steps, Quiet, Auto	
Air Direction Control		Right, Left, Horizontal, Downward		Right, Left, Horizontal, Downward		
Air Filter		Removable / Washable / Mildew Proof		Removable / Washable / Mildew Proof		
Running Current (Rated)	A		0.18	0.18	0.18	0.18
Power Consumption (Rated)	W		40	40	40	40
Power Factor	%		96.6	96.6	96.6	96.6
Temperature Control			Microcomputer Control		Microcomputer Control	
Dimensions (H x W x D)	mm		283 x 770 x 198		283 x 770 x 198	
Packaged Dimensions (H x W x D)	mm		263 x 840 x 344		263 x 840 x 344	
Weight	kg		7		7	
Gross Weight	kg		11		11	
Operation Sound	H / M / L / SL	dBA	39 / 33 / 25 / 22	39 / 34 / 28 / 25	40 / 33 / 26 / 22	40 / 34 / 28 / 25
Sound Power		dBA	55	55	56	56
Outdoor Unit			RX20JV1B		RX25JV1B	
Casing Color			Ivory White		Ivory White	
Compressor	Type		Hermetically Sealed Swing Type		Hermetically Sealed Swing Type	
	Model		1YC23AEXDA		1YC23AEXDA	
	Motor Output	W	750		750	
Refrigerant Oil	Type		FVC50K		FVC50K	
	Charge	L	0.375		0.375	
Refrigerant	Type		R-410A		R-410A	
	Charge	kg	0.74		0.74	
Airflow Rate (H)	m³/min		29.2	26.2	29.2	26.2
	cfm		1,030	927	1,030	927
Fan	Type		Propeller		Propeller	
	Motor Output	W	33		33	
Running Current (Rated)	A		2.52	2.62	3.52	3.02
Power Consumption (Rated)	W		510	550	690	650
Power Factor	%		88.0	91.3	85.2	93.6
Starting Current	A		2.7		3.7	
Dimensions (H x W x D)	mm		550 x 658 x 275		550 x 658 x 275	
Packaged Dimensions (H x W x D)	mm		616 x 788 x 359		616 x 788 x 359	
Weight	kg		28		28	
Gross Weight	kg		31		31	
Operation Sound		dBA	46	47	46	47
Sound Power		dBA	60	61	60	61
Drawing No.			3D065930		3D065931	

Note: ■ The data are based on the conditions shown in the table below.

Cooling	Heating	Piping Length
Indoor ; 27°CDB / 19°CWB Outdoor ; 35°CDB / 24°CWB	Indoor ; 20°CDB Outdoor ; 7°CDB / 6°CWB	5 m

Conversion Formulae
kcal/h = kW x 860 Btu/h = kW x 3412 cfm = m³/min x 35.3

50 Hz, 230 V

Model	Indoor Units		FTX35JV1B	
	Outdoor Units		RX35JV1B	
			Cooling	Heating
Capacity Rated (Min. ~ Max.)	kW		3.3 (1.3 ~ 3.8)	3.5 (1.3 ~ 4.8)
	Btu/h		11,300 (4,400 ~ 13,000)	11,900 (4,400 ~ 16,400)
	kcal/h		2,840 (1,120 ~ 3,270)	3,010 (1,120 ~ 4,130)
Running Current (Rated)	A		5.2	4.7
Power Consumption Rated (Min. ~ Max.)	W		980 (290 ~ 1,300)	930 (290 ~ 1,290)
Power Factor	%		81.9	86.0
COP Rated (Min. ~ Max.)	W/W		3.37 (4.48 ~ 2.92)	3.76 (4.48 ~ 3.72)
Piping Connections	Liquid	mm	φ 6.4	
	Gas	mm	φ 9.5	
	Drain	mm	φ 18.0	
Heat Insulation			Both Liquid and Gas Pipes	
Max. Interunit Piping Length	m		15	
Max. Interunit Height Difference	m		12	
Chargeless	m		10	
Amount of Additional Charge of Refrigerant	g/m		20	
Indoor Unit		FTX35JV1B		
Front Panel Color		White		
Airflow Rate	m³/min (cfm)	H	9.3 (328)	10.1 (356)
		M	7.7 (272)	8.4 (295)
		L	6.1 (215)	6.7 (235)
		SL	4.9 (173)	5.7 (201)
Fan	Type	Cross Flow Fan		
	Motor Output	W	16	
	Speed	Steps	5 Steps, Quiet, Auto	
Air Direction Control		Right, Left, Horizontal, Downward		
Air Filter		Removable / Washable / Mildew Proof		
Running Current (Rated)	A	0.18	0.18	
Power Consumption (Rated)	W	40	40	
Power Factor	%	96.6	96.6	
Temperature Control		Microcomputer Control		
Dimensions (H x W x D)	mm	283 x 770 x 198		
Packaged Dimensions (H x W x D)	mm	263 x 840 x 344		
Weight	kg	7		
Gross Weight	kg	11		
Operation Sound	H / M / L / SL	dBA	41 / 34 / 27 / 23	41 / 35 / 29 / 26
Sound Power		dBA	57	57
Outdoor Unit		RX35JV1B		
Casing Color		Ivory White		
Compressor	Type	Hermetically Sealed Swing Type		
	Model	1YC23AEXDA		
	Motor Output	W	750	
Refrigerant Oil	Type	FVC50K		
	Charge	L	0.375	
Refrigerant	Type	R-410A		
	Charge	kg	1.0	
Airflow Rate (H)	m³/min	27.6	24.5	
	cfm	975	865	
Fan	Type	Propeller		
	Motor Output	W	33	
Running Current (Rated)	A	5.02	4.52	
Power Consumption (Rated)	W	940	890	
Power Factor	%	86.0	85.6	
Starting Current	A	5.0		
Dimensions (H x W x D)	mm	550 x 658 x 275		
Packaged Dimensions (H x W x D)	mm	616 x 788 x 359		
Weight	kg	30		
Gross Weight	kg	34		
Operation Sound		dBA	48	48
Sound Power		dBA	62	62
Drawing No.		3D065932		

Note: ■ The data are based on the conditions shown in the table below.

Cooling	Heating	Piping Length
Indoor ; 27°CDB / 19°CWB Outdoor ; 35°CDB / 24°CWB	Indoor ; 20°CDB Outdoor ; 7°CDB / 6°CWB	5 m

Conversion Formulae
kcal/h = kW x 860 Btu/h = kW x 3412 cfm = m³/min x 35.3

50 Hz, 230 V

Model	Indoor Units		ATX20JV1B		ATX25JV1B	
	Outdoor Units		ARX20JV1B		ARX25JV1B	
			Cooling	Heating	Cooling	Heating
Capacity Rated (Min. ~ Max.)	kW		2.0 (1.3 ~ 2.6)	2.5 (1.3 ~ 3.5)	2.5 (1.3 ~ 3.0)	2.8 (1.3 ~ 4.0)
	Btu/h		6,800 (4,400 ~ 8,900)	8,500 (4,400 ~ 1,1600)	8,500 (4,400 ~ 10,200)	9,600 (4,400 ~ 13,600)
	kcal/h		1,720 (1,120 ~ 2,240)	2,150 (1,120 ~ 3,010)	2,150 (1,120 ~ 2,580)	2,410 (1,120 ~ 3,440)
Running Current (Rated)	A		2.7	3.0	3.7	3.2
Power Consumption Rated (Min. ~ Max.)	W		550 (310 ~ 720)	590 (250 ~ 950)	730 (310 ~ 1,050)	690 (250 ~ 1,110)
Power Factor (Rated)	%		88.6	91.6	85.8	93.8
COP Rated (Min. ~ Max.)	W/W		3.64 (4.19 ~ 3.61)	4.24 (5.2 ~ 3.68)	3.42 (4.19 ~ 2.86)	4.06 (5.2 ~ 3.60)
Piping Connections	Liquid	mm	φ 6.4		φ 6.4	
	Gas	mm	φ 9.5		φ 9.5	
	Drain	mm	φ 18.0		φ 18.0	
Heat Insulation			Both Liquid and Gas Pipes		Both Liquid and Gas Pipes	
Max. Interunit Piping Length	m		15		15	
Max. Interunit Height Difference	m		12		12	
Chargeless	m		10		10	
Amount of Additional Charge of Refrigerant	g/m		20		20	
Indoor Unit			ATX20JV1B		ATX25JV1B	
Front Panel Color			White		White	
Airflow Rate	m³/min (cfm)	H	9.1 (321)	9.4 (331)	9.2 (325)	9.7 (342)
		M	7.4 (261)	7.8 (276)	7.6 (268)	8.0 (283)
		L	5.9 (208)	6.3 (222)	6.0 (212)	6.3 (222)
		SL	4.7 (166)	5.5 (194)	4.8 (169)	5.5 (194)
Fan	Type		Cross Flow Fan		Cross Flow Fan	
	Motor Output	W	16		16	
	Speed	Steps	5 Steps, Quiet, Auto		5 Steps, Quiet, Auto	
Air Direction Control			Right, Left, Horizontal, Downward		Right, Left, Horizontal, Downward	
Air Filter			Removable / Washable / Mildew Proof		Removable / Washable / Mildew Proof	
Running Current (Rated)	A		0.18	0.18	0.18	0.18
Power Consumption (Rated)	W		40	40	40	40
Power Factor	%		96.6	96.6	96.6	96.6
Temperature Control			Microcomputer Control		Microcomputer Control	
Dimensions (H x W x D)	mm		283 x 770 x 198		283 x 770 x 198	
Packaged Dimensions (H x W x D)	mm		263 x 840 x 344		263 x 840 x 344	
Weight	kg		7		7	
Gross Weight	kg		11		11	
Operation Sound	H / M / L / SL	dBA	39 / 33 / 25 / 22	39 / 34 / 28 / 25	40 / 33 / 26 / 22	40 / 34 / 28 / 25
Sound Power		dBA	55	55	56	56
Outdoor Unit			ARX20JV1B		ARX25JV1B	
Casing Color			Ivory White		Ivory White	
Compressor	Type		Hermetically Sealed Swing Type		Hermetically Sealed Swing Type	
	Model		1YC23AEXDA		1YC23AEXDA	
	Motor Output	W	750		750	
Refrigerant Oil	Type		FVC50K		FVC50K	
	Charge	L	0.375		0.375	
Refrigerant	Type		R-410A		R-410A	
	Charge	kg	0.74		0.74	
Airflow Rate (H)	m³/min		29.2	26.2	29.2	26.2
	cfm		1,030	927	1,030	927
Fan	Type		Propeller		Propeller	
	Motor Output	W	33		33	
Running Current (Rated)	A		2.52	2.62	3.52	3.02
Power Consumption (Rated)	W		510	550	690	650
Power Factor	%		88.0	91.3	85.2	93.6
Starting Current	A		2.7		3.7	
Dimensions (H x W x D)	mm		550 x 658 x 275		550 x 658 x 275	
Packaged Dimensions (H x W x D)	mm		616 x 788 x 359		616 x 788 x 359	
Weight	kg		28		28	
Gross Weight	kg		31		31	
Operation Sound		dBA	46	47	46	47
Sound Power		dBA	60	61	60	61
Drawing No.			3D065933		3D065934	

Note: ■ The data are based on the conditions shown in the table below.

Cooling	Heating	Piping Length
Indoor ; 27°CDB / 19°CWB Outdoor ; 35°CDB / 24°CWB	Indoor ; 20°CDB Outdoor ; 7°CDB / 6°CWB	5 m

Conversion Formulae
kcal/h = kW x 860 Btu/h = kW x 3412 cfm = m³/min x 35.3

50 Hz, 230 V

Model	Indoor Units		ATX35JV1B	
	Outdoor Units		ARX35JV1B	
			Cooling	Heating
Capacity Rated (Min. ~ Max.)	kW		3.3 (1.3 ~ 3.8)	3.5 (1.3 ~ 4.8)
	Btu/h		11,300 (4,400 ~ 13,000)	11,900 (4,400 ~ 16,400)
	kcal/h		2,840 (1,120 ~ 3,270)	3,010 (1,120 ~ 4,130)
Running Current (Rated)	A		5.2	4.7
Power Consumption Rated (Min. ~ Max.)	W		980 (290 ~ 1,300)	930 (290 ~ 1,290)
Power Factor	%		81.9	86.0
COP Rated (Min. ~ Max.)	W/W		3.37 (4.48 ~ 2.92)	3.76 (4.48 ~ 3.72)
Piping Connections	Liquid	mm	φ 6.4	
	Gas	mm	φ 9.5	
	Drain	mm	φ 18.0	
Heat Insulation			Both Liquid and Gas Pipes	
Max. Interunit Piping Length	m		15	
Max. Interunit Height Difference	m		12	
Chargeless	m		10	
Amount of Additional Charge of Refrigerant	g/m		20	
Indoor Unit			ATX35JV1B	
Front Panel Color			White	
Airflow Rate	m³/min (cfm)	H	9.3 (328)	10.1 (356)
		M	7.7 (272)	8.4 (295)
		L	6.1 (215)	6.7 (235)
		SL	4.9 (173)	5.7 (201)
Fan	Type		Cross Flow Fan	
	Motor Output	W	16	
	Speed	Steps	5 Steps, Quiet, Auto	
Air Direction Control			Right, Left, Horizontal, Downward	
Air Filter			Removable / Washable / Mildew Proof	
Running Current (Rated)	A		0.18	0.18
Power Consumption (Rated)	W		40	40
Power Factor	%		96.6	96.6
Temperature Control			Microcomputer Control	
Dimensions (H x W x D)	mm		283 x 770 x 198	
Packaged Dimensions (H x W x D)	mm		263 x 840 x 344	
Weight	kg		7	
Gross Weight	kg		11	
Operation Sound	H / M / L / SL	dBA	41 / 34 / 27 / 23	41 / 35 / 29 / 26
Sound Power		dBA	57	57
Outdoor Unit			ARX35JV1B	
Casing Color			Ivory White	
Compressor	Type		Hermetically Sealed Swing Type	
	Model		1YC23AEXDA	
	Motor Output	W	750	
Refrigerant Oil	Type		FVC50K	
	Charge	L	0.375	
Refrigerant	Type		R-410A	
	Charge	kg	1.0	
Airflow Rate (H)	m³/min		27.6	24.5
	cfm		975	865
Fan	Type		Propeller	
	Motor Output	W	33	
Running Current (Rated)	A		5.02	4.52
Power Consumption (Rated)	W		940	890
Power Factor	%		86.0	85.6
Starting Current	A		5.0	
Dimensions (H x W x D)	mm		550 x 658 x 275	
Packaged Dimensions (H x W x D)	mm		616 x 788 x 359	
Weight	kg		30	
Gross Weight	kg		34	
Operation Sound		dBA	48	48
Sound Power		dBA	62	62
Drawing No.			3D065935	

Note: ■ The data are based on the conditions shown in the table below.

Cooling	Heating	Piping Length
Indoor ; 27°CDB / 19°CWB Outdoor ; 35°CDB / 24°CWB	Indoor ; 20°CDB Outdoor ; 7°CDB / 6°CWB	5 m

Conversion Formulae
kcal/h = kW x 860 Btu/h = kW x 3412 cfm = m³/min x 35.3

Part 3 Printed Circuit Board Connector Wiring Diagram

1. Printed Circuit Board Connector Wiring Diagram.....	9
1.1 Indoor Unit.....	9
1.2 Outdoor Unit.....	11

1. Printed Circuit Board Connector Wiring Diagram

1.1 Indoor Unit

Connectors and Other Parts

PCB(1): Control PCB

- | | |
|-------------------|--|
| 1) S6 | Connector for swing motor (horizontal blade) |
| 2) S26 | Connector for display PCB |
| 3) S32 | Connector for indoor heat exchanger thermistor |
| 4) S200 | Connector for fan motor |
| 5) S403 | Connector for adaptor PCB (option) |
| 6) H1, H2, H3, FG | Connector for terminal board |
| 7) V1 | Varistor |
| 8) JA | Address setting jumper |
| JB | Fan speed setting when compressor stops for thermostat OFF |
| JC | Power failure recovery function (auto-restart) |
| | * Refer to page 140 for detail. |
| 9) LED A | LED for service monitor (green) |
| 10)FU1 (F1U) | Fuse (3.15 A, 250 V) |

PCB(2): Display PCB

- | | |
|---------------|--------------------------------|
| 1) S27 | Connector for control PCB |
| 2) SW1 (S1W) | Forced operation ON/OFF button |
| 3) LED1 (H1P) | LED for operation (green) |
| 4) LED2 (H2P) | LED for timer (yellow) |
| 5) RTH1 (R1T) | Room temperature thermistor |

PCB Detail

PCB(1): Control PCB

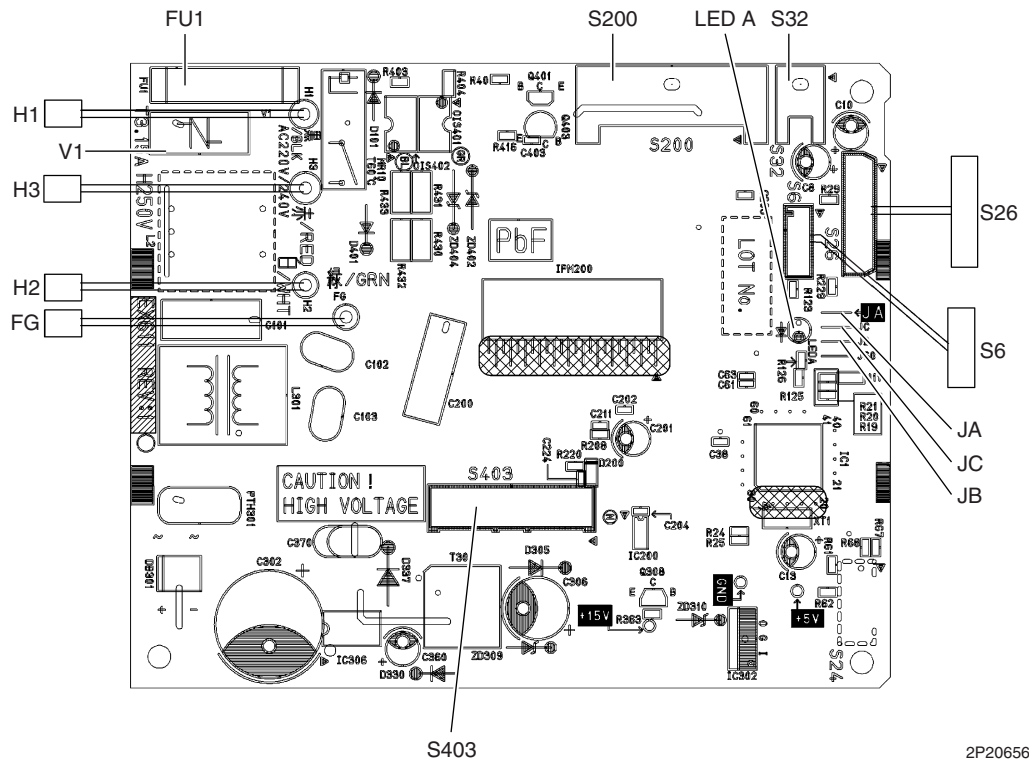

2P206569-1

PCB(2): Display PCB

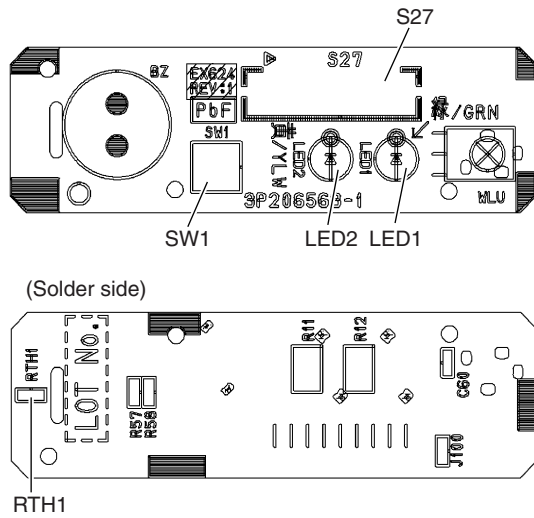

(Solder side)

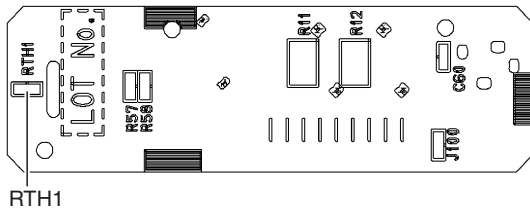

3P206563-1

1.2 Outdoor Unit

Connectors and Other Parts

PCB(1): Filter PCB

1) S11	Connector for main PCB
2) AC1, AC2, S	Connector for terminal board
3) E1, E2	Terminal for ground
4) HL2, HN2	Connector for main PCB
5) HR1	Connector for reactor
6) FU3	Fuse (20 A, 250 V)
7) V2, V3	Varistor

PCB(2): Main PCB

1) S10	Connector for filter PCB
2) S20	Connector for electronic expansion valve coil
3) S40	Connector for overload protector
4) S70	Connector for fan motor
5) S80	Connector for four way valve coil
6) S90	Connector for thermistors (outdoor temperature, outdoor heat exchanger, discharge pipe)
7) HL3, HN3	Connector for filter PCB
8) HR2	Connector for reactor
9) U, V, W	Connector for compressor
10)FU1, FU2	Fuse (3.15 A, 250 V)
11)LED A	LED for service monitor (green)
12)V1	Varistor
13)J5	Jumper for improvement of defrost performance * Refer to page 140 for detail.

PCB Detail

PCB(1): Filter PCB

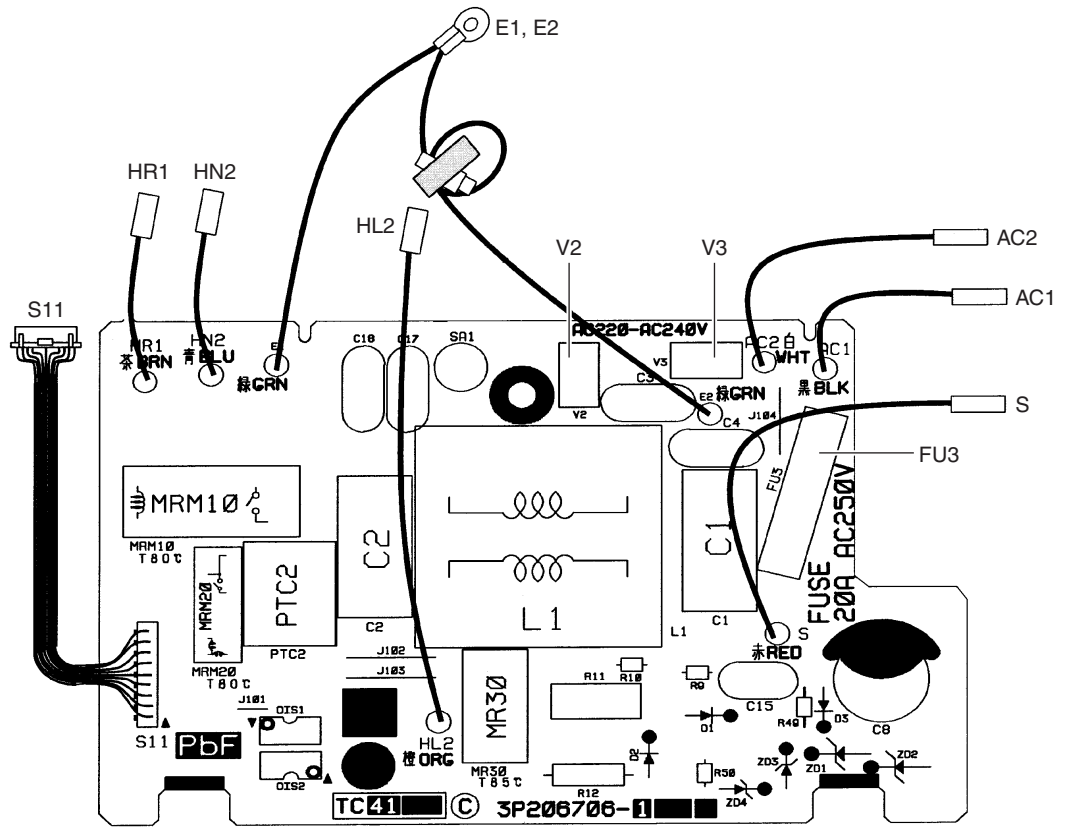

3P206706-1

PCB(2): Main PCB

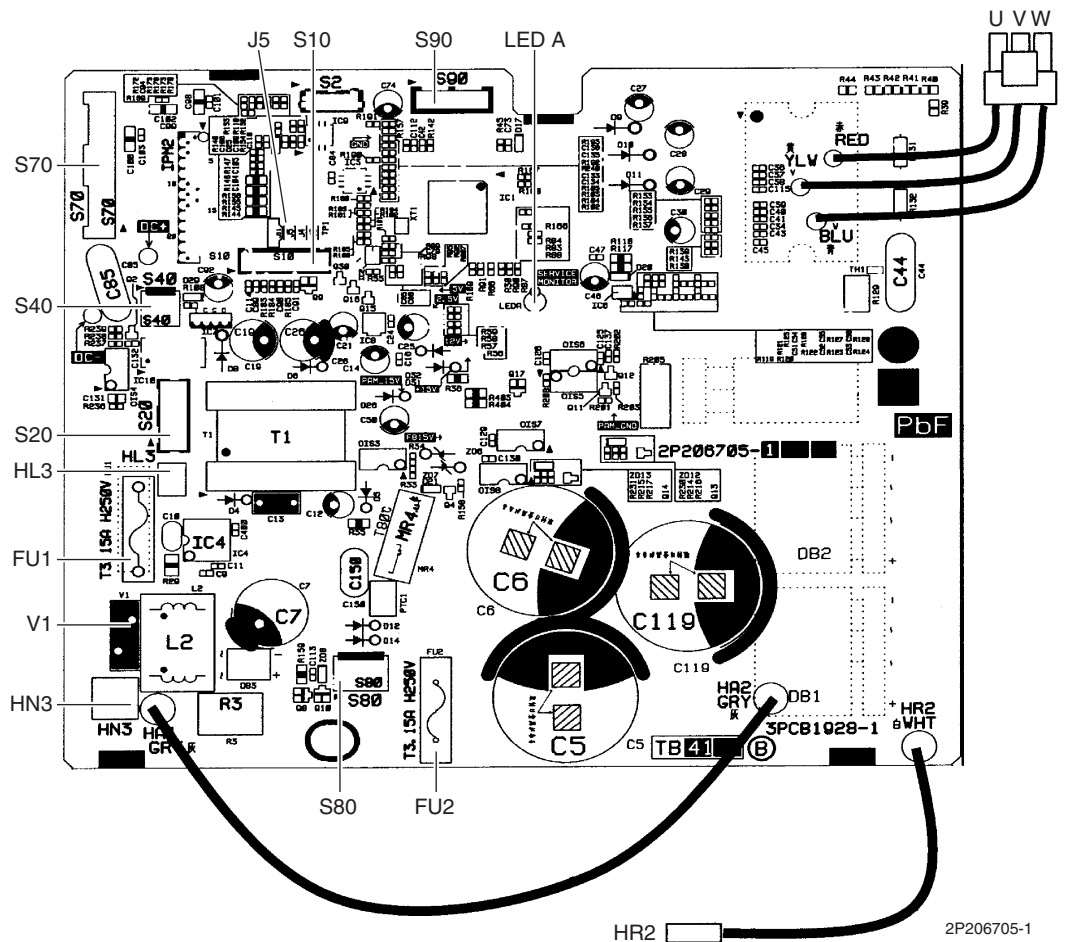

2P206705-1

Part 4

Function and Control

1. Main Functions.....	14
1.1 Frequency Principle.....	14
1.2 Airflow Direction Control.....	16
1.3 Fan Speed Control for Indoor Units.....	17
1.4 Program Dry Operation.....	18
1.5 Automatic Operation.....	19
1.6 Thermostat Control.....	20
1.7 NIGHT SET Mode.....	21
1.8 ECONO Operation.....	22
1.9 Inverter POWERFUL Operation.....	23
1.10 Other Functions.....	24
2. Function of Thermistor.....	25
3. Control Specification.....	26
3.1 Mode Hierarchy.....	26
3.2 Frequency Control.....	27
3.3 Controls at Mode Changing / Start-up.....	29
3.4 Discharge Pipe Temperature Control.....	30
3.5 Input Current Control.....	31
3.6 Freeze-up Protection Control.....	32
3.7 Heating Peak-cut Control.....	32
3.8 Outdoor Fan Control.....	33
3.9 Liquid Compression Protection Function.....	33
3.10 Defrost Control.....	34
3.11 Electronic Expansion Valve Control.....	35
3.12 Malfunctions.....	38
3.13 Forced Operation Mode.....	39

1. Main Functions

1.1 Frequency Principle

Main Control Parameters

The compressor is frequency-controlled during normal operation. The target frequency is set by the following 2 parameters coming from the operating indoor unit:

- The load condition of the operating indoor unit
- The difference between the room temperature and the target temperature

Additional Control Parameters

The target frequency is adapted by additional parameters in the following cases:

- Frequency restrictions
- Initial settings
- Forced cooling operation

Inverter Principle

To regulate the capacity, a frequency control is needed. The inverter makes it possible to vary the rotation speed of the compressor. The following table explains the conversion principle:

Phase	Description
1	The supplied AC power source is converted into the DC power source for the present.
2	The DC power source is reconverted into the three phase AC power source with variable frequency. <ul style="list-style-type: none"> ■ When the frequency increases, the rotation speed of the compressor increases resulting in an increased refrigerant circulation. This leads to a higher amount of the heat exchange per unit. ■ When the frequency decreases, the rotation speed of the compressor decreases resulting in a decreased refrigerant circulation. This leads to a lower amount of the heat exchange per unit.

Drawing of Inverter

The following drawing shows a schematic view of the inverter principle:

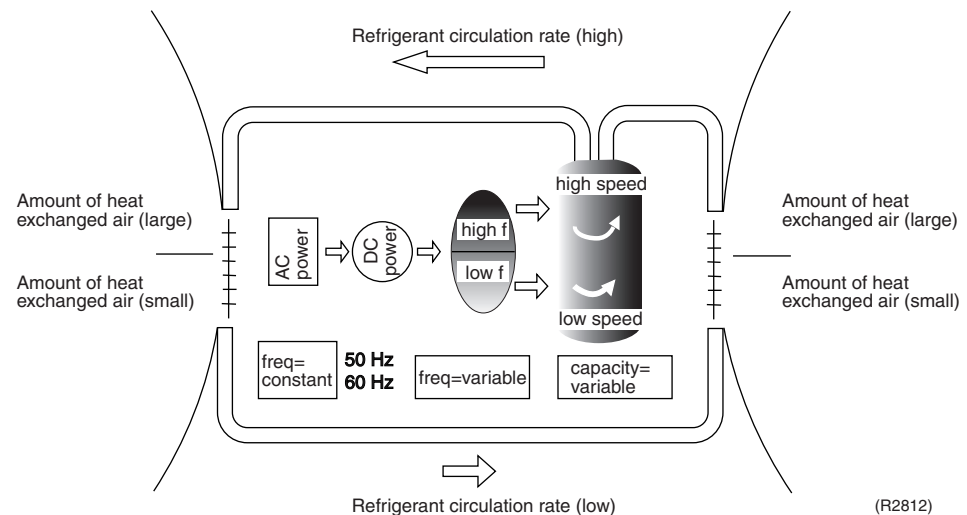

Inverter Features

The inverter provides the following features:

- The regulating capacity can be changed according to the changes in the outdoor temperature and cooling / heating load.
- Quick heating and quick cooling
The compressor rotational speed is increased when starting the heating (or cooling). This enables to reach the set temperature quickly.
- Even during extreme cold weather, the high capacity is achieved. It is maintained even when the outdoor temperature is 2°C.
- Comfortable air conditioning
A fine adjustment is integrated to keep the room temperature constant.
- Energy saving heating and cooling
Once the set temperature is reached, the energy saving operation enables to maintain the room temperature at low power.

Frequency Limits

The following functions regulate the minimum and maximum frequency:

Frequency	Functions
Low	<ul style="list-style-type: none"> ■ Four way valve operation compensation. Refer to page 29.
High	<ul style="list-style-type: none"> ■ Compressor protection function. Refer to page 30. ■ Discharge pipe temperature control. Refer to page 30. ■ Input current control. Refer to page 31. ■ Freeze-up protection control. Refer to page 32. ■ Heating peak-cut control. Refer to page 32. ■ Defrost control. Refer to page 34.

Forced Cooling Operation

Refer to "Forced operation mode" on page 39 for detail.

1.2 Airflow Direction Control

Power-Airflow Flap

The large flap sends a large volume of air downwards to the floor. The flap provides an optimum control in cooling, dry, and heating mode.

Cooling / Dry Mode

During cooling or dry mode, the flap retracts into the indoor unit. Then, cool air can be blown far and pervaded all over the room.

Heating Mode

During heating mode, the large flap directs airflow downwards to spread the warm air to the entire room.

Wide-Angle Louvers

The louvers, made of elastic synthetic resin, provide a wide range of airflow that guarantees a comfortable air distribution.

Auto-Swing

The following table explains the auto swing process for cooling, dry, fan, and heating :

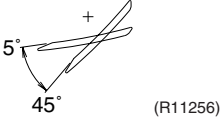
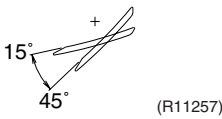
Vertical Swing (up and down)	
Cooling / Dry / Fan	Heating
	

COMFORT AIRFLOW Operation

The vertical swing flap is controlled not to blow the air directly on the person in the room.

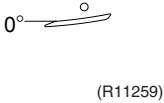
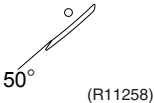
Cooling	Heating
	

1.3 Fan Speed Control for Indoor Units

Outline

Phase control and fan speed control contains 9 steps: LLL, LL, SL, L, ML, M, MH, H, and HH. The airflow rate can be automatically controlled depending on the difference between the room temperature and the target temperature. This is done through phase control and Hall IC control.



For more information about Hall IC, refer to the troubleshooting for fan motor on page 61.

Automatic Fan Speed Control

In automatic fan speed operation, the step "SL" is not available.

Step	Cooling	Heating
LLL	 (R6833)	 (R11975)
LL		
L		
ML		
M		
MH		
H		
HH (POWERFUL)		

= The airflow rate is automatically controlled within this range when the FAN setting button is set to automatic.

<Cooling>

The following drawing explains the principle of fan speed control for cooling.

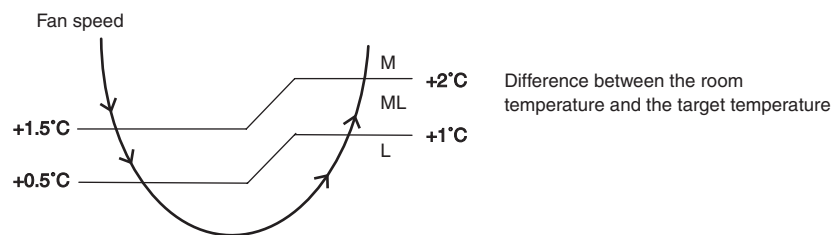

<Heating>

On heating mode, the fan speed is regulated according to the indoor heat exchanger temperature and the difference between the room temperature and the target temperature.



Note:

1. During POWERFUL operation, fan rotates at H tap + 80 rpm.
2. Fan stops during defrost operation.
3. In time of thermostat OFF, the fan rotates at the following speed.
Cooling: The fan keeps rotating at the set tap.
Heating: The fan keeps rotating at LLL tap.

1.4 Program Dry Operation

Outline

Program dry operation removes humidity while preventing the room temperature from lowering. Since the microcomputer controls both the temperature and airflow rate, the temperature adjustment and fan adjustment buttons are inoperable in this mode.

Detail

The microcomputer automatically sets the temperature and airflow rate. The difference between the room temperature at start-up and the target temperature is divided into two zones. Then, the unit operates in the dry mode with an appropriate capacity for each zone to maintain the temperature and humidity at a comfortable level.

Room temperature at start-up	Target temperature X	Thermostat OFF point Y	Thermostat ON point Z
24°C or more	Room temperature at start-up	$X - 2.5^{\circ}\text{C}$	$X - 0.5^{\circ}\text{C}$ or $Y + 0.5^{\circ}\text{C}$ (zone B) continues for 10 min.
23.5°C ⋮ 18°C		$X - 2.0^{\circ}\text{C}$	$X - 0.5^{\circ}\text{C}$ or $Y + 0.5^{\circ}\text{C}$ (zone B) continues for 10 min.
17.5°C ⋮		$X - 2.0^{\circ}\text{C}$	$X - 0.5^{\circ}\text{C} = 17.5^{\circ}\text{C}$ or $Y + 0.5^{\circ}\text{C}$ (zone B) continues for 10 min.

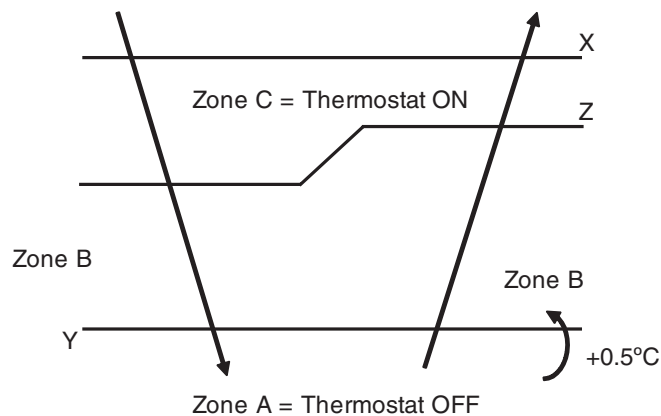

(R11581)

1.5 Automatic Operation

Outline

Automatic Cooling / Heating Function

When the AUTO mode is selected with the remote controller, the microcomputer automatically determines the operation mode as cooling or heating according to the room temperature and the set temperature at start-up, and automatically operates in that mode.

The unit automatically switches the operation mode to maintain the room temperature at the set temperature.

Detail

Tc: temperature set by remote controller

Tt: target temperature

Tr: room temperature

C: correction value

- The temperature set by remote controller (Tc) determines the target temperature (Tt).
(Tc = 18 ~ 30°C).
- The target temperature (Tt) is calculated as;

$$Tt = Tc + C$$
 where C is the correction value.

$$C = 0^\circ\text{C}$$
- Thermostat ON/OFF point and mode switching point are as follows.
 Tr means the room temperature.
 - Heating → Cooling switching point:

$$Tr \geq Tt + 2.5^\circ\text{C}$$
 - Cooling → Heating switching point:

$$Tr < Tt - 2.5^\circ\text{C}$$
 - Thermostat ON/OFF point is the same as the ON/OFF point of cooling or heating operation.
- During initial operation
 - $Tr \geq Tc$: Cooling operation
 - $Tr < Tc$: Heating operation

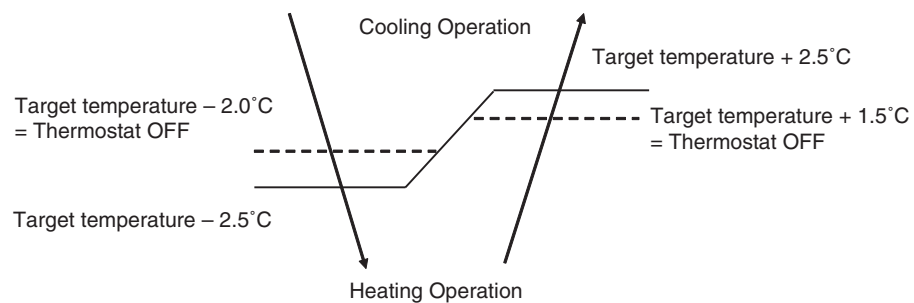

(R11893)

Ex: When the target temperature is 25°C

Cooling → 23°C: Thermostat OFF → 22°C: Switch to heating

Heating → 26.5°C: Thermostat OFF → 27.5°C: Switch to cooling

1.6 Thermostat Control

Thermostat control is based on the difference between the room temperature and the target temperature.

Thermostat OFF Condition

- ◆ The temperature difference is in the zone A.

Thermostat ON Condition

- ◆ The temperature difference returns to the zone C after being in the zone A.
- ◆ The system resumes from defrost control in any zones except A.
- ◆ The operation turns on in any zones except A.
- ◆ The monitoring time has passed while the temperature difference is in the zone B.
(Cooling / Dry : 10 minutes, Heating : 10 seconds)

Cooling / Dry

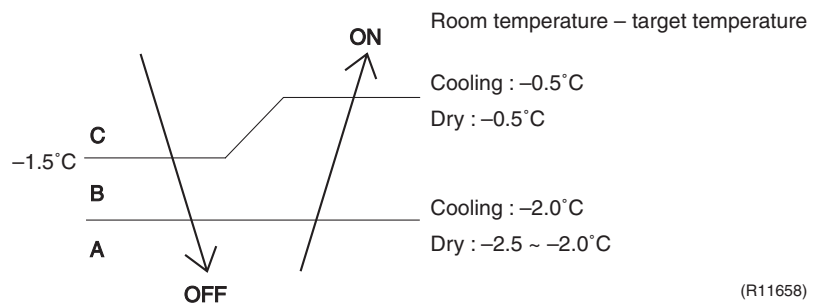

Heating

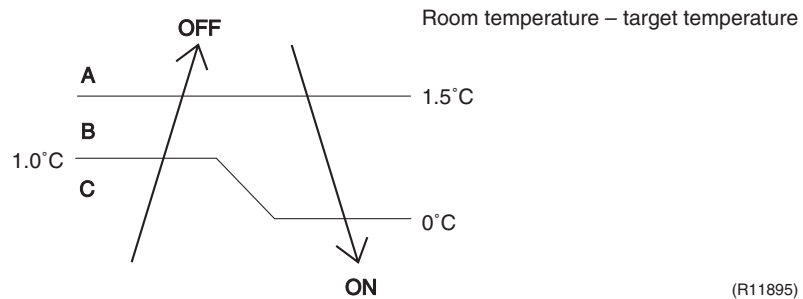

1.7 NIGHT SET Mode

Outline

When the OFF timer is set, the NIGHT SET Mode is automatically activated. The NIGHT SET Mode keeps the airflow rate setting.

Detail

The NIGHT SET Mode continues operation at the target temperature for the first one hour, then automatically raises the target temperature slightly in the case of cooling, or lowers it slightly in the case of heating. This prevents excessive cooling in summer and excessive heating in winter to ensure comfortable sleeping conditions, and also conserves electricity.

Cooling

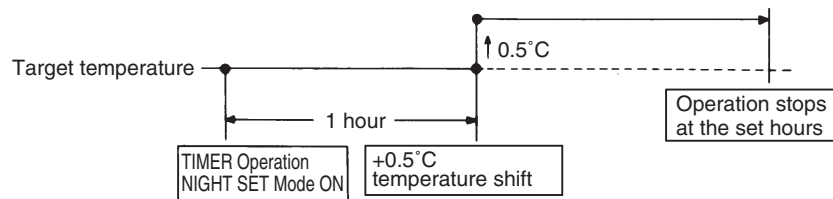

(R12011)

Heating

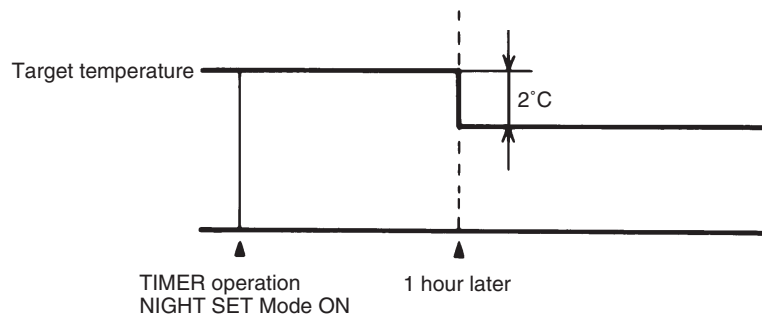

(R12012)

1.8 ECONO Operation

Outline

The "ECONO operation" reduces the maximum operating current and power consumption during start-up etc..

This operation is particularly convenient for energy-saving-oriented users. It is also a major bonus for those whose breaker capacities do not allow the use of multiple electrical devices and air conditioners.

It is easily activated from the wireless remote controller by pushing the ECONO button.

- When this function is activated, the maximum capacity decreases.
- The remote controller can send the ECONO command when the unit is in COOL, HEAT, DRY, or AUTO operation. This function can only be set when the unit is running. Pressing the ON/OFF button on the remote controller cancels the function.
- This function and POWERFUL operation cannot be used at the same time. The latest command has the priority.

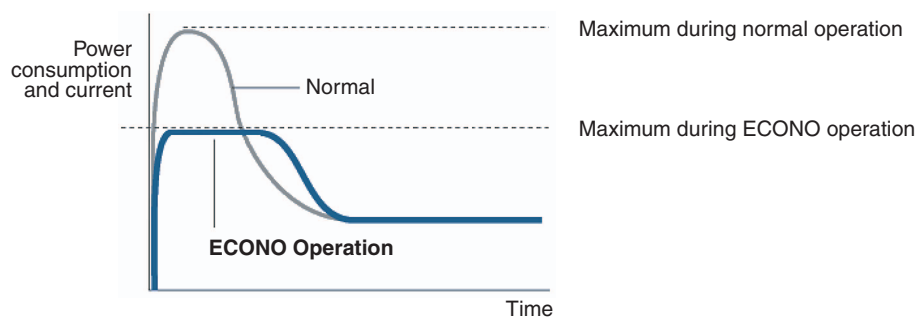

(R12013)

Detail

- When the ECONO command is valid, the input current is under reducing control. (Refer to "Input current control" on page 31.)

1.9 Inverter POWERFUL Operation

Outline

In order to exploit the cooling and heating capacity to full extent, operate the air conditioner by increasing the indoor fan rotating speed and the compressor frequency.

Detail

When POWERFUL button is pressed, the fan speed and target temperature are converted to the following states for 20 minutes.

Operation mode	Fan speed	Target temperature
COOL	H tap + 80 rpm	18°C
DRY	DRY rotating speed + 80 rpm	Lowered by 2.5°C
HEAT	H tap + 80 rpm	31°C
FAN	H tap + 80 rpm	—
AUTO	Same as cooling / heating in POWERFUL operation	The target temperature is kept unchanged.

Ex.) : POWERFUL operation in cooling mode.

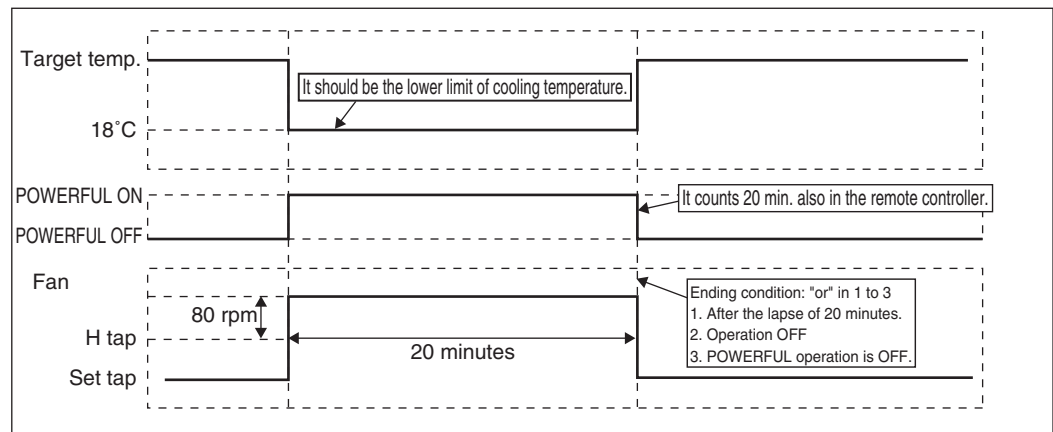

(R11976)

1.10 Other Functions

1.10.1 Hot-Start Function

In order to prevent the cold air blast that normally comes when heating operation is started, the temperature of the indoor heat exchanger is detected, and either the airflow is stopped or is made very weak thereby carrying out comfortable heating of the room.

*The cold air blast is also prevented using a similar control when the defrosting operation is started or when the thermostat is turned ON.

1.10.2 Signal Receiving Sign

When the indoor unit receives a signal from the remote controller, the unit emits a signal receiving sound.

1.10.3 Indoor Unit ON/OFF Button

An ON/OFF button is provided on the display of the unit.

- Press this button once to start operation. Press once again to stop it.
- This button is useful when the remote controller is missing or the battery has run out.
- The operation mode refers to the following table.

Mode	Temperature setting	Airflow rate
AUTO	25°C	Automatic

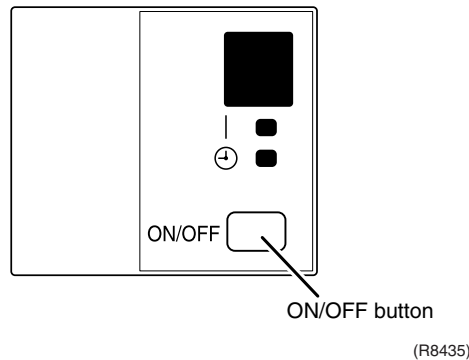

<Forced operation mode>

Forced operation mode can be started by pressing the ON/OFF button for 5 to 9 seconds while the unit is not operating.

Refer to "Forced operation mode" on page 39 for detail.



Note: When the ON/OFF button is pressed for 10 seconds or more, the forced operation is stopped.

1.10.4 Titanium Apatite Photocatalytic Air-Purifying Filter

This filter combines the Air-Purifying Filter and Titanium Apatite Photocatalytic Deodorizing Filter as a single highly effective filter. The filter traps microscopic particles, decompose odors and even deactivates bacteria and viruses. It lasts for 3 years without replacement if washed about once every 6 months.

1.10.5 Auto-restart Function

Even if a power failure (including one for just a moment) occurs during the operation, the operation restarts automatically when the power is restored in the same condition as before the power failure.



Note: It takes 3 minutes to restart the operation because the 3-minute standby function is activated.

2. Function of Thermistor

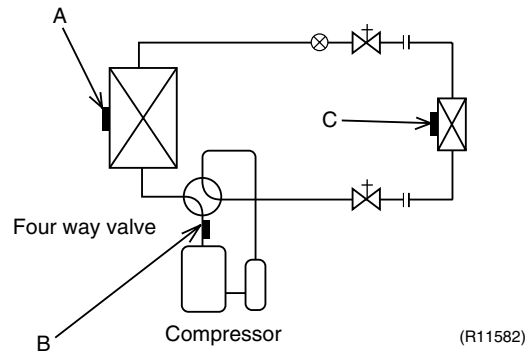

A Outdoor Heat Exchanger Thermistor

1. The outdoor heat exchanger thermistor is used for controlling target discharge pipe temperature. The system sets the target discharge pipe temperature according to the outdoor and indoor heat exchanger temperature, and controls the electronic expansion valve opening so that the target discharge pipe temperature can be obtained.
2. In cooling operation, the outdoor heat exchanger thermistor is used for detecting disconnection of the discharge pipe thermistor. When the discharge pipe temperature becomes lower than the outdoor heat exchanger temperature, the discharge pipe thermistor is judged as disconnected.
3. In cooling operation, the outdoor heat exchanger thermistor is used for high pressure protection.

B Discharge Pipe Thermistor

1. The discharge pipe thermistor is used for controlling discharge pipe temperature. If the discharge pipe temperature (used in place of the inner temperature of the compressor) rises abnormally, the operating frequency becomes lower or the operation halts.
2. The discharge pipe thermistor is used for detecting disconnection of the discharge pipe thermistor.

C Indoor Heat Exchanger Thermistor

1. The indoor heat exchanger thermistor is used for controlling target discharge pipe temperature. The system sets the target discharge pipe temperature according to the outdoor and indoor heat exchanger temperature, and controls the electronic expansion valve opening so that the target discharge pipe temperature can be obtained.
2. In cooling operation, the indoor heat exchanger thermistor is used for freeze-up protection control. If the indoor heat exchanger temperature drops abnormally, the operating frequency becomes lower or the operation halts.
3. In heating operation, the indoor heat exchanger thermistor is used for detecting disconnection of the discharge pipe thermistor. When the discharge pipe temperature becomes lower than the indoor heat exchanger temperature, the discharge pipe thermistor is judged as disconnected.

3. Control Specification

3.1 Mode Hierarchy

Outline

There are two modes; the one is the normal operation mode and the other is the forced operation mode for installation and providing service.

Detail

There are following modes; stop, cooling (includes drying), heating (include defrosting)

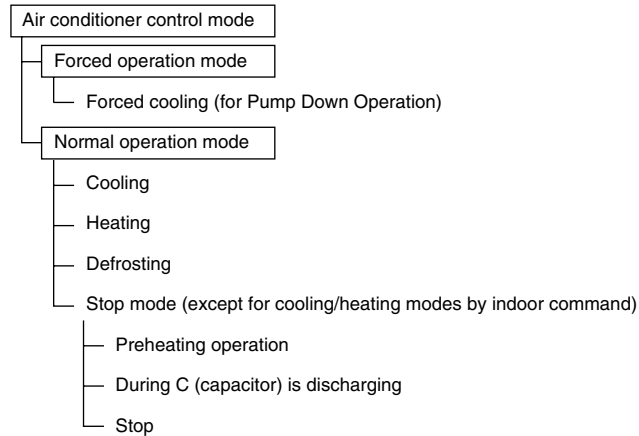

(R2829)



Note: Unless specified otherwise, an indoor dry operation command is regarded as cooling operation.

3.2 Frequency Control

Outline

Frequency is determined according to the difference between the room temperature and the target temperature.

The function is explained as follows.

1. How to determine frequency
2. Frequency command from the indoor unit (Difference between the room temperature and the target temperature)
3. Frequency initial setting
4. PI control

When the shift of the frequency is less than zero ($\Delta F < 0$) by PI control, the target frequency is used as the command frequency.

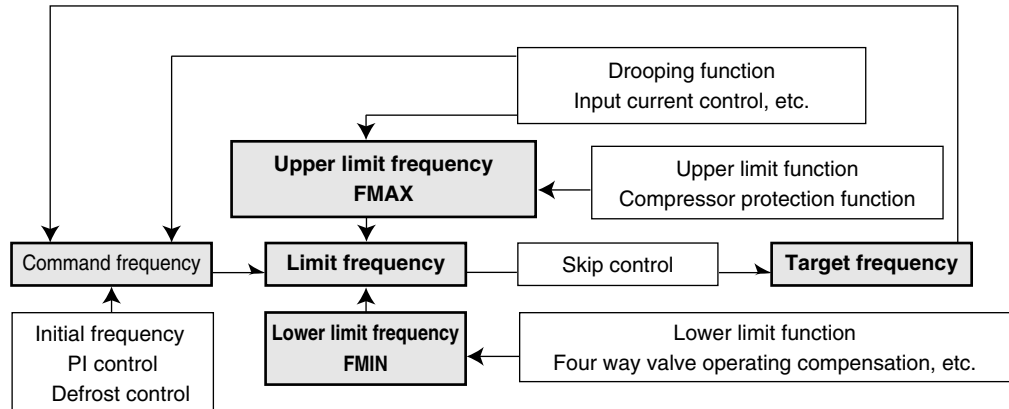

(R2831)

Detail

How to Determine Frequency

The compressor's frequency is determined by taking the following steps.

1. Determine command frequency

- ◆ Command frequency is determined in the following order of priority.
 1. Limiting defrost control time
 2. Forced cooling
 3. Indoor frequency command

2. Determine upper limit frequency

- ◆ The minimum value is set as an upper limit frequency among the frequency upper limits of the following functions:
Compressor protection, input current, discharge pipe temperature, heating peak-cut, freeze-up protection, defrost.

3. Determine lower limit frequency

- ◆ The maximum value is set as a lower limit frequency among the frequency lower limits of the following functions:
Four way valve operation compensation, draft prevention, pressure difference upkeep.

4. Determine prohibited frequency

- ◆ There is a certain prohibited frequency such as a power supply frequency.

Indoor Frequency Command (ΔD signal)

The difference between the room temperature and the target temperature is taken as the “ ΔD signal” and is used for frequency command.

Temperature difference (°C)	ΔD signal	Temperature difference (°C)	ΔD signal	Temperature difference (°C)	ΔD signal	Temperature difference (°C)	ΔD signal
-2.0	*Th OFF	0	4	2.0	8	4.0	C
-1.5	1	0.5	5	2.5	9	4.5	D
-1.0	2	1.0	6	3.0	A	5.0	E
-0.5	3	1.5	7	3.5	B	5.5	F

*Th OFF = Thermostat OFF

Frequency Initial Setting**<Outline>**

When starting the compressor, the frequency is initialized according to the ΔD value and the Q value of the indoor unit.

Q value: Indoor unit output determined from indoor unit volume, airflow rate and other factors.

PI Control (Determine Frequency Up / Down by ΔD Signal)**1. P control**

The ΔD value is calculated in each sampling time (20 seconds), and the frequency is adjusted according to its difference from the frequency previously calculated.

2. I control

If the operating frequency does not change for more than a certain fixed time, the frequency is adjusted according to the ΔD value.

When the ΔD value is small, the frequency is lowered.

When the ΔD value is large, the frequency is increased.

3. Frequency management when other controls are functioning

- ◆ When frequency is drooping;
Frequency management is carried out only when the frequency droops.
- ◆ For limiting lower limit
Frequency management is carried out only when the frequency rises.

4. Upper and lower limit of frequency by PI control

The frequency upper and lower limits are set according to the command on indoor unit.

When the indoor or outdoor unit quiet operation command comes from the indoor unit, the upper limit frequency is lowered than the usual setting.

3.3 Controls at Mode Changing / Start-up

3.3.1 Preheating Operation

Outline The inverter operation in open phase starts with the conditions of the preheating command from the indoor unit, the outdoor temperature, and the discharge pipe temperature.

Detail Outdoor temperature $\geq 7^{\circ}\text{C}$ → Control A
Outdoor temperature $< 7^{\circ}\text{C}$ → Control B

Control A

- ◆ ON condition
 - Discharge pipe temperature $< 10^{\circ}\text{C}$
 - Radiation fin temperature $< 85^{\circ}\text{C}$
- ◆ OFF condition
 - Discharge pipe temperature $> 12^{\circ}\text{C}$
 - Radiation fin temperature $\geq 90^{\circ}\text{C}$

Control B

- ◆ ON condition
 - Discharge pipe temperature $< 20^{\circ}\text{C}$
 - Radiation fin temperature $< 85^{\circ}\text{C}$
- ◆ OFF condition
 - Discharge pipe temperature $> 22^{\circ}\text{C}$
 - Radiation fin temperature $\geq 90^{\circ}\text{C}$

3.3.2 Four Way Valve Switching

Outline In heating operation, current is conducted, and in cooling and defrosting, current is not conducted. In order to eliminate the switching sound when the heating is stopped, as the four way valve coil switches from ON to OFF, the OFF delay switch of the four way valve is carried out after the operation stopped.

Detail **OFF delay switch of four way valve:**
The four way valve coil is energized for 160 seconds after the operation is stopped.

3.3.3 Four Way Valve Operation Compensation

Outline At the beginning of the operation as the four way valve is switched, the differential pressure to activate the four way valve is acquired by having output frequency which is more than a certain fixed frequency, for a certain fixed time.

Detail **Starting Conditions**

1. When starting compressor for heating.
2. When the operation mode changes to cooling from heating.
3. When starting compressor for defrosting or resetting.
4. When starting compressor for the first time after the reset with the power is ON.
5. When starting compressor for heating next to the suspension of defrosting.
6. When starting compressor next to the fault of switching over cooling / heating.

Set the lower limit frequency A Hz for B seconds with any conditions 1 through 6 above.

A (Hz)	62
B (seconds)	50

3.3.4 3-minute Standby

Turning on the compressor is prohibited for 3 minutes after turning it off.
(Except when defrosting.)

3.3.5 Compressor Protection Function

When turning the compressor from OFF to ON, the upper limit of frequency is set as follows.
(The function is not activated when defrosting.)

FCG 1	58	Hz
FCG 2	72	
FCG 3	90	
TCG 1	180	seconds
TCG 2	180	
TCG 3	10	

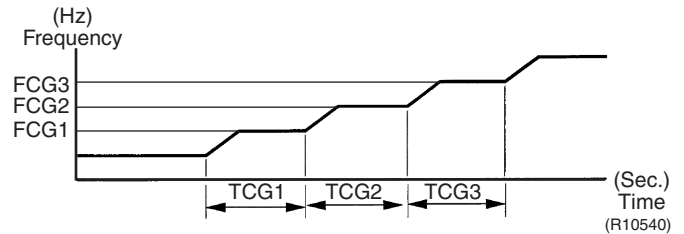

3.4 Discharge Pipe Temperature Control

Outline

The discharge pipe temperature is used as the internal temperature of the compressor. If the discharge pipe temperature rises above a certain level, the upper limit of frequency is set to keep this temperature from going up further.

Detail

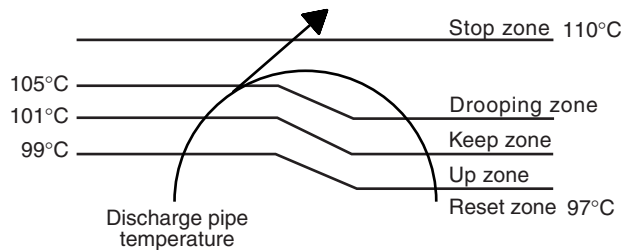

(R12014)

Zone	Control
Stop zone	When the temperature reaches the stop zone, the compressor stops.
Drooping zone	The timer starts, and the frequency is drooping.
Keep zone	The upper limit of frequency is kept.
Up zone	The upper limit of frequency is increased.
Reset zone	The upper limit of frequency is canceled.

3.5 Input Current Control

Outline

The microcomputer calculates the input current during the compressor is running, and sets the frequency upper limit from the input current.

In case of heat pump model, this control which is the upper limit control of the frequency takes priority to the lower limit of control of four way valve operation compensation.

Detail

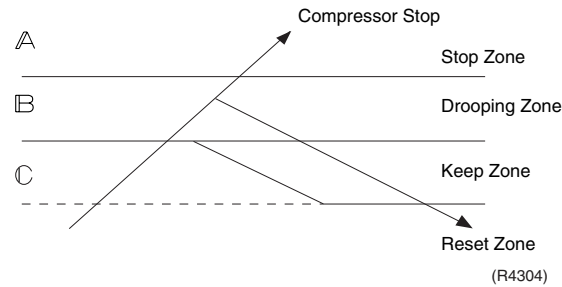

Frequency control in each zone

Stop zone

- ◆ After 2.5 seconds in this zone, the compressor is stopped.

Drooping zone

- ◆ The upper limit of the compressor frequency is defined as operation frequency – 2 Hz.
- ◆ After this, the output frequency is pulled down by 2 Hz every second until it reaches the keep zone.

Keep zone

- ◆ The present maximum frequency goes on.

Reset zone

- ◆ Limit of the frequency is canceled.

		20/25 class		35 class	
		Cooling	Heating	Cooling	Heating
A (A)		14	14	14	14
B (A)	Normal mode	6.0	6.75	6.5	7.75
	ECONO mode	2.75	2.75	2.75	2.75
C (A)	Normal mode	5.25	6.0	5.75	7.0
	ECONO mode	2.0	2.0	2.0	2.0

Limitation of current drooping and stop value according to the outdoor temperature

- ◆ The current droops when outdoor temperature becomes higher than a certain level (model by model).

3.6 Freeze-up Protection Control

Outline During cooling operation, the signal sent from the indoor unit controls the operating frequency limitation and prevents freezing of the indoor heat exchanger. (The signal from the indoor unit is divided into zones.)

Detail The operating frequency limitation is judged with the indoor heat exchanger temperature.

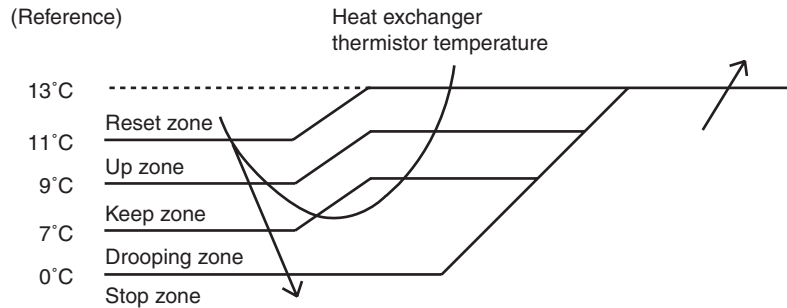

(R11997)

3.7 Heating Peak-cut Control

Outline During heating operation, the indoor heat exchanger temperature determines the frequency upper limit to prevent abnormal high pressure.

Detail

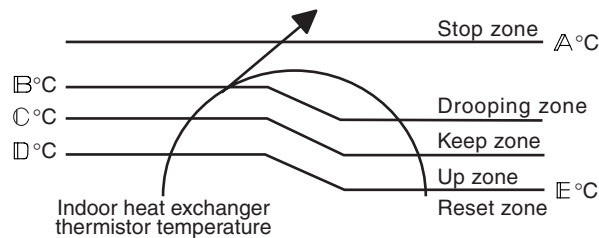

(R11998)

Zone	Control
Stop zone	When the temperature reaches the stop zone, the compressor stops.
Drooping zone	The timer starts, and the frequency is drooping.
Keep zone	The upper limit of frequency is kept.
Up zone	The upper limit of frequency is increased.
Reset zone	The upper limit of frequency is canceled.

A (°C)	65
B (°C)	55
C (°C)	52
D (°C)	50
E (°C)	45

3.8 Outdoor Fan Control

1. Fan OFF delay when stopped

The outdoor fan is turned OFF 70 seconds after the compressor stops.

2. Fan ON control to cool down the electrical box

The outdoor fan is turned ON when the electrical box temperature is high while the compressor is OFF.

3. Fan OFF control while defrosting

The outdoor fan is turned OFF while defrosting.

4. Fan ON/OFF control when operation starts/stops

The outdoor fan is turned ON when the operation starts. The outdoor fan is turned OFF when the operation stops.

5. Fan control while forced operation

The outdoor fan is controlled as well as normal operation while the forced operation.

6. Fan speed control while indoor/outdoor quiet operation

The rotation speed of the outdoor fan is reduced by the command of the indoor/outdoor quiet operation.

7. Fan control for POWERFUL operation

The rotation speed of the outdoor fan is increased while the POWERFUL operation.

8. Fan speed control for pressure difference upkeep

The rotation speed of the outdoor fan is controlled for keeping the pressure difference while cooling with low outdoor temperature.

- ◆ When the pressure difference is small, the rotation speed of the outdoor fan is reduced.
- ◆ When the pressure difference is large, the rotation speed of the outdoor fan is increased.

3.9 Liquid Compression Protection Function

Outline

In order to obtain the dependability of the compressor, the compressor is stopped according to the outdoor temperature and temperature of the outdoor heat exchanger.

Detail

- Operation stops depending on the outdoor temperature

Compressor turns off under the conditions that the system is in cooling operation and outdoor temperature is below 0°C.

3.10 Defrost Control

Outline

Defrosting is carried out by the cooling cycle (reverse cycle). The defrosting time or outdoor heat exchanger temperature must be more than a certain value to finish.

Detail

Conditions for Starting Defrost

- The starting conditions is determined with the outdoor temperature and the outdoor heat exchanger temperature.
- The system is in heating operation.
- The compressor operates for 6 minutes.
- More than 28 minutes of accumulated time pass since the start of the operation, or ending the previous defrosting.

Conditions for Canceling Defrost

The judgment is made with outdoor heat exchanger temperature. (4°C - 22°C)

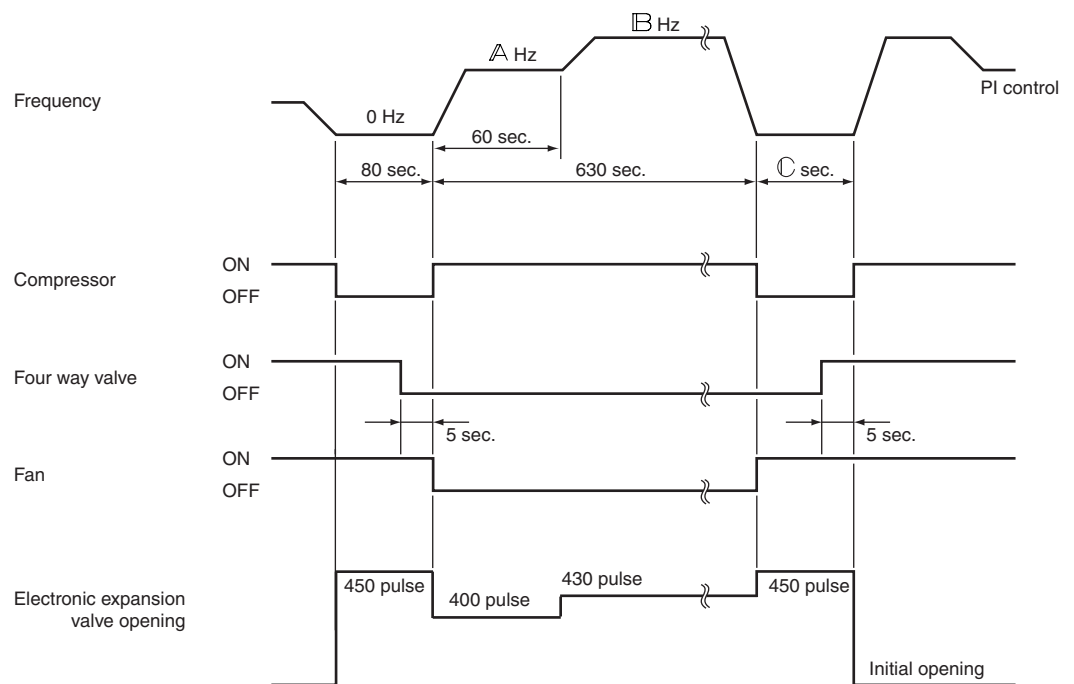

(R11947)

	A (Hz)	B (Hz)	C (seconds)
20/25 class	68	80	100
35 class	72	84	70

3.11 Electronic Expansion Valve Control

Outline

The following items are included in the electronic expansion valve control.

Electronic expansion valve is fully closed

1. Electronic expansion valve is fully closed when turning on the power.
2. Pressure equalizing control

Open Control

1. Electronic expansion valve control when starting operation
2. Electronic expansion valve control when frequency changed
3. Electronic expansion valve control for defrosting
4. Electronic expansion valve control when the discharge pipe temperature is abnormally high
5. Electronic expansion valve control when the discharge pipe thermistor is disconnected

Feedback Control

1. Discharge pipe temperature control

Detail

The followings are the examples of control which function in each mode by the electronic expansion valve control.

Operation pattern		Control when frequency changed	Control for abnormally high discharge pipe temperature
	○ : function × : not function		
When power is turned ON	Fully closed when power is turned ON	×	×
Cooling operation	Open control when starting	×	○
	(Control of target discharge pipe temperature)	○	○
Stop	Pressure equalizing control	×	×
Heating operation	Open control when starting	×	○
	(Control of target discharge pipe temperature)	○	○
	(Defrost control)	×	×
Stop	Pressure equalizing control	×	×
Heating operation	Open control when starting	×	○
Control of discharge pipe thermistor disconnection	Continue	×	×
Stop	Pressure equalizing control	×	×

(R2833)

3.11.1 Fully Closing with Power ON

The electronic expansion valve is initialized when turning on the power. The opening position is set and the pressure equalization is developed.

3.11.2 Pressure Equalization Control

When the compressor is stopped, the pressure equalization control is activated. The electronic expansion valve opens, and develops the pressure equalization.

3.11.3 Opening Limit

Outline

A maximum and minimum opening of the electronic expansion valve are limited.

Detail

- A maximum electronic expansion valve opening : 470 pulse
 - A minimum electronic expansion valve opening : 52 pulse
- The electronic expansion valve is fully closed when cooling is stopped and is opened with fixed opening during defrosting.

3.11.4 Starting Operation Control

The electronic expansion valve opening is controlled when the operation starts, and prevents the superheating or liquid compression.

3.11.5 High Discharge Pipe Temperature

When the compressor is operating, if the discharge pipe temperature exceeds a certain value, the electronic expansion valve opens and the refrigerant runs to the low pressure side. This procedure lowers the discharge pipe temperature.

3.11.6 Disconnection of the Discharge Pipe Thermistor

Outline

The disconnection of the discharge pipe thermistor is detected by comparing the discharge pipe temperature with the condensation temperature. If the discharge pipe thermistor is disconnected, the electronic expansion valve opens according to the outdoor temperature and the operation frequency, and operates for a specified time, and then stops. After 3 minutes of waiting, the operation restarts and checks if the discharge pipe thermistor is disconnected. If the discharge pipe thermistor is disconnected, the system stops after operating for a specified time. If the disconnection is detected 5 times in succession, then the system is shut down. When the compressor runs for 60 minutes without any error, the error counter is reset.

Detail

Detect Disconnection

When the starting control (cooling : 10 seconds, heating : 120 seconds) finishes, the detection timer for disconnection of the discharge pipe thermistor (720 seconds) starts. When the timer is over, the following adjustment is made.

1. When the operation mode is cooling
 - When the following condition is fulfilled, the discharge pipe thermistor disconnection is ascertained.
 - Discharge pipe temperature + 6°C < outdoor heat exchanger temperature
2. When the operation mode is heating
 - When the following condition is fulfilled, the discharge pipe thermistor disconnection is ascertained.
 - Discharge pipe temperature + 6°C < indoor heat exchanger temperature

Adjustment when the thermistor is disconnected

When the disconnection is ascertained and the 9-minute timer for the compressor operation continuation is over, the compressor stops.

When compressor stops repeatedly, the system is shut down.

3.11.7 Control when frequency is changed

When the target discharge pipe temperature control is active, if the target frequency is changed for a specified value in a certain time period, the target discharge pipe temperature control is canceled and the target opening of the electronic expansion valve is changed according to the shift.

3.11.8 Target Discharge Pipe Temperature Control

The target discharge pipe temperature is obtained from the indoor and outdoor heat exchanger temperature, and the electronic expansion valve opening is adjusted so that the actual discharge pipe temperature becomes close to the target discharge pipe temperature. (Indirect SH (superheating) control using the discharge pipe temperature)

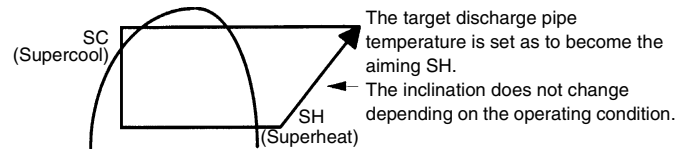

(R10626)

The electronic expansion valve opening and the target discharge pipe temperature are adjusted every 20 seconds. The target discharge pipe temperature is controlled by indoor heat exchanger temperature and outdoor heat exchanger temperature. The opening degree of the electronic expansion valve is controlled by followings.

- ◆ Target discharge pipe temperature
- ◆ Actual discharge pipe temperature
- ◆ Previous discharge pipe temperature

3.12 Malfunctions

3.12.1 Sensor Malfunction Detection

Sensor malfunction may occur in the thermistor.

Relating to Thermistor Malfunction

1. Outdoor heat exchanger thermistor
2. Discharge pipe thermistor
3. Radiation fin thermistor
4. Outdoor temperature thermistor

3.12.2 Detection of Overcurrent and Overload

Outline

An excessive output current is detected and, the OL temperature is observed to protect the compressor.

Detail

- If the OL (compressor head) temperature exceeds 120°C (depending on the model), the system shuts down the compressor.
- If the inverter current exceeds 14 A, the system shuts down the compressor.

3.12.3 Refrigerant Shortage Control

Outline

I Detecting by power consumption

If the power consumption is below the specified value and the frequency is higher than the specified frequency, it is regarded as refrigerant shortage.

The power consumption is small comparing with that in the normal operation when refrigerant is insufficient, and refrigerant shortage is detected by checking a power consumption.

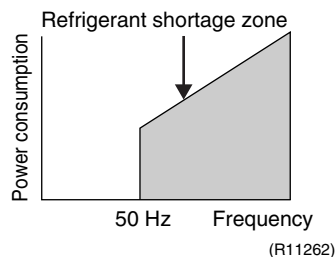

II Detecting by discharge pipe temperature

If the discharge pipe temperature is higher than the target discharge pipe temperature, and the electronic expansion valve is fully open for more than the specified time, it is regarded as refrigerant shortage.

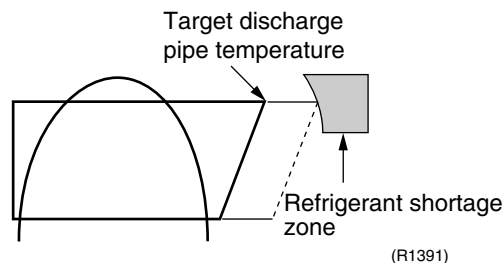

Refer to "Refrigerant shortage" on page 87 for detail.

3.13 Forced Operation Mode

Outline Forced operation mode includes only forced cooling.

Detail

Item	Forced Cooling
Conditions	1) The outdoor unit is not abnormal and not in the 3-minute standby mode.
	2) The outdoor unit is not operating.
	The forced operation is allowed when the above both conditions are met.
Start	Press the forced operation ON/OFF button (SW1) on the indoor unit for 5 seconds.
Command frequency	58 Hz
End	1) Press the forced operation ON/OFF button (SW1) on the indoor unit again.
	2) Press the ON/OFF button on the remote controller.
	3) The operation ends automatically after 15 minutes.
Others	The protection functions are prior to all others in the forced operation.

Part 5

Operation Manual

1. System Configuration.....	41
2. Operation Manual.....	42
2.1 Remote Controller	42
2.2 AUTO · DRY · COOL · HEAT · FAN Operation	43
2.3 Adjusting the Airflow Direction.....	45
2.4 POWERFUL Operation	47
2.5 ECONO Operation	48
2.6 TIMER Operation	49

1. System Configuration

After the installation and test operation of the room air conditioner have been completed, it should be operated and handled as described below. Every user would like to know the correct method of operation of the room air conditioner, to check if it is capable of cooling (or heating) well, and to know a clever method of using it.

In order to meet this expectation of the users, giving sufficient explanations taking enough time can be said to reduce about 80% of the requests for servicing. However good the installation work is and however good the functions are, the customer may blame either the room air conditioner or its installation work because of improper handling. The installation work and handing over of the unit can only be considered to have been completed when its handling has been explained to the user without using technical terms but giving full knowledge of the equipment.

2. Operation Manual

Illustrations are for FTX models as representative.

2.1 Remote Controller

■ Remote Controller

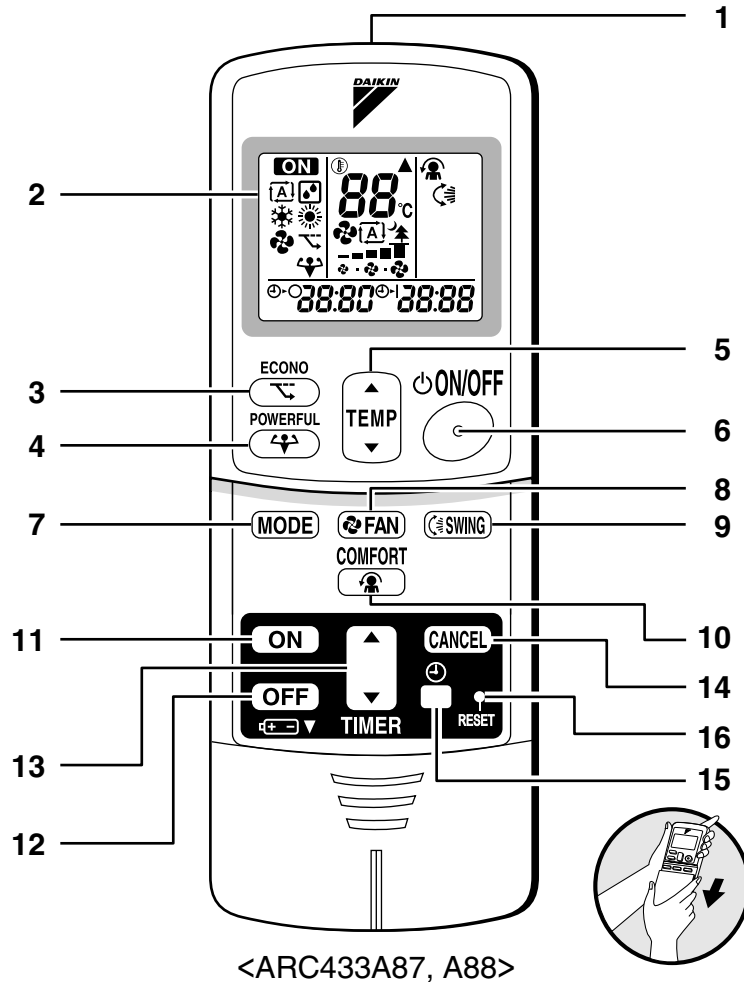

<ARC433A87, A88>

- | | |
|---|---|
| <p>1. Signal transmitter:</p> <ul style="list-style-type: none"> • It sends signals to the indoor unit. <p>2. Display:</p> <ul style="list-style-type: none"> • It displays the current settings.
(In this illustration, each section is shown with all its displays ON for the purpose of explanation.) <p>3. ECONO button:
ECONO operation (page 15.)</p> <p>4. POWERFUL button:
POWERFUL operation (page 14.)</p> <p>5. TEMPERATURE adjustment buttons:</p> <ul style="list-style-type: none"> • It changes the temperature setting. <p>6. ON/OFF button:</p> <ul style="list-style-type: none"> • Press this button once to start operation.
Press once again to stop it. <p>7. MODE selector button:</p> <ul style="list-style-type: none"> • It selects the operation mode.
(AUTO/DRY/COOL/HEAT/FAN) (page 10.) | <p>8. FAN setting button:</p> <ul style="list-style-type: none"> • It selects the airflow rate setting. <p>9. SWING button:</p> <ul style="list-style-type: none"> • Adjusting the Airflow Direction. (page 12.) <p>10. COMFORT AIRFLOW button: COMFORT AIRFLOW operation (page 13.)</p> <p>11. ON TIMER button: (page 17.)</p> <p>12. OFF TIMER button: (page 16.)</p> <p>13. TIMER Setting button:</p> <ul style="list-style-type: none"> • It changes the time setting. <p>14. TIMER CANCEL button:</p> <ul style="list-style-type: none"> • It cancels the timer setting. <p>15. CLOCK button</p> <p>16. RESET button:</p> <ul style="list-style-type: none"> • Restart the unit if it freezes. • Use a thin object to push. |
|---|---|

2.2 AUTO · DRY · COOL · HEAT · FAN Operation

AUTO · DRY · COOL · HEAT · FAN Operation

The air conditioner operates with the operation mode of your choice.

From the next time on, the air conditioner will operate with the same operation mode.

■ To start operation

1. Press “MODE selector button” and select a operation mode.

- Each pressing of the button advances the mode setting in sequence.

: AUTO

: DRY

: COOL

: HEAT

: FAN

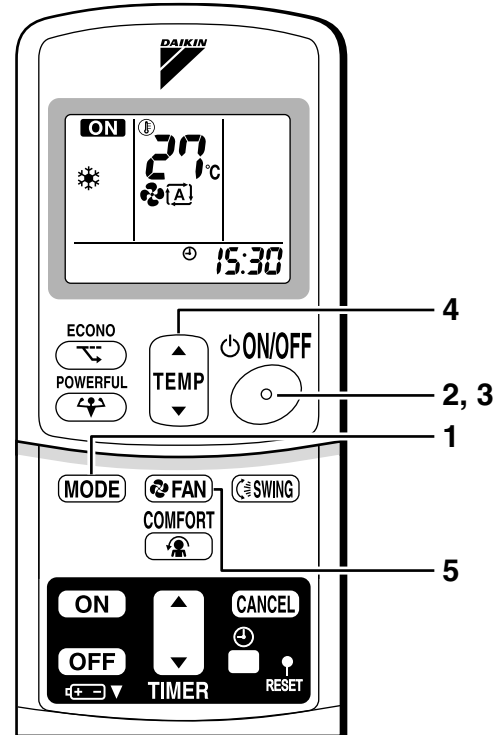
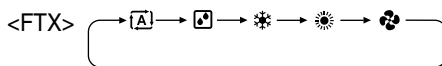
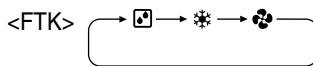

2. Press “ON/OFF button” .

- The OPERATION lamp lights up.



■ To stop operation

3. Press “ON/OFF button” again.

- Then OPERATION lamp goes off.





■ To change the temperature setting

4. Press “TEMPERATURE adjustment button”.

DRY or FAN mode	AUTO or COOL or HEAT mode
The temperature setting is not variable.	Press “▲” to raise the temperature and press “▼” to lower the temperature.
	Set to the temperature you like. 

■ To change the airflow rate setting

5. Press “FAN setting button”.

DRY mode	AUTO or COOL or HEAT or FAN mode
The airflow rate setting is not variable.	<p>Five levels of airflow rate setting from “” to “” plus “” “” are available.</p> 

- Indoor unit quiet operation

When the airflow is set to “”, the noise from the indoor unit will become quieter. Use this when making the noise quieter.

The unit might lose capacity when the airflow rate is set to a weak level.

NOTE

■ Note on HEAT operation

- Since this air conditioner heats the room by taking heat from outdoor air to indoors, the heating capacity becomes smaller in lower outdoor temperatures. If the heating effect is insufficient, it is recommended to use another heating appliance in combination with the air conditioner.
- The heat pump system heats the room by circulating hot air around all parts of the room. After the start of heating operation, it takes some time before the room gets warmer.
- In heating operation, frost may occur on the outdoor unit and lower the heating capacity. In that case, the system switches into defrosting operation to take away the frost.
- During defrosting operation, hot air does not flow out of indoor unit.

■ Note on COOL operation

- This air conditioner cools the room by blowing the hot air in the room outside, so if the outside temperature is high, the performance of the air conditioner drops.

■ Note on DRY operation

- The computer chip works to rid the room of humidity while maintaining the temperature as much as possible. It automatically controls temperature and airflow rate, so manual adjustment of these functions is unavailable.

■ Note on AUTO operation

- In AUTO operation, the system selects an appropriate operation mode (COOL or HEAT) based on the room temperature at the start of the operation.
- The system automatically reselects setting at a regular interval to bring the room temperature to user-setting level.
- If you do not like AUTO operation, manually change the set temperature.

■ Note on airflow rate setting

- At smaller airflow rates, the cooling (heating) effect is also smaller.

2.3 Adjusting the Airflow Direction

Adjusting the Airflow Direction

You can adjust the airflow direction to increase your comfort.

■ To adjust the horizontal blades (flaps)

1. Press “SWING button”.

- “” is displayed on the LCD and the flaps will begin to swing.

2. When the flaps have reached the desired position, press “SWING button” once more.

- The flap will stop moving.
- “” disappears from the LCD.

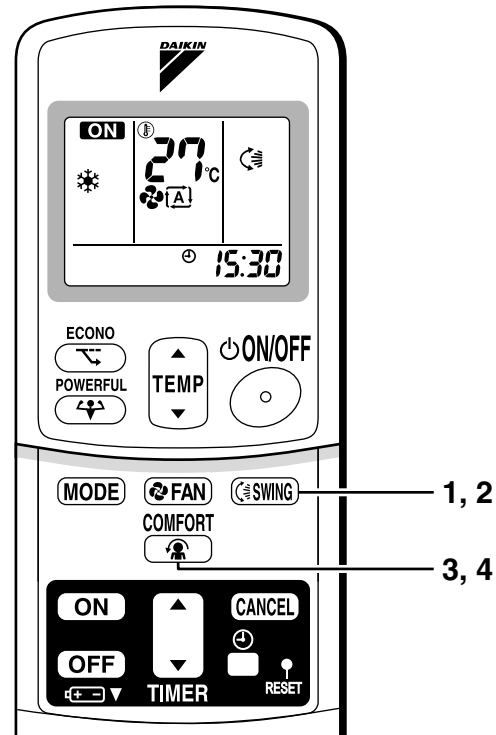

■ To adjust the vertical blades (louvers)

Hold the knob and move the louvers.

(You will find a knob on the left-side and the right-side blades.)

- When the unit is installed in the corner of a room, the direction of the louvers should be facing away from the wall. If they face the wall, the wall will block off the wind, causing the cooling (or heating) efficiency to drop.

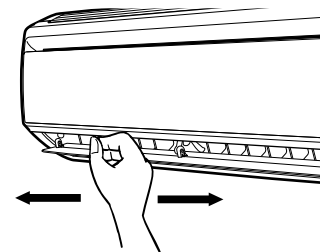

■ To start COMFORT AIRFLOW operation

3. Press “COMFORT AIRFLOW button”.

- The flap position will change, preventing air from blowing directly on the occupants of the room.
- “” is displayed on the LCD.
- Airflow rate is set to “AUTO”.

〈COOL/DRY〉 The flap will go up.

〈HEAT〉 The flap will go down.

■ To cancel COMFORT AIRFLOW operation

4. Press “COMFORT AIRFLOW button” again.

- The flaps will return to the memory position from before COMFORT AIRFLOW mode.
- “” disappears from the LCD.

Notes on COMFORT AIRFLOW operation

- POWERFUL operation and COMFORT AIRFLOW operation cannot be used at the same time. Priority is given to POWERFUL operation.

Notes on flaps and louvers angles

- When “SWING button” is selected, the flaps swinging range depends on the operation mode. (See the figure.)

■ ATTENTION

- Always use a remote controller to adjust the flaps angle. If you attempt to move it forcibly with hand when it is swinging, the mechanism may be broken.
- Be careful when adjusting the louvers. Inside the air outlet, a fan is rotating at a high speed.
- If the air conditioner is operated in cooling or dry mode with the flap kept stopped in the downward direction, the flap will automatically start operating in approximately an hour in order to prevent dew condensation.

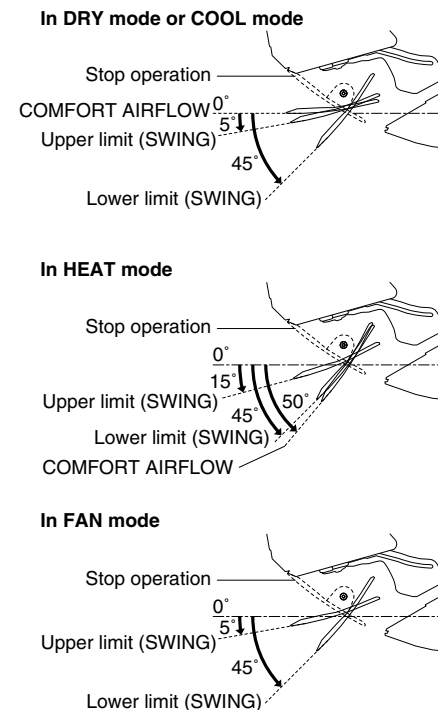

2.4 POWERFUL Operation

POWERFUL Operation

POWERFUL operation quickly maximizes the cooling (heating) effect in any operation mode. You can get the maximum capacity .

■ To start POWERFUL operation

1. Press “POWERFUL button”.

- POWERFUL operation ends in 20minutes. Then the system automatically operates again with the previous settings which were used before POWERFUL operation.
- “” is displayed on the LCD.
- When using POWERFUL operation, there are some functions which are not available.

■ To cancel POWERFUL operation

2. Press “POWERFUL button” again.

- “” disappears from the LCD.

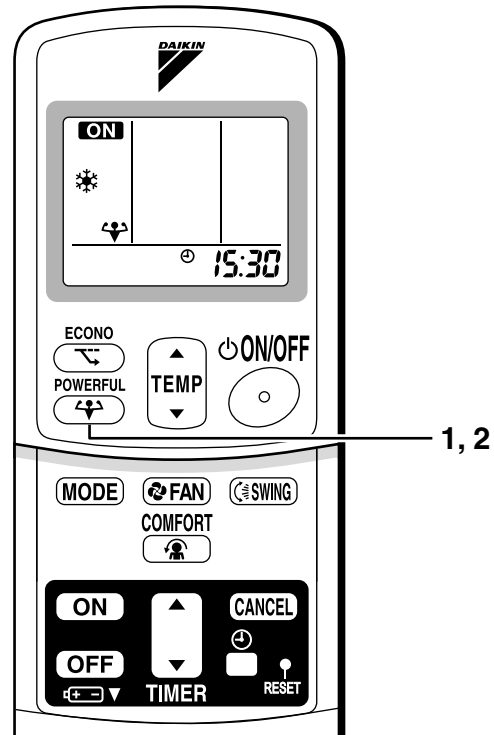

NOTE

■ Notes on POWERFUL operation

- POWERFUL Operation cannot be used together with ECONO or COMFORT AIRFLOW Operation. Priority is given to the function of whichever button is pressed last.
- POWERFUL Operation can only be set when the unit is running. Pressing the operation stop button causes the settings to be canceled, and the “” disappears from the LCD.
- **In COOL and HEAT mode**
To maximize the cooling (heating) effect, the capacity of outdoor unit must be increased and the airflow rate be fixed to the maximum setting.
The temperature and airflow settings are not variable.
- **In DRY mode**
The temperature setting is lowered by 2.5°C and the airflow rate is slightly increased.
- **In FAN mode**
The airflow rate is fixed to the maximum setting.

2.5 ECONO Operation

ECONO Operation

ECONO operation is a function which enables efficient operation by lowering the maximum power consumption value.

■ To start ECONO operation

1. Press “ECONO button” .

- “” is displayed on the LCD.

■ To cancel ECONO operation

2. Press “ECONO button” again.

- “” disappears from the LCD.

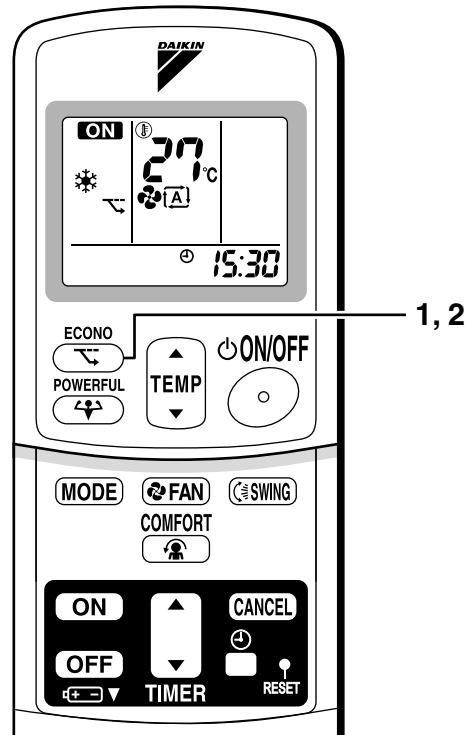

NOTE

- ECONO Operation can only be set when the unit is running. Pressing the operation stop button causes the settings to be canceled, and the “” disappears from the LCD.
- ECONO operation is a function which enables efficient operation by limiting the power consumption of the outdoor unit (operating frequency).
- ECONO operation functions in AUTO, COOL, DRY, and HEAT modes.
- POWERFUL operation and ECONO operation cannot be used at the same time. Priority is given to the function of whichever button is pressed last.
- Power consumption may not drop even if ECONO operation is used, when the level of power consumption is already low.

2.6 TIMER Operation

TIMER Operation

Timer functions are useful for automatically switching the air conditioner on or off at night or in the morning. You can also use OFF TIMER and ON TIMER in combination.

■ To use OFF TIMER operation

- Check that the clock is correct.
If not, set the clock to the present time.

1. Press “OFF TIMER button”.

0:00 is displayed.

⊕-⊖ blinks.

2. Press “TIMER Setting button” until the time setting reaches the point you like.

- Every pressing of either button increases or decreases the time setting by 10 minutes.
Holding down either button changes the setting rapidly.

3. Press “OFF TIMER button” again.

- The TIMER lamp lights up.

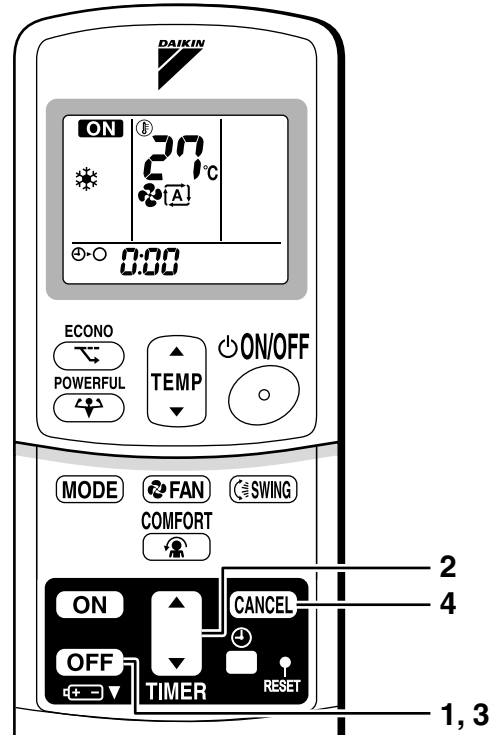
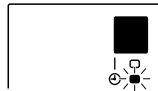

■ To cancel the OFF TIMER operation

4. Press “CANCEL button”.

- The TIMER lamp goes off.

NOTE

- When TIMER is set, the present time is not displayed.
- Once you set ON, OFF TIMER, the time setting is kept in the memory. (The memory is canceled when remote controller batteries are replaced.)
- When operating the unit via the ON/OFF Timer, the actual length of operation may vary from the time entered by the user.

■ NIGHT SET MODE

When the OFF TIMER is set, the air conditioner automatically adjusts the temperature setting (0.5°C up in COOL, 2.0°C down in HEAT) to prevent excessive cooling (heating) for your pleasant sleep.

■ To use ON TIMER operation

- Check that the clock is correct. If not, set the clock to the present time.

1. Press “ON TIMER button”.

6:00 is displayed.

⊕-| blinks.

2. Press “TIMER Setting button” until the time setting reaches the point you like.

- Every pressing of either button increases or decreases the time setting by 10 minutes. Holding down either button changes the setting rapidly.

3. Press “ON TIMER button” again.

- The TIMER lamp lights up.

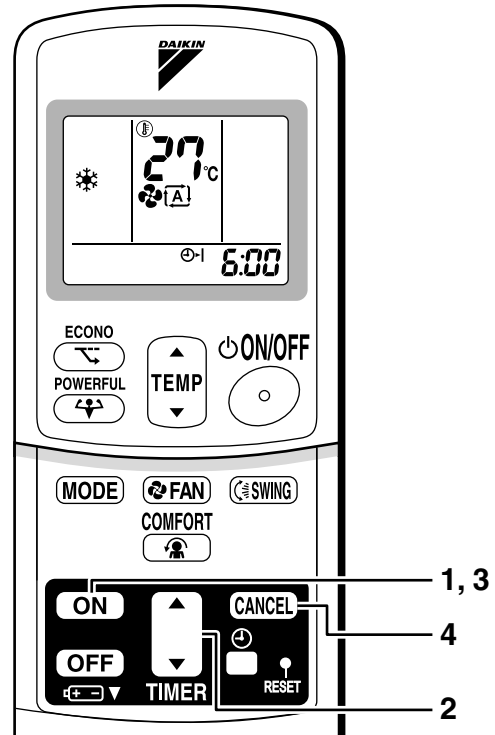
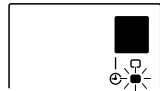

■ To cancel ON TIMER operation

4. Press “CANCEL button”.

- The TIMER lamp goes off.

■ To combine ON TIMER and OFF TIMER

- A sample setting for combining the two timers is shown below.

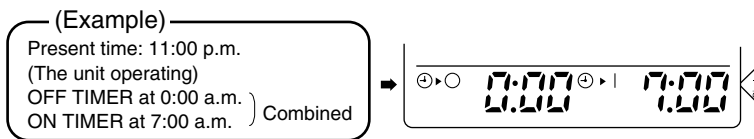

ATTENTION

- In the following cases, set the timer again.
 - After a breaker has turned OFF.
 - After a power failure.
 - After replacing batteries in the remote controller.

Part 6

Service Diagnosis

1. Caution for Diagnosis.....	52
1.1 Troubleshooting with LED	52
2. Problem Symptoms and Measures	53
3. Service Check Function	54
4. Troubleshooting	57
4.1 Error Codes and Description	57
4.2 Indoor Unit PCB Abnormality	58
4.3 Freeze-up Protection Control or Heating Peak-cut Control.....	59
4.4 Fan Motor (DC Motor) or Related Abnormality.....	61
4.5 Thermistor or Related Abnormality (Indoor Unit).....	63
4.6 Signal Transmission Error (between Indoor and Outdoor Unit)	64
4.7 Unspecified Voltage (between Indoor and Outdoor Unit).....	65
4.8 Outdoor Unit PCB Abnormality.....	66
4.9 OL Activation (Compressor Overload)	67
4.10 Compressor Lock	68
4.11 DC Fan Lock	69
4.12 Input Overcurrent Detection	70
4.13 Four Way Valve Abnormality	71
4.14 Discharge Pipe Temperature Control.....	73
4.15 High Pressure Control in Cooling	74
4.16 Compressor System Sensor Abnormality	75
4.17 Position Sensor Abnormality	76
4.18 DC Voltage / Current Sensor Abnormality.....	78
4.19 Thermistor or Related Abnormality (Outdoor Unit).....	79
4.20 Electrical Box Temperature Rise	81
4.21 Radiation Fin Temperature Rise	83
4.22 Output Overcurrent Detection	85
4.23 Refrigerant Shortage	87
4.24 Low-voltage Detection or Over-voltage Detection.....	89
5. Check.....	90
5.1 How to Check.....	90

1. Caution for Diagnosis

1.1 Troubleshooting with LED

Indoor Unit

The operation lamp blinks when any of the following errors is detected.

1. When a protection device of the indoor or outdoor unit is activated, or when the thermistor malfunctions.
 2. When a signal transmission error occurs between the indoor and outdoor units.
- In either case, conduct the diagnostic procedure described in the following pages.

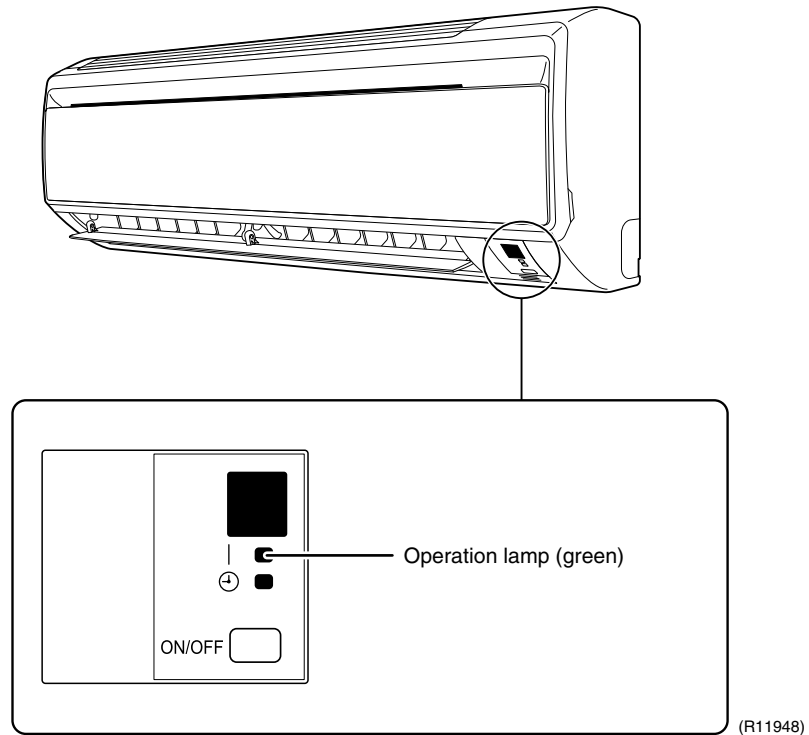

Outdoor Unit

The outdoor unit has one green LED (LED A) on the PCB. The blinking green LED indicates normal condition of microcomputer operation.

2. Problem Symptoms and Measures

Symptom	Check Item	Details of Measure	Reference Page
The units does not operate.	Check the power supply.	Check to make sure that the rated voltage is supplied.	—
	Check the type of the indoor units.	Check to make sure that the indoor unit type is compatible with the outdoor unit.	—
	Check the outdoor temperature.	Heating operation cannot be used when the outdoor temperature is 20°C or higher, and cooling operation cannot be used when the outdoor temperature is below 10°C.	—
	Diagnose with remote controller indication.	—	57
	Check the remote controller addresses.	Check to make sure that address settings for the remote controller and indoor unit are correct.	—
Operation sometimes stops.	Check the power supply.	A power failure of 2 to 10 cycles stops air conditioner operation. (Operation lamp OFF)	—
	Check the outdoor temperature.	Heating operation cannot be used when the outdoor temperature is 20°C or higher, and cooling operation cannot be used when the outdoor temperature is below 10°C.	—
	Diagnose with remote controller indication.	—	57
The unit operates but does not cool, or does not heat.	Check for wiring and piping errors in the connection between the indoor and outdoor units.	Conduct the wiring/piping error check described on the product diagnosis label.	—
	Check for thermistor detection errors.	Check to make sure that the thermistor is mounted securely.	—
	Check for faulty operation of the electronic expansion valve.	Set the units to cooling operation, and check the temperature of the liquid pipe to see the electronic expansion valve works.	—
	Diagnose with remote controller indication.	—	57
	Diagnose by service port pressure and operating current.	Check for refrigerant shortage.	87
Large operating noise and vibrations	Check the output voltage of the power module.	—	95
	Check the power module.	—	—
	Check the installation condition.	Check to make sure that the required spaces for installation (specified in the installation manual, etc.) are provided.	—

3. Service Check Function

Check Method 1

1. When the timer cancel button is held down for 5 seconds, “00” indication appears on the temperature display section.

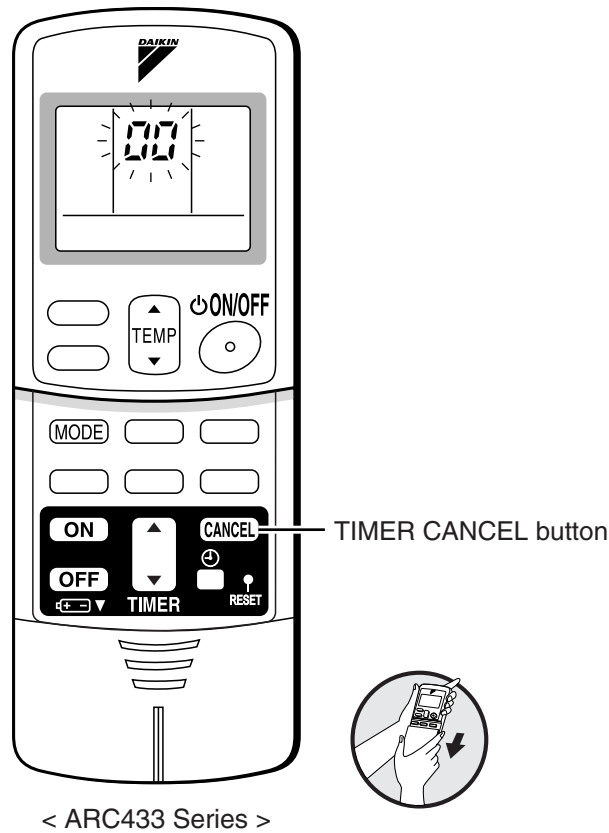

(R11949)

2. Press the timer cancel button repeatedly until a long beep sounds.

■ The code indication changes in the sequence shown below.

No.	Code	No.	Code	No.	Code
1	00	12	F6	23	R1
2	U4	13	C7	24	E1
3	L5	14	R3	25	UR
4	E6	15	H8	26	UH
5	H6	16	H9	27	P4
6	H0	17	C9	28	L3
7	R6	18	C4	29	L4
8	E7	19	C5	30	H7
9	U0	20	J3	31	U2
10	F3	21	J6	32	ER
11	R5	22	E5	33	RH



Note:

1. A short beep “pi” and two consecutive beeps “pi pi” indicate non-corresponding codes.
2. To return to the normal mode, hold the timer cancel button down for 5 seconds. When the remote controller is left untouched for 60 seconds, it also returns to the normal mode.

Check Method 2

1. Press the center of the TEMP button and the MODE button at the same time.

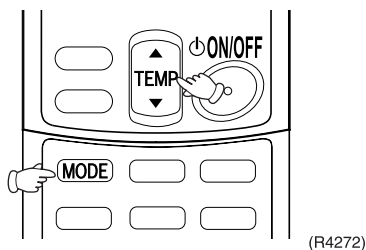

The figure of the ten's place blinks.

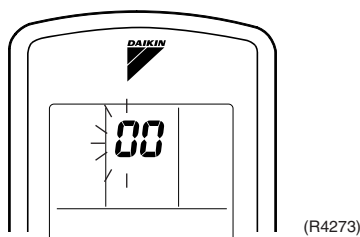

2. Press the TEMP▲ or ▼ button and change the figure until you hear the sound of “beep” or “pi pi”.

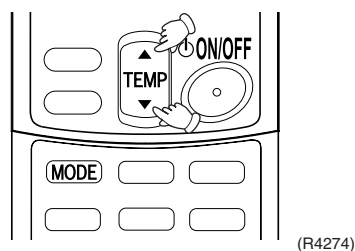

3. Diagnose by the sound.
 - ★“pi” : The figure of the ten's place does not accord with the error code.
 - ★“pi pi” : The figure of the ten's place accords with the error code but the one's not.
 - ★“beep” : The both figures of the ten's and one's place accord with the error code.
 (→See 7.)

4. Press the MODE button.

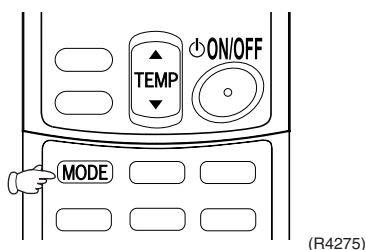

The figure of the one's place blinks.

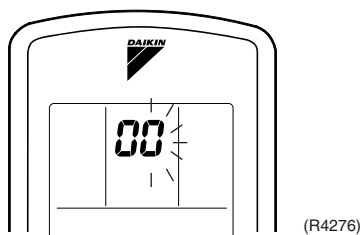

5. Press the TEMP▲ or ▼ button and change the figure until you hear the sound of “beep”.

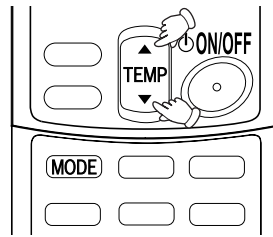

(R4277)

6. Diagnose by the sound.
- ★“pi” : The figure of the ten’s place does not accord with the error code.
 - ★“pi pi” : The figure of the ten’s place accords with the error code but the one’s not.
 - ★“beep” : The both figures of the ten’s and one’s place accord with the error code.

7. Determine the error code.

The figures indicated when you hear the “beep” sound are error code.
(Error codes and description → Refer to page 57.)

8. Press the MODE button to exit from the diagnosis mode.

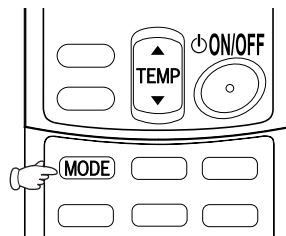

(R4278)

The display “ 7 - ” means the trial operation mode.
(Refer to page 139 for trial operation.)

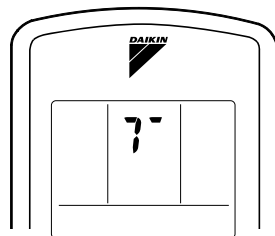

(R9669)

9. Press the ON/OFF button twice to return to the normal mode.

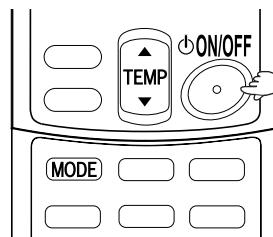

(R9670)



Note: When the remote controller is left untouched for 60 seconds, it returns to the normal mode.

4. Troubleshooting

4.1 Error Codes and Description

	Error Codes	Description	Reference Page
System	00	Normal	—
	U0★	Refrigerant shortage	87
	U2	Low-voltage detection or over-voltage detection	89
	U4	Signal transmission error (between indoor and outdoor unit)	64
	U8	Unspecified voltage (between indoor and outdoor unit)	65
Indoor Unit	P1	Indoor unit PCB abnormality	58
	P5	Freeze-up protection control or heating peak-cut control	59
	P6	Fan motor (DC motor) or related abnormality	61
	C4	Indoor heat exchanger thermistor or related abnormality	63
	C9	Room temperature thermistor or related abnormality	63
Outdoor Unit	E1	Outdoor unit PCB abnormality	66
	E5★	OL activation (compressor overload)	67
	E6★	Compressor lock	68
	E7	DC fan lock	69
	E8	Input overcurrent detection	70
	E9	Four way valve abnormality	71
	F3	Discharge pipe temperature control	73
	F6	High pressure control in cooling	74
	H0	Compressor system sensor abnormality	75
	H6	Position sensor abnormality	76
	H8	DC voltage / current sensor abnormality	78
	H9	Outdoor temperature thermistor or related abnormality	79
	J3	Discharge pipe thermistor or related abnormality	79
	J6	Outdoor heat exchanger thermistor or related abnormality	79
	L3	Electrical box temperature rise	81
	L4	Radiation fin temperature rise	83
	L5	Output overcurrent detection	85
	P4	Radiation fin thermistor or related abnormality	79

★: Displayed only when system-down occurs.

4.2 Indoor Unit PCB Abnormality

Remote Controller Display	R1
Method of Malfunction Detection	The system checks if the circuit works properly within the microcomputer of the indoor unit.
Malfunction Decision Conditions	The system cannot set the internal settings.
Supposed Causes	<ul style="list-style-type: none"> ■ Wrong models interconnected ■ Defective indoor unit PCB ■ Disconnection of connector

Troubleshooting

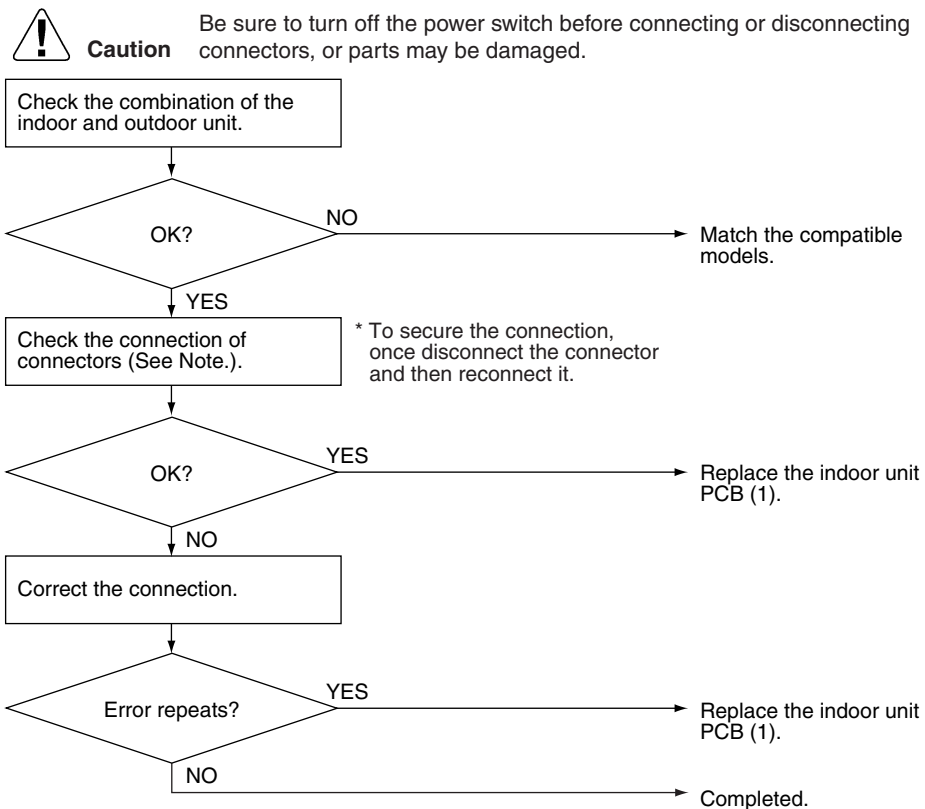

(R11704)

 **Note:** Check the following connector.

Model Type	Connector
Wall Mounted Type	Terminal board ~ Control PCB

4.3 Freeze-up Protection Control or Heating Peak-cut Control

Remote
Controller
Display

85

Method of
Malfunction
Detection

- Freeze-up protection control
During cooling operation, the freeze-up protection control (operation halt) is activated according to the temperature detected by the indoor heat exchanger thermistor.
- Heating peak-cut control
During heating operation, the temperature detected by the indoor heat exchanger thermistor is used for the heating peak-cut control (operation halt, outdoor fan stop, etc.)

Malfunction
Decision
Conditions

- Freeze-up protection control
During cooling operation, the indoor heat exchanger temperature is below 0°C.
- Heating peak-cut control
During heating operation, the indoor heat exchanger temperature is above 65°C

Supposed
Causes

- Short-circuited air
- Clogged air filter of the indoor unit
- Dust accumulation on the indoor heat exchanger
- Defective indoor heat exchanger thermistor
- Defective indoor unit PCB

Troubleshooting



Check No.06
Refer to P.92



Caution

Be sure to turn off the power switch before connecting or disconnecting connectors, or parts may be damaged.

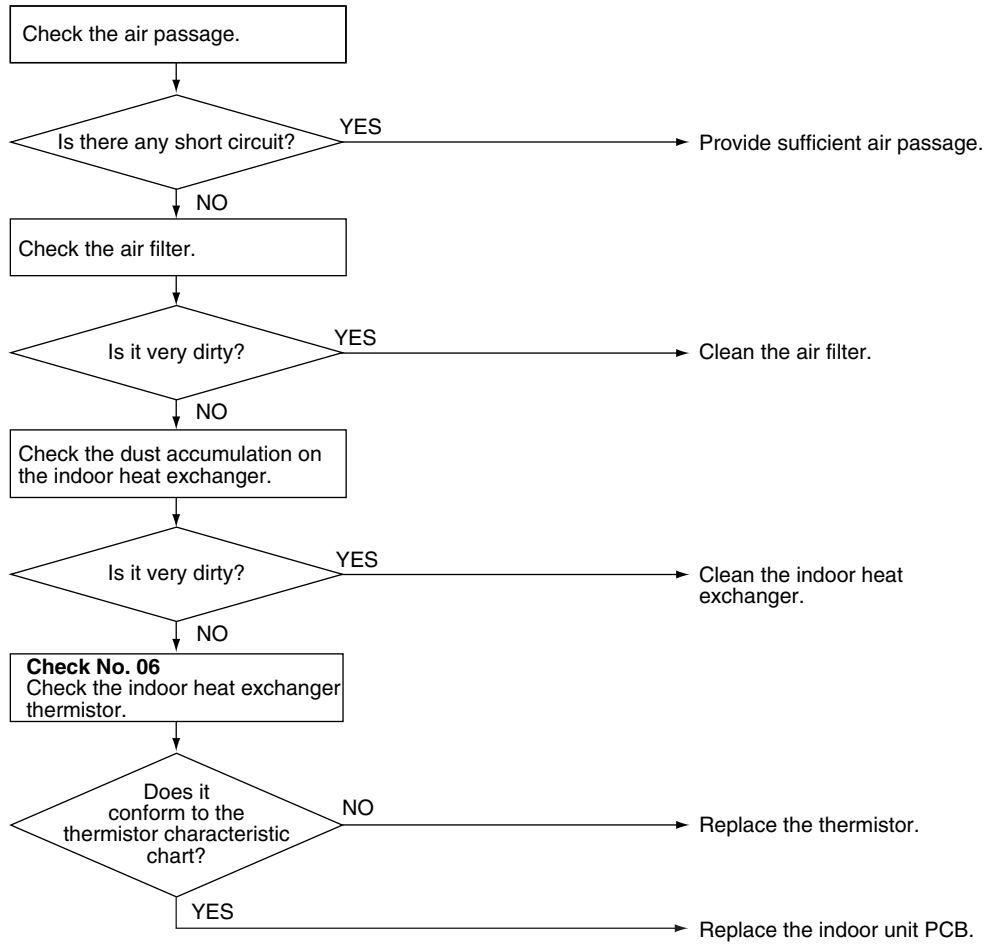

(R7131)

4.4 Fan Motor (DC Motor) or Related Abnormality

Remote Controller Display



Method of Malfunction Detection

The rotation speed detected by the Hall IC during fan motor operation is used to determine abnormal fan motor operation.

Malfunction Decision Conditions

The detected rotation speed does not reach the demanded rotation speed of the target tap, and is less than 50% of the maximum fan motor rotation speed.

Supposed Causes

- Disconnection of connector
- Foreign matters stuck in the fan
- Layer short inside the fan motor winding
- Breaking of wire inside the fan motor
- Breaking of the fan motor lead wires
- Defective capacitor of the fan motor
- Defective indoor unit PCB

Troubleshooting

Check No.18
 Refer to P.97

Check No.19
 Refer to P.97

Check No.20
 Refer to P.98

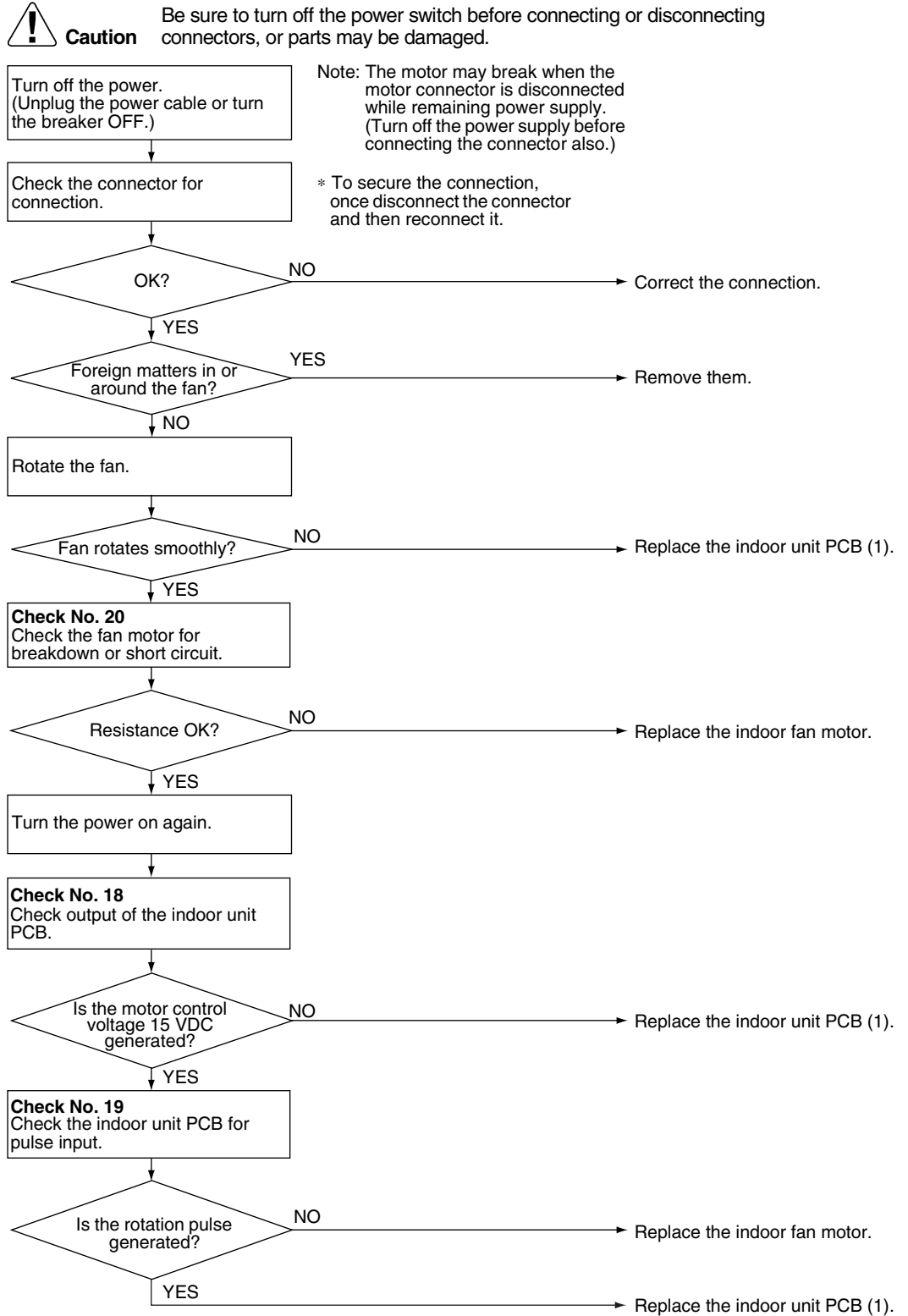

(R12038)

4.5 Thermistor or Related Abnormality (Indoor Unit)

Remote
Controller
Display

Ⓔ, Ⓕ

Method of
Malfunction
Detection

The temperatures detected by the thermistors determine thermistor errors.

Malfunction
Decision
Conditions

The thermistor input is more than 4.96 V or less than 0.04 V during compressor operation.

Supposed
Causes

- Disconnection of connector
- Defective thermistor
- Defective indoor unit PCB

Troubleshooting



Check No.06
Refer to P.92



Caution

Be sure to turn off the power switch before connecting or disconnecting connectors, or parts may be damaged.

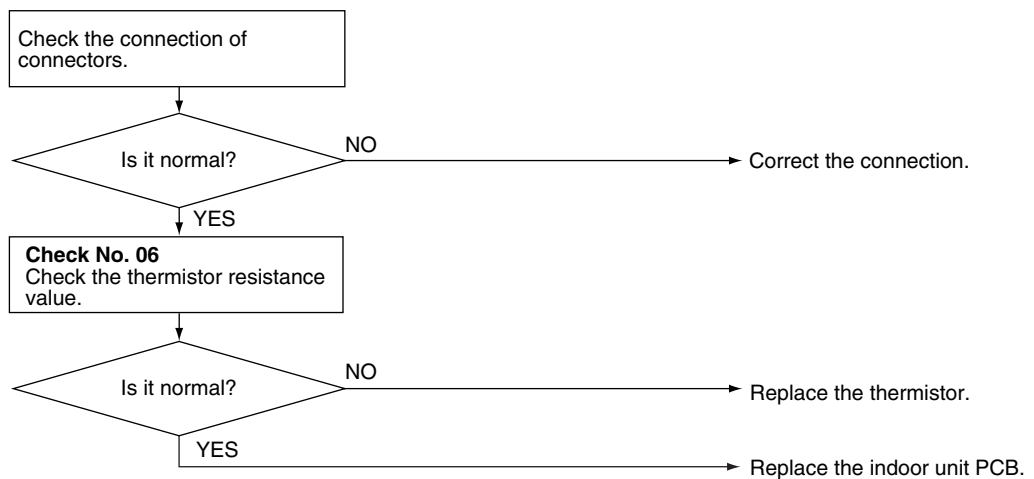

(R7134)

Ⓔ : Indoor heat exchanger thermistor
Ⓕ : Room temperature thermistor

4.6 Signal Transmission Error (between Indoor and Outdoor Unit)

Remote Controller Display



Method of Malfunction Detection

The data received from the outdoor unit in indoor unit-outdoor unit signal transmission is checked whether it is normal.

Malfunction Decision Conditions

The data sent from the outdoor unit cannot be received normally, or the content of the data is abnormal.

Supposed Causes

- Wiring error
- Breaking of the connection wires between the indoor and outdoor units (wire No. 3)
- Defective outdoor unit PCB
- Defective indoor unit PCB
- Disturbed power supply waveform

Troubleshooting

Check No.10
 Refer to P.94

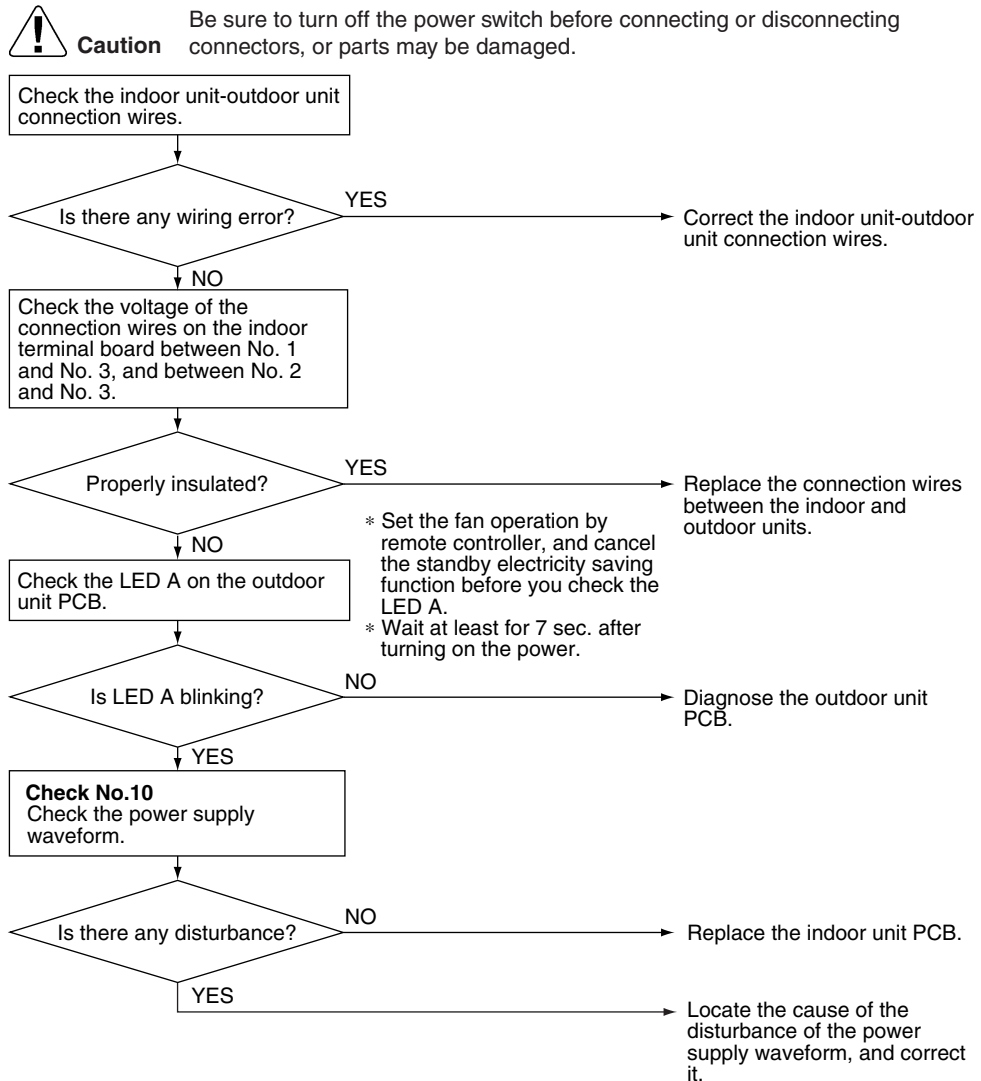

(R12023)

4.7 Unspecified Voltage (between Indoor and Outdoor Unit)

Remote
Controller
Display



Method of
Malfunction
Detection

The supply power is detected for its requirements (different from pair type and multi type) by the indoor / outdoor transmission signal.

Malfunction
Decision
Conditions

The pair type and multi type are interconnected.

Supposed
Causes

- Wrong models interconnected
- Wrong wiring of connection wires
- Wrong indoor unit PCB or outdoor unit PCB mounted
- Defective indoor unit PCB
- Defective outdoor unit PCB

Troubleshooting



Caution

Be sure to turn off the power switch before connecting or disconnecting connectors, or parts may be damaged.

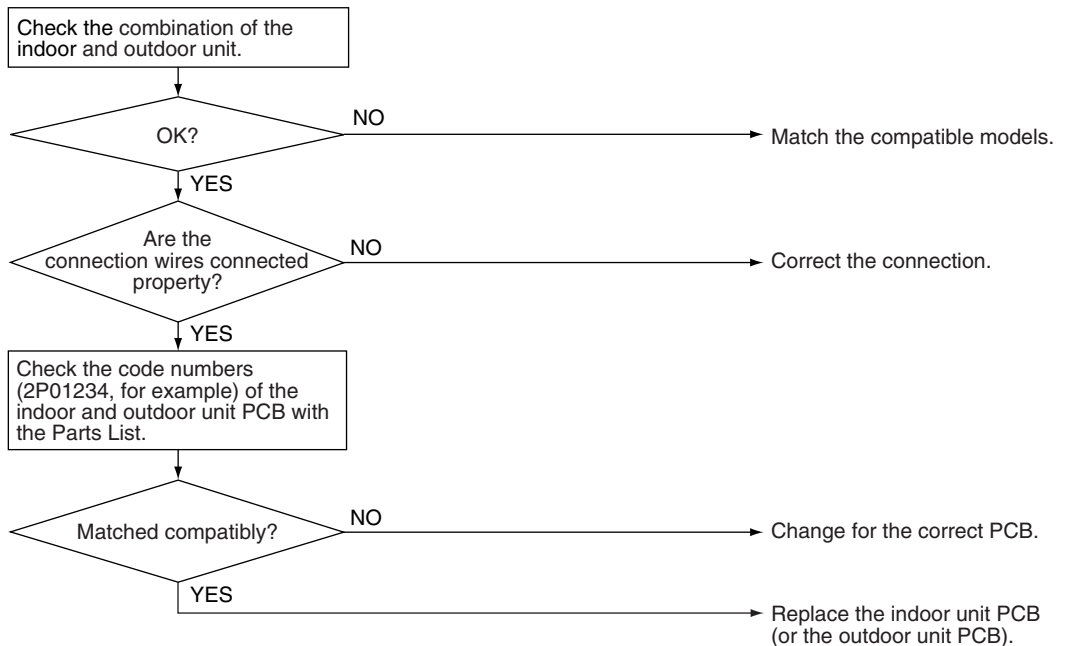

(R11707)

4.8 Outdoor Unit PCB Abnormality

Remote
Controller
Display

E1

Method of
Malfunction
Detection

- The system follows the microprocessor program as specified.
- The system checks to see if the zero-cross signal comes in properly.

Malfunction
Decision
Conditions

- The microprocessor program runs out of control.
- The zero-cross signal is not detected.

Supposed
Causes

- Defective outdoor unit PCB
- Broken harness between PCBs
- Noise
- Momentary fall of voltage
- Momentary power failure, etc

Troubleshooting

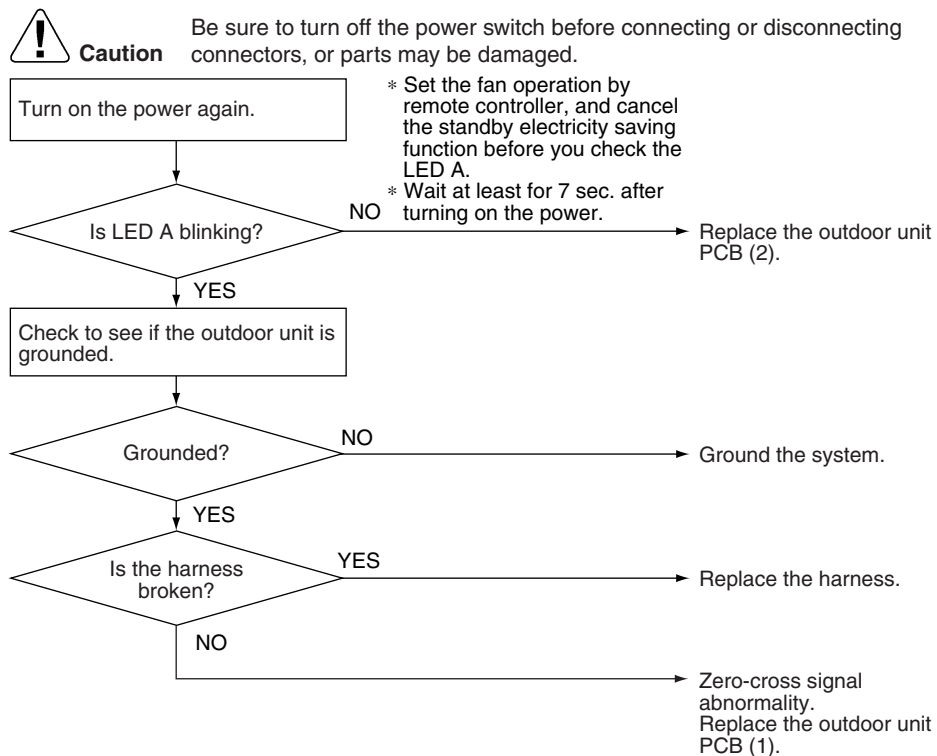





(R12024)

4.9 OL Activation (Compressor Overload)

Remote Controller Display	E5
Method of Malfunction Detection	A compressor overload is detected through compressor OL.
Malfunction Decision Conditions	<ul style="list-style-type: none"> ■ If the error repeats twice, the system is shut down. ■ Reset condition: Continuous run for about 60 minutes without any other error * The operating temperature condition is not specified.
Supposed Causes	<ul style="list-style-type: none"> ■ Defective discharge pipe thermistor ■ Defective electronic expansion valve or coil ■ Defective four way valve or coil ■ Defective outdoor unit PCB ■ Refrigerant shortage ■ Water mixed in refrigerant ■ Defective stop valve

Troubleshooting

- 
- 
- 
- 

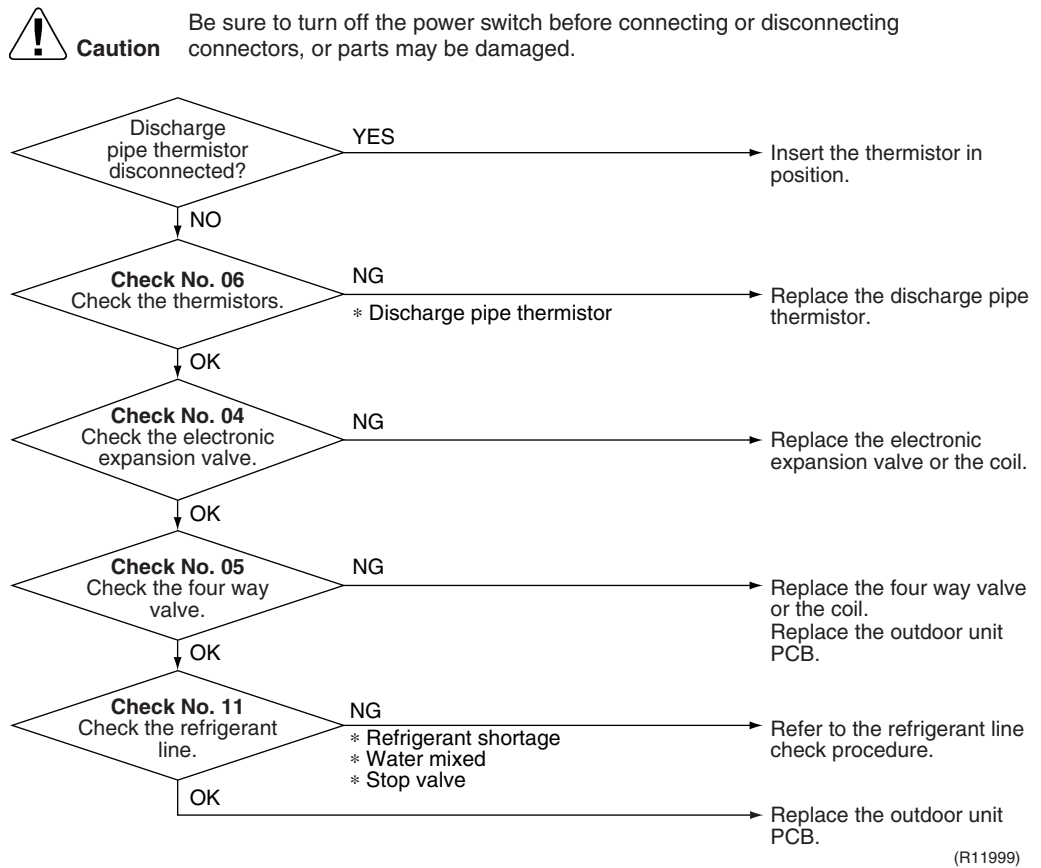

4.10 Compressor Lock

Remote
Controller
Display



Method of
Malfunction
Detection

A compressor lock is detected by checking the compressor running condition through the position detection circuit.

Malfunction
Decision
Conditions

- Operation stops due to overcurrent.
- If the error repeats 16 times, the system is shut down.
- Reset condition: Continuous run for about 11 minutes without any other error

Supposed
Causes

- Compressor locked
- Compressor harness disconnected

Troubleshooting



Caution

Be sure to turn off the power switch before connecting or disconnecting connectors, or parts may be damaged.
(Precaution before turning on the power again)
Make sure the power has been off for at least 30 seconds.

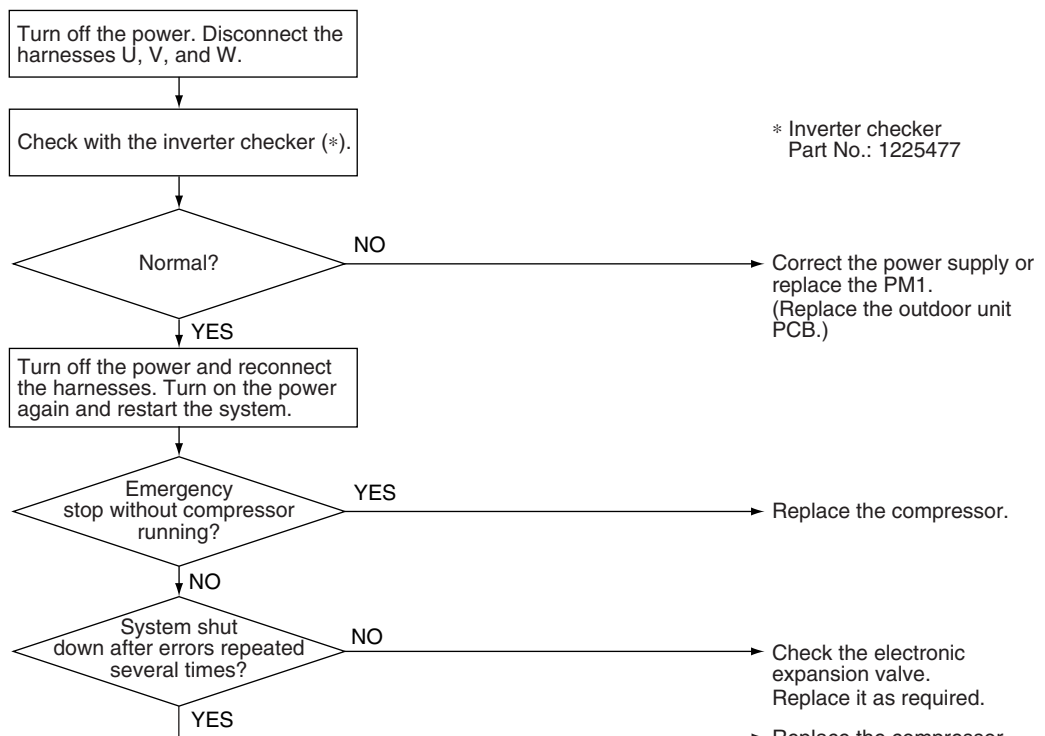

* Inverter checker
Part No.: 1225477

(R8399)

4.11 DC Fan Lock

<p>Remote Controller Display</p> 	
<p>Method of Malfunction Detection</p>	<p>An error is determined with the high-voltage fan motor rotation speed detected by the Hall IC.</p>
<p>Malfunction Decision Conditions</p>	<ul style="list-style-type: none"> ■ The fan does not start in 30 seconds even when the fan motor is running. ■ If the error repeats 16 times, the system is shut down. ■ Reset condition: Continuous run for about 11 minutes without any other error
<p>Supposed Causes</p>	<ul style="list-style-type: none"> ■ Disconnection of the fan motor ■ Foreign matters stuck in the fan ■ Defective fan motor ■ Defective outdoor unit PCB

Troubleshooting

 **Check No.15**
Refer to P.96

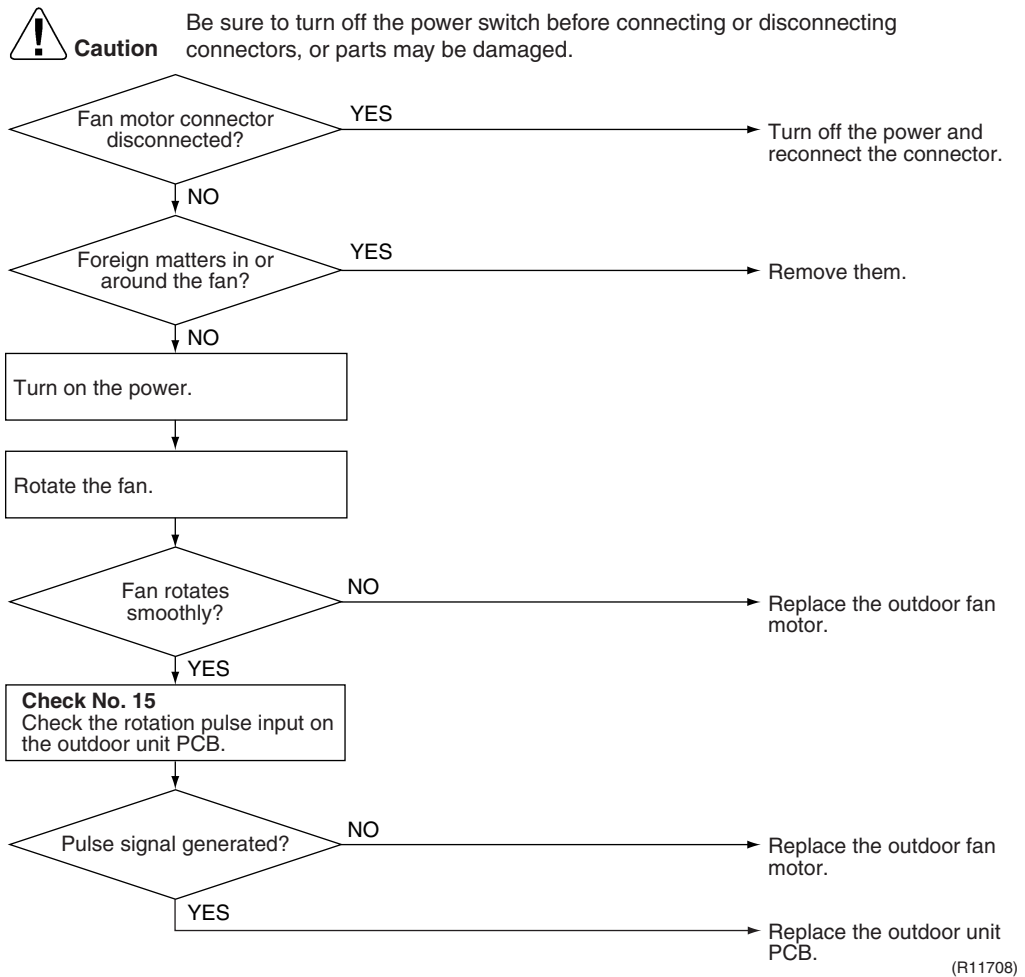

4.12 Input Overcurrent Detection

Remote
Controller
Display



Method of
Malfunction
Detection

An input overcurrent is detected by checking the input current value with the compressor running.

Malfunction
Decision
Conditions

- The following current with the compressor running continues for 2.5 seconds.
Cooling/Heating: Above 14 A

Supposed
Causes

- Defective compressor
- Defective power module
- Defective outdoor unit PCB
- Short circuit

Troubleshooting

Check No.07
Refer to P.93

Check No.08
Refer to P.93



Caution Be sure to turn off the power switch before connecting or disconnecting connectors, or parts may be damaged.

* An input overcurrent may result from wrong internal wiring. If the wires have been disconnected and reconnected for part replacement, for example, and the system is interrupted by an input overcurrent, take the following procedure.

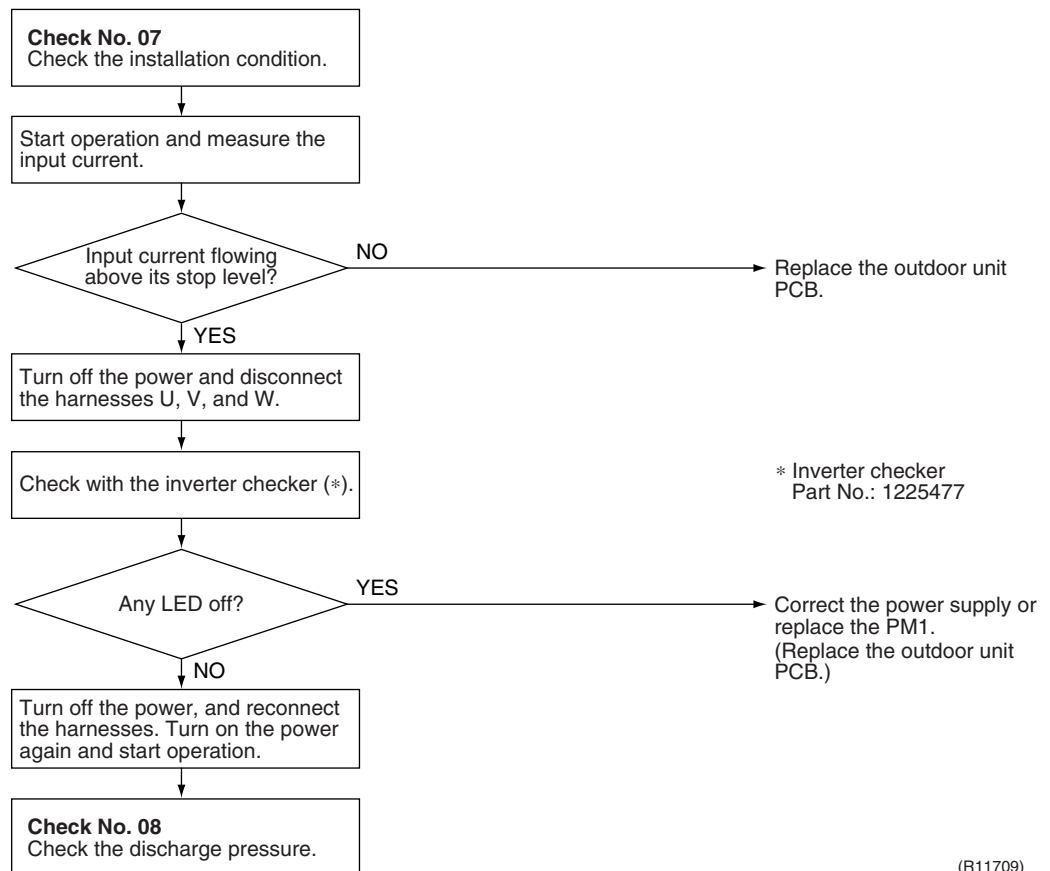

(R11709)

4.13 Four Way Valve Abnormality

Remote
Controller
Display

EA

Method of
Malfunction
Detection

The room temperature thermistor, the indoor heat exchanger thermistor, the outdoor temperature thermistor, and the outdoor heat exchanger thermistor are checked if they function within their normal ranges in each operation mode.

Malfunction
Decision
Conditions

A following condition continues over 10 minutes after operating for 5 minutes.

- Cooling / Dry
(room temp. – indoor heat exchanger temp.) < –5°C
- Heating
(indoor heat exchanger temp. – room temp.) < –5°C

Supposed
Causes

- Disconnection of four way valve coil
- Defective four way valve coil or harness
- Defective four way valve
- Defective outdoor unit PCB
- Defective thermistor
- Refrigerant shortage
- Water mixed in refrigerant
- Defective stop valve

Troubleshooting

Check No.05
 Refer to P.91

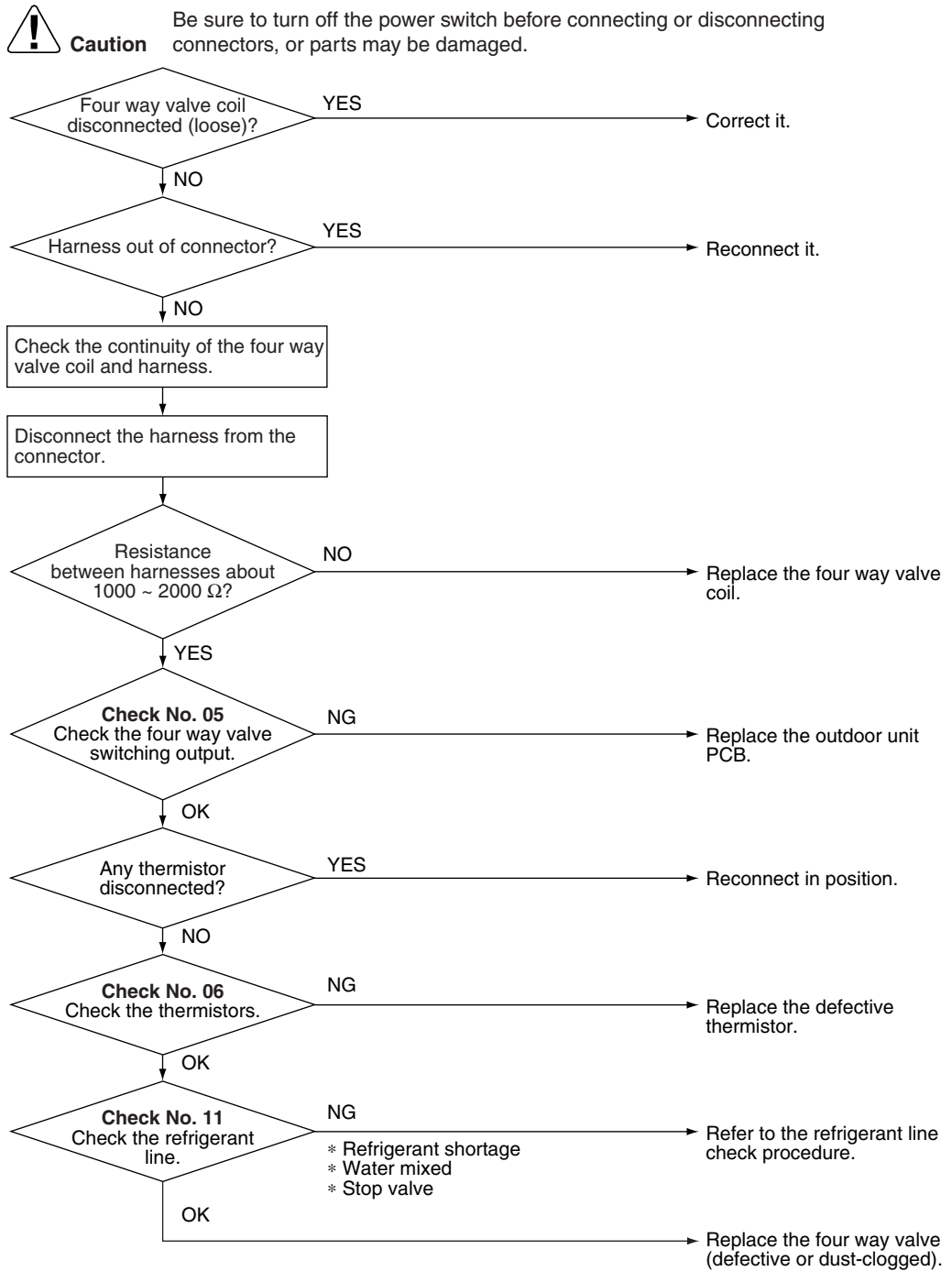

Check No.06
 Refer to P.92

Check No.11
 Refer to P.95





(R11710)

4.14 Discharge Pipe Temperature Control

<p>Remote Controller Display</p>													
<p>Method of Malfunction Detection</p>	<p>An error is determined with the temperature detected by the discharge pipe thermistor.</p>												
<p>Malfunction Decision Conditions</p>	<ul style="list-style-type: none"> ■ If the temperature detected by the discharge pipe thermistor rises above Δ °C, the compressor stops. ■ The error is cleared when the discharge pipe temperature has dropped below B °C. 												
	<table border="1" style="width: 100%; border-collapse: collapse;"> <thead> <tr> <th style="text-align: left;">Stop temperatures</th> <th style="text-align: center;">Δ (°C)</th> <th style="text-align: center;">B (°C)</th> </tr> </thead> <tbody> <tr> <td>(1) above 45 Hz (rising), above 40 Hz (dropping)</td> <td style="text-align: center;">110</td> <td style="text-align: center;">97</td> </tr> <tr> <td>(2) 30~45 Hz (rising), 25~40 Hz (dropping)</td> <td style="text-align: center;">105</td> <td style="text-align: center;">92</td> </tr> <tr> <td>(3) below 30 Hz (rising), below 25 Hz (dropping)</td> <td style="text-align: center;">99</td> <td style="text-align: center;">86</td> </tr> </tbody> </table>	Stop temperatures	Δ (°C)	B (°C)	(1) above 45 Hz (rising), above 40 Hz (dropping)	110	97	(2) 30~45 Hz (rising), 25~40 Hz (dropping)	105	92	(3) below 30 Hz (rising), below 25 Hz (dropping)	99	86
Stop temperatures	Δ (°C)	B (°C)											
(1) above 45 Hz (rising), above 40 Hz (dropping)	110	97											
(2) 30~45 Hz (rising), 25~40 Hz (dropping)	105	92											
(3) below 30 Hz (rising), below 25 Hz (dropping)	99	86											
	<ul style="list-style-type: none"> ■ If the error repeats 4 times, the system is shut down. ■ Reset condition: Continuous run for about 60 minutes without any other error 												
<p>Supposed Causes</p>	<ul style="list-style-type: none"> ■ Defective discharge pipe thermistor (Defective outdoor heat exchanger thermistor or outdoor temperature thermistor) ■ Defective electronic expansion valve or coil ■ Refrigerant shortage ■ Defective four way valve ■ Water mixed in refrigerant ■ Defective stop valve ■ Defective outdoor unit PCB 												

Troubleshooting

-  **Check No.04**
Refer to P.90
-  **Check No.06**
Refer to P.92
-  **Check No.11**
Refer to P.95

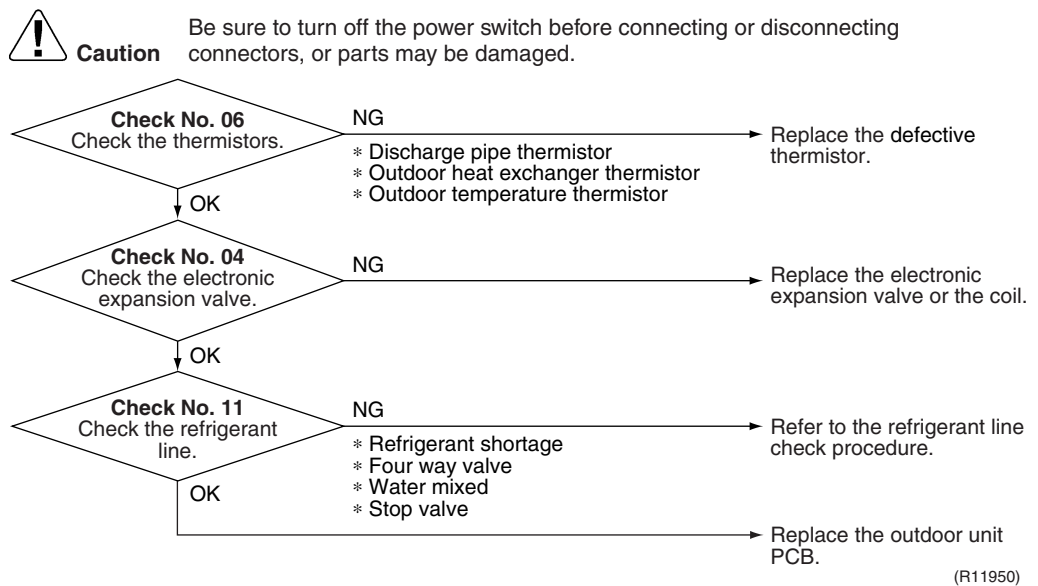

4.15 High Pressure Control in Cooling

Remote
Controller
Display



Method of
Malfunction
Detection

High-pressure control (operation halt, frequency drop, etc.) is activated in cooling operation if the temperature sensed by the outdoor heat exchanger thermistor exceeds the limit.

Malfunction
Decision
Conditions

- The temperature sensed by the outdoor heat exchanger thermistor rises above about 60°C.
- The error is cleared when the temperature drops below about 50°C.

Supposed
Causes

- The installation space is not large enough.
- Dirty outdoor heat exchanger
- Defective outdoor fan motor
- Defective stop valve
- Defective electronic expansion valve or coil
- Defective outdoor heat exchanger thermistor
- Defective outdoor unit PCB

Troubleshooting

Check No.04
Refer to P.90

Check No.06
Refer to P.92

Check No.07
Refer to P.93

Check No.08
Refer to P.93

Check No.09
Refer to P.94

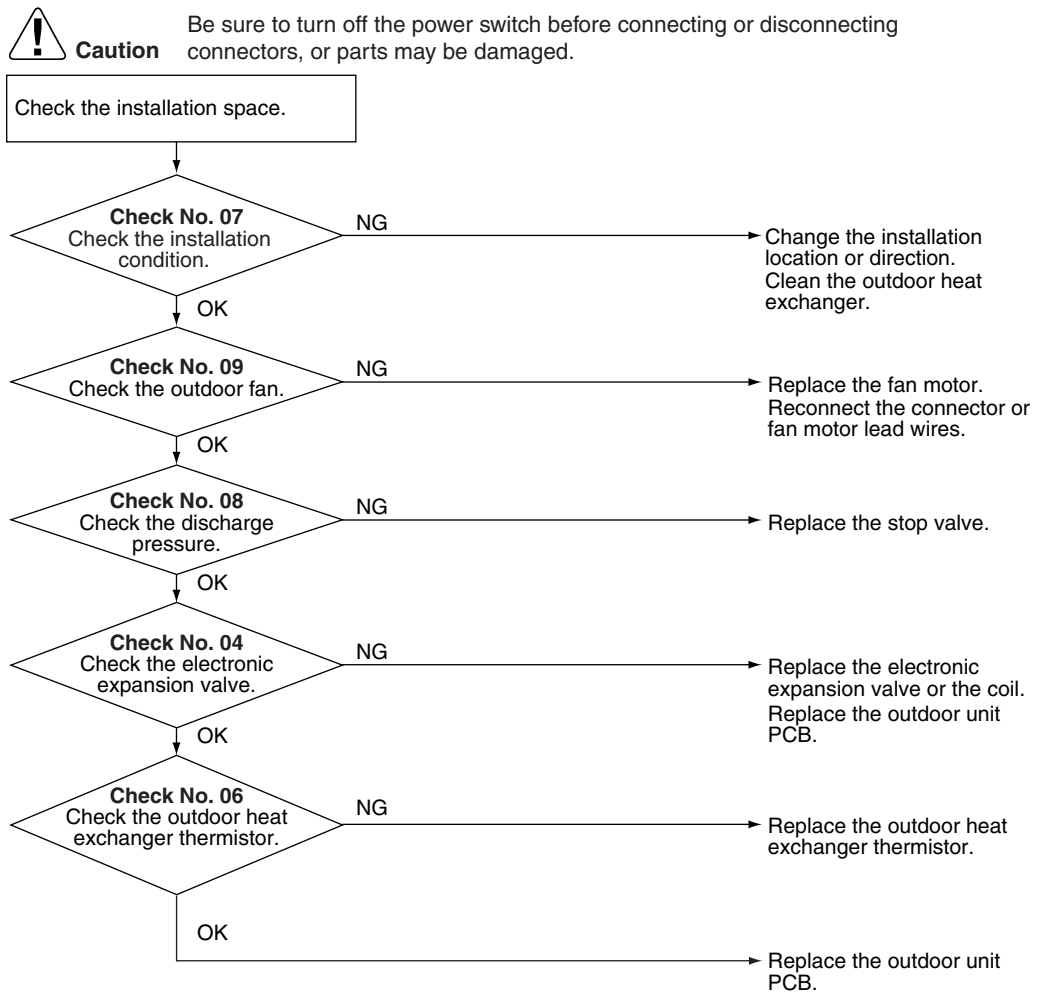

(R11897)

4.16 Compressor System Sensor Abnormality

Remote
Controller
Display



Method of
Malfunction
Detection

- The system checks the DC current before the compressor starts.

Malfunction
Decision
Conditions

- The DC current before compressor start-up is out of the range 0.5-4.5 V (sensor output converted to voltage value)
- The DC voltage before compressor start-up is below 50 V.

Supposed
Causes

- Broken or disconnection of harness
- Defective outdoor unit PCB

Troubleshooting



Caution

Be sure to turn off the power switch before connecting or disconnecting connectors, or parts may be damaged.

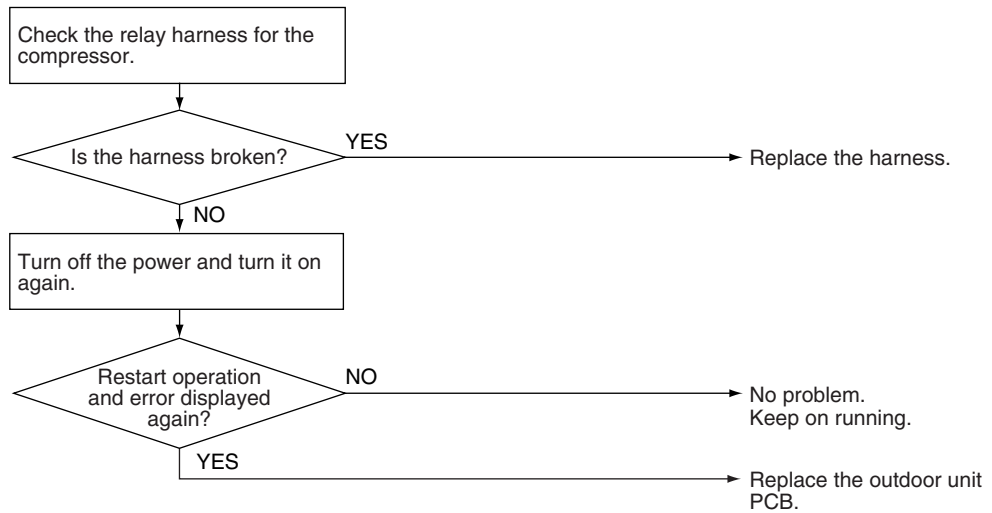

(R11712)

4.17 Position Sensor Abnormality

Remote
Controller
Display



Method of
Malfunction
Detection

A compressor start-up failure is detected by checking the compressor running condition through the position detection circuit.

Malfunction
Decision
Conditions

- The compressor fails to start in about 15 seconds after the compressor run command signal is sent.
- If the error repeats 16 times, the system is shut down.
- Reset condition: Continuous run for about 11 minutes without any other error

Supposed
Causes

- Disconnection of the compressor relay cable
- Defective compressor
- Defective outdoor unit PCB
- Start-up failure caused by the closed stop valve
- Input voltage is out of specification

Troubleshooting



Check No.29
Refer to P.99



Caution Be sure to turn off the power switch before connecting or disconnecting connectors, or parts may be damaged.

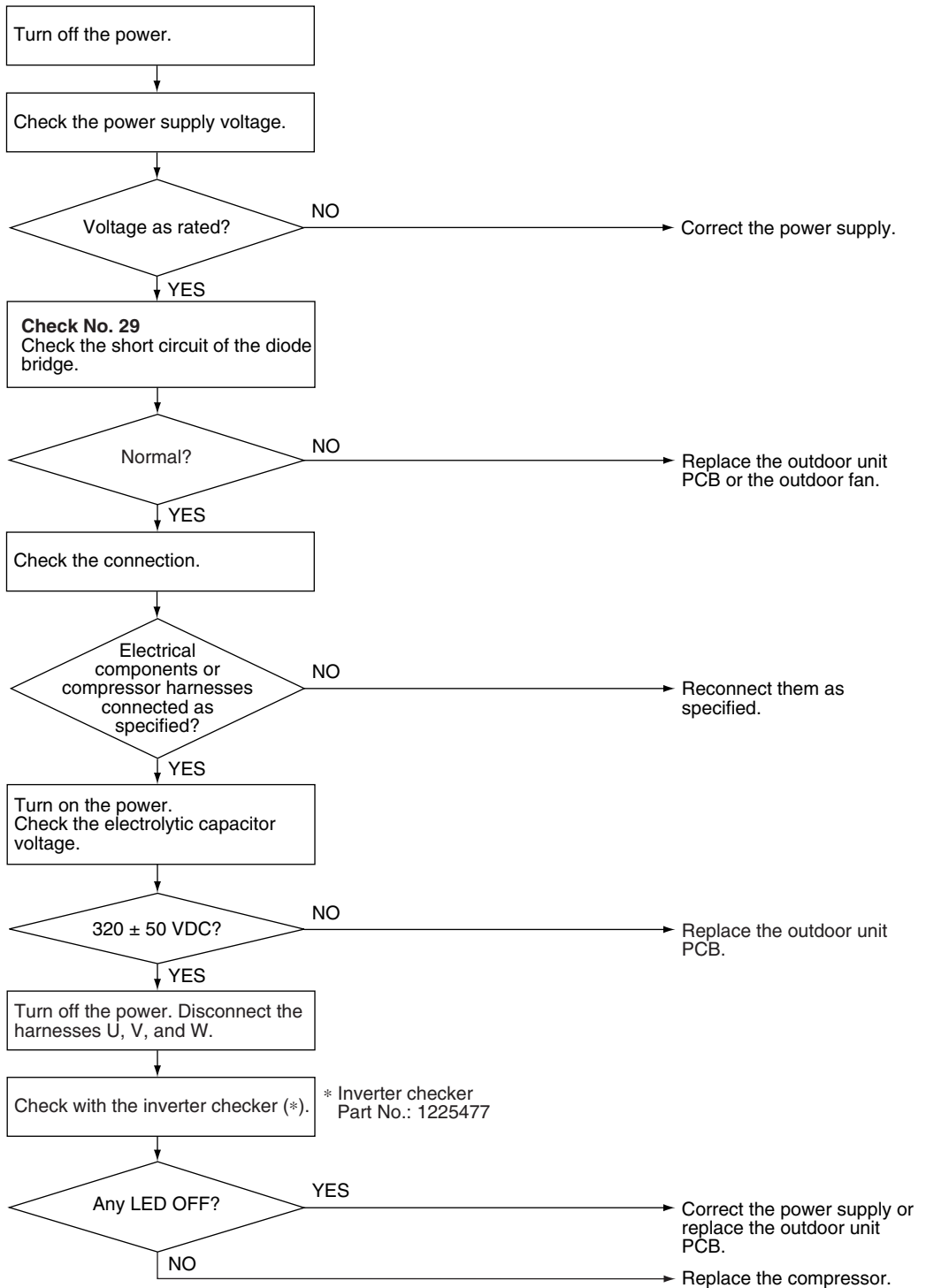

(R11380)

4.18 DC Voltage / Current Sensor Abnormality

Remote
Controller
Display



Method of
Malfunction
Detection

DC voltage or DC current sensor abnormality is identified based on the compressor running frequency and the input current.

Malfunction
Decision
Conditions

- The compressor running frequency is above 52 Hz.
(The input current is also below 0.1 A.)
- If the error repeats 4 times, the system is shut down.
- Reset condition: Continuous run for about 60 minutes without any other error.

Supposed
Causes

- Defective outdoor unit PCB

Troubleshooting



Caution

Be sure to turn off the power switch before connecting or disconnecting connectors, or parts may be damaged.

Replace the outdoor unit PCB.

4.19 Thermistor or Related Abnormality (Outdoor Unit)

Remote
Controller
Display

H3, U3, U5, P4

Method of
Malfunction
Detection

This fault is identified based on the thermistor input voltage to the microcomputer.
A thermistor fault is identified based on the temperature sensed by each thermistor.

Malfunction
Decision
Conditions

- The thermistor input voltage is above 4.96 V or below 0.04 V with the power on.
- U3 error is judged if the discharge pipe temperature is lower than the heat exchanger temperature.

Supposed
Causes

- Disconnection of the connector for the thermistor
- Defective thermistor
- Defective heat exchanger thermistor in the case of U3 error (outdoor heat exchanger thermistor in cooling operation, or indoor heat exchanger thermistor in heating operation)
- Defective outdoor unit PCB
- Defective indoor unit PCB

Troubleshooting

In case of "P4"



Caution

Be sure to turn off the power switch before connecting or disconnecting connectors, or parts may be damaged.

Replace the outdoor unit PCB.

P4 : Radiation fin thermistor

Troubleshooting

Check No.06
 Refer to P.92

In case of "H3" "J3" "J5"



Caution

Be sure to turn off the power switch before connecting or disconnecting connectors, or parts may be damaged.

Turn on the power again.

Error displayed again on remote controller?

NO

Reconnect the connectors or thermistors.

YES

Check No. 06
 Check the thermistor resistance value.

Normal?

NO

Replace the defective one(s) of the following thermistors.
 * Outdoor temperature thermistor
 * Discharge pipe thermistor
 * Outdoor heat exchanger thermistor

YES

J3 error: the discharge pipe temperature is lower than the heat exchanger temperature.
 Cooling: Outdoor heat exchanger temperature
 Heating: Indoor heat exchanger temperature

Check No. 06
 Check the indoor heat exchanger thermistor resistance value in the heating operation.

Indoor heat exchanger thermistor functioning?

NO

Replace the indoor heat exchanger thermistor.

YES

Replace the outdoor unit PCB.
 (Replace the indoor unit PCB.)

(R11905)

- H3 : Outdoor temperature thermistor
- J3 : Discharge pipe thermistor
- J5 : Outdoor heat exchanger thermistor

4.20 Electrical Box Temperature Rise

Remote
Controller
Display



Method of
Malfunction
Detection

An electrical box temperature rise is detected by checking the radiation fin thermistor with the compressor off.

Malfunction
Decision
Conditions

- With the compressor off, the radiation fin temperature is above A °C.
- The error is cleared when the radiation fin temperature drops below B °C.
- To cool the electrical components, the outdoor fan starts when the radiation fin temperature rises above C °C and stops when it drops below B °C.

A (°C)	93
B (°C)	70
C (°C)	78

Supposed
Causes

- Defective outdoor fan motor
- Short circuit
- Defective radiation fin thermistor
- Disconnection of connector
- Defective outdoor unit PCB

Troubleshooting

Check No.07
 Refer to P.93

Check No.09
 Refer to P.94

 **Caution** Be sure to turn off the power switch before connecting or disconnecting connectors, or parts may be damaged.

 **WARNING**
 To cool the electrical components, the outdoor fan starts when the radiation fin temperature rises above C °C and stops when it drops below B °C.

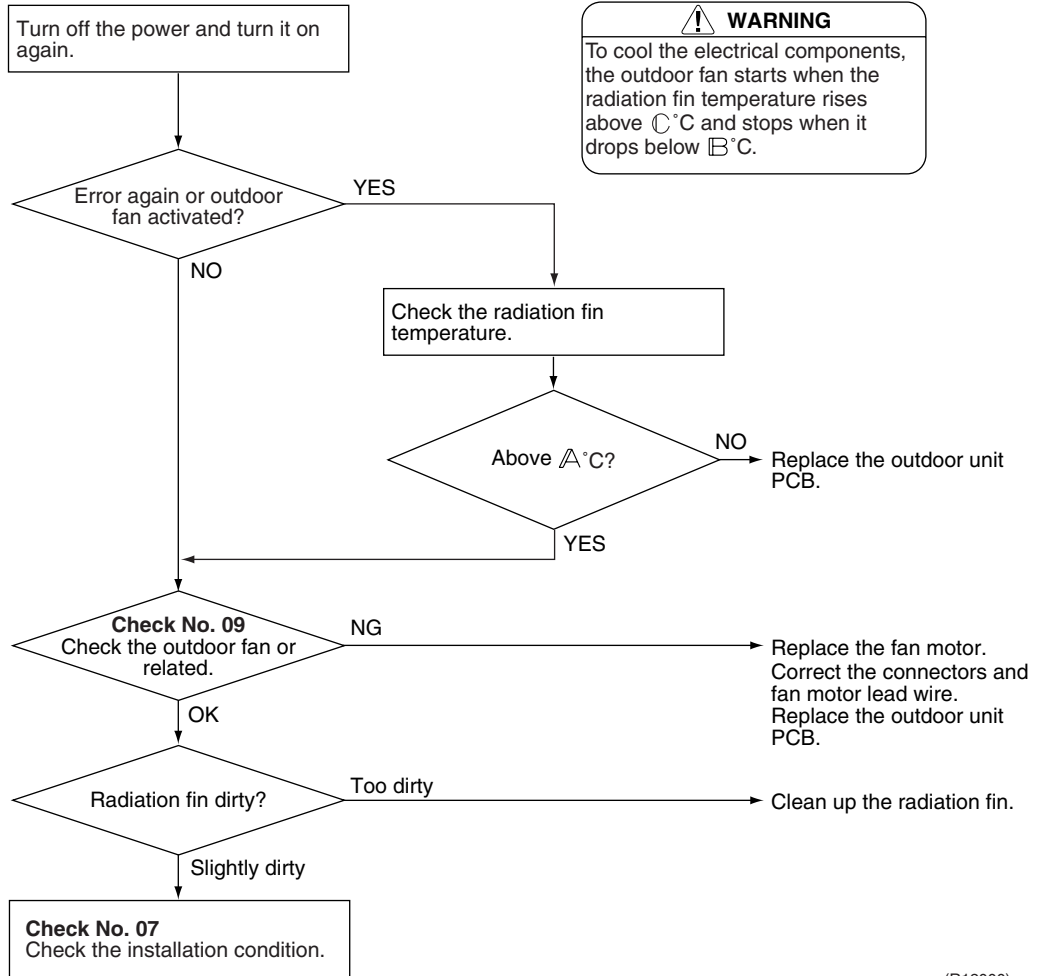

(R12000)

A (°C)	93
B (°C)	70
C (°C)	78

4.21 Radiation Fin Temperature Rise

Remote
Controller
Display

L4

Method of
Malfunction
Detection

A radiation fin temperature rise is detected by checking the radiation fin thermistor with the compressor on.

Malfunction
Decision
Conditions

- If the radiation fin temperature with the compressor on is above A °C.
- The error is cleared when the radiation fin temperature drops below B °C.
- If the error repeats, the system is shut down.
- Reset condition: Continuous run for about 60 minutes without any other error.

A (°C)	93
B (°C)	78

Supposed
Causes

- Defective outdoor fan motor
- Short circuit
- Defective radiation fin thermistor
- Disconnection of connector
- Defective outdoor unit PCB
- Silicon grease is not applied properly on the radiation fin after replacing the outdoor unit PCB.

Troubleshooting

 **Check No.07**
Refer to P.93

 **Check No.09**
Refer to P.94



Caution Be sure to turn off the power switch before connecting or disconnecting connectors, or parts may be damaged.

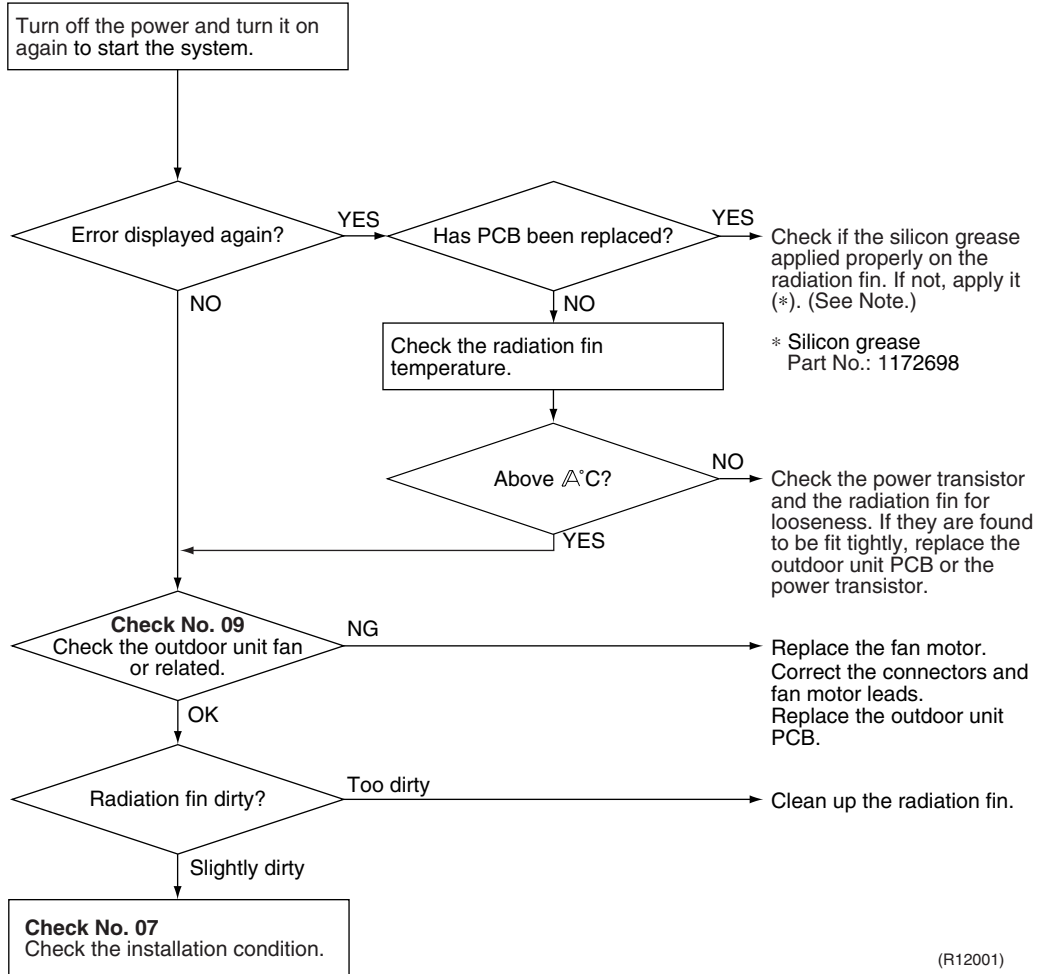

(R12001)

Δ (°C)	93
--------	----



Note: Refer to “Application of silicon grease to a power transistor and a diode bridge” on page 141 for detail.

4.22 Output Overcurrent Detection

Remote
Controller
Display

U5

Method of
Malfunction
Detection

An output overcurrent is detected by checking the current that flows in the inverter DC section.

Malfunction
Decision
Conditions

- A position signal error occurs while the compressor is running.
- A speed error occurs while the compressor is running.
- An output overcurrent signal is fed from the output overcurrent detection circuit to the microcomputer.
- If the error repeats 8 times, the system is shut down.
- Reset condition: Continuous run for about 11 minutes without any other error

Supposed
Causes

- Poor installation condition
- Closed stop valve
- Defective power module
- Wrong internal wiring
- Abnormal supply voltage
- Defective outdoor unit PCB
- Defective compressor

Troubleshooting



Check No.07
Refer to P.93



Check No.08
Refer to P.93



Check No.13
Refer to P.95

Caution Be sure to turn off the power switch before connecting or disconnecting connectors, or parts may be damaged.

* An output overcurrent signal may result from wrong internal wiring. If the wires have been disconnected and reconnected and the system is interrupted by an output overcurrent, take the following procedure.

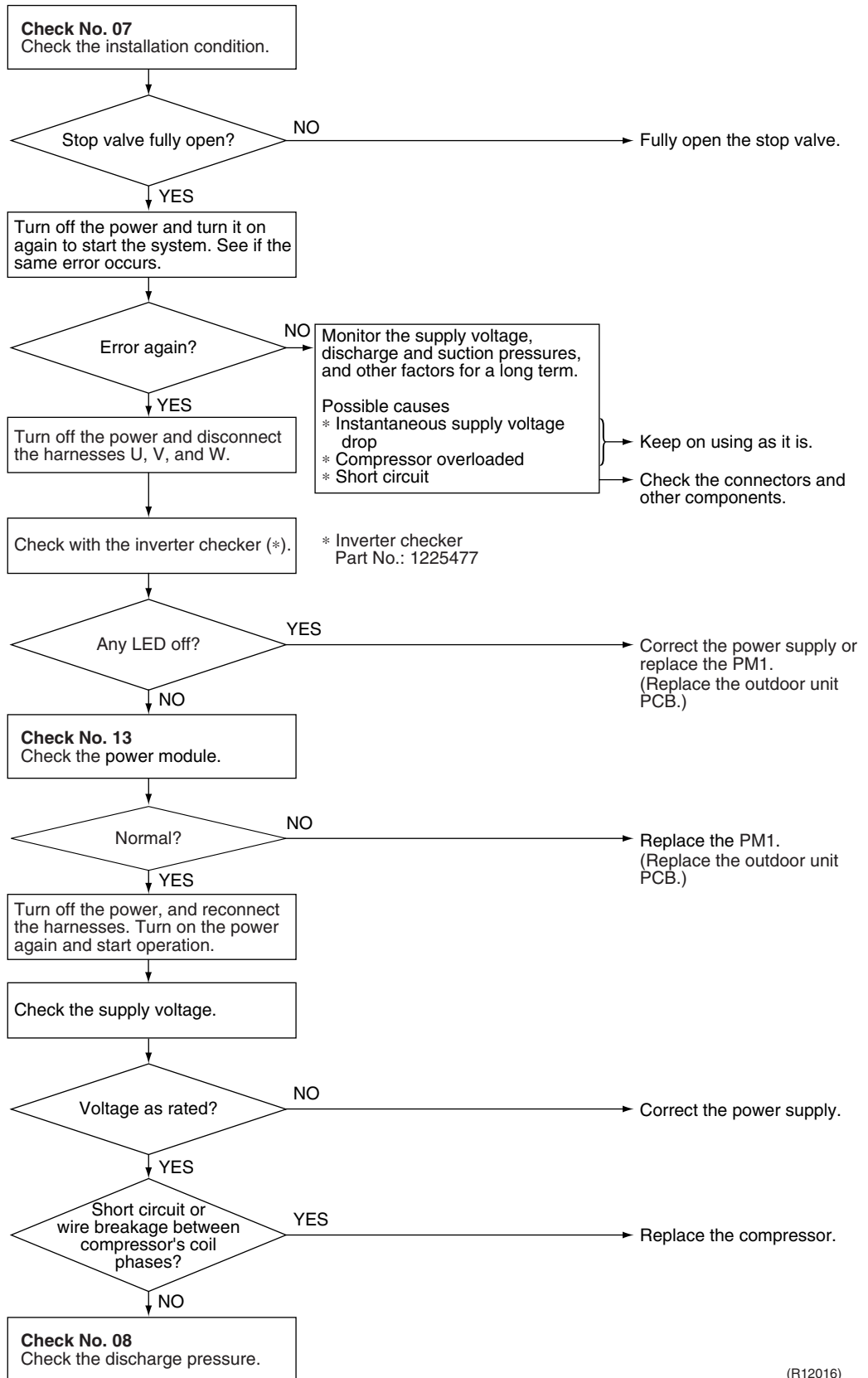

(R12016)

4.23 Refrigerant Shortage

Remote
Controller
Display



Method of
Malfunction
Detection

Refrigerant shortage detection I:

Refrigerant shortage is detected by checking the input current value and the compressor running frequency. If the refrigerant is short, the input current is smaller than the normal value.

Refrigerant shortage detection II:

Refrigerant shortage is detected by checking the discharge pipe temperature and the opening of the electronic expansion valve. If the refrigerant is short, the discharge pipe temperature tends to rise.

Malfunction
Decision
Conditions

Refrigerant shortage detection I:

The following conditions continue for 7 minutes.

- ◆ Input current \times input voltage \leq A \times output frequency + B
- ◆ Output frequency $>$ C

	A (-)	B (W)	C (Hz)
20/25 class	828/256	-10	50
35 class	777/256	-15	50

Refrigerant shortage detection II :

The following conditions continue for 80 seconds.

- ◆ Opening of the electronic expansion valve \geq D
- ◆ Discharge pipe temperature $>$ E \times target discharge pipe temperature + F

		D (pulse)	E (-)	F (°C)
20/25 class	Cooling	470	190/128	-7
	Heating		211/128	-11
35 class	Cooling	470	160/128	- 1.5
	Heating		172/128	-8

- If the error repeats 4 times, the system is shut down.
- Reset condition: Continuous run for about 60 minutes without any other error.

Supposed
Causes

- Disconnection of the discharge pipe thermistor, indoor or outdoor heat exchanger thermistor, room or outdoor temperature thermistor
- Closed stop valve
- Refrigerant shortage (refrigerant leakage)
- Poor compression performance of compressor
- Defective electronic expansion valve

Troubleshooting

Check No.04
 Refer to P.90

Check No.06
 Refer to P.92



Caution Be sure to turn off the power switch before connecting or disconnecting connectors, or parts may be damaged.

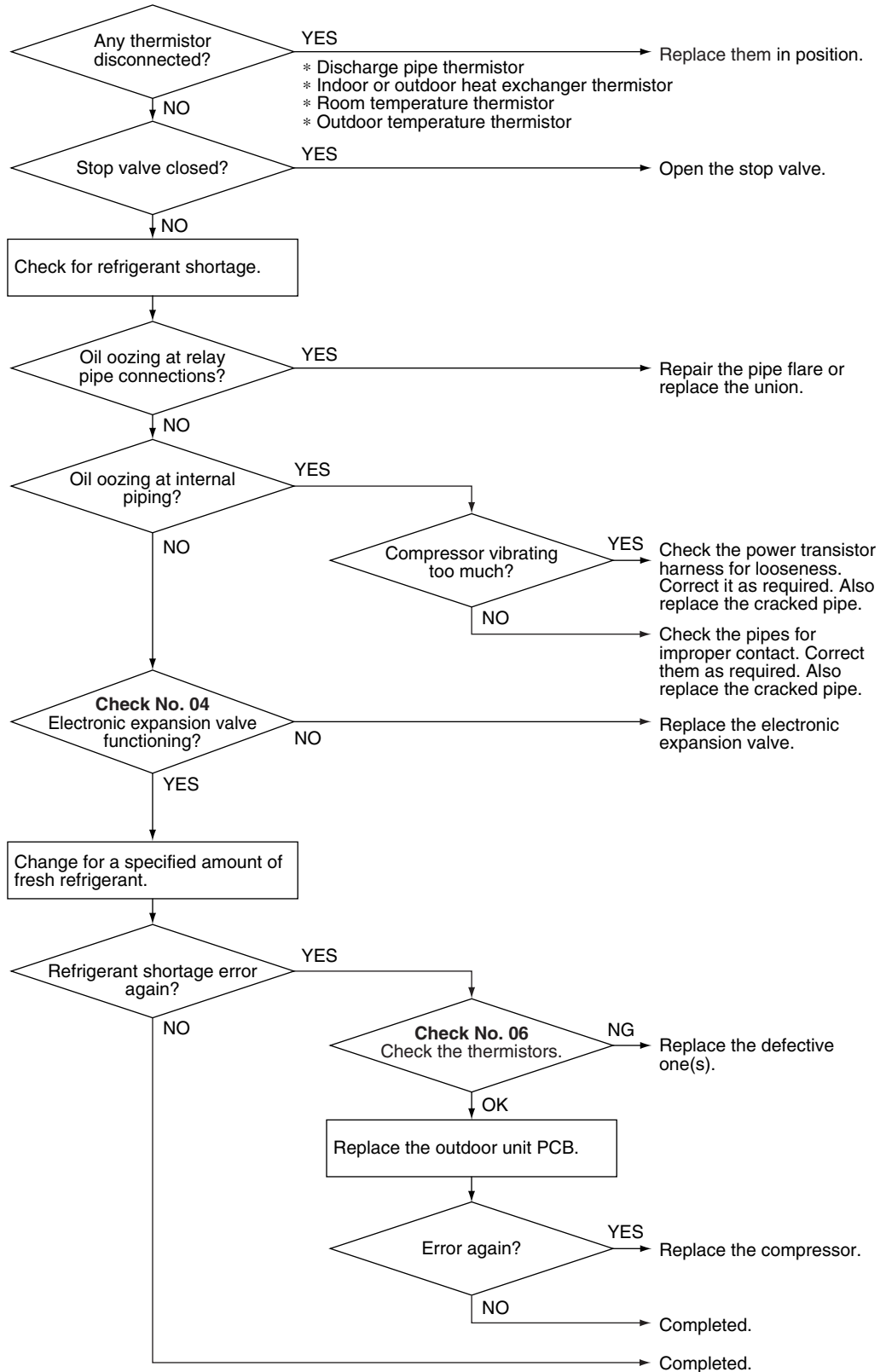

(R12015)

4.24 Low-voltage Detection or Over-voltage Detection

Remote
Controller
Display



Method of
Malfunction
Detection

Low-voltage detection:

An abnormal voltage drop is detected by the DC voltage detection circuit.

Over-voltage detection:

An abnormal voltage rise is detected by the over-voltage detection circuit.

Malfunction
Decision
Conditions

Low-voltage detection:

- The voltage detected by the DC voltage detection circuit is below 150 V.
- The compressor stops if the error occurs, and restarts automatically after 3-minute standby.

Over-voltage detection:

- An over-voltage signal is fed from the over-voltage detection circuit to the microcomputer.
- The compressor stops if the error occurs, and restarts automatically after 3-minute standby.

Supposed
Causes

- Supply voltage is not as specified.
- Defective DC voltage detection circuit
- Defective over-voltage detection circuit
- Defective PAM control part
- Layer short inside the fan motor winding

Troubleshooting

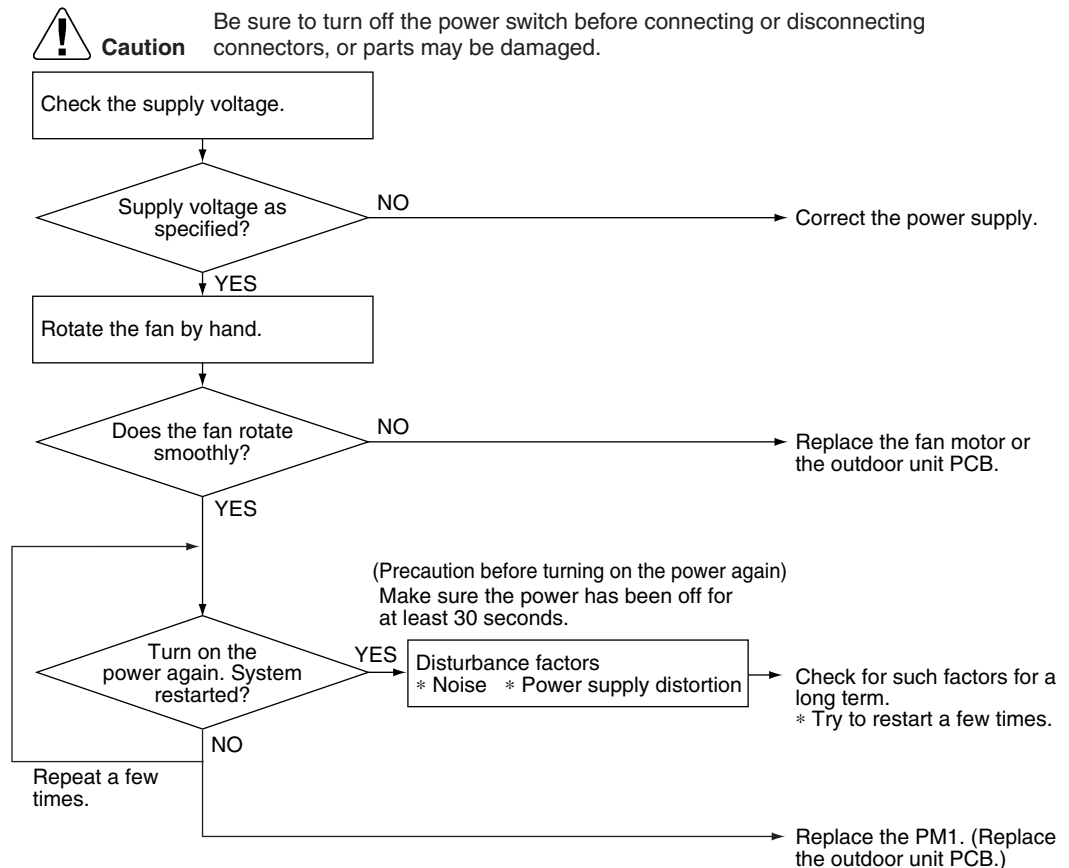

(R8402)

5. Check

5.1 How to Check

5.1.1 Electronic Expansion Valve Check

Check No.04

Conduct the followings to check the electronic expansion valve (EV).

1. Check to see if the EV connector is correctly connected to the PCB.
2. Turn the power off and on again, and check to see if the EV generate latching sound.
3. If the EV does not generate latching sound in the above step 2, disconnect the connector and check the continuity using a tester.
4. Check the continuity between the pins 1 - 6 and 3 - 6, and between the pins 2 - 5 and 4 - 5. If there is no continuity between the pins, the EV coil is faulty.

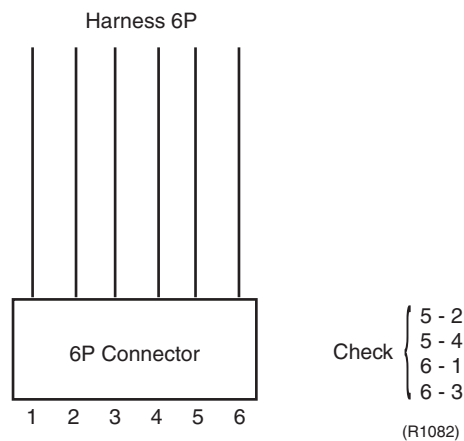

5. If the continuity is confirmed in the above step 3, the outdoor unit PCB is faulty.



Note: Please note that the latching sound varies depending on the valve type.

5.1.2 Four Way Valve Performance Check

Check No.05

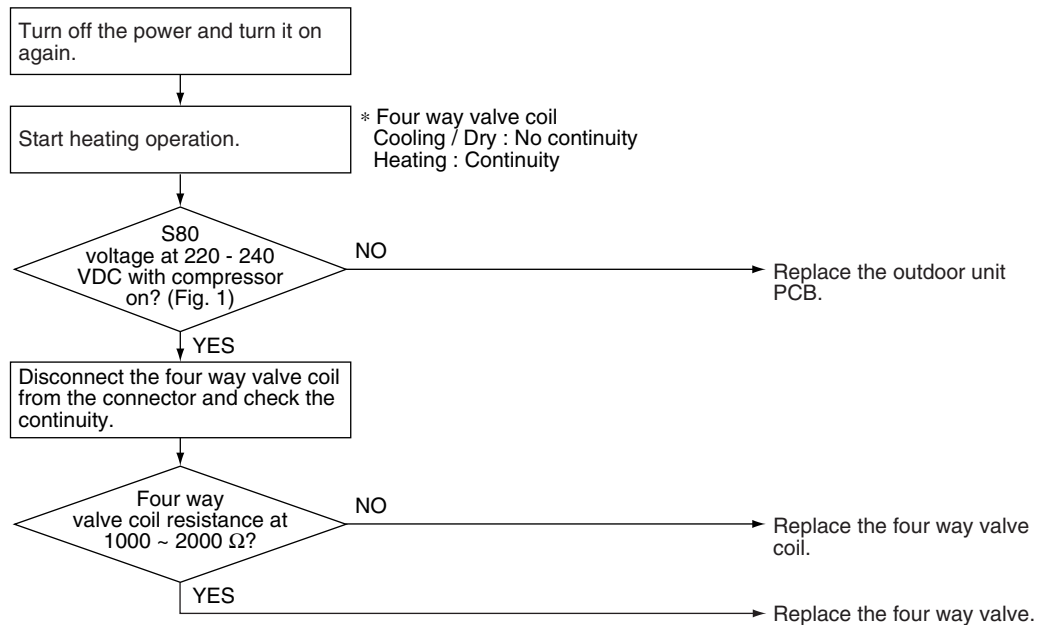

(R11965)

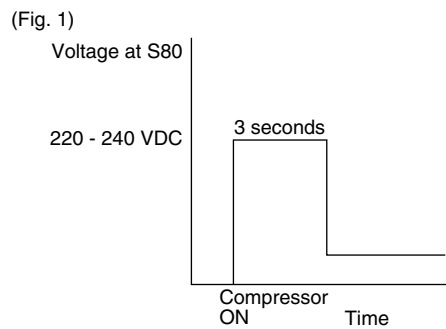

(R12017)

5.1.3 Thermistor Resistance Check

Check No.06

Disconnect the connectors of the thermistors from the PCB, and measure the resistance of each thermistor using tester.

The relationship between normal temperature and resistance is shown in the table and the graph below.

Thermistor	Room temperature thermistor	Other thermistors
Temperature (°C)	R25°C = 10 kΩ B = 3435	R25°C = 20 kΩ B = 3950
-20	73.4 (kΩ)	211.0 (kΩ)
-15	57.0	150.0
-10	44.7	116.5
-5	35.3	88.0
0	28.2	67.2
5	22.6	51.9
10	18.3	40.0
15	14.8	31.8
20	12.1	25.0
25	10.0	20.0
30	8.2	16.0
35	6.9	13.0
40	5.8	10.6
45	4.9	8.7
50	4.1	7.2

Room temperature thermistor

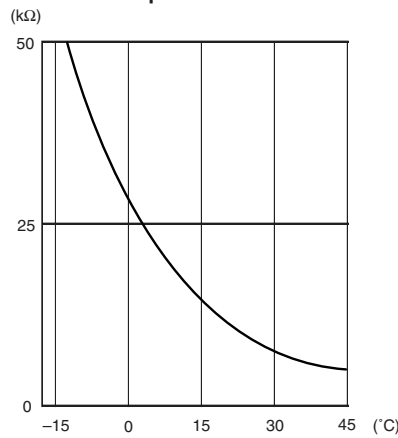

Other thermistors

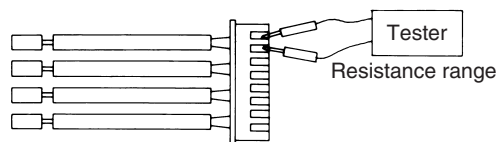
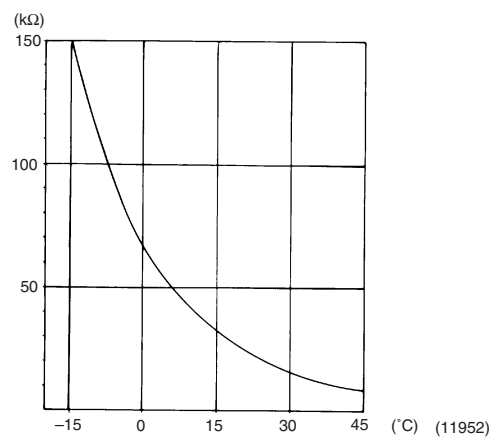

- For the models in which the thermistor is directly mounted on the PCB, disconnect the connector for the PCB and measure.

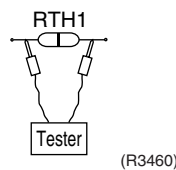

5.1.4 Installation Condition Check

Check No.07

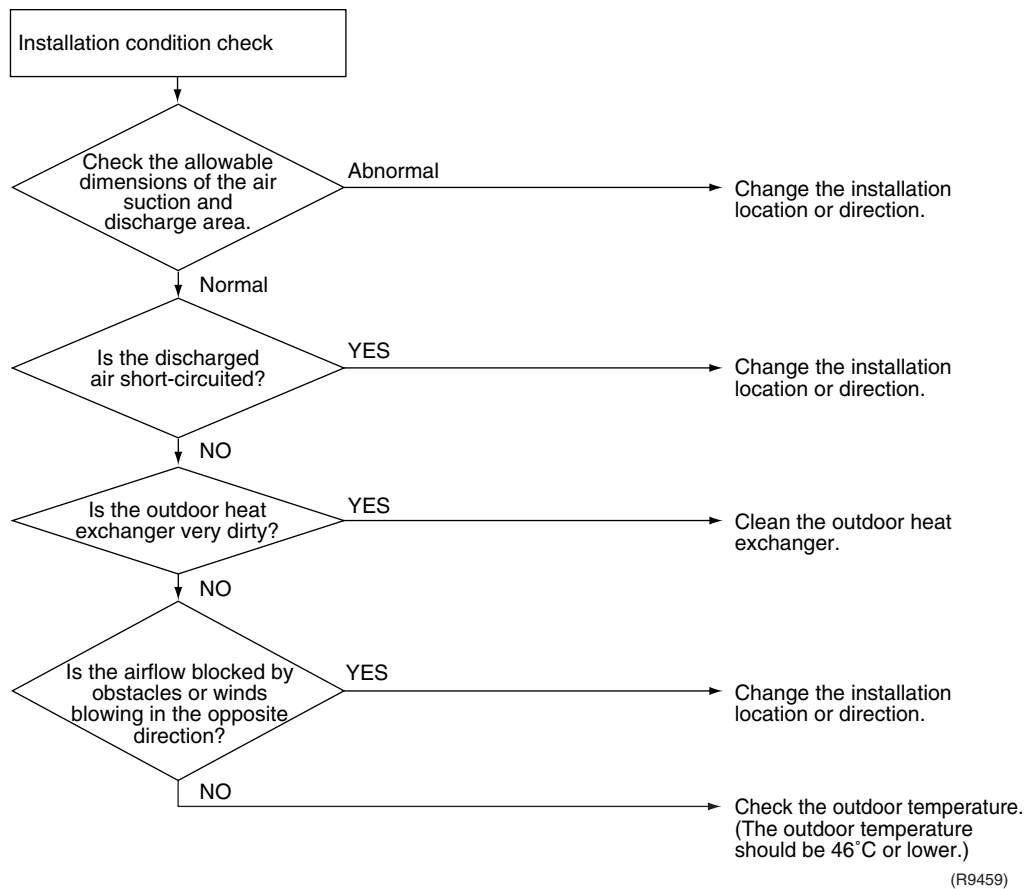

5.1.5 Discharge Pressure Check

Check No.08

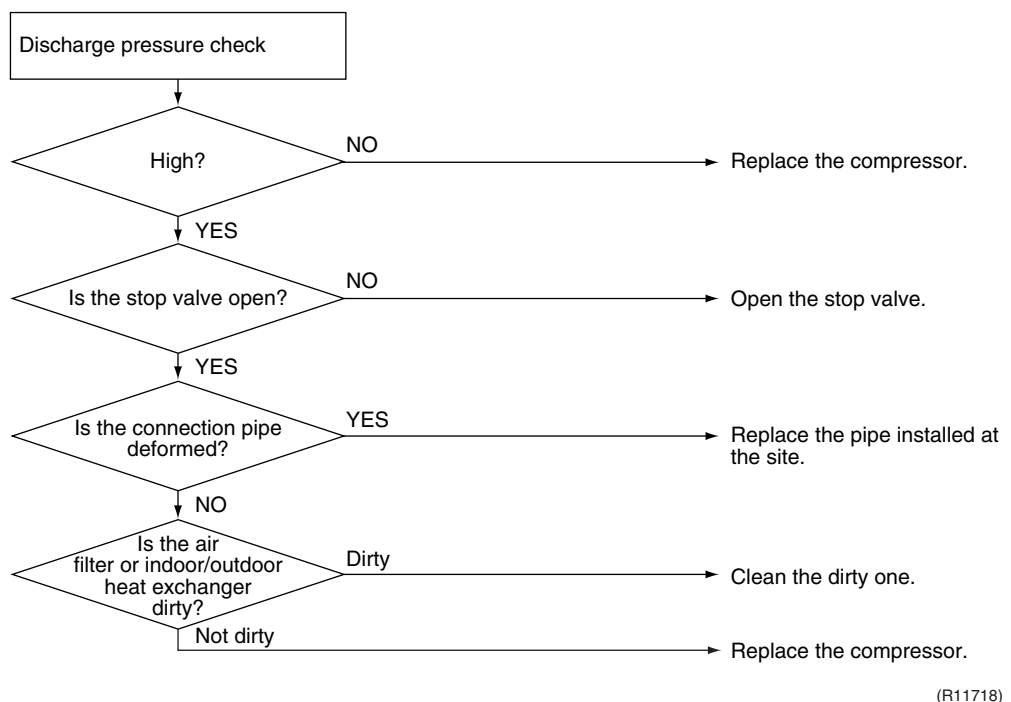

5.1.6 Outdoor Fan System Check

Check No.09

DC motor

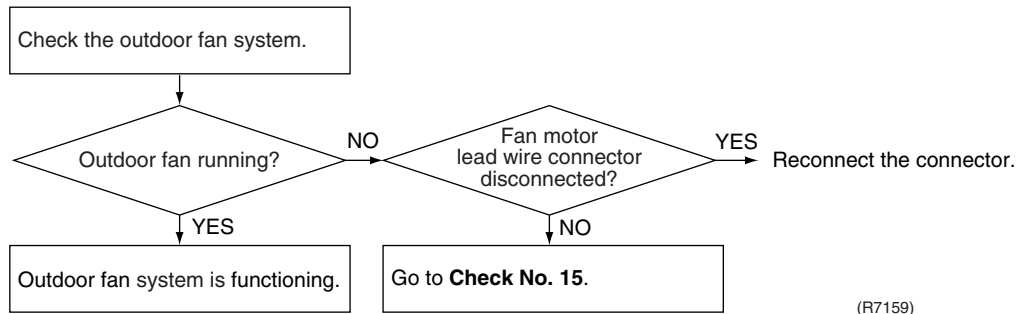

(R7159)

5.1.7 Power Supply Waveforms Check

Check No.10

Measure the power supply waveform between No. 1 and No. 2 on the terminal board, and check the waveform disturbance.

- Check to see if the power supply waveform is a sine wave. (Fig.1)
- Check to see if there is waveform disturbance near the zero cross. (sections circled in Fig.2)

Fig.1

Fig.2

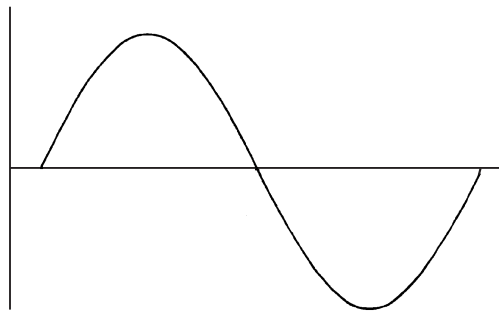

(R1736)

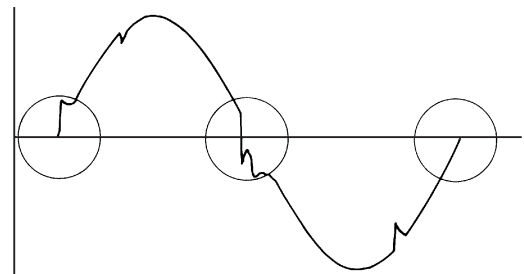

(R1444)

5.1.8 Inverter Units Refrigerant System Check

Check No.11

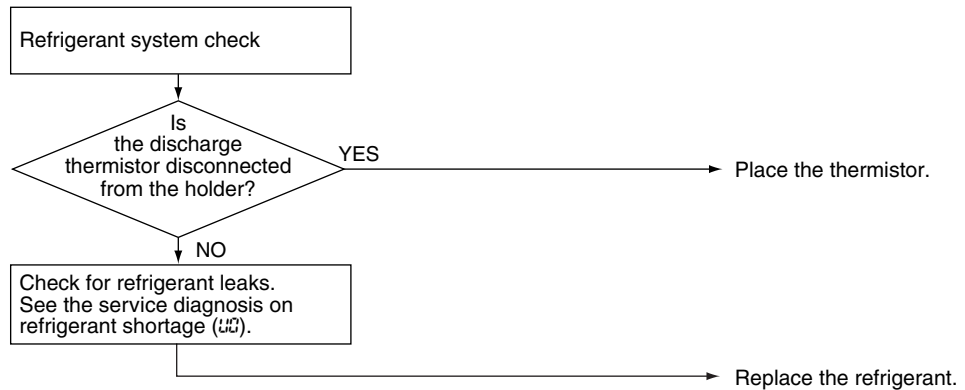

(R8259)

5.1.9 Power Module Check

Check No.13



Note: Check to make sure that the voltage between (+) and (-) of the diode bridge (DB1) is approx. 0 V before checking.

- Disconnect the compressor harness connector from the outdoor unit PCB. To disengage the connector, press the protrusion on the connector.
- Follow the procedure below to measure resistance between the terminals of the DB1 and the terminals of the compressor connector with a multi-tester. Evaluate the measurement results for a judgment.

Negative (-) terminal of tester (positive terminal (+) for digital tester)	DB1 (+)	UVW	DB1 (-)	UVW
Positive (+) terminal of tester (negative terminal (-) for digital tester)	UVW	DB1 (+)	UVW	DB1 (-)
Resistance in OK	several kΩ ~ several MΩ			
Resistance in NG	0 Ω or ∞			

5.1.10 Rotation Pulse Check on the Outdoor Unit PCB

Check No.15

<Outdoor fan motor>

1. Check that the voltage between the pins 10-11 is 15 VDC.
2. Check if the Hall IC generates the rotation pulse (0 ~ 15 VDC) 4 times between the pins 10-12, 10-13, when the fan motor is manually rotated once.

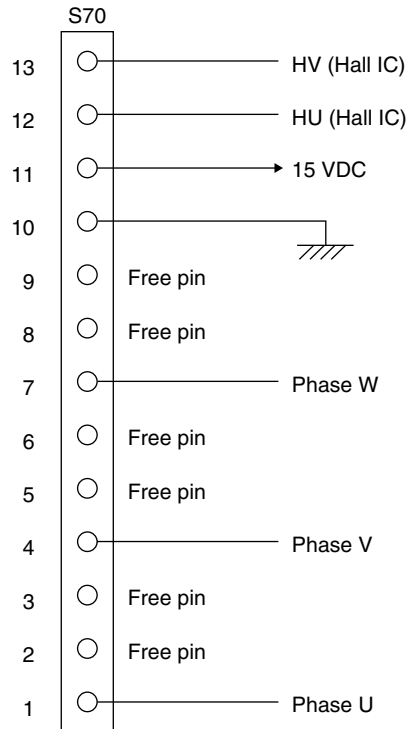

(R11907)

5.1.11 Indoor Unit PCB Output Check

Check No.18

- (1) Check the connector for connection.
- (2) Check the motor control voltage is generated (between the pins 2 and 3).

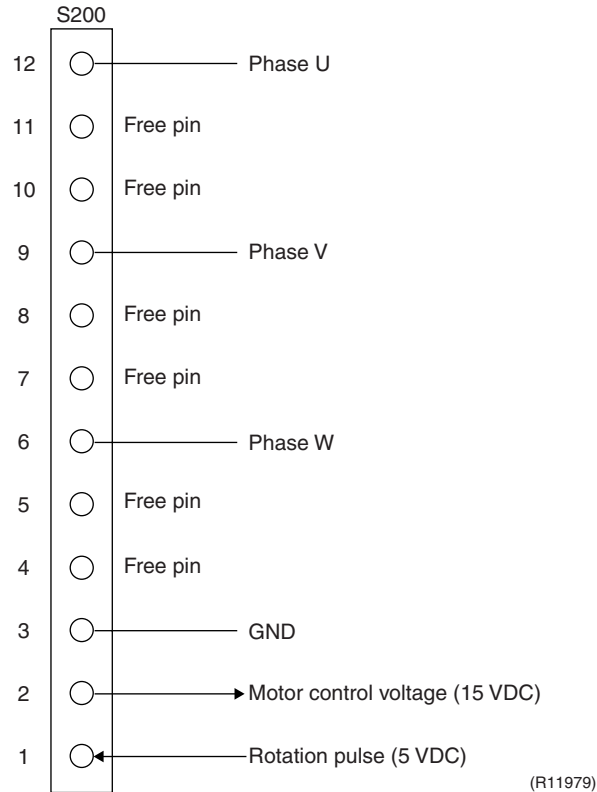

5.1.12 Rotation Pulse Check on the Indoor Unit PCB

Check No.19

- (1) Check the connector for connection.
- (2) Turn the power on and stop the operation.
- (3) Check if the Hall IC generates the rotation pulse 4 times when the fan motor is manually rotated once (between the pins 1 and 3).

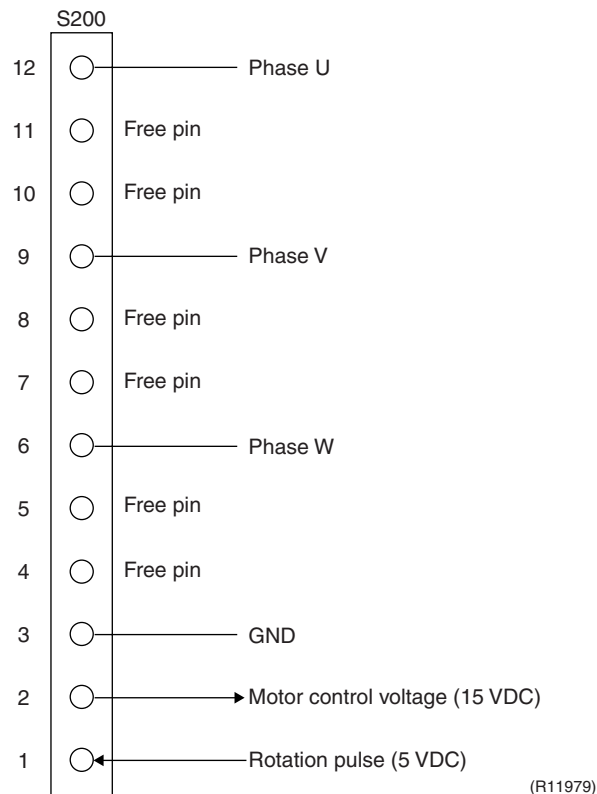

5.1.13 Fan Motor Wire / Short Circuit Check

Check No.20

- (1) Check the connector for connection.
- (2) Turn the power off.
- (3) Check if each resistance at the phases U-V and V-W is $90\ \Omega \sim 100\ \Omega$ (between the pins 12-9, and between 9-6).

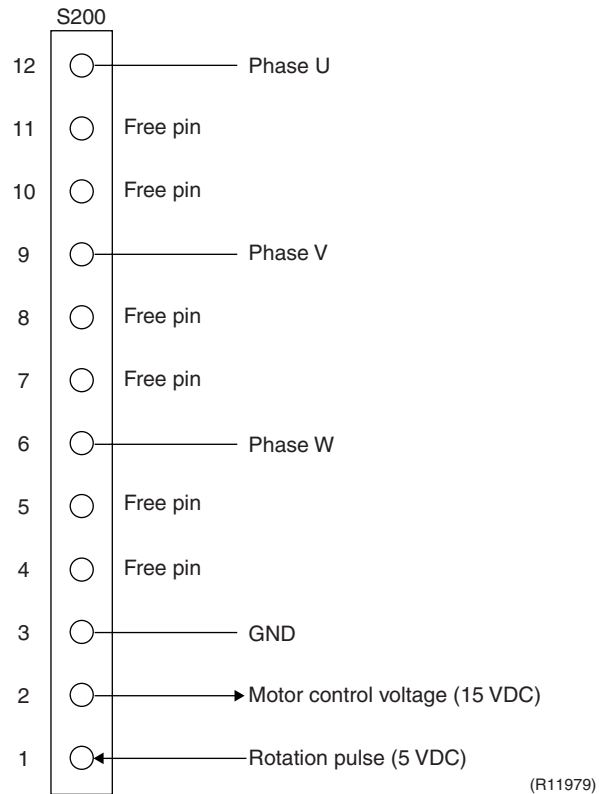

5.1.14 Main Circuit Short Check

Check No.29



Note: Check to make sure that the voltage between (+) and (-) of the diode bridge (DB1) is approx. 0 V before checking.

- Measure the resistance between the pins of the DB1 as below.
- If the resistance is ∞ or less than 1 k Ω , short circuit occurs on the main circuit.

(-) terminal of the tester (in case of digital, (+) terminal)	~ (2, 3)	+ (4)	~ (2, 3)	- (1)
(+) terminal of the tester (in case of digital, (-) terminal)	+ (4)	~ (2, 3)	- (1)	~ (2, 3)
Resistance in OK	several k Ω ~ several M Ω	∞	∞	several k Ω ~ several M Ω
Resistance in NG	0 Ω or ∞	0	0	0 Ω or ∞

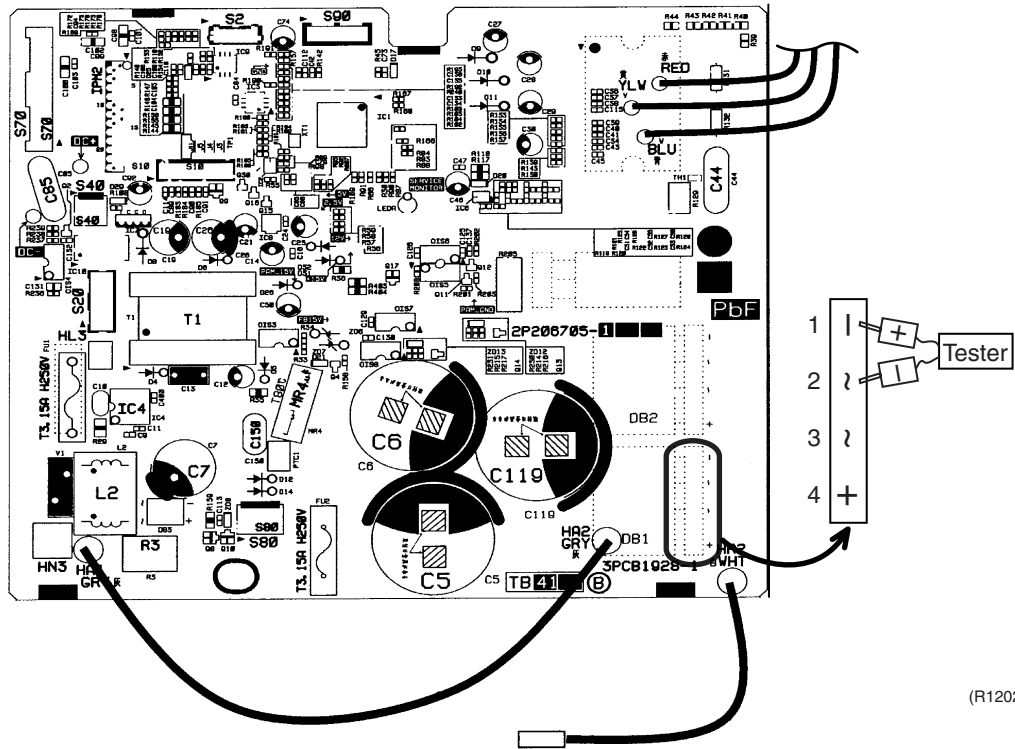

(R12025)

Part 7

Removal Procedure

1. Indoor Unit.....	101
1.1 Removal of Air Filter.....	101
1.2 Removal of Horizontal Blades / Fan Guard.....	103
1.3 Removal of Front Panel.....	105
1.4 Removal of Front Grille	106
1.5 Removal of Electrical Box / Vertical Blades	108
1.6 Removal of PCB / Swing Motor.....	111
1.7 Removal of Indoor Heat Exchanger	115
1.8 Removal of Fan Rotor	118
1.9 Exchange of Drain Hose	121
2. Outdoor Unit.....	122
2.1 Removal of Panels	122
2.2 Removal of Outdoor Fan / Fan Motor.....	124
2.3 Removal of Electrical Box / Control PCB	125
2.4 Removal of Sound Blanket.....	132
2.5 Removal of Four Way Valve.....	134
2.6 Removal of Compressor.....	137

1. Indoor Unit

1.1 Removal of Air Filter

Procedure



Warning

Be sure to wait 10 minutes or more after turning off all power supplies before disassembling work.

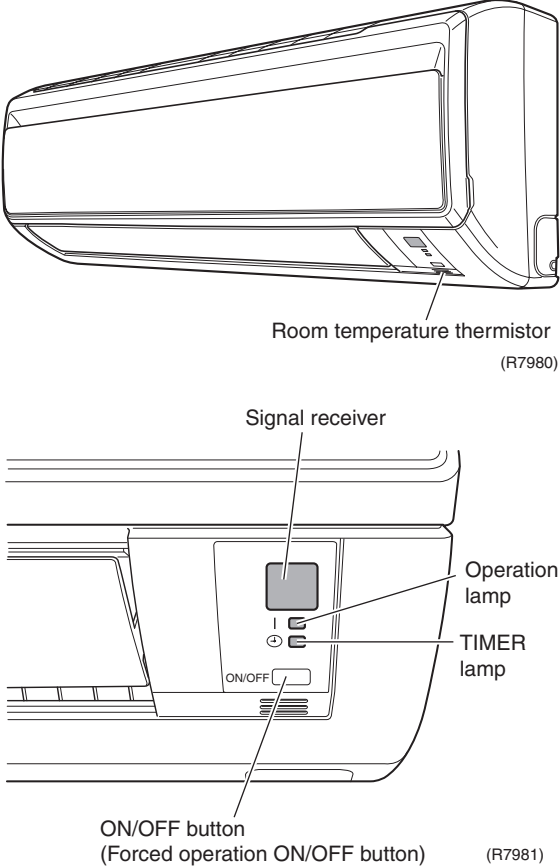
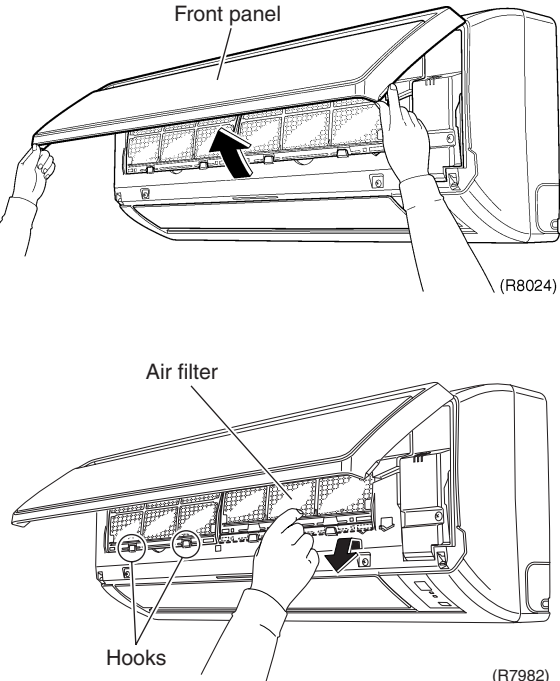
Step	Procedure	Points
<p>1. Appearance feature</p>	 <p>Room temperature thermistor (R7980)</p> <p>Signal receiver</p> <p>Operation lamp</p> <p>TIMER lamp</p> <p>ON/OFF button (Forced operation ON/OFF button) (R7981)</p>	<p>Warning Dangerous: High voltage A high voltage is applied to all the electric circuits of this product including thermistors.</p> <ul style="list-style-type: none"> ■ When a signal from the remote controller is received, the receiving tone sounds and the operation lamp flickers immediately to confirm the signal reception. ■ When the ON/OFF button is kept pressed for 5 seconds, the forced cooling operation is performed for about 15 minutes.
<p>2. Remove the air filter.</p> <p>1 Open the front panel to the position where it stops.</p> <p>2 Slightly push up the knob at the center of the air filter.</p>	 <p>Front panel</p> <p>Air filter</p> <p>Hooks</p>	<ul style="list-style-type: none"> ■ The air filter is not marked for difference between the right and left sides. ■ The air filter can be set easily by inserting it along the guides. ■ Insert the air filter with the "FRONT" mark faced up. ■ Be sure to insert the hooks (at 2 lower positions) when mounting the air filter.

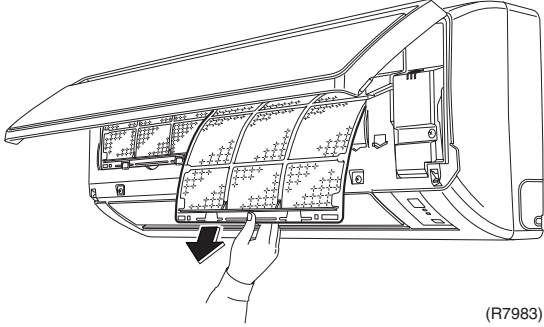
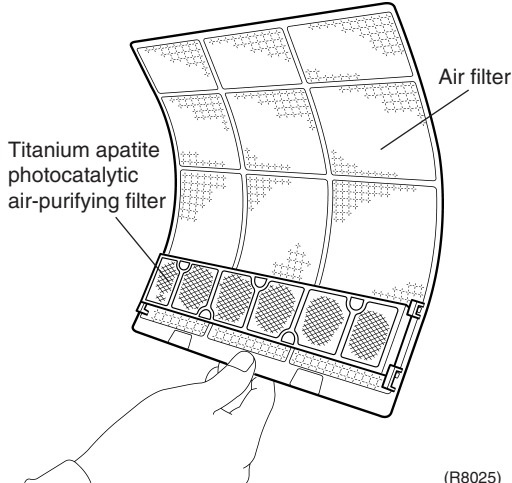
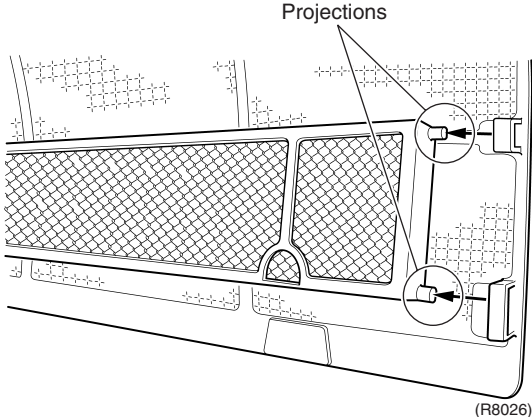
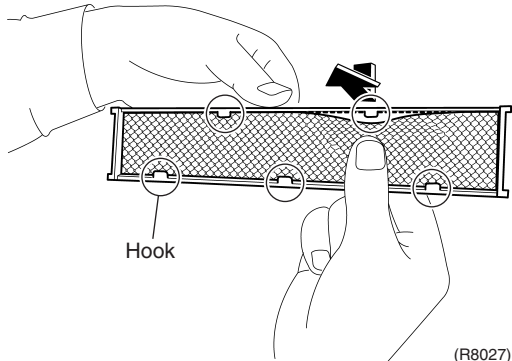
Step	Procedure	Points
3	<p>Pull out the air filter downward and remove it.</p>  <p style="text-align: right;">(R7983)</p>	
3.	<p>Remove the Titanium apatite photocatalytic air-purifying filter.</p>	
1	<p>The Titanium apatite photocatalytic air-purifying filter is attached to the back of the air filter.</p>  <p style="text-align: right;">(R8025)</p>	
2	<p>Remove the Titanium apatite photocatalytic air-purifying filter frame by bending the air filter and unfastening the projections from the air filter frame.</p>  <p style="text-align: right;">(R8026)</p>	
3	<p>Remove the Titanium apatite photocatalytic air-purifying filter from its frame (at 5 positions) by bending it.</p>  <p style="text-align: right;">(R8027)</p>	<ul style="list-style-type: none"> ■ To prevent the damage, do not remove the Titanium apatite photocatalytic air-purifying filter from the frame when cleaning it. ■ The Titanium apatite photocatalytic air-purifying filter is not marked for difference between the right and left sides.

1.2 Removal of Horizontal Blades / Fan Guard

Procedure



Warning

Be sure to wait 10 minutes or more after turning off all power supplies before disassembling work.

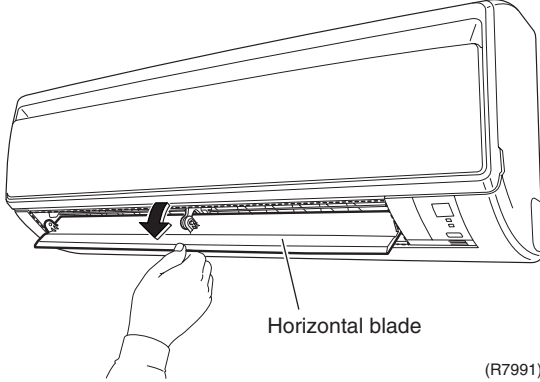
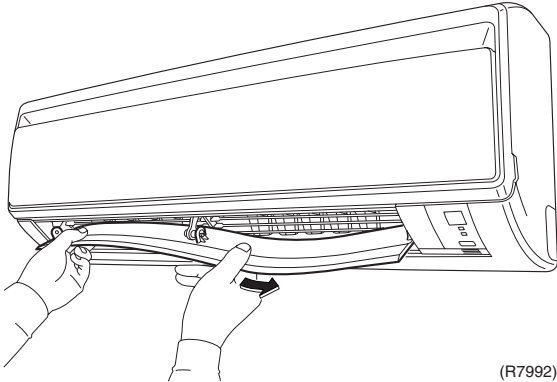
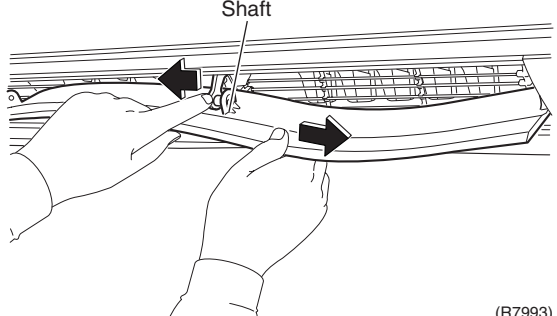
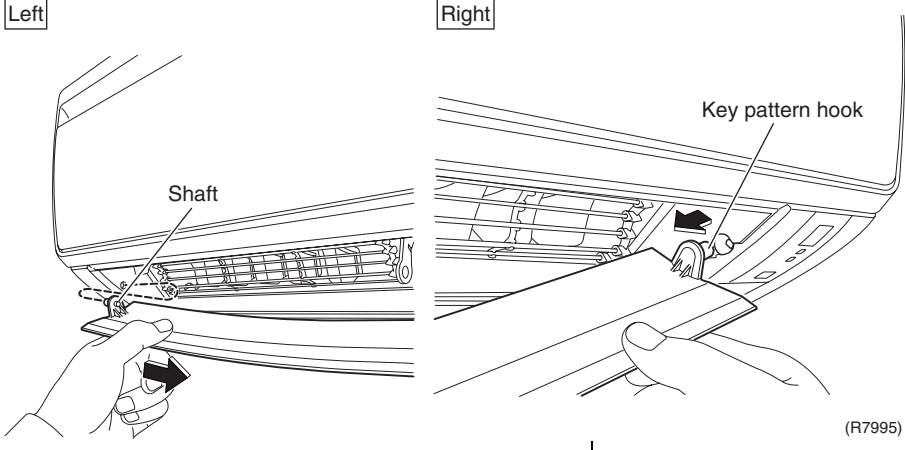
Step	Procedure	Points
1. Remove the horizontal blade.		
1	Open the horizontal blade.	
	 <p style="text-align: right;">(R7991)</p>	
2	Unfasten the center shaft while bending the horizontal blade slightly.	<p>■ The center shaft can be released easily by bending the blade.</p>
	 <p style="text-align: right;">(R7992)</p>  <p style="text-align: right;">(R7993)</p>	<p>Cautions for reassembling</p> <ol style="list-style-type: none"> 1. Since the key pattern hook is provided, rotate the blade and fit it to the right shaft first. 2. Fit the blade to the center and left shafts.
3	Unfasten the left shaft of the horizontal blade.	
4	Unfasten the right shaft of the horizontal blade.	 <p style="text-align: right;">(R7995)</p>

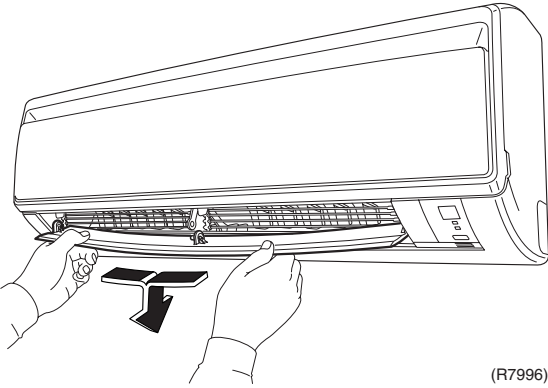
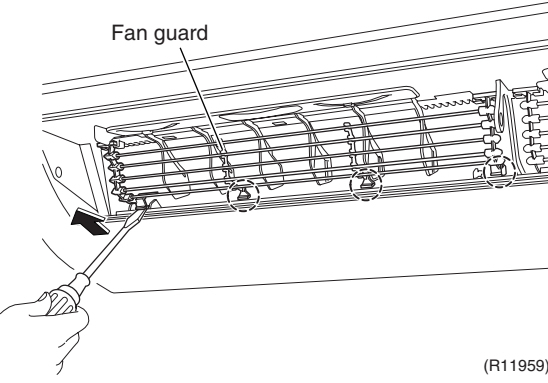
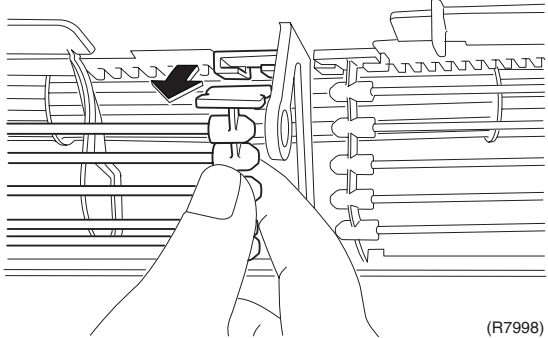
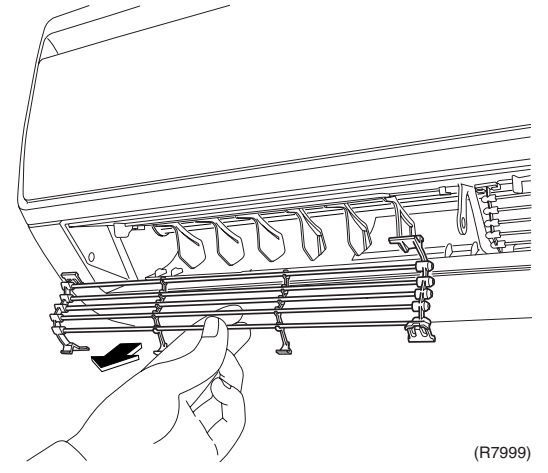
Step	Procedure	Points
5	<p>Remove the horizontal blade.</p>  <p>(R7996)</p>	
2.	<p>Remove the fan guard.</p> <p>1 Unfasten the hooks at the lower part of the fan guard with a flat screwdriver.</p>  <p>(R11959)</p> <p>2 Unfasten the hooks at the upper 2 positions.</p>  <p>(R7998)</p> <p>3 Remove the fan guard.</p>  <p>(R7999)</p>	<p>■ Remove the other fan guard in the same way.</p>

1.3 Removal of Front Panel

Procedure



Warning

Be sure to wait 10 minutes or more after turning off all power supplies before disassembling work.

Step	Procedure	Points	
1	Open the front panel over the position where it stops.	<p>(R7984)</p>	<ul style="list-style-type: none"> ■ The rotary shaft on each side can be released easily by sliding each shaft inwards. ■ When reassembling the front panel, fit the right and left rotary shafts one by one into the grooves and fully push them in position.
2	Release the right rotary shaft.	<p>(R8028)</p>	
3	Release the left rotary shaft.	<p>(R8029)</p>	
4	Remove the front panel.	<p>(R7985)</p>	

1.4 Removal of Front Grille

Procedure



Warning

Be sure to wait 10 minutes or more after turning off all power supplies before disassembling work.

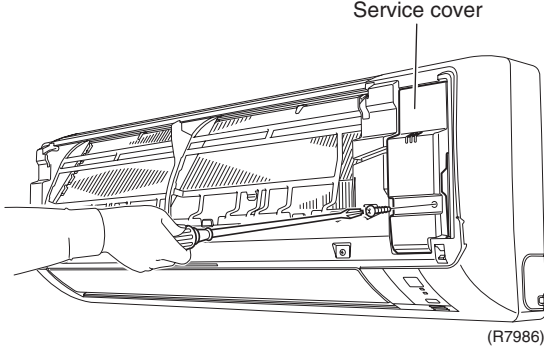
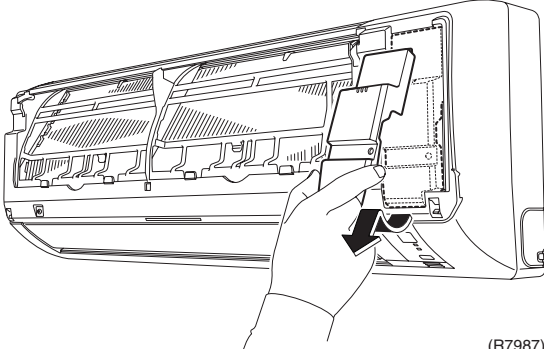
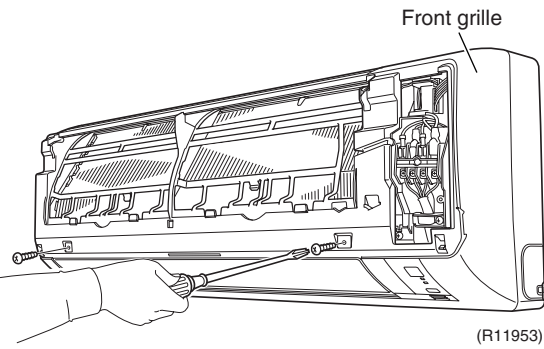
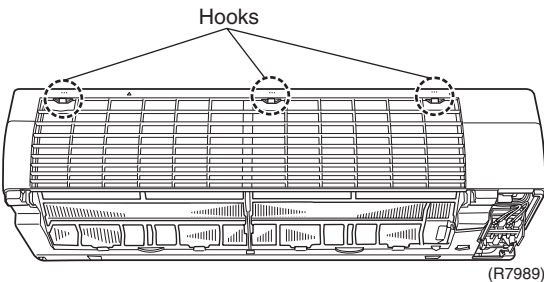
Step	Procedure	Points
<p>1. Remove the service cover.</p> <p>1 Remove the screw of the service cover.</p> <p>2 Pull out the service cover down in the direction of the arrow.</p>	 <p style="text-align: center;">Service cover</p> <p style="text-align: right;">(R7986)</p>  <p style="text-align: right;">(R7987)</p>	<p>Preparation</p> <ul style="list-style-type: none"> ■ Remove the front panel according to the "Removal of Front Panel". ■ You can remove the front grille without detaching the service cover.
<p>2. Remove the front grille.</p> <p>1 Remove the 2 screws, which fix the front grille to the main body.</p> <p>2 The front grille has 3 hooks on the upper part.</p>	 <p style="text-align: center;">Front grille</p> <p style="text-align: right;">(R11953)</p>  <p style="text-align: center;">Hooks</p> <p style="text-align: right;">(R7989)</p>	<ul style="list-style-type: none"> ■ Refer to the removal procedure in a reverse way when reassembling.

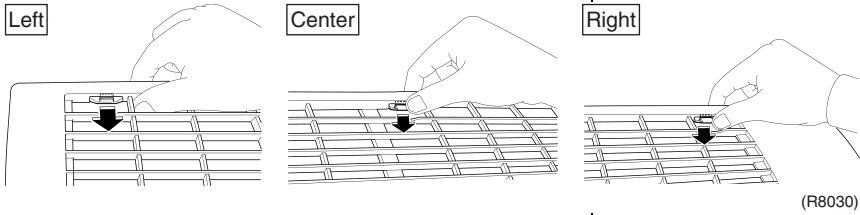
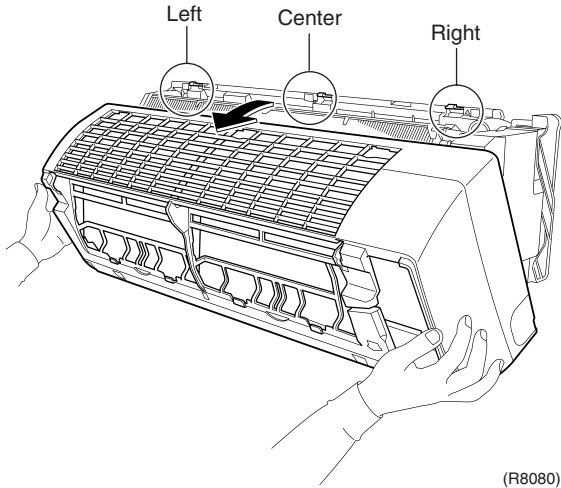
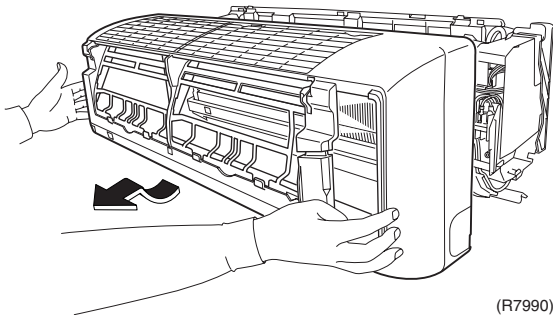
Step	Procedure	Points
3	<p>Press each hook, and also lift the grille up to unfasten the hooks.</p> 	
4	<p>Pull the upper part of the front grille.</p> 	
5	<p>Lift the lower part up and remove the front grille.</p> 	<p>■ When reassembling the front grille, make sure that the hooks are fastened.</p>

1.5 Removal of Electrical Box / Vertical Blades

Procedure



Warning

Be sure to wait 10 minutes or more after turning off all power supplies before disassembling work.

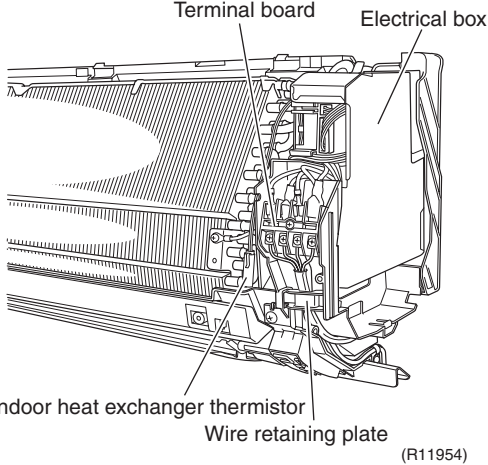
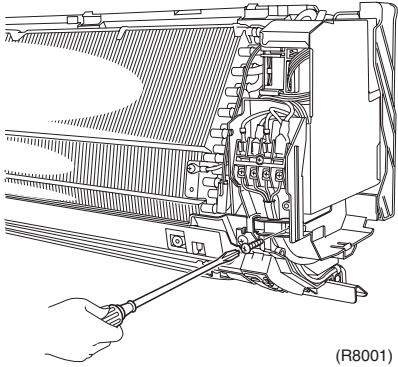
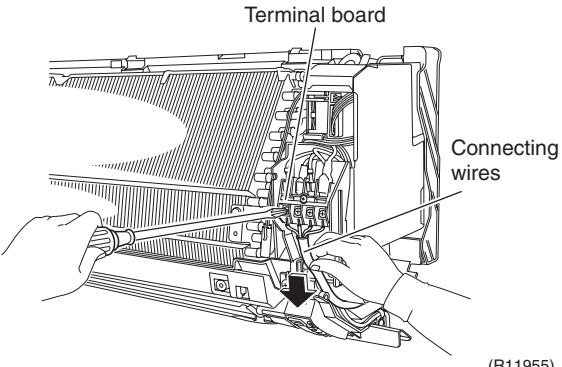
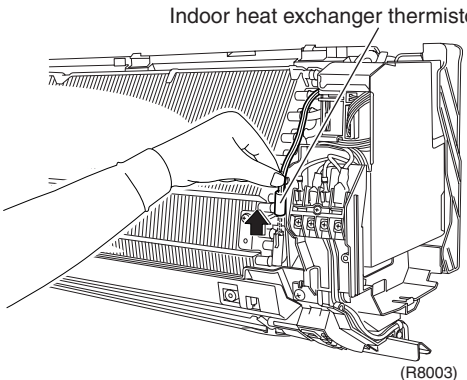
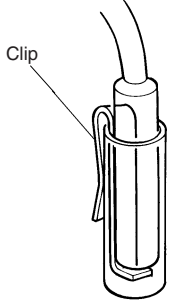
Step	Procedure	Points
1. Disconnect the connecting wires.	 <p>Terminal board Electrical box</p> <p>Indoor heat exchanger thermistor</p> <p>Wire retaining plate (R11954)</p>	<p>Preparation</p> <ul style="list-style-type: none"> Remove the front grille according to the "Removal of Front Grille".
1 The figure shows the connections of wire harnesses.		
2 Remove the screw of the wire retaining plate.	 <p>(R8001)</p>	
3 Loosen the screws of the terminal board and disconnect the connecting wires.	 <p>Terminal board</p> <p>Connecting wires</p> <p>(R11955)</p>	<ul style="list-style-type: none"> (1) Black - Power Supply (2) White - Power Supply (3) Red - Signal
4 Pull out the indoor heat exchanger thermistor.	 <p>Indoor heat exchanger thermistor</p> <p>(R8003)</p>	<ul style="list-style-type: none"> Take care not to lose the clip of thermistor.  <p>Clip</p> <p>(R11268)</p>

Step	Procedure	Points
2.	Remove the electrical box.	
1	Remove the screw and disconnect the earth wire.	
2	Disconnect the connector for fan motor [S200].	
3	Remove the screw of the electrical box.	
4	Slide the electrical box to the right first and detach the horizontal blade from the electrical box.	
5	Pull the electrical box.	

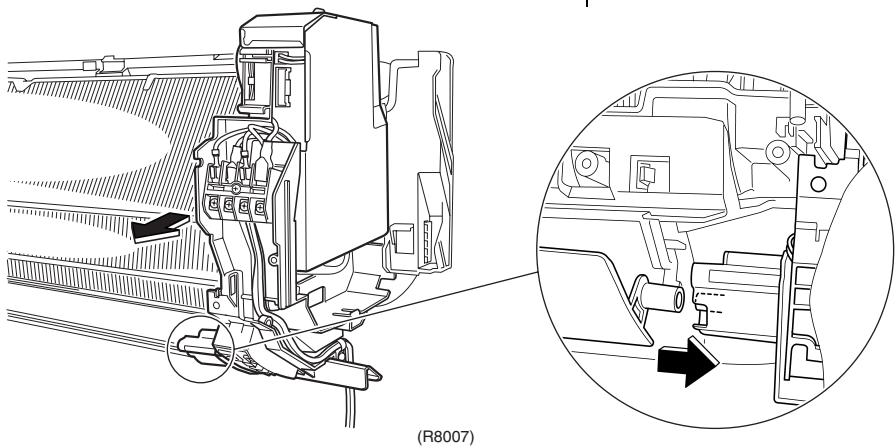
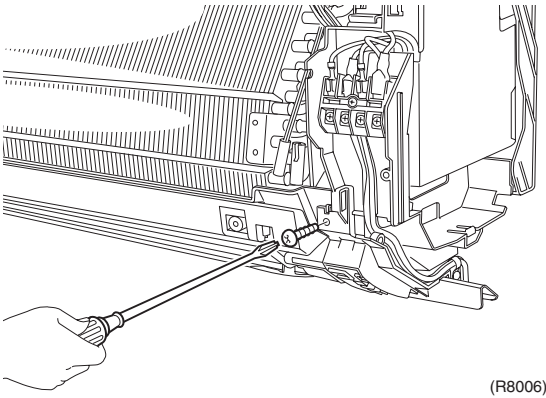
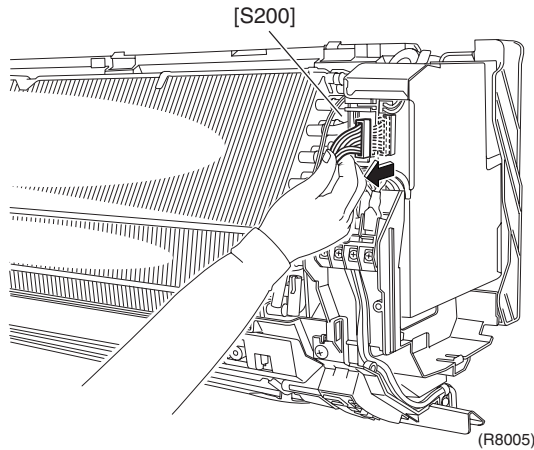
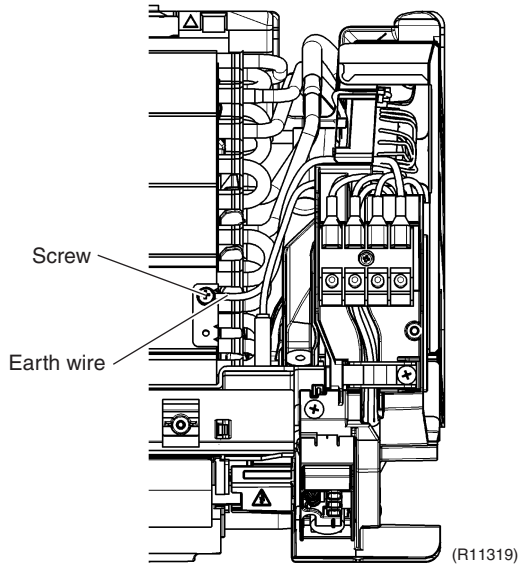

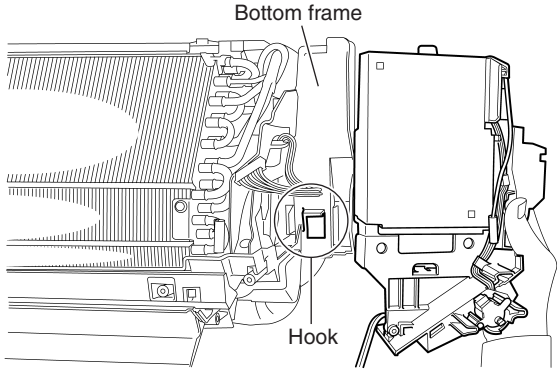
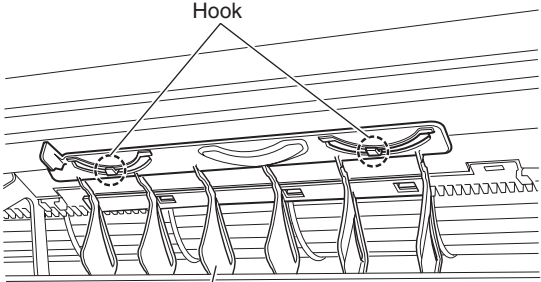
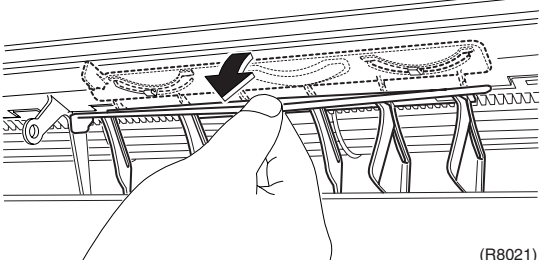
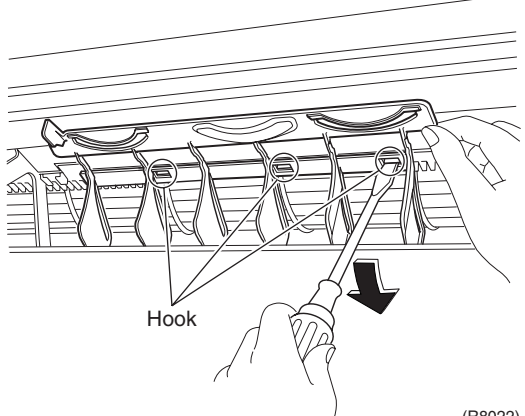
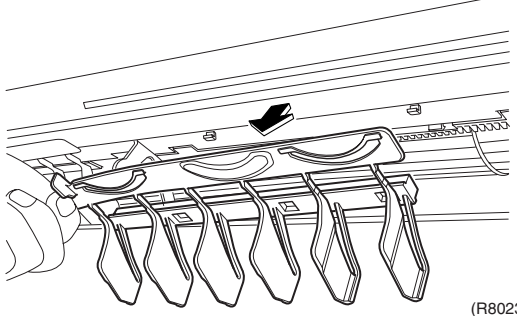
Step	Procedure	Points
	 <p style="text-align: center;">Bottom frame</p> <p style="text-align: center;">Hook</p> <p style="text-align: right;">(R8031)</p>	<ul style="list-style-type: none"> ■ There is a hook on the bottom frame. When reassembling, fit the rear side of the electrical box to the hook.
<p>3. Remove the vertical blade ASSY.</p>		<ul style="list-style-type: none"> ■ A vertical blade ASSY has 6 fins. It is impossible to replace only one fin. ■ The vertical blade ASSY is not marked for difference between right and left.
<p>1 Unfasten the hooks at the upper 2 positions.</p>	 <p style="text-align: center;">Hook</p> <p style="text-align: center;">Vertical blade ASSY</p> <p style="text-align: right;">(R8020)</p>  <p style="text-align: right;">(R8021)</p>	
<p>2 Unfasten the 3 hooks at the shaft mounting part by pressing them with a flat screwdriver.</p>	 <p style="text-align: center;">Hook</p> <p style="text-align: right;">(R8022)</p>	
<p>3 Remove the vertical blade ASSY.</p>	 <p style="text-align: right;">(R8023)</p>	<ul style="list-style-type: none"> ■ Repeat the same procedure to remove the vertical blade ASSY on the other side.

1.6 Removal of PCB / Swing Motor

Procedure



Warning

Be sure to wait 10 minutes or more after turning off all power supplies before disassembling work.

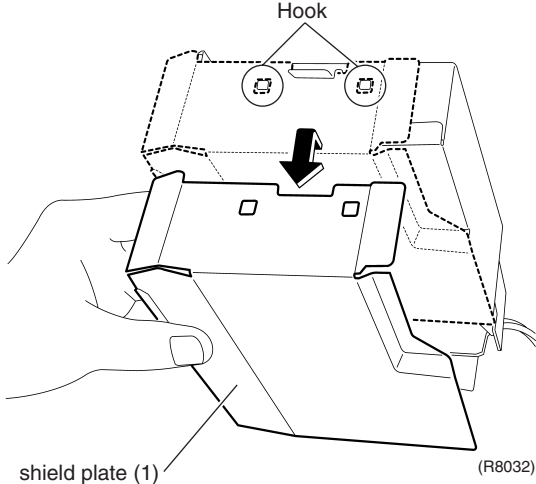
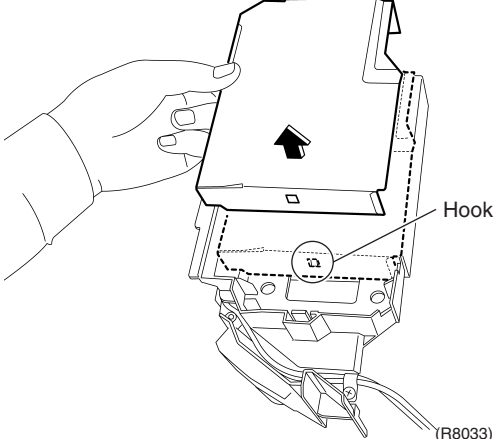
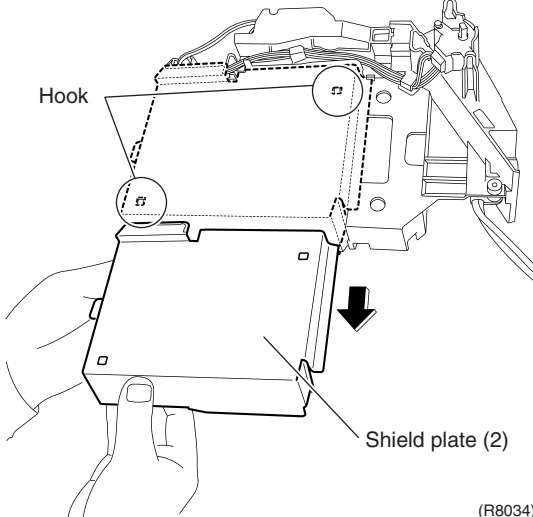
Step	Procedure	Points
1. Remove the shield plate.		Preparation ■ Remove the electrical box according to the "Removal of Electrical Box".
1	Unfasten the hooks at the upper 2 positions of the shield plate.	
2	Unfasten the hook at the lower position, and remove the shield plate (1).	
3	Lift the shield plate (2) and unfasten the 2 hooks.	
4	Slide the shield plate (2) and remove it.	

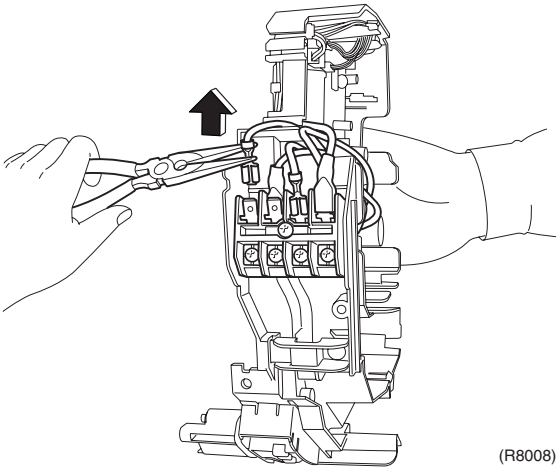
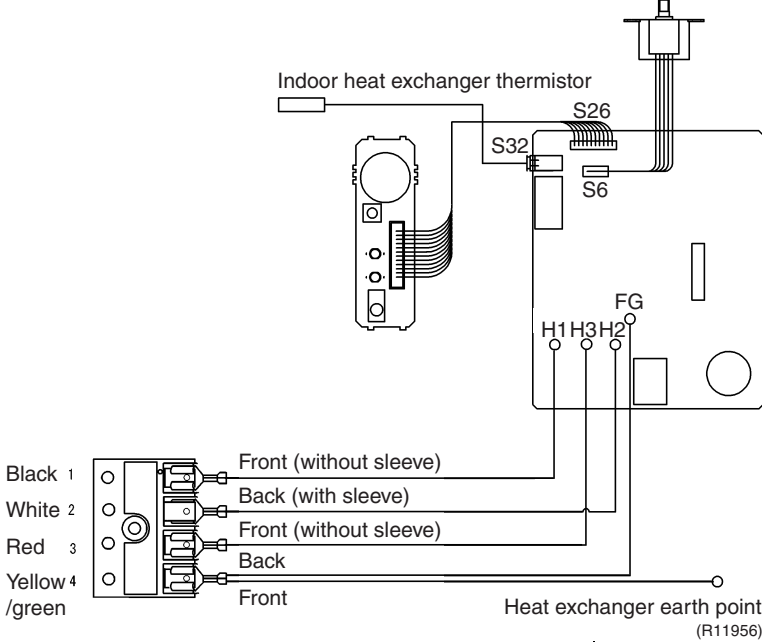
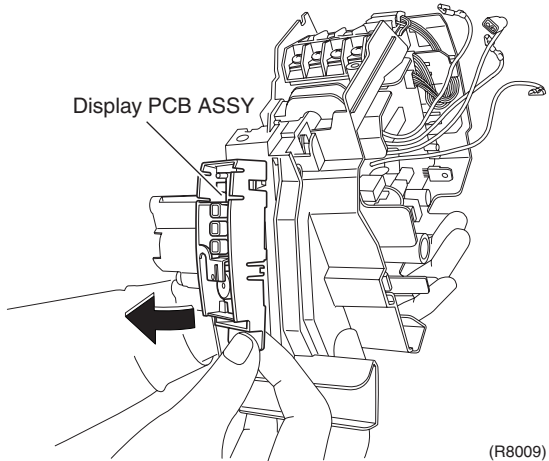
Step	Procedure	Points
5	<p>Disconnect the wire harnesses from the terminal board with pliers.</p>  <p>(R8008)</p>  <p>Indoor heat exchanger thermistor</p> <p>S26 S32 S6</p> <p>H1 H3 H2 FG</p> <p>Black 1 Front (without sleeve) White 2 Back (with sleeve) Red 3 Front (without sleeve) Yellow 4 Back /green Front</p> <p>Heat exchanger earth point (R11956)</p>	
2. Remove the display PCB.		
1	<p>Lift the lower part of the display PCB ASSY to remove.</p>  <p>Display PCB ASSY</p> <p>(R8009)</p>	

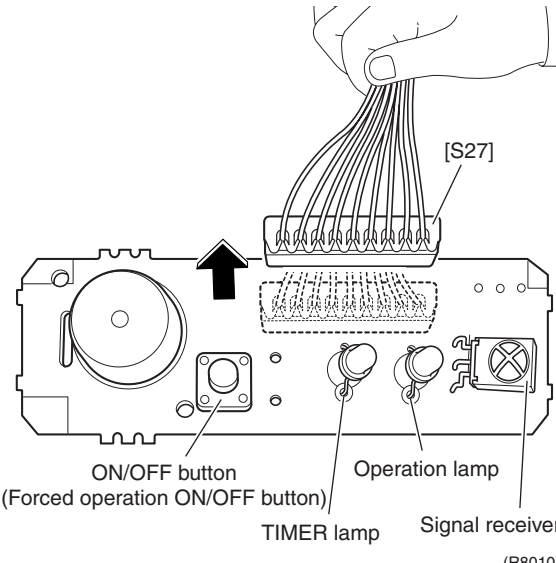
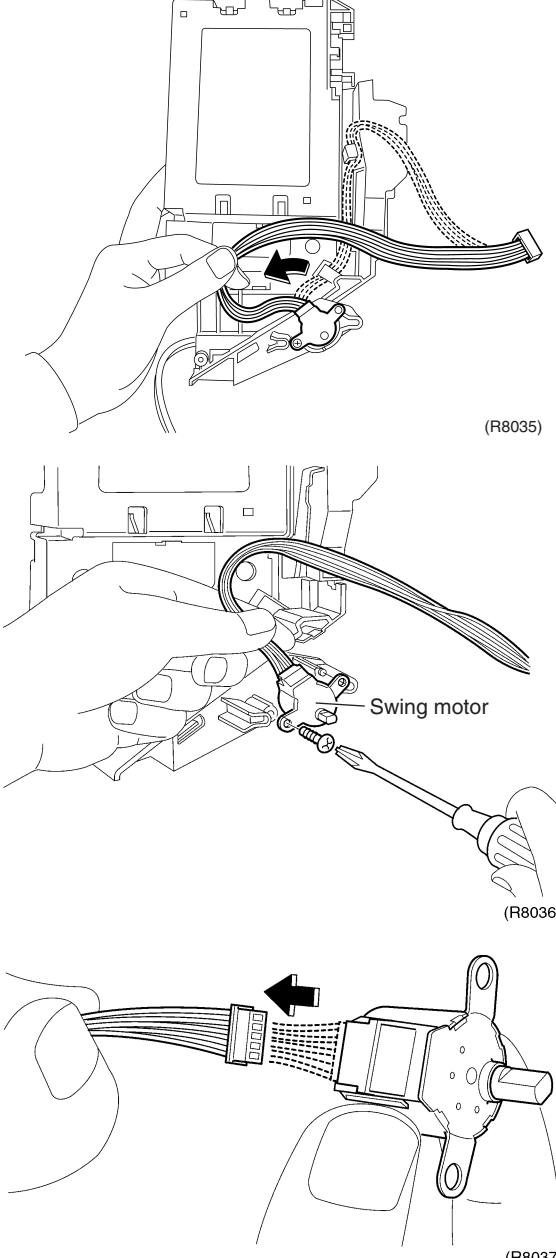
Step	Procedure	Points
<p>2 Disconnect the connector [S27] from the display PCB.</p> <p>3 The figure shows the names of the display PCB component parts.</p>	 <p>[S27]</p> <p>ON/OFF button (Forced operation ON/OFF button)</p> <p>Operation lamp</p> <p>TIMER lamp</p> <p>Signal receiver</p> <p>(R8010)</p>	<p>[S27]: control PCB</p>
<p>3. Remove the swing motor.</p> <p>1 Release the harness from the hooks.</p> <p>2 Remove the screw of the swing motor.</p> <p>3 Disconnect the connector.</p>	 <p>(R8035)</p> <p>Swing motor</p> <p>(R8036)</p> <p>(R8037)</p>	

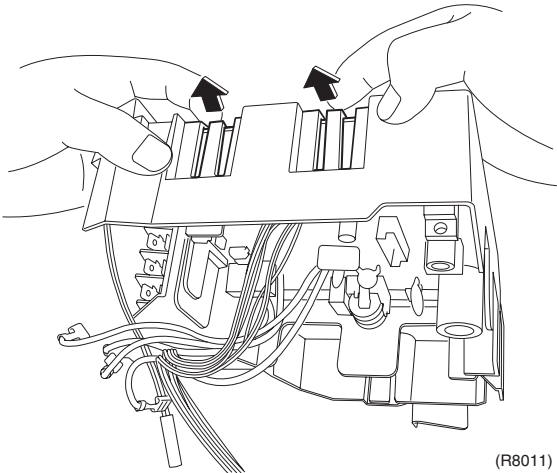
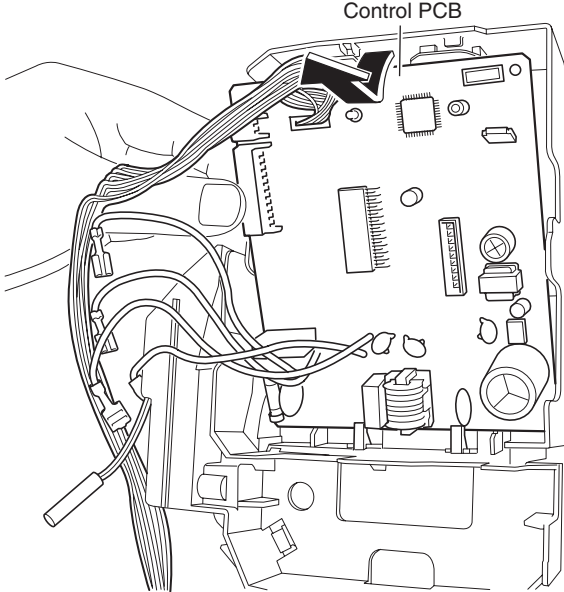
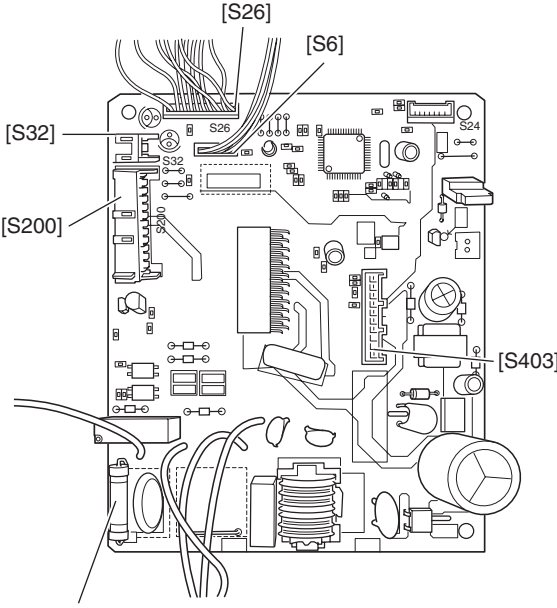
Step	Procedure	Points
4	<p>Unfasten the 2 hooks at the upper part from the rear side.</p>  <p>(R8011)</p>	
5	<p>Lift up the upper part of the control PCB, and remove it.</p>  <p>Control PCB</p> <p>(R8012)</p>	
6	<p>The figure shows the names of the control PCB component parts.</p>  <p>[S26]</p> <p>[S6]</p> <p>[S32]</p> <p>[S200]</p> <p>[S403]</p> <p>Fuse (250V, 3.15A)</p> <p>(R8013)</p>	<p>[S6]: swing motor [S26]: display PCB [S32]: indoor heat exchanger thermistor [S200]: fan motor [S403]: adaptor PCB (option)</p>

1.7 Removal of Indoor Heat Exchanger

Procedure



Warning

Be sure to wait 10 minutes or more after turning off all power supplies before disassembling work.

Step	Procedure	Points
1. Disconnect the refrigerant piping.	<p>(R8014)</p>	<p>Preparation</p> <ul style="list-style-type: none"> Remove the electrical box according to the "Removal of Electrical Box".
1 Remove the screws which fix the indoor heat exchanger to the installation plate.	<p>Wooden base</p> <p>(R8015)</p>	<p>Caution</p> <p>For pump down operation, be sure to stop the compressor before disconnecting the refrigerant pipe. If the refrigerant pipe is disconnected with the compressor running and the stop valve opened, air may be sucked in to generate an over-pressure in refrigeration cycle, thus resulting in pipe rupture or accidental injury.</p>
2 Lift the indoor unit with a wooden base.	<p>Drain hose</p> <p>Extension drain hose</p> <p>Connecting wires</p> <p>(R8016)</p>	<ul style="list-style-type: none"> If the drain hose is embedded in the wall, disconnect the drain hose beforehand.
3 Place a plastic sheet under the drain pan as remaining drain may leak.	<p>(R8017)</p>	<p>Caution</p> <p>From the viewpoint of global environment protection, make sure to use a vacuum pump for air purging.</p>
4 Disconnect the flare nut for gas piping with 2 wrenches.		

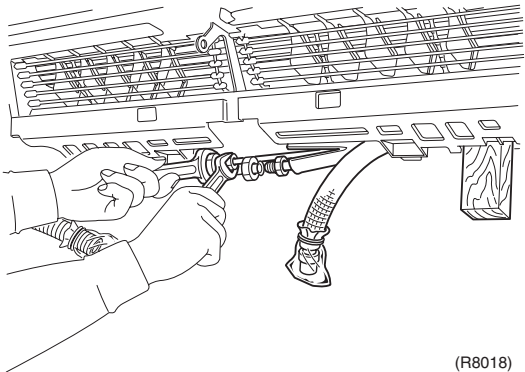
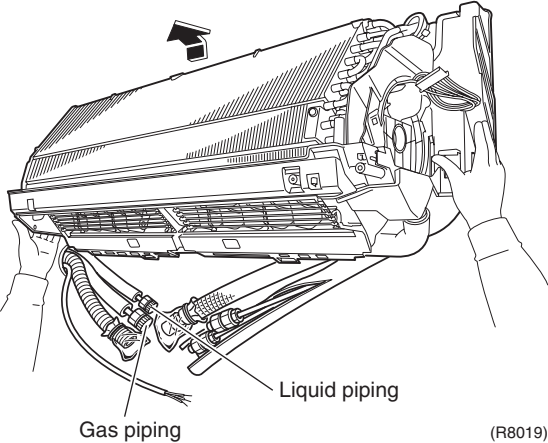
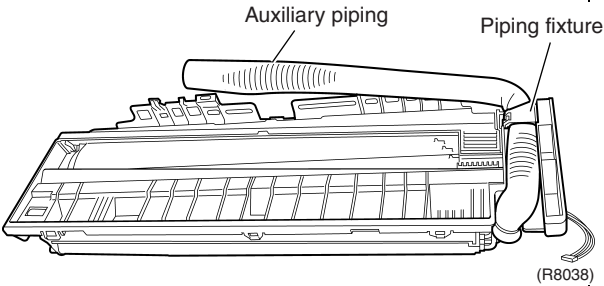
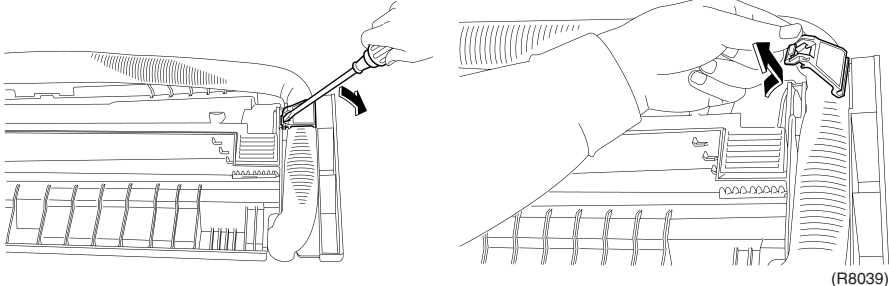
Step	Procedure	Points
5	<p>Disconnect the flare nut for liquid piping with 2 wrenches.</p>  <p>(R8018)</p>	
2. Remove the indoor unit.	<p>1 Remove the indoor unit from the installation plate.</p>  <p>(R8019)</p> <p>2 Unfasten the hook of the piping fixture on the back of the unit.</p>  <p>(R8038)</p>  <p>(R8039)</p>	<p>■ When the pipings are disconnected, protect the both openings from entering moisture.</p>

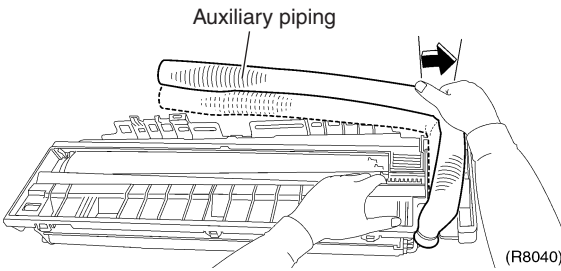
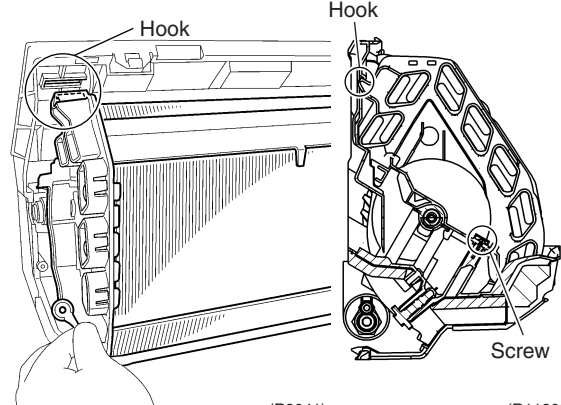
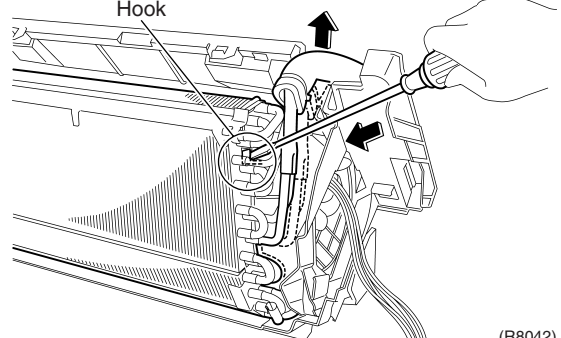
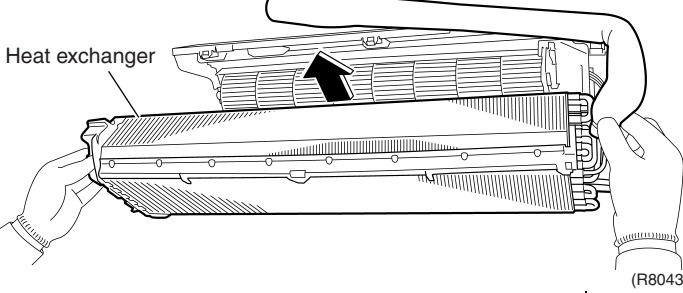
Step	Procedure	Points
3	<p>Widen the auxiliary piping to the extent of 10°~20°.</p> 	
4	<p>Remove the screw on the left side and unfasten the hook on the rear side.</p> 	<p>Caution When removing or reassembling the indoor heat exchanger, be sure to wear gloves or wrap it with cloth before proceeding to the work. (You may be injured by the fins.)</p>
5	<p>Push and unfasten the hook on the right side and lift up the indoor heat exchanger.</p> 	
6	<p>Pull the indoor heat exchanger to the front side to unfasten the hooks completely, and then lift it.</p> 	

1.8 Removal of Fan Rotor

Procedure



Warning

Be sure to wait 10 minutes or more after turning off all power supplies before disassembling work.

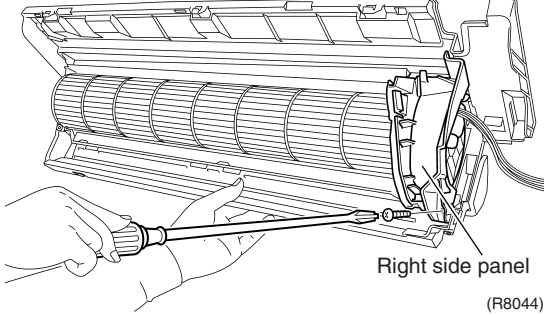
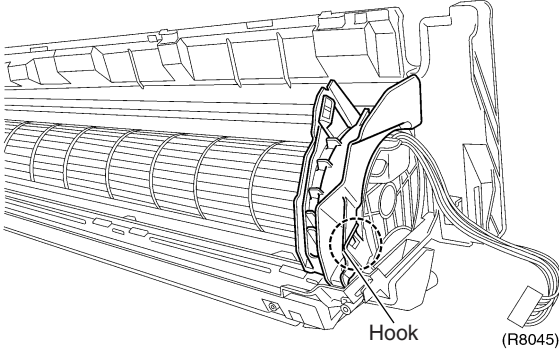
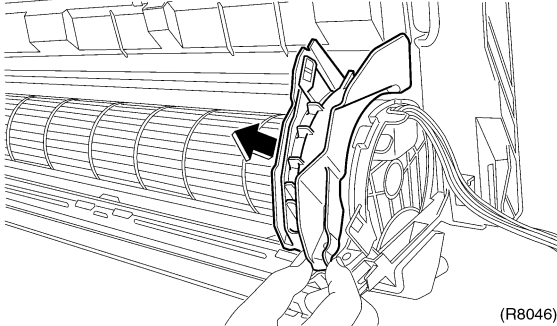
Step	Procedure	Points
1. Remove the right side panel.		<p>Preparation</p> <ul style="list-style-type: none"> Remove the indoor heat exchanger according to the "Removal of Indoor Heat Exchanger".
1	<p>Remove the screw of the right side panel.</p>  <p>Right side panel (R8044)</p>	
2	<p>Unfasten the hook of the right side panel.</p>  <p>Hook (R8045)</p>	
3	<p>Remove the right side panel.</p>  <p>(R8046)</p>	

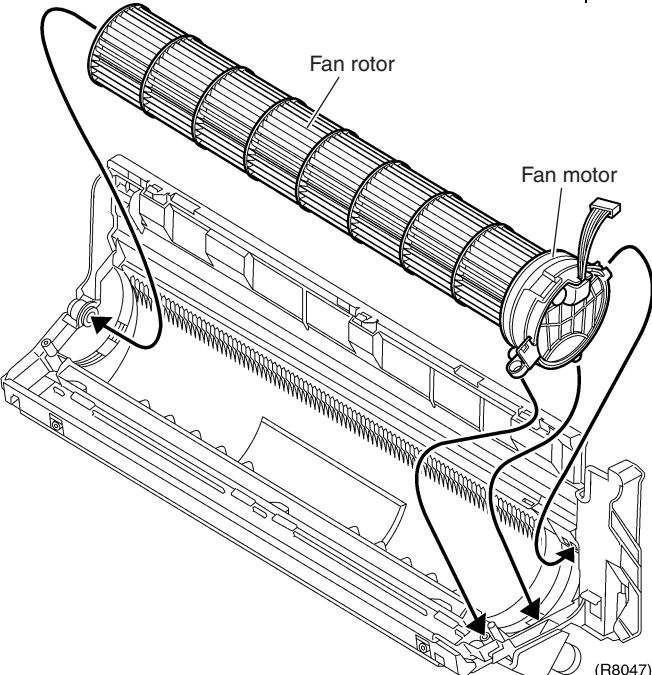
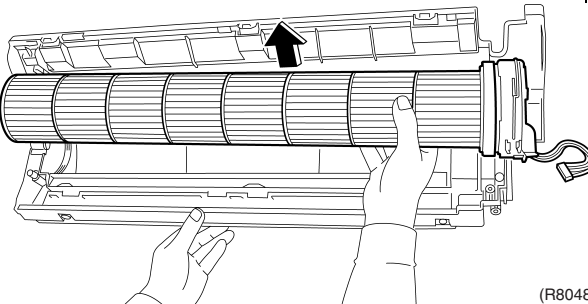
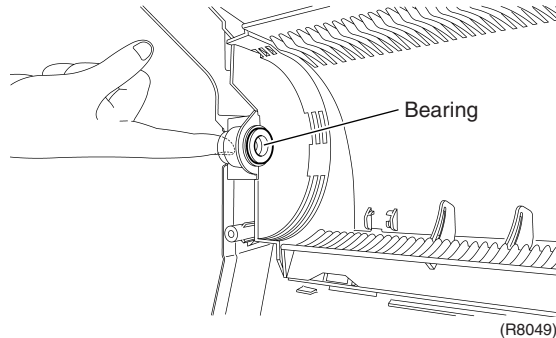
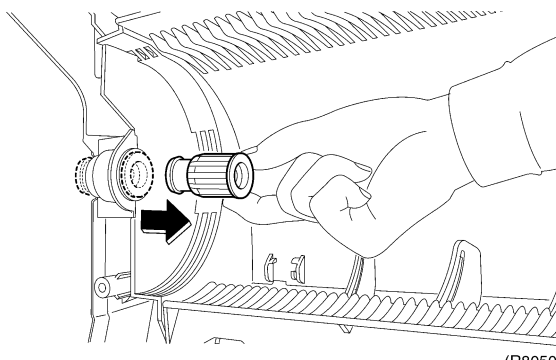
Step	Procedure	Points
2. Remove the fan rotor and fan motor.		
1	<p>The fan motor has 3 projections. The fan rotor has a rotating shaft on the left side.</p>  <p style="text-align: right;">(R8047)</p>	
2	<p>Lift up the right side of the fan rotor and slide it to the right, then remove it.</p>  <p style="text-align: right;">(R8048)</p>	
3	<p>Press the bearing from outside.</p>	
4	<p>Remove the bearing.</p>  <p style="text-align: right;">(R8049)</p>  <p style="text-align: right;">(R8050)</p>	

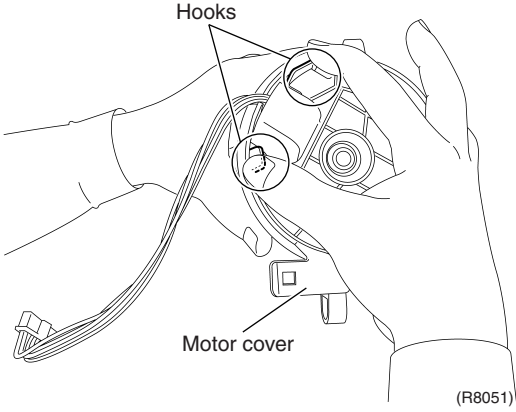
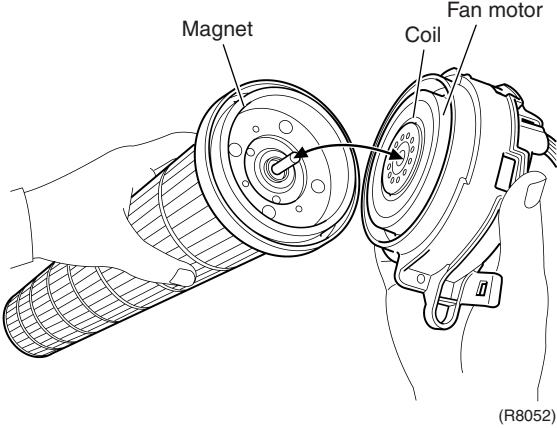
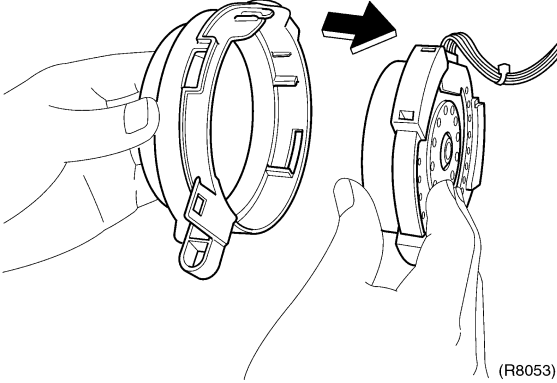
Step	Procedure	Points
5	Unfasten the 2 hooks of the motor cover.	 <p>(R8051)</p>
6	Pull out the fan motor from the fan rotor to remove.	 <p>(R8052)</p>  <p>(R8053)</p> <ul style="list-style-type: none"> ■ The magnet of the fan motor is united with the fan rotor. Be careful not to attract metal waste to the magnet. Keep away from the materials that can be affected by magnetic force also.

1.9 Exchange of Drain Hose

Procedure



Warning

Be sure to wait 10 minutes or more after turning off all power supplies before disassembling work.

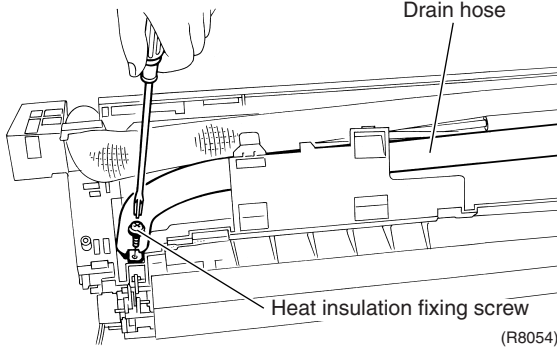
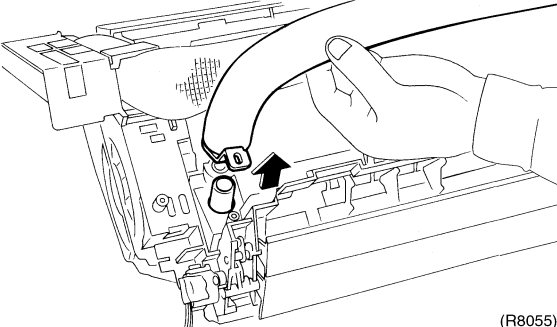
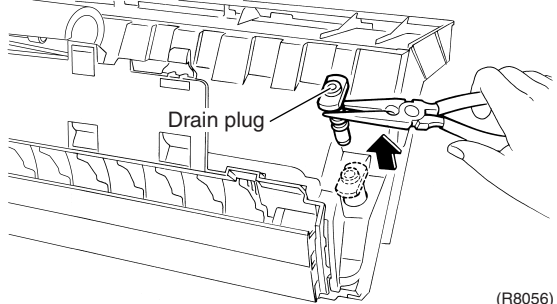
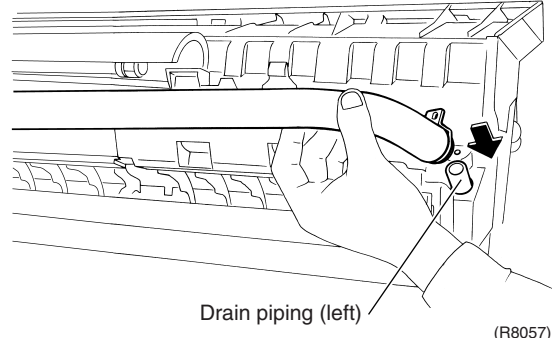
Step	Procedure	Procedure	Points
1	Remove the heat insulation fixing screw on the right side and remove the drain hose.	 	<ul style="list-style-type: none"> After removing the drain hose, to prevent water leakage, make sure to mount the heat insulation fixing screw as it was.
2	Remove the drain plug located at the left side with pliers and press the removed drain plug into the right side with a hexagonal wrench (4 mm).		
3	Insert the drain hose to the left side, and tighten it with the heat insulation fixing screw.		<p>Caution Do not thrust in the drain plug with a sharp-pointed tool like a screwdriver. (The drain plug may be broken, resulting in water leakage.)</p>

2. Outdoor Unit

2.1 Removal of Panels

Procedure

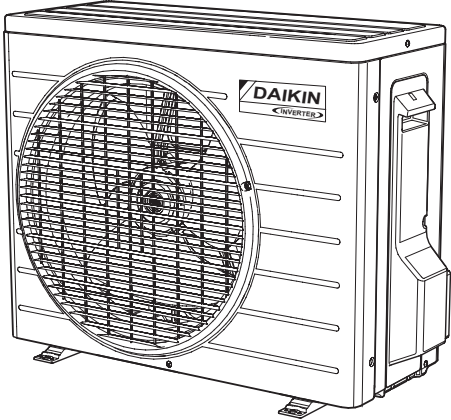
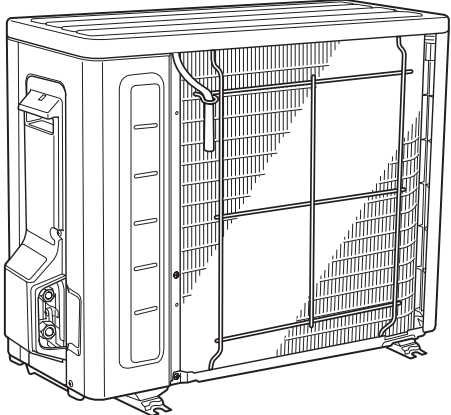
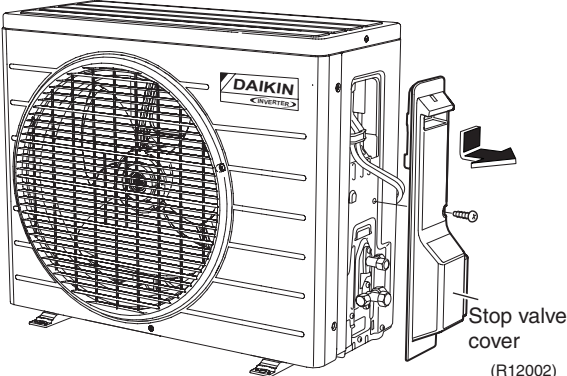
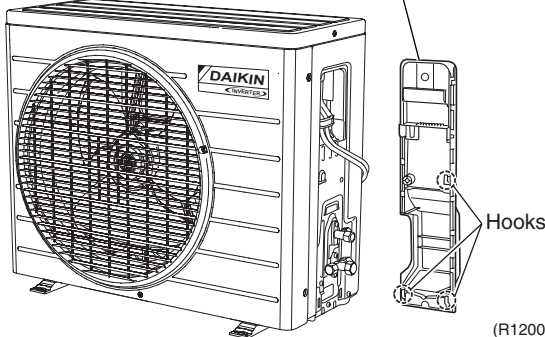

Warning Be sure to wait 10 minutes or more after turning off all power supplies before disassembling work.

Step	Procedure	Points
1. Appearance features	 <p>(R7940)</p>  <p>(R7371)</p>	<ul style="list-style-type: none"> ■ Take care not to cut your finger by the fins of the outdoor heat exchanger.
2. Remove the panels.	<p>1 Remove the screw of the stop valve cover. Pull down the stop valve cover and remove it.</p>  <p>Stop valve cover (R12002)</p>  <p>Shield plate</p> <p>Hooks</p> <p>(R12003)</p>	<ul style="list-style-type: none"> ■ The stop valve cover is united with the shield plate. ■ When reassembling, make sure to fit the 3 hooks.

Step	Procedure	Points
2	Remove the 3 screws (right: 1 screw, left: 2 screws) and remove the top panel.	
3	Remove the 6 screws of the front panel.	
4	Lift up the left side and unfasten the hooks.	
5	Unfasten the right side hooks and remove the front panel.	
6	The discharge grille has 2 projections to prevent rotating. Press the projections from the rear side and rotate the discharge grille.	
7	Unfasten the 6 hooks and remove the discharge grille.	

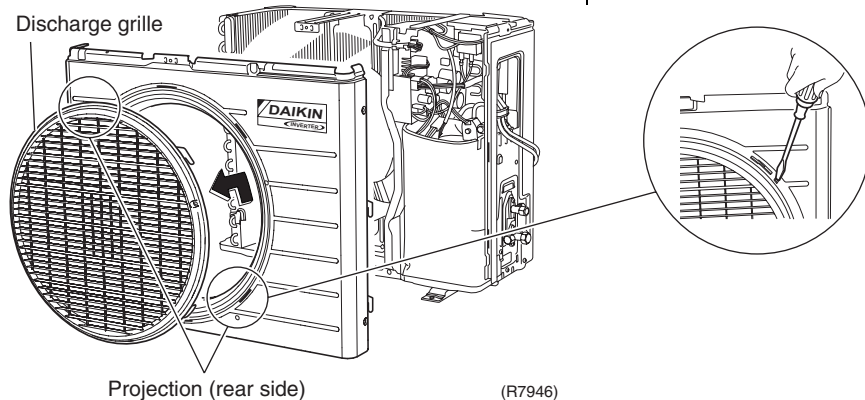
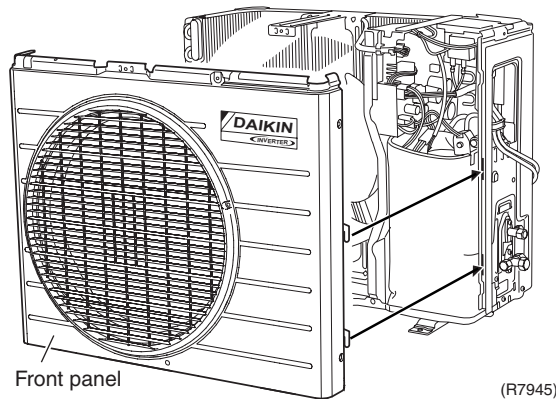
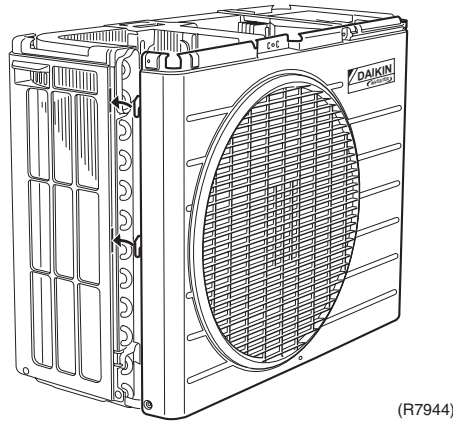
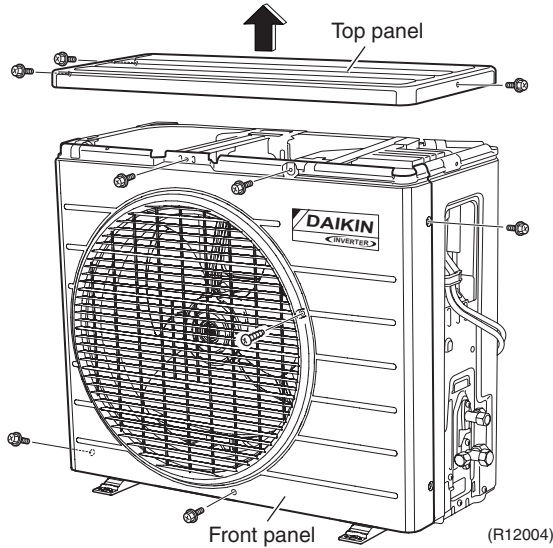

2.2 Removal of Outdoor Fan / Fan Motor

Procedure

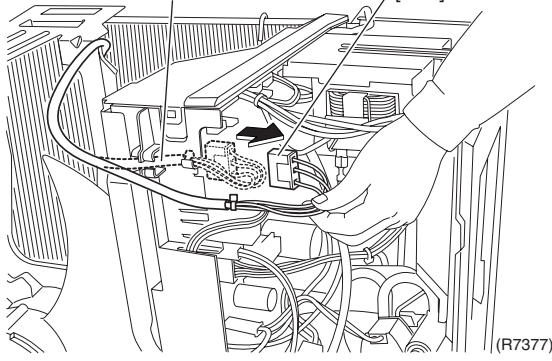
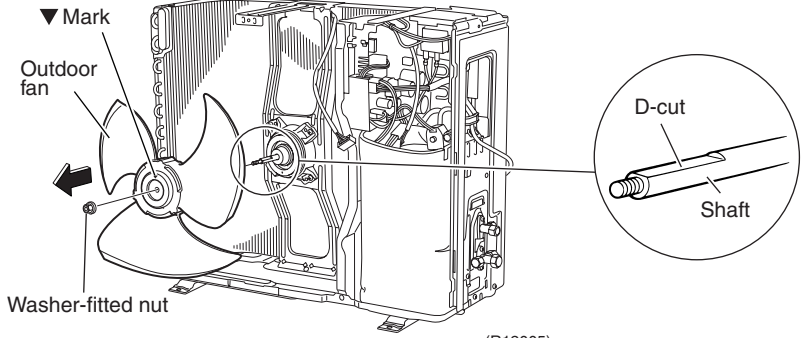
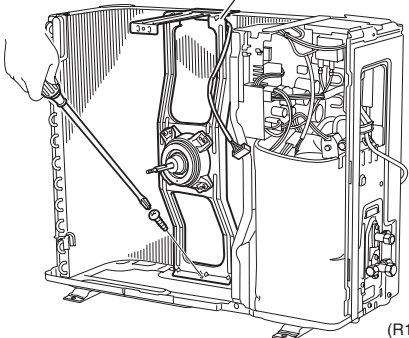
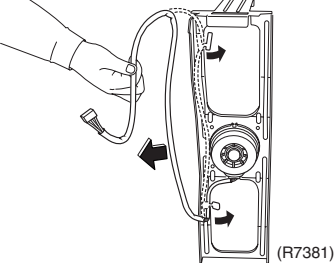
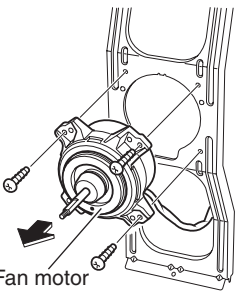
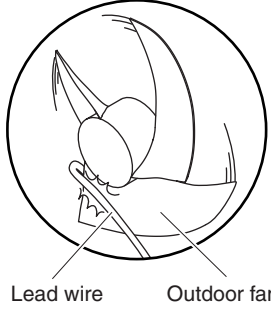

Warning Be sure to wait 10 minutes or more after turning off all power supplies before disassembling work.

Step	Procedure	Points
<p>1. Remove the outdoor fan.</p> <p>1 Disconnect the connector for the fan motor [S70].</p> <p>2 Release the fan motor lead wire from the hooks.</p> <p>3 Release the washer-fitted nut (M6) of the outdoor fan with a spanner.</p> <p>4 Remove the outdoor fan.</p>	<p>Fan motor lead wire [S70]</p>  <p>(R7377)</p>  <p>▼ Mark</p> <p>Outdoor fan</p> <p>Washer-fitted nut</p> <p>D-cut</p> <p>Shaft</p> <p>(R12005)</p>	<p>Preparation</p> <ul style="list-style-type: none"> ■ Remove the panels according to the "Removal of Panels". ■ The screw has reverse winding. ■ Align ▼ mark of the outdoor fan with D-cut section of the motor shaft when mounting. ■ Spanner size: 10 mm
<p>2. Remove the fan motor.</p> <p>1 Remove the screw to remove the fan motor fixing frame.</p> <p>2 Release the fan motor lead wire from the hooks.</p> <p>3 Remove the 3 screws to remove the fan motor.</p>	<p>Fan motor fixing frame</p>  <p>(R11957)</p>  <p>(R7381)</p>  <p>Fan motor</p> <p>(R11958)</p>	<ul style="list-style-type: none"> ■ Put the lead wire through the back of the motor when reassembling. (so as not to be entangled with the outdoor fan)  <p>Lead wire</p> <p>Outdoor fan</p> <p>(R3249)</p>

2.3 Removal of Electrical Box / Control PCB

Procedure

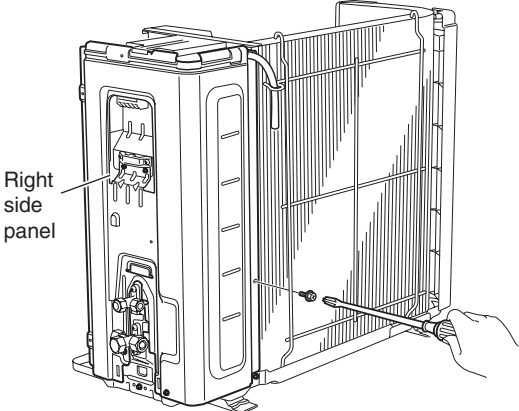
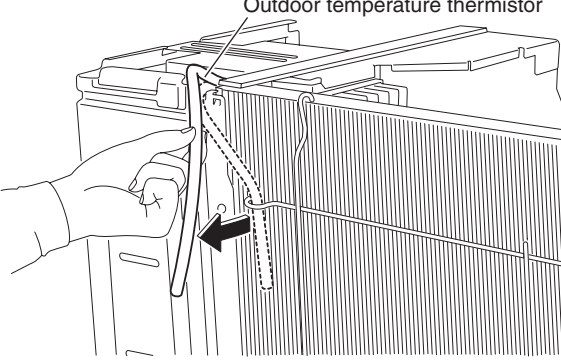
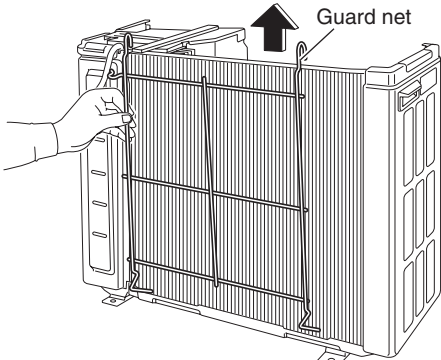
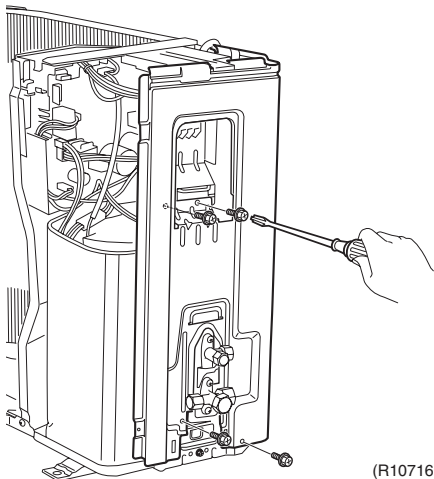

Warning Be sure to wait 10 minutes or more after turning off all power supplies before disassembling work.

Step	Procedure	Points
1. Remove the right side panel.	 <p>(R12019)</p>	<p>Preparation</p> <ul style="list-style-type: none"> Remove the panels according to the "Removal of Panels".
2. Release the outdoor temperature thermistor.	 <p>(R12006)</p>	<ul style="list-style-type: none"> The outdoor temperature thermistor is hooked on the guard net.
3. Lift up the guard net to remove.	 <p>(R7384)</p>	
4. Remove the 4 screws on the right side panel.	 <p>(R10716)</p>	

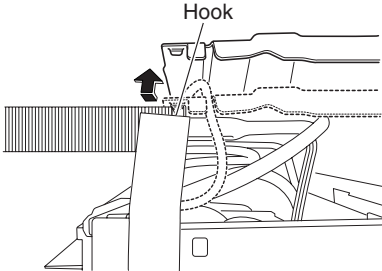
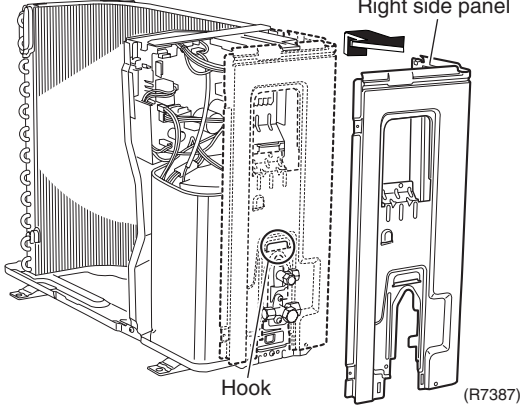
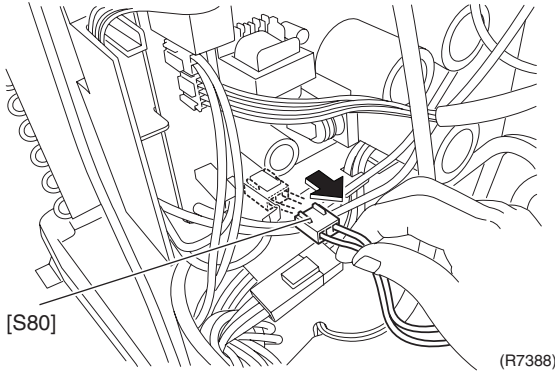
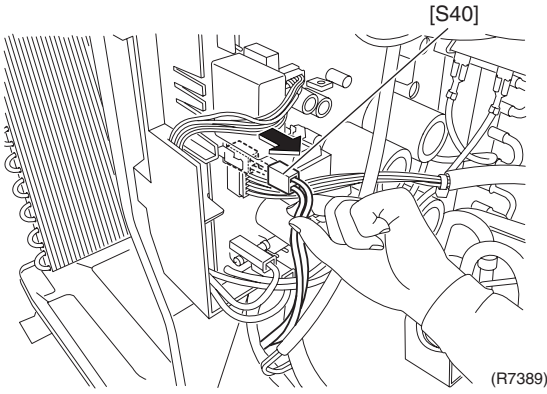
Step	Procedure	Points
5	Unfasten the hook on the rear side.	<ul style="list-style-type: none"> ■ When reassembling, make sure to fit the hook.
6	Unfasten the hook, and lift up the right side panel to remove.	
2. Remove the electrical box.	 <p style="text-align: right;">(R7386)</p>  <p style="text-align: right;">(R7387)</p>	
1	Disconnect the connector for four way valve coil [S80].	 <p style="text-align: right;">(R7388)</p>
2	Disconnect the connector for overload protector [S40].	 <p style="text-align: right;">(R7389)</p>

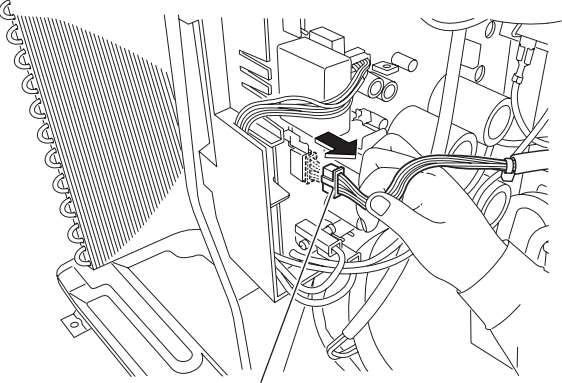
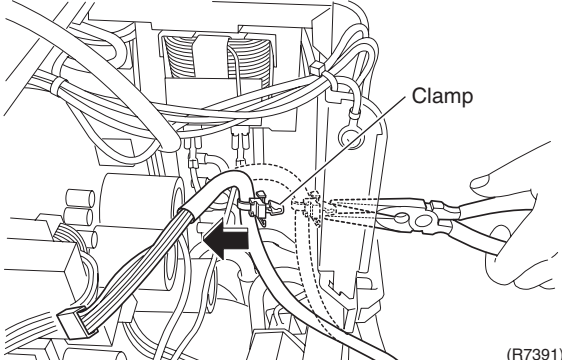
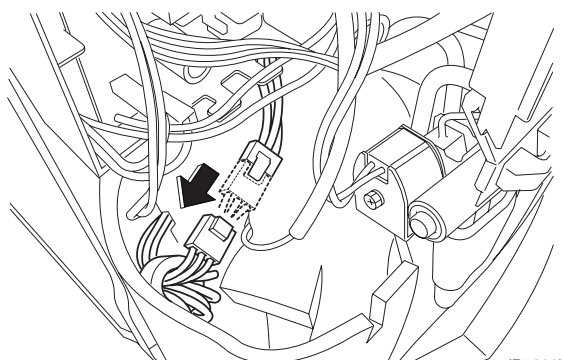
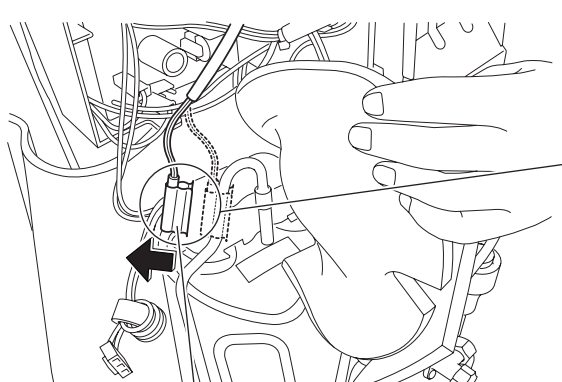
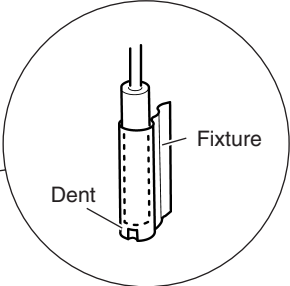
Step	Procedure	Points
3	<p>Disconnect the connector for electronic expansion valve coil [S20].</p>  <p style="text-align: center;">[S20] (R7390)</p>	
4	<p>Detach the clamp of the lead wire for the electronic expansion valve coil.</p>  <p style="text-align: center;">Clamp (R7391)</p>	
5	<p>Disconnect the relay connector for the compressor motor.</p>  <p style="text-align: center;">(R7392)</p>	<ul style="list-style-type: none"> ■ Pay attention so as not to lose the fixture. ■ When reassembling, do not insert the thermistor up to the dent of fixture.
6	<p>Release the discharge pipe thermistor.</p>  <p style="text-align: center;">Discharge pipe thermistor (R7393)</p>	

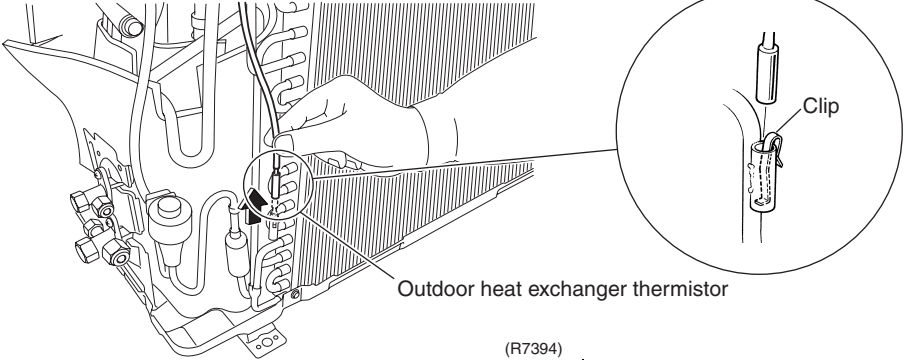
Step	Procedure	Points
7	Pull out the outdoor heat exchanger thermistor.	 <p data-bbox="900 533 1235 555">Outdoor heat exchanger thermistor</p> <p data-bbox="1007 595 1066 613">(R7394)</p>
8	Cut the clamp.	<ul style="list-style-type: none"> ■ Pay attention so as not to lose the clip.
9	Unfasten the hook from the partition plate with a flat screwdriver.	<ul style="list-style-type: none"> ■ The electrical box can be removed by lifting itself without a screwdriver.
10	Lift and remove the electrical box.	

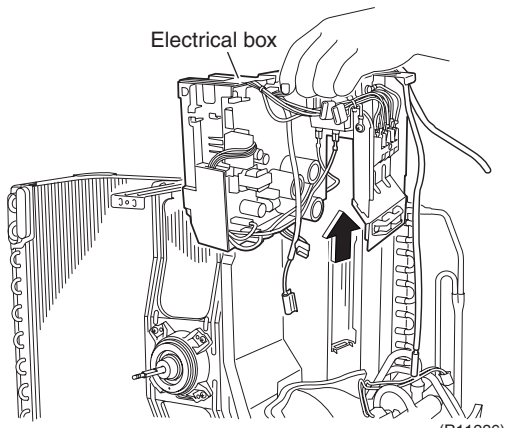
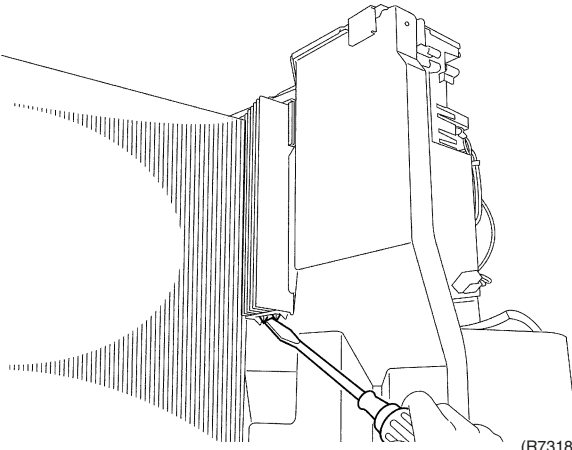
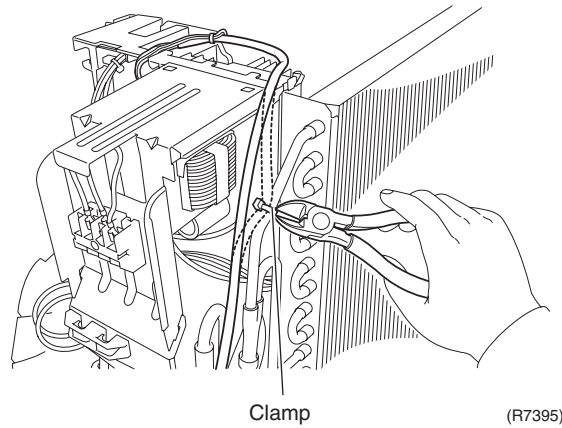
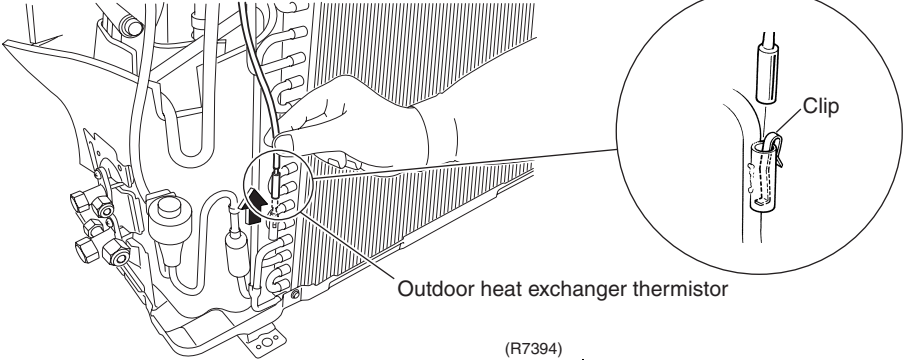

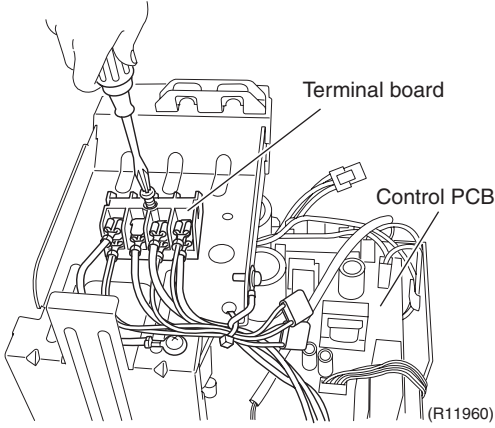
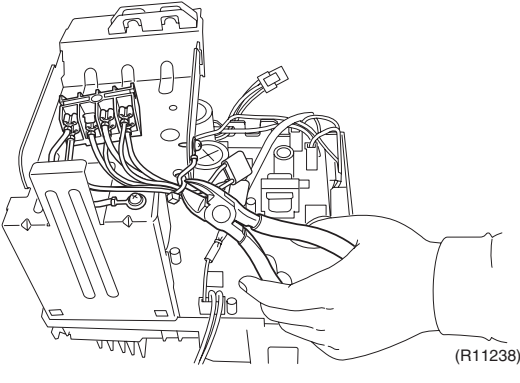
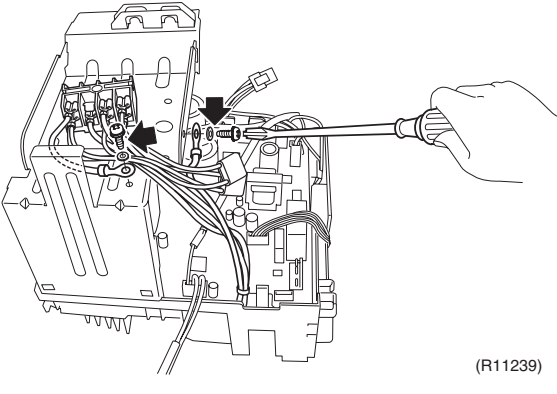
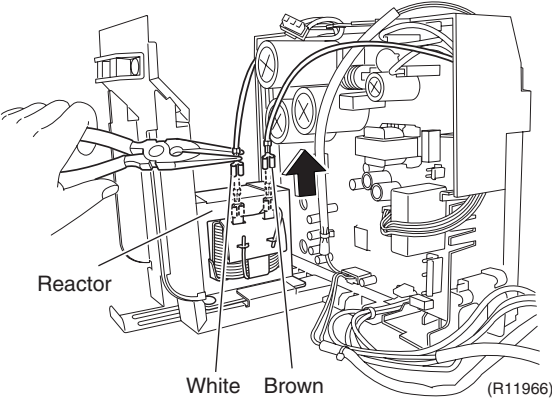
Step	Procedure	Points
3.	Remove the control PCB.	
1	Remove the screw on the terminal board. 	
2	Cut the clamp. 	
3	Remove the 2 screws of the earth terminals. 	
4	Disconnect the 2 terminals of the reactor. 	

Step	Procedure	Points
5	Remove the 3 screws to remove the reactor.	
6	Disconnect the connector for thermistors [S90].	
7	Remove the 6 screws.	
8	Disconnect the 3 connectors for filter PCB [S10] [HN3] [HL3].	

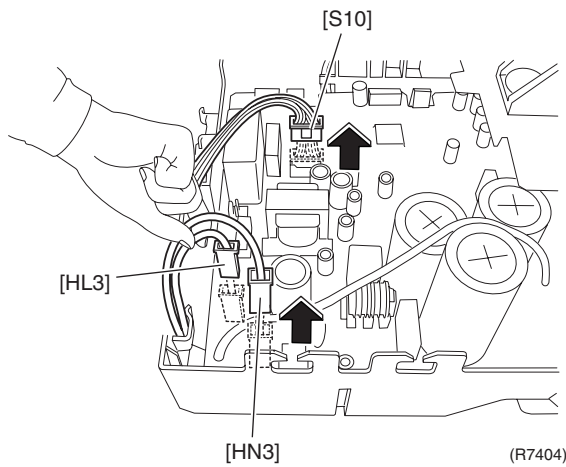
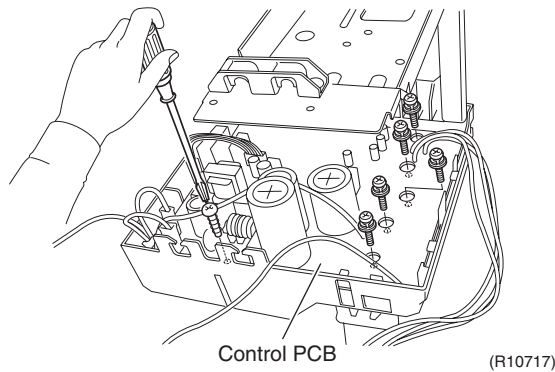
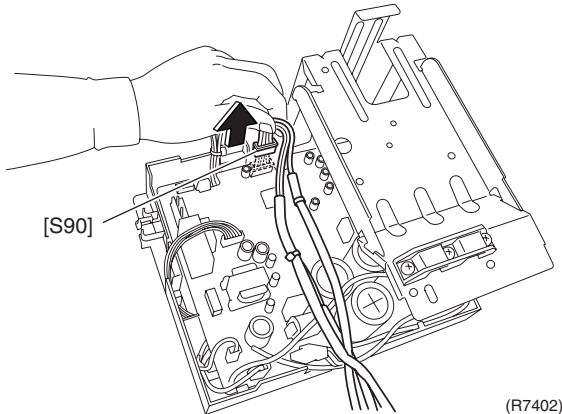
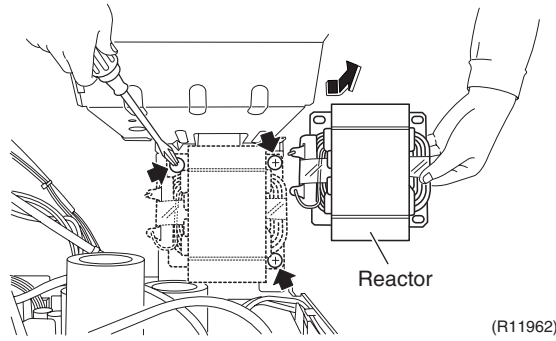

Step	Procedure	Points
9	Unfasten the 2 hooks.	
10	Lift and remove the control PCB.	
11	Feature of the control PCB	

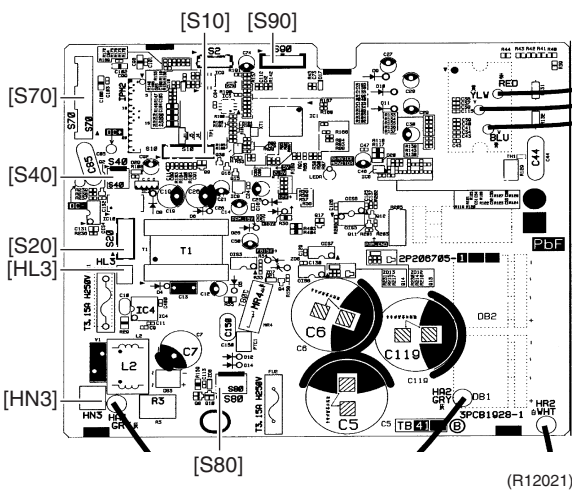
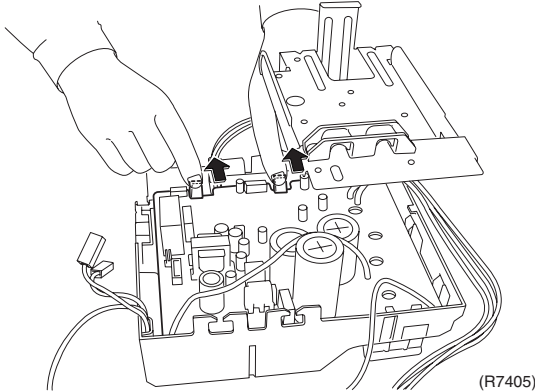

- [S10] [HN3] [HL3]: filter PCB
- [S20]: electronic expansion valve coil
- [S40]: overload protector
- [S70]: fan motor
- [S80]: four way valve coil
- [S90]: thermistors

2.4 Removal of Sound Blanket

Procedure

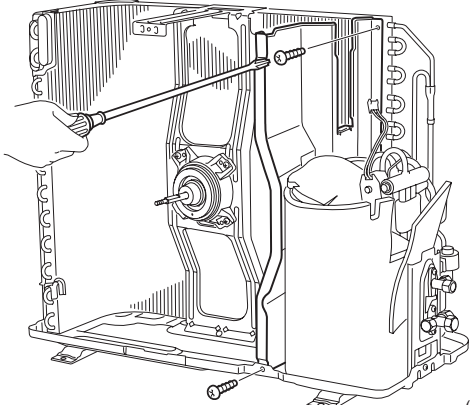
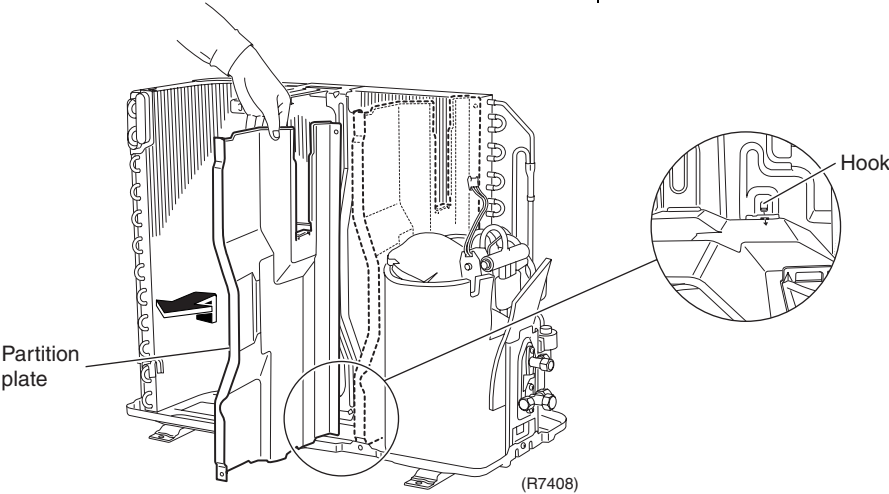
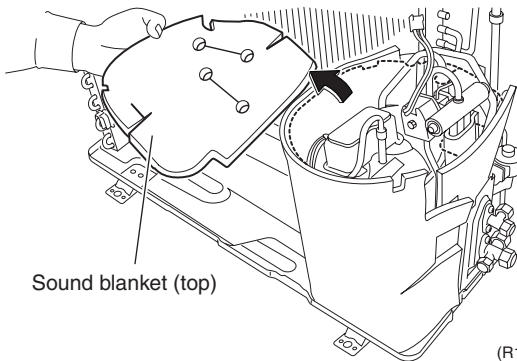

Warning Be sure to wait 10 minutes or more after turning off all power supplies before disassembling work.

Step	Procedure	Points
<p>1. Remove the partition plate.</p> <p>1 Remove the 2 screws.</p> <p>2 The partition plate has a hook on the lower side. Lift and pull the partition plate to remove.</p>	 <p>(R11964)</p>  <p>(R7408)</p>	<ul style="list-style-type: none"> ■ When reassembling, fit the lower hook into the bottom frame.
<p>2. Remove the sound blanket.</p> <p>1 Lift and remove the sound blanket (top).</p>	 <p>(R11963)</p>	<ul style="list-style-type: none"> ■ Since the piping ports on the sound blanket are torn easily, remove the blanket carefully.

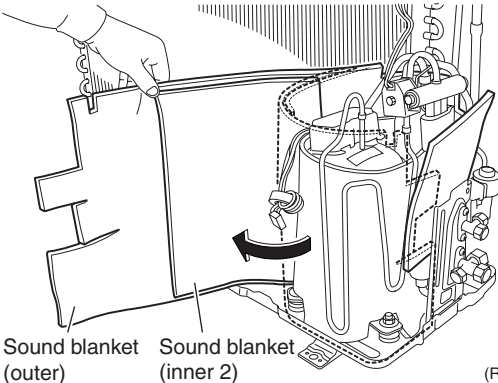
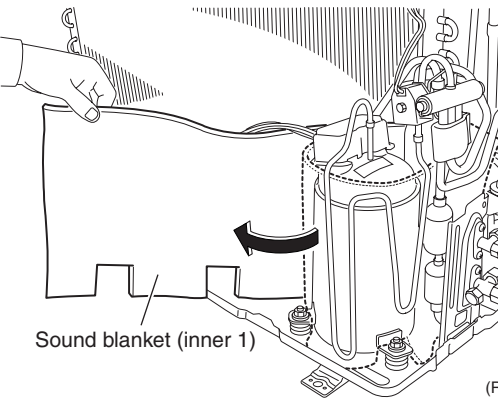
Step	Procedure	Points
2	Pull the sound blankets (outer and inner 2) out.	 <p data-bbox="1007 595 1075 613">(R10720)</p>
3	Pull the sound blanket (inner 1) out.	 <p data-bbox="1007 1025 1075 1043">(R7411)</p> <ul style="list-style-type: none"> <li data-bbox="1094 629 1461 757">■ Since the piping ports on the sound blanket are torn easily, remove the blanket carefully.

2.5 Removal of Four Way Valve

Procedure

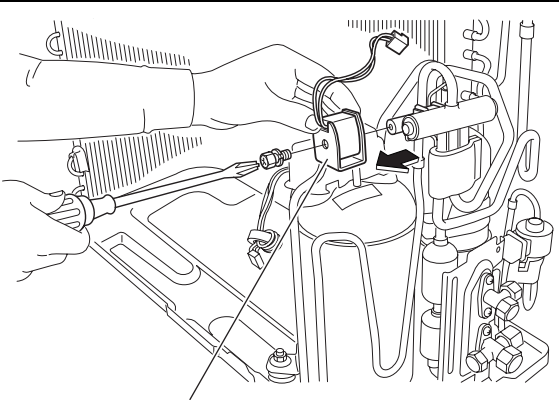
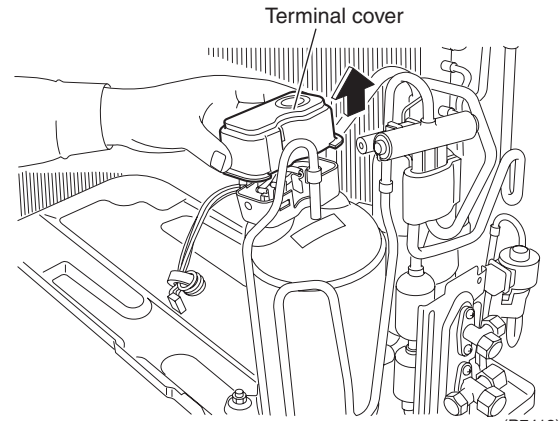
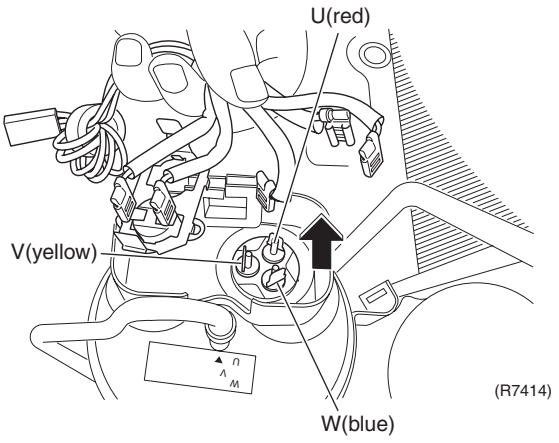
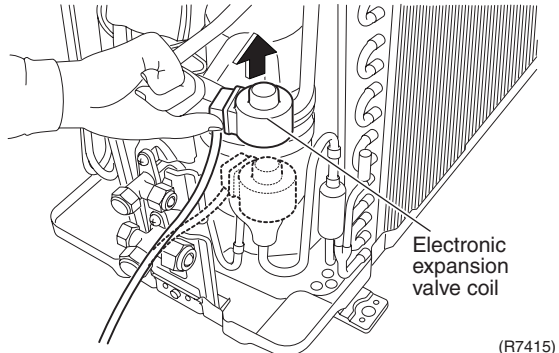

Warning Be sure to wait 10 minutes or more after turning off all power supplies before disassembling work.

Step	Procedure	Points
1. Remove the peripheries.		
1 Remove the screw and remove the four way valve coil.	<p>Four way valve coil (R7412)</p>	
2 Remove the terminal cover.		
2 Remove the terminal cover.	<p>Terminal cover (R7413)</p>	
3 Disconnect the terminals.		
3 Disconnect the terminals.	<p>U(red) V(yellow) W(blue) (R7414)</p>	
4 Remove the electronic expansion valve coil.		
4 Remove the electronic expansion valve coil.	<p>Electronic expansion valve coil (R7415)</p>	

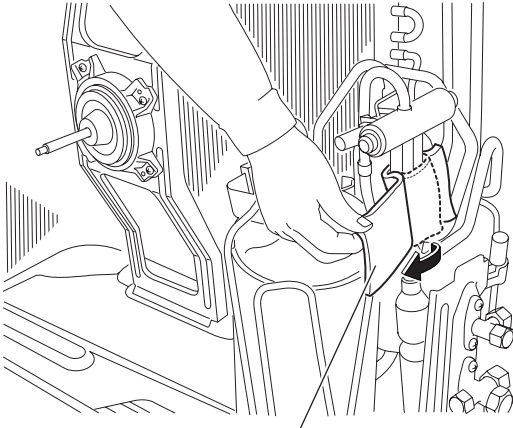
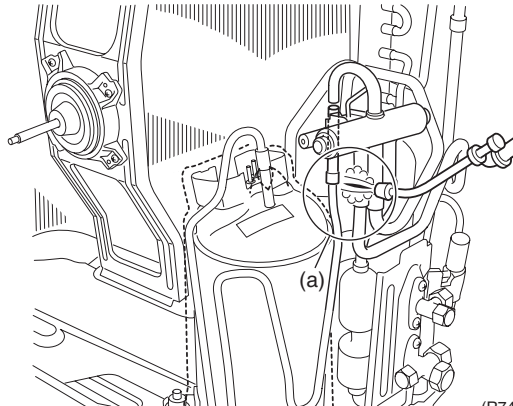
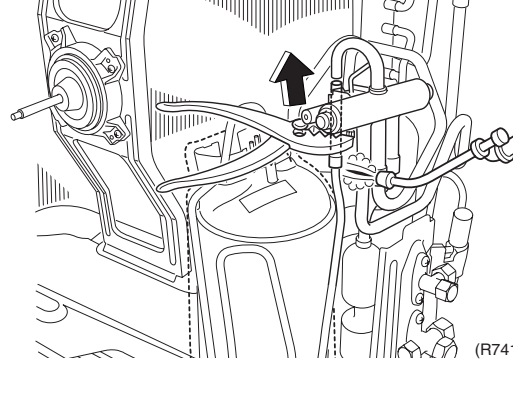
Step	Procedure	Points
5	Remove the putty.  <p style="text-align: center;">Putty (R7416)</p>	
2.	Remove the four way valve. <ul style="list-style-type: none"> ■ Before working, make sure that the refrigerant is empty in the circuit. ■ Be sure to apply nitrogen replacement when heating up the brazed part. 1 Heat up the brazed point (a) and withdraw the piping with pliers.  <p style="text-align: center;">(R7418)</p>  <p style="text-align: center;">(R7419)</p>	<p>⚠ Caution Be careful not to get yourself burnt with the pipes and other parts that are heated by the gas brazing machine.</p> <p>⚠ Caution From the viewpoint of global environment protection, do not discharge the refrigerant gas in the atmosphere. Make sure to recover the refrigerant gas with the recovery system.</p> <p>⚠ Caution From the viewpoint of global environment protection, make sure to use a vacuum pump for air purging.</p> <p>Reassembling precautions</p> <ol style="list-style-type: none"> 1. Use non-oxidizing brazing method. If nitrogen gas is not available, braze the parts speedily. 2. Avoid deterioration of the gaskets due to carbonization of oil inside the four way valve or thermal influence. For this purpose, wrap the four way valve with wet cloth. Splash water over the cloth against becoming too hot (keep it below 120°C). <ul style="list-style-type: none"> ■ In pulling the pipes, be careful not to over-tighten them with pliers. The pipes may get deformed.

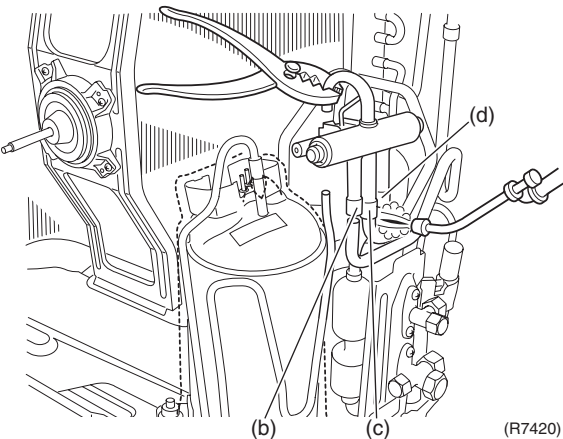
Step	Procedure	Points
2	Heat up the 3 brazed points of the four way valve. Disconnect the point (b) first.	If the gas brazing machine fails to remove the four way valve, take the steps below.
3	Disconnect the points (c) and (d).	<ol style="list-style-type: none"> 1. Disconnect the brazed pipe sections that are easy to separate and join together later. 2. With a tube cutter, cut off the internal pipes to easily take out the four way valve.
<p>Warning</p> <p>If refrigerant gas leaks during the work, ventilate the room. (If the refrigerant gas is exposed to flames, toxic gas may be generated.)</p>		<p>i Note: Do not use a metal saw for cutting pipes by all means because the sawdust comes into the circuit.</p>
		

2.6 Removal of Compressor

Procedure

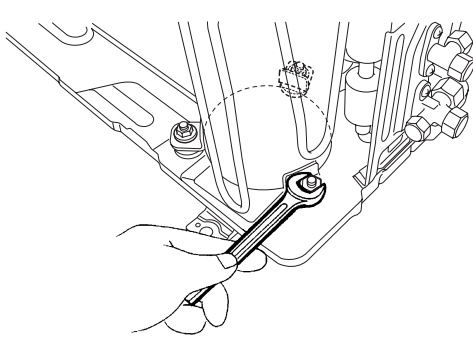
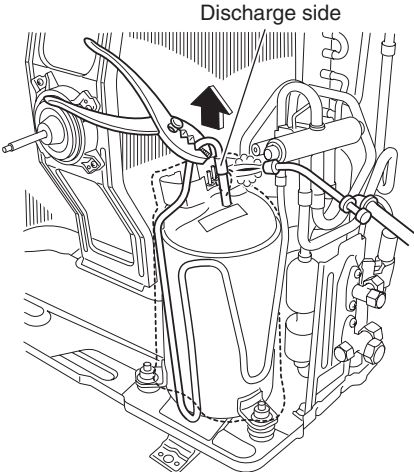
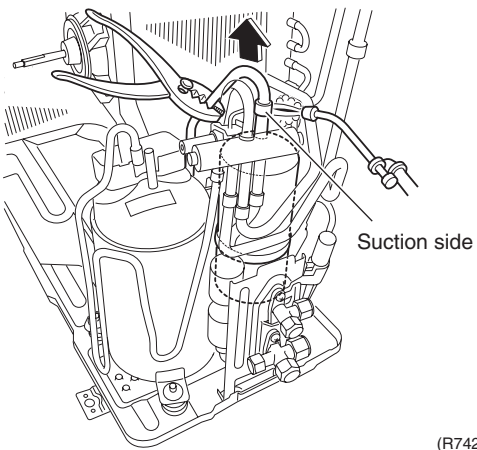
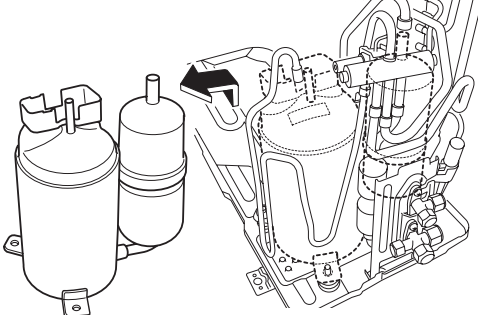

Warning Be sure to wait 10 minutes or more after turning off all power supplies before disassembling work.

Step	Procedure	Points
1. Remove the peripheries.	 <p style="text-align: right;">(R12022)</p>	<p>Warning If refrigerant gas leaks during the work, ventilate the room. (If the refrigerant gas is exposed to flames, toxic gas may be generated.)</p> <ul style="list-style-type: none"> ■ Provide a protective sheet or a steel plate so that the brazing flame cannot influence peripheries. ■ Be careful so as not to burn the compressor terminals or the name plate. ■ Be careful so as not to burn the heat exchanger fin.
2. Remove the compressor.	<p>■ Before working, make sure that the refrigerant is empty in the circuit.</p> <p>■ Be sure to apply nitrogen replacement when heating up the brazed part.</p> <p>1 Heat up the brazed part of the discharge side and disconnect.</p> <p>2 Heat up the brazed part of the suction side and disconnect.</p> <p>3 Lift the compressor up and remove it.</p>  <p style="text-align: right;">(R7422)</p>  <p style="text-align: right;">(R7423)</p>  <p style="text-align: right;">(R7424)</p>	<p>Warning Since it may happen that refrigerant oil in the compressor catches fire, prepare wet cloth so as to extinguish fire immediately.</p> <p>In case of difficulty with gas brazing machine</p> <ol style="list-style-type: none"> 1. Disconnect the brazed part where is easy to disconnect and restore. 2. Cut pipes on the main unit with a tube cutter in order to make it easy to disconnect. <p>Cautions for restoration</p> <ol style="list-style-type: none"> 1. Restore the piping by non-oxidation brazing. 2. It is required to prevent the carbonization of the oil inside the four way valve and the deterioration of the gaskets affected by heat. For the sake of this, wrap the four way valve with wet cloth and provide water so that the cloth does not dry and avoid excessive heating. (Keep below 120°C) <p>Note: Do not use a metal saw for cutting pipes by all means because the sawdust comes into the circuit.</p>



Caution
From the viewpoint of global environment protection, do not discharge the refrigerant gas in the atmosphere. Make sure to recover the refrigerant gas with the recovery system.



Caution
From the viewpoint of global environment protection, make sure to use a vacuum pump for air purging.

Part 8 Others

1. Others	139
1.1 Trial Operation.....	139
1.2 Field Settings.....	140
1.3 Application of Silicon Grease to a Power Transistor and a Diode Bridge.....	141

1. Others

1.1 Trial Operation

Outline

1. Measure the supply voltage and make sure that it falls in the specified range.
2. Trial operation should be carried out in either cooling or heating mode.
3. Carry out the trial operation in accordance with the operation manual to ensure that all functions and parts, such as louver movement, are working properly.
 - The air conditioner requires a small amount of power in its standby mode. If the system is not to be used for some time after installation, shut off the circuit breaker to eliminate unnecessary power consumption.
 - If the circuit breaker trips to shut off the power to the air conditioner, the system backs up the operation mode. The system then restarts operation with the previous mode when the circuit breaker is restored.

In cooling mode, select the lowest programmable temperature; in heating mode, select the highest programmable temperature.

- Trial operation may be disabled in either mode depending on the room temperature.
- After trial operation is complete, set the temperature to a normal level.
(26°C to 28°C in cooling mode, 20°C to 24°C in heating mode)
- For protection, the system does not start for 3 minutes after it is turned off.

Detail

ARC433 Series

- (1) Press the ON/OFF button to turn on the system.
- (2) Press the center of the TEMP button and the MODE button at the same time.
- (3) Press the MODE button twice.
(“?” appears on the display to indicate that trial operation is selected.)
- (4) Press the MODE button and select operation mode.
- (5) Trial operation terminates in approx. 30 minutes and switches into normal mode. To quit a trial operation, press the ON/OFF button.

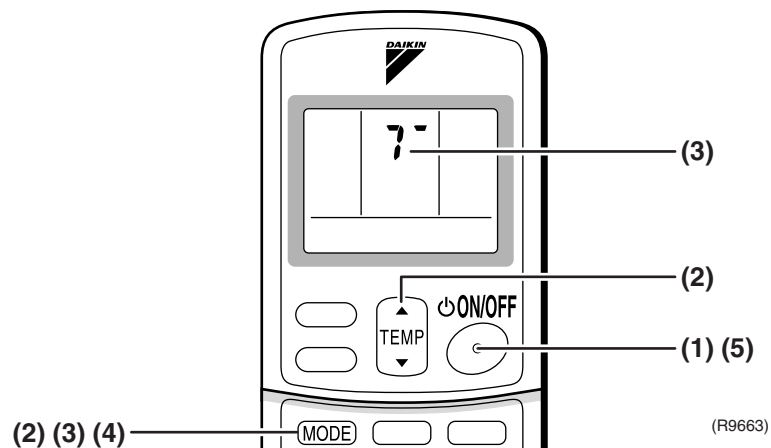

1.2 Field Settings

1.2.1 When 2 Units are Installed in 1 Room

How to set the different addresses.

- When 2 indoor units are installed in 1 room, 1 of the 2 pairs of indoor unit and wireless remote controller can be set for different address.
Both the indoor unit PCB and the wireless remote controller need alteration.

Indoor Unit PCB

- (1) Remove the front grille. (2 screws)
- (2) Remove the service cover. (1 screw)
- (3) Remove the shield plate. (3 hooks)
- (4) Cut the address setting jumper JA on the control PCB.

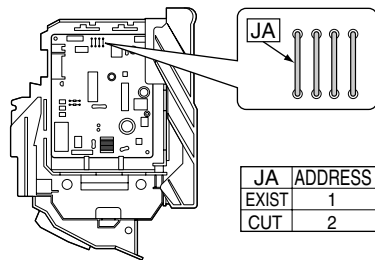

(R12007)

Wireless Remote Controller

- (1) Remove the cover and take it off.
- (2) Cut the address setting jumper J4.

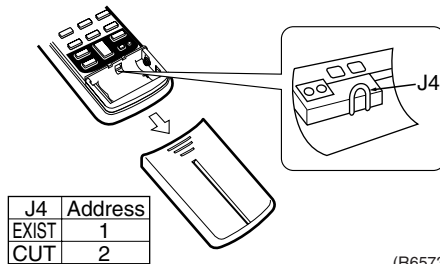

(R6573)

1.2.2 Jumper Settings

Jumper	Function	When connected (factory set)	When cut
JB (on indoor unit PCB)	Fan speed setting when compressor stops for thermostat OFF. (effective only at cooling operation)	Fan speed setting ; Remote controller setting	Fan rpm is set to "0" <Fan stop>
JC (on indoor unit PCB)	Power failure recovery function	Auto-restart	The unit does not resume operation after recovering from a power failure. Timer ON/OFF settings are cleared.
J5 (on outdoor unit PCB)	Improvement of defrost performance	Standard control	Reinforced control (ex. The frequency increases, the duration time of defrost lengthens.)



For the location of the jumper, refer to the following pages.
Indoor unit; page 10
Outdoor unit; page 12

1.3 Application of Silicon Grease to a Power Transistor and a Diode Bridge

Applicable Models

All outdoor units using inverter type compressor for room air conditioner.

When the printed circuit board (PCB) of an outdoor unit is replaced, it is required that silicon grease (*1) is certainly applied to the heat radiation part (the contact point to the radiation fin) of the power transistor and diode bridge.

*1: Parts number of the silicon grease – 1172698 (Drawing number 3FB03758-1)

Details

The silicon grease is an essential article for encouraging the heat radiation of the power transistor and the diode bridge. Applying the paste should be implemented in accordance with the following instruction.

Remark: There is the possibility of failure with smoke in case of bad heat radiation.

- Wipe off the old silicon grease completely on a radiation fin.
- Apply the silicon grease evenly to the whole.
- Do not leave any foreign object such as solder or paper waste between the power transistor and the radiation fin, and also the diode bridge, and the radiation fin.
- Tighten the screws of the power transistor and the diode bridge, and contact to the radiation fin without any gap.

<Example>

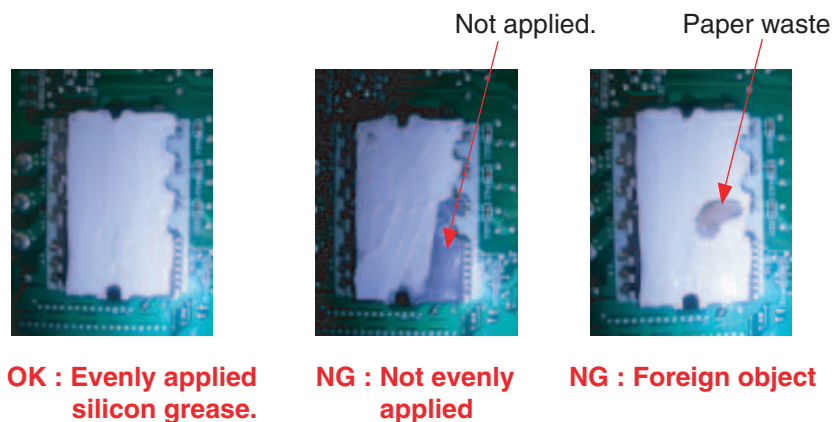
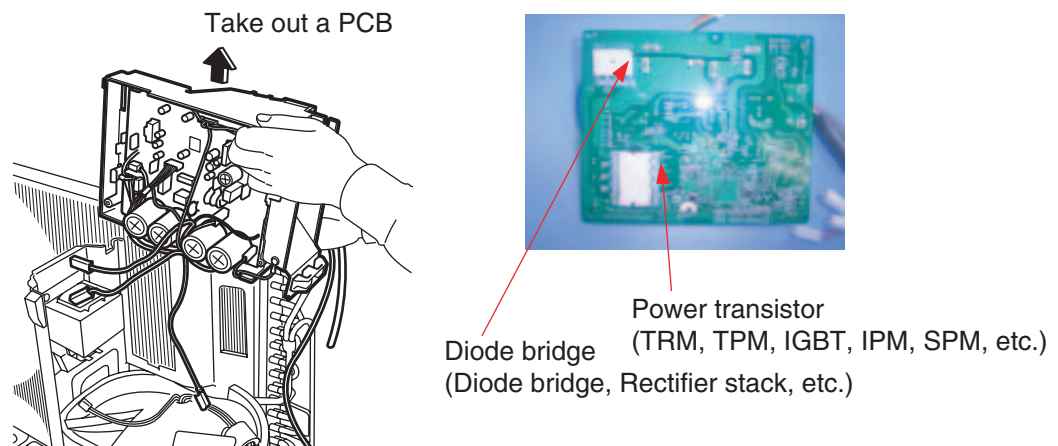

(R9056)

Part 9

Appendix

1. Piping Diagrams.....	143
1.1 Indoor Unit.....	143
1.2 Outdoor Unit.....	144
2. Wiring Diagrams.....	145
2.1 Indoor Unit.....	145
2.2 Outdoor Unit.....	145

1. Piping Diagrams

1.1 Indoor Unit

FTX20/25/35JV1B, ATX20/25/35JV1B

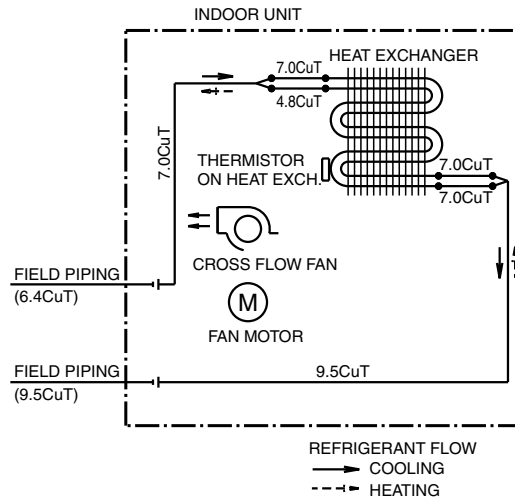

4D058926E

1.2 Outdoor Unit

RX20/25JV1B, ARX20/25JV1B

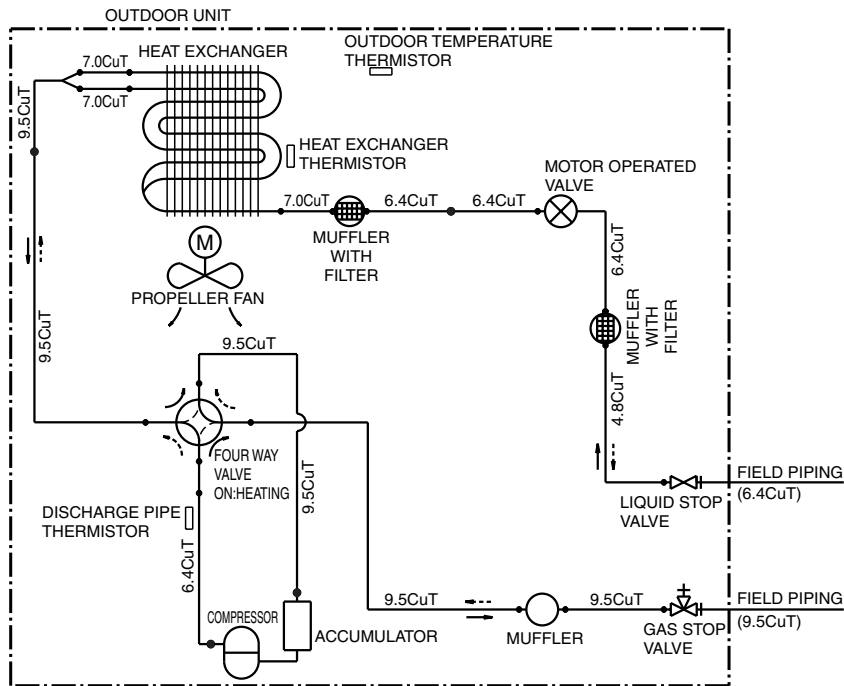

3D058716B

RX35JV1B, ARX35JV1B

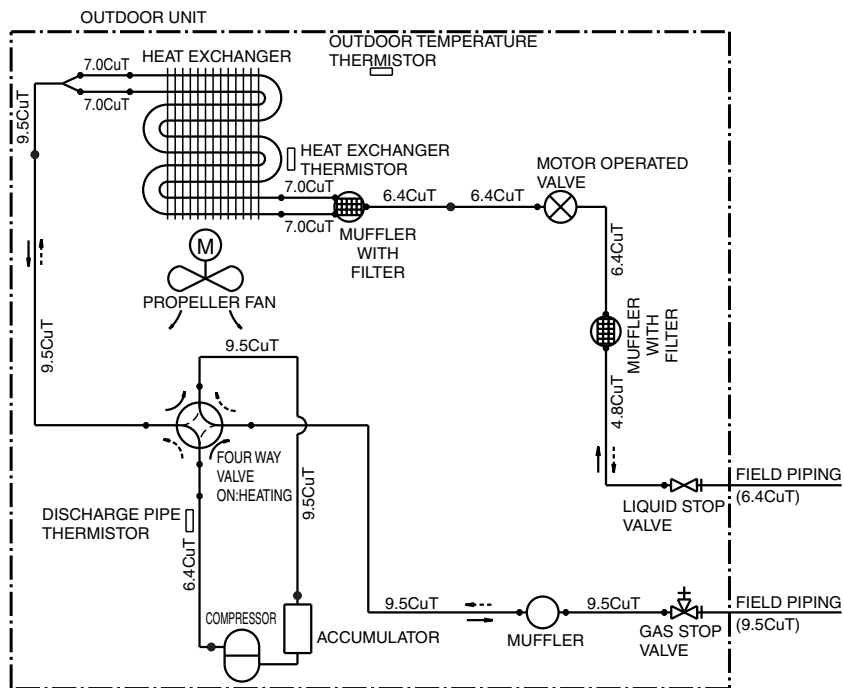

3D058714B

2. Wiring Diagrams

2.1 Indoor Unit

FTX20/25/35JV1B, ATX20/25/35JV1B

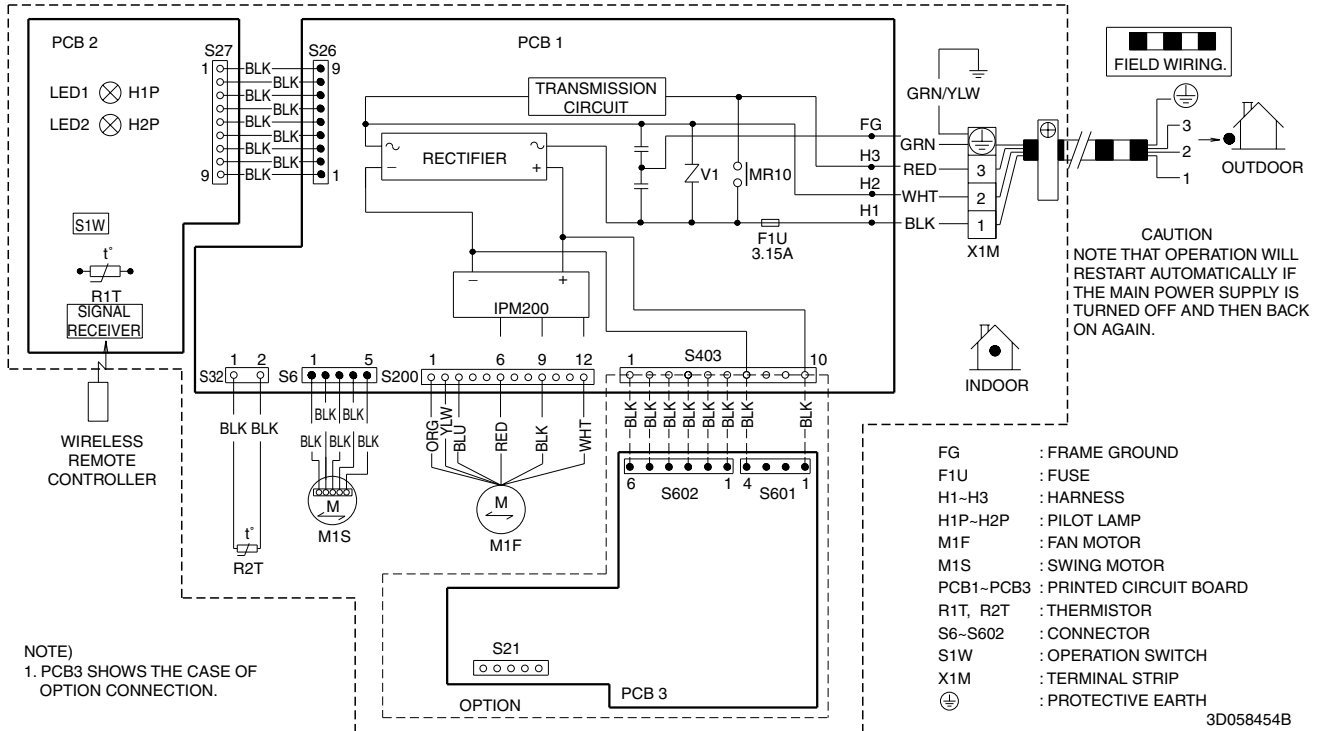

2.2 Outdoor Unit

RX20/25/35JV1B, ARX20/25/35JV1B

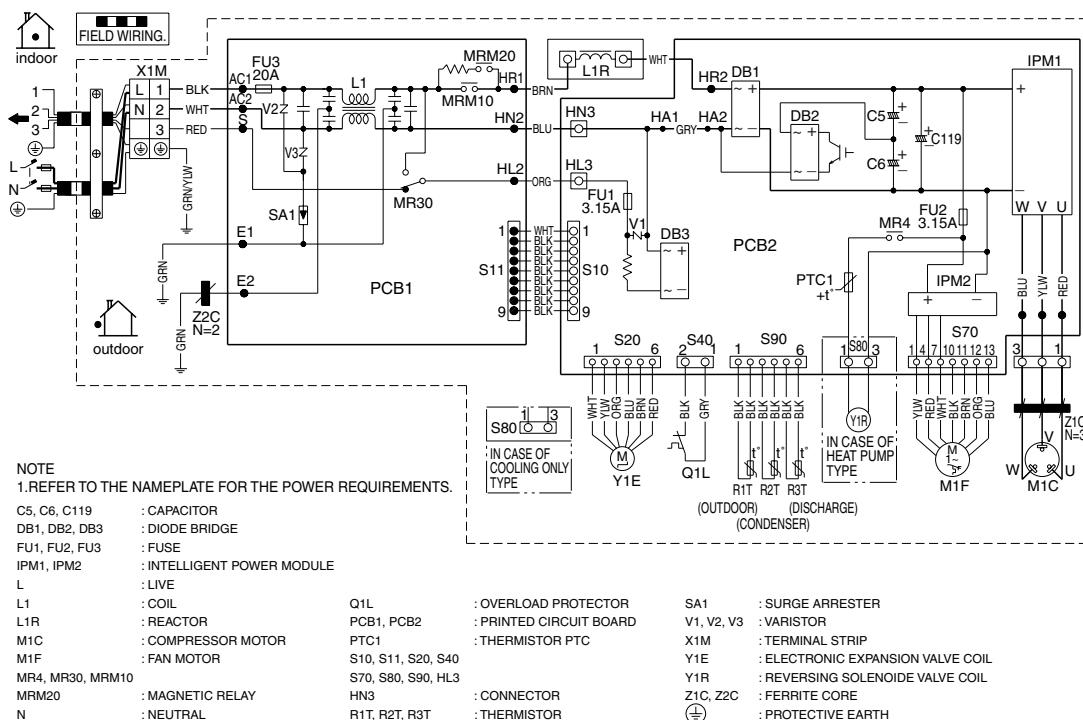

Warning



- Daikin Industries, Ltd.'s products are manufactured for export to numerous countries throughout the world. Daikin Industries, Ltd. does not have control over which products are exported to and used in a particular country. Prior to purchase, please therefore confirm with your local authorised importer, distributor and/or retailer whether this product conforms to the applicable standards, and is suitable for use, in the region where the product will be used. This statement does not purport to exclude, restrict or modify the application of any local legislation.
- Ask a qualified installer or contractor to install this product. Do not try to install the product yourself. Improper installation can result in water or refrigerant leakage, electrical shock, fire or explosion.
- Use only those parts and accessories supplied or specified by Daikin. Ask a qualified installer or contractor to install those parts and accessories. Use of unauthorised parts and accessories or improper installation of parts and accessories can result in water or refrigerant leakage, electrical shock, fire or explosion.
- Read the User's Manual carefully before using this product. The User's Manual provides important safety instructions and warnings. Be sure to follow these instructions and warnings.

If you have any enquiries, please contact your local importer, distributor and/or retailer.

Cautions on product corrosion

1. Air conditioners should not be installed in areas where corrosive gases, such as acid gas or alkaline gas, are produced.
2. If the outdoor unit is to be installed close to the sea shore, direct exposure to the sea breeze should be avoided. If you need to install the outdoor unit close to the sea shore, contact your local distributor.



JMI-0107

Organization:
DAIKIN INDUSTRIES, LTD.
AIR CONDITIONING MANUFACTURING DIVISION

Scope of Registration:
THE DESIGN/DEVELOPMENT AND MANUFACTURE OF
COMMERCIAL AIR CONDITIONING, HEATING, COOLING,
REFRIGERATING EQUIPMENT, COMMERCIAL HEATING
EQUIPMENT, RESIDENTIAL AIR CONDITIONING
EQUIPMENT, HEAT RECLAIM VENTILATION, AIR
CLEANING EQUIPMENT, MARINE TYPE CONTAINER
REFRIGERATION UNITS, COMPRESSORS AND VALVES.



JQA-1452

Organization:
DAIKIN INDUSTRIES
(THAILAND) LTD.

Scope of Registration:
THE DESIGN/DEVELOPMENT
AND MANUFACTURE OF AIR
CONDITIONERS AND THE
COMPONENTS INCLUDING
COMPRESSORS USED FOR THEM



EC99J2044

All of the Daikin Group's business facilities and subsidiaries in Japan are certified under the ISO 14001 international standard for environment management.

Dealer

DAIKIN INDUSTRIES, LTD.

Head Office:
Umeda Center Bldg., 2-4-12, Nakazaki-Nishi,
Kita-ku, Osaka, 530-8323 Japan

Tokyo Office:
JR Shinagawa East Bldg., 2-18-1, Konan,
Minato-ku, Tokyo, 108-0075 Japan

http://www.daikin.com/global_ac/

©All rights reserved