



technical data

FTK/XS-C/B



**Wall Mounted,
Inverter Controlled Unit**

air conditioning systems

Split Sky Air

Split - Sky Air



ISO14001 assures an effective environmental management system in order to help protect human health and the environment from the potential impact of our activities, products and services and to assist in maintaining and improving the quality of the environment



Daikin units comply with the European regulations that guarantee the safety of the product.



Daikin Europe N.V. is approved by LRQA for its Quality Management System in accordance with the ISO9001 standard. ISO9001 pertains to quality assurance regarding design, development, manufacturing as well as to services related to the product.



Daikin Europe N.V. participates in the Eurovent Certification Programme for Air Conditioners (AC), Liquid Chilling Packages (LCP) and Fan Coil Units (FC); the certified data of certified models are listed in the Eurovent Directory.

Specifications are subject to change without prior notice.

DAIKIN EUROPE N.V.

Zandvoordestraat 300
B - 8400 Ostend Belgium
www.daikineurope.com



TABLE OF CONTENTS

FTKS/FTXS-C/B

1	Features	2
2	Specifications	3
	Nominal capacity, capacity steps and nominal input	
	Technical specifications	
3	Dimensional drawings	13
4	Piping diagrams	15
5	Wiring diagrams	17
6	Sound level	19
	Sound level data	
	Sound pressure spectrum	
7	Accessories	24
	Standard accessories	
	Optional accessories	
8	Control systems	25
9	Center of gravity	27
10	Installation	28

For capacity tables, please refer to part II: outdoor units



1 Features

1

- Flat front panel: its stylish appearance fits easily within any interior décor and is more easy to clean.
- Lightweight and compact
- The movement sensor saves power consumption in unoccupied rooms.
- The home leave operation saves energy during absence.
- Automatic horizontal and vertical auto-swing ensures uniform air flow and temperature distribution.
- 3D-air flow (50,60,71 class only)
- Powerful mode can be selected for rapid cooling or heating.
- Air purification filter with photocatalytic deodorising function
 - deodorises the air
 - powerful decomposes cigarette and pet odours
 - removes house dust and pollen
 - deactivates bacteria and viruses
- Indoor / outdoor unit silent operation
Silent buttons on the remote control lower the operating sound of the indoor and/or outdoor unit by 3dB(A) each.
- Night quiet mode automatically reduces the operating sound of the outdoor unit by 3dB(A) at night. multi outdoors in cooling mode only
- Up to 4 indoor units can be connected to 1 Multi outdoor unit. All indoor units are individually controllable with remote control and do not need to be installed in the same room. They operate simultaneously within the same cooling or heating mode.
- The outdoor unit can easily be mounted on a roof, a terrace or placed against an outside wall.
- Outdoor units are fitted with a swing compressor, renowned for its low noise and energy efficiency.
- The remote control has a 24 hour timer
- The indoor model also has a start/stop button mounted on the front panel
- Up to 5 indoor units can be operated from a single centralised control
- Purpose designed holder provided for your remote control



2



2 Specifications

NOMINAL CAPACITY and NOMINAL INPUT						
For indoor units only:						
INDOOR UNITS				FTKS20CVMB	FTKS25CVMB	FTKS35CVMB
NOMINAL INPUT	Cooling	nominal	kW	0.04	0.04	0.04
For combination indoor + outdoor units (air cooled):						
INDOOR UNITS				FTKS20CVMB	FTKS25CVMB	FTKS35CVMB
OUTDOOR UNITS - PAIR APPLICATION				RKS20DVMB	RKS25DVMB	RKS35DVMB
NOMINAL CAPACITY (2-3)	Cooling (1)	min.–nom.–max.	kW	1.3~2.0~2.6	1.3~2.5~3.0	1.4~3.4~3.8
NOMINAL INPUT	Cooling	min.–nom.–max.	kW	0.30~0.50~0.98	0.30~0.695~0.98	0.30~1.06~1.30
EER				4.00	3.60	3.21
ENERGY LABEL	Cooling			A	A	A
ANNUAL ENERGY CONSUMPTION	Cooling		kWh	250	348	530
OUTDOOR UNITS - PAIR APPLICATION				RKH20CVMB7	RKH25CVMB7	RKH35CVMB7
NOMINAL CAPACITY (2-3)	Cooling (1)	min.–nom.–max.	kW	1.3~2.0~2.6	1.3~2.25~3.0	1.4~3.15~3.8
NOMINAL INPUT	Cooling	min.–nom.–max.	kW	0.43~0.62~0.945	0.43~0.70~1.20	0.46~1.045~1.425
EER				3.23	3.21	3.01
ENERGY LABEL	Cooling			A	A	B
ANNUAL ENERGY CONSUMPTION	Cooling		kWh	310	350	523
OUTDOOR UNITS - MULTI APPLICATION				2MKS40/3MKS50/4MKS58,75,90D		4MKS58,75,90D
For more information, see chapter MKS-D						

TECHNICAL SPECIFICATIONS							
For indoor units only:							
INDOOR UNITS				FTKS20CVMB	FTKS25CVMB	FTKS35CVMB	
DIMENSIONS	Unit	H	mm	273			
		W	mm	784			
		D	mm	195			
WEIGHT	Unit		kg	7.5			
COLOUR	Unit			White			
SOUND LEVEL	Sound pressure (cooling) (4)	high	dB(A)	38	38	39	
		low	dB(A)	25	25	26	
		super low	dB(A)	22	22	23	
	Sound power (cooling) (5)		dB(A)	56	56	57	
FAN	Air flow rate (cooling)	high	m ³ /min	7.7	7.7	7.7	
		low	m ³ /min	4.2	4.2	4.4	
		super low	m ³ /min	3.6	3.6	3.8	
	Speed	steps		5 steps, silent and auto			
		high	rpm	1,340	1,340	1,340	
		medium	rpm	1,090	1,090	1,100	
	low	rpm	840	840	870		
	Type			Cross flow fan			
Motor output		W	18	18	18		
HEAT EXCHANGER	Type		ML fin - ϕ 7Hi - XA tube				
	Rows x stages x fin pitch	mm	2 x 12 x 1.4	2 x 12 x 1.4	2 x 12 x 1.4		
AIR FILTER			Removable/washable/mildew proof				
TEMPERATURE CONTROL			Microcomputer control				
PIPING CONNECTIONS	liquid	mm	ϕ 6.4				
	gas	mm	ϕ 9.5				
	drain	mm	ϕ 18.0				
INSULATION MATERIAL	Heat insulation tape		Both liquid and gas pipes				
For outdoor units	Pair application		See chapter RKS-D/RKH-C				
	Multi application		See chapter MKS-D				

3D044242B
3D044243B
3D044244B

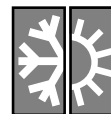

2 Specifications

2

NOMINAL CAPACITY and NOMINAL INPUT						
For indoor units only:						
INDOOR UNITS				FTKS50BVMB	FTKS60BVMB	FTKS71BVMB
NOMINAL INPUT	Cooling	nominal	kW	0.04	0.04	0.045
For combination indoor + outdoor units (air cooled):						
INDOOR UNITS				FTKS50BVMB	FTKS60BVMB	FTKS71BVMB
OUTDOOR UNITS - PAIR APPLICATION				RKS50BVMB9	RKS60BVMB9	RKS71BVMB9
NOMINAL CAPACITY (2-3)	Cooling (1)	min.–nom.–max.	kW	0.90–5.00–5.80	0.90–6.00–6.70	0.90–7.10–8.00
NOMINAL INPUT	Cooling	min.–nom.–max.	kW	0.45–1.66–2.30	0.45–2.12–2.45	0.45–2.53–3.07
EER				3.01	2.83	2.81
ENERGY LABEL	Cooling			B	C	C
ANNUAL ENERGY CONSUMPTION	Cooling		kWh	830	1,060	1,265
OUTDOOR UNITS - MULTI APPLICATION				4MKS58,75,90D	4MKS75,90D	4MKS90D
For more information, see chapter MKS-D						

TECHNICAL SPECIFICATIONS							
For indoor units only:							
INDOOR UNITS				FTKS50BVMB	FTKS60BVMB	FTKS71BVMB	
DIMENSIONS	Unit	H	mm	290	290		
		W	mm	795	1,050		
		D	mm	238	238		
WEIGHT	Unit		kg	9	12		
COLOUR	Unit	White					
SOUND LEVEL	Sound pressure (cooling) (4)	high	dB(A)	44	45	46	
		low	dB(A)	35	36	37	
		super low	dB(A)	32	33	34	
	Sound power (cooling) (5)		dB(A)	63	63	63	
FAN	Air flow rate (cooling)	high	m ³ /min	11.4	16.2	16.7	
		low	m ³ /min	8.0	11.4	11.6	
		super low	m ³ /min	7.1	10.2	10.6	
	Speed	steps	5 steps, silent and auto				
		high	rpm	1,340	1,330	1,370	
		medium	rpm	1,180	1,170	1,210	
		low	rpm	1,010	1,010	1,040	
Type	Cross flow fan						
Motor output		W	40	43			
HEAT EXCHANGER	Type	ML fin - ϕ 8Hi - XA tube					
	Rows x stages x fin pitch		mm	2 x 16 x 1.4	2 x 16 x 1.4	2 x 16 x 1.4	
AIR FILTER	Removable/washable/mildew proof						
TEMPERATURE CONTROL	Microcomputer control						
PIPING CONNECTIONS	liquid	mm	ϕ 6.4				
	gas	mm	ϕ 12.7		ϕ 15.9		
	drain	mm	ϕ 18.0				
INSULATION MATERIAL	Heat insulation tape		Both liquid and gas pipes				
For outdoor units	Pair application	See chapter RKS-B					
	Multi application	See chapter MKS-D					

3D040781A
3D040782A
3D040783A



2 Specifications

2

ELECTRICAL SPECIFICATIONS				
For indoor units only:				
CURRENT	Nominal running current	cooling	A	FTKS20CVMB 0.18 FTKS25CVMB 0.18 FTKS35CVMB 0.18
	Maximum running current	cooling	A	- - -
For combination indoor units + outdoor units:				
CURRENT	Nominal running current	cooling	A	FTKS20CVMB 2.8 FTKS25CVMB 3.9 FTKS35CVMB 4.9
	Maximum running current	cooling	A	See chapter RKS-D: electrical data
	Starting current	cooling	A	
For combination indoor units + outdoor units:				
CURRENT	Nominal running current	cooling	A	FTKS20CVMB 3.3 FTKS25CVMB 3.7 FTKS35CVMB 4.9
	Maximum running current	cooling	A	See chapter RKH-C: electrical data
	Starting current	cooling	A	
For combination indoor units + outdoor units:				
CURRENT	Nominal running current	cooling	A	FTKS20CVMB FTKS25CVMB FTKS35CVMB 2MKS40/3MKS50/4MKS58,75,90D
	Maximum running current	cooling	A	See chapter MKS-D: electrical data
	Starting current	cooling	A	
For indoor units only:				
POWER SUPPLY				FTKS20CVMB VM FTKS25CVMB VM FTKS35CVMB VM
NOMINAL DISTRIBUTION SYSTEM VOLTAGE	Phase			1~ 1~ 1~
	Frequency		Hz	50 50 50
	Voltage		V	230 230 230

3D044242B
3D044243B
3D044244B

NOTES

- Nominal cooling capacities are based on: indoor temperature 27°CDB/19°CWB * outdoor temperature 35°CDB * refrigerant piping length: 7.5m * level difference: 0m.
- Capacities are net, including a deduction for cooling (an addition for heating) for indoor fan motor heat.
- Units should be selected on nominal capacity. Maximum capacity is limited to peak periods.
- The sound pressure level is measured via a microphone at a certain distance from the unit. For measuring conditions: please refer to item 6 of this chapter.
- The sound power level is an absolute value indicating the "power" which a sound source generates.
- Energy label: scale from A (most efficient) to G (less efficient).
- Annual energy consumption: based on average use of 500 running hours per year at full load (= nominal conditions)

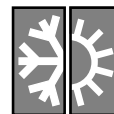

2 Specifications

2

ELECTRICAL SPECIFICATIONS						
For indoor units only:						
CURRENT	Nominal running current	cooling	A	FTKS50BVMB	FTKS60BVMB	FTKS71BVMB
	Maximum running current	cooling	A	0.18	0.18	0.20
				-	-	-
For combination indoor units + outdoor units:						
				FTKS50BVMB	FTKS60BVMB	FTKS71BVMB
				RKS50BVMB9	RKS60BVMB9	RKS71BVMB9
CURRENT	Nominal running current	cooling	A	7.3	9.3	11.1
	Maximum running current	cooling	A	See chapter RKS-B: electrical data		
	Starting current	cooling	A			
For combination indoor units + outdoor units:						
				FTKS50BVMB	FTKS60BVMB	FTKS71BVMB
				4MKS58,75,90D	4MKS75,90D	4MKS90D
CURRENT	Nominal running current	cooling	A	See chapter MKS-D: electrical data		
	Maximum running current	cooling	A			
	Starting current	cooling	A			
For indoor units only:						
POWER SUPPLY				VM	VM	VM
NOMINAL DISTRIBUTION SYSTEM VOLTAGE	Phase			1~	1~	1~
	Frequency		Hz	50	50	50
	Voltage		V	230	230	230

3D040781A
3D040782A
3D040783A

NOTES

- 1 Nominal cooling capacities are based on: indoor temperature 27°CDB/19°CWB * outdoor temperature 35°CDB * refrigerant piping length: 7.5m * level difference: 0m.
- 2 Capacities are net, including a deduction for cooling (an addition for heating) for indoor fan motor heat.
- 3 Units should be selected on nominal capacity. Maximum capacity is limited to peak periods.
- 4 The sound pressure level is measured via a microphone at a certain distance from the unit. For measuring conditions: please refer to item 6 of this chapter.
- 5 The sound power level is an absolute value indicating the "power" which a sound source generates.
- 6 Energy label: scale from A (most efficient) to G (less efficient).
- 7 Annual energy consumption: based on average use of 500 running hours per year at full load (= nominal conditions)

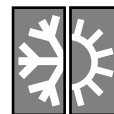

2 Specifications

2

NOMINAL CAPACITY and NOMINAL INPUT						
For indoor units only:						
INDOOR UNITS				FTXS20CVMB	FTXS25CVMB	FTXS35CVMB
NOMINAL INPUT	Cooling	nominal	kW	0.04	0.04	0.04
	Heating	nominal	kW	0.04	0.04	0.04
For combination indoor + outdoor units (air cooled):						
INDOOR UNITS				FTXS20CVMB	FTXS25CVMB	FTXS35CVMB
OUTDOOR UNITS - PAIR APPLICATION				RXS20DVMB	RXS25DVMB	RXS35DVMB
NOMINAL CAPACITY (3-4)	Cooling (1)	min.~nom.~max.	kW	1.3~2.0~2.6	1.3~2.5~3.0	1.4~3.4~3.8
	Heating (2)	min.~nom.~max.	kW	1.3~2.7~4.5	1.3~3.4~4.5	1.4~4.0~5.0
NOMINAL INPUT	Cooling	min.~nom.~max.	kW	0.30~0.50~0.98	0.30~0.695~0.98	0.30~1.06~1.30
	Heating	min.~nom.~max.	kW	0.29~0.675~1.48	0.29~0.935~1.46	0.31~1.17~1.59
EER	Cooling			4.00	3.60	3.21
COP	Heating			4.00	3.64	3.42
ENERGY LABEL	Cooling			A	A	A
	Heating			A	A	B
ANNUAL ENERGY CONSUMPTION	Cooling		kWh	250	348	530
INDOOR UNITS				FTXS20CVMB	FTXS25CVMB	FTXS35CVMB
OUTDOOR UNITS - PAIR APPLICATION				RXH20CVMB7	RXH25CVMB7	RXH35CVMB7
NOMINAL CAPACITY (3-4)	Cooling (1)	min.~nom.~max.	kW	1.3~2.0~2.6	1.3~2.5~3.0	1.4~3.15~3.8
	Heating (2)	min.~nom.~max.	kW	1.3~2.6~4.0	1.3~2.85~4.5	1.4~3.6~5.0
NOMINAL INPUT	Cooling	min.~nom.~max.	kW	0.43~0.62~0.945	0.43~0.70~1.20	0.46~1.045~1.425
	Heating	min.~nom.~max.	kW	0.35~0.76~1.31	0.35~0.835~1.61	0.405~1.055~1.90
EER	Cooling			3.23	3.21	3.01
COP	Heating			3.42	3.41	3.41
ENERGY LABEL	Cooling			A	A	B
	Heating			B	B	B
ANNUAL ENERGY CONSUMPTION	Cooling		kWh	310	350	522.5
OUTDOOR UNITS - MULTI APPLICATION				2MXS40/2MXS52/3MXS52/4MXS68/80D		
For more information, see chapter MXS-D						

3D044245B
3D044246B
3D044247B



2 Specifications

2

NOMINAL CAPACITY and NOMINAL INPUT

For indoor units only:

INDOOR UNITS				FTXS50BVMB	FTXS60BVMB	FTXS71BVMB
NOMINAL INPUT	Cooling	nominal	kW	0.040	0.040	0.045
	Heating	nominal	kW	0.045	0.045	0.050

For combination indoor + outdoor units (air cooled):

INDOOR UNITS				FTXS50BVMB	FTXS60BVMB	FTXS71BVMB
OUTDOOR UNITS - PAIR APPLICATION				RXS50BVMB	RXS60BVMB	RXS71BVMB
NOMINAL CAPACITY (3-4)	Cooling (1)	min.~nom.~max.	kW	0.90~5.00~5.80	0.90~6.00~6.70	0.90~7.10~8.00
	Heating (2)	min.~nom.~max.	kW	0.90~5.80~7.50	0.90~7.00~8.00	0.90~8.50~9.50
NOMINAL INPUT	Cooling	min.~nom.~max.	kW	0.45~1.66~2.30	0.45~2.12~2.45	0.45~2.53~3.07
	Heating	min.~nom.~max.	kW	0.45~1.70~2.58	0.45~2.09~3.10	0.45~2.63~3.80
EER	Cooling			3.01	2.83	2.81
COP	Heating			3.41	3.35	3.23
ENERGY LABEL	Cooling			B	C	C
	Heating			B	C	C
ANNUAL ENERGY CONSUMPTION	Cooling		kWh	830	1,060	1,265
OUTDOOR UNITS - MULTI APPLICATION				2MXS52/3MXS52/ 4MXS68,80D	4MXS68,80D	4MXS80D
For more information, see chapter MXS-D						

3D040778A
3D040779
3D040780A

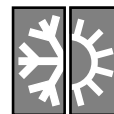

2 Specifications

2

TECHNICAL SPECIFICATIONS							
For indoor units only:							
INDOOR UNITS				FTXS20CVMB	FTXS25CVMB	FTXS35CVMB	
DIMENSIONS	Unit	H	mm	273			
		W	mm	784			
		D	mm	195			
WEIGHT	Unit	kg		7.5			
COLOUR	Unit	White					
SOUND LEVEL	Sound pressure (cooling/heating) (5)	high	dB(A)	38/38	38/38	39/39	
		low	dB(A)	25/28	25/28	26/29	
		super low	dB(A)	22/25	22/25	23/26	
	Sound power (cooling/heating) (6)	high	dB(A)	56/56	56/56	57/57	
FAN	Air flow rate (cooling/heating)	high	m ³ /min	7.7/7.8	7.7/7.8	7.7/8.1	
		low	m ³ /min	4.2/5.3	4.2/5.3	4.4/5.3	
		super low	m ³ /min	3.6/4.6	3.6/4.6	3.8/4.6	
	Speed (cooling/heating)	steps		5 steps, silent and auto			
		high	rpm	1,340/1,300	1,340/1,300	1,340/1,340	
		medium	rpm	1,090/1,130	1,090/1,130	1,100/1,150	
		low	rpm	840/960	840/960	870/960	
Type	Cross flow fan						
Motor output	W		18	18	18		
HEAT EXCHANGER	Type	ML fin - ϕ 7Hi - XA tube					
	Rows x stages x fin pitch	mm		2 x 12 x 1.4	2 x 12 x 1.4	2 x 12 x 1.4	
AIR FILTER	Removable/washable/mildew proof						
TEMPERATURE CONTROL	Microcomputer control						
PIPING CONNECTIONS	liquid	mm		ϕ 6.4			
	gas	mm		ϕ 9.5			
	drain	mm		ϕ 18.0			
INSULATION MATERIAL	Heat insulation tape		Both liquid and gas pipes				
For outdoor units	Pair application	See chapter RXS-D/RXH-C					
	Multi application	See chapter MXS-D					

3D044245B
3D044246B
3D044247B



2 Specifications

2

TECHNICAL SPECIFICATIONS							
For indoor units only:							
INDOOR UNITS				FTXS50BVMB	FTXS60BVMB	FTXS71BVMB	
DIMENSIONS	Unit	H	mm	290		290	
		W	mm	795		1,050	
		D	mm	238		238	
WEIGHT	Unit		kg	9		12	
COLOUR	Unit	White					
SOUND LEVEL	Sound pressure (cooling/heating) (5)	high	dB(A)	44/42	45/44	46/46	
		low	dB(A)	35/33	36/35	37/37	
		super low	dB(A)	32/30	33/32	34/34	
	Sound power (cooling/heating) (6)	high	dB(A)	63/60	63/62	63/63	
FAN	Air flow rate (cooling/heating)	high	m ³ /min	11.4/12.6	16.2/17.4	16.7/18.5	
		low	m ³ /min	8.0/8.9	11.4/12.7	11.6/13.5	
		super low	m ³ /min	7.1/7.7	10.2/11.4	10.6/12.1	
	Speed (cooling/heating)	steps		5 steps, silent and auto			
		high	rpm	1,340/1,370	1,330/1,360	1,370/1,440	
		medium	rpm	1,180/1,200	1,170/1,200	1,210/1,270	
		low	rpm	1,010/1,030	1,010/1,040	1,040/1,100	
Type	Cross flow fan						
Motor output		W	40		43		
HEAT EXCHANGER	Type	ML fin - ϕ 8Hi - XA tube					
	Rows x stages x fin pitch	mm	2 x 16 x 1.4	2 x 16 x 1.4	2 x 16 x 1.4		
AIR FILTER	Removable/washable/mildew proof						
TEMPERATURE CONTROL	Microcomputer control						
PIPING CONNECTIONS	liquid	mm	ϕ 6.4				
	gas	mm	ϕ 12.7		ϕ 15.9		
	drain	mm	ϕ 18.0				
INSULATION MATERIAL	Heat insulation tape	Both liquid and gas pipes					
For outdoor units	Pair application	See chapter RXS-B					
	Multi application	See chapter MXS-D					

3D040778A
3D040779
3D040780A

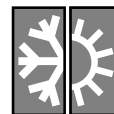

2 Specifications

2

ELECTRICAL SPECIFICATIONS					FTXS20CVMB	FTXS25CVMB	FTXS35CVMB
For indoor units only:							
CURRENT	Nominal running current	cooling	A	0.18	0.18	0.18	
		heating	A	0.18	0.18	0.18	
	Maximum running current	cooling	A	-			
		heating	A				
For combination indoor units + outdoor units:							
					FTXS20CVMB	FTXS25CVMB	FTXS35CVMB
					RXS20DVMB	RXS25DVMB	RXS35DVMB
CURRENT	Nominal running current	cooling	A	2.8	3.9	4.9	
		heating	A	3.5	4.4	5.4	
	Maximum running current	cooling	A	See chapter RXS-D: electrical data			
		heating	A				
	Starting current	cooling	A				
		heating	A				
For combination indoor units + outdoor units:							
					FTXS20CVMB	FTXS25CVMB	FTXS35CVMB
					RXH20CVMB7	RXH25CVMB7	RXH35CVMB7
CURRENT	Nominal running current	cooling	A	3.3	3.7	4.9	
		heating	A	4.0	4.4	4.9	
	Maximum running current	cooling	A	See chapter RXH-C: electrical data			
		heating	A				
	Starting current	cooling	A				
		heating	A				
For combination indoor units + outdoor units:							
					FTXS20CVMB	FTXS25CVMB	FTXS35CVMB
					2MXS40/2MXS52/3MXS52/4MXS68,80D		
CURRENT	Nominal running current	cooling	A	See chapter MXS-D: electrical data			
		heating	A				
	Maximum running current	cooling	A				
		heating	A				
	Starting current	cooling	A				
		heating	A				
For indoor units only:							
POWER SUPPLY					VM	VM	VM
NOMINAL DISTRIBUTION SYSTEM VOLTAGE	Phase			1~	1~	1~	
	Frequency			50	50	50	
	Voltage			230	230	230	

3D044245B
3D044246B
3D044247B

NOTES

- Nominal cooling capacities are based on: indoor temperature 27°CDB/19°CWB * outdoor temperature 35°CDB * refrigerant piping length: 7.5m * level difference: 0m.
- Nominal heating capacities are based on: indoor temperature 20°CDB * outdoor temperature 7°CDB/6°CWB * refrigerant piping length 7.5m (horizontal) * level difference 0m.
- Capacities are net, including a deduction for cooling (an addition for heating) for indoor fan motor heat.
- Units should be selected on nominal capacity. Maximum capacity is limited to peak periods.
- The sound pressure level is measured via a microphone at a certain distance from the unit. For measuring conditions: please refer to item 6 of this chapter.
- The sound power level is an absolute value indicating the "power" which a sound source generates.
- Energy label: scale from A (most efficient) to G (less efficient).
- Annual energy consumption: based on average use of 500 running hours per year at full load (= nominal conditions)

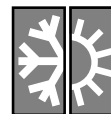

2 Specifications

2

ELECTRICAL SPECIFICATIONS				FTXS50BVMB	FTXS60BVMB	FTXS71BVMB
For indoor units only:						
CURRENT	Nominal running current	cooling	A	0.18	0.18	0.20
		heating	A	0.20	0.20	0.22
	Maximum running current	cooling	A	See chapter RXS-B: electrical data		
		heating	A			
For combination indoor units + outdoor units:						
				FTXS50BVMB	FTXS60BVMB	FTXS71BVMB
				RXS50BVMB	RXS60BVMB	RXS71BVMB
CURRENT	Nominal running current	cooling	A	7.3	9.3	11.1
		heating	A	7.5	9.2	11.6
	Maximum running current	cooling	A	See chapter RXS-B: electrical data		
		heating	A			
	Starting current	cooling	A			
		heating	A			
For combination indoor units + outdoor units:						
				FTXS50BVMB	FTXS60BVMB	FTXS71BVMB
				3MXS52/ 4MXS68,80D	4MXS68,80D	4MXS80D
CURRENT	Nominal running current	cooling	A	See chapter MXS-D: electrical data		
		heating	A			
	Maximum running current	cooling	A			
		heating	A			
	Starting current	cooling	A			
		heating	A			
For indoor units only:						
POWER SUPPLY				VM	VM	VM
NOMINAL DISTRIBUTION SYSTEM VOLTAGE	Phase			1~	1~	1~
	Frequency		Hz	50	50	50
	Voltage		V	230	230	230

3D040778A
3D040779
3D040780A

NOTES

- Nominal cooling capacities are based on: indoor temperature 27°CDB/19°CWB * outdoor temperature 35°CDB * refrigerant piping length: 7.5m * level difference: 0m.
- Nominal heating capacities are based on: indoor temperature 20°CDB * outdoor temperature 7°CDB/6°CWB * refrigerant piping length 7.5m (horizontal) * level difference 0m.
- Capacities are net, including a deduction for cooling (an addition for heating) for indoor fan motor heat.
- Units should be selected on nominal capacity. Maximum capacity is limited to peak periods.
- The sound pressure level is measured via a microphone at a certain distance from the unit. For measuring conditions: please refer to item 6 of this chapter.
- The sound power level is an absolute value indicating the "power" which a sound source generates.
- Energy label: scale from A (most efficient) to G (less efficient).
- Annual energy consumption: based on average use of 500 running hours per year at full load (= nominal conditions)



3 Dimensional drawings

3

FTK/XS20-25-35C

The mark (→) shows piping direction

Bottom

Signal transmitter

Indoor unit ON/OFF switch

Home leave lamp

Signal receiver

Room temp. thermistor

Intelligent movement sensor

Timer lamp

Operation lamp

Flaps

Front grille fixing screws (Inside)

784

197

195

273

unit (mm)

Air flow (indoor) required space (for performance and maintenance)

(including installation plate)

50 MIN (space for maintenance)

30 MIN (space for performance)

50 MIN (space for maintenance)

Name plate

Terminal block with earth terminal

Gas pipe 9.5Cut (The length of pipe outside the unit: about 300)

Drain hose (connecting part I.D. ϕ 14.0, O.D. ϕ 18.0)

Liquid pipe ϕ 6.4 CuT (the length of pipe outside the unit: about 350)

(The hose length on the outside of the unit is approx. 410)

Blade angle

Up/down (automatic)
Cooling, dry

Heating

Right/left (manual)

0°

2.5°

2.5°

5°

3.0°

3.0°

5.0°

5.0°

Infrared remote control

58

18

163

FTXS--: (ARC433A1)
FTKS--: (ARC433A2)

Standard locations of wall holes

Wall hole for embedded piping ϕ 65 hole

Wall hole ϕ 65 hole

3D044026

FTK/XS50B

The mark (→) shows piping direction

Bottom

Signal transmitter

Operation lamp

Signal receiver

Indoor unit ON/OFF switch

Intelligent movement sensor

Room temp. thermistor

Timer lamp

Home leave lamp

Flaps

Front grille fixing screws (Inside)

795

240

238

290

unit (mm)

Air flow (indoor) required space (for performance and maintenance)

(including installation plate)

50 MIN (space for maintenance)

30 MIN (space for performance)

50 MIN (space for maintenance)

Name plate

Terminal block with earth terminal (Inside)

Gas pipe 12.7Cut (The length of pipe outside the unit: about 340)

Drain hose (connecting part I.D. ϕ 14.0, O.D. ϕ 18.0)

Liquid pipe ϕ 6.4 CuT (the length of pipe outside the unit: about 350)

(The hose length on the outside of the unit is approx. 440)

Blade angles

Horizontal blade (Automatic)
Cooling

Heating (FTX-- only)

Dry

Fan only

Vertical blade (Automatic)

10°

40°

10°

40°

15°

55°

15°

55°

5°

35°

5°

35°

5°

55°

55°

5.0°

5.0°

5.0°

5.0°

Infrared remote control

58

18

163

FTX---: (ARC433A21)
FTK---: (ARC433A22)

Standard locations of wall holes

Wall hole for embedded piping ϕ 65 hole

Wall hole ϕ 65 hole

3D040071



3 Dimensional drawings

3

FTK/XS60-71B

The mark (→) shows piping direction

	A	B
FTK(XS60)71--	64	127
FTK(XS60)--		127
FTK(XS71)--		127

Infrared remote control
FTX---: (ARC433A2133)
FTK---: (ARC433A22)

Blade angle

Standard locations of wall holes

3D040073A



4 Piping diagrams

4

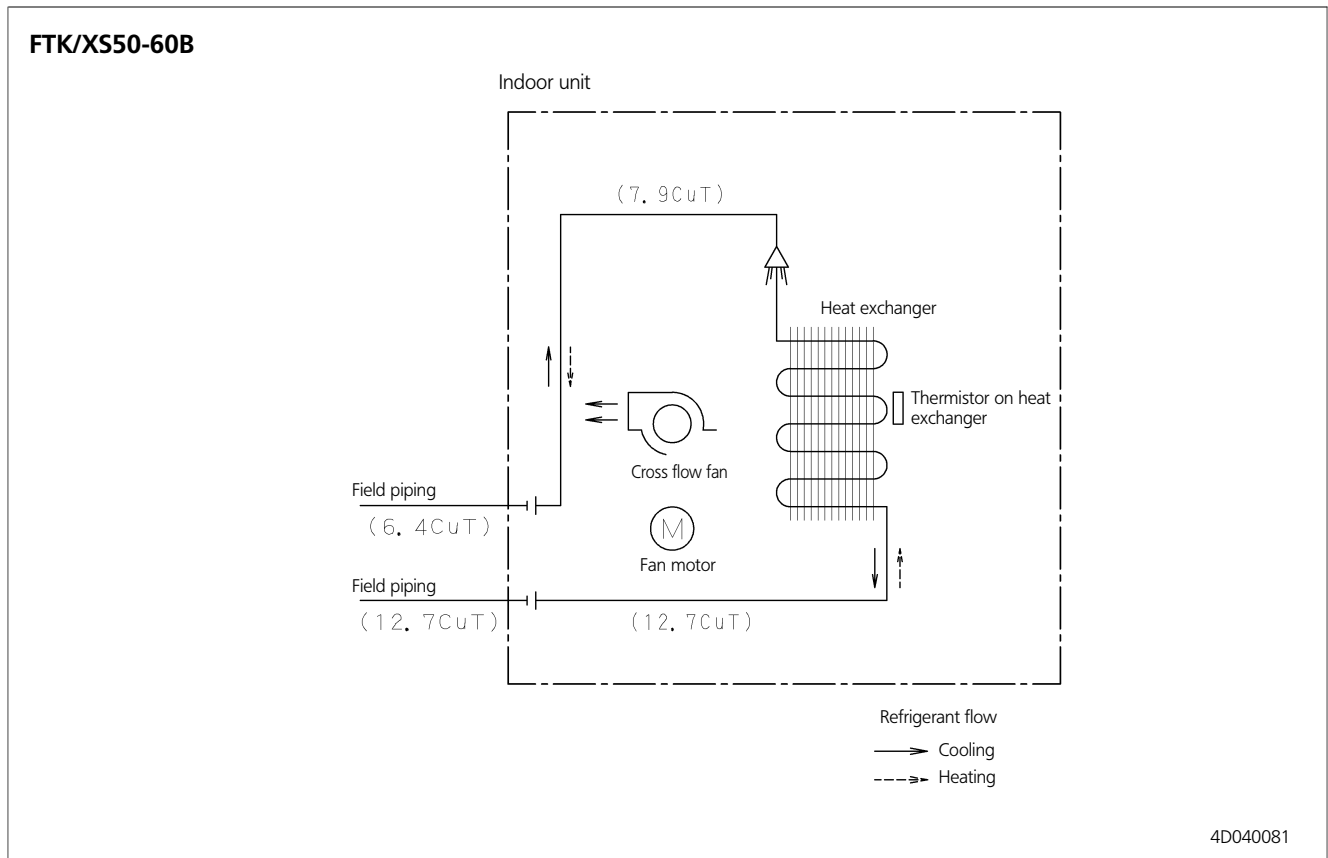
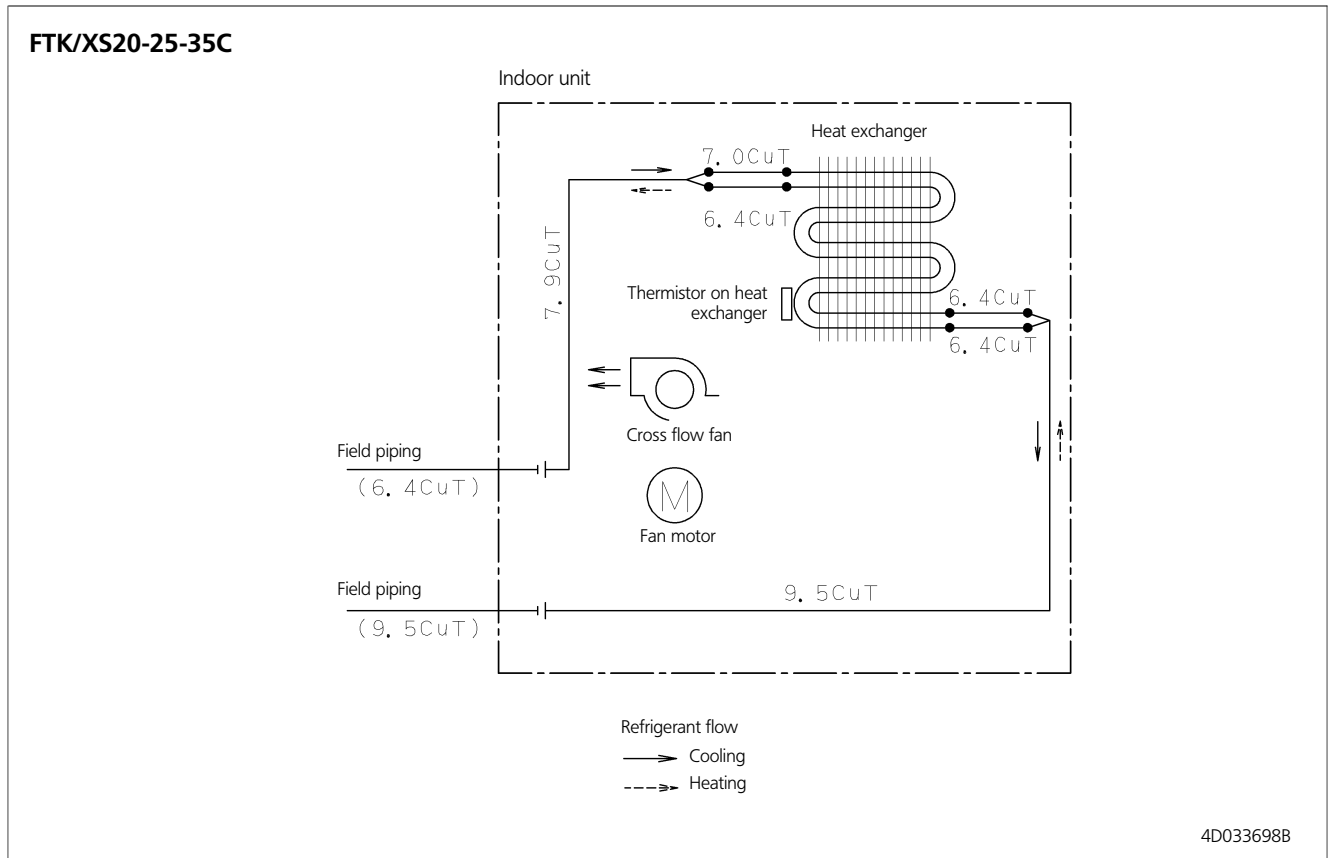



4 Piping diagrams

4

FTK/XS71B

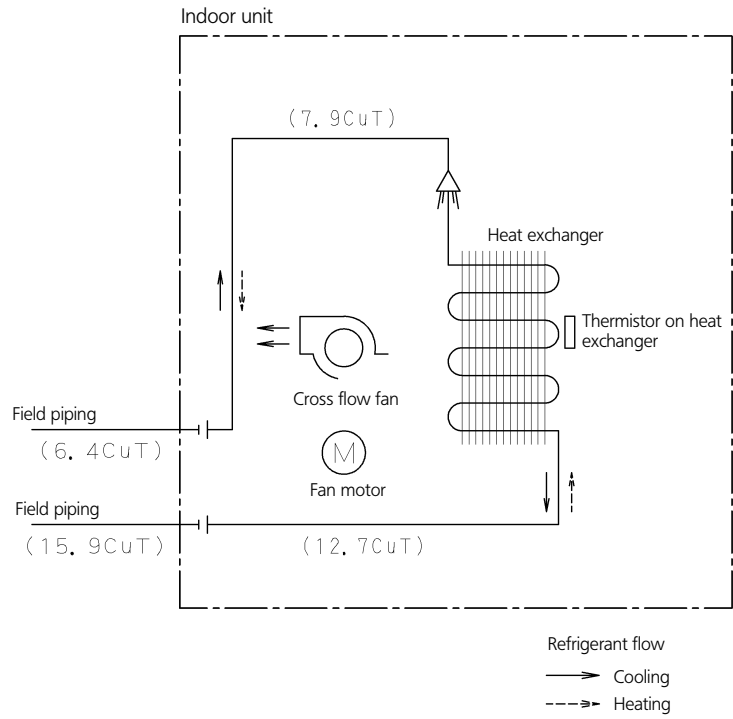

4D040082



5 Wiring diagrams

5

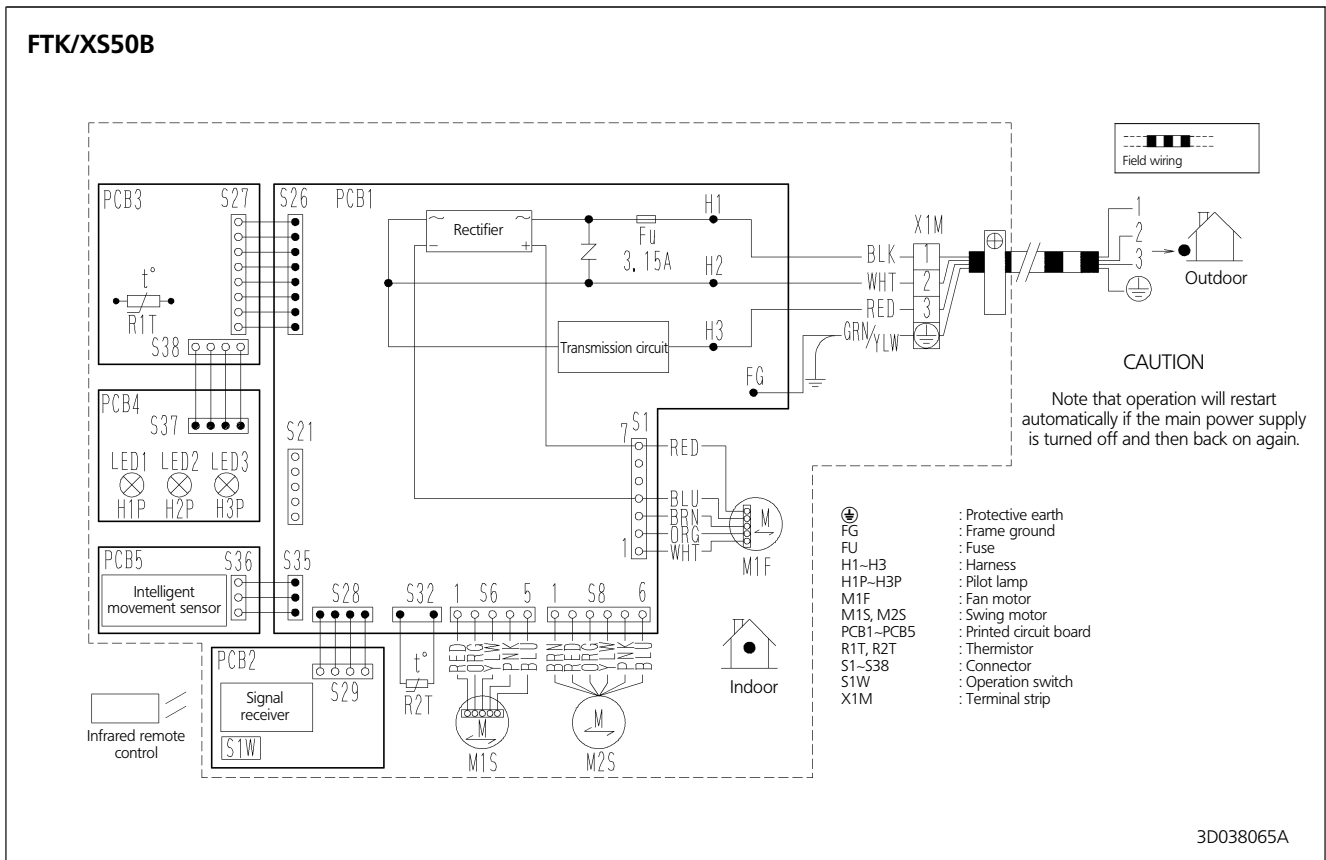
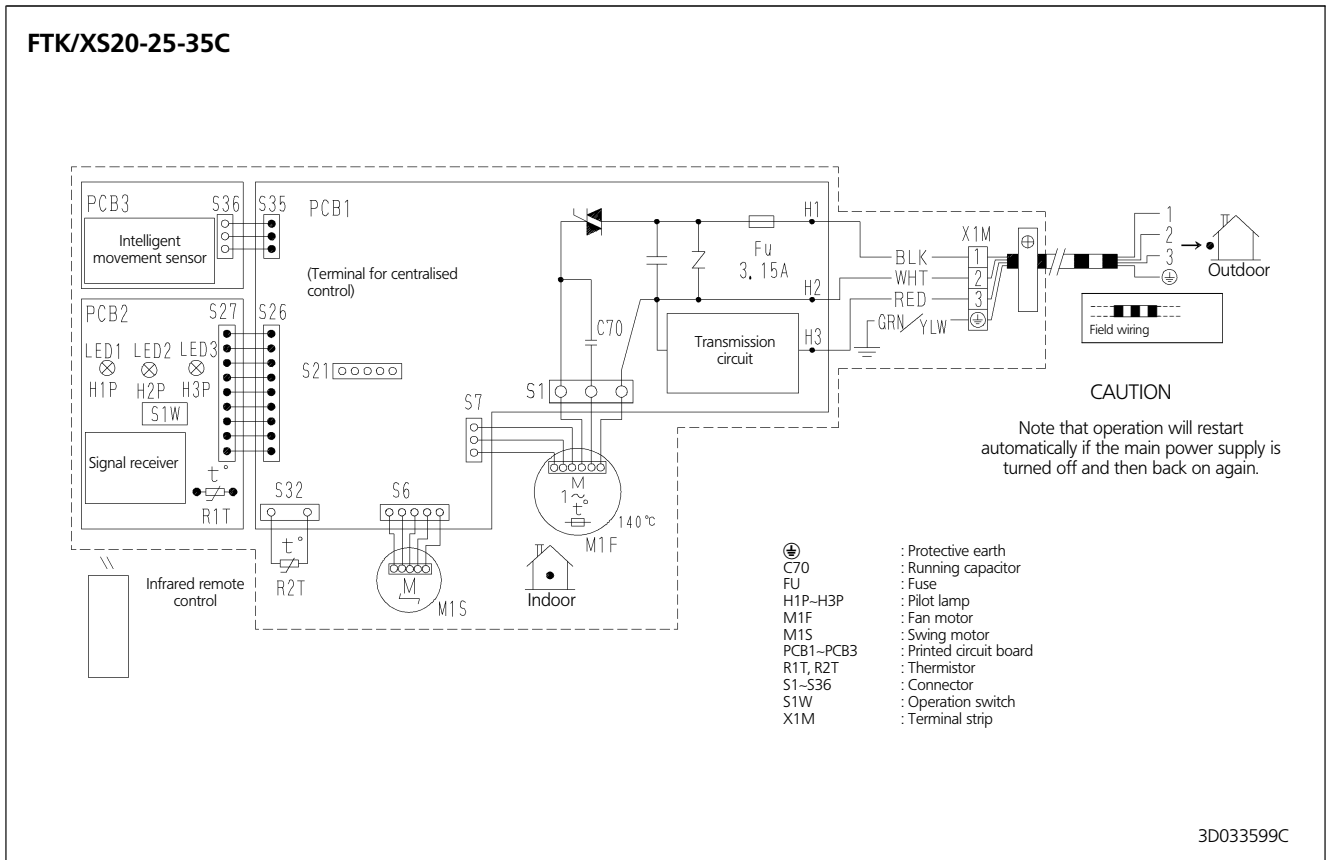

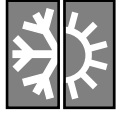

5 Wiring diagrams

5

FTK/XS60-71B

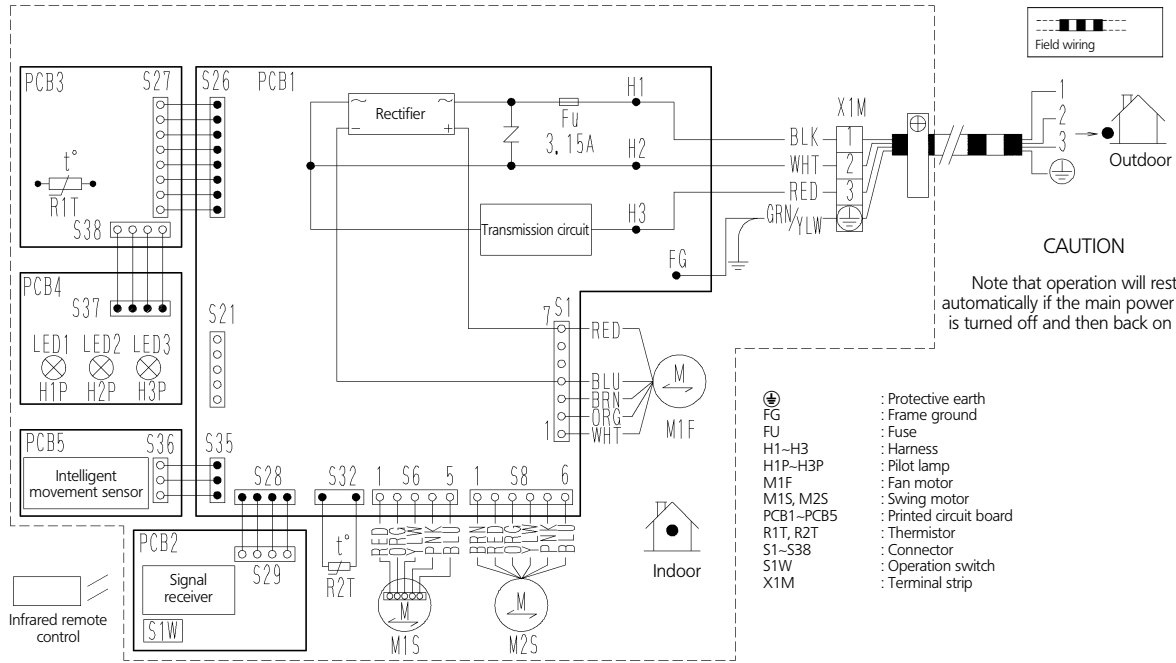

Field wiring

CAUTION

Note that operation will restart automatically if the main power supply is turned off and then back on again.

- ⊕ : Protective earth
- FG : Frame ground
- FU : Fuse
- H1-H3 : Harness
- H1P-H3P : Pilot lamp
- M1F : Fan motor
- M1S, M2S : Swing motor
- PCB1-PCB5 : Printed circuit board
- R1T, R2T : Thermistor
- S1-S38 : Connector
- S1W : Operation switch
- X1M : Terminal strip

3D038530B



6 Sound level

6-1 Sound level data

Cooling only

Model	Sound pressure level			Measuring location	Sound power level (Cooling)
	230V, 50Hz				
	Cooling				
	H	L	SL		
FTKS20C	38	25	22		56
FTKS25C	38	25	22		56
FTKS35C	39	26	23		57
FTKS50B	44	35	32		63
FTKS60B	45	36	33		63
FTKS71B	46	37	34		63

Heat pump

Model	Sound pressure level			Measuring location	Sound power level (Cooling/Heating)
	230V, 50Hz				
	Cooling/Heating				
	H	L	SL		
FTXS20C	38/38	25/28	22/25		56/56
FTXS25C	38/38	25/28	22/25		56/56
FTXS35C	39/39	26/29	23/26		57/57
FTXS50B	44/42	35/33	32/30		63/60
FTXS60B	45/44	36/35	33/32		63/62
FTXS71B	46/46	37/37	34/34		63/63

6-2 Sound pressure spectrum

Cooling only

FTKS20-25C

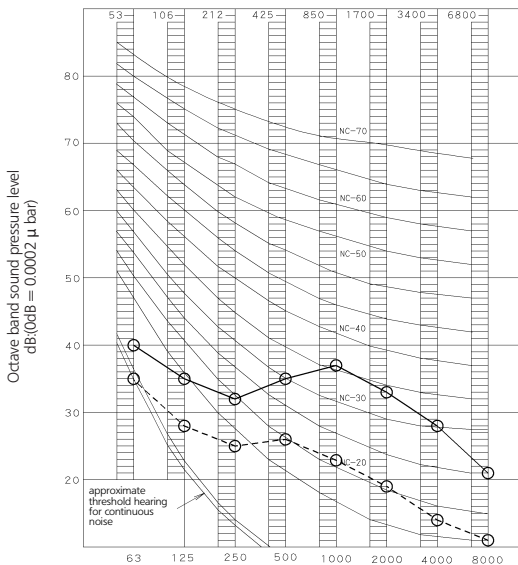

4D035255B

Octave band center frequency (Hz)

FTKS35C

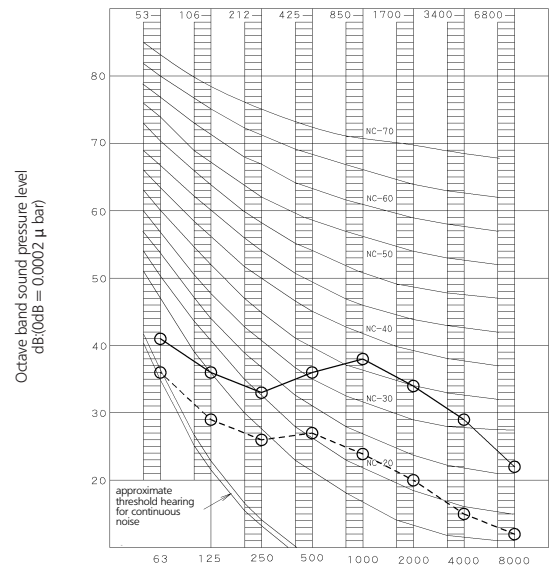

4D035256B

Octave band center frequency (Hz)



6 Sound level

6-2 Sound pressure spectrum

6

6-2

FTKS50B

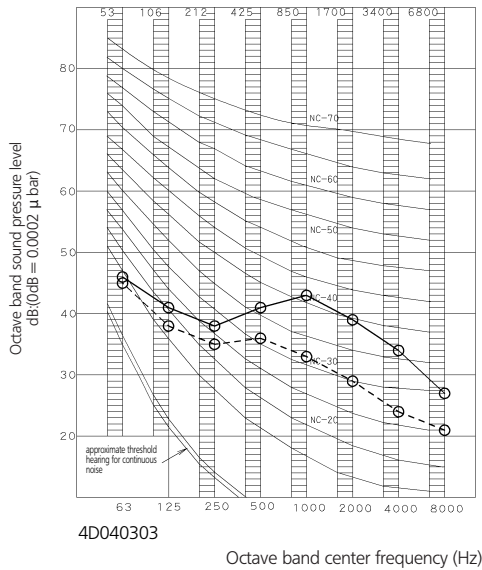

FTKS60B

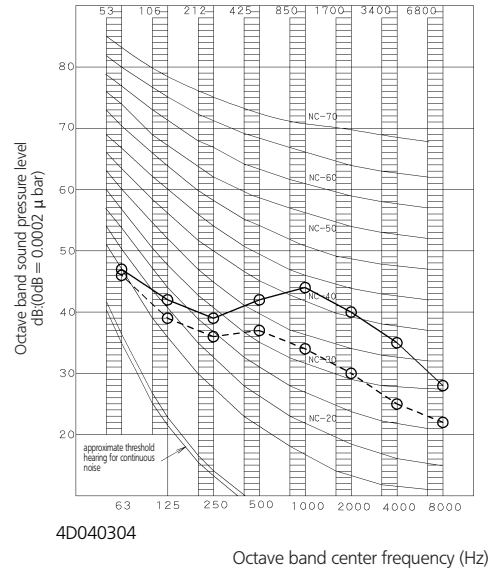

FTKS71B

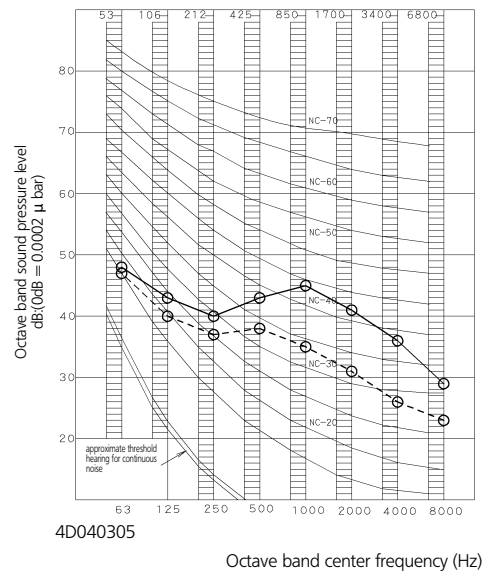

NOTE

- 1 Operation noise differs with operation and ambient conditions.

Legend

- 50/60Hz 220-240/220-230V(H)
- -○ 50/60Hz 220-240/220-230V(L)



6 Sound level

6-2 Sound pressure spectrum

Heat pump

6

6-2

FTXS20-25C (Cooling)

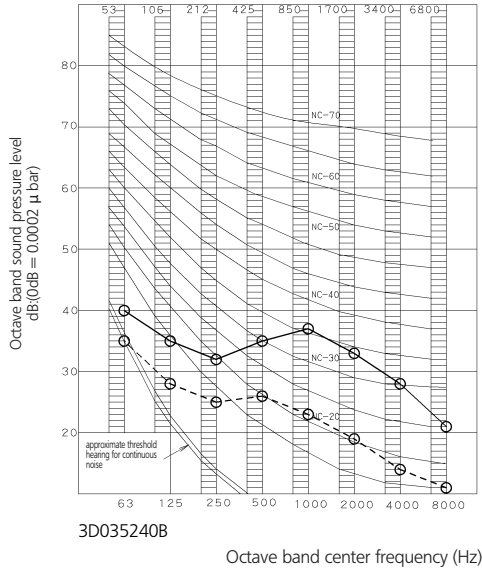

FTXS20-25C (Heating)

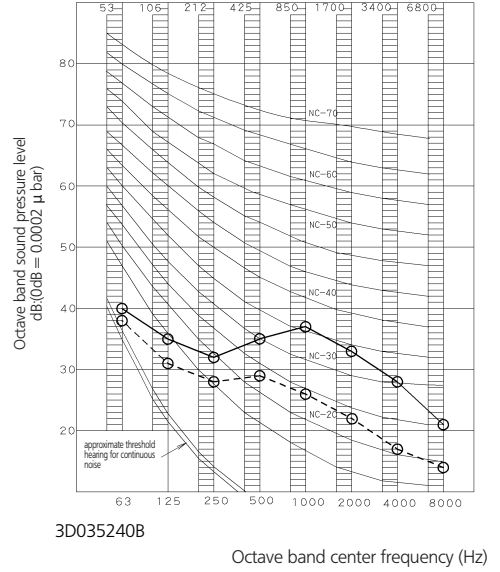

FTXS35C (Cooling)

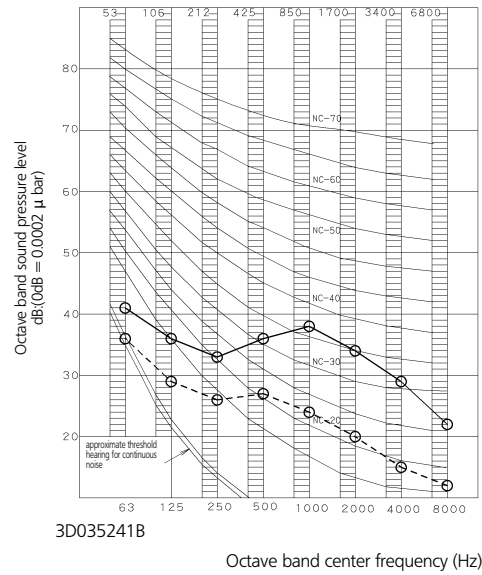

FTXS35C (Heating)

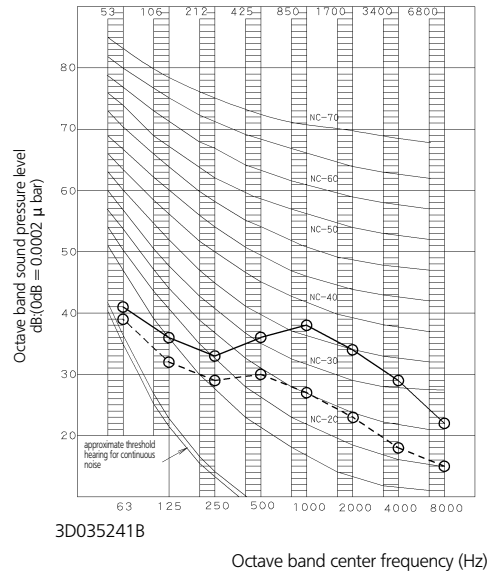

NOTE

- 1 Operation noise differs with operation and ambient conditions.

Legend

- 50/60Hz 220-240/220-230V(H)
- 50/60Hz 220-240/220-230V(L)



6 Sound level

6-2 Sound pressure spectrum

6

6-2

FTXS50B (Cooling)

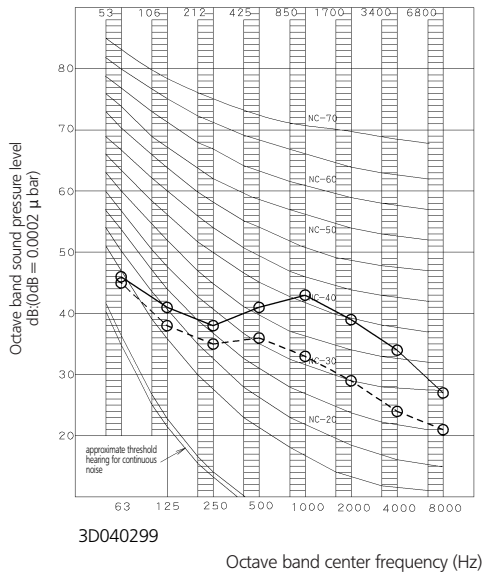

FTXS50B (Heating)

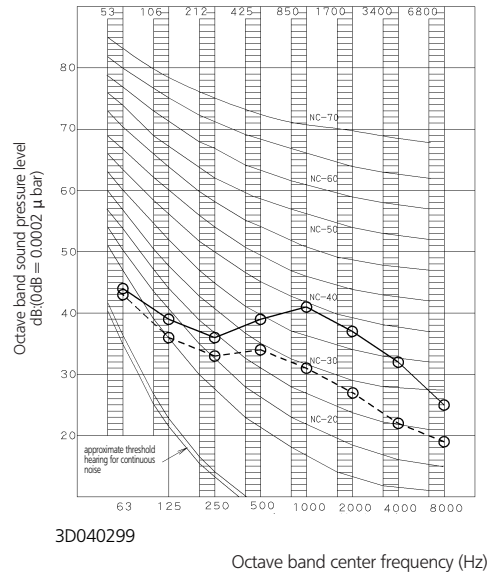

FTXS60B (Cooling)

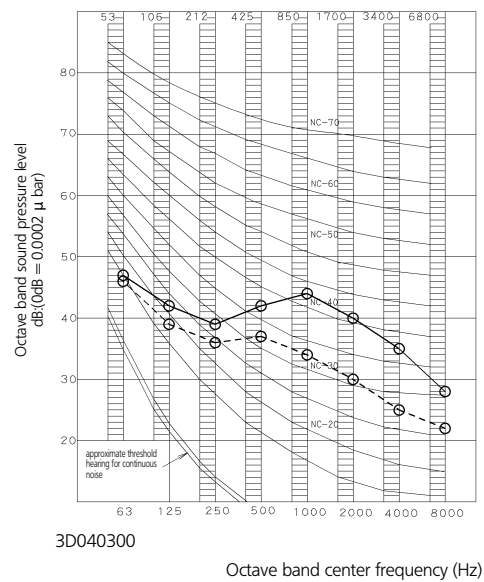

FTXS60B (Heating)

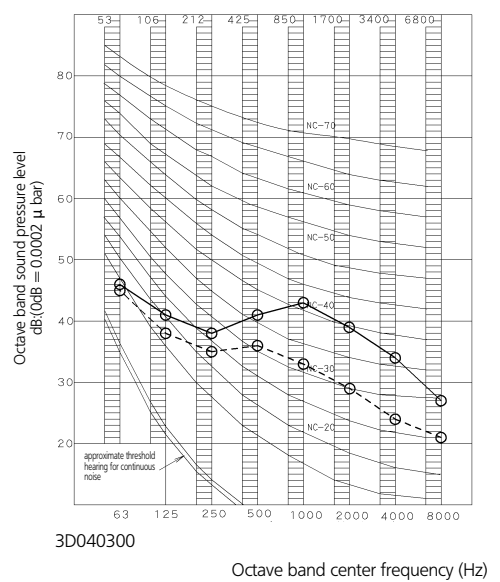

NOTE

- 1 Operation noise differs with operation and ambient conditions.

Legend

- 50/60Hz 220-240/220-230V(H)
- -○ 50/60Hz 220-240/220-230V(L)



6 Sound level

6-2 Sound pressure spectrum

6

6-2

FTXS71B (Cooling)

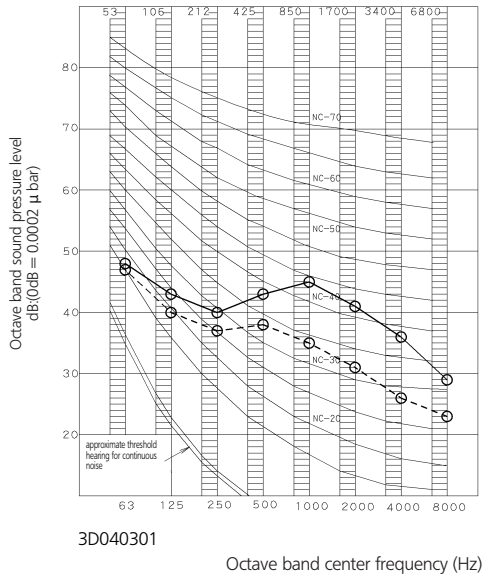

FTXS71B (Heating)

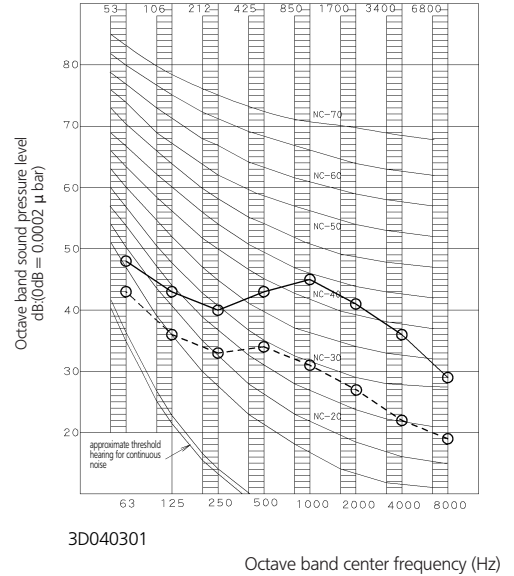

NOTE

1 Operation noise differs with operation and ambient conditions.

Legend

- 50/60Hz 220-240/220-230V(H)
- -○ 50/60Hz 220-240/220-230V(L)



7 Accessories

7-1 Standard accessories

7
7-1

FTK/XS20-25-35C

Ⓐ Mounting plate	1	Ⓔ Remote control holder	1	Ⓚ Operation manual	1
Ⓑ Air purification filter with photocatalytic deodorising function	2	Ⓞ AAA dry-cell batteries	2	Ⓛ Installation manual	1
Ⓒ Infrared remote control	1	Ⓜ Indoor unit fixing screws M4x12L	2		

FTK/XS50-60-71B

Ⓐ Mounting plate	1	Ⓔ Remote control holder	1	Ⓚ Operation manual	2
Ⓑ Air purification filter with photocatalytic deodorising function	2	Ⓞ AAA dry-cell batteries	1	Ⓛ Installation manual	1
Ⓒ Infrared remote control	1	Ⓜ Indoor unit fixing screws M4x12L	2		

7-2 Optional accessories

FTK/XS-C/B

Option name		20	25	35	50	60	71
Wiring adapter for time clock / remote control (1)	Normal open contact						KRP413A1S
	Normal open pulse contact						KRP413A1S
Centralised control board	1 up to 5 rooms (2)						KRC72
Central remote control							DCS302C51
Unified ON/OFF control							DCS301B51
Schedule timer							DST301B51
Interface adapter (3)							KRP928A2S
Air purification filter with photocatalytic deodorising function (with frame)							KAF918A43
Air purification filter with photocatalytic deodorising function (without frame)							KAF918A44
Anti-theft protection for remote control							KKF917A4

- (1) Wiring adapter is also required for each indoor unit.
- (2) Wiring adapter supplied by Daikin. Time clock and other devices: field supply.
- (3) Interface adapter for room air conditioners (DIII-NET)



8 Control systems

8-1 Infrared remote control

FTK/XS20-25-35C

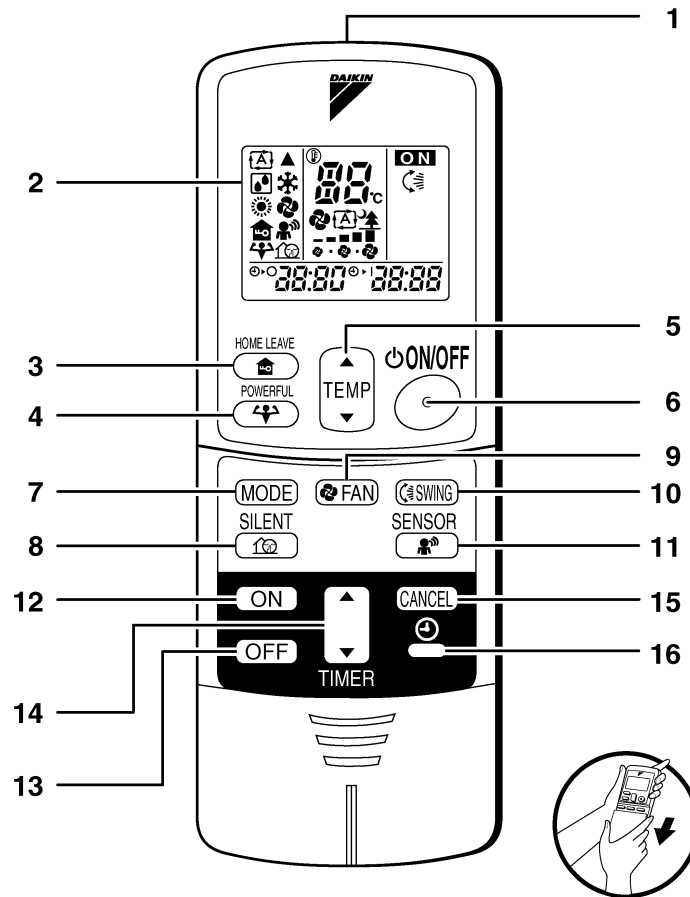

<ARC433A1, A2>

- | | |
|--|--|
| <p>1 Signal transmitter:
• It sends signals to the indoor unit.</p> <p>2 Display:
• It displays the current settings. (In this illustration, each section is shown with all its displays ON for the purpose of explanation.)</p> <p>3 HOME LEAVE button:
for HOME LEAVE operation</p> <p>4 POWERFUL button:
for POWERFUL operation</p> <p>5 TEMPERATURE adjustment buttons:
• It changes the temperature setting</p> <p>6 ON/OFF button:
• Press this button once to start operation. Press once again to stop it.</p> <p>7 MODE selector button:
• It selects the operation mode
(Auto / Dry / Cool / Heat / Fan)</p> | <p>8 OUTDOOR UNIT SILENT button:
SILENT operation</p> <p>9 FAN setting button:
• It selects the air flow rate setting.</p> <p>10 SWING button</p> <p>11 SENSOR button: for INTELLIGENT EYE
Operation</p> <p>12 ON TIMER button</p> <p>13 OFF TIMER button</p> <p>14 TIMER setting button:
• It changes the time setting</p> <p>15 TIMER CANCEL button:
It cancels the timer setting.</p> <p>16 CLOCK button</p> |
|--|--|

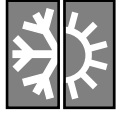

8 Control systems

8-1 Infrared remote control

8

8-1

FTK/XS50-60-71B

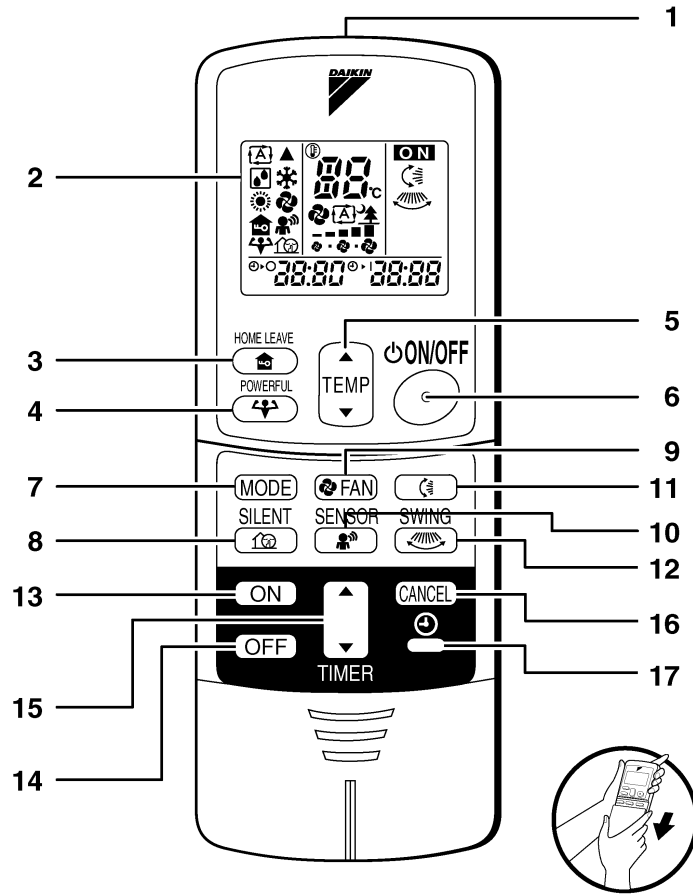

<ARC433A21, A22>

- | | |
|--|---|
| <p>1 Signal transmitter:
• It sends signals to the indoor unit.</p> <p>2 Display:
• It displays the current settings. (In this illustration, each section is shown with all its displays ON for the purpose of explanation.)</p> <p>3 HOME LEAVE button:
for HOME LEAVE operation</p> <p>4 POWERFUL button:
for POWERFUL operation</p> <p>5 TEMPERATURE adjustment buttons:
• It changes the temperature setting</p> <p>6 ON/OFF button:
• Press this button once to start operation. Press once again to stop it.</p> <p>7 MODE selector button:
• It selects the operation mode
(Auto / Dry / Cool / Heat / Fan)</p> | <p>8 OUTDOOR UNIT SILENT button:
SILENT operation</p> <p>9 FAN setting button:
• It selects the air flow rate setting.</p> <p>10 SENSOR button: for INTELLIGENT EYE
Operation</p> <p>11 SWING button
• Flap (horizontal blade)</p> <p>12 SWING button
• Louver (Vertical blades)</p> <p>13 ON TIMER button</p> <p>14 OFF TIMER button</p> <p>15 TIMER setting button:
• It changes the time setting</p> <p>16 TIMER CANCEL button:
It cancels the timer setting.</p> <p>17 CLOCK button</p> |
|--|---|



9 Center of gravity

FTK/XS20-25-35C

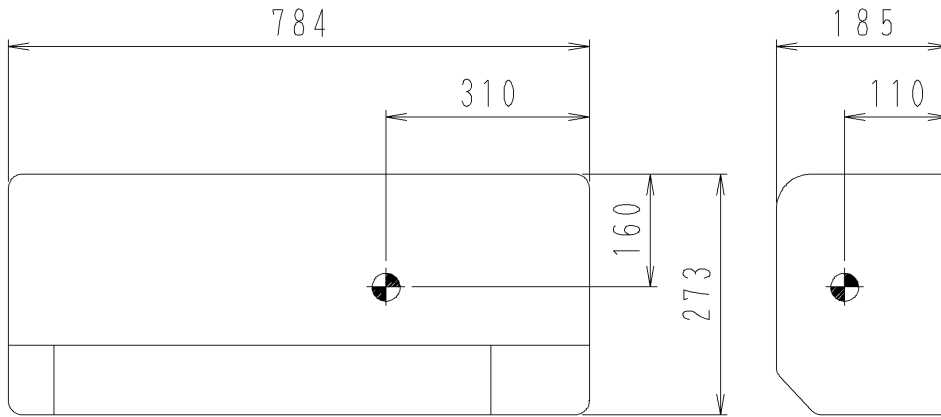

4D020686H

FTK/XS50B

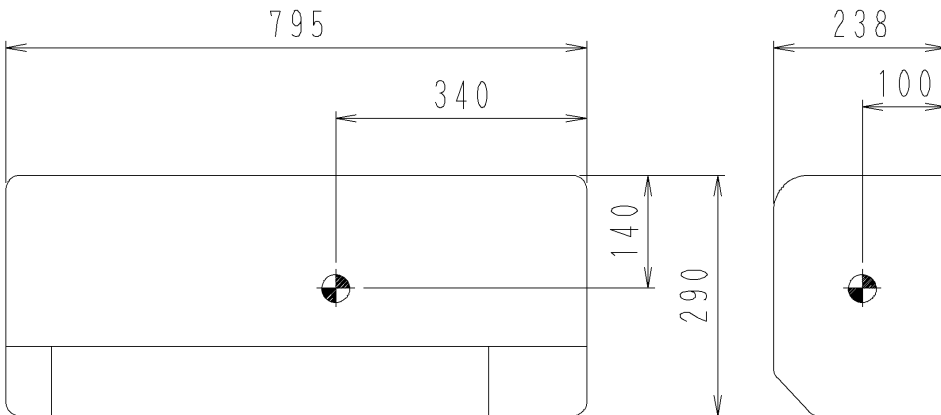

4D040311

FTK/XS60-71B

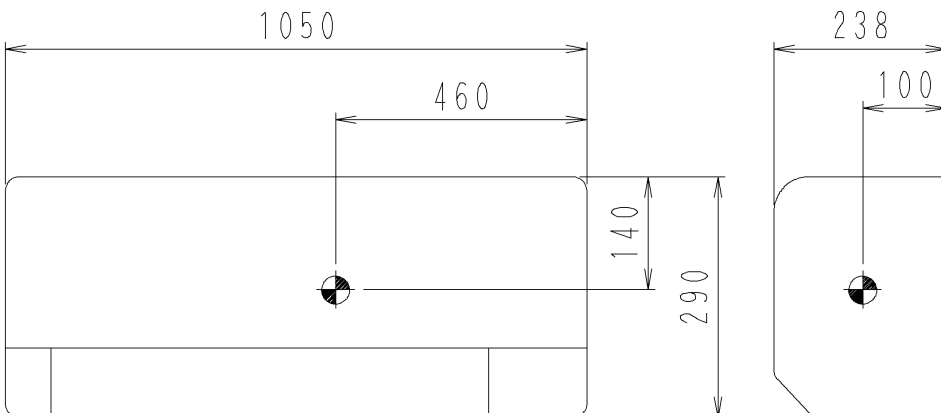

4D040313



10 Installation

10

FTK/XS20-25-35C

Indoor unit installation drawings

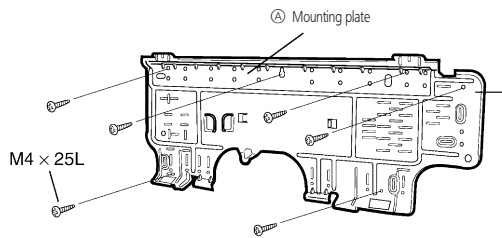

- How to attach the indoor unit.**
 Hook the claws of the bottom frame to the mounting plate.
 If the claws are difficult to hook, remove the front panel.
- How to remove the indoor unit.**
 Push up the marked area (at the lower part of the front panel) to release the claws. If it is difficult to release, remove the front panel.

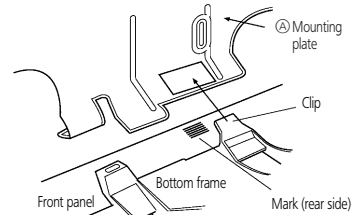

The mounting plate should be installed on a wall which can support the weight of the indoor unit.

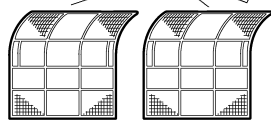
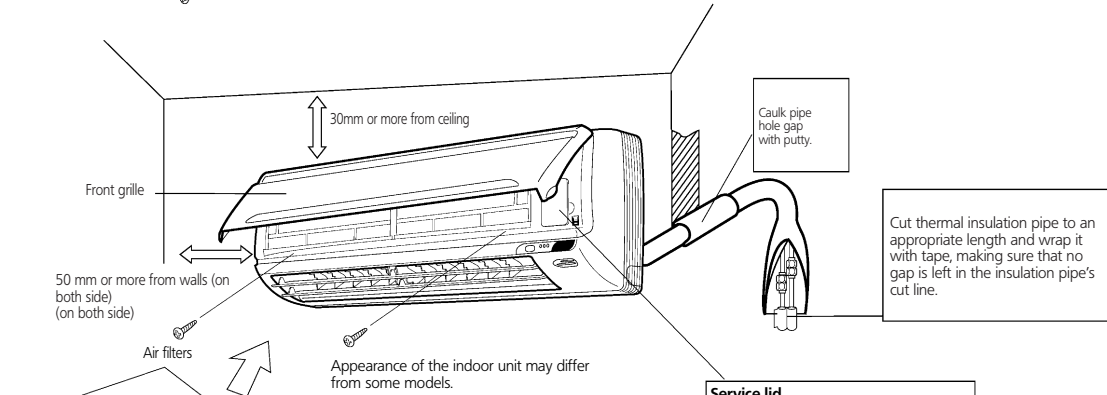

Ⓒ Air purification filter with photocatalytic deodorising function

Tabs (upper 3 locations)

Insert the upper side of the Ⓒ Air purification filter with photocatalytic deodorising function into the tabs (upper 3 locations), push the lower side of the filters up a little and into the tabs (lower 2 locations).

Insert the lower side of the Ⓒ Air purification filter with photocatalytic deodorising function into the tabs (lower 2 locations).

Service lid
This service lid is an open/close type.

- Remove the screws on the service lid.
- Slide the service lid leftward.
- Rotate the service lid upward.

Ⓓ Infrared remote control

Ⓔ Remote control holder

(M3 x 20L)

Before screwing the remote control holder to the wall, make sure that control signals are properly received by indoor unit.



10 Installation

FTK/XS50-60-71B

Indoor unit installation drawings

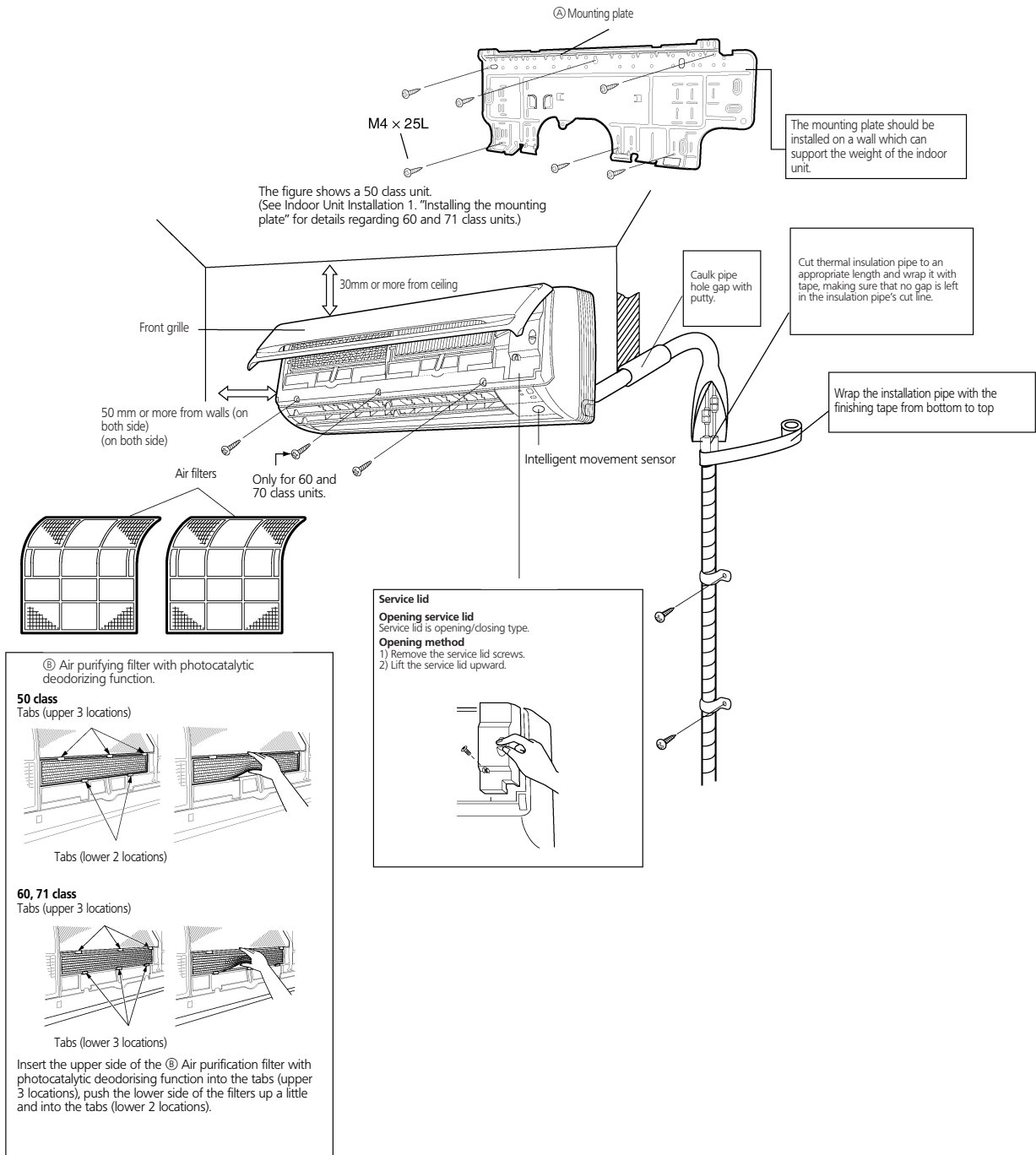

Movement sensor

Caution

- 1) Do not hit or violently push the movement sensor. This can lead to damage and malfunction.
- 2) Do not place large objects near the sensor. Also keep heating units or humidifiers outside the sensor's detection area.