



# technical data

**FLKS/FLXS-B**



**Flexi Type,  
Inverter Controlled Unit**



air conditioning systems

# Split Sky Air

# Split - Sky Air



ISO14001 assures an effective environmental management system in order to help protect human health and the environment from the potential impact of our activities, products and services and to assist in maintaining and improving the quality of the environment



Daikin units comply with the European regulations that guarantee the safety of the product.



Daikin Europe N.V. is approved by LRQA for its Quality Management System in accordance with the ISO9001 standard. ISO9001 pertains to quality assurance regarding design, development, manufacturing as well as to services related to the product.



Daikin Europe N.V. is participating in the EUROVENT Certification Programme. Products are as listed in the EUROVENT Directory of Certified Products. Multi Units are certified by Eurovent for combinations up to 2 indoor units.

Specifications are subject to change without prior notice.

## **DAIKIN EUROPE N.V.**

Zandvoordestraat 300  
B - 8400 Ostend Belgium  
Internet: <http://www.daikineurope.com>

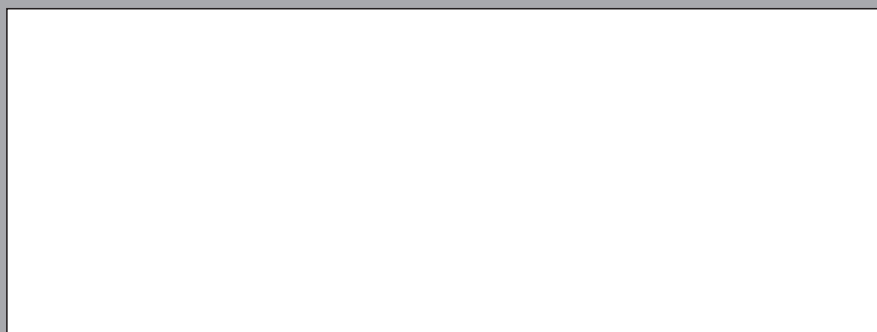

# TABLE OF CONTENTS

## FLKS/FLXS-B



1	Features .....	2
2	Specifications .....	3
	Nominal capacity, capacity steps and nominal input	
	Technical specifications	
	Electrical specifications	
3	Dimensional drawings .....	9
4	Piping diagrams .....	10
5	Wiring diagrams .....	11
6	Sound level .....	12
	Sound level data	
	Sound pressure spectrum	
7	Accessories .....	16
	Standard accessories	
	Optional accessories	
8	Control systems .....	17
9	Center of gravity .....	18
10	Installation .....	19

\* For capacity tables, please refer to part II: outdoor units





# 1 Features























1

- Lightweight but sturdy design
- Can fit on either ceiling or lower wall. Its low height enables it to fit beneath a window
- Consumes up to 30% less energy than non-inverter units
- The home leave operation saves energy during absence.
- Powerful mode can be selected for rapid cooling or heating.
- Automatic air flow director ensures uniform air flow and temperature distribution
- Air purification filter
  - deodorises the air
  - helps to prevent bacterial and viral propagation
- Photocatalytic deodorising air filter:
  - powerful decomposes cigarette and pet odours
  - removes house dust and pollen
  - deactivates bacteria and viruses
- Washable grille
- Indoor / outdoor unit silent operation:
 

Silent buttons on the remote control lower the operating sound of the indoor and/or outdoor unit by 3dB(A) each.

Remark: Only applicable in combination with DC-inverter outdoor units!
- Night quiet mode automatically reduces the operating sound of the outdoor unit by 3dB(A) at night. (multi outdoors in cooling mode only)
- Up to 4 indoor units can be connected to 1 Multi outdoor unit. All indoor units are individually controllable with remote control and do not need to be installed in the same room. They operate simultaneously within the same cooling or heating mode.
- The outdoor unit can easily be mounted on a roof, a terrace or placed against an outside wall.
- Outdoor units are fitted with a swing compressor, renowned for its low noise and energy efficiency.
- The remote control has a 24 hour timer
- The indoor model also has a start/stop button mounted on the front panel
- Up to 5 indoor units can be regulated from a single centralised control
- Purpose designed holder provided for your remote control



 Standard	 Optional		 AUTO		 FLXS	 AUTO	 FLKS	 5 steps
		 DRY						
	 Only in combination with DC-inverter outdoor units	 Only in combination with DC-inverter outdoor units	 MKS/MXS (cooling application only)					



## 2 Specifications

2

NOMINAL CAPACITY and NOMINAL INPUT							
For indoor units only:							
INDOOR UNITS				FLKS25BVMB	FLKS35BVMB	FLKS50BVMB	FLKS60BVMB
NOMINAL INPUT	Cooling	nominal	kW	0.074	0.078	0.096	0.098

For combination indoor units + outdoor units:							
INDOOR UNITS				FLKS25BVMB	FLKS35BVMB	FLKS50BVMB	FLKS60BVMB
OUTDOOR UNITS - PAIR APPLICATION				RKS25BVMB	RKS35BVMB	RKS50BVMB	Multi appl. only
NOMINAL CAPACITY (2-3)	Cooling (1)	min.~nom.~max.	kW	1.00~2.50~3.00	1.00~3.50~3.70	0.90~4.90~5.30	For more information, please refer to our Multi Model catalogue or contact your local dealer.
NOMINAL INPUT	Cooling	min.~nom.~max.	kW	0.24~0.715~0.925	0.24~1.22~1.30	0.45~1.72~1.95	
EER				3.50	2.87	2.85	
ENERGY LABEL	Cooling		kW	A	C	C	
ANNUAL ENERGY CONSUMPTION	Cooling		kW	357.5	610	860	
OUTDOOR UNITS - MULTI APPLICATION				2MKS40/3MKS50/4MKS58,75,90B		4MKS58,75,90B	4MKS75,90B
For more information, see chapter MKS-B							

For combination indoor units + outdoor units:							
INDOOR UNITS				FLKS25BVMB	FLKS35BVMB	FLKS50BVMB	
OUTDOOR UNITS - PAIR APPLICATION				RK25BVMB	RK35BVMB	RS50BVMB	
NOMINAL CAPACITY (2-3)	Cooling (1)	min.~nom.~max.	kW	1.30~2.50~3.00	1.40~3.43~3.80	4.90 (nom.)	
NOMINAL INPUT	Cooling	min.~nom.~max.	kW	0.43~0.89~1.25	0.50~1.315~1.72	1.72 (nom.)	
EER				2.81	2.61	2.85	
ENERGY LABEL	Cooling		kW	C	D	C	
ANNUAL ENERGY CONSUMPTION	Cooling		kW	445	657.5	860	
OUTDOOR UNITS - MULTI APPLICATION				-	-	-	
				-	-	-	



## 2 Specifications

2

TECHNICAL SPECIFICATIONS								
For indoor units only:								
INDOOR UNITS				FLKS25BVMB	FLKS35BVMB	FLKS50BVMB	FLKS60BVMB	
DIMENSIONS	Unit	H	mm	490				
		W	mm	1,050				
		D	mm	200				
WEIGHT	Unit	kg		16		17		
COLOUR	Unit	Almond white						
SOUND LEVEL	Sound pressure (cooling) (4)	high	dBA	37	38	47	48	
		low	dBA	31	32	39	41	
		super low	dBA	28	29	36	39	
	Sound power (cooling) (5)	dBA		53	54	63	64	
FAN	Air flow rate (cooling)	high	m <sup>3</sup> /min	7.6	8.6	11.4	12.0	
		low	m <sup>3</sup> /min	6.0	6.6	8.5	9.3	
		super low	m <sup>3</sup> /min	5.2	5.6	7.5	8.3	
	Speed	steps		5 steps, silent and auto				
		high	rpm	820	920	1,380	1,380	
		medium	rpm	740	820	1,240	1,240	
		low	rpm	660	720	1,100	1,100	
		super low	rpm	580	620	1,000	1,000	
Type	Sirocco fan							
Motor output	W		34					
HEAT EXCHANGER	Type	ML fin - $\phi$ 8Hi - XA tube						
	Rows x stages x fin pitch	mm	2 x 24 x 1.5	2 x 24 x 1.5	1 x 32 x 1.6	-		
AIR FILTER	Removable/washable/mildew proof							
TEMPERATURE CONTROL	Microcomputer control							
PIPING CONNECTIONS	liquid	mm	$\phi$ 6.4					
	gas	mm	$\phi$ 9.5		$\phi$ 12.7			
	drain	mm	$\phi$ 18.0					
INSULATION MATERIAL	Heat insulation tape		Both liquid and gas pipes					
For outdoor units	Pair application	See chapter RKS-B / RK-B / RS-B						
	Multi application	See chapter MKS-B						

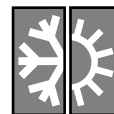

## 2 Specifications

2

ELECTRICAL SPECIFICATIONS							
For indoor units only:				FLKS25BVMB	FLKS35BVMB	FLKS50BVMB	FLKS60BVMB
CURRENT	Nominal running current	cooling	A	0.34	0.36	0.45	0.45
	Maximum running current	cooling	A	See chapter RKS-B: electrical data			

For combination indoor units + outdoor units:				FLKS25BVMB	FLKS35BVMB	FLKS50BVMB	FLKS60BVMB
				RKS25BVMB	RKS35BVMB	RKS50BVMB	Multi appl. only
CURRENT	Nominal running current	cooling	A	3.8	5.7	7.6	-
	Maximum running current	cooling	A	See chapter RKS-B: electrical data			
	Starting current	cooling	A				

For combination indoor units + outdoor units:				FLKS25BVMB	FLKS35BVMB	FLKS50BVMB
				RK25BVMB	RK35BVMB	RS50BVMB
CURRENT	Nominal running current	cooling	A	4.2	5.9	7.6
	Maximum running current	cooling	A	See chapter RK-B: electrical data		See chapter RS-B: electrical data
	Starting current	cooling	A			

For combination indoor units + outdoor units:				FLKS25BVMB	FLKS35BVMB	FLKS50BVMB	FLKS60BVMB
				2MKS40/3MKS50/4MKS58,75,90B		4MKS58,75,90B	4MKS75,90B
CURRENT	Nominal running current	cooling	A	See chapter MKS-B: electrical data			
	Maximum running current	cooling	A				
	Starting current	cooling	A				

For indoor units only:				FLKS25BVMB	FLKS35BVMB	FLKS50BVMB	FLKS60BVMB
POWER SUPPLY				VM	VM	VM	VM
NOMINAL DISTRIBUTION SYSTEM VOLTAGE	Phase			1~	1~	1~	1~
	Frequency		Hz	50	50	50	50
	Voltage		V	230	230	230	230

### NOTES

- Nominal cooling capacities are based on: indoor temperature 27°CDB/19°CWB \* outdoor temperature 35°CDB \* refrigerant piping length: 7.5m \* level difference: 0m.
- Capacities are net, including a deduction for cooling (an addition for heating) for indoor fan motor heat.
- Units should be selected on nominal capacity. Maximum capacity is limited to peak periods.
- The sound pressure level is measured via a microphone at a certain distance from the unit. For measuring conditions: please refer to item 6 of this chapter.
- The sound power level is an absolute value indicating the "power" which a sound source generates.
- Energy label: scale from A (most efficient) to G (less efficient).
- Annual energy consumption: based on average use of 500 running hours per year at full load (= nominal conditions)

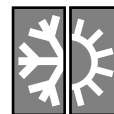

## 2 Specifications

2

NOMINAL CAPACITY and NOMINAL INPUT							
For indoor units only:							
INDOOR UNITS				FLXS25BVMB	FLXS35BVMB	FLXS50BVMB	FLXS60BVMB
NOMINAL INPUT	Cooling	nominal	kW	0.32	0.078	0.096	0.098
	Heating	nominal	kW	0.34	0.078	0.096	0.096

For combination indoor units + outdoor units:							
INDOOR UNITS				FLXS25BVMB	FLXS35BVMB	FLXS50BVMB	FLXS60BVMB
OUTDOOR UNITS - PAIR APPLICATION				RXS25BVMB	RXS35BVMB	RXS50BVMB	Multi appl. only
NOMINAL CAPACITY (3-4)	Cooling (1)	min.~nom.~max.	kW	1.00~2.50~3.00	1.00~3.50~3.70	0.90~4.90~5.30	For more information, please refer to our Multi Model catalogue or contact your local dealer.
	Heating (2)	min.~nom.~max.	kW	1.00~3.40~5.00	1.00~4.50~5.00	0.90~6.10~7.50	
NOMINAL INPUT	Cooling	min.~nom.~max.	kW	0.24~0.715~0.925	0.24~1.22~1.30	0.45~1.72~1.95	
	Heating	min.~nom.~max.	kW	0.24~0.94~1.43	0.24~1.38~1.83	0.31~1.82~3.54	
EER	Cooling			3.50	2.87	2.85	
COP	Heating			3.62	3.26	3.35	
ENERGY LABEL	Cooling			A	C	C	
	Heating			A	C	C	
ANNUAL ENERGY CONSUMPTION	Cooling		kW/h	357.5	610	860	
OUTDOOR UNITS - MULTI APPLICATION				2MXS40/3MXS52/4MXS68,80B		3MXS52/4MXS68,80B	
For more information, see chapter MXS-B							

For combination indoor units + outdoor units:							
INDOOR UNITS				FLXS25BVMB	FLXS35BVMB		
OUTDOOR UNITS - PAIR APPLICATION				RX25BVMB	RX35BVMB		
NOMINAL CAPACITY (3-4)	Cooling (1)	min.~nom.~max.	kW	1.30~2.50~3.00	1.40~3.43~3.80		
	Heating (2)	min.~nom.~max.	kW	1.30~3.30~4.00	1.40~4.10~5.00		
NOMINAL INPUT	Cooling	min.~nom.~max.	kW	0.43~0.89~1.25	0.50~1.315~1.72		
	Heating	min.~nom.~max.	kW	0.35~1.08~1.35	0.405~1.355~1.90		
EER	Cooling			2.81	2.61		
COP	Heating			3.06	3.03		
ENERGY LABEL	Cooling			C	D		
	Heating			D	D		
ANNUAL ENERGY CONSUMPTION	Cooling		kW/h	445	657.5		
OUTDOOR UNITS - MULTI APPLICATION				-	-		
				-	-		



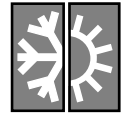

## 2 Specifications

2

TECHNICAL SPECIFICATIONS								
For indoor units only:								
INDOOR UNITS				FLXS25BVMB	FLXS35BVMB	FLXS50BVMB	FLXS60BVMB	
DIMENSIONS	Unit	H	mm	490				
		W	mm	1,050				
		D	mm	200				
WEIGHT	Unit	kg		16		17		
COLOUR	Unit	Almond white						
SOUND LEVEL	Sound pressure (cooling/heating) (5)	high	dBA	37/37	38/39	47/46	48/47	
		low	dBA	31/31	32/33	39/35	41/37	
		super low	dBA	28/29	29/30	36/33	39/34	
	Sound power (cooling/heating) (6)	high	dBA	53/*	54/*	63/*	64/*	
FAN	Air flow rate (cooling/heating)	high	m <sup>3</sup> /min	7.6/9.2	8.6/9.8	11.4/12.1	12.0/12.8	
		low	m <sup>3</sup> /min	6.0/7.4	6.6/8.0	8.5/7.5	9.3/8.4	
		super low	m <sup>3</sup> /min	5.2/6.6	5.6/7.2	7.5/6.8	8.3/7.5	
	Speed (cooling/heating)	steps	5 steps, silent and auto					
		high	rpm	820/880	920/940	1,380/1,320	1,380/1,320	
		medium	rpm	740/790	820/850	1,240/1,130	1,240/1,130	
		low	rpm	660/700	720/760	1,100/940	1,100/940	
		super low	rpm	580/620	620/680	1,000/860	1,000/860	
Type	Sirocco fan							
Motor output	W		34					
HEAT EXCHANGER	Type	ML fin, $\phi$ 7Hi-HA tube						
	Rows x stages x fin pitch	mm		2 x 24 x 1.5	2 x 24 x 1.5	3 x 10 x 1.5	3 x 10 x 1.5	
AIR FILTER	Removable/washable/mildew proof							
TEMPERATURE CONTROL	Microcomputer control							
PIPING CONNECTIONS	liquid	mm	$\phi$ 6.4					
		gas	mm	$\phi$ 9.5		$\phi$ 12.7		
		drain	mm	$\phi$ 18.0				
INSULATION MATERIAL	Heat insulation tape		Both liquid and gas pipes					
For outdoor units	Pair application	See chapter RXS-B / RX-B						
	Multi application	See chapter MXS-B						

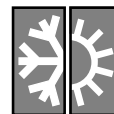

## 2 Specifications

2

ELECTRICAL SPECIFICATIONS							
<b>For indoor units only:</b>							
CURRENT	Nominal running current	cool/heat	A	0.32/0.34	0.36/0.36	0.45/0.45	0.45/0.43
	Maximum running current	cool/heat	A	See chapter RXS-B: electrical data			
<b>For combination indoor units + outdoor units:</b>							
CURRENT	Nominal running current	cool/heat	A	3.8/4.5	5.7/6.3	7.6/8.0	-
	Maximum running current	cool/heat	A	See chapter RXS-B: electrical data			
	Starting current	cool/heat	A				
<b>For combination indoor units + outdoor units:</b>							
CURRENT	Nominal running current	cool/heat	A	4.2/4.9	5.9/6.0		
	Maximum running current	cool/heat	A	See chapter RX-B: electrical data			
	Starting current	cool/heat	A				
<b>For combination indoor units + outdoor units:</b>							
CURRENT	Nominal running current	cool/heat	A	2MXS40/3MXS52/4MXS68,80B		3MXS52/4MXS68,80B	
	Maximum running current	cool/heat	A	See chapter MXS-B: electrical data			
	Starting current	cool/heat	A				
<b>For indoor units only:</b>							
POWER SUPPLY				VM	VM	VM	VM
NOMINAL DISTRIBUTION SYSTEM VOLTAGE	Phase			1~	1~	1~	1~
	Frequency		Hz	50	50	50	50
	Voltage		V	230	230	230	230

### NOTES

- Nominal cooling capacities are based on: indoor temperature 27°CDB/19°CWB \* outdoor temperature 35°CDB \* refrigerant piping length: 7.5m \* level difference: 0m.
- Nominal heating capacities are based on: indoor temperature: 20°CDB \* outdoor temperature: 7°CDB/6°CWB \* refrigerant piping length: 7.5m \* level difference 0m.
- Capacities are net, including a deduction for cooling (an addition for heating) for indoor fan motor heat.
- Units should be selected on nominal capacity. Maximum capacity is limited to peak periods.
- The sound pressure level is measured via a microphone at a certain distance from the unit. For measuring conditions: please refer to item 6 of this chapter.
- The sound power level is an absolute value indicating the "power" which a sound source generates.
- Energy label: scale from A (most efficient) to G (less efficient).
- Annual energy consumption: based on average use of 500 running hours per year at full load (= nominal conditions)



# 3 Dimensional drawings

3

**FLK/XS25-35-50-60B**  
**Ceiling suspended installation**  
 The mark (→) shows piping direction

Required service space (ceiling suspended)  
 (for performance and maintenance)

unit (mm)

200MIN (space for maintenance)      200MIN (space for performance)

Air flow (indoor)

- Liquid pipe (6.4CuT)
- Gas pipe (A CuT)

	A
FLX(K)S25BVMB	φ 9.5
FLX(K)S35BVMB	φ 9.5
FLX(K)S50BVMB	φ 12.7
FLX(K)S60BVMB	φ 12.7

Wall hole for refrigerant φ 65 hole

φ 40 drain hose hole  
 - Drain hose (ID φ 14 - OD φ 18)

Standard locations of wall holes

Wall hole for embedded piping φ 65 hole

50 min (space for maintenance)

Location of suspension bolts

3D033694B

**FLK/XS25-35-50-60B**  
**Floor level installation**  
 The mark (→) shows piping direction

Required space  
 (for performance and maintenance)

unit (mm)

200MIN (space for maintenance)      200MIN (space for performance)

Air flow (indoor)

- Liquid pipe (6.4CuT)
- Gas pipe (A CuT)
- Drain hose (ID φ 14 - OD φ 18)

	A
FLX(K)S25BVMB	φ 9.5
FLX(K)S35BVMB	φ 9.5
FLX(K)S50BVMB	φ 12.7
FLX(K)S60BVMB	φ 12.7

Wall hole for refrigerant piping φ 80 hole

Wall hole for embedded piping φ 80 hole

50MIN (space for maintenance)

Location of wall holes

3D033695C



# 4 Piping diagrams

4

## FLK/XS25-35-50-60B

	A	B	C
FLX(K)S25BVMB	φ 9.5	φ 9.5	φ 6.4
FLX(K)S35BVMB	φ 9.5	φ 9.5	φ 6.4
FLX(K)S50BVMB	φ 12.7	φ 12.7	φ 9.5
FLX(K)S60BVMB	φ 12.7	φ 12.7	φ 9.5

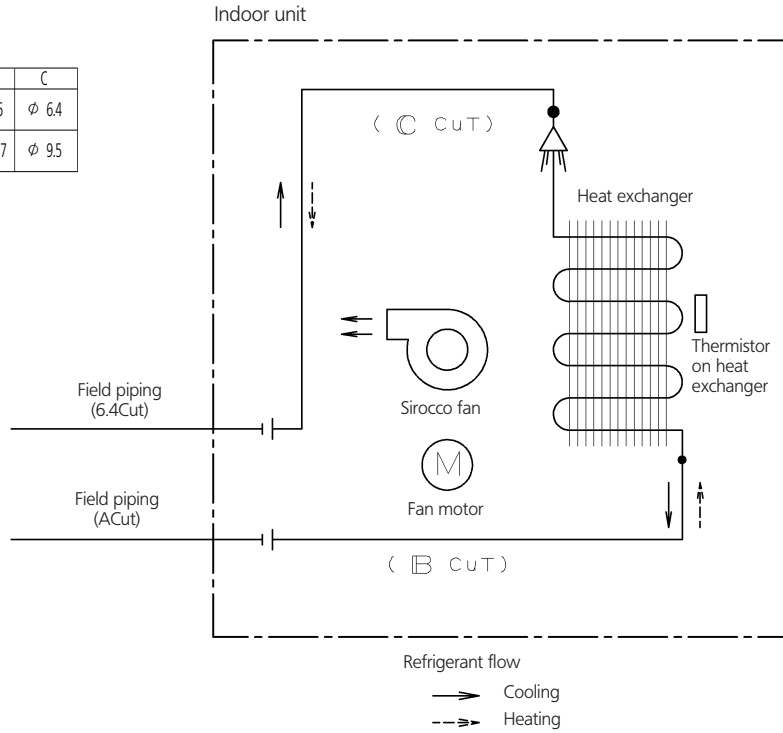

4D034012B



# 5 Wiring diagrams

5

FLK/XS25-35-50-60B

Notice that operation will restart automatically when the main power supply is turned off and then turned on again.

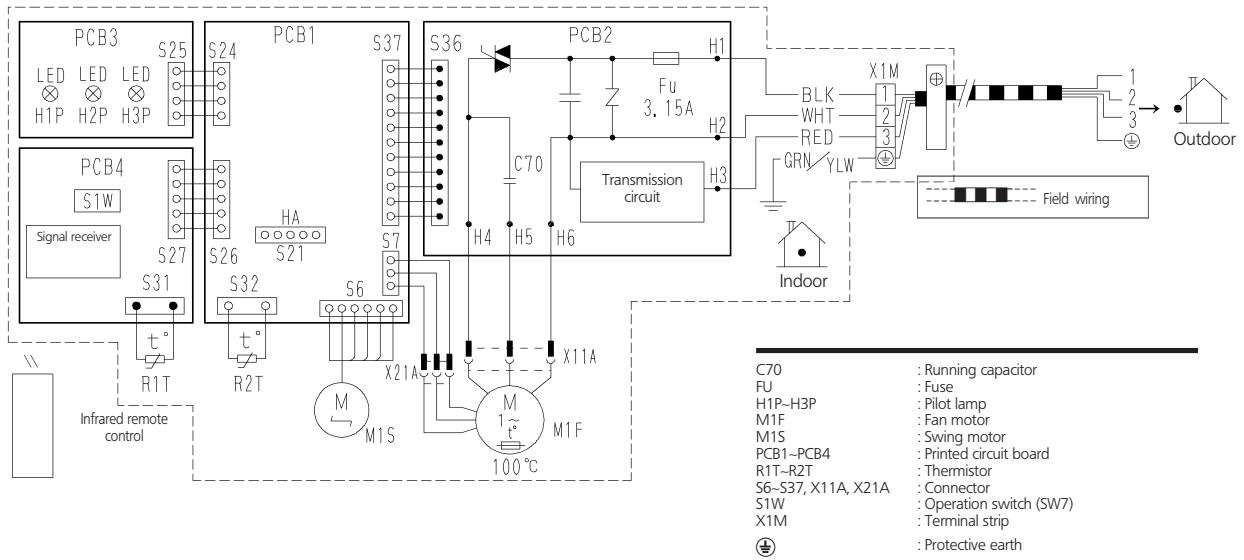

3D033909B



# 6 Sound level

## 6-1 Sound level data

### 6 Cooling only

6-1

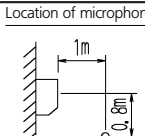
Model	Sound pressure level			Measuring location 	Sound power level (Cooling)
	230V, 50Hz				
	Cooling				
	H	L	SL		
FLKS25B	37	31	28		53
FLKS35B	38	32	29		54
FLKS50B	47	39	36		63
FLKS60B	48	41	39		64

### Heat pump

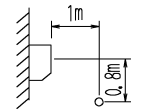
Model	Sound pressure level			Measuring location 	Sound power level (Cooling/Heating)
	230V, 50Hz				
	Cooling/Heating				
	H	L	SL		
FLXS25B	37/37	31/31	28/29		53/*
FLXS35B	38/39	32/33	29/30		54/*
FLXS50B	47/46	39/35	36/33		63/*
FLXS60B	48/47	41/37	39/34		64/63



# 6 Sound level

## 6-1 Sound pressure spectrum

Cooling only

6

6-1

FLKS25B

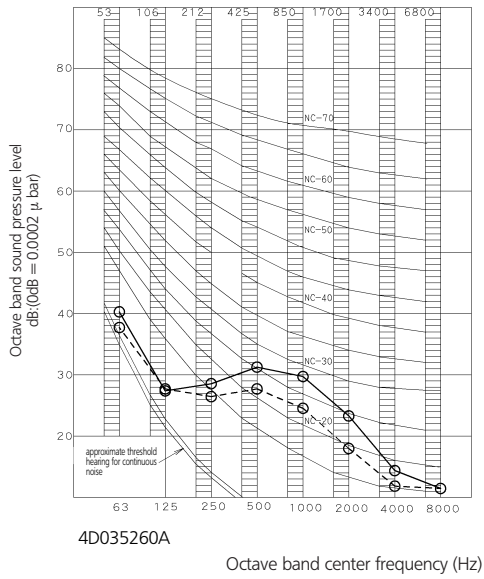

FLKS35B

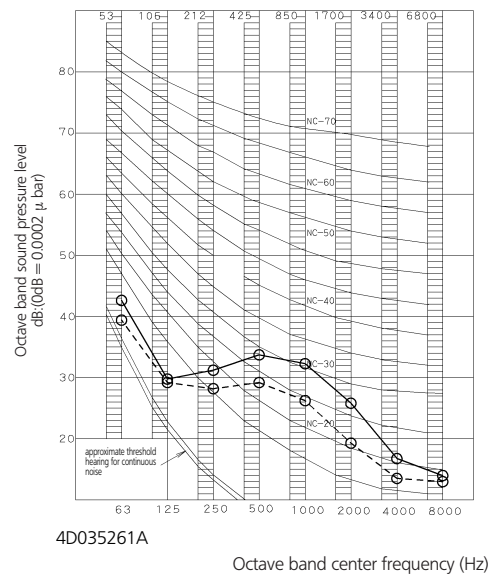

FLKS50B

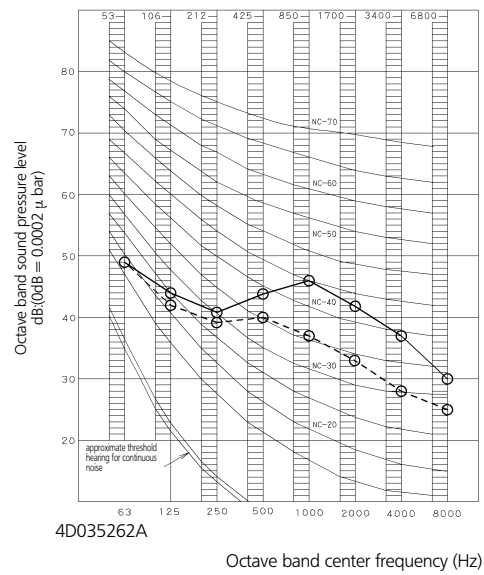

FLKS60B

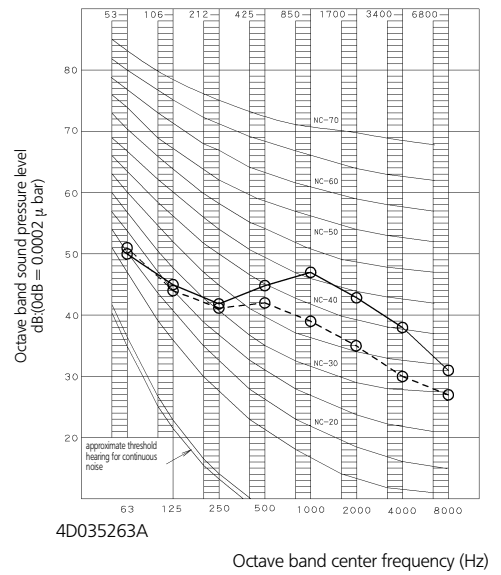

**NOTE**

- 1 Operation noise differs with operation and ambient conditions.

Legend

- 50/60Hz 220-240/220-230V(H)
- 50/60Hz 220-240/220-230V(L)

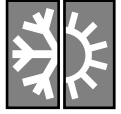

# 6 Sound level

## 6-1 Sound pressure spectrum

### 6 Heat pump

6-1

**FLXS25B (Cooling)**

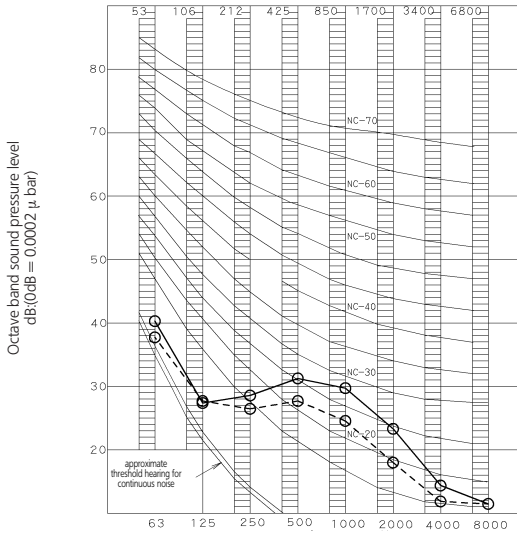

3D035245A

Octave band center frequency (Hz)

**FLXS25B (Heating)**

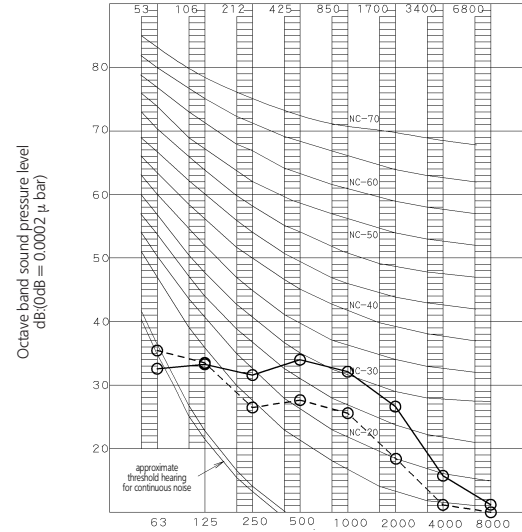

3D035245A

Octave band center frequency (Hz)

**FLXS35B (Cooling)**

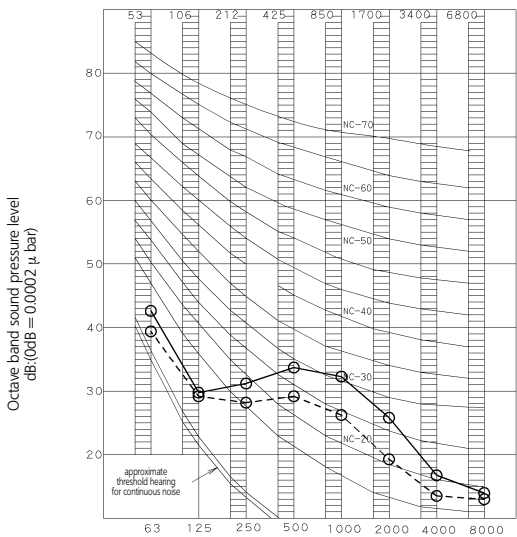

3D035246A

Octave band center frequency (Hz)

**FLXS35B (Heating)**

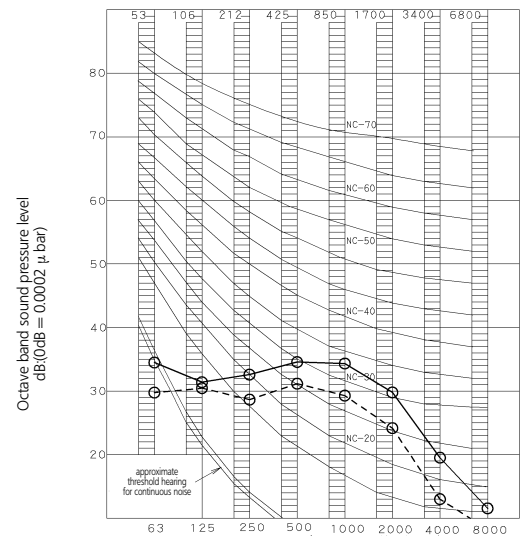

3D035246A

Octave band center frequency (Hz)

Legend

- 50/60Hz 220-240/220-230V(H)
- -○ 50/60Hz 220-240/220-230V(L)

**NOTES**

- 1 Operation sound is measured in an anechoic chamber.
- 2 Operation sound differs with operation and ambient conditions.





# 6 Sound level

## 6-1 Sound pressure spectrum

### Heat pump

6

6-1

FLXS50B (Cooling)

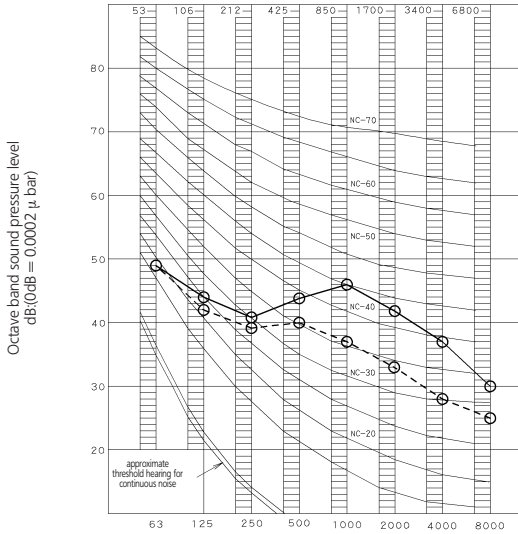

3D035247A

Octave band center frequency (Hz)

FLXS50B (Heating)

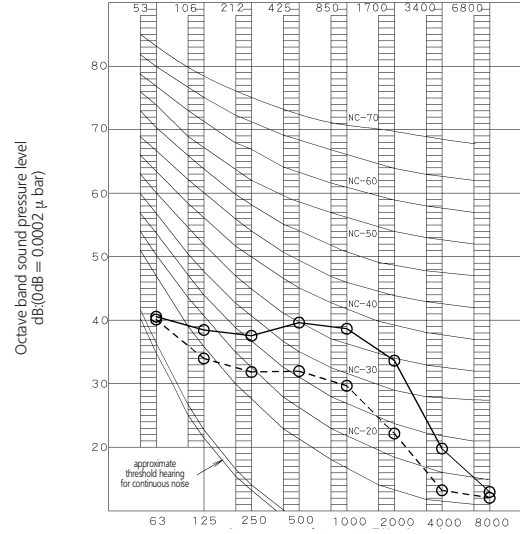

3D035247A

Octave band center frequency (Hz)

FLXS60B (Cooling)

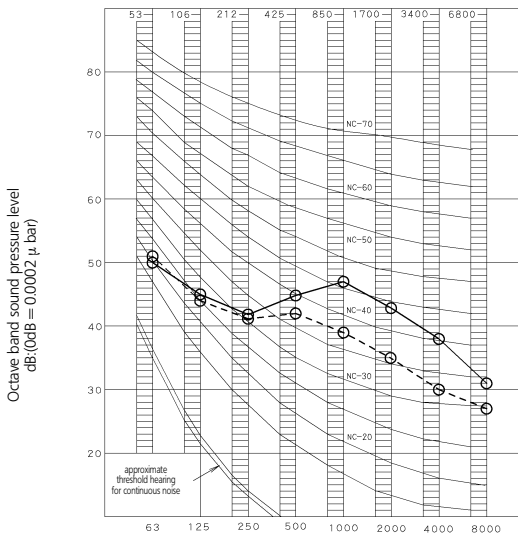

3D035248A

Octave band center frequency (Hz)

FLXS60B (Heating)

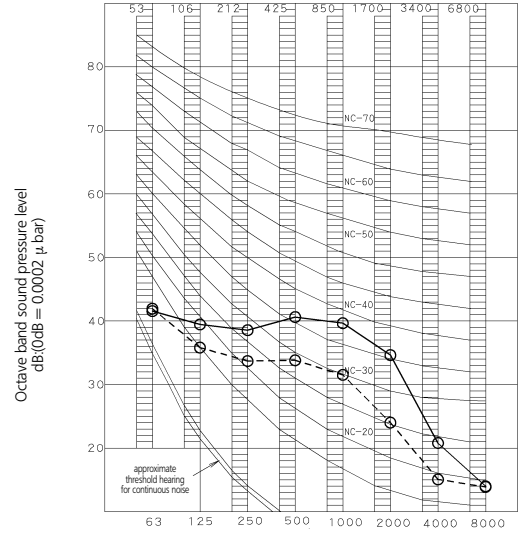

3D035248A

Octave band center frequency (Hz)

Legend

- 50/60Hz 220-240/220-230V(H)
- -○ 50/60Hz 220-240/220-230V(L)

NOTES

- 1 Operation sound is measured in an anechoic chamber.
- 2 Operation sound differs with operation and ambient conditions.



# 7 Accessories

## 7-1 Standard accessories

7  
7-1

### FLK/XS-B

Ⓐ Mounting plate	1	Ⓔ AAA dry-cell batteries	2	Ⓝ Heat insulation tube (Extension auxiliary pipe)	1
Ⓑ Photocatalytic deodorising filter	1	Ⓜ Side cover	2	Ⓓ Heat insulation tube (Refrigerant pipe)	1
Ⓒ Air purifying filter	1	Ⓚ Operation manual	1	Ⓛ Binding band	4
Ⓓ Infrared remote control	1	Ⓛ Installation manual	1		
Ⓔ Remote control holder	1	Ⓜ Extension auxiliary pipe	2		

The extension auxiliary pipe Ⓝ N is not included for FLXS25, FLXS35, FLKS25 and FLKS35

## 7-2 Optional accessories

### FLK/XS-B

Option name		25	35	50	60
Wiring adapter for time clock / remote control (1)	Normal open contact			KRP413A1S	
	Normal open pulse contact			KRP413A1S	
Centralised control board	1 up to 5 rooms (2)			KRC72	
Central remote control				DCS302B51	
Unified ON/OFF control				DCS301B51	
Schedule timer				DCT301B51	
Interface adapter (3)				KRP928A2S	
Photocatalytic deodorising filter, with frame				KAZ917A41	
Photocatalytic deodorising filter, without frame				KAZ917A42	
Air purification filter with frame				KAF925B41	
Air purification filter without frame				KAF925B42	
Anti-theft protection for remote control				KKF910A4	

- (1) Wiring adapter is also required for each indoor unit.
- (2) Wiring adapter supplied by Daikin. Time clock and other devices: field supply.
- (3) For DIII-NET adapter



# 8 Control systems

## 8-1 Infrared remote control

FLK/XS-B

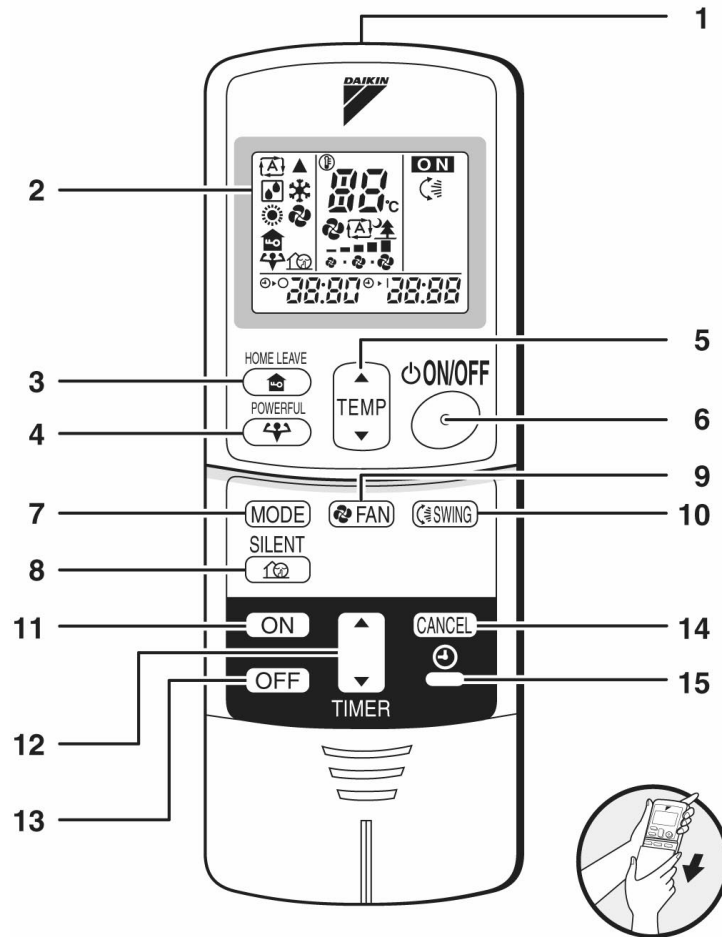

<ARC433A5, A6>

- |  |  |
|--|--|
| <p>1 <b>Signal transmitter:</b><br/>• It sends signals to the indoor unit.</p> <p>2 <b>Display:</b><br/>• It displays the current settings. (In this illustration, each section is shown with all its displays ON for the purpose of explanation.)</p> <p>3 <b>HOME LEAVE button:</b><br/>for HOME LEAVE operation</p> <p>4 <b>POWERFUL button:</b><br/>for POWERFUL operation</p> <p>5 <b>TEMPERATURE adjustment buttons:</b><br/>• It changes the temperature setting</p> <p>6 <b>ON/OFF button:</b><br/>• Press this button once to start operation. Press once again to stop it.</p> <p>7 <b>MODE selector button:</b><br/>• It selects the operation mode<br/>(Auto  / Dry  / Cool  / Heat  / Fan )</p> | <p>8 <b>OUTDOOR UNIT SILENT button:</b><br/>SILENT operation</p> <p>9 <b>FAN setting button:</b><br/>• It selects the air flow rate setting.</p> <p>10 <b>SWING button</b></p> <p>11 <b>ON TIMER button</b></p> <p>12 <b>OFF TIMER button</b></p> <p>13 <b>TIMER setting button:</b><br/>• It changes the time setting</p> <p>14 <b>TIMER CANCEL button:</b><br/>It cancels the timer setting.</p> <p>15 <b>CLOCK button</b></p> |
|--|--|



# 9 Center of gravity

9 FLK/XS-B

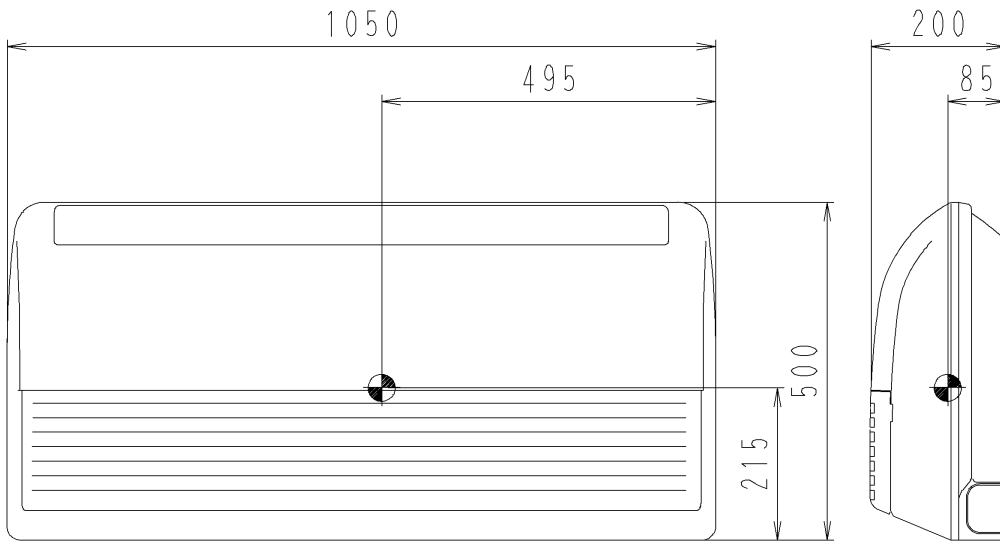

4D027653C



# 10 Installation

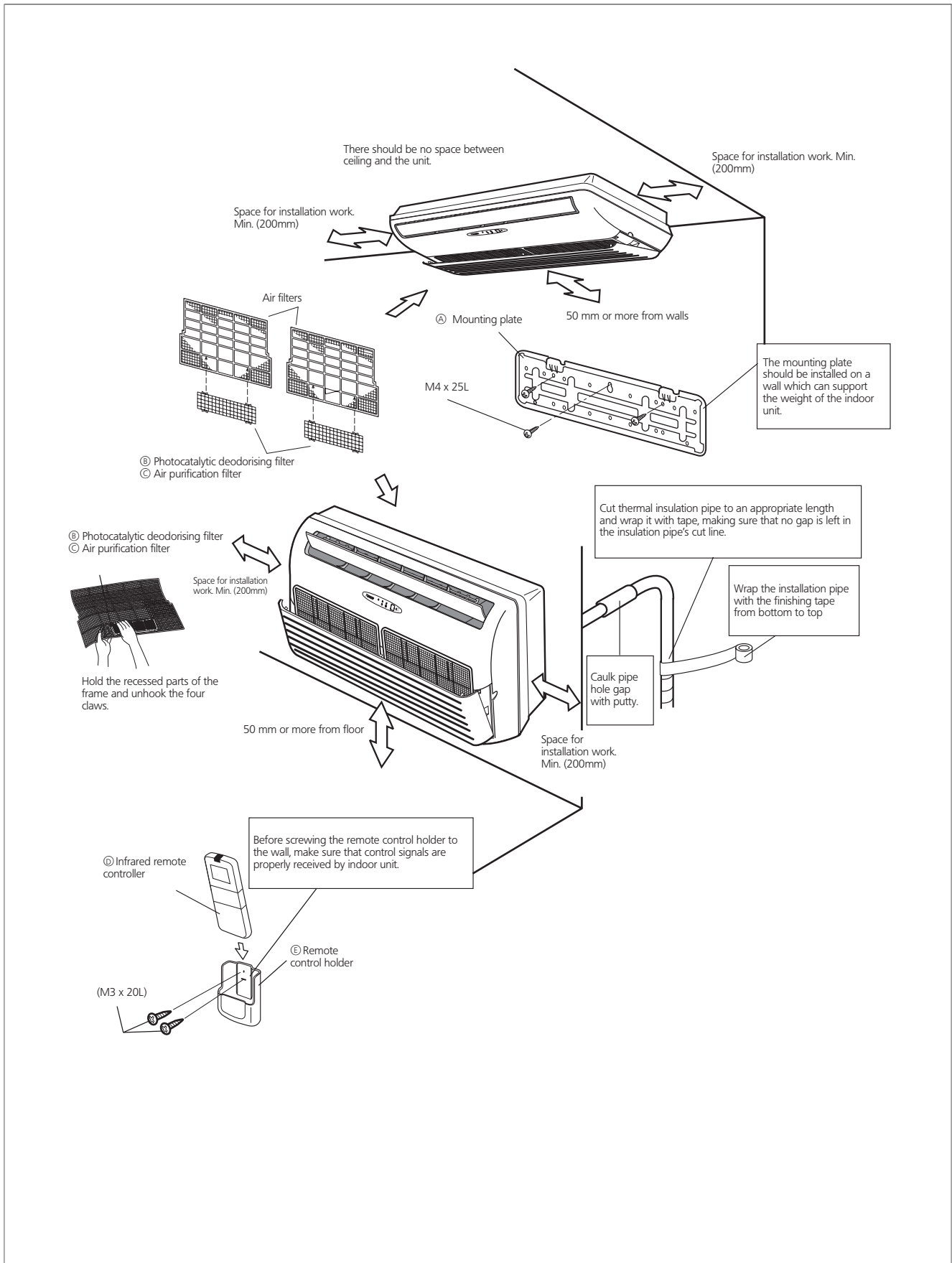



# 10 Installation

## 10 Ceiling mounting

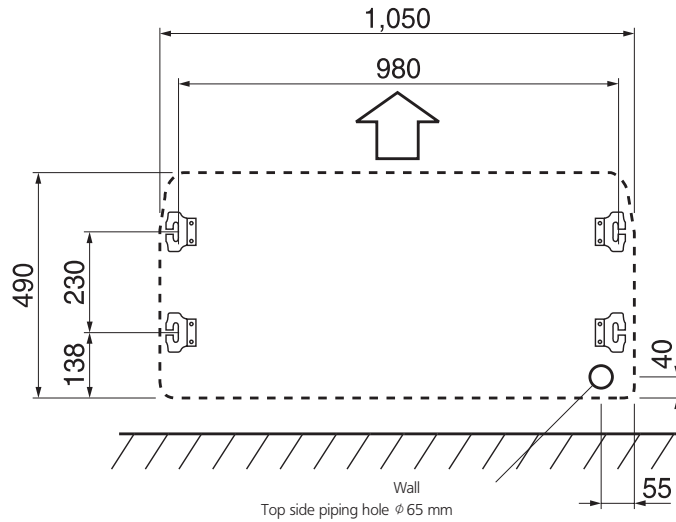
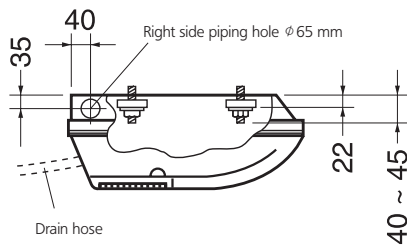
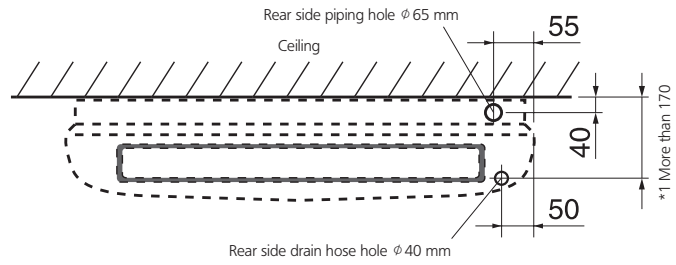
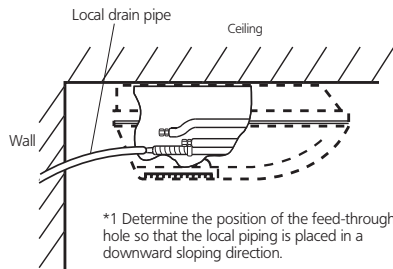

## Wall mounting

