



technical data

FDYP-B7



Concealed Ceiling Unit



air conditioning systems

Split Sky Air

Split - Sky Air



ISO14001 assures an effective environmental management system in order to help protect human health and the environment from the potential impact of our activities, products and services and to assist in maintaining and improving the quality of the environment



Daikin units comply with the European regulations that guarantee the safety of the product.



Daikin Europe N.V. is approved by LRQA for its Quality Management System in accordance with the ISO9001 standard. ISO9001 pertains to quality assurance regarding design, development, manufacturing as well as to services related to the product.



Daikin Europe N.V. is participating in the EUROVENT Certification Programme. Products are as listed in the EUROVENT Directory of Certified Products.

Specifications are subject to change without prior notice.

DAIKIN EUROPE N.V.

Zandvoordestraat 300
B - 8400 Ostend Belgium
Internet: <http://www.daikineurope.com>



TABLE OF CONTENTS

FDYP-B7

| | | |
|----|--|----|
| 1 | Features | 2 |
| 2 | Specifications | 3 |
| | Nominal capacity, capacity steps and nominal input | |
| | Technical specifications | |
| 3 | Dimensional drawings | 7 |
| 4 | Piping diagrams | 8 |
| 5 | Wiring diagrams | 9 |
| 6 | Sound level | 10 |
| | Sound level data | |
| | Sound pressure spectrum | |
| 7 | Fan characteristics | 11 |
| 8 | Accessories | 12 |
| | Standard accessories | |
| | Optional accessories | |
| 9 | Control systems | 14 |
| 10 | Installation | 14 |

For capacity tables, please refer to part II: outdoor units





1 Features

1

- Compact casing with a height of 350mm (125 class) or 450mm (220 and 250 class)
- Extremely quiet in operation both indoors and outdoors
- Fits flush into each ceiling
- High external static pressure, ranging from 150 to 250 Pa
- For equal distribution in larger rooms, up to 2 indoor units can be connected to 1 outdoor. They are operated from 1 remote control
- The wired remote control has a programmable timer
- Centralised control of several units can be achieved via 3 wired controls
 - centralised remote control
 - unified ON/OFF control
 - schedule timer

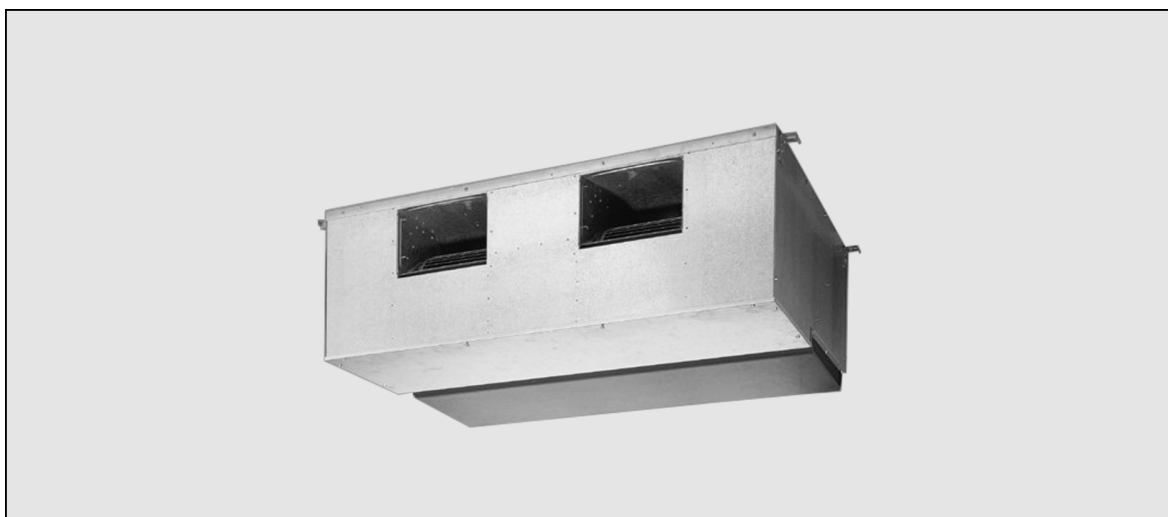

Optional



2 steps
(FDYP250)



3 steps
(FDYP125, 200)



2 Specifications



2

| NOMINAL CAPACITY and NOMINAL INPUT | | | | | |
|------------------------------------|---------|----|-------------|-------------|-------------|
| For indoor units only: | | | | | |
| INDOOR UNITS | | | FDYP125B7V1 | FDYP200B7V1 | FDYP250B7V1 |
| NOMINAL INPUT | Cooling | kW | – | – | – |

| For combination indoor + outdoor units (air cooled): | | | | | |
|--|-------------|-----|---------------------|-------------|-------------|
| INDOOR UNITS | | | FDYP125B7V1 | FDYP200B7V1 | FDYP250B7V1 |
| OUTDOOR UNITS | | | RP125L7W1-RP125B7T1 | RP200L7W1 | RP250L7W1 |
| NOMINAL CAPACITY (2) | Cooling (1) | kW | 12.20/12.40 | 20.00 | 25.00 |
| NOMINAL INPUT | Cooling | kW | 4.68/4.70 | 8.71 | 10.74 |
| EER | | | 2.61/2.64 | - | - |
| ENERGY LABEL | Cooling | | D/D | - | - |
| ANNUAL ENERGY CONSUMPTION | Cooling | kWh | 2,340/2,350 | - | - |

| TECHNICAL SPECIFICATIONS | | | | | | |
|--------------------------|----------------------------|----------------|---------------------------------------|------------------|------------------|-----------------------------------|
| For indoor units only: | | | | | | |
| INDOOR UNITS | | | FDYP125B7V1 | FDYP200B7V1 | FDYP250B7V1 | |
| DIMENSIONS | Unit | H | mm | 350 | 450 | 450 |
| | | W | mm | 1,400 | 1,400 | 1,400 |
| | | D | mm | 662 | 900 | 900 |
| | | | | | | |
| WEIGHT | Unit | kg | 59 | 87 | 92 | |
| MATERIAL | Unit | | Galvanised steel plate | | | |
| SOUND LEVEL | Sound pressure (3) | high | dB(A) | 44 | 45 | 47 |
| | Sound power (4) | | dB(A) | 75 | 81 | 82 |
| FAN | Air flow rate | medium | m ³ /min | 43 | 69 | 89 |
| | Speed | steps | | 3 steps | | 2 steps |
| | Qty x model | | | 1 x DPA216-178NB | 1 x DPC241-241NB | |
| | Qty x motor output | W | | 1 x 500 | 1 x 650 | 1 x 1,000 |
| | Drive | | | Direct drive | | |
| | External static pressure | | Pa | 0~150 | 0~250 | 0~250 |
| HEAT EXCHANGER | Type | | ϕ 7 Hi-Xa tube, NLH 7 fin-hydrophilia | | | ϕ 8 Hi-Xa tube, fin non-symmetric |
| | Rows x stages x fin pitch | mm | 3 x 14 x 1.75 | | | 2 x 24 x 2 |
| | Face area | m ² | 0.338 | | | 0.634 |
| TEMPERATURE CONTROL | | | Computerised control | | | |
| PIPING CONNECTIONS | | liquid | mm | ϕ9.52 (flare) | ϕ12.7 (flare) | ϕ15.9 (flare) |
| | | gas | mm | ϕ19.10 (flare) | ϕ28.6 | ϕ28.6 |
| | | drain | mm | I.D. ϕ23 | I.D. ϕ23 | I.D. ϕ23 |
| | | drain | mm | O.D. ϕ32 | O.D. ϕ32 | O.D. ϕ32 |
| INSULATION MATERIAL | Sound absorbing insulation | | Flame and heat resistant foamed felt | | | |
| For outdoor units | Pair application | | See chapter RP-L7/B7 | | | |

2 Specifications



2

| ELECTRICAL SPECIFICATIONS | | | | FDYP125B7V1 | FDYP200B7V1 | FDYP200B7V1 |
|--|-------------------------|---------|----|---------------------------------------|--------------------------|--------------------------|
| For indoor units only: | | | | | | |
| CURRENT | Nominal running current | cooling | A | See chapter RP-L7/B7: Electrical data | | |
| | Max. running current | cooling | A | | | |
| For combination indoor units + outdoor units: | | | | FDYP125B7V1 RP125L7W1-RP125B7T1 | FDYP200B7V1 RP200L7W1 | FDYP200B7V1 RP250L7W1 |
| CURRENT | Nominal running current | cooling | A | See chapter RP-L7/B7: Electrical data | 14.4 | 17.2 |
| | Maximum running current | cooling | A | | 17.9 | 27.5 |
| | Starting current | cooling | A | See chapter RP-L7/B7: Electrical data | | |
| For indoor units only: | | | | FDYP125B7V1 | FDYP200B7V1 | FDYP200B7V1 |
| POWER SUPPLY | | | | V1 | V1 | V1 |
| NOMINAL DISTRIBUTION SYSTEM VOLTAGE | Phase | | | 1~ | 1~ | 1~ |
| | Frequency | | Hz | 50 | 50 | 50 |
| | Voltage | | V | 230 | 230 | 230 |

3TW22801-1A

NOTES

- 1 Nominal cooling capacities are based on: indoor temperature: 27°CDB/19°CWB * outdoor temperature: 35°CDB * equivalent refrigerant piping length: 7.5m * level difference: 0m
- 2 Capacities are net, including a deduction for indoor fan motor heat.
- 3 The sound pressure level is measured via a microphone at 1.5m distance from the unit. It is a relative value, depending on the distance and acoustic environment. For measuring conditions: please refer to item 6 of this chapter.
- 4 The sound power level is an absolute value indicating the "power" which a sound source generates.
- 5 Energy label: scale from A (most efficient) to G (less efficient).
- 6 Annual energy consumption: based on average use of 500 running hours per year at full load (= nominal conditions).

2 Specifications

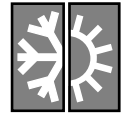

2

| NOMINAL CAPACITY and NOMINAL INPUT | | | | | |
|------------------------------------|---------|----|-------------|-------------|-------------|
| For indoor units only: | | | | | |
| INDOOR UNITS | | | FDYP125B7V1 | FDYP200B7V1 | FDYP250B7V1 |
| NOMINAL INPUT | Cooling | kW | — | — | — |
| | Heating | kW | — | — | — |

| For combination indoor + outdoor units (air cooled): | | | | | |
|--|-------------|-----|-------------|-------------|-------------|
| INDOOR UNITS | | | FDYP125B7V1 | FDYP200B7V1 | FDYP250B7V1 |
| OUTDOOR UNITS | | | RYP125L7W1 | RYP200L7W1 | RYP250L7W1 |
| NOMINAL CAPACITY (3) | Cooling (1) | kW | 12.20 | 19.50 | 25.00 |
| | Heating (2) | kW | 14.60 | 23.10 | 27.00 |
| NOMINAL INPUT | Cooling | kW | 4.68 | 8.69 | 10.20 |
| | Heating | kW | 4.51 | 7.59 | 8.76 |
| EER | | | 2.61 | - | - |
| COP | | | 3.24 | - | - |
| ENERGY LABEL | Cooling | | D | - | - |
| | Heating | | C | - | - |
| ANNUAL ENERGY CONSUMPTION | Cooling | kWh | 2,340 | - | - |

| TECHNICAL SPECIFICATIONS | | | | | | |
|--------------------------|--------------------------------------|--------|---------------------|--------------------------------------|-----------------------------------|---------------|
| For indoor units only: | | | | | | |
| INDOOR UNITS | | | | FDYP125B7V1 | FDYP200B7V1 | FDYP250B7V1 |
| DIMENSIONS | Unit | H | mm | 350 | 450 | 450 |
| | | W | mm | 1,400 | 1,400 | 1,400 |
| | | D | mm | 662 | 900 | 900 |
| WEIGHT | Unit | | kg | 59 | 87 | 92 |
| MATERIAL | Unit | | | Galvanised steel plate | | |
| SOUND LEVEL | Sound pressure (cooling/heating) (4) | high | dB(A) | 44/44 | 45/45 | 47/47 |
| | Sound power (cooling/heating) (5) | | dB(A) | 75/75 | 81/81 | 82/82 |
| FAN | Air flow rate | medium | m ³ /min | 43 | 69 | 89 |
| | Speed | | steps | 3 steps | | 2 steps |
| | Qty x model | | | 1 x DPA216-178NB | 1 x DPC241-241NB | |
| | Qty x motor output | | W | 1 x 500 | 1 x 650 | 1 x 1,000 |
| | Drive | | | Direct drive | | |
| External static pressure | | Pa | 0~150 | 0~250 | 0~250 | |
| HEAT EXCHANGER | Type | | | φ 7 Hi-Xa tube, NLH 7 fin-hydrophila | φ 8 Hi-Xa tube, fin non-symmetric | |
| | Rows x stages x fin pitch | | mm | 3 x 14 x 1.75 | 2 x 24 x 2 | 3 x 24 x 2 |
| | Face area | | m ² | 0.338 | 0.634 | 0.634 |
| TEMPERATURE CONTROL | | | | Computerised control | | |
| PIPING CONNECTIONS | | liquid | mm | φ9.52 (flare) | φ12.7 (flare) | φ15.9 (flare) |
| | | gas | mm | φ19.10 (flare) | φ28.6 | 28.6 |
| | | drain | mm | I.D. φ23 | I.D. φ23 | I.D. φ23 |
| | | drain | mm | O.D. φ25 | O.D. φ25 | O.D. φ25 |
| INSULATION MATERIAL | Sound absorbing insulation | | | Flame and heat resistant foamed felt | | |
| For outdoor units | Pair application | | | See chapter RYP-L7/B7 | | |

2 Specifications



2

| ELECTRICAL SPECIFICATIONS | | | | FDYP125B7V1 | FDYP200B7V1 | FDYP250B7V1 | |
|--|-------------------------------|---------|----|-------------------------------------|--------------------|--------------------|----|
| For indoor units only: | | | | | | | |
| CURRENT | Nominal running current | cooling | A | See chapter RYP-L7: Electrical data | | | |
| | | heating | A | | | | |
| | Max. running current | cooling | A | | | | |
| | | heating | A | | | | |
| For combination indoor units + outdoor units: | | | | | | | |
| | | | | FDYP125B7V1 | FDYP200B7V1 | FDYP250B7V1 | |
| | | | | RYP125B7W1 | RYP200B7W1 | RYP250B7W1 | |
| CURRENT | Nominal running current | cooling | A | See chapter RYP-L7: Electrical data | 14.4 | 17.2 | |
| | | heating | A | | 14.4 | 17.2 | |
| | Maximum running current | cooling | A | | 17.9 | 27.5 | |
| | | heating | A | | 17.9 | 27.5 | |
| | Starting current | cooling | A | See chapter RYP-L7: Electrical data | | | |
| | | heating | A | | | | |
| | For indoor units only: | | | | | | |
| | POWER SUPPLY | | | | V1 | V1 | V1 |
| NOMINAL DISTRIBUTION SYSTEM VOLTAGE | Phase | | | 1~ | 1~ | 1~ | |
| | Frequency | | Hz | 50 | 50 | 50 | |
| | Voltage | | V | 230 | 230 | 230 | |

3TW22801-1A

NOTES

- 1 Nominal cooling capacities are based on: indoor temperature: 27°CDB/19°CWB * outdoor temperature: 35°CDB * equivalent refrigerant piping length: 7.5m * level difference: 0m
- 2 Nominal heating capacities are based on: indoor temperature: 20°CDB * outdoor temperature: 7°CDB/6°CWB * refrigerant piping length: 7.5m * level difference 0m.
- 3 Capacities are net, including a deduction for cooling (an addition for heating) for indoor fan motor heat.
- 4 The sound pressure level is measured in an anechoic room at 1m distance from the unit. It is a relative value, depending on the distance and acoustic environment. For measuring conditions; please refer to item 6 of this chapter.
- 5 The sound power level is an absolute value indicating the "power" which a sound source generates.
- 6 Energy label: scale from A (most efficient) to G (less efficient).
- 7 Annual energy consumption: based on average use of 500 running hours per year at full load (= nominal conditions).



3 Dimensional drawings

3

FDYP125B7

Notes:

- : Service space
- : Extra service space for optional drain pump

- 1 Power supply intake
- 2 Drain connection ϕ 25 O.D.
- 3 Gas pipe connection single union joint 3/4"
- 4 Liquid pipe connection single union joint 3/8"
- 5 Filter

3TW22804-1A

FDYP200-250B7

| Model | A | B |
|-------------|-----|-----|
| FDYP200B7V1 | 830 | 285 |
| FDYP250B7V1 | 890 | 255 |

Notes:

- : Service space
- : Extra service space for optional drain pump

- 1 Filter
- 2 Drain connection ϕ 25 O.D.
- 3 Gas pipe connection: FDYP200B/250B: 1 1/8" O.D. or 28.6 mm O.D.
- 4 Liquid pipe connection: FDYP200B: Single union joint 1/2" or 12.7mm
FDYP250B: Single union joint 5/8" or 15.9mm

3TW22814-1A



4 Piping diagrams

4

FDYP125B7

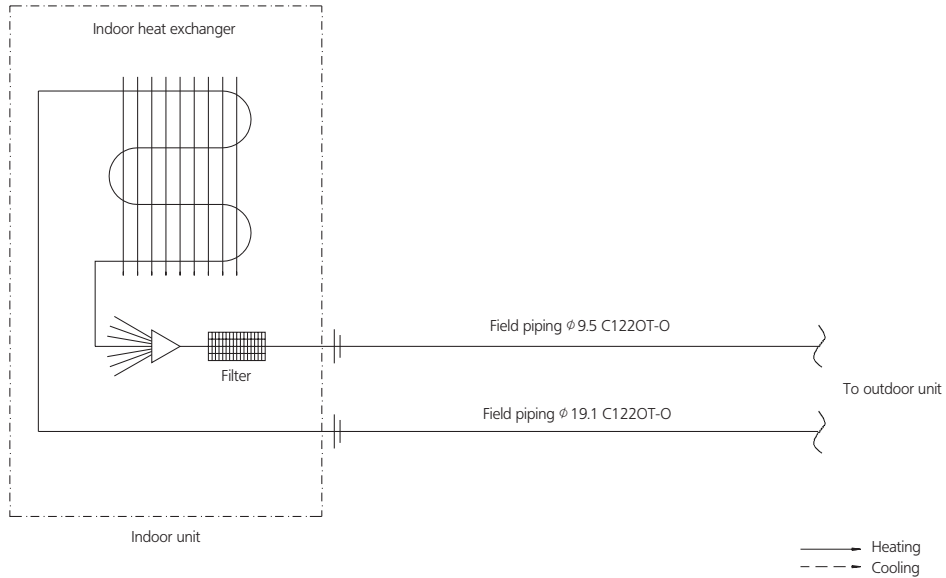

Check valve
 Flare connection
 Screw connection
 Flange connection
 Pinched pipe
 Spinned pipe

3TW23365-1(h/p) + 3TW23335-1(c/o)

FDYP200-250B7

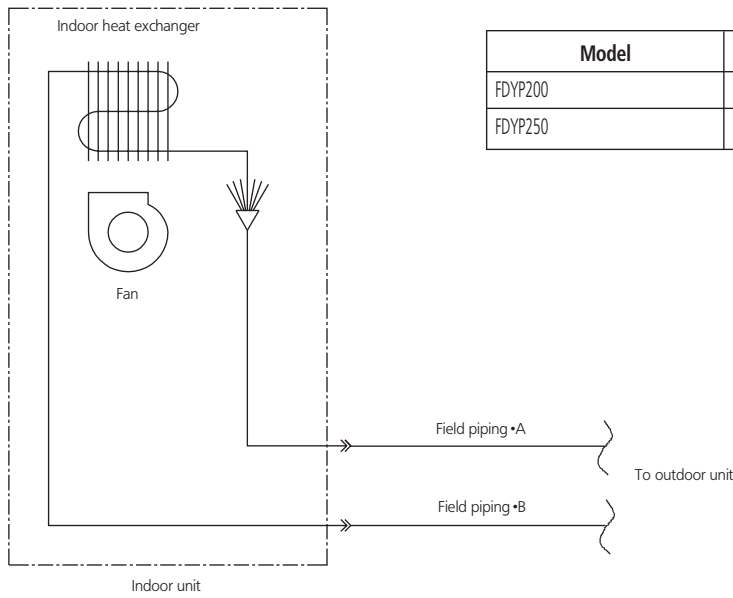

| Model | A | B |
|---------|-------------|-------------|
| FDYP200 | ϕ 12.7 | ϕ 28.6 |
| FDYP250 | ϕ 15.9 | ϕ 28.6 |

Check valve
 Flare connection
 Screw connection
 Flange connection
 Pinched pipe
 Spinned pipe

3TW23635-1(h/p) + 3TW23615-1(c/o)



5 Wiring diagrams

5

FDYP125,200,250B7

Notes

1. When using the central remote control, see manual for connection to the unit.
 2. Be sure that power supply is switched off before opening switch box.
- * L-tap is not available for 250 class.

Field wiring Terminal
 Connector
 Protective earth (screw)
 Colours
 BLK: Black / WHT: White / RED: Red / BLU: Blue / YLW: Yellow

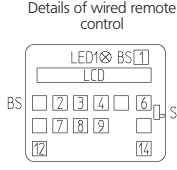
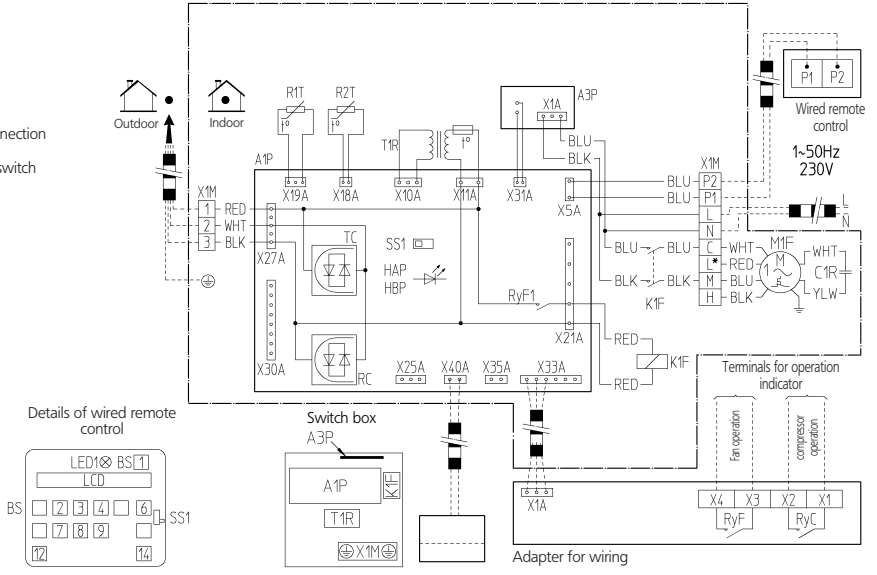

| | | | | | | | | | | |
|---------|--|---------|-----------------------------|----------------------|----------------------------------|---------------|----------------------------------|--------------------------|------------------------------|---|
| A1P | Printed circuit board | R1T | Thermistor (air) | Wired remote control | BS1 | On/Off button | BS14 | Filter sign reset button | Connector for optional parts | |
| T1R | Transformer (230V/21.8V) | R2T | Thermistor (coil) | BS1 | On/Off button | BS2 | Timer mode start/stop button | LED1 | X30A | Connector (interface adaptor for SKY AIR / US series) |
| A3P | Printed circuit board | RyF1 | Magnetic relay (fan) | BS2 | Timer mode start/stop button | BS3,8 | Programming time button | LCD | X33A | Connector (adaptor for wiring) |
| C1R | Capacitor (fan) | SS1 | Selector switch (emergency) | BS4 | Temperature setting button up | BS9 | Temperature setting button down | SS1 | X25A | Connector (group control adaptor) |
| F1T | Thermal fuse (M1F embedded) | X1M | Terminal strip | BS9 | Temperature setting button down | BS6 | Operation mode selector button | | X40A | Connector (remote ON/OFF, forced off, only SKY-AIR Pseries) |
| HAP/HBP | Light emitting diode (service monitor green) | RC | Signal receiver circuit | BS7 | Timer on/off button | BS7 | Timer on/off button | | | |
| K1F | Magnetic contactor (M1F) | TC | Signal transmission circuit | BS12 | Inspection/test operation button | BS12 | Inspection/test operation button | | | |
| M1F | Motor (fan) | RyC/RyF | Magnetic relay | | | | | | | |

2TW22806-1C



6 Sound level

6-1 Sound level data

6
6-1

| Model | Sound pressure level | | Measuring location | Sound power level |
|-------------|----------------------|---------|--------------------|-------------------|
| | 230V | | | |
| | 50 Hz | | | |
| | Cooling | Heating | | |
| FDYP125B7V1 | 44 | 44 | | 75 |
| FDYP200B7V1 | 45 | 45 | | 81 |
| FDYP250B7V1 | 47 | 47 | | 82 |

6-2 Sound pressure spectrum

FDYP125B7V1

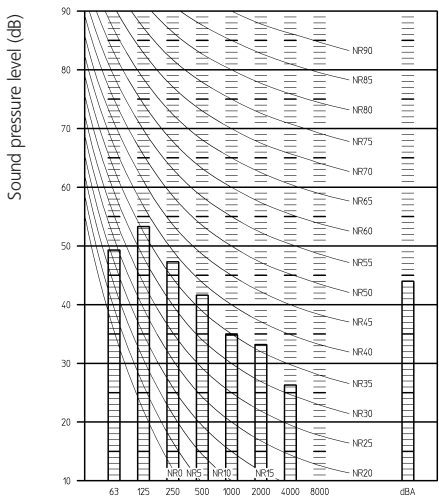

3TW22807-1

Octave band center frequency (Hz)

FDYP200B7V1

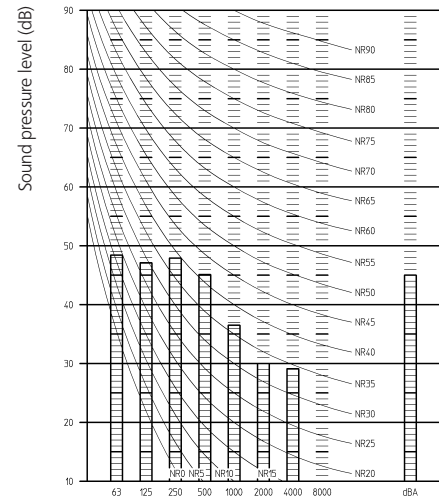

3TW22817-1

Octave band center frequency (Hz)

FDYP250B7V1

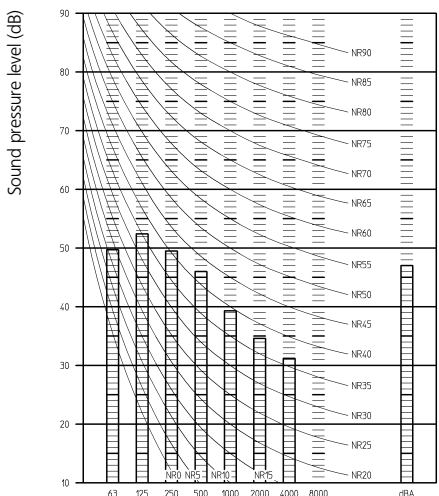

3TW22827-1

Octave band center frequency (Hz)

Legend

- High speed
- Low speed

NOTES

- 1 Data is valid at free field condition
- 2 Data is valid at nominal operation condition (at 62 Pa ESP, 90m³/min)
- 3 dBA = A-weighted sound pressure level (A-scale according to IEC)
- 4 Reference acoustic pressure 0dB = 20μPa
- 5 the indicated sound pressure is the casing radiated sound pressure.



7 Fan characteristics

FDYP125B7V1

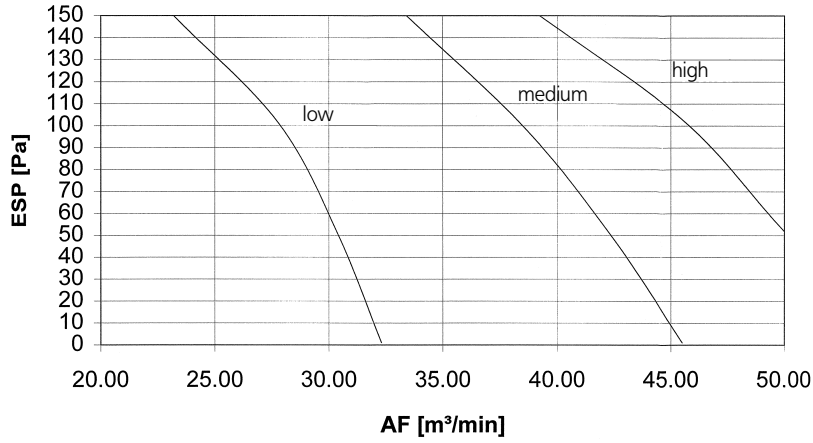

Filter is standard included

3TW22808-1

FDYP200B7V1

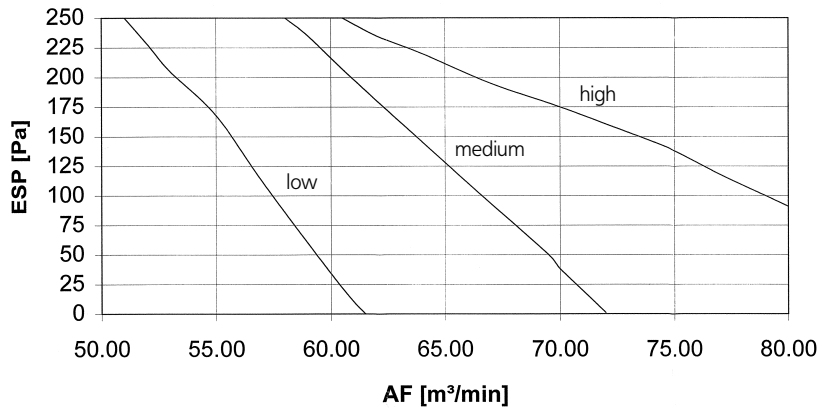

Filter is standard included

3TW22818-1

FDYP250B7V1

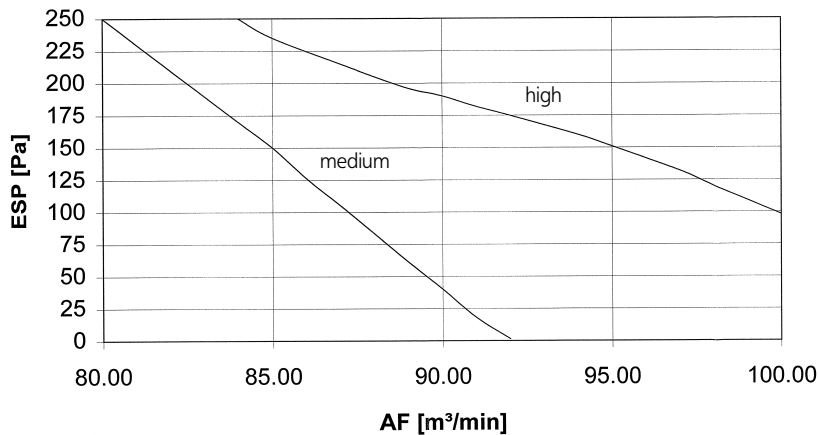

Filter is standard included

3TW22828-1



8 Accessories

8-1 Standard accessories

8
8-1



Installation manual Operation manual

8-2 Optional accessories

| Name of option | Kit name | | |
|--|------------|-----------|-----------|
| | FDYP125B7 | FDYP200B7 | FDYP250B7 |
| Wiring adaptor for electrical appendices | KRP4A51 | | |
| Adapter for wiring (interlock for fresh air intake) | KRP1B54 | | |
| Interface adapter for Sky Air series | DTA102A52 | | |
| Central remote control | DCS302A51 | | |
| unified ON/OFF control | DCS301A51 | | |
| Schedule timer | DST301A51 | | |
| Option PCB for external electrical heater, humidifier and/or hour meter *1 | EGRP1B2 | | |
| Drain pump | EKDU125A1 | | |
| Remote control | Wired type | BRC1D517 | |
| Remote ON/OFF, forced OFF | EKRORO | | |

*1 Electrical heater and humidifier are field supply. These parts should not be installed inside the equipment. (Refer to installation manual EGRP1B2).

3TW22809-1



8 Accessories

8-2 Optional accessories

Specifications EKRORO

8

8-2

Wire specifications

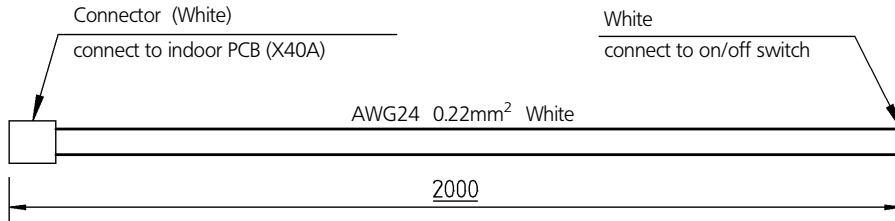

Operating method

| | | | |
|----------------|--------------------------------|-----|--|
| Input | Switch | ON* | |
| | | OFF | |
| Remote control | ON | | |
| | OFF | | |
| Unit | Standard setting: 'forced off' | ON | |
| | | OFF | |
| | Alternative setting: 'on/off' | ON | |
| | | OFF | |

* Input 'ON' = closed contact.

| Forced off | On/off operation |
|---|--|
| Input 'on' stops operation + disables control | Input off→on: starts operation, remote control is still enabled. |
| Input 'off' enables control | Input on→off: stops operation, remote control is still enabled. |

Selection of 'FORCED OFF' and 'ON/OFF' operation

| Setting | Mode NO | First code NO | Second code NO |
|------------------|---------|---------------|----------------|
| Forced off | 12 (22) | 1 | 01 |
| On/off operation | | | 02 |

4TW23941-1



9 Control systems

9-1 Wired remote control

9

9-1

BRC1D517

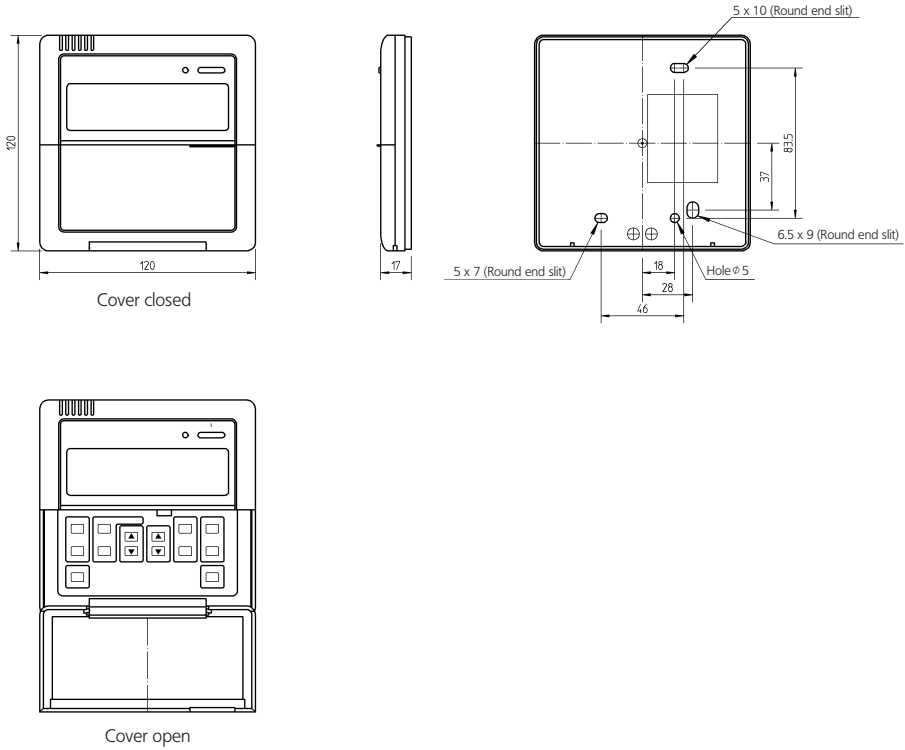

3TW23651-2

10 Installation

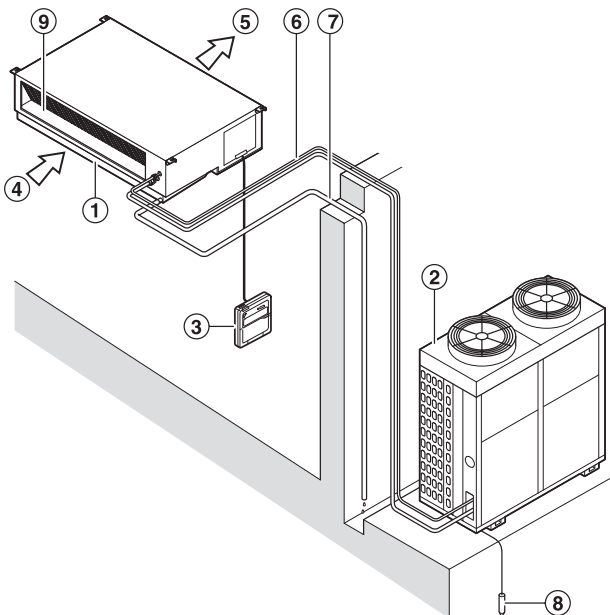

| Number | Description |
|--------|---|
| 1 | Indoor unit |
| 2 | Outdoor unit |
| 3 | Remote control |
| 4 | Inlet air |
| 5 | Discharged air |
| 6 | Refrigerant piping, connection electric wire |
| 7 | Drain pipe |
| 8 | Ground wire Wire to ground from the outdoor unit to prevent electrical shocks. |
| 9 | Air filter |