

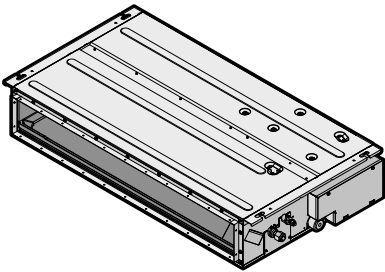

Installer reference guide

Split system air conditioners



FDXM25F3V1B
FDXM35F3V1B
FDXM50F3V1B
FDXM60F3V1B

FDXM25F3V1B9
FDXM35F3V1B9
FDXM50F3V1B9
FDXM60F3V1B9

Installer reference guide
Split system air conditioners

English

Table of Contents

1 General safety precautions 2

1.1 About the documentation 2

 1.1.1 Meaning of warnings and symbols..... 2

1.2 For the installer..... 3

 1.2.1 General 3

 1.2.2 Installation site 3

 1.2.3 Refrigerant 5

 1.2.4 Brine..... 5

 1.2.5 Water 5

 1.2.6 Electrical 6

2 About the documentation 6

2.1 About this document..... 6

2.2 Installer reference guide at a glance 7

3 About the box 7

3.1 Overview: About the box 7

3.2 Indoor unit 7

 3.2.1 To unpack and handle the unit..... 7

 3.2.2 To remove the accessories from the indoor unit..... 7

4 About the units and options 7

4.1 Overview: About the units and options..... 7

4.2 System layout..... 8

4.3 Combining units and options 8

 4.3.1 Possible options for the indoor unit..... 8

5 Preparation 8

5.1 Overview: Preparation..... 8

5.2 Preparing the installation site 8

 5.2.1 Installation site requirements of the indoor unit 8

5.3 Preparing refrigerant piping..... 9

 5.3.1 Refrigerant piping requirements..... 9

 5.3.2 Refrigerant piping insulation 9

5.4 Preparing electrical wiring 9

 5.4.1 About preparing electrical wiring..... 9

6 Installation 10

6.1 Overview: Installation 10

6.2 Mounting the indoor unit..... 10

 6.2.1 Precautions when mounting the indoor unit..... 10

 6.2.2 Guidelines when installing the indoor unit..... 10

 6.2.3 Guidelines when installing the ducting..... 11

 6.2.4 Guidelines when installing the drain piping..... 11

6.3 Connecting the refrigerant piping 12

 6.3.1 About connecting the refrigerant piping 12

 6.3.2 Precautions when connecting the refrigerant piping... 12

 6.3.3 Guidelines when connecting the refrigerant piping 13

 6.3.4 Pipe bending guidelines..... 13

 6.3.5 To flare the pipe end..... 13

 6.3.6 To connect the refrigerant piping to the indoor unit 13

 6.3.7 To check for leaks..... 14

6.4 Connecting the electrical wiring..... 14

 6.4.1 About connecting the electrical wiring..... 14

 6.4.2 Precautions when connecting the electrical wiring 14

 6.4.3 Guidelines when connecting the electrical wiring 14

 6.4.4 To connect the electrical wiring on the indoor unit..... 15

 6.4.5 Specifications of standard wiring components..... 15

7 Configuration 15

7.1 Field settings 15

8 Commissioning 16

8.1 Checklist before commissioning 16

8.2 To perform a test run 16

8.3 Error codes when performing a test run 17

9 Hand-over to the user 17

10 Disposal 17

11 Technical data 17

 11.1 Wiring diagram 18

12 Glossary 18

1 General safety precautions

1.1 About the documentation

- The original documentation is written in English. All other languages are translations.
- The precautions described in this document cover very important topics, follow them carefully.
- The installation of the system, and all activities described in the installation manual and the installer reference guide **MUST** be performed by an authorised installer.

1.1.1 Meaning of warnings and symbols

 **DANGER**
Indicates a situation that results in death or serious injury.

 **DANGER: RISK OF ELECTROCUTION**
Indicates a situation that could result in electrocution.

 **DANGER: RISK OF BURNING**
Indicates a situation that could result in burning because of extreme hot or cold temperatures.

 **DANGER: RISK OF EXPLOSION**
Indicates a situation that could result in explosion.



 **WARNING**
Indicates a situation that could result in death or serious injury.

 **WARNING: FLAMMABLE MATERIAL**

 **CAUTION**
Indicates a situation that could result in minor or moderate injury.

 **NOTICE**
Indicates a situation that could result in equipment or property damage.

 **INFORMATION**
Indicates useful tips or additional information.

Symbol	Explanation
	Before installation, read the installation and operation manual, and the wiring instruction sheet.
	Before performing maintenance and service tasks, read the service manual.
	For more information, see the installer and user reference guide.

1.2 For the installer

1.2.1 General

If you are NOT sure how to install or operate the unit, contact your dealer.



NOTICE

Improper installation or attachment of equipment or accessories could result in electric shock, short-circuit, leaks, fire or other damage to the equipment. Only use accessories, optional equipment and spare parts made or approved by Daikin.



WARNING

Make sure installation, testing and applied materials comply with applicable legislation (on top of the instructions described in the Daikin documentation).



CAUTION

Wear adequate personal protective equipment (protective gloves, safety glasses,...) when installing, maintaining or servicing the system.



WARNING

Tear apart and throw away plastic packaging bags so that nobody, especially children, can play with them. Possible risk: suffocation.



DANGER: RISK OF BURNING

- Do NOT touch the refrigerant piping, water piping or internal parts during and immediately after operation. It could be too hot or too cold. Give it time to return to normal temperature. If you must touch it, wear protective gloves.
- Do NOT touch any accidental leaking refrigerant.



WARNING

Provide adequate measures to prevent that the unit can be used as a shelter by small animals. Small animals that make contact with electrical parts can cause malfunctions, smoke or fire.



CAUTION

Do NOT touch the air inlet or aluminium fins of the unit.



NOTICE

- Do NOT place any objects or equipment on top of the unit.
- Do NOT sit, climb or stand on the unit.



NOTICE

Works executed on the outdoor unit are best done under dry weather conditions to avoid water ingress.

In accordance with the applicable legislation, it might be necessary to provide a logbook with the product containing at least: information on maintenance, repair work, results of tests, stand-by periods,...

Also, at least, following information MUST be provided at an accessible place at the product:

- Instructions for shutting down the system in case of an emergency
- Name and address of fire department, police and hospital
- Name, address and day and night telephone numbers for obtaining service

In Europe, EN378 provides the necessary guidance for this logbook.

1.2.2 Installation site

- Provide sufficient space around the unit for servicing and air circulation.
- Make sure the installation site withstands the unit's weight and vibration.
- Make sure the area is well ventilated. Do NOT block any ventilation openings.
- Make sure the unit is level.

Do NOT install the unit in the following places:

- In potentially explosive atmospheres.
- In places where there is machinery that emits electromagnetic waves. Electromagnetic waves may disturb the control system, and cause malfunction of the equipment.
- In places where there is a risk of fire due to the leakage of flammable gases (example: thinner or gasoline), carbon fibre, ignitable dust.
- In places where corrosive gas (example: sulphurous acid gas) is produced. Corrosion of copper pipes or soldered parts may cause the refrigerant to leak.

Instructions for equipment using R32 refrigerant

If applicable.



WARNING

- Do NOT pierce or burn.
- Do NOT use means to accelerate the defrosting process or to clean the equipment, other than those recommended by the manufacturer.
- Be aware that R32 refrigerant does NOT contain an odour.



WARNING

The appliance shall be stored so as to prevent mechanical damage and in a well-ventilated room without continuously operating ignition sources (example: open flames, an operating gas appliance or an operating electric heater) and have a room size as specified below.



NOTICE

- Do NOT re-use joints which have been used already.
- Joints made in installation between parts of refrigerant system shall be accessible for maintenance purposes.



WARNING

Make sure installation, servicing, maintenance and repair comply with instructions from Daikin and with applicable legislation (for example national gas regulation) and are executed only by authorised persons.

Installation space requirements



NOTICE

- Pipework shall be protected from physical damage.
- Installation of pipework shall be kept to a minimum.

1 General safety precautions

WARNING

If appliances contain R32 refrigerant, the floor area of the room in which the appliances are installed, operated and stored **MUST** be larger than the minimum floor area defined in table below A (m²). This applies to:

- Indoor units **without** a refrigerant leakage sensor; in case of indoor units **with** refrigerant leakage sensor, consult the installation manual
- Outdoor units installed or stored indoors (e.g. winter garden, garage, machinery room)
- Pipework in unventilated spaces

To determine the minimum floor area

- Determine the total refrigerant charge in the system (= factory refrigerant charge ① + ② additional refrigerant amount charged).

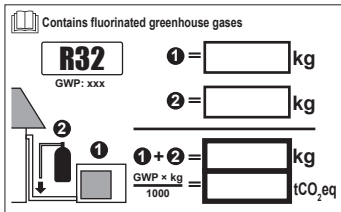

- Determine which graph or table to use.

- For indoor units: Is the unit ceiling-mounted, wall-mounted or floor-standing?
- For outdoor units installed or stored indoors, and field piping in unventilated spaces, this depends on the installation height:

If the installation height is...	Then use the graph or table for...
<1.8 m	Floor-standing units
1.8 ≤ x < 2.2 m	Wall-mounted units
≥ 2.2 m	Ceiling-mounted units

- Use the graph or table to determine the minimum floor area.

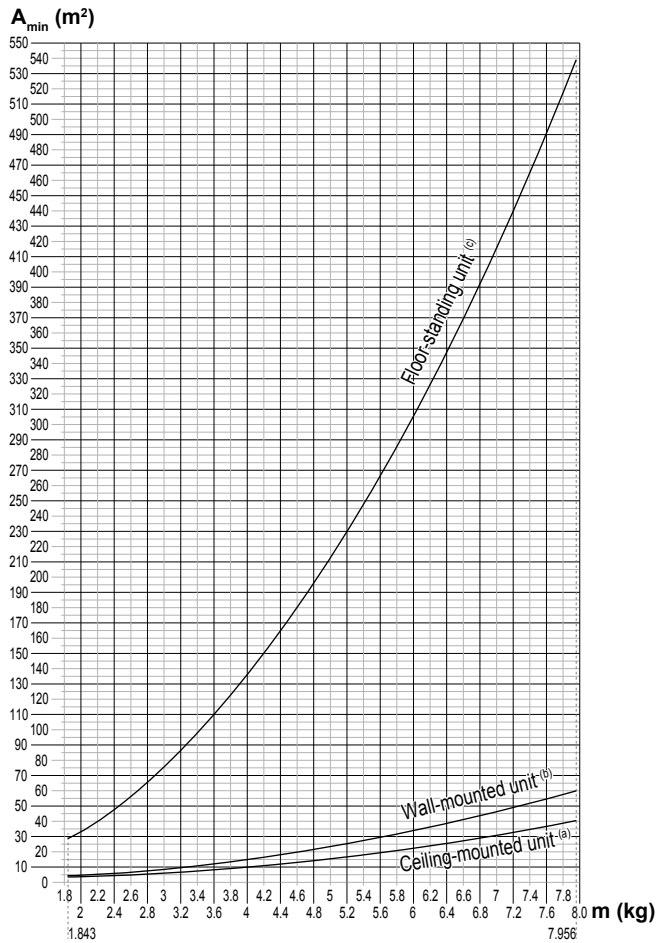

Ceiling-mounted unit ^(a)	Wall-mounted unit ^(b)	Floor-standing unit ^(c)
m (kg) — A _{min} (m ²)	m (kg) — A _{min} (m ²)	m (kg) — A _{min} (m ²)
≤ 1.842 — —	≤ 1.842 — —	≤ 1.842 — —
1.843 — 3.64	1.843 — 4.45	1.843 — 28.9
2.0 — 3.95	2.0 — 4.83	2.0 — 34.0
2.2 — 4.34	2.2 — 5.31	2.2 — 41.2
2.4 — 4.74	2.4 — 5.79	2.4 — 49.0
2.6 — 5.13	2.6 — 6.39	2.6 — 57.5
2.8 — 5.53	2.8 — 7.41	2.8 — 66.7
3.0 — 5.92	3.0 — 8.51	3.0 — 76.6
3.2 — 6.48	3.2 — 9.68	3.2 — 87.2
3.4 — 7.32	3.4 — 10.9	3.4 — 98.4
3.6 — 8.20	3.6 — 12.3	3.6 — 110
3.8 — 9.14	3.8 — 13.7	3.8 — 123
4.0 — 10.1	4.0 — 15.1	4.0 — 136
4.2 — 11.2	4.2 — 16.7	4.2 — 150
4.4 — 12.3	4.4 — 18.3	4.4 — 165
4.6 — 13.4	4.6 — 20.0	4.6 — 180
4.8 — 14.6	4.8 — 21.8	4.8 — 196
5.0 — 15.8	5.0 — 23.6	5.0 — 213
5.2 — 17.1	5.2 — 25.6	5.2 — 230
5.4 — 18.5	5.4 — 27.6	5.4 — 248
5.6 — 19.9	5.6 — 29.7	5.6 — 267
5.8 — 21.3	5.8 — 31.8	5.8 — 286
6.0 — 22.8	6.0 — 34.0	6.0 — 306
6.2 — 24.3	6.2 — 36.4	6.2 — 327
6.4 — 25.9	6.4 — 38.7	6.4 — 349
6.6 — 27.6	6.6 — 41.2	6.6 — 371
6.8 — 29.3	6.8 — 43.7	6.8 — 394
7.0 — 31.0	7.0 — 46.3	7.0 — 417
7.2 — 32.8	7.2 — 49.0	7.2 — 441
7.4 — 34.7	7.4 — 51.8	7.4 — 466
7.6 — 36.6	7.6 — 54.6	7.6 — 492
7.8 — 38.5	7.8 — 57.5	7.8 — 518
7.956 — 40.1	7.956 — 59.9	7.956 — 539

- m Total refrigerant charge in the system
- A_{min} Minimum floor area
- (a) Ceiling-mounted unit (= Ceiling-mounted unit)
- (b) Wall-mounted unit (= Wall-mounted unit)

(c) Floor-standing unit (= Floor-standing unit)

1.2.3 Refrigerant

If applicable. See the installation manual or installer reference guide of your application for more information.



NOTICE

Make sure refrigerant piping installation complies with applicable legislation. In Europe, EN378 is the applicable standard.



NOTICE

Make sure the field piping and connections are NOT subjected to stress.



WARNING

During tests, NEVER pressurize the product with a pressure higher than the maximum allowable pressure (as indicated on the nameplate of the unit).



WARNING

Take sufficient precautions in case of refrigerant leakage. If refrigerant gas leaks, ventilate the area immediately. Possible risks:

- Excessive refrigerant concentrations in a closed room can lead to oxygen deficiency.
- Toxic gas may be produced if refrigerant gas comes into contact with fire.



DANGER: RISK OF EXPLOSION

Pump down – Refrigerant leakage. If you want to pump down the system, and there is a leak in the refrigerant circuit:

- Do NOT use the unit's automatic pump down function, with which you can collect all refrigerant from the system into the outdoor unit. **Possible consequence:** Self-combustion and explosion of the compressor because of air going into the operating compressor.
- Use a separate recovery system so that the unit's compressor does NOT have to operate.



WARNING

ALWAYS recover the refrigerant. Do NOT release them directly into the environment. Use a vacuum pump to evacuate the installation.



NOTICE

After all the piping has been connected, make sure there is no gas leak. Use nitrogen to perform a gas leak detection.



NOTICE

- To avoid compressor breakdown, do NOT charge more than the specified amount of refrigerant.
- When the refrigerant system is to be opened, refrigerant MUST be treated according to the applicable legislation.





WARNING

Make sure there is no oxygen in the system. Refrigerant may only be charged after performing the leak test and the vacuum drying.

- In case re-charge is required, refer to the nameplate of the unit. It states the type of refrigerant and necessary amount.
- The unit is factory charged with refrigerant and depending on pipe sizes and pipe lengths some systems require additional charging of refrigerant.

- Only use tools exclusively for the refrigerant type used in the system, this to ensure pressure resistance and prevent foreign materials from entering into the system.
- Charge the liquid refrigerant as follows:

If	Then
A siphon tube is present (i.e., the cylinder is marked with "Liquid filling siphon attached")	Charge with the cylinder upright. 
A siphon tube is NOT present	Charge with the cylinder upside down. 

- Open refrigerant cylinders slowly.
- Charge the refrigerant in liquid form. Adding it in gas form may prevent normal operation.



CAUTION

When the refrigerant charging procedure is done or when pausing, close the valve of the refrigerant tank immediately. If the valve is NOT closed immediately, remaining pressure might charge additional refrigerant. **Possible consequence:** Incorrect refrigerant amount.

1.2.4 Brine

If applicable. See the installation manual or installer reference guide of your application for more information.



WARNING

The selection of the brine MUST be in accordance with the applicable legislation.



WARNING

Take sufficient precautions in case of brine leakage. If brine leaks, ventilate the area immediately and contact your local dealer.



WARNING

The ambient temperature inside the unit can get much higher than that of the room, e.g. 70°C. In case of a brine leak, hot parts inside the unit can create a hazardous situation.



WARNING

The use and installation of the application MUST comply with the safety and environmental precautions specified in the applicable legislation.

1.2.5 Water

If applicable. See the installation manual or installer reference guide of your application for more information.



NOTICE

Make sure water quality complies with EU directive 98/83 EC.

2 About the documentation

1.2.6 Electrical



DANGER: RISK OF ELECTROCUTION

- Turn OFF all power supply before removing the switch box cover, connecting electrical wiring or touching electrical parts.
- Disconnect the power supply for more than 1 minute, and measure the voltage at the terminals of main circuit capacitors or electrical components before servicing. The voltage MUST be less than 50 V DC before you can touch electrical components. For the location of the terminals, see the wiring diagram.
- Do NOT touch electrical components with wet hands.
- Do NOT leave the unit unattended when the service cover is removed.



WARNING

If NOT factory installed, a main switch or other means for disconnection, having a contact separation in all poles providing full disconnection under overvoltage category III condition, MUST be installed in the fixed wiring.



WARNING

- ONLY use copper wires.
- Make sure the field wiring complies with the applicable legislation.
- All field wiring MUST be performed in accordance with the wiring diagram supplied with the product.
- NEVER squeeze bundled cables and make sure they do NOT come in contact with the piping and sharp edges. Make sure no external pressure is applied to the terminal connections.
- Make sure to install earth wiring. Do NOT earth the unit to a utility pipe, surge absorber, or telephone earth. Incomplete earth may cause electrical shock.
- Make sure to use a dedicated power circuit. NEVER use a power supply shared by another appliance.
- Make sure to install the required fuses or circuit breakers.
- Make sure to install an earth leakage protector. Failure to do so may cause electric shock or fire.
- When installing the earth leakage protector, make sure it is compatible with the inverter (resistant to high frequency electric noise) to avoid unnecessary opening of the earth leakage protector.



NOTICE

Precautions when laying power wiring:



- Do NOT connect wiring of different thicknesses to the power terminal block (slack in the power wiring may cause abnormal heat).
- When connecting wiring which is the same thickness, do as shown in the figure above.
- For wiring, use the designated power wire and connect firmly, then secure to prevent outside pressure being exerted on the terminal board.
- Use an appropriate screwdriver for tightening the terminal screws. A screwdriver with a small head will damage the head and make proper tightening impossible.
- Over-tightening the terminal screws may break them.

Install power cables at least 1 metre away from televisions or radios to prevent interference. Depending on the radio waves, a distance of 1 metre may not be sufficient.



WARNING

- After finishing the electrical work, confirm that each electrical component and terminal inside the electrical components box is connected securely.
- Make sure all covers are closed before starting up the unit.



NOTICE

Only applicable if the power supply is three-phase, and the compressor has an ON/OFF starting method.

If there exists the possibility of reversed phase after a momentary black out and the power goes on and off while the product is operating, attach a reversed phase protection circuit locally. Running the product in reversed phase can break the compressor and other parts.

2 About the documentation

2.1 About this document



INFORMATION

Make sure that the user has the printed documentation and ask him/her to keep it for future reference.

Target audience

Authorised installers



INFORMATION

This appliance is intended to be used by expert or trained users in shops, in light industry, and on farms, or for commercial and household use by lay persons.

Documentation set

This document is part of a documentation set. The complete set consists of:

- **General safety precautions:**
 - Safety instructions that you MUST read before installing
 - Format: Paper (in the box of the indoor unit)

- **Indoor unit installation manual:**
 - Installation instructions
 - Format: Paper (in the box of the indoor unit)
- **Installer reference guide:**
 - Preparation of the installation, good practices, reference data,...
 - Format: Digital files on <http://www.daikineurope.com/support-and-manuals/product-information/>

Latest revisions of the supplied documentation may be available on the regional Daikin website or via your dealer.

The original documentation is written in English. All other languages are translations.

Technical engineering data

- A **subset** of the latest technical data is available on the regional Daikin website (publicly accessible).
- The **full set** of latest technical data is available on the Daikin extranet (authentication required).

2.2 Installer reference guide at a glance

Chapter	Description
General safety precautions	Safety instructions that you MUST read before installing
About the documentation	What documentation exists for the installer
About the box	How to unpack the units and remove their accessories
About the units and options	<ul style="list-style-type: none"> ▪ System layout ▪ Combining units and options
Preparation	What to do and know before going on-site
Installation	What to do and know to install the system
Configuration	What to do and know to configure the system after it is installed
Commissioning	What to do and know to commission the system after it is configured
Hand-over to the user	What to give and explain to the user
Disposal	How to dispose of the system
Technical data	Specifications of the system
Glossary	Definition of terms

3 About the box

3.1 Overview: About the box

Keep the following in mind:

- At delivery, the unit **MUST** be checked for damage. Any damage **MUST** be reported immediately to the carrier's claims agent.
- Bring the packed unit as close as possible to its final installation position to prevent damage during transport.
- Prepare the path along which you want to bring the unit inside in advance.

3.2 Indoor unit



WARNING: FLAMMABLE MATERIAL

The R32 refrigerant (if applicable) in this unit is mildly flammable. Refer to the outdoor unit specifications for the type of refrigerant to be used.

3.2.1 To unpack and handle the unit

Use a sling of soft material or protective plates together with a rope when lifting the unit. This to avoid damage or scratches to the unit.

Lift the unit by holding on to the hanger brackets without exerting any pressure on other parts, especially on refrigerant piping, drain piping and other resin parts.

3.2.2 To remove the accessories from the indoor unit

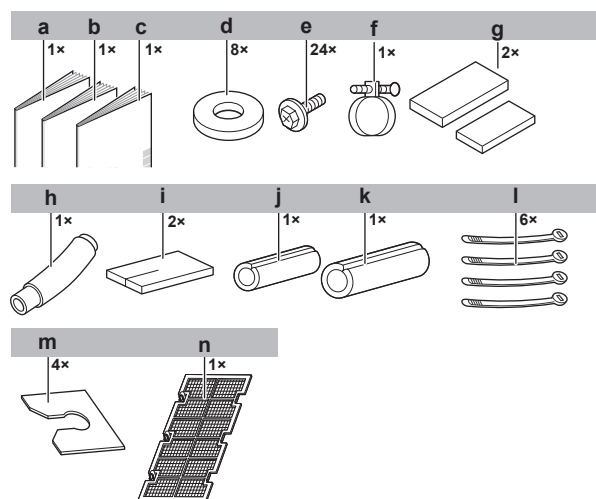

- a Installation manual
- b Operation manual
- c General safety precautions
- d Washers for hanger bracket
- e Screws for duct flanges
- f Metal clamp
- g Sealing pads: small and large
- h Drain hose
- i Sealing material
- j Insulation piece: Small (liquid pipe)
- k Insulation piece: Large (gas pipe)
- l Tie wraps
- m Washer fixing plate
- n Air filter

4 About the units and options

4.1 Overview: About the units and options

This chapter contains information about:

- Combining outdoor and indoor units
- Combining the indoor unit with options

5 Preparation

4.2 System layout

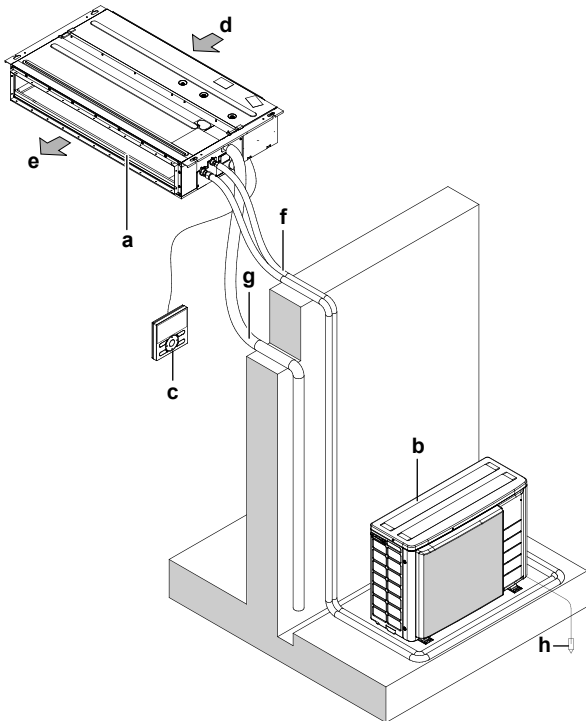

- a Indoor unit
- b Outdoor unit
- c User interface
- d Suction air
- e Discharge air
- f Refrigerant piping + interconnection cable
- g Drain pipe
- h Earth wiring

4.3 Combining units and options

4.3.1 Possible options for the indoor unit

Make sure you have the following mandatory options:

- User interface: Wired or wireless (refer to catalogues and technical literature for selecting a suitable user interface)

5 Preparation

5.1 Overview: Preparation

This chapter describes what you have to do and know before going on-site.

It contains information about:

- Preparing the installation site
- Preparing the refrigerant piping
- Preparing the electrical wiring

5.2 Preparing the installation site

- Provide sufficient space around the unit for servicing and air circulation.
- Choose the installation location with sufficient space for carrying the unit in and out of the site.



WARNING

Do NOT install the air conditioner at any place where flammable gas may leak out. If the gas leaks out and stays around the air conditioner, a fire may break out.

5.2.1 Installation site requirements of the indoor unit



INFORMATION

Also read the following requirements:

- General installation site requirements. See the "General safety precautions" chapter.
- Refrigerant piping requirements (length, height difference). See further in this "Preparation" chapter.



INFORMATION

The sound pressure level is less than 70 dBA.



NOTICE

The equipment described in this manual may cause electronic noise generated from radio-frequency energy. The equipment complies to specifications that are designed to provide reasonable protection against such interference. However, there is no guarantee that interference will not occur in a particular installation.

It is therefore recommended to install the equipment and electric wires keeping proper distances away from stereo equipment, personal computers, etc.

Install power cables at least 1 metre away from televisions or radios to prevent interference. Depending on the radio waves, a distance of 1 metre may not be sufficient.

- **Fluorescent lights.** When installing a wireless user interface in a room with fluorescent lights, mind the following to avoid interference:
 - Install the wireless user interface as close as possible to the indoor unit.
 - Install the indoor unit as far as possible from the fluorescent lights.
- **Signal receiver with built-in temperature sensor** must be installed on a location:
 - near the intake vent (when installation near the intake vent is not possible, install 1.5 m above the floor)
 - which is not exposed to cold or hot air.
 - where signal may not be blocked by curtain, etc.
- Take care that in the event of a water leak, water cannot cause any damage to the installation space and surroundings.
- Choose a location where the hot/cold air discharged from the unit or the operation noise, will NOT disturb anyone.



WARNING

Do NOT place objects below the indoor and/or outdoor unit that may get wet. Otherwise condensation on the main unit or refrigerant pipes, air filter dirt or drain blockage may cause dripping, and objects under the unit may get dirty or damaged.

- **Air flow.** Make sure nothing blocks the air flow.
- **Drainage.** Make sure condensation water can be evacuated properly.
- **Ceiling insulation.** When conditions in the ceiling exceed 30°C and a relative humidity of 80%, or when fresh air is inducted into the ceiling, then additional insulation is required (minimum 10 mm thickness, polyethylene foam).

- **Protective guards.** Make sure to install protective guards on the suction and discharge side to prevent somebody from touching the fan blades or heat exchanger.

Do NOT install the unit in the following places:

- In places where a mineral oil mist, spray or vapour may be present in the atmosphere. Plastic parts may deteriorate and fall off or cause water leakage.

It is NOT recommended to install the unit in the following places because it may shorten the life of the unit:

- Where the voltage fluctuates a lot
- In vehicles or vessels
- Where acidic or alkaline vapour is present
- Use **suspension bolts** for installation.
- **Spacing.** Mind the following requirements:

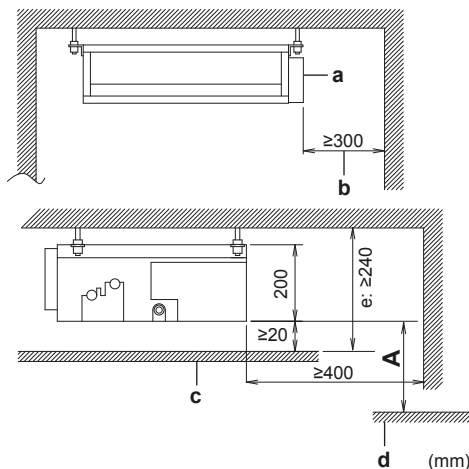

- A Minimum distance to the floor:**
2.7 m to avoid accidental touching.
2.5 m in case the fan is covered (e.g. false ceiling, grille, ...)
- a** Control box
 - b** Maintenance space
 - c** Ceiling
 - d** Floor surface
 - e** Select the dimension to ensure downward slope of at least 1/100

5.3 Preparing refrigerant piping

5.3.1 Refrigerant piping requirements



INFORMATION

Also read the precautions and requirements in the "General safety precautions" chapter.

Refrigerant piping diameter

Use the same diameters as the connections on the outdoor units:

Class	L1 liquid piping	L1 gas piping
25+35	Ø6.4	Ø9.5
50+60	Ø6.4	Ø12.7

Refrigerant piping material

- **Piping material:** Phosphoric acid deoxidised seamless copper.
- **Piping temper grade and thickness:**

Outer diameter (Ø)	Temper grade	Thickness (t) ^(a)	
6.4 mm (1/4")	Annealed (O)	≥0.8 mm	
9.5 mm (3/8")			
12.7 mm (1/2")			

- (a) Depending on the applicable legislation and the unit's maximum working pressure (see "PS High" on the unit name plate), larger piping thickness might be required.

5.3.2 Refrigerant piping insulation

- Use polyethylene foam as insulation material:
 - with a heat transfer rate between 0.041 and 0.052 W/mK (0.035 and 0.045 kcal/mh°C)
 - with a heat resistance of at least 120°C
- Insulation thickness

Pipe outer diameter (Ø _p)	Insulation inner diameter (Ø _i)	Insulation thickness (t)
6.4 mm (1/4")	8~10 mm	≥10 mm
9.5 mm (3/8")	12~15 mm	
12.7 mm (1/2")	14~16 mm	

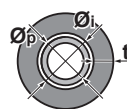

If the temperature is higher than 30°C and the humidity is higher than RH 80%, the thickness of the insulation materials should be at least 20 mm to prevent condensation on the surface of the insulation.

5.4 Preparing electrical wiring

5.4.1 About preparing electrical wiring



INFORMATION

Also read the precautions and requirements in the "General safety precautions" chapter.



WARNING

- If the power supply has a missing or wrong N-phase, equipment might break down.
- Establish proper earthing. Do NOT earth the unit to a utility pipe, surge absorber, or telephone earth. Incomplete earthing may cause electrical shock.
- Install the required fuses or circuit breakers.
- Secure the electrical wiring with cable ties so that the cables do NOT come in contact with sharp edges or piping, particularly on the high-pressure side.
- Do NOT use taped wires, stranded conductor wires, extension cords, or connections from a star system. They can cause overheating, electrical shock or fire.
- Do NOT install a phase advancing capacitor, because this unit is equipped with an inverter. A phase advancing capacitor will reduce performance and may cause accidents.

6 Installation



WARNING

- All wiring **MUST** be performed by an authorised electrician and **MUST** comply with the applicable legislation.
- Make electrical connections to the fixed wiring.
- All components procured on-site and all electrical construction **MUST** comply with the applicable legislation.



WARNING

ALWAYS use multicore cable for power supply cables.

6 Installation

6.1 Overview: Installation

This chapter describes what you have to do and know on-site to install the system.

Typical workflow

Installation typically consists of the following stages:

- 1 Mounting the outdoor unit.
- 2 Mounting the indoor unit.
- 3 Connecting the refrigerant piping.
- 4 Checking the refrigerant piping.
- 5 Charging refrigerant.
- 6 Connecting the electrical wiring.
- 7 Finishing the outdoor installation.
- 8 Finishing the indoor installation.



INFORMATION

This chapter only describes installation instructions specific to the indoor unit. For the other instructions, see:

- The installation manual of the outdoor unit
- The installation manual of the user interface
- The installation manual of the optional accessories

6.2 Mounting the indoor unit

6.2.1 Precautions when mounting the indoor unit



INFORMATION

Also read the precautions and requirements in the following chapters:

- General safety precautions
- Preparation

6.2.2 Guidelines when installing the indoor unit



INFORMATION

Optional equipment. When installing optional equipment, also read the installation manual of the optional equipment. Depending on the field conditions, it might be easier to install the optional equipment first.

- **Ceiling strength.** Check whether the ceiling is strong enough to support the weight of the unit. If there is a risk, reinforce the ceiling before installing the unit.
 - For existing ceilings, use anchors.
 - For new ceilings, use sunken inserts, sunken anchors or other field supplied parts.
- **Suspension bolts.** Use W3/8 M10 suspension bolts for installation. Attach the hanger bracket to the suspension bolt. Fix it securely using a nut and washer from the upper and lower sides of the hanger bracket.

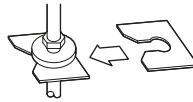

- **Ceiling opening size.** Make sure the ceiling opening is within the following limits:

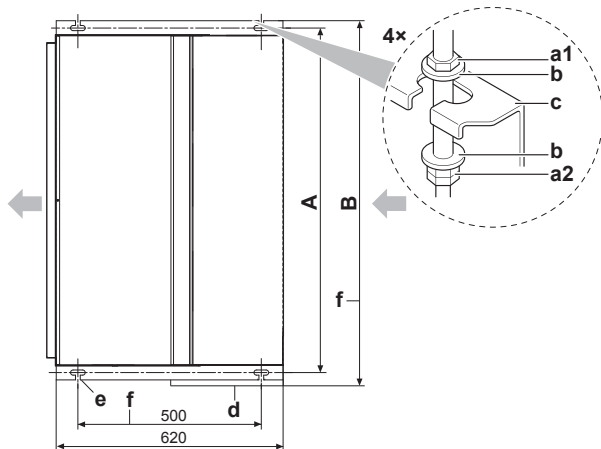

Class	A (mm)	B (mm)
FDXM25+35	740	790
FDXM50+60	1140	1190

- a1 Nut (field supply)
- a2 Double nut (field supply)
- b Washer (accessories)
- c Hanger bracket
- d Control box
- e Suspension bolt pitch
- f Overall dimension

- **External static pressure.** Refer to technical documentation to ensure that the unit's external static pressure is not exceeded.

- **Ceiling opening.** (Ceiling with opening for installation)

- 1 Pass all pipes and wiring through the unit's piping and wiring holes.
- 2 Make sure that the ceiling is level.

- **Installation example:**

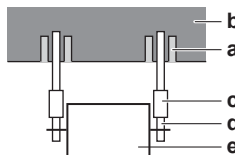

- a Anchor bolt
- b Ceiling slab
- c Long nut or turn-buckle
- d Suspension bolt
- e Indoor unit

- **Install suction cover and air filter (accessory)** In case of bottom suction:

- 3 Remove the suction cover.

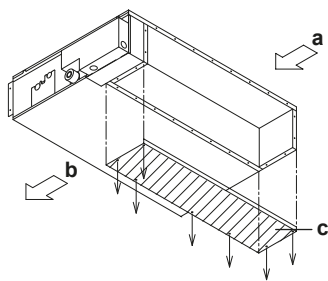

4 Reattach the removed suction cover.

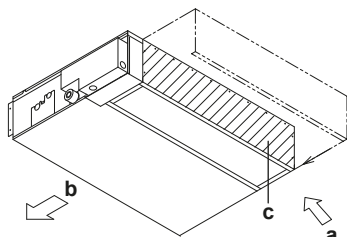

- a Air inlet
- b Air outlet
- c Suction cover

5 Attach the air filter (accessory) by pushing down the hooks (2 hooks for 25+35 type, 3 hooks for 50+60 type).

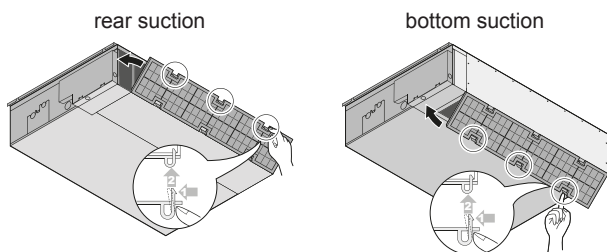

• **Install the unit temporarily.**

6 Attach the hanger bracket to the suspension bolt.

7 Fix the unit securely.

• **Level.** Make sure the unit is level at all four corners using a level or a water-filled vinyl tube.

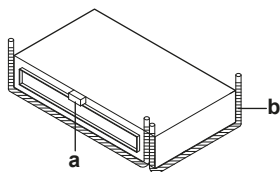

- a Level
- b Vinyl tube

8 Tighten the upper nut.



NOTICE

Do NOT install the unit tilted. **Possible consequence:** If the unit is tilted against the direction of the condensate flow (the drain piping side is raised), the float switch might malfunction and cause water to drip.

6.2.3 Guidelines when installing the ducting



WARNING

If the one or more rooms are connected with the unit via duct system make sure:

- there are no operating ignition sources (example: open flames, an operating gas appliance or an operating electric heater) in case the floor area is less than A_{min} specified in the General safety precautions;
- no auxiliary devices, which may be a potential ignition source, are installed in the duct work (example: hot surfaces with a temperature exceeding 700°C and electric switching device);
- only auxiliary devices approved by manufacturer are used in the duct work.



WARNING

Do NOT install operating ignition sources (example: open flames, an operating gas appliance or an operating electric heater) in the duct work.

The ducting is to be field supplied.

• **Air inlet side.** Attach the duct and intake-side flange (field supply). For connecting the flange, use 7 accessory screws.

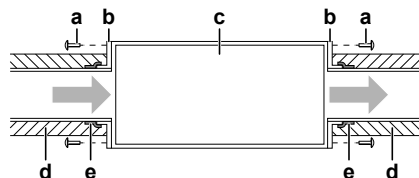

- a Connection screw (accessory)
- b Flange (field supply)
- c Main unit
- d Insulation (field supply)
- e Aluminium tape (field supply)

• **Filter.** Be sure to attach an air filter inside the air passage on the intake side. Use an air filter with dust collecting efficiency $\geq 50\%$ (gravimetric method). The included filter is not used when the intake duct is attached.

• **Air outlet side.** Connect the duct according to the inside dimension of the outlet-side flange.

• **Air leaks.** Wind aluminium tape around the intake side flange and duct connection. Make sure there are no air leaks at any other connection.

• **Insulation.** Insulate the duct to prevent condensation from forming. Use glass wool or polyethylene foam 25 mm thick.

6.2.4 Guidelines when installing the drain piping

General guidelines

• **Drain pump.** For this "high lift type", the drainage sounds will be reduced when the drain pump is installed in a higher location. Recommended height is 300 mm.

• **Pipe length.** Keep drain piping as short as possible.

• **Pipe size.** Keep the pipe size equal to or greater than that of the connecting pipe (vinyl pipe of 20 mm nominal diameter and 26 mm outer diameter).

• **Slope.** Make sure the drain piping slopes down (at least 1/100) to prevent air from being trapped in the piping. Use hanging bars as shown.

6 Installation

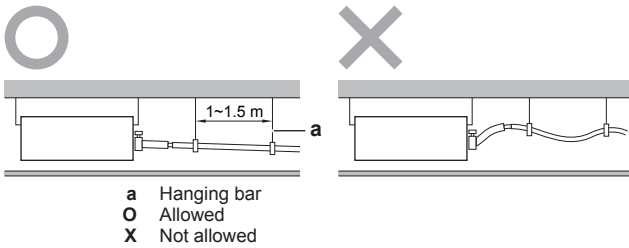

- **Condensation.** Take measures against condensation. Insulate the complete drain piping in the building.

To connect the drain piping to the indoor unit

NOTICE

Incorrect connection of the drain hose might cause leaks, and damage the installation space and surroundings.

- 1 Push the drain hose as far as possible over the drain pipe connection.
- 2 Tighten the metal clamp until the screw head is less than 4 mm from the metal clamp part.
- 3 Check for water leaks (see "To check for water leaks" on page 12).
- 4 Install the insulation piece (drain pipe).
- 5 Wind the large sealing pad (= insulation) around the metal clamp and drain hose, and fix it with cable ties.
- 6 Connect the drain piping to the drain hose.

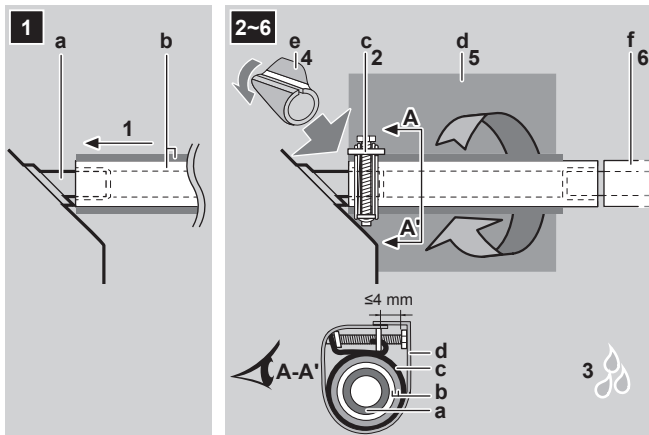

- a Drain pipe connection (attached to the unit)
- b Drain hose (accessory)
- c Metal clamp (accessory)
- d Large sealing pad (accessory)
- e Insulation piece (drain pipe) (accessory)
- f Drain piping (field supply)

NOTICE

- Do NOT remove the drain pipe plug. Water might leak out.
- Use the drain outlet only to discharge the water if the drain pump is not used or before maintenance.
- Insert and remove the drain plug gently. Excessive force may deform the drain socket of the drain pan.

Pull out the plug.

- Do NOT wiggle the plug up and down.

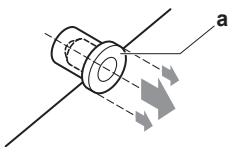

Push in the plug.

- Set the plug and push it in using a Phillips screwdriver.

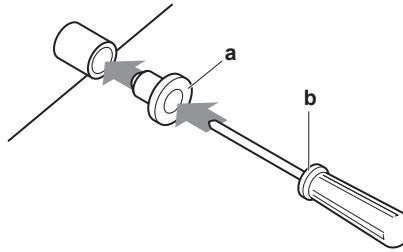

- a Drain plug
- b Phillips screwdriver

To check for water leaks

Gradually pour approximately 1 l of water in the drain pan, and check for water leaks.

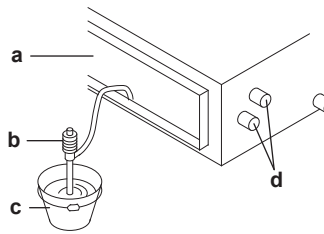

- a Air outlet
- b Portable pump
- c Bucket
- d Refrigerant pipes
- e Drain outlet

6.3 Connecting the refrigerant piping

6.3.1 About connecting the refrigerant piping

Before connecting the refrigerant piping

Make sure the outdoor and indoor unit are mounted.

Typical workflow

Connecting the refrigerant piping involves:

- Connecting the refrigerant piping to the outdoor unit
- Connecting the refrigerant piping to the indoor unit
- Insulating the refrigerant piping
- Keeping in mind the guidelines for:
 - Pipe bending
 - Flaring pipe ends
 - Brazing
 - Using the stop valves

6.3.2 Precautions when connecting the refrigerant piping

INFORMATION

Also read the precautions and requirements in the following chapters:

- General safety precautions
- Preparation

DANGER: RISK OF BURNING

CAUTION

- Do NOT use mineral oil on flared part.
- NEVER install a drier to this unit to guarantee its lifetime. The drying material may dissolve and damage the system.



NOTICE

Take the following precautions on refrigerant piping into account:

- Avoid anything but the designated refrigerant to get mixed into the refrigerant cycle (e.g. air).
- Only use R32 or R410A when adding refrigerant. Refer to the outdoor unit specifications for the type of refrigerant to be used.
- Only use installation tools (e.g. manifold gauge set) that are exclusively used for R32 or R410A installations to withstand the pressure and to prevent foreign materials (e.g. mineral oils and moisture) from mixing into the system.
- Install the piping so that the flare is NOT subjected to mechanical stress.
- Protect the piping as described in the following table to prevent dirt, liquid or dust from entering the piping.
- Use caution when passing copper tubes through walls (see figure below).

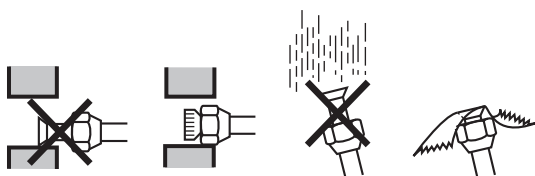

Unit	Installation period	Protection method
Outdoor unit	>1 month	Pinch the pipe
	<1 month	Pinch or tape the pipe
Indoor unit	Regardless of the period	



INFORMATION

Do NOT open the refrigerant stop valve before checking the refrigerant piping. When you need to charge additional refrigerant it is recommended to open the refrigerant stop valve after charging.

6.3.3 Guidelines when connecting the refrigerant piping

Take the following guidelines into account when connecting pipes:

- Coat the flare inner surface with ether oil or ester oil when connecting a flare nut. Tighten 3 or 4 turns by hand, before tightening firmly.

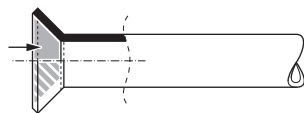

- ALWAYS use 2 wrenches together when loosening a flare nut.
- ALWAYS use a spanner and torque wrench together to tighten the flare nut when connecting the piping. This to prevent nut cracking and leaks.

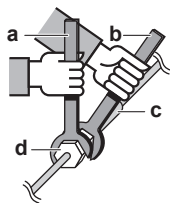

- a Torque wrench
- b Spanner
- c Piping union
- d Flare nut

Piping size (mm)	Tightening torque (N·m)	Flare dimensions (A) (mm)	Flare shape (mm)
Ø6.4	15~17	8.7~9.1	
Ø9.5	33~39	12.8~13.2	
Ø12.7	50~60	16.2~16.6	

6.3.4 Pipe bending guidelines

Use a pipe bender for bending. All pipe bends should be as gentle as possible (bending radius should be 30~40 mm or larger).

6.3.5 To flare the pipe end



CAUTION

- Incomplete flaring may cause refrigerant gas leakage.
- Do NOT re-use flares. Use new flares to prevent refrigerant gas leakage.
- Use flare nuts that are included with the unit. Using different flare nuts may cause refrigerant gas leakage.

- 1 Cut the pipe end with a pipe cutter.
- 2 Remove burrs with the cut surface facing down so that the chips do NOT enter the pipe.

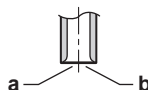

- a Cut exactly at right angles.
- b Remove burrs.

- 3 Remove the flare nut from the stop valve and put the flare nut on the pipe.
- 4 Flare the pipe. Set exactly at the position as shown in the following figure.

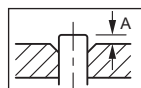

	Flare tool for R410A or R32 (clutch type)	Conventional flare tool	
		Clutch type (Ridgid-type)	Wing nut type (Imperial-type)
A	0~0.5 mm	1.0~1.5 mm	1.5~2.0 mm

- 5 Check that the flaring is properly made.

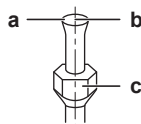

- a Flare's inner surface MUST be flawless.
- b The pipe end MUST be evenly flared in a perfect circle.
- c Make sure the flare nut is fitted.

6.3.6 To connect the refrigerant piping to the indoor unit



CAUTION

Install refrigerating pipe or components in a position where they are unlikely to be exposed to any substance which may corrode refrigerant containing components, unless the components are constructed of materials which are inherently resistant to being corroded or are suitably protected against being so corroded.

6 Installation



WARNING: FLAMMABLE MATERIAL

The R32 refrigerant (if applicable) in this unit is mildly flammable. Refer to the outdoor unit specifications for the type of refrigerant to be used.

- **Pipe length.** Keep refrigerant piping as short as possible.
- **Flare connections.** Connect refrigerant piping to the unit using flare connections.
- **Insulation.** Insulate the refrigerant piping on the indoor unit as follows:

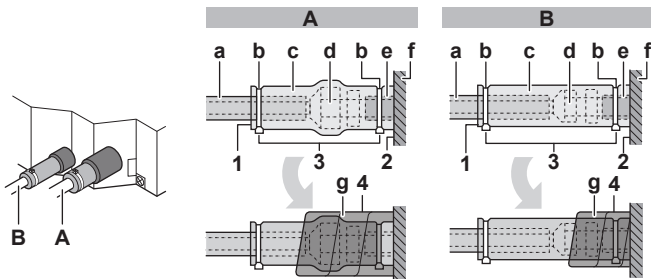

- A** Gas piping
B Liquid piping
- a** Insulation material (field supply)
b Cable tie (accessory)
c Insulation pieces: Large (gas pipe), small (liquid pipe) (accessories)
d Flare nut (attached to the unit)
e Refrigerant pipe connection (attached to the unit)
f Unit
g Sealing pads: Medium 1 (gas pipe), medium 2 (liquid pipe) (accessories)
- 1 Turn up the seams of the insulation pieces.
 - 2 Attach to the base of the unit.
 - 3 Tighten the cable ties on the insulation pieces.
 - 4 Wrap the sealing pad from the base of the unit to the top of the flare nut.



NOTICE

Make sure to insulate all refrigerant piping. Any exposed piping might cause condensation.

6.3.7 To check for leaks



NOTICE

Do NOT exceed the unit's maximum working pressure (see "PS High" on the unit name plate).



NOTICE

Make sure to use a recommended bubble test solution from your wholesaler. Do not use soap water, which may cause cracking of flare nuts (soap water may contain salt, which absorbs moisture that will freeze when the piping gets cold), and/or lead to corrosion of flared joints (soap water may contain ammonia which causes a corrosive effect between the brass flare nut and the copper flare).

- 1 Charge the system with nitrogen gas up to a gauge pressure of at least 200 kPa (2 bar). It is recommended to pressurize to 3000 kPa (30 bar) in order to detect small leaks.
- 2 Check for leaks by applying the bubble test solution to all connections.
- 3 Discharge all nitrogen gas.

6.4 Connecting the electrical wiring

6.4.1 About connecting the electrical wiring

Typical workflow

Connecting the electrical wiring typically consists of the following stages:

- 1 Making sure the power supply system complies with the electrical specifications of the units.
- 2 Connecting the electrical wiring to the outdoor unit.
- 3 Connecting the electrical wiring to the indoor unit.
- 4 Connecting the main power supply.

6.4.2 Precautions when connecting the electrical wiring



INFORMATION

Also read the precautions and requirements in the following chapters:

- General safety precautions
- Preparation



DANGER: RISK OF ELECTROCUTION



WARNING

ALWAYS use multicore cable for power supply cables.



WARNING

If the supply cord is damaged, it MUST be replaced by the manufacturer, its service agent or similarly qualified persons in order to avoid a hazard.

6.4.3 Guidelines when connecting the electrical wiring

Keep the following in mind:

- If stranded conductor wires are used, install a round crimp-style terminal on the end of the wire. Place the round crimp-style terminal on the wire up to the covered part and fasten the terminal with the appropriate tool.

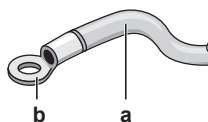

- a** Stranded conductor wire
b Round crimp-style terminal

- Use the following methods for installing wires:

Wire type	Installation method
Single-core wire	<p>a Curled single-core wire b Screw c Flat washer</p>

Wire type	Installation method
Stranded conductor wire with round crimp-style terminal	<p>a Terminal b Screw c Flat washer</p> <p>O Allowed X NOT allowed</p>

6.4.4 To connect the electrical wiring on the indoor unit

It is important to keep the power supply and the transmission wiring separated from each other. In order to avoid any electrical interference the distance between both wirings should ALWAYS be at least 50 mm.

NOTICE

Be sure to keep the power line and transmission line apart from each other. Transmission wiring and power supply wiring may cross, but may NOT run parallel.

1 Remove the service cover.

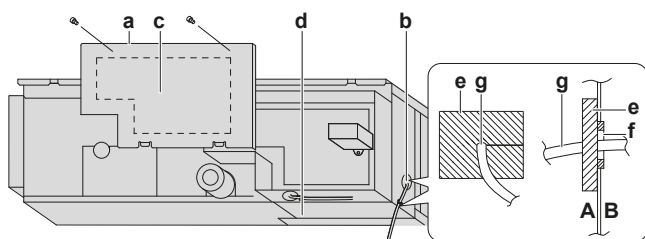

- A Outside the unit
- B Inside the unit
- a Control box cover
- b Connection of interconnection cable (including earth)
- c Wiring diagram
- d Connection of user interface wiring
- e Sealing material (accessory)
- f Opening for cables
- g Wire

- 2 **User interface cable:** Route the cable through the frame, connect the cable to the terminal block, and fix the cable with a cable tie.
- 3 **Interconnection cable** (indoor↔outdoor): Route the cable through the frame, connect the cable to the terminal block (make sure the numbers match with the numbers on the outdoor unit, and connect the earth wire), and fix the cable with a cable tie.
- 4 Wrap the cables with the sealing material (accessory) to prevent water from entering the unit. Seal all gaps to prevent small animals from entering the system.

WARNING

Provide adequate measures to prevent that the unit can be used as a shelter by small animals. Small animals that make contact with electrical parts can cause malfunctions, smoke or fire.

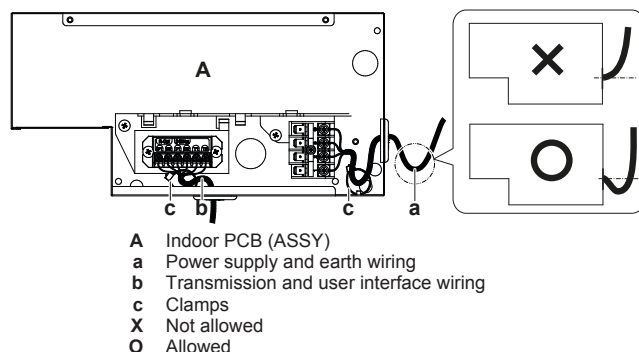

5 Reattach the service cover.

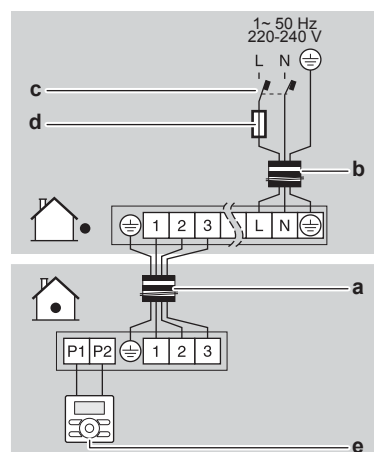

- a Interconnection cable
- b Power supply cable
- c Earth leakage circuit breaker
- d Fuse
- e User interface

6.4.5 Specifications of standard wiring components

Component	Specification
Interconnection cable (indoor↔outdoor)	Minimum cable section of 2.5 mm ² and applicable for 230 V
User interface cable	Vinyl cords with 0.75 to 1.25 mm ² sheath or cables (2-core wires) Maximum 500 m

7 Configuration

7.1 Field settings

Make the following field settings so that they correspond with the actual installation setup and with the needs of the user:

- **External static pressure setting.** See the technical documentation for the range of the external static pressure setting.
- **For heat pump.** If users experience cold feet during the heating function, adjust the discharge grille as shown below.

8 Commissioning

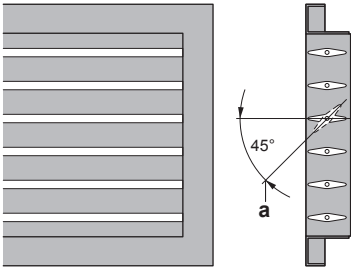

8 Commissioning

8.1 Checklist before commissioning

After the installation of the unit, first check the following items. Once all below checks are fulfilled, the unit **MUST** be closed, **ONLY** then can the unit be powered up.

<input type="checkbox"/>	You read the complete installation instructions, as described in the installer reference guide .
<input type="checkbox"/>	The indoor units are properly mounted.
<input type="checkbox"/>	In case a wireless user interface is used: The indoor unit decoration panel with infrared receiver is installed.
<input type="checkbox"/>	The outdoor unit is properly mounted.
<input type="checkbox"/>	There are NO missing phases or reversed phases .
<input type="checkbox"/>	The system is properly earthed and the earth terminals are tightened.
<input type="checkbox"/>	The fuses or locally installed protection devices are installed according to this document, and have NOT been bypassed.
<input type="checkbox"/>	The power supply voltage matches the voltage on the identification label of the unit.
<input type="checkbox"/>	There are NO loose connections or damaged electrical components in the switch box.
<input type="checkbox"/>	The insulation resistance of the compressor is OK.
<input type="checkbox"/>	There are NO damaged components or squeezed pipes on the inside of the indoor and outdoor units.
<input type="checkbox"/>	There are NO refrigerant leaks .
<input type="checkbox"/>	The correct pipe size is installed and the pipes are properly insulated.
<input type="checkbox"/>	The stop valves (gas and liquid) on the outdoor unit are fully open.

8.2 To perform a test run

This task is only applicable when using the BRC1E52 or BRC1E53 user interface. When using any other user interface, see the installation manual or service manual of the user interface.



NOTICE

Do not interrupt the test run.



INFORMATION

Backlight. To perform an ON/OFF action on the user interface, the backlight does not need to be lit. For any other action, it needs to be lit first. The backlight is lit for ± 30 seconds when you press a button.

- 1 Perform introductory steps.

#	Action
1	Open the liquid stop valve (A) and gas stop valve (B) by removing the stem cap and turning counterclockwise with a hex wrench until it stops.
2	Close the service cover to prevent electric shocks.
3	Turn ON power for at least 6 hours before starting operation to protect the compressor.
4	On the user interface, set the unit to cooling operation mode.

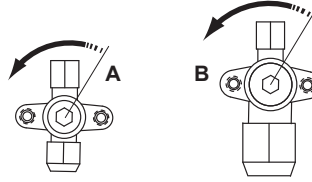

- 2 Start the test run

#	Action	Result
1	Go to the home menu.	
2	Press at least 4 seconds.	The Service Settings menu is displayed.
3	Select Test Operation.	
4	Press.	Test Operation is displayed on the home menu.
5	Press within 10 seconds.	Test run starts.

- 3 Check operation for 3 minutes.

- 4 Stop the test run.

#	Action	Result
1	Press at least 4 seconds.	The Service Settings menu is displayed.
2	Select Test Operation.	
3	Press.	The unit returns to normal operation, and the home menu is displayed.

8.3 Error codes when performing a test run

If the installation of the outdoor unit has NOT been done correctly, the following error codes may be displayed on the user interface:

Error code	Possible cause
Nothing displayed (the currently set temperature is not displayed)	<ul style="list-style-type: none"> The wiring is disconnected or there is a wiring error (between power supply and outdoor unit, between outdoor unit and indoor units, between indoor unit and user interface). The fuse on the outdoor or indoor unit PCB has blown.
E3, E4 or L8	<ul style="list-style-type: none"> The stop valves are closed. The air inlet or air outlet is blocked.
E7	<p>There is a missing phase in case of three-phase power supply units.</p> <p>Note: Operation will be impossible. Turn OFF the power, recheck the wiring, and switch two of the three electrical wires.</p>
L4	The air inlet or air outlet is blocked.
U0	The stop valves are closed.
U2	<ul style="list-style-type: none"> There is a voltage imbalance. There is a missing phase in case of three-phase power supply units. Note: Operation will be impossible. Turn OFF the power, recheck the wiring, and switch two of the three electrical wires.
U4 or UF	The inter-unit branch wiring is not correct.
UA	The outdoor and indoor unit are incompatible.

9 Hand-over to the user

Once the test run is finished and the unit operates properly, please make sure the following is clear for the user:

- Make sure that the user has the printed documentation and ask him/her to keep it for future reference. Inform the user that he can find the complete documentation at the URL mentioned earlier in this manual.
- Explain the user how to properly operate the system and what to do in case of problems.
- Show the user what to do for the maintenance of the unit.

10 Disposal



NOTICE















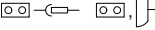

Do NOT try to dismantle the system yourself: dismantling of the system, treatment of the refrigerant, oil and other parts MUST comply with applicable legislation. Units MUST be treated at a specialised treatment facility for reuse, recycling and recovery.

11 Technical data

- A **subset** of the latest technical data is available on the regional Daikin website (publicly accessible).
- The **full set** of latest technical data is available on the Daikin extranet (authentication required).

12 Glossary

11.1 Wiring diagram

Unified Wiring Diagram Legend			
For applied parts and numbering, refer to the wiring diagram on the unit. Part numbering is by Arabic numbers in ascending order for each part and is represented in the overview below by symbol "***" in the part code.			
	: CIRCUIT BREAKER		: PROTECTIVE EARTH
	: CONNECTION		: PROTECTIVE EARTH (SCREW)
	: CONNECTOR		: RECTIFIER
	: EARTH		: RELAY CONNECTOR
	: FIELD WIRING		: SHORT-CIRCUIT CONNECTOR
	: FUSE		: TERMINAL
	: INDOOR UNIT		: TERMINAL STRIP
	: OUTDOOR UNIT		: WIRE CLAMP
BLK : BLACK	GRN : GREEN	PNK : PINK	WHT : WHITE
BLU : BLUE	GRY : GREY	PRP, PPL : PURPLE	YLW : YELLOW
BRN : BROWN	ORG : ORANGE	RED : RED	
A*P : PRINTED CIRCUIT BOARD	PS : SWITCHING POWER SUPPLY		
BS* : PUSHBUTTON ON/OFF, OPERATION SWITCH	PTC* : THERMISTOR PTC		
BZ, H*O : BUZZER	Q* : INSULATED GATE BIPOLAR TRANSISTOR (IGBT)		
C* : CAPACITOR	Q*DI : EARTH LEAK CIRCUIT BREAKER		
AC*, CN*, E*, HA*, HE*, HL*, HN*, HR*, MR*_A, MR*_B, S*, U, V, W, X*A, K*R_*	Q*L : OVERLOAD PROTECTOR		
D*, V*D : DIODE	Q*M : THERMO SWITCH		
DB* : DIODE BRIDGE	R* : RESISTOR		
DS* : DIP SWITCH	R*T : THERMISTOR		
E*H : HEATER	RC : RECEIVER		
F*U, FU* (FOR CHARACTERISTICS, REFER TO PCB INSIDE YOUR UNIT)	S*C : LIMIT SWITCH		
FG* : CONNECTOR (FRAME GROUND)	S*L : FLOAT SWITCH		
H* : HARNESS	S*NPH : PRESSURE SENSOR (HIGH)		
H*P, LED*, V*L : PILOT LAMP, LIGHT EMITTING DIODE	S*NPL : PRESSURE SENSOR (LOW)		
HAP : LIGHT EMITTING DIODE (SERVICE MONITOR GREEN)	S*PH, HPS* : PRESSURE SWITCH (HIGH)		
HIGH VOLTAGE : HIGH VOLTAGE	S*PL : PRESSURE SWITCH (LOW)		
IES : INTELLIGENT EYE SENSOR	S*T : THERMOSTAT		
IPM* : INTELLIGENT POWER MODULE	S*RH : HUMIDITY SENSOR		
K*R, KCR, KFR, KHuR, K*M : MAGNETIC RELAY	S*W, SW* : OPERATION SWITCH		
L : LIVE	SA*, F1S : SURGE ARRESTOR		
L* : COIL	SR*, WLU : SIGNAL RECEIVER		
L*R : REACTOR	SS* : SELECTOR SWITCH		
M* : STEPPER MOTOR	SHEET METAL : TERMINAL STRIP FIXED PLATE		
M*C : COMPRESSOR MOTOR	T*R : TRANSFORMER		
M*F : FAN MOTOR	TC, TRC : TRANSMITTER		
M*P : DRAIN PUMP MOTOR	V*, R*V : VARISTOR		
M*S : SWING MOTOR	V*R : DIODE BRIDGE		
MR*, MRCW*, MRM*, MRN* : MAGNETIC RELAY	WRC : WIRELESS REMOTE CONTROLLER		
N : NEUTRAL	X* : TERMINAL		
n*, N=* : NUMBER OF PASSES THROUGH FERRITE CORE	X*M : TERMINAL STRIP (BLOCK)		
PAM : PULSE-AMPLITUDE MODULATION	Y*E : ELECTRONIC EXPANSION VALVE COIL		
PCB* : PRINTED CIRCUIT BOARD	Y*R, Y*S : REVERSING SOLENOID VALVE COIL		
PM* : POWER MODULE	Z*C : FERRITE CORE		
	ZF, Z*F : NOISE FILTER		

12 Glossary

Dealer

Sales distributor for the product.

Authorized installer

Technical skilled person who is qualified to install the product.

User

Person who is owner of the product and/or operates the product.

Applicable legislation

All international, European, national and local directives, laws, regulations and/or codes that are relevant and applicable for a certain product or domain.

Service company

Qualified company which can perform or coordinate the required service to the product.

Installation manual

Instruction manual specified for a certain product or application, explaining how to install, configure and maintain it.

Operation manual

Instruction manual specified for a certain product or application, explaining how to operate it.

Maintenance instructions

Instruction manual specified for a certain product or application, which explains (if relevant) how to install, configure, operate and/or maintain the product or application.

Accessories

Labels, manuals, information sheets and equipment that are delivered with the product and that need to be installed according to the instructions in the accompanying documentation.

Optional equipment

Equipment made or approved by Daikin that can be combined with the product according to the instructions in the accompanying documentation.

Field supply

Equipment NOT made by Daikin that can be combined with the product according to the instructions in the accompanying documentation.

ERC

DAIKIN INDUSTRIES CZECH REPUBLIC s.r.o.

U Nové Hospody 1/1155, 301 00 Plzeň Skvrňany, Czech Republic

DAIKIN EUROPE N.V.

Zandvoordestraat 300, B-8400 Oostende, Belgium

Copyright 2017 Daikin

4P550955-1 2018.07