

Service Manual

Inverter Pair Wall Mounted Type J-Series



[Applied Models]

- Inverter Pair : Heat Pump

Inverter Pair Wall Mounted Type J-Series

●Heat Pump

Indoor Unit

FTX20JV1B
FTX25JV1B
FTX35JV1B

ATX20JV1B
ATX25JV1B
ATX35JV1B

FTX20J2V1B
FTX25J2V1B
FTX35J2V1B

ATX20J2V1B
ATX25J2V1B
ATX35J2V1B

Outdoor Unit

RX20JV1B
RX25JV1B
RX35JV1B

ARX20JV1B
ARX25JV1B
ARX35JV1B

RX20J3V1B
RX25J3V1B
RX35J3V1B

ARX20J3V1B
ARX25J3V1B
ARX35J3V1B



The removal procedure for each model is separately bound. Refer to page 103 for the booklet number of applicable model.

1. Introduction	V
1.1 Safety Cautions	V
1.2 Used Icons	X
Part 1 List of Functions	1
1. Functions.....	2
Part 2 Specifications	4
1. Specifications	5
Part 3 Printed Circuit Board Connector Wiring Diagram	13
1. Indoor Unit.....	14
2. Outdoor Unit.....	16
Part 4 Function and Control.....	18
1. Main Functions.....	19
1.1 Temperature Control	19
1.2 Frequency Principle.....	19
1.3 Airflow Direction Control	21
1.4 Fan Speed Control for Indoor Unit	22
1.5 Program Dry Operation	23
1.6 Automatic Operation.....	24
1.7 Thermostat Control.....	25
1.8 NIGHT SET Mode	26
1.9 ECONO Operation	26
1.10 Inverter POWERFUL Operation	27
1.11 Clock Setting	27
1.12 Other Functions.....	28
2. Function of Thermistor	29
3. Control Specification	30
3.1 Mode Hierarchy	30
3.2 Frequency Control.....	30
3.3 Controls at Mode Changing / Start-up.....	32
3.4 Discharge Pipe Temperature Control.....	33
3.5 Input Current Control.....	34
3.6 Freeze-up Protection Control	35
3.7 Heating Peak-cut Control	35
3.8 Outdoor Fan Control.....	36
3.9 Liquid Compression Protection Function.....	36
3.10 Defrost Control	37
3.11 Electronic Expansion Valve Control	38
3.12 Malfunctions	41
Part 5 Remote Controller	42
1. Remote Controller	43

Part 6 Service Diagnosis	45
1. Troubleshooting with LED	46
1.1 Indoor Unit.....	46
1.2 Outdoor Unit.....	46
2. Problem Symptoms and Measures	47
3. Service Check Function	48
4. Troubleshooting	51
4.1 Error Codes and Description	51
4.2 Indoor Unit PCB Abnormality	52
4.3 Freeze-up Protection Control or Heating Peak-cut Control.....	53
4.4 Fan Motor (DC Motor) or Related Abnormality.....	54
4.5 Thermistor or Related Abnormality (Indoor Unit).....	56
4.6 Refrigerant Shortage.....	57
4.7 Low-voltage Detection or Over-voltage Detection.....	59
4.8 Signal Transmission Error (between Indoor Unit and Outdoor Unit).....	61
4.9 Unspecified Voltage (between Indoor Unit and Outdoor Unit)	63
4.10 Outdoor Unit PCB Abnormality.....	64
4.11 OL Activation (Compressor Overload)	65
4.12 Compressor Lock	67
4.13 DC Fan Lock	68
4.14 Input Overcurrent Detection	69
4.15 Four Way Valve Abnormality.....	70
4.16 Discharge Pipe Temperature Control.....	72
4.17 High Pressure Control in Cooling	73
4.18 Compressor System Sensor Abnormality	74
4.19 Position Sensor Abnormality	75
4.20 DC Voltage / Current Sensor Abnormality.....	77
4.21 Thermistor or Related Abnormality (Outdoor Unit).....	78
4.22 Electrical Box Temperature Rise.....	80
4.23 Radiation Fin Temperature Rise	81
4.24 Output Overcurrent Detection	83
5. Check	85
5.1 Thermistor Resistance Check	85
5.2 Fan Motor Connector Output Check	86
5.3 Power Supply Waveforms Check.....	87
5.4 Electronic Expansion Valve Check.....	87
5.5 Four Way Valve Performance Check.....	88
5.6 Inverter Units Refrigerant System Check.....	88
5.7 Inverter Analyzer Check.....	89
5.8 Rotation Pulse Check on the Outdoor Unit PCB.....	90
5.9 Installation Condition Check.....	91
5.10 Discharge Pressure Check.....	91
5.11 Outdoor Fan System Check.....	92
5.12 Main Circuit Short Check.....	92
5.13 Power Module Check	93
Part 7 Tips for Servicing	94
1. Tips for Servicing	95
1.1 Pump Down Operation	95
1.2 Forced Cooling Operation	95

- 2. Trial Operation96
- 3. Field Settings97
 - 3.1 When 2 Units are Installed in 1 Room.....97
 - 3.2 Jumper Settings97
- 4. Silicon Grease on Power Transistor / Diode Bridge98





Part 8 Appendix..... 99

- 1. Piping Diagrams100
 - 1.1 Indoor Unit.....100
 - 1.2 Outdoor Unit.....101
- 2. Wiring Diagrams.....102
 - 2.1 Indoor Unit.....102
 - 2.2 Outdoor Unit.....102
- 3. Removal Procedure (Booklet No.)103







1. Introduction





1.1 Safety Cautions







Cautions and Warnings



- Be sure to read the following safety cautions before conducting repair work.
- The caution items are classified into “ **Warning**” and “ **Caution**”. The “ **Warning**” items are especially important since they can lead to death or serious injury if they are not followed closely. The “ **Caution**” items can also lead to serious accidents under some conditions if they are not followed. Therefore, be sure to observe all the safety caution items described below.
- About the pictograms
 - △ This symbol indicates the item for which caution must be exercised.
The pictogram shows the item to which attention must be paid.
 - This symbol indicates the prohibited action.
The prohibited item or action is shown in the illustration or near the symbol.
 - This symbol indicates the action that must be taken, or the instruction.
The instruction is shown in the illustration or near the symbol.
- After the repair work is complete, be sure to conduct a test operation to ensure that the equipment operates normally, and explain the cautions for operating the product to the customer.

1.1.1 Cautions Regarding Safety of Workers









 Warning	
Do not store the equipment in a room with successive fire sources (e.g., naked flame, gas appliance, electric heater).	
Be sure to disconnect the power cable plug from the plug socket before disassembling the equipment for repair. Working on the equipment that is connected to the power supply may cause an electrical shock. If it is necessary to supply power to the equipment to conduct the repair or inspecting the circuits, do not touch any electrically charged sections of the equipment.	
If the refrigerant gas is discharged during the repair work, do not touch the discharged refrigerant gas. The refrigerant gas may cause frostbite.	
When disconnecting the suction or discharge pipe of the compressor at the welded section, evacuate the refrigerant gas completely at a well-ventilated place first. If there is gas remaining inside the compressor, the refrigerant gas or refrigerating machine oil discharges when the pipe is disconnected, and it may cause injury.	
If the refrigerant gas leaks during the repair work, ventilate the area. The refrigerant gas may generate toxic gases when it contacts flames.	
The step-up capacitor supplies high-voltage electricity to the electrical components of the outdoor unit. Be sure to discharge the capacitor completely before conducting repair work. A charged capacitor may cause an electrical shock.	









 Warning	
Do not start or stop the air conditioner operation by plugging or unplugging the power cable plug. Plugging or unplugging the power cable plug to operate the equipment may cause an electrical shock or fire.	
Be sure to wear a safety helmet, gloves, and a safety belt when working at a high place (more than 2 m). Insufficient safety measures may cause a fall accident.	
In case of R-32 / R-410A refrigerant models, be sure to use pipes, flare nuts and tools for the exclusive use of the R-32 / R-410A refrigerant. The use of materials for R-22 refrigerant models may cause a serious accident such as a damage of refrigerant cycle as well as an equipment failure.	
Do not mix air or gas other than the specified refrigerant (R-32 / R-410A / R-22) in the refrigerant system. If air enters the refrigerating system, an excessively high pressure results, causing equipment damage and injury.	



 Caution	
Do not repair the electrical components with wet hands. Working on the equipment with wet hands may cause an electrical shock.	
Do not clean the air conditioner by splashing water. Washing the unit with water may cause an electrical shock.	
Be sure to provide the grounding when repairing the equipment in a humid or wet place, to avoid electrical shocks.	
Be sure to turn off the power switch and unplug the power cable when cleaning the equipment. The internal fan rotates at a high speed, and may cause injury.	
Be sure to conduct repair work with appropriate tools. The use of inappropriate tools may cause injury.	
Be sure to check that the refrigerating cycle section has cooled down enough before conducting repair work. Working on the unit when the refrigerating cycle section is hot may cause burns.	









 Caution	
Use the welder in a well-ventilated place. Using the welder in an enclosed room may cause oxygen deficiency.	

1.1.2 Cautions Regarding Safety of Users

 Warning	
Do not store the equipment in a room with successive fire sources (e.g., naked flame, gas appliance, electric heater).	
Be sure to use parts listed in the service parts list of the applicable model and appropriate tools to conduct repair work. Never attempt to modify the equipment. The use of inappropriate parts or tools may cause an electrical shock, excessive heat generation or fire.	
If the power cable and lead wires have scratches or deteriorated, be sure to replace them. Damaged cable and wires may cause an electrical shock, excessive heat generation or fire.	
Do not use a joined power cable or extension cable, or share the same power outlet with other electrical appliances, since it may cause an electrical shock, excessive heat generation or fire.	
Be sure to use an exclusive power circuit for the equipment, and follow the local technical standards related to the electrical equipment, the internal wiring regulations, and the instruction manual for installation when conducting electrical work. Insufficient power circuit capacity and improper electrical work may cause an electrical shock or fire.	
Be sure to use the specified cable for wiring between the indoor and outdoor units. Make the connections securely and route the cable properly so that there is no force pulling the cable at the connection terminals. Improper connections may cause excessive heat generation or fire.	
When wiring between the indoor and outdoor units, make sure that the terminal cover does not lift off or dismount because of the cable. If the cover is not mounted properly, the terminal connection section may cause an electrical shock, excessive heat generation or fire.	
Do not damage or modify the power cable. Damaged or modified power cable may cause an electrical shock or fire. Placing heavy items on the power cable, and heating or pulling the power cable may damage the cable.	





 Warning	
Do not mix air or gas other than the specified refrigerant (R-32 / R-410A / R-22) in the refrigerant system. If air enters the refrigerating system, an excessively high pressure results, causing equipment damage and injury.	
If the refrigerant gas leaks, be sure to locate the leaking point and repair it before charging the refrigerant. After charging refrigerant, make sure that there is no refrigerant leak. If the leaking point cannot be located and the repair work must be stopped, be sure to perform pump-down and close the service valve, to prevent the refrigerant gas from leaking into the room. The refrigerant gas itself is harmless, but it may generate toxic gases when it contacts flames, such as fan and other heaters, stoves and ranges.	
When relocating the equipment, make sure that the new installation site has sufficient strength to withstand the weight of the equipment. If the installation site does not have sufficient strength and if the installation work is not conducted securely, the equipment may fall and cause injury.	
Check to make sure that the power cable plug is not dirty or loose, then insert the plug into a power outlet securely. If the plug has dust or loose connection, it may cause an electrical shock or fire.	
Be sure to install the product correctly by using the provided standard installation frame. Incorrect use of the installation frame and improper installation may cause the equipment to fall, resulting in injury.	For unitary type only 
Be sure to install the product securely in the installation frame mounted on the window frame. If the unit is not securely mounted, it may fall and cause injury.	For unitary type only 
When replacing the coin battery in the remote controller, be sure to dispose of the old battery to prevent children from swallowing it. If a child swallows the coin battery, see a doctor immediately.	

 Caution	
Installation of a leakage breaker is necessary in some cases depending on the conditions of the installation site, to prevent electrical shocks.	
Do not install the equipment in a place where there is a possibility of combustible gas leaks. If the combustible gas leaks and remains around the unit, it may cause a fire.	

 Caution	
Check to see if the parts and wires are mounted and connected properly, and if the connections at the soldered or crimped terminals are secure. Improper installation and connections may cause excessive heat generation, fire or an electrical shock.	
If the installation platform or frame has corroded, replace it. Corroded installation platform or frame may cause the unit to fall, resulting in injury.	
Check the grounding, and repair it if the equipment is not properly grounded. Improper grounding may cause an electrical shock.	
Be sure to measure the insulation resistance after the repair, and make sure that the resistance is 1 MΩ or higher. Faulty insulation may cause an electrical shock.	
Be sure to check the drainage of the indoor unit after the repair. Faulty drainage may cause the water to enter the room and wet the furniture and floor.	
Do not tilt the unit when removing it. The water inside the unit may spill and wet the furniture and floor.	
Be sure to install the packing and seal on the installation frame properly. If the packing and seal are not installed properly, water may enter the room and wet the furniture and floor.	For unitary type only 

1.2 Used Icons

Icons are used to attract the attention of the reader to specific information. The meaning of each icon is described in the table below:

Icon	Type of Information	Description
 Note:	Note	A “note” provides information that is not indispensable, but may nevertheless be valuable to the reader, such as tips and tricks.
 Caution	Caution	A “caution” is used when there is danger that the reader, through incorrect manipulation, may damage equipment, lose data, get an unexpected result or has to restart (part of) a procedure.
 Warning	Warning	A “warning” is used when there is danger of personal injury.
	Reference	A “reference” guides the reader to other places in this binder or in this manual, where he/she will find additional information on a specific topic.

Part 1

List of Functions

1. Functions.....2

1. Functions

Category	Functions			Category	Functions			
		FTX20/25/35JV1B RX20/25/35JV1B	FTX20/25/35J2V1B RX20/25/35J3V1B			FTX20/25/35JV1B RX20/25/35JV1B	FTX20/25/35J2V1B RX20/25/35J3V1B	
Basic Function	Inverter (with inverter power control)	●	●	Health & Clean	Air-purifying filter	—	—	
	Operation limit for cooling (°CDB)	10 ~46	10 ~46		Photocatalytic deodorizing filter	—	—	
	Operation limit for heating (°CWB)	-15 ~18	-15 ~18		Air-purifying filter with photocatalytic deodorizing function	—	—	
	PAM control	●	●		Titanium apatite photocatalytic air-purifying filter	●	●	
	Standby electricity saving	●	●		Air filter (prefilter)	●	●	
Compressor	Oval scroll compressor	—	—	Wipe-clean flat panel	●	●		
	Swing compressor	●	●	Washable grille	—	—		
	Rotary compressor	—	—	MOLD PROOF operation	—	—		
	Reluctance DC motor	●	●	Heating dry operation	—	—		
Comfortable Airflow	Power-airflow flap	●	●	Good-sleep cooling operation	—	—		
	Power-airflow dual flaps	—	—	Timer	WEEKLY TIMER operation	—	—	
	Power-airflow diffuser	—	—		24-hour ON/OFF TIMER	●	●	
	Wide-angle louvers	●	●		NIGHT SET mode	●	●	
	Vertical auto-swing (up and down)	●	●	Worry Free "Reliability & Durability"	Auto-restart (after power failure)	●	●	
	Horizontal auto-swing (right and left)	—	—		Self-diagnosis (digital, LED) display	●	●	
	3-D airflow	—	—		Wiring error check function	—	—	
	COMFORT AIRFLOW operation	●	●		Anti-corrosion treatment of outdoor heat exchanger	●	●	
Comfort Control	Auto fan speed	●	●	Flexibility	Multi-split / split type compatible indoor unit	●	●	
	Indoor unit quiet operation	●	●		Flexible power supply correspondence	—	—	
	NIGHT QUIET mode (automatic)	—	—		High ceiling application	—	—	
	OUTDOOR UNIT QUIET operation (manual)	—	—		Chargeless	10 m	10 m	
	INTELLIGENT EYE operation	—	—		Either side drain (right or left)	●	●	
	Quick warming function (preheating operation)	●	●		Power selection	—	—	
	Hot-start function	●	●		Remote Control	5-room centralized controller (option)	—	—
	Automatic defrosting	●	●			Remote control adaptor (normal open pulse contact) (option)	—	—
Operation	Automatic operation	●	●	Remote control adaptor (normal open contact) (option)		—	—	
	Program dry operation	●	●	Remote Controller	Wireless	●	●	
	Fan only	●	●		Wired (option)	●	●	
Lifestyle Convenience	New POWERFUL operation (non-inverter)	—	—	Remote Controller				
	Inverter POWERFUL operation	●	●					
	Priority-room setting	—	—					
	COOL / HEAT mode lock	—	—					
	HOME LEAVE operation	—	—					
	ECONO operation	●	●					
	Indoor unit [ON/OFF] button	●	●					
	Signal receiving sign	●	●					
	R/C with back light	—	—					
Temperature display	—	—						

Note: ● : Available
— : Not available

Category	Functions	ATX20/25/35JV1B ARX20/25/35JV1B	ATX20/25/35J2V1B ARX20/25/35J3V1B	Category	Functions	ATX20/25/35JV1B ARX20/25/35JV1B	ATX20/25/35J2V1B ARX20/25/35J3V1B	
Basic Function	Inverter (with inverter power control)	●	●	Health & Clean	Air-purifying filter	—	—	
	Operation limit for cooling (°CDB)	10 ~46	10 ~46		Photocatalytic deodorizing filter	—	—	
	Operation limit for heating (°CWB)	-15 ~18	-15 ~18		Air-purifying filter with photocatalytic deodorizing function	—	—	
	PAM control	●	●		Titanium apatite photocatalytic air-purifying filter	●	●	
	Standby electricity saving	●	●		Air filter (prefilter)	●	●	
Compressor	Oval scroll compressor	—	—	Wipe-clean flat panel	●	●		
	Swing compressor	●	●	Washable grille	—	—		
	Rotary compressor	—	—	MOLD PROOF operation	—	—		
	Reluctance DC motor	●	●	Heating dry operation	—	—		
Comfortable Airflow	Power-airflow flap	●	●	Good-sleep cooling operation	—	—		
	Power-airflow dual flaps	—	—	Timer	WEEKLY TIMER operation	—	—	
	Power-airflow diffuser	—	—		24-hour ON/OFF TIMER	●	●	
	Wide-angle louvers	●	●		NIGHT SET mode	●	●	
	Vertical auto-swing (up and down)	●	●	Worry Free "Reliability & Durability"	Auto-restart (after power failure)	●	●	
	Horizontal auto-swing (right and left)	—	—		Self-diagnosis (digital, LED) display	●	●	
	3-D airflow	—	—		Wiring error check function	—	—	
	COMFORT AIRFLOW operation	●	●		Anti-corrosion treatment of outdoor heat exchanger	●	●	
Comfort Control	Auto fan speed	●	●		Flexibility	Multi-split / split type compatible indoor unit	●	●
	Indoor unit quiet operation	●	●	Flexible power supply correspondence		—	—	
	NIGHT QUIET mode (automatic)	—	—	High ceiling application		—	—	
	OUTDOOR UNIT QUIET operation (manual)	—	—	Chargeless		10 m	10 m	
	INTELLIGENT EYE operation	—	—	Either side drain (right or left)		●	●	
	Quick warming function (preheating operation)	●	●	Power selection		—	—	
	Hot-start function	●	●	Remote Control		5-room centralized controller (option)	—	—
	Automatic defrosting	●	●			Remote control adaptor (normal open pulse contact) (option)	—	—
Operation	Automatic operation	●	●		Remote control adaptor (normal open contact) (option)	—	—	
	Program dry operation	●	●	DIII-NET compatible (adaptor) (option)	—	—		
	Fan only	●	●	Remote Controller	Wireless	●	●	
Lifestyle Convenience	New POWERFUL operation (non-inverter)	—	—		Wired (option)	●	●	
	Inverter POWERFUL operation	●	●					
	Priority-room setting	—	—					
	COOL / HEAT mode lock	—	—					
	HOME LEAVE operation	—	—					
	ECONO operation	●	●					
	Indoor unit [ON/OFF] button	●	●					
	Signal receiving sign	●	●					
R/C with back light	—	—						
Temperature display	—	—						

Note: ● : Available
 — : Not available

Part 2 Specifications

1. Specifications5

1. Specifications

50 Hz, 230 V

Model	Indoor Unit		FTX20JV1B		FTX25JV1B	
	Outdoor Unit		RX20JV1B		RX25JV1B	
			Cooling	Heating	Cooling	Heating
Capacity Rated (Min. ~ Max.)	kW		2.0 (1.3 ~ 2.6)	2.5 (1.3 ~ 3.5)	2.5 (1.3 ~ 3.0)	2.8 (1.3 ~ 4.0)
	Btu/h		6,800 (4,400 ~ 8,900)	8,500 (4,400 ~ 11,600)	8,500 (4,400 ~ 10,200)	9,600 (4,400 ~ 13,600)
	kcal/h		1,720 (1,120 ~ 2,240)	2,150 (1,120 ~ 3,010)	2,150 (1,120 ~ 2,580)	2,410 (1,120 ~ 3,440)
Running Current (Rated)	A		2.7	3.0	3.7	3.2
Power Consumption Rated (Min. ~ Max.)	W		550 (310 ~ 720)	590 (250 ~ 950)	730 (310 ~ 1,050)	690 (250 ~ 1,110)
Power Factor (Rated)	%		88.6	91.6	85.8	93.8
COP Rated (Min. ~ Max.)	W/W		3.64 (4.19 ~ 3.61)	4.24 (5.20 ~ 3.68)	3.42 (4.19 ~ 2.86)	4.06 (5.20 ~ 3.60)
Piping Connections	Liquid	mm	φ 6.4		φ 6.4	
	Gas	mm	φ 9.5		φ 9.5	
	Drain	mm	φ 18.0		φ 18.0	
Heat Insulation			Both Liquid and Gas Pipes		Both Liquid and Gas Pipes	
Max. Interunit Piping Length	m		15		15	
Max. Interunit Height Difference	m		12		12	
Chargeless	m		10		10	
Amount of Additional Charge of Refrigerant	g/m		20		20	
Indoor Unit			FTX20JV1B		FTX25JV1B	
Front Panel Color			White		White	
Airflow Rate	H	m³/min (cfm)	9.1 (321)	9.4 (331)	9.2 (325)	9.7 (342)
	M		7.4 (261)	7.8 (276)	7.6 (268)	8.0 (283)
	L		5.9 (208)	6.3 (222)	6.0 (212)	6.3 (222)
	SL		4.7 (166)	5.5 (194)	4.8 (169)	5.5 (194)
Fan	Type		Cross Flow Fan		Cross Flow Fan	
	Motor Output	W	16		16	
	Speed	Steps	5 Steps, Quiet, Auto		5 Steps, Quiet, Auto	
Air Direction Control			Right, Left, Horizontal, Downward		Right, Left, Horizontal, Downward	
Air Filter			Removable / Washable / Mildew Proof		Removable / Washable / Mildew Proof	
Running Current (Rated)	A		0.18	0.18	0.18	0.18
Power Consumption (Rated)	W		40	40	40	40
Power Factor	%		96.6	96.6	96.6	96.6
Temperature Control			Microcomputer Control		Microcomputer Control	
Dimensions (H x W x D)	mm		283 x 770 x 198		283 x 770 x 198	
Packaged Dimensions (H x W x D)	mm		263 x 840 x 344		263 x 840 x 344	
Weight (Mass)	kg		7		7	
Gross Weight (Gross Mass)	kg		11		11	
Sound Pressure Level	H / M / L / SL	dB(A)	39 / 33 / 25 / 22	39 / 34 / 28 / 25	40 / 33 / 26 / 22	40 / 34 / 28 / 25
Sound Power Level		dB	55	55	56	56
Outdoor Unit			RX20JV1B		RX25JV1B	
Casing Color			Ivory White		Ivory White	
Compressor	Type		Hermetically Sealed Swing Type		Hermetically Sealed Swing Type	
	Model		1YC23AEXD		1YC23AEXD	
	Motor Output	W	750		750	
Refrigerant Oil	Type		FVC50K		FVC50K	
	Charge	L	0.375		0.375	
Refrigerant	Type		R-410A		R-410A	
	Charge	kg	0.74		0.74	
Airflow Rate	H	m³/min (cfm)	29.2 (1,030)	26.2 (927)	29.2 (1,030)	26.2 (927)
Fan	Type		Propeller		Propeller	
	Motor Output	W	33		33	
Running Current (Rated)	A		2.52	2.62	3.52	3.02
Power Consumption (Rated)	W		510	550	690	650
Power Factor	%		88.0	91.3	85.2	93.6
Starting Current	A		2.7		3.7	
Dimensions (H x W x D)	mm		550 x 658 x 275		550 x 658 x 275	
Packaged Dimensions (H x W x D)	mm		616 x 788 x 359		616 x 788 x 359	
Weight (Mass)	kg		28		28	
Gross Weight (Gross Mass)	kg		31		31	
Sound Pressure Level (H)		dB(A)	46	47	46	47
Sound Power Level (H)		dB	60	61	60	61
Drawing No.			3D065930		3D065931	

Note: ■ The data are based on the conditions shown in the table below.

Cooling	Heating	Piping Length
Indoor ; 27°CDB / 19°CWB Outdoor ; 35°CDB / 24°CWB	Indoor ; 20°CDB Outdoor ; 7°CDB / 6°CWB	5 m

Conversion Formulae
kcal/h = kW × 860 Btu/h = kW × 3412 cfm = m³/min × 35.3

50 Hz, 230 V

Model	Indoor Unit		FTX35JV1B	
	Outdoor Unit		RX35JV1B	
			Cooling	Heating
Capacity Rated (Min. ~ Max.)	kW		3.3 (1.3 ~ 3.8)	3.5 (1.3 ~ 4.8)
	Btu/h		11,300 (4,400 ~ 13,000)	11,900 (4,400 ~ 16,400)
	kcal/h		2,840 (1,120 ~ 3,270)	3,010 (1,120 ~ 4,130)
Running Current (Rated)	A		5.2	4.7
Power Consumption Rated (Min. ~ Max.)	W		980 (290 ~ 1,300)	930 (290 ~ 1,290)
Power Factor	%		81.9	86.0
COP Rated (Min. ~ Max.)	W/W		3.37 (4.48 ~ 2.92)	3.76 (4.48 ~ 3.72)
Piping Connections	Liquid	mm	φ 6.4	
	Gas	mm	φ 9.5	
	Drain	mm	φ 18.0	
Heat Insulation	Both Liquid and Gas Pipes			
Max. Interunit Piping Length	m		15	
Max. Interunit Height Difference	m		12	
Chargeless	m		10	
Amount of Additional Charge of Refrigerant	g/m		20	
Indoor Unit		FTX35JV1B		
Front Panel Color		White		
Airflow Rate	H	m³/min (cfm)	9.3 (328)	10.1 (356)
	M		7.7 (272)	8.4 (295)
	L		6.1 (215)	6.7 (235)
	SL		4.9 (173)	5.7 (201)
Fan	Type		Cross Flow Fan	
	Motor Output	W	16	
	Speed	Steps	5 Steps, Quiet, Auto	
Air Direction Control	Right, Left, Horizontal, Downward			
Air Filter	Removable / Washable / Mildew Proof			
Running Current (Rated)	A		0.18	0.18
Power Consumption (Rated)	W		40	40
Power Factor	%		96.6	96.6
Temperature Control	Microcomputer Control			
Dimensions (H x W x D)	mm		283 x 770 x 198	
Packaged Dimensions (H x W x D)	mm		263 x 840 x 344	
Weight (Mass)	kg		7	
Gross Weight (Gross Mass)	kg		11	
Sound Pressure Level	H / M / L / SL	dB(A)	41 / 34 / 27 / 23	41 / 35 / 29 / 26
Sound Power Level		dB	57	57
Outdoor Unit		RX35JV1B		
Casing Color		Ivory White		
Compressor	Type		Hermetically Sealed Swing Type	
	Model		1YC23AEXD	
	Motor Output	W	750	
Refrigerant Oil	Type		FVC50K	
	Charge	L	0.375	
Refrigerant	Type		R-410A	
	Charge	kg	1.0	
Airflow Rate	H	m³/min (cfm)	27.6 (975)	24.5 (865)
Fan	Type		Propeller	
	Motor Output	W	33	
Running Current (Rated)	A		5.02	4.52
Power Consumption (Rated)	W		940	890
Power Factor	%		86.0	85.6
Starting Current	A		5.0	
Dimensions (H x W x D)	mm		550 x 658 x 275	
Packaged Dimensions (H x W x D)	mm		616 x 788 x 359	
Weight (Mass)	kg		30	
Gross Weight (Gross Mass)	kg		34	
Sound Pressure Level (H)		dB(A)	48	48
Sound Power Level (H)		dB	62	62
Drawing No.	3D065932			

Note: ■ The data are based on the conditions shown in the table below.

Cooling	Heating	Piping Length
Indoor ; 27°CDB / 19°CWB Outdoor ; 35°CDB / 24°CWB	Indoor ; 20°CDB Outdoor ; 7°CDB / 6°CWB	5 m

Conversion Formulae
kcal/h = kW × 860 Btu/h = kW × 3412 cfm = m³/min × 35.3

50 Hz, 230 V

Model	Indoor Unit		FTX20J2V1B		FTX25J2V1B	
	Outdoor Unit		RX20J3V1B		RX25J3V1B	
			Cooling	Heating	Cooling	Heating
Capacity Rated (Min. ~ Max.)	kW		2.0 (1.3 ~ 2.6)	2.5 (1.3 ~ 3.5)	2.5 (1.3 ~ 3.0)	2.8 (1.3 ~ 4.0)
	Btu/h		6,800 (4,400 ~ 8,900)	8,500 (4,400 ~ 11,900)	8,500 (4,400 ~ 10,200)	9,600 (4,400 ~ 13,600)
	kcal/h		1,720 (1,120 ~ 2,240)	2,150 (1,120 ~ 3,010)	2,150 (1,120 ~ 2,580)	2,410 (1,120 ~ 3,440)
Running Current (Rated)	A		2.7	3.0	3.7	3.2
Power Consumption Rated (Min. ~ Max.)	W		550 (310 ~ 720)	590 (250 ~ 950)	730 (310 ~ 1,050)	690 (250 ~ 1,110)
Power Factor (Rated)	%		88.6	85.5	85.8	93.8
COP Rated (Min. ~ Max.)	W/W		3.64 (4.19 ~ 3.61)	4.24 (5.20 ~ 3.68)	3.42 (4.19 ~ 2.86)	4.06 (5.20 ~ 3.60)
Piping Connections	Liquid	mm	φ 6.4		φ 6.4	
	Gas	mm	φ 9.5		φ 9.5	
	Drain	mm	φ 18.0		φ 18.0	
Heat Insulation			Both Liquid and Gas Pipes		Both Liquid and Gas Pipes	
Max. Interunit Piping Length	m		15		15	
Max. Interunit Height Difference	m		12		12	
Chargeless	m		10		10	
Amount of Additional Charge of Refrigerant	g/m		20		20	
Indoor Unit			FTX20J2V1B		FTX25J2V1B	
Front Panel Color			White		White	
Airflow Rate	H	m ³ /min (cfm)	9.1 (321)	9.4 (331)	9.2 (325)	9.7 (342)
	M		7.4 (261)	7.8 (276)	7.6 (268)	8.0 (283)
	L		5.9 (208)	6.3 (222)	6.0 (212)	6.3 (222)
	SL		4.7 (166)	5.5 (194)	4.8 (169)	5.5 (194)
Fan	Type		Cross Flow Fan		Cross Flow Fan	
	Motor Output	W	16		16	
	Speed	Steps	5 Steps, Quiet, Auto		5 Steps, Quiet, Auto	
Air Direction Control			Right, Left, Horizontal, Downward		Right, Left, Horizontal, Downward	
Air Filter			Removable / Washable / Mildew Proof		Removable / Washable / Mildew Proof	
Running Current (Rated)	A		0.18	0.18	0.18	0.18
Power Consumption (Rated)	W		40	40	40	40
Power Factor	%		96.6	96.6	96.6	96.6
Temperature Control			Microcomputer Control		Microcomputer Control	
Dimensions (H x W x D)	mm		283 x 770 x 198		283 x 770 x 198	
Packaged Dimensions (H x W x D)	mm		266 x 846 x 345		266 x 846 x 345	
Weight (Mass)	kg		7		7	
Gross Weight (Gross Mass)	kg		11		11	
Sound Pressure Level	H / M / L / SL	dB(A)	39 / 33 / 25 / 22	39 / 34 / 28 / 25	40 / 33 / 26 / 22	40 / 34 / 28 / 25
Sound Power Level		dB	55	55	55	55
Outdoor Unit			RX20J3V1B		RX25J3V1B	
Casing Color			Ivory White		Ivory White	
Compressor	Type		Hermetically Sealed Swing Type		Hermetically Sealed Swing Type	
	Model		1YC23AEXD		1YC23AEXD	
	Motor Output	W	750		750	
Refrigerant Oil	Type		FVC50K		FVC50K	
	Charge	L	0.375		0.375	
Refrigerant	Type		R-410A		R-410A	
	Charge	kg	0.74		0.74	
Airflow Rate	H	m ³ /min (cfm)	29.2 (1,030)	26.2 (927)	29.2 (1,030)	26.2 (927)
Fan	Type		Propeller		Propeller	
	Motor Output	W	33		33	
Running Current (Rated)	A		2.52	2.82	3.52	3.02
Power Consumption (Rated)	W		510	550	690	650
Power Factor	%		88.0	84.8	85.2	93.6
Starting Current	A		3.0		3.7	
Dimensions (H x W x D)	mm		550 x 658 x 275		550 x 658 x 275	
Packaged Dimensions (H x W x D)	mm		612 x 769 x 350		612 x 769 x 350	
Weight (Mass)	kg		28		28	
Gross Weight (Gross Mass)	kg		31		31	
Sound Pressure Level (H)		dB(A)	46	47	46	47
Sound Power Level (H)		dB	60	61	60	61
Drawing No.			C: 3D080673		C: 3D080674	

Note: ■ The data are based on the conditions shown in the table below.

Cooling	Heating	Piping Length
Indoor ; 27°CDB / 19°CWB Outdoor ; 35°CDB / 24°CWB	Indoor ; 20°CDB Outdoor ; 7°CDB / 6°CWB	5 m

Conversion Formulae
kcal/h = kW × 860 Btu/h = kW × 3412 cfm = m ³ /min × 35.3

50 Hz, 230 V

Model	Indoor Unit		FTX35J2V1B	
	Outdoor Unit		RX35J3V1B	
			Cooling	Heating
Capacity Rated (Min. ~ Max.)	kW		3.3 (1.3 ~ 3.8)	3.5 (1.3 ~ 4.8)
	Btu/h		11,300 (4,400 ~ 13,000)	11,900 (4,400 ~ 16,400)
	kcal/h		2,840 (1,120 ~ 3,270)	3,010 (1,120 ~ 4,130)
Running Current (Rated)	A		5.2	4.7
Power Consumption Rated (Min. ~ Max.)	W		980 (290 ~ 1,300)	930 (290 ~ 1,290)
Power Factor	%		81.9	86.0
COP Rated (Min. ~ Max.)	W/W		3.37 (4.48 ~ 2.92)	3.76 (4.48 ~ 3.72)
Piping Connections	Liquid	mm	φ 6.4	
	Gas	mm	φ 9.5	
	Drain	mm	φ 18.0	
Heat Insulation	Both Liquid and Gas Pipes			
Max. Interunit Piping Length	m		15	
Max. Interunit Height Difference	m		12	
Chargeless	m		10	
Amount of Additional Charge of Refrigerant	g/m		20	
Indoor Unit			FTX35J2V1B	
Front Panel Color			White	
Airflow Rate	H	m³/min (cfm)	9.3 (328)	10.1 (356)
	M		7.7 (272)	8.4 (295)
	L		6.1 (215)	6.7 (235)
	SL		4.9 (173)	5.7 (201)
Fan	Type		Cross Flow Fan	
	Motor Output	W	16	
	Speed	Steps	5 Steps, Quiet, Auto	
Air Direction Control			Right, Left, Horizontal, Downward	
Air Filter			Removable / Washable / Mildew Proof	
Running Current (Rated)	A		0.18	0.18
Power Consumption (Rated)	W		40	40
Power Factor	%		96.6	96.6
Temperature Control			Microcomputer Control	
Dimensions (H x W x D)	mm		283 x 770 x 198	
Packaged Dimensions (H x W x D)	mm		266 x 846 x 345	
Weight (Mass)	kg		7	
Gross Weight (Gross Mass)	kg		11	
Sound Pressure Level	H / M / L / SL	dB(A)	41 / 34 / 27 / 23	41 / 35 / 29 / 26
Sound Power Level		dB	58	58
Outdoor Unit			RX35J3V1B	
Casing Color			Ivory White	
Compressor	Type		Hermetically Sealed Swing Type	
	Model		1YC23AEXD	
	Motor Output	W	750	
Refrigerant Oil	Type		FVC50K	
	Charge	L	0.375	
Refrigerant	Type		R-410A	
	Charge	kg	1.0	
Airflow Rate	H	m³/min (cfm)	27.6 (975)	24.5 (865)
Fan	Type		Propeller	
	Motor Output	W	33	
Running Current (Rated)	A		5.02	4.52
Power Consumption (Rated)	W		940	890
Power Factor	%		81.4	85.6
Starting Current	A		5.2	
Dimensions (H x W x D)	mm		550 x 658 x 275	
Packaged Dimensions (H x W x D)	mm		612 x 769 x 350	
Weight (Mass)	kg		30	
Gross Weight (Gross Mass)	kg		34	
Sound Pressure Level (H)		dB(A)	48	48
Sound Power Level (H)		dB	62	62
Drawing No.	C: 3D080675			

Note: ■ The data are based on the conditions shown in the table below.

Cooling	Heating	Piping Length
Indoor ; 27°CDB / 19°CWB Outdoor ; 35°CDB / 24°CWB	Indoor ; 20°CDB Outdoor ; 7°CDB / 6°CWB	5 m

Conversion Formulae
kcal/h = kW × 860 Btu/h = kW × 3412 cfm = m³/min × 35.3

50 Hz, 230 V

Model	Indoor Unit		ATX20JV1B		ATX25JV1B	
	Outdoor Unit		ARX20JV1B		ARX25JV1B	
			Cooling	Heating	Cooling	Heating
Capacity Rated (Min. ~ Max.)	kW		2.0 (1.3 ~ 2.6)	2.5 (1.3 ~ 3.5)	2.5 (1.3 ~ 3.0)	2.8 (1.3 ~ 4.0)
	Btu/h		6,800 (4,400 ~ 8,900)	8,500 (4,400 ~ 11,600)	8,500 (4,400 ~ 10,200)	9,600 (4,400 ~ 13,600)
	kcal/h		1,720 (1,120 ~ 2,240)	2,150 (1,120 ~ 3,010)	2,150 (1,120 ~ 2,580)	2,410 (1,120 ~ 3,440)
Running Current (Rated)	A		2.7	3.0	3.7	3.2
Power Consumption Rated (Min. ~ Max.)	W		550 (310 ~ 720)	590 (250 ~ 950)	730 (310 ~ 1,050)	690 (250 ~ 1,110)
Power Factor (Rated)	%		88.6	91.6	85.8	93.8
COP Rated (Min. ~ Max.)	W/W		3.64 (4.19 ~ 3.61)	4.24 (5.20 ~ 3.68)	3.42 (4.19 ~ 2.86)	4.06 (5.20 ~ 3.60)
Piping Connections	Liquid	mm	φ 6.4		φ 6.4	
	Gas	mm	φ 9.5		φ 9.5	
	Drain	mm	φ 18.0		φ 18.0	
Heat Insulation			Both Liquid and Gas Pipes		Both Liquid and Gas Pipes	
Max. Interunit Piping Length	m		15		15	
Max. Interunit Height Difference	m		12		12	
Chargeless	m		10		10	
Amount of Additional Charge of Refrigerant	g/m		20		20	
Indoor Unit			ATX20JV1B		ATX25JV1B	
Front Panel Color			White		White	
Airflow Rate	H	m³/min (cfm)	9.1 (321)	9.4 (331)	9.2 (325)	9.7 (342)
	M		7.4 (261)	7.8 (276)	7.6 (268)	8.0 (283)
	L		5.9 (208)	6.3 (222)	6.0 (212)	6.3 (222)
	SL		4.7 (166)	5.5 (194)	4.8 (169)	5.5 (194)
Fan	Type		Cross Flow Fan		Cross Flow Fan	
	Motor Output	W	16		16	
	Speed	Steps	5 Steps, Quiet, Auto		5 Steps, Quiet, Auto	
Air Direction Control			Right, Left, Horizontal, Downward		Right, Left, Horizontal, Downward	
Air Filter			Removable / Washable / Mildew Proof		Removable / Washable / Mildew Proof	
Running Current (Rated)	A		0.18	0.18	0.18	0.18
Power Consumption (Rated)	W		40	40	40	40
Power Factor	%		96.6	96.6	96.6	96.6
Temperature Control			Microcomputer Control		Microcomputer Control	
Dimensions (H x W x D)	mm		283 x 770 x 198		283 x 770 x 198	
Packaged Dimensions (H x W x D)	mm		263 x 840 x 344		263 x 840 x 344	
Weight (Mass)	kg		7		7	
Gross Weight (Gross Mass)	kg		11		11	
Sound Pressure Level	H / M / L / SL	dB(A)	39 / 33 / 25 / 22	39 / 34 / 28 / 25	40 / 33 / 26 / 22	40 / 34 / 28 / 25
	Sound Power Level		dB	55	55	56
Outdoor Unit			ARX20JV1B		ARX25JV1B	
Casing Color			Ivory White		Ivory White	
Compressor	Type		Hermetically Sealed Swing Type		Hermetically Sealed Swing Type	
	Model		1YC23AEXD		1YC23AEXD	
	Motor Output	W	750		750	
Refrigerant Oil	Type		FVC50K		FVC50K	
	Charge	L	0.375		0.375	
Refrigerant	Type		R-410A		R-410A	
	Charge	kg	0.74		0.74	
Airflow Rate	H	m³/min (cfm)	29.2 (1,030)	26.2 (927)	29.2 (1,030)	26.2 (927)
	Fan		Type	Propeller		Propeller
	Motor Output	W	33		33	
Running Current (Rated)	A		2.52	2.62	3.52	3.02
Power Consumption (Rated)	W		510	550	690	650
Power Factor	%		88.0	91.3	85.2	93.6
Starting Current	A		2.7		3.7	
Dimensions (H x W x D)	mm		550 x 658 x 275		550 x 658 x 275	
Packaged Dimensions (H x W x D)	mm		616 x 788 x 359		616 x 788 x 359	
Weight (Mass)	kg		28		28	
Gross Weight (Gross Mass)	kg		31		31	
Sound Pressure Level (H)	dB(A)		46	47	46	47
Sound Power Level (H)	dB		60	61	60	61
Drawing No.			3D065933		3D065934	

Note: ■ The data are based on the conditions shown in the table below.

Cooling	Heating	Piping Length
Indoor ; 27°CDB / 19°CWB Outdoor ; 35°CDB / 24°CWB	Indoor ; 20°CDB Outdoor ; 7°CDB / 6°CWB	5 m

Conversion Formulae
kcal/h = kW × 860 Btu/h = kW × 3412 cfm = m³/min × 35.3

50 Hz, 230 V

Model	Indoor Unit		ATX35JV1B	
	Outdoor Unit		ARX35JV1B	
			Cooling	Heating
Capacity Rated (Min. ~ Max.)	kW		3.3 (1.3 ~ 3.8)	3.5 (1.3 ~ 4.8)
	Btu/h		11,300 (4,400 ~ 13,000)	11,900 (4,400 ~ 16,400)
	kcal/h		2,840 (1,120 ~ 3,270)	3,010 (1,120 ~ 4,130)
Running Current (Rated)	A		5.2	4.7
Power Consumption Rated (Min. ~ Max.)	W		980 (290 ~ 1,300)	930 (290 ~ 1,290)
Power Factor	%		81.9	86.0
COP Rated (Min. ~ Max.)	W/W		3.37 (4.48 ~ 2.92)	3.76 (4.48 ~ 3.72)
Piping Connections	Liquid	mm	φ 6.4	
	Gas	mm	φ 9.5	
	Drain	mm	φ 18.0	
Heat Insulation	Both Liquid and Gas Pipes			
Max. Interunit Piping Length	m		15	
Max. Interunit Height Difference	m		12	
Chargeless	m		10	
Amount of Additional Charge of Refrigerant	g/m		20	
Indoor Unit			ATX35JV1B	
Front Panel Color			White	
Airflow Rate	H	m³/min (cfm)	9.3 (328)	10.1 (356)
	M		7.7 (272)	8.4 (295)
	L		6.1 (215)	6.7 (235)
	SL		4.9 (173)	5.7 (201)
Fan	Type		Cross Flow Fan	
	Motor Output	W	16	
	Speed	Steps	5 Steps, Quiet, Auto	
Air Direction Control			Right, Left, Horizontal, Downward	
Air Filter			Removable / Washable / Mildew Proof	
Running Current (Rated)	A		0.18	0.18
Power Consumption (Rated)	W		40	40
Power Factor	%		96.6	96.6
Temperature Control			Microcomputer Control	
Dimensions (H x W x D)	mm		283 x 770 x 198	
Packaged Dimensions (H x W x D)	mm		263 x 840 x 344	
Weight (Mass)	kg		7	
Gross Weight (Gross Mass)	kg		11	
Sound Pressure Level	H / M / L / SL	dB(A)	41 / 34 / 27 / 23	41 / 35 / 29 / 26
Sound Power Level		dB	57	57
Outdoor Unit			ARX35JV1B	
Casing Color			Ivory White	
Compressor	Type		Hermetically Sealed Swing Type	
	Model		1YC23AEXD	
	Motor Output	W	750	
Refrigerant Oil	Type		FVC50K	
	Charge	L	0.375	
Refrigerant	Type		R-410A	
	Charge	kg	1.0	
Airflow Rate	H	m³/min (cfm)	27.6 (975)	24.5 (865)
Fan	Type		Propeller	
	Motor Output	W	33	
Running Current (Rated)	A		5.02	4.52
Power Consumption (Rated)	W		940	890
Power Factor	%		86.0	85.6
Starting Current	A		5.0	
Dimensions (H x W x D)	mm		550 x 658 x 275	
Packaged Dimensions (H x W x D)	mm		616 x 788 x 359	
Weight (Mass)	kg		30	
Gross Weight (Gross Mass)	kg		34	
Sound Pressure Level (H)		dB(A)	48	48
Sound Power Level (H)		dB	62	62
Drawing No.			3D065935	

Note: ■ The data are based on the conditions shown in the table below.

Cooling	Heating	Piping Length
Indoor ; 27°CDB / 19°CWB Outdoor ; 35°CDB / 24°CWB	Indoor ; 20°CDB Outdoor ; 7°CDB / 6°CWB	5 m

Conversion Formulae
kcal/h = kW × 860 Btu/h = kW × 3412 cfm = m³/min × 35.3

50 Hz, 230 V

Model	Indoor Unit		ATX20J2V1B		ATX25J2V1B	
	Outdoor Unit		ARX20J3V1B		ARX25J3V1B	
			Cooling	Heating	Cooling	Heating
Capacity Rated (Min. ~ Max.)	kW		2.0 (1.3 ~ 2.6)	2.5 (1.3 ~ 3.5)	2.5 (1.3 ~ 3.0)	2.8 (1.3 ~ 4.0)
	Btu/h		6,800 (4,400 ~ 8,900)	8,500 (4,400 ~ 11,900)	8,500 (4,400 ~ 10,200)	9,600 (4,400 ~ 13,600)
	kcal/h		1,720 (1,120 ~ 2,240)	2,150 (1,120 ~ 3,010)	2,150 (1,120 ~ 2,580)	2,410 (1,120 ~ 3,440)
Running Current (Rated)	A		2.7	3.0	3.7	3.2
Power Consumption Rated (Min. ~ Max.)	W		550 (310 ~ 720)	590 (250 ~ 950)	730 (310 ~ 1,050)	690 (250 ~ 1,110)
Power Factor (Rated)	%		88.6	85.5	85.8	93.8
COP Rated (Min. ~ Max.)	W/W		3.64 (4.19 ~ 3.61)	4.24 (5.20 ~ 3.68)	3.42 (4.19 ~ 2.86)	4.06 (5.20 ~ 3.60)
Piping Connections	Liquid	mm	φ 6.4		φ 6.4	
	Gas	mm	φ 9.5		φ 9.5	
	Drain	mm	φ 18.0		φ 18.0	
Heat Insulation			Both Liquid and Gas Pipes		Both Liquid and Gas Pipes	
Max. Interunit Piping Length	m		15		15	
Max. Interunit Height Difference	m		12		12	
Chargeless	m		10		10	
Amount of Additional Charge of Refrigerant	g/m		20		20	
Indoor Unit			ATX20J2V1B		ATX25J2V1B	
Front Panel Color			White		White	
Airflow Rate	H	m ³ /min (cfm)	9.1 (321)	9.4 (331)	9.2 (325)	9.7 (342)
	M		7.4 (261)	7.8 (276)	7.6 (268)	8.0 (283)
	L		5.9 (208)	6.3 (222)	6.0 (212)	6.3 (222)
	SL		4.7 (166)	5.5 (194)	4.8 (169)	5.5 (194)
Fan	Type		Cross Flow Fan		Cross Flow Fan	
	Motor Output	W	16		16	
	Speed	Steps	5 Steps, Quiet, Auto		5 Steps, Quiet, Auto	
Air Direction Control			Right, Left, Horizontal, Downward		Right, Left, Horizontal, Downward	
Air Filter			Removable / Washable / Mildew Proof		Removable / Washable / Mildew Proof	
Running Current (Rated)	A		0.18	0.18	0.18	0.18
Power Consumption (Rated)	W		40	40	40	40
Power Factor	%		96.6	96.6	96.6	96.6
Temperature Control			Microcomputer Control		Microcomputer Control	
Dimensions (H x W x D)	mm		283 x 770 x 198		283 x 770 x 198	
Packaged Dimensions (H x W x D)	mm		266 x 846 x 345		266 x 846 x 345	
Weight (Mass)	kg		7		7	
Gross Weight (Gross Mass)	kg		11		11	
Sound Pressure Level	H / M / L / SL	dB(A)	39 / 33 / 25 / 22	39 / 34 / 28 / 25	40 / 33 / 26 / 22	40 / 34 / 28 / 25
Sound Power Level		dB	55	55	55	55
Outdoor Unit			ARX20J3V1B		ARX25J3V1B	
Casing Color			Ivory White		Ivory White	
Compressor	Type		Hermetically Sealed Swing Type		Hermetically Sealed Swing Type	
	Model		1YC23AEXD		1YC23AEXD	
	Motor Output	W	750		750	
Refrigerant Oil	Type		FVC50K		FVC50K	
	Charge	L	0.375		0.375	
Refrigerant	Type		R-410A		R-410A	
	Charge	kg	0.74		0.74	
Airflow Rate	H	m ³ /min (cfm)	29.2 (1,030)	26.2 (927)	29.2 (1,030)	26.2 (927)
Fan	Type		Propeller		Propeller	
	Motor Output	W	33		33	
Running Current (Rated)	A		2.52	2.82	3.52	3.02
Power Consumption (Rated)	W		510	550	690	650
Power Factor	%		88.0	84.8	85.2	93.6
Starting Current	A		3.0		3.7	
Dimensions (H x W x D)	mm		550 x 658 x 275		550 x 658 x 275	
Packaged Dimensions (H x W x D)	mm		612 x 769 x 350		612 x 769 x 350	
Weight (Mass)	kg		28		28	
Gross Weight (Gross Mass)	kg		31		31	
Sound Pressure Level (H)		dB(A)	46	47	46	47
Sound Power Level (H)		dB	60	61	60	61
Drawing No.			C: 3D080717		C: 3D080718	

Note: ■ The data are based on the conditions shown in the table below.

Cooling	Heating	Piping Length
Indoor ; 27°CDB / 19°CWB Outdoor ; 35°CDB / 24°CWB	Indoor ; 20°CDB Outdoor ; 7°CDB / 6°CWB	5 m

Conversion Formulae
kcal/h = kW × 860 Btu/h = kW × 3412 cfm = m ³ /min × 35.3

50 Hz, 230 V

Model	Indoor Unit		ATX35J2V1B	
	Outdoor Unit		ARX35J3V1B	
			Cooling	Heating
Capacity Rated (Min. ~ Max.)	kW		3.3 (1.3 ~ 3.8)	3.5 (1.3 ~ 4.8)
	Btu/h		11,300 (4,400 ~ 13,000)	11,900 (4,400 ~ 16,400)
	kcal/h		2,840 (1,120 ~ 3,270)	3,010 (1,120 ~ 4,130)
Running Current (Rated)	A		5.2	4.7
Power Consumption Rated (Min. ~ Max.)	W		980 (290 ~ 1,300)	930 (290 ~ 1,290)
Power Factor	%		81.9	86.0
COP Rated (Min. ~ Max.)	W/W		3.37 (4.48 ~ 2.92)	3.76 (4.48 ~ 3.72)
Piping Connections	Liquid	mm	φ 6.4	
	Gas	mm	φ 9.5	
	Drain	mm	φ 18.0	
Heat Insulation	Both Liquid and Gas Pipes			
Max. Interunit Piping Length	m		15	
Max. Interunit Height Difference	m		12	
Chargeless	m		10	
Amount of Additional Charge of Refrigerant	g/m		20	
Indoor Unit			ATX35J2V1B	
Front Panel Color			White	
Airflow Rate	H	m ³ /min (cfm)	9.3 (328)	10.1 (356)
	M		7.7 (272)	8.4 (295)
	L		6.1 (215)	6.7 (235)
	SL		4.9 (173)	5.7 (201)
Fan	Type		Cross Flow Fan	
	Motor Output	W	16	
	Speed	Steps	5 Steps, Quiet, Auto	
Air Direction Control			Right, Left, Horizontal, Downward	
Air Filter			Removable / Washable / Mildew Proof	
Running Current (Rated)	A		0.18	0.18
Power Consumption (Rated)	W		40	40
Power Factor	%		96.6	96.6
Temperature Control			Microcomputer Control	
Dimensions (H x W x D)	mm		283 x 770 x 198	
Packaged Dimensions (H x W x D)	mm		266 x 846 x 345	
Weight (Mass)	kg		7	
Gross Weight (Gross Mass)	kg		11	
Sound Pressure Level	H / M / L / SL	dB(A)	41 / 34 / 27 / 23	41 / 35 / 29 / 26
Sound Power Level		dB	58	58
Outdoor Unit			ARX35J3V1B	
Casing Color			Ivory White	
Compressor	Type		Hermetically Sealed Swing Type	
	Model		1YC23AEXD	
	Motor Output	W	750	
Refrigerant Oil	Type		FVC50K	
	Charge	L	0.375	
Refrigerant	Type		R-410A	
	Charge	kg	1.0	
Airflow Rate	H	m ³ /min (cfm)	27.6 (975)	24.5 (865)
Fan	Type		Propeller	
	Motor Output	W	33	
Running Current (Rated)	A		5.02	4.52
Power Consumption (Rated)	W		940	890
Power Factor	%		81.4	85.6
Starting Current	A		5.2	
Dimensions (H x W x D)	mm		550 x 658 x 275	
Packaged Dimensions (H x W x D)	mm		612 x 769 x 350	
Weight (Mass)	kg		30	
Gross Weight (Gross Mass)	kg		34	
Sound Pressure Level (H)		dB(A)	48	48
Sound Power Level (H)		dB	62	62
Drawing No.			C: 3D080719	

Note: ■ The data are based on the conditions shown in the table below.

Cooling	Heating	Piping Length
Indoor ; 27°CDB / 19°CWB Outdoor ; 35°CDB / 24°CWB	Indoor ; 20°CDB Outdoor ; 7°CDB / 6°CWB	5 m

Conversion Formulae
kcal/h = kW × 860 Btu/h = kW × 3412 cfm = m ³ /min × 35.3

Part 3 Printed Circuit Board Connector Wiring Diagram

1. Indoor Unit.....	14
2. Outdoor Unit.....	16

1. Indoor Unit

Control PCB

- | | |
|-------------------|--|
| 1) S6 | Connector for swing motor (horizontal blade) |
| 2) S26 | Connector for display PCB |
| 3) S32 | Connector for indoor heat exchanger thermistor |
| 4) S200 | Connector for fan motor |
| 5) S403 | Connector for adaptor PCB (option) |
| 6) H1, H2, H3, FG | Connector for terminal board |
| 7) V1 | Varistor |
| 8) JA | Address setting jumper |
| | * Refer to page 97 for detail. |
| 9) JB | Fan speed setting when compressor stops for thermostat OFF |
| JC | Power failure recovery function (auto-restart) |
| | * Refer to page 97 for detail. |
| 10) LED A | LED for service monitor (green) |
| 11) FU1 (F1U) | Fuse (3.15 A, 250 V) |

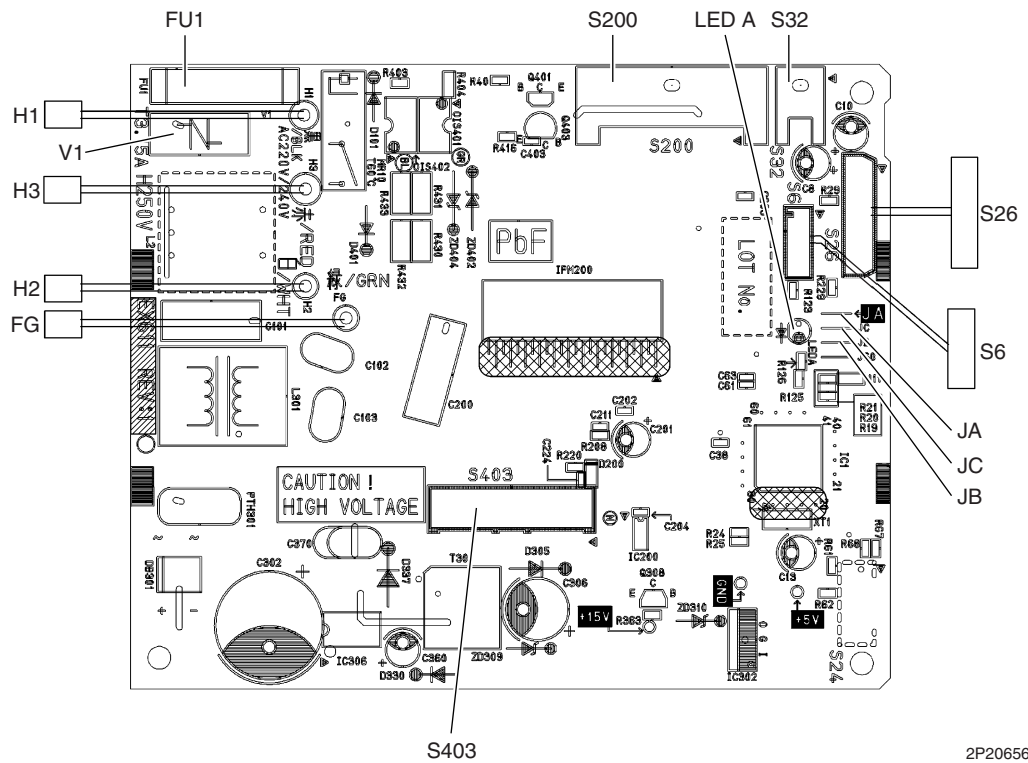

2P206569-1



Caution

Replace the PCB if you accidentally cut the jumpers other than JA, JB and JC.

Jumpers are necessary for electronic circuit. Improper operation may occur if you cut any of them.

Display PCB

- | | |
|---------------|--|
| 1) S27 | Connector for control PCB |
| 2) SW1 (S1W) | Forced cooling operation [ON/OFF] button
* Refer to page 95 for detail. |
| 3) LED1 (H1P) | LED for operation (green) |
| 4) LED2 (H2P) | LED for timer (yellow) |
| 5) RTH1 (R1T) | Room temperature thermistor |

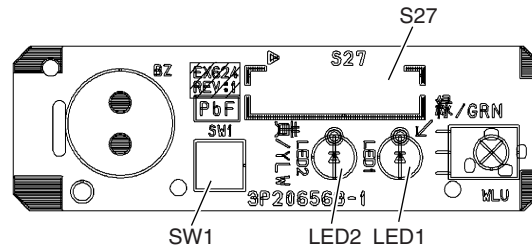

(Solder side)

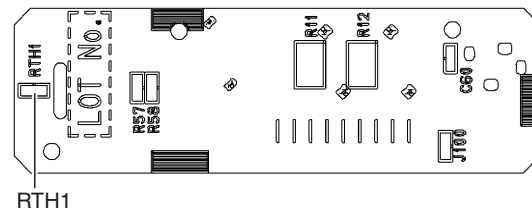

3P206563-1

2. Outdoor Unit

Main PCB

- | | |
|--------------|--|
| 1) S10 | Connector for filter PCB |
| 2) S20 | Connector for electronic expansion valve coil |
| 3) S40 | Connector for overload protector |
| 4) S70 | Connector for fan motor |
| 5) S80 | Connector for four way valve coil |
| 6) S90 | Connector for thermistors
(outdoor temperature, outdoor heat exchanger, discharge pipe) |
| 7) HL3, HN3 | Connector for filter PCB |
| 8) HR2 | Connector for reactor |
| 9) U, V, W | Connector for compressor |
| 10) FU1, FU2 | Fuse (3.15 A, 250 V) |
| 11) LED A | LED for service monitor (green) |
| 12) V1 | Varistor |
| 13) J5 | Jumper for improvement of defrost performance |
- * Refer to page 97 for detail.

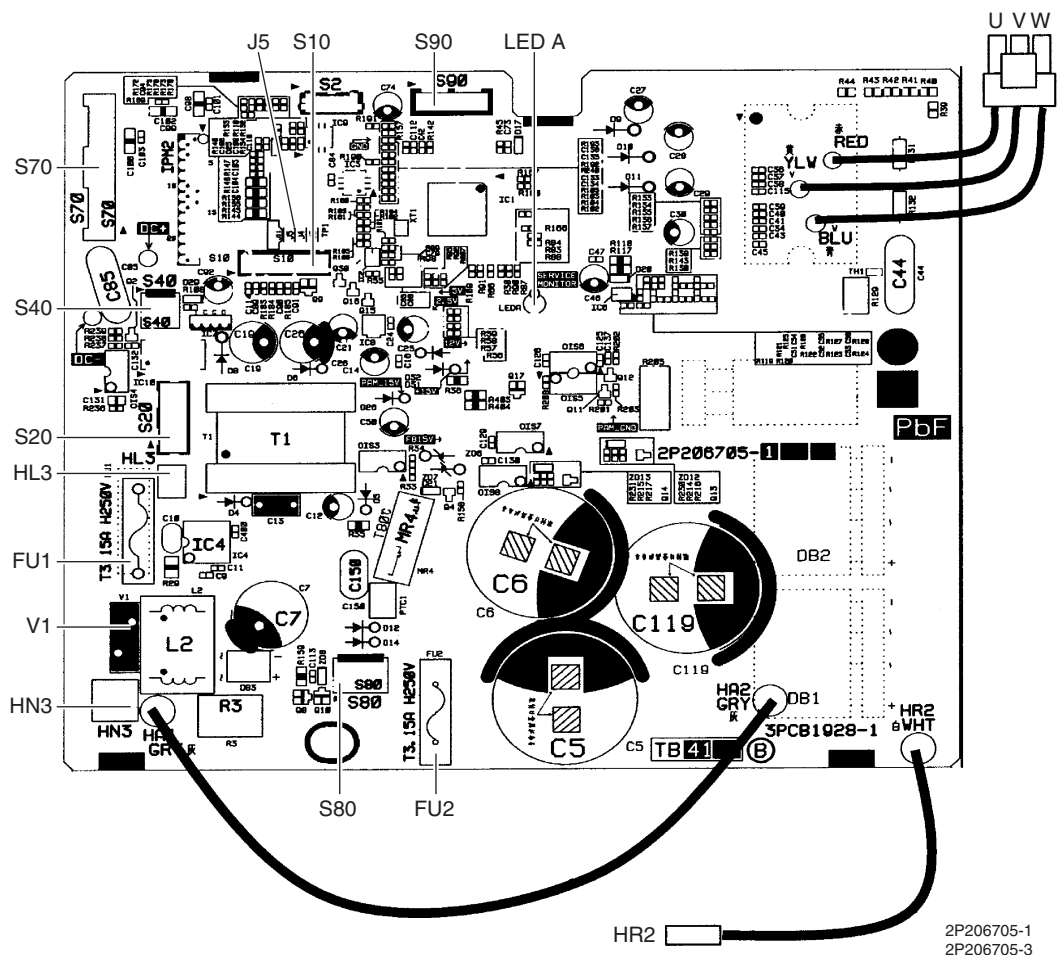

Caution Replace the PCB if you accidentally cut any jumper other than J5.

Jumpers are necessary for electronic circuit. Improper operation may occur if you cut any of them.

Filter PCB

- | | |
|----------------|------------------------------|
| 1) S11 | Connector for main PCB |
| 2) AC1, AC2, S | Connector for terminal board |
| 3) E1, E2 | Terminal for earth wire |
| 4) HL2, HN2 | Connector for main PCB |
| 5) HR1 | Connector for reactor |
| 6) FU3 | Fuse (20 A, 250 V) |
| 7) V2, V3 | Varistor |

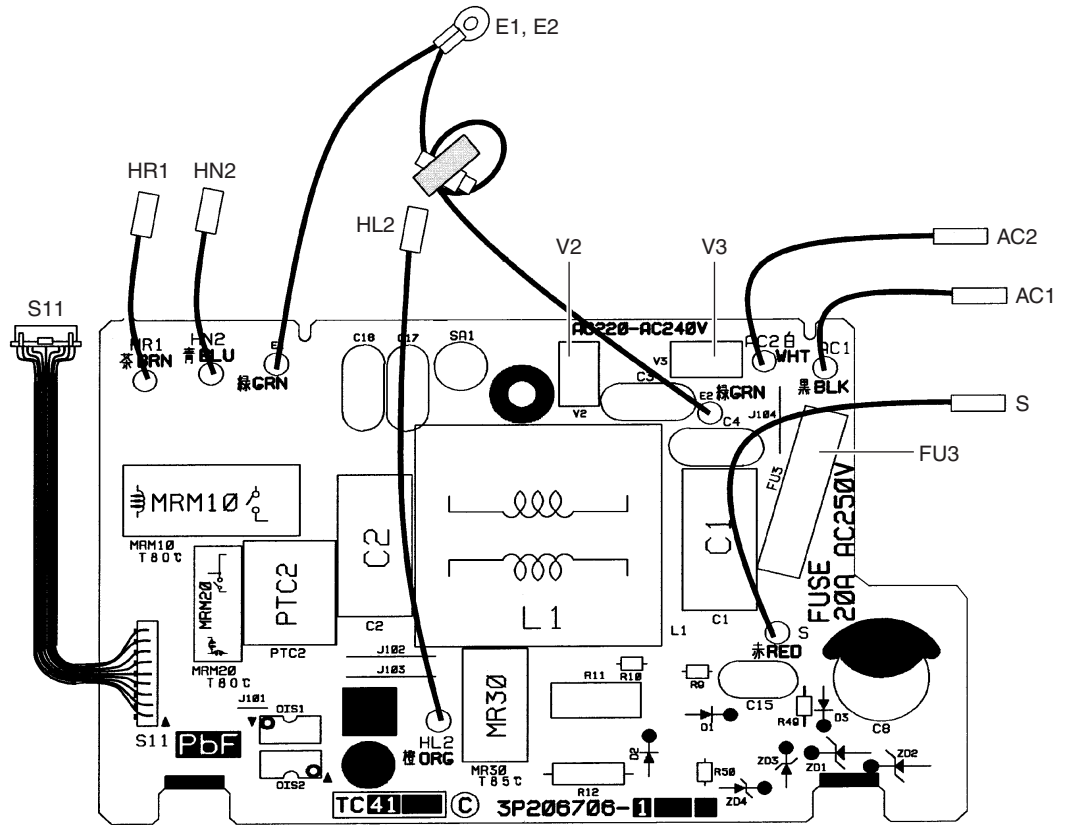

3P206706-1

Part 4

Function and Control

1. Main Functions.....	19
1.1 Temperature Control	19
1.2 Frequency Principle.....	19
1.3 Airflow Direction Control.....	21
1.4 Fan Speed Control for Indoor Unit	22
1.5 Program Dry Operation	23
1.6 Automatic Operation.....	24
1.7 Thermostat Control.....	25
1.8 NIGHT SET Mode	26
1.9 ECONO Operation	26
1.10 Inverter POWERFUL Operation	27
1.11 Clock Setting	27
1.12 Other Functions.....	28
2. Function of Thermistor	29
3. Control Specification	30
3.1 Mode Hierarchy	30
3.2 Frequency Control.....	30
3.3 Controls at Mode Changing / Start-up.....	32
3.4 Discharge Pipe Temperature Control.....	33
3.5 Input Current Control.....	34
3.6 Freeze-up Protection Control	35
3.7 Heating Peak-cut Control	35
3.8 Outdoor Fan Control.....	36
3.9 Liquid Compression Protection Function.....	36
3.10 Defrost Control	37
3.11 Electronic Expansion Valve Control	38
3.12 Malfunctions	41

1. Main Functions

1.1 Temperature Control

Definitions of Temperatures

The definitions of temperatures are classified as following.

- ◆ Room temperature: temperature of lower part of the room
- ◆ Set temperature: temperature set by remote controller
- ◆ Room thermistor temperature: temperature detected by room temperature thermistor
- ◆ Target temperature: temperature determined by microcomputer

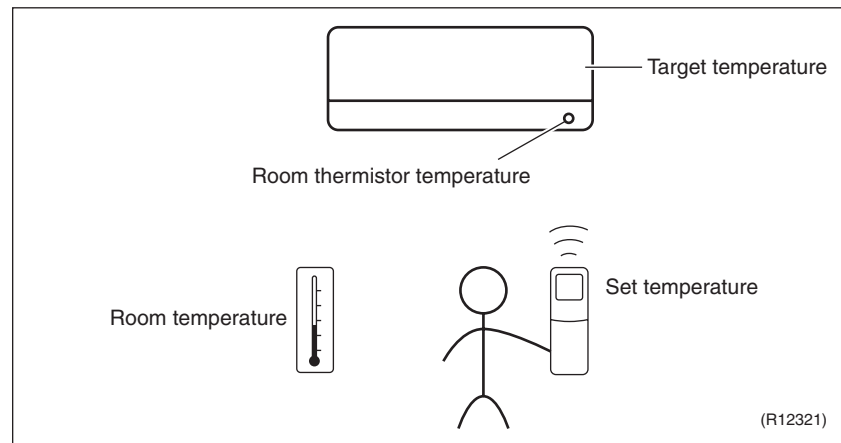

Temperature Control

The temperature of the room is detected by the room temperature thermistor. However, there is a difference between the “temperature detected by room temperature thermistor” and the “temperature of lower part of the room”, depending on the type of the indoor unit or installation condition. Practically, the temperature control is done by the “target temperature appropriately adjusted for the indoor unit” and the “temperature detected by room temperature thermistor”.

1.2 Frequency Principle

Main Control Parameters

The frequency of the compressor is controlled by the following 2 parameters:

- The load condition of the operating indoor unit
- The difference between the room thermistor temperature and the target temperature

Additional Control Parameters

The target frequency is adapted by additional parameters in the following cases:

- Frequency restrictions
- Initial settings
- Forced cooling operation

Inverter Principle

To regulate the capacity, a frequency control is needed. The inverter makes it possible to alter the rotation speed of the compressor. The following table explains the conversion principle:

Phase	Description
1	The supplied AC power source is converted into the DC power source for the present.
2	The DC power source is reconverted into the three phase AC power source with variable frequency. <ul style="list-style-type: none"> ■ When the frequency increases, the rotation speed of the compressor increases resulting in an increased refrigerant circulation. This leads to a higher amount of the heat exchange per unit. ■ When the frequency decreases, the rotation speed of the compressor decreases resulting in a decreased refrigerant circulation. This leads to a lower amount of the heat exchange per unit.

Drawing of Inverter

The following drawing shows a schematic view of the inverter principle:

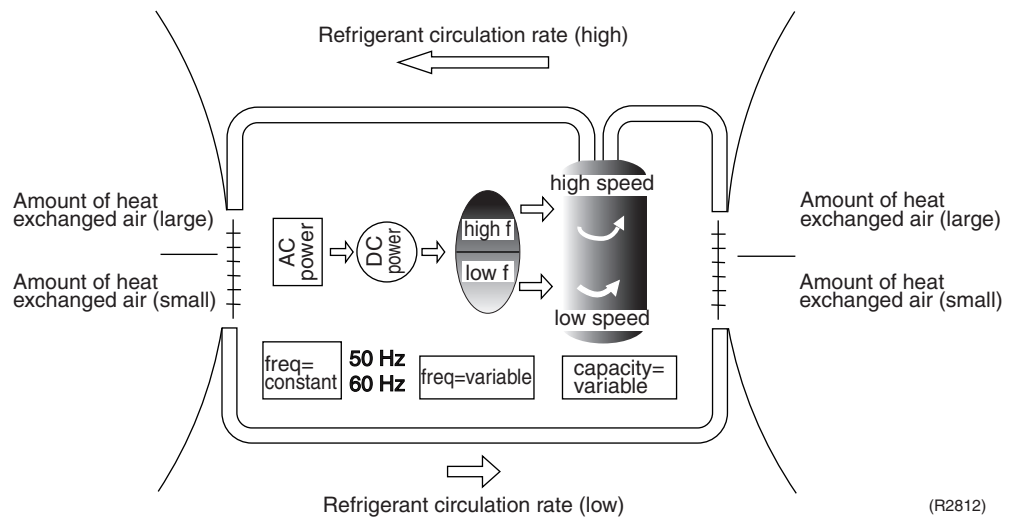

Inverter Features

The inverter provides the following features:

- The regulating capacity can be changed according to the changes in the outdoor temperature and cooling / heating load.
- Quick heating and quick cooling
The rotation speed of the compressor is increased when starting the heating (or cooling). This enables to reach the set temperature quickly.
- Even during extreme cold weather, high capacity is achieved. It is maintained even when the outdoor temperature is 2°C.
- Comfortable air conditioning
A fine adjustment is integrated to keep the room temperature constant.
- Energy saving heating and cooling
Once the set temperature is reached, the energy saving operation enables to maintain the room temperature at low power.

Frequency Limits

The following functions regulate the minimum and maximum frequency:

Frequency	Functions
Low	<ul style="list-style-type: none"> ■ Four way valve operation compensation. Refer to page 32.
High	<ul style="list-style-type: none"> ■ Compressor protection function. Refer to page 33. ■ Discharge pipe temperature control. Refer to page 33. ■ Input current control. Refer to page 34. ■ Freeze-up protection control. Refer to page 35. ■ Heating peak-cut control. Refer to page 35. ■ Defrost control. Refer to page 37.

Forced Cooling Operation

Refer to page 95 for detail.

1.3 Airflow Direction Control

Power-Airflow Flap

The large flap sends a large volume of air downward to the floor and provides an optimum control in cooling, dry, and heating operation.

<Cooling / Dry>

During cooling or dry operation, the flap retracts into the indoor unit. Then, cool air can be blown far and distributed all over the room.

<Heating>

During heating operation, the large flap directs airflow downward to spread the warm air to the entire room.

Wide-Angle Louvers

The louvers, made of elastic synthetic resin, provide a wide range of airflow that guarantees comfortable air distribution.

Auto-Swing

The following table explains the auto-swing process for cooling, dry, fan, and heating:

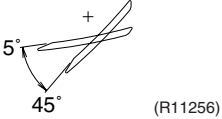
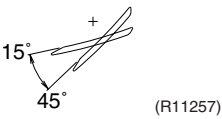
Vertical Swing (up and down)	
Cooling / Dry / Fan	Heating
	

COMFORT AIRFLOW Operation

The vertical swing flap is controlled not to blow the air directly at the people in the room.

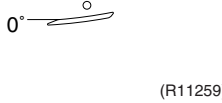
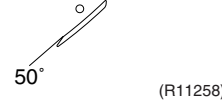
Cooling / Dry	Heating
	

1.4 Fan Speed Control for Indoor Unit

Outline



Phase control and fan speed control contains 9 steps: LLL, LL, SL, L, ML, M, MH, H, and HH. The airflow rate can be automatically controlled depending on the difference between the room thermistor temperature and the target temperature. This is done through phase control and Hall IC control.



For more information about Hall IC, refer to the troubleshooting for fan motor on page 54.

Automatic Fan Speed Control

In automatic fan speed operation, the step "SL" is not available.

Step	Cooling	Heating
LLL	 (R11681)	 (R6834)
LL		
L		
ML		
M		
MH		
H		
HH (POWERFUL)		

 = The airflow rate is automatically controlled within this range when the [FAN] setting button is set to automatic.

<Cooling>

The following drawing explains the principle of fan speed control for cooling.

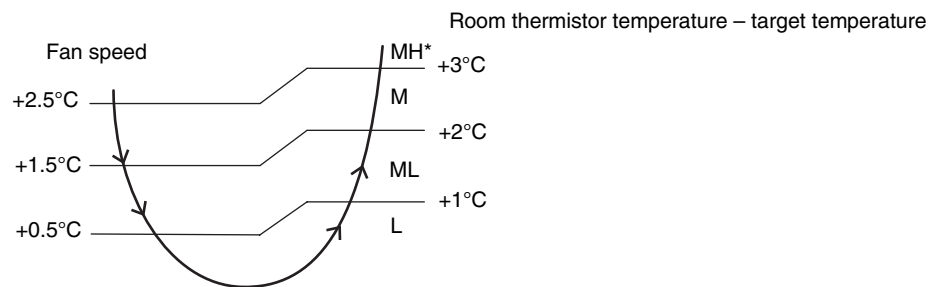

(R14588)

*The upper limit is M tap in 30 minutes from the operation start.

<Heating>

In heating operation, the fan speed is regulated according to the indoor heat exchanger temperature and the difference between the room thermistor temperature and the target temperature.



Note:

1. During POWERFUL operation, the fan rotates at H tap + 80 rpm.
2. The fan stops during defrost control.

COMFORT AIRFLOW Operation

- The fan speed is controlled automatically.
- The latest command has the priority between POWERFUL and COMFORT AIRFLOW.

1.5 Program Dry Operation

Outline

Program dry operation removes humidity while preventing the room temperature from lowering. Since the microcomputer controls both the temperature and airflow rate, the temperature adjustment and [FAN] setting buttons are inoperable.

Detail

The microcomputer automatically sets the temperature and airflow rate. The difference between the room thermistor temperature at start-up and the target temperature is divided into two zones. Then, the unit operates in an appropriate capacity for each zone to maintain the temperature and humidity at a comfortable level.

Room thermistor temperature at start-up	Target temperature X	Thermostat OFF point Y	Thermostat ON point Z
24°C or more	Room thermistor temperature at start-up	X - 2.5°C	X - 0.5°C or Y + 0.5°C (zone B) continues for 10 min.
23.5°C ⋮ 18°C		X - 2.0°C	X - 0.5°C or Y + 0.5°C (zone B) continues for 10 min.
17.5°C ⋮	18°C	X - 2.0°C	X - 0.5°C = 17.5°C or Y + 0.5°C (zone B) continues for 10 min.

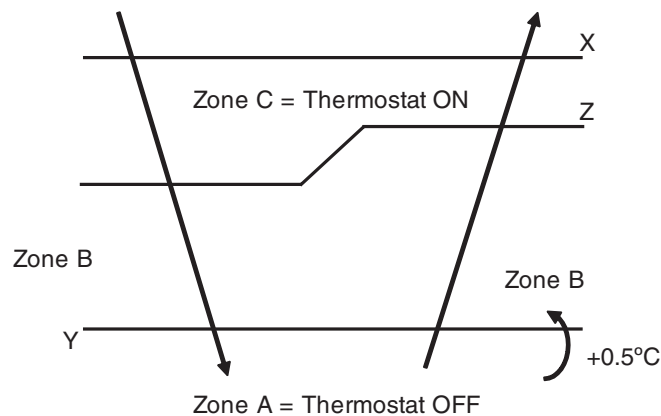

(R11581)

1.6 Automatic Operation

Outline

Automatic Cooling / Heating Function

When the automatic operation is selected with the remote controller, the microcomputer automatically determines the operation mode as cooling or heating according to the room temperature and the set temperature at start-up.

The unit automatically switches the operation mode to maintain the room temperature at the set temperature.

Detail

Ts: set temperature (set by remote controller)

Tt: target temperature (determined by microcomputer)

Tr: room thermistor temperature (detected by room temperature thermistor)

C: correction value

- The set temperature determines the target temperature.
Ts = 18 ~ 30°C
- The target temperature is calculated as;
Tt = Ts + C
where C = 0°C
- The thermostat ON/OFF point and operation mode switching point are as follows.
 - Heating → Cooling switching point:
Tr ≥ Tt + 2.5°C
 - Cooling → Heating switching point:
Tr < Tt - 2.5°C
 - The thermostat ON/OFF point is the same as the ON/OFF point of cooling or heating operation.
- During initial operation
Tr ≥ Ts : Cooling operation
Tr < Ts : Heating operation

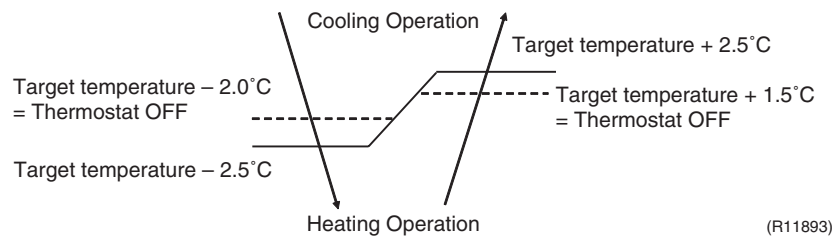

Ex: When the target temperature is 25°C

Cooling → 23°C: Thermostat OFF → 22°C: Switch to heating

Heating → 26.5°C: Thermostat OFF → 27.5°C: Switch to cooling

1.7 Thermostat Control

Outline Thermostat control is based on the difference between the room thermistor temperature and the target temperature.

Detail

Thermostat OFF Condition

- ◆ The temperature difference is in the zone A.

Thermostat ON Condition

- ◆ The temperature difference returns to the zone C after being in the zone A.
- ◆ The system resumes from defrost control in any zones except A.
- ◆ The operation turns on in any zones except A.
- ◆ The monitoring time has passed while the temperature difference is in the zone B.
(Cooling / Dry: 10 minutes, Heating: 10 seconds)

<Cooling / Dry>

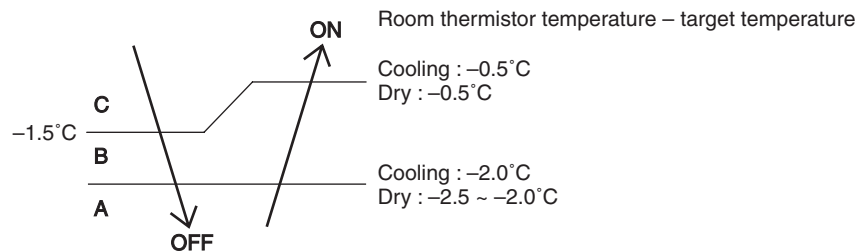

<Heating>

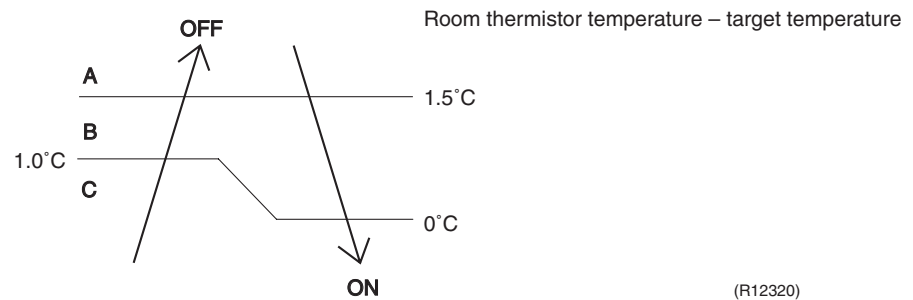

Refer to “Temperature Control” on page 19 for detail.

1.8 NIGHT SET Mode

Outline When the OFF TIMER is set, the NIGHT SET Mode is automatically activated. The NIGHT SET Mode keeps the airflow rate setting.

Detail The NIGHT SET Mode continues operation at the target temperature for the first one hour, then automatically raises the target temperature slightly in the case of cooling, or lowers it slightly in the case of heating. This prevents excessive cooling in summer and excessive heating in winter to ensure comfortable sleeping conditions, and also conserves electricity.

<Cooling>

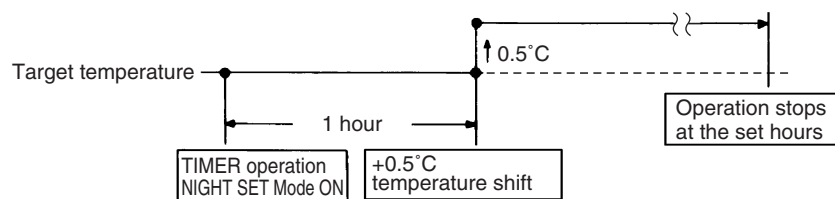

(R18917)

<Heating>

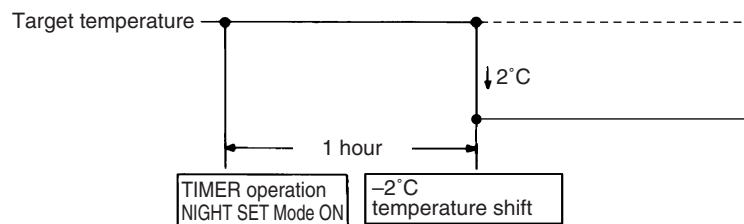

(R18985)

1.9 ECONO Operation

Outline ECONO operation reduces the maximum operating current and the power consumption. This operation is particularly convenient for energy-saving-oriented users. It is also a major bonus for those whose breaker capacities do not allow the use of multiple electrical devices and air conditioners. It is easily activated from the wireless remote controller by pushing the [ECONO] button.

Detail

- When this function is activated, the maximum capacity also decreases.
- The remote controller can send the ECONO command when the unit is in cooling, heating, dry, or automatic operation. This function can only be set when the unit is running. Pressing the [ON/OFF] button on the remote controller cancels the function.
- This function and POWERFUL operation cannot be used at the same time. The latest command has the priority.

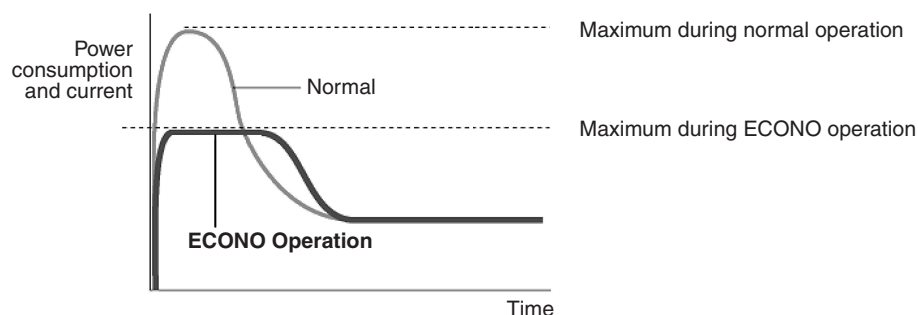

(R9288)

1.10 Inverter POWERFUL Operation

Outline

In order to exploit the cooling and heating capacity to full extent, operate the air conditioner by increasing the indoor fan rotating speed and the compressor frequency.

Detail

When the [POWERFUL] button is pressed, the fan speed and target temperature are converted to the following states for 20 minutes.

Operation mode	Fan speed	Target temperature
COOL	H tap + A rpm	18°C
DRY	Dry rotating speed + A rpm	Lowered by 2.5°C
HEAT	H tap + A rpm	31°C
FAN	H tap + A rpm	—
AUTO	Same as cooling / heating in POWERFUL operation	The target temperature is kept unchanged.

A = 80 rpm

Ex: POWERFUL operation in cooling

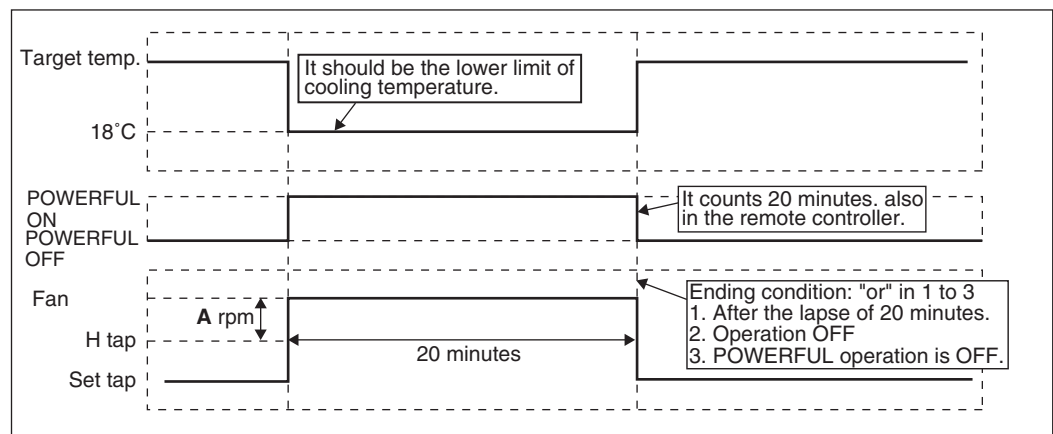

(R13571)

1.11 Clock Setting

ARC433 Series

The clock can be set by taking the following steps:

- Press the [CLOCK] button.
→ 0:00 is displayed and ☉ blinks.
- Press the [TIMER] ▲ or ▼ button to set the clock to the present time.
Holding down the [TIMER] ▲ or ▼ button increases or decreases the time display rapidly.
- Press the [CLOCK] button again.
→ : blinks and clock setting is completed.

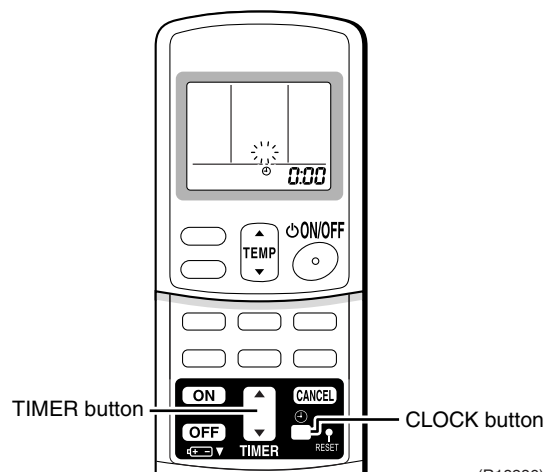

(R18286)

1.12 Other Functions

1.12.1 Hot-Start Function

In order to prevent the cold air blast that normally comes when heating operation is started, the temperature of the indoor heat exchanger is detected, and the airflow is either stopped or made very weak thereby carrying out comfortable heating of the room.

*The cold air blast is also prevented using similar control when the defrost control starts or when the thermostat is turned ON.

1.12.2 Signal Receiving Sign

When the indoor unit receives a signal from the remote controller, the unit emits a signal receiving sound.

1.12.3 Indoor Unit [ON/OFF] Button

An [ON/OFF] button is provided on the display of the unit.

- Press the [ON/OFF] button once to start operation. Press once again to stop it.
- The [ON/OFF] button is useful when the remote controller is missing or the battery has run out.
- The operation mode refers to the following table.

Operation mode	Temperature setting	Airflow rate
AUTO	25°C	Automatic

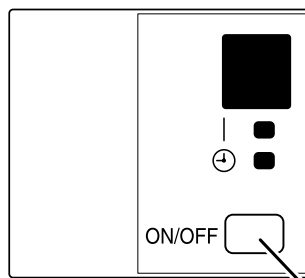

ON/OFF button

(R8435)

<Forced cooling operation>

Forced cooling operation can be started by pressing the [ON/OFF] button for 5 to 9 seconds while the unit is not operating. Refer to page 95 for detail.



Note: When the [ON/OFF] button is pressed for 10 seconds or more, the forced cooling operation is stopped.

1.12.4 Titanium Apatite Photocatalytic Air-Purifying Filter

This filter combines the Air-Purifying Filter and Titanium Apatite Photocatalytic Deodorizing Filter as a single highly effective filter. The filter traps microscopic particles, decomposes odors and even deactivates bacteria and viruses. It lasts for 3 years without replacement if washed about once every 6 months.

1.12.5 Auto-restart Function

If a power failure (including one for just a moment) occurs during the operation, the operation restarts automatically when the power is restored in the same condition as before the power failure.



Note: It takes 3 minutes to restart the operation because the 3-minute standby function is activated.

2. Function of Thermistor

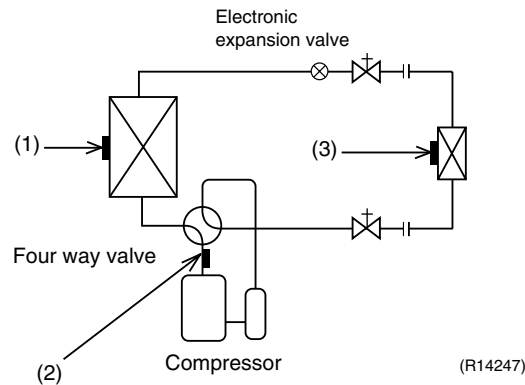

(1) Outdoor Heat Exchanger Thermistor

1. The outdoor heat exchanger thermistor is used for controlling the target discharge pipe temperature. The system sets the target discharge pipe temperature according to the outdoor and indoor heat exchanger temperature, and controls the electronic expansion valve opening so that the target discharge pipe temperature can be obtained.
2. In cooling operation, the outdoor heat exchanger thermistor is used for detecting the disconnection of the discharge pipe thermistor. When the discharge pipe temperature drops below the outdoor heat exchanger temperature by more than a certain value, the discharge pipe thermistor is judged as disconnected.
3. In cooling operation, the outdoor heat exchanger thermistor is used for high pressure protection.

(2) Discharge Pipe Thermistor

1. The discharge pipe thermistor is used for controlling discharge pipe temperature. If the discharge pipe temperature (used in place of the inner temperature of the compressor) rises abnormally, the operating frequency becomes lower or the operation halts.
2. The discharge pipe thermistor is used for detecting disconnection of the discharge pipe thermistor.

(3) Indoor Heat Exchanger Thermistor

1. The indoor heat exchanger thermistor is used for controlling the target discharge pipe temperature. The system sets the target discharge pipe temperature according to the outdoor and indoor heat exchanger temperature, and controls the electronic expansion valve opening so that the target discharge pipe temperature can be obtained.
2. In cooling operation, the indoor heat exchanger thermistor is used for freeze-up protection control. If the indoor heat exchanger temperature drops abnormally, the operating frequency becomes lower or the operation halts.
3. In heating operation, the indoor heat exchanger thermistor is used for detecting the disconnection of the discharge pipe thermistor. When the discharge pipe temperature drops below the indoor heat exchanger temperature by more than a certain value, the discharge pipe thermistor is judged as disconnected.

3. Control Specification

3.1 Mode Hierarchy

Outline

The air conditioner control has normal operation mode, forced operation mode, and power transistor test mode for installation and servicing.

Detail

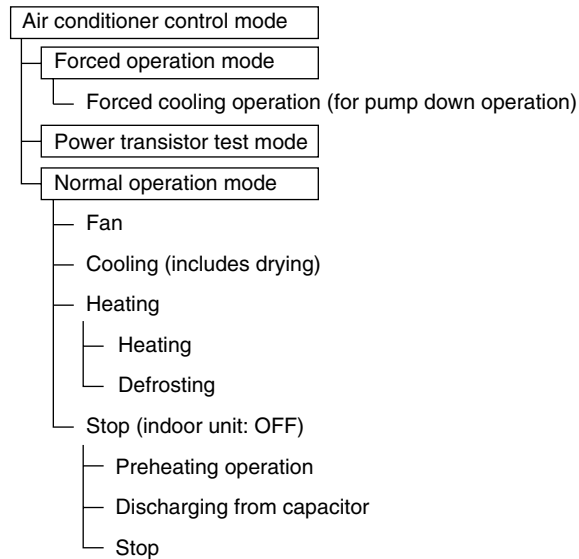

(R17533)



Note: Unless specified otherwise, a dry operation command is regarded as cooling operation.

3.2 Frequency Control

Outline

Frequency is determined according to the difference between the room thermistor temperature and the target temperature.

When the shift of the frequency is less than zero ($\Delta F < 0$) by PI control, the target frequency is used as the command frequency.

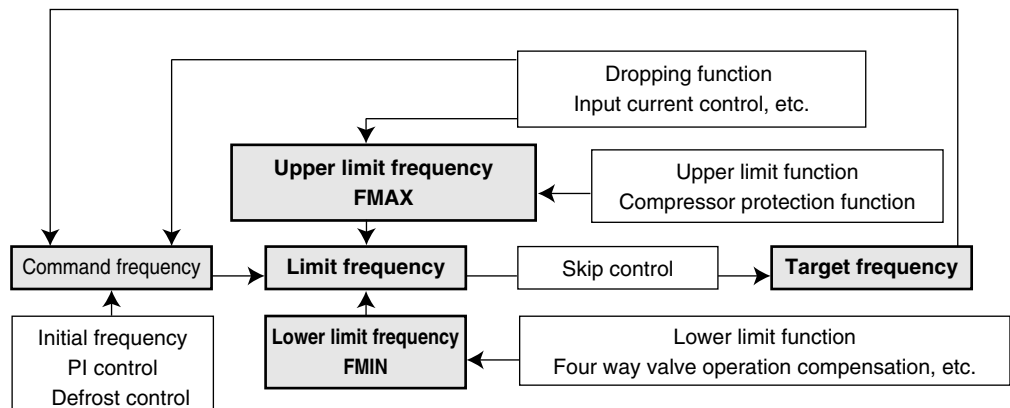

(R18023)

Detail

How to Determine Frequency

The compressor's frequency is determined by taking the following steps.

1. Determine command frequency

- ◆ Command frequency is determined in the following order of priority.
 1. Limiting defrost control time
 2. Forced cooling
 3. Indoor frequency command

2. Determine upper limit frequency

- ◆ The minimum value is set as an upper limit frequency among the frequency upper limits of the following functions:
Compressor protection, input current, discharge pipe temperature, heating peak-cut, freeze-up protection, defrost.

3. Determine lower limit frequency

- ◆ The maximum value is set as a lower limit frequency among the frequency lower limits of the following functions:
Four way valve operation compensation, draft prevention, pressure difference upkeep.

4. Determine prohibited frequency

- ◆ There is a certain prohibited frequency such as a power supply frequency.

Indoor Frequency Command (ΔD signal)

The difference between the room thermistor temperature and the target temperature is taken as the " ΔD signal" and is used for frequency command.

Temperature difference	ΔD signal	Temperature difference	ΔD signal	Temperature difference	ΔD signal	Temperature difference	ΔD signal
-2.0	*Th OFF	0	4	2.0	8	4.0	C
-1.5	1	0.5	5	2.5	9	4.5	D
-1.0	2	1.0	6	3.0	A	5.0	E
-0.5	3	1.5	7	3.5	B	5.5	F

*Th OFF = Thermostat OFF

Frequency Initial Setting

When starting the compressor, the frequency is initialized according to the ΔD value and the Q value of the indoor unit.

Q value: Indoor unit output determined from indoor unit volume, airflow rate and other factors.

PI Control (Determine Frequency Up / Down by ΔD Signal)**1. P control**

The ΔD value is calculated in each sampling time (20 seconds), and the frequency is adjusted according to its difference from the frequency previously calculated.

2. I control

If the operating frequency does not change for more than a certain fixed time, the frequency is adjusted according to the ΔD value.

When the ΔD value is low, the frequency is lowered.

When the ΔD value is high, the frequency is increased.

3. Frequency management when other controls are functioning

- ◆ When frequency is dropping;
Frequency management is carried out only when the frequency drops.
- ◆ For limiting lower limit
Frequency management is carried out only when the frequency rises.

4. Upper and lower limit of frequency by PI control

The frequency upper and lower limits are set according to the command of the indoor unit.

When the indoor or outdoor unit quiet operation command comes from the indoor unit, the upper limit frequency is lower than the usual setting.

3.3 Controls at Mode Changing / Start-up

3.3.1 Preheating Control

Outline The inverter operation in open phase starts with the conditions of the preheating command from the indoor unit, the outdoor temperature, and the discharge pipe temperature.

Detail Outdoor temperature $\geq A^{\circ}\text{C}$ → Control I
Outdoor temperature $< A^{\circ}\text{C}$ → Control II

Control I

- ◆ ON condition
Discharge pipe temperature $< B^{\circ}\text{C}$
- ◆ OFF condition
Discharge pipe temperature $> C^{\circ}\text{C}$
Radiation fin temperature $\geq 90^{\circ}\text{C}$

Control II

- ◆ ON condition
Discharge pipe temperature $< D^{\circ}\text{C}$
- ◆ OFF condition
Discharge pipe temperature $> E^{\circ}\text{C}$
Radiation fin temperature $\geq 90^{\circ}\text{C}$

	A (°C)	B (°C)	C (°C)	D (°C)	E (°C)
RX20/25/35JV1B, ARX20/25/35JV1B	7	10	12	20	22
RX20/25/35J3V1B, ARX20/25/35J3V1B	-2.5	0	2	10	12

3.3.2 Four Way Valve Switching

Outline In heating operation, current is conducted, and in cooling operation and defrost control, current is not conducted. In order to eliminate the switching sound as the four way valve coil switches from ON to OFF when the heating is stopped, the OFF delay switch of the four way valve is carried out.

Detail **OFF delay switch of four way valve:**
The four way valve coil is energized for 160 seconds after the operation is stopped.

3.3.3 Four Way Valve Operation Compensation

Outline At the beginning of the operation as the four way valve is switched, the pressure difference to activate the four way valve is acquired by having output frequency which is more than a certain fixed frequency, for a certain fixed time.

Detail **Starting Conditions**

1. When the compressor starts and the four way valve switches from OFF to ON
2. When the four way valve switches from ON to OFF during operation
3. When the compressor starts after resetting
4. When the compressor starts after the fault of four way valve switching

The lower limit of frequency keeps **A** Hz for **B** seconds with any conditions 1 through 4 above.

A (Hz)	62
B (seconds)	50

3.3.4 3-minute Standby

Turning on the compressor is prohibited for 3 minutes after turning it off.
(Except when defrosting.)

3.3.5 Compressor Protection Function

When turning the compressor from OFF to ON, the upper limit of frequency is set as follows.
(The function is not activated when defrosting.)

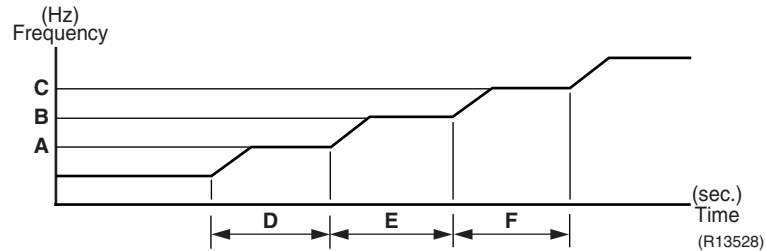

A (Hz)	58
B (Hz)	72
C (Hz)	90
D (seconds)	180
E (seconds)	180
F (seconds)	10

3.4 Discharge Pipe Temperature Control

Outline

The discharge pipe temperature is used as the internal temperature of the compressor. If the discharge pipe temperature rises above a certain level, the upper limit of frequency is set to keep the discharge pipe temperature from rising further.

Detail

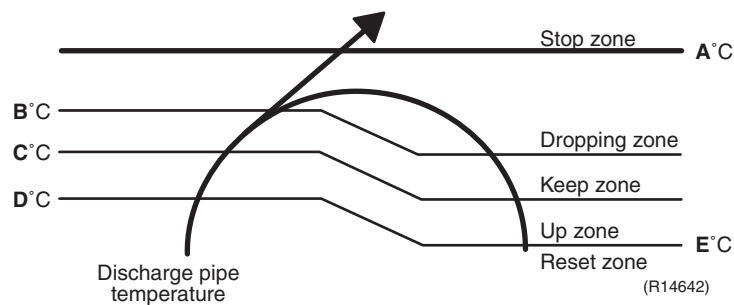

Zone	Control
Stop zone	When the temperature reaches the stop zone, the compressor stops.
Dropping zone	The upper limit of frequency decreases.
Keep zone	The upper limit of frequency is kept.
Up zone	The upper limit of frequency increases.
Reset zone	The upper limit of frequency is canceled.

A (°C)	110
B (°C)	105
C (°C)	101
D (°C)	99
E (°C)	97

3.5 Input Current Control

Outline

The microcomputer calculates the input current while the compressor is running, and sets the frequency upper limit from the input current. In case of heat pump models, this control which is the upper limit control of the frequency takes priority over the lower limit of control of four way valve operation compensation.

Detail

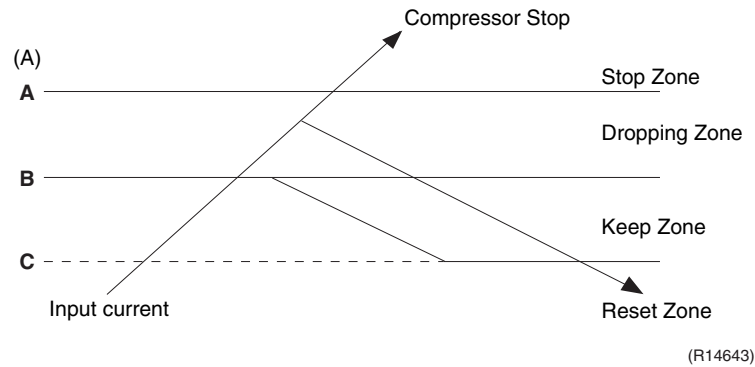

Frequency control in each zone

Stop zone

- After 2.5 seconds in this zone, the compressor is stopped.

Dropping zone

- The upper limit of the compressor frequency is defined as operation frequency – 2 Hz.
- After this, the output frequency is lowered by 2 Hz every second until it reaches the keep zone.

Keep zone

- The present maximum frequency goes on.

Reset zone

- Limit of the frequency is canceled.

		20/25 class		35 class	
		Cooling	Heating	Cooling	Heating
A	(A)	14	14	14	14
B	(A) Normal mode	6.0	6.75	6.5	7.75
	ECONO mode	2.75	2.75	2.75	2.75
C	(A) Normal mode	5.25	6.0	5.75	7.0
	ECONO mode	2.0	2.0	2.0	2.0

Limitation of current dropping and stop value according to the outdoor temperature

- The current drops when outdoor temperature becomes higher than a certain level (depending on the model).

3.6 Freeze-up Protection Control

Outline During cooling operation, the signal sent from the indoor unit controls the operating frequency limitation and prevents freezing of the indoor heat exchanger. (The signal from the indoor unit is divided into zones.)

Detail The operating frequency limitation is judged with the indoor heat exchanger temperature.

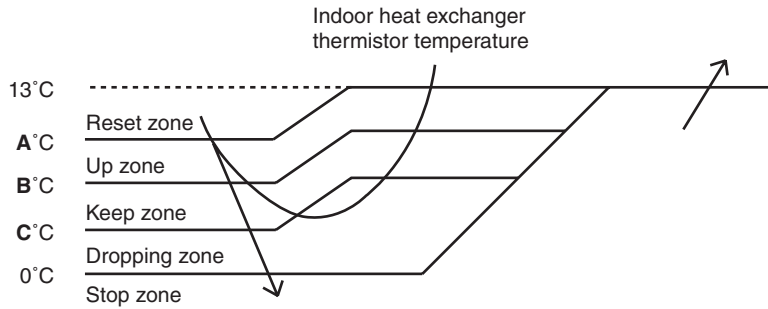

(R14718)

A (°C)	B (°C)	C (°C)
11	9	7

3.7 Heating Peak-cut Control

Outline During heating operation, the indoor heat exchanger temperature determines the frequency upper limit to prevent abnormal high pressure.

Detail

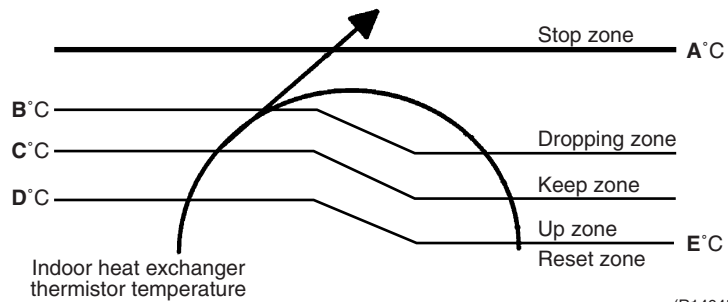

(R14645)

Zone	Control
Stop zone	When the temperature reaches the stop zone, the compressor stops.
Dropping zone	The upper limit of frequency decreases.
Keep zone	The upper limit of frequency is kept.
Up zone	The upper limit of frequency increases.
Reset zone	The upper limit of frequency is canceled.

A (°C)	B (°C)	C (°C)	D (°C)	E (°C)
65	55	52	50	45

3.8 Outdoor Fan Control

1. Fan ON control to cool down the electrical box

The outdoor fan is turned ON when the electrical box temperature is high while the compressor is OFF.

2. Fan OFF control during defrosting

The outdoor fan is turned OFF during defrosting.

3. Fan OFF delay when stopped

The outdoor fan is turned OFF 70 seconds after the compressor stops.

4. Fan speed control for pressure difference upkeep

The rotation speed of the outdoor fan is controlled for keeping the pressure difference during cooling operation with low outdoor temperature.

- ◆ When the pressure difference is low, the rotation speed of the outdoor fan is reduced.
- ◆ When the pressure difference is high, the rotation speed of the outdoor fan is controlled as well as normal operation.

5. Fan speed control during forced cooling operation

The outdoor fan is controlled as well as normal operation during forced cooling operation.

6. Fan speed control during POWERFUL operation

The rotation speed of the outdoor fan is increased during POWERFUL operation.

7. Fan speed control during indoor / outdoor unit quiet operation

The rotation speed of the outdoor fan is reduced by the command of the indoor / outdoor unit quiet operation.

8. Fan ON/OFF control when operation starts / stops

The outdoor fan is turned ON when the operation starts. The outdoor fan is turned OFF when the operation stops.

3.9 Liquid Compression Protection Function

Outline

In order to obtain the dependability of the compressor, the compressor is stopped according to the outdoor temperature and the outdoor heat exchanger temperature.

Detail

Operation stops depending on the outdoor temperature.

Compressor turns off under the conditions that the system is in cooling operation and outdoor temperature is below 0°C.

3.10 Defrost Control

Outline

Defrosting is carried out by the cooling cycle (reverse cycle). The defrosting time or outdoor heat exchanger temperature must be more than a certain value to finish defrosting.

Detail

Conditions for Starting Defrost

- The starting conditions are determined with the outdoor temperature and the outdoor heat exchanger temperature.
- The system is in heating operation.
- The compressor operates for 6 minutes.
- More than **A** minutes of accumulated time pass after the start of the operation, or ending the previous defrosting.

Conditions for Canceling Defrost

The judgment is made with the outdoor heat exchanger temperature. (**B**°C)

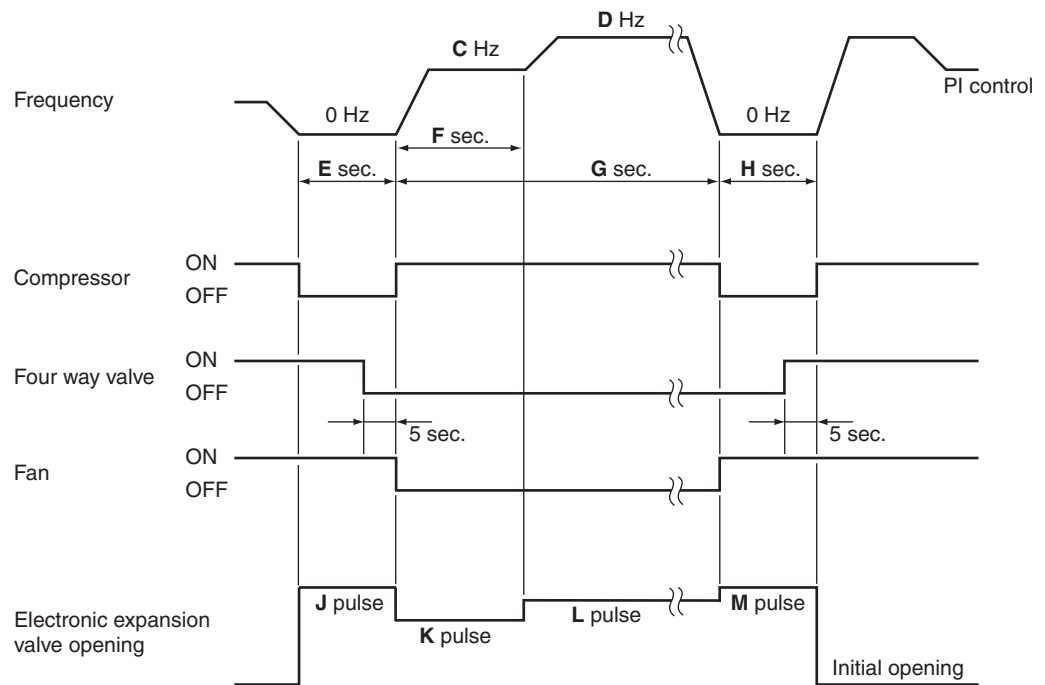

(R18152)

	20/25 class	35 class
A (minutes)	28	28
B (°C)	4 ~ 22	4 ~ 22
C (Hz)	68	72
D (Hz)	80	84
E (seconds)	80	80
F (seconds)	60	60
G (seconds)	510	510
H (seconds)	100	70
J (pulse)	450	450
K (pulse)	400	400
L (pulse)	430	430
M (pulse)	450	450

3.11 Electronic Expansion Valve Control

Outline

The following items are included in the electronic expansion valve control.

Electronic expansion valve is fully closed

1. Electronic expansion valve is fully closed when turning on the power.
2. Pressure equalizing control

Open Control

1. Electronic expansion valve control when starting operation
2. Electronic expansion valve control when the frequency changes
3. Electronic expansion valve control for defrosting
4. Electronic expansion valve control when the discharge pipe temperature is abnormally high
5. Electronic expansion valve control when the discharge pipe thermistor is disconnected

Feedback Control

Target discharge pipe temperature control

Detail

The followings are the examples of electronic expansion valve control which function in each operation mode.

	When the power turns on or when the compressor stops	When the operation starts	When the frequency changes under starting control	During target discharge pipe temperature control	When the frequency changes under target discharge pipe temperature control	When the disconnection of the discharge pipe thermistor is ascertained	When the frequency changes under the control for disconnection of the discharge pipe thermistor	Under defrost control
● : Available — : Not available								
Cooling								
Starting control	—	●	—	—	—	—	—	—
Control when the frequency changes	—	—	●	—	●	—	—	—
Target discharge pipe temperature control	—	—	—	●	—	—	—	—
Control for disconnection of the discharge pipe thermistor	—	—	—	—	—	●	●	—
High discharge pipe temperature control	—	●	●	●	●	—	—	—
Pressure equalizing control	●	—	—	—	—	—	—	—
Opening limit control	—	●	●	●	●	●	●	—
Heating								
Starting control	—	●	—	—	—	—	—	—
Control when the frequency changes	—	—	●	—	●	—	—	—
Target discharge pipe temperature control	—	—	—	●	—	—	—	—
Control for disconnection of the discharge pipe thermistor	—	—	—	—	—	●	●	—
High discharge pipe temperature control	—	●	●	●	●	—	—	—
Defrost control	—	—	—	—	—	—	—	●
Pressure equalizing control	●	—	—	—	—	—	—	—
Opening limit control	—	●	●	●	●	●	●	—

3.11.1 Fully Closing with Power ON

The electronic expansion valve is initialized when turning on the power. The opening position is set and the pressure equalization is developed.

3.11.2 Pressure Equalizing Control

When the compressor is stopped, the pressure equalizing control is activated. The electronic expansion valve opens, and develops the pressure equalization.

3.11.3 Opening Limit Control

The maximum and minimum opening of the electronic expansion valve are limited.

Maximum opening pulse	470
Minimum opening pulse	52

The electronic expansion valve is fully closed when cooling operation stops, and is opened at a fixed degree during defrosting.

3.11.4 Starting Operation Control

The electronic expansion valve opening is controlled when the operation starts, and prevents superheating or liquid compression.

3.11.5 Control when the Frequency Changes

When the target discharge pipe temperature control is active, if the target frequency is changed to a specified value in a certain time period, the target discharge pipe temperature control is canceled and the target opening of the electronic expansion valve is changed according to the shift.

3.11.6 High Discharge Pipe Temperature Control

When the compressor is operating, if the discharge pipe temperature exceeds a certain value, the electronic expansion valve opens and the refrigerant runs to the low pressure side. This procedure lowers the discharge pipe temperature.

3.11.7 Control for Disconnection of the Discharge Pipe Thermistor

Outline

The disconnection of the discharge pipe thermistor is detected by comparing the discharge pipe temperature with the condensation temperature. If the discharge pipe thermistor is disconnected, the electronic expansion valve opens according to the outdoor temperature and the operation frequency, operates for a specified time, and then stops.

After 3 minutes, the operation restarts and checks if the discharge pipe thermistor is disconnected. If the discharge pipe thermistor is disconnected, the system stops after operating for a specified time.

If the disconnection is detected repeatedly, the system is shut down. When the compressor runs for 60 minutes without any error, the error counter is reset.

Detail

When the starting control (cooling: **A** seconds, heating: **B** seconds) finishes, the detection timer for disconnection of the discharge pipe thermistor (**C** seconds) starts. When the timer is over, the following adjustment is made.

When the following condition is fulfilled, the discharge pipe thermistor disconnection is ascertained.

<Cooling>

Discharge pipe temperature + 6°C < outdoor heat exchanger temperature

<Heating>

Discharge pipe temperature + 6°C < indoor heat exchanger temperature

A (seconds)	10
B (seconds)	120
C (seconds)	720

Adjustment when the thermistor is disconnected

When the disconnection is ascertained, the compressor continues operation for 9 minutes and then stops.

If the compressor stops repeatedly, the system is shut down.

3.11.8 Target Discharge Pipe Temperature Control

The target discharge pipe temperature is obtained from the indoor and outdoor heat exchanger temperature, and the electronic expansion valve opening is adjusted so that the actual discharge pipe temperature becomes close to the target discharge pipe temperature. (Indirect SH (superheating) control using the discharge pipe temperature)

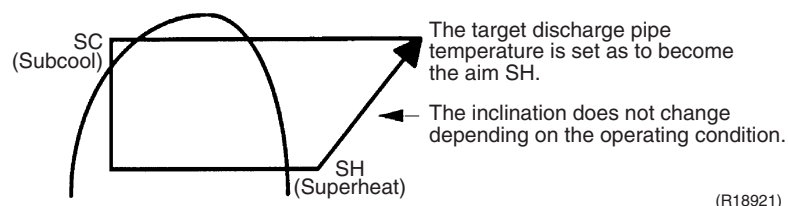

The electronic expansion valve opening and the target discharge pipe temperature are adjusted every 20 seconds. The target discharge pipe temperature is controlled by indoor heat exchanger temperature and outdoor heat exchanger temperature. The opening degree of the electronic expansion valve is controlled by the followings.

- ◆ Target discharge pipe temperature
- ◆ Actual discharge pipe temperature
- ◆ Previous discharge pipe temperature

3.12 Malfunctions

3.12.1 Sensor Malfunction Detection

Sensor malfunction may occur in the thermistor.

Relating to Thermistor Malfunction

1. Outdoor heat exchanger thermistor
2. Discharge pipe thermistor
3. Radiation fin thermistor
4. Outdoor temperature thermistor

3.12.2 Detection of Overcurrent and Overload

Outline

An excessive output current is detected and the OL temperature is observed to protect the compressor.

Detail

- If the OL (compressor head) temperature exceeds 120°C, the system shuts down the compressor.
- If the inverter current exceeds 14 A, the system shuts down the compressor.

3.12.3 Refrigerant Shortage Control

Outline

I: Detecting by power consumption

If the power consumption is below the specified value and the frequency is higher than the specified frequency, it is regarded as refrigerant shortage.

The power consumption is low comparing with that in the normal operation when refrigerant is insufficient, and refrigerant shortage is detected by checking power consumption.

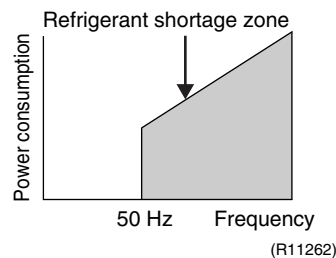

II: Detecting by discharge pipe temperature

If the discharge pipe temperature is higher than the target discharge pipe temperature, and the electronic expansion valve is fully open for more than the specified time, it is regarded as refrigerant shortage.

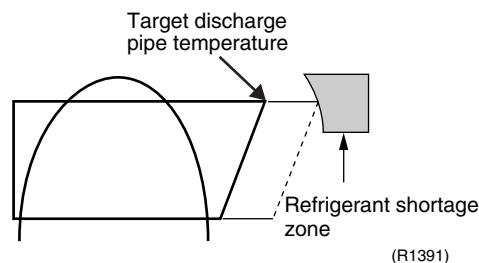

Refer to page 57 for detail.

Part 5

Remote Controller

1. Remote Controller43

1. Remote Controller

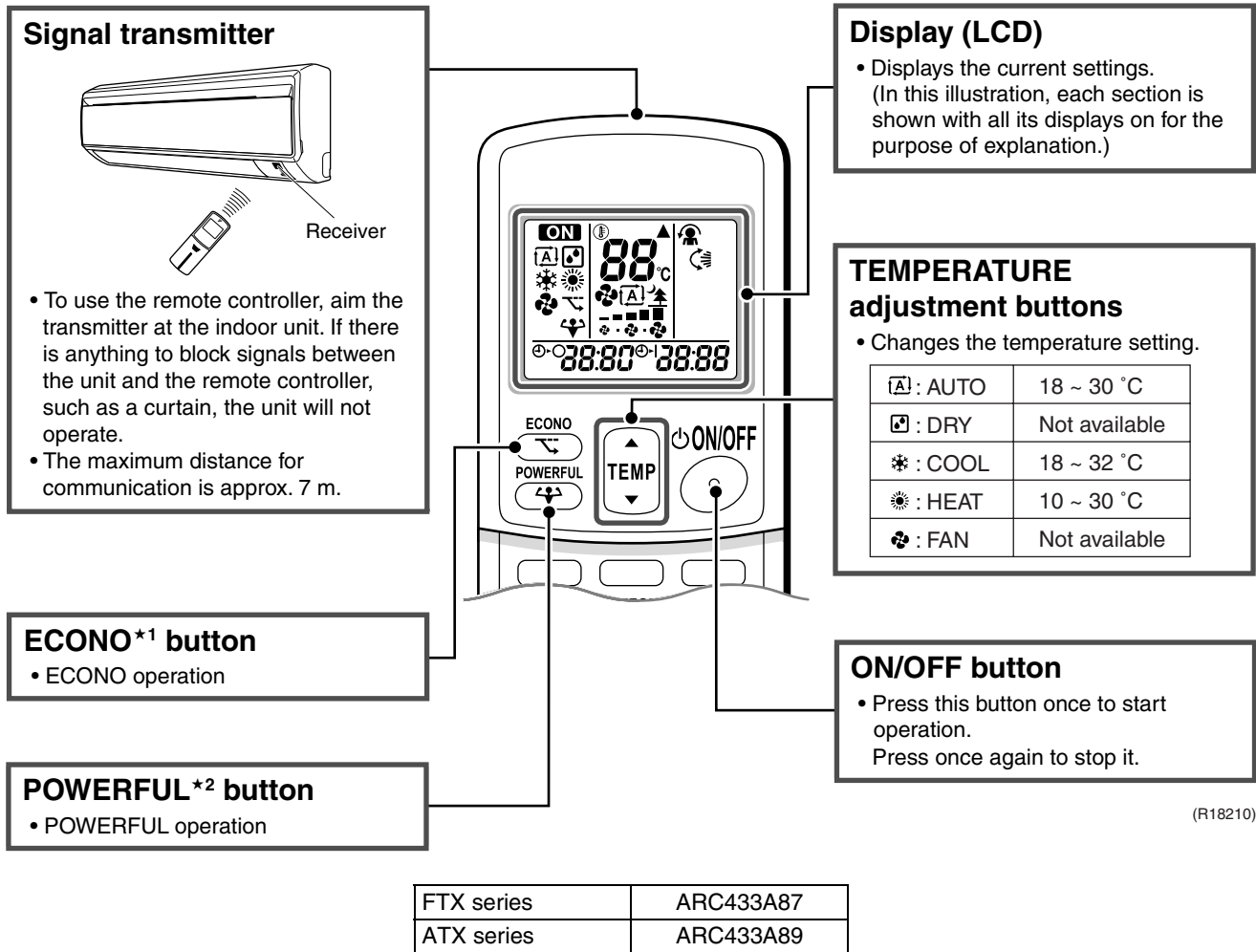

(R18210)

Reference

Refer to the following pages for detail.

★1	ECONO operation	P.26
★2	POWERFUL operation	P.27



Note:

Refer to the operation manual of applicable model for detail. You can download operation manuals from 'DISTRIBUTOR'S PAGE':

DISTRIBUTOR'S PAGE → Product Information → Operation/Installation Manual
 (URL: http://global.daikin.com/Daikin/global/Distributors_admin/user_mng/login.php)

Open the Front Cover



MODE button

- Selects the operation mode.

ON TIMER button

- Press this button and adjust the day and time with TIMER setting button. Press this button again to complete TIMER setting.

OFF TIMER button

- Press this button and adjust the day and time with TIMER setting button. Press this button again to complete TIMER setting.

TIMER Setting button

- Changes the ON/OFF TIMER settings.

COMFORT*4 button

- The airflow direction will be in upward while in COOL operation, in downward while in HEAT operation. This function will prevent cold or warm air from directly blowing on your body.

CLOCK*5 button

RESET button

- Restarts the unit if it freezes.
- Use a thin object to push.

FAN setting button

- Selects the airflow rate setting every time you press this button.

- In indoor unit quiet operation, operation sound becomes weak. (The airflow rate also decreases.)
- In DRY operation, the airflow rate setting is not available.

SWING*3 button

- Adjusts the airflow direction.
- When you press the SWING button, the flap moves up and down. The flap stops when you pressed the SWING button again.

TIMER CANCEL button

- Cancels the timer setting.

(R19105)

Reference

Refer to the following pages for detail.

★3	Auto-swing setting	P.21
★4	COMFORT AIRFLOW operation	P.21, 22

★5	Clock setting	P.27
----	---------------	------



Note:

Refer to the operation manual of applicable model for detail. You can download operation manuals from 'DISTRIBUTOR'S PAGE':
 DISTRIBUTOR'S PAGE → Product Information → Operation/Installation Manual
 (URL: http://global.daikin.com/Daikin/global/Distributors_admin/user_mng/login.php)

Part 6

Service Diagnosis

1. Troubleshooting with LED	46
1.1 Indoor Unit.....	46
1.2 Outdoor Unit.....	46
2. Problem Symptoms and Measures	47
3. Service Check Function	48
4. Troubleshooting	51
4.1 Error Codes and Description	51
4.2 Indoor Unit PCB Abnormality	52
4.3 Freeze-up Protection Control or Heating Peak-cut Control.....	53
4.4 Fan Motor (DC Motor) or Related Abnormality.....	54
4.5 Thermistor or Related Abnormality (Indoor Unit).....	56
4.6 Refrigerant Shortage.....	57
4.7 Low-voltage Detection or Over-voltage Detection.....	59
4.8 Signal Transmission Error (between Indoor Unit and Outdoor Unit).....	61
4.9 Unspecified Voltage (between Indoor Unit and Outdoor Unit)	63
4.10 Outdoor Unit PCB Abnormality.....	64
4.11 OL Activation (Compressor Overload)	65
4.12 Compressor Lock	67
4.13 DC Fan Lock	68
4.14 Input Overcurrent Detection	69
4.15 Four Way Valve Abnormality.....	70
4.16 Discharge Pipe Temperature Control.....	72
4.17 High Pressure Control in Cooling	73
4.18 Compressor System Sensor Abnormality	74
4.19 Position Sensor Abnormality	75
4.20 DC Voltage / Current Sensor Abnormality.....	77
4.21 Thermistor or Related Abnormality (Outdoor Unit).....	78
4.22 Electrical Box Temperature Rise.....	80
4.23 Radiation Fin Temperature Rise	81
4.24 Output Overcurrent Detection	83
5. Check.....	85
5.1 Thermistor Resistance Check	85
5.2 Fan Motor Connector Output Check	86
5.3 Power Supply Waveforms Check.....	87
5.4 Electronic Expansion Valve Check.....	87
5.5 Four Way Valve Performance Check	88
5.6 Inverter Units Refrigerant System Check.....	88
5.7 Inverter Analyzer Check.....	89
5.8 Rotation Pulse Check on the Outdoor Unit PCB.....	90
5.9 Installation Condition Check.....	91
5.10 Discharge Pressure Check.....	91
5.11 Outdoor Fan System Check.....	92
5.12 Main Circuit Short Check.....	92
5.13 Power Module Check	93

1. Troubleshooting with LED

1.1 Indoor Unit

Operation Lamp

The operation lamp blinks when any of the following errors is detected.

1. When a protection device of the indoor or outdoor unit is activated, or when the thermistor malfunctions.
 2. When a signal transmission error occurs between the indoor and outdoor units.
- In either case, conduct the diagnostic procedure described in the following pages.

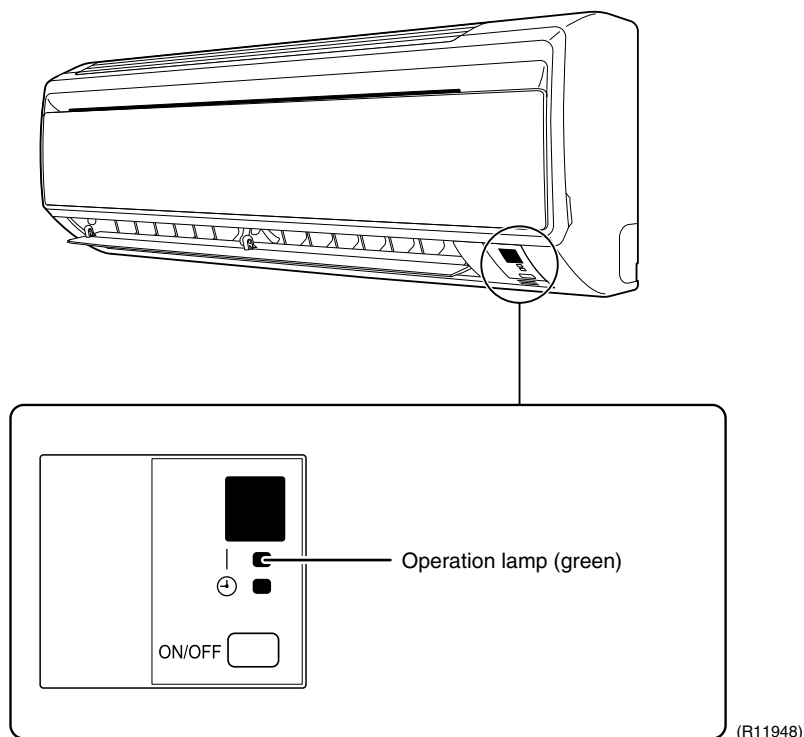

Service Monitor

The indoor unit has one green LED (LED A) on the control PCB. When the microcomputer works in order, the LED A blinks.

1.2 Outdoor Unit

The outdoor unit has one green LED (LED A) on the PCB. When the microcomputer works in order, the LED A blinks.

2. Problem Symptoms and Measures

Symptom	Check Item	Details of Measure	Reference Page
The unit does not operate.	Check the power supply.	Check if the rated voltage is supplied.	—
	Check the type of the indoor unit.	Check if the indoor unit type is compatible with the outdoor unit.	—
	Check the outdoor temperature.	Heating operation cannot be used when the outdoor temperature is 18°CWB or higher, and cooling operation cannot be used when the outdoor temperature is below 10°CDB.	—
	Diagnose with remote controller indication.	—	51
	Check the remote controller addresses.	Check if address settings for the remote controller and indoor unit are correct.	97
Operation sometimes stops.	Check the power supply.	A power failure of 2 to 10 cycles stops air conditioner operation. (Operation lamp OFF)	—
	Check the outdoor temperature.	Heating operation cannot be used when the outdoor temperature is 18°CWB or higher, and cooling operation cannot be used when the outdoor temperature is below 10°CDB.	—
	Diagnose with remote controller indication.	—	51
The unit operates but does not cool, or does not heat.	Check for wiring and piping errors in the connection between the indoor unit and outdoor unit.	—	—
	Check for thermistor detection errors.	Check if the thermistor is mounted securely.	—
	Check for faulty operation of the electronic expansion valve.	Set the unit to cooling operation, and check the liquid pipe temperature to see if the electronic expansion valve works.	—
	Diagnose with remote controller indication.	—	51
	Diagnose by service port pressure and operating current.	Check for refrigerant shortage.	57
Large operating noise and vibrations	Check the output voltage of the power module.	—	93
	Check the power module.	—	—
	Check the installation condition.	Check if the required spaces for installation (specified in the installation manual) are provided.	—

3. Service Check Function

Check Method 1

- When the timer cancel button is held down for 5 seconds, **00** is displayed on the temperature display screen.

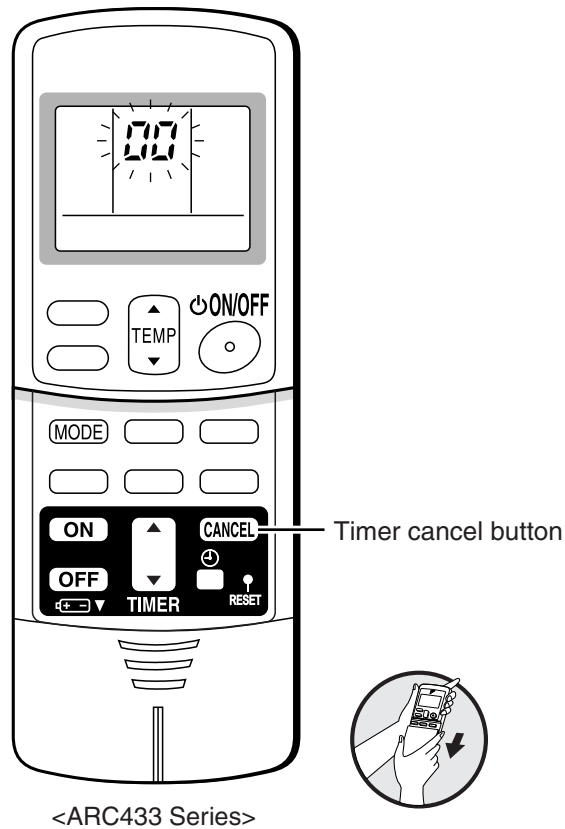

(R18206)

- Press the timer cancel button repeatedly until a long beep sounds.
 - The code indication changes in the sequence shown below.

No.	Code	No.	Code	No.	Code
1	00	13	C7	25	UR
2	U4	14	R3	26	UH
3	L5	15	H8	27	P4
4	E6	16	H9	28	L3
5	H6	17	C9	29	L4
6	H0	18	C4	30	H7
7	R6	19	C5	31	U2
8	E7	20	J3	32	ER
9	U0	21	J6	33	RH
10	F3	22	E5	34★	FR
11	R5	23	R1		
12	F6	24	E1		

★ for FTX models only



Note:

- A short beep or two consecutive beeps indicate non-corresponding codes.
- To return to the normal mode, hold the timer cancel button down for 5 seconds. When the remote controller is left untouched for 60 seconds, it also returns to the normal mode.
- Not all the error codes are displayed. When you cannot find the error code, try the check method 2. (→ Refer to page 49.)

Check Method 2

1. Press the center of the [TEMP] button and the [MODE] button at the same time to enter the diagnosis mode.

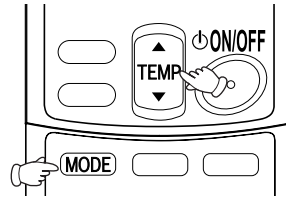

(R19114)

The left-side number blinks.

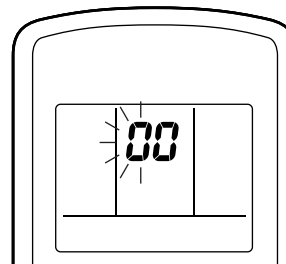

(R14967)

2. Press the [TEMP] ▲ or ▼ button and change the number until you hear the two consecutive beeps or the long beep.

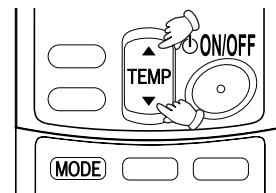

(R19115)

3. Diagnose by the sound.

- ★beep : The left-side number does not correspond with the error code.
- ★two consecutive beeps : The left-side number corresponds with the error code but the right-side number does not.
- ★long beep : Both the left-side and right-side numbers correspond with the error code.
The numbers indicated when you hear the long beep are the error code.
Error codes and description → Refer to page 51.

4. Press the [MODE] button.

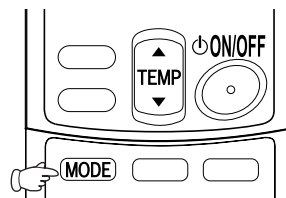

(R19116)

The right-side number blinks.

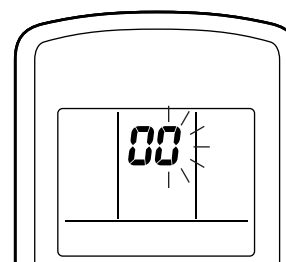

(R14968)

5. Press the [TEMP] ▲ or ▼ button and change the number until you hear the long beep.

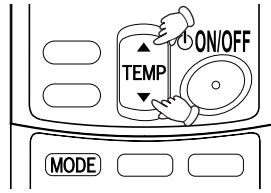

(R19115)

6. Diagnose by the sound.
- ★beep : The left-side number does not correspond with the error code.
 - ★two consecutive beeps : The left-side number corresponds with the error code but the right-side number does not.
 - ★long beep : Both the left-side and right-side numbers correspond with the error code.
7. Determine the error code.
The numbers indicated when you hear the long beep are the error code.
Error codes and description → Refer to page 51.
8. Press the [MODE] button to exit from the diagnosis mode.

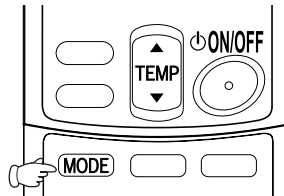

(R19116)

The display 7° means the trial operation mode.
Refer to page 96 for trial operation.

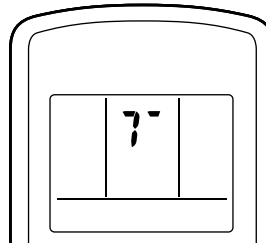

(R14969)

9. Press the [ON/OFF] button twice to return to the normal mode.

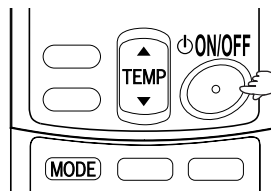

(R19117)



Note: When the remote controller is left untouched for 60 seconds, it returns to the normal mode.

4. Troubleshooting

4.1 Error Codes and Description

	Error Codes	Description	Reference Page
System	00	Normal	—
	U0★	Refrigerant shortage	57
	U2	Low-voltage detection or over-voltage detection	59
	U4	Signal transmission error (between indoor unit and outdoor unit)	61
	U8	Unspecified voltage (between indoor unit and outdoor unit)	63
Indoor Unit	R1	Indoor unit PCB abnormality	52
	R5	Freeze-up protection control or heating peak-cut control	53
	R6	Fan motor (DC motor) or related abnormality	54
	C4	Indoor heat exchanger thermistor or related abnormality	56
	C9	Room temperature thermistor or related abnormality	56
Outdoor Unit	E1	Outdoor unit PCB abnormality	64
	E5★	OL activation (compressor overload)	65
	E6★	Compressor lock	67
	E7★	DC fan lock	68
	E8	Input overcurrent detection	69
	E9	Four way valve abnormality	70
	F3	Discharge pipe temperature control	72
	F6	High pressure control in cooling	73
	H0	Compressor system sensor abnormality	74
	H6	Position sensor abnormality	75
	H8	DC voltage / current sensor abnormality	77
	H9	Outdoor temperature thermistor or related abnormality	78
	U3★	Discharge pipe thermistor or related abnormality	78
	U5	Outdoor heat exchanger thermistor or related abnormality	78
	L3	Electrical box temperature rise	80
	L4	Radiation fin temperature rise	81
	L5★	Output overcurrent detection	83
	P4	Radiation fin thermistor or related abnormality	78

★: Displayed only when system-down occurs.

4.2 Indoor Unit PCB Abnormality

Error Code

P1

Method of Error Detection

The system checks if the circuit works properly within the microcomputer of the indoor unit.

Error Decision Conditions

The system cannot set the internal settings.

Supposed Causes

- Wrong models interconnected
- Defective indoor unit PCB
- Disconnection of connector
- Reduction of power supply voltage

Troubleshooting

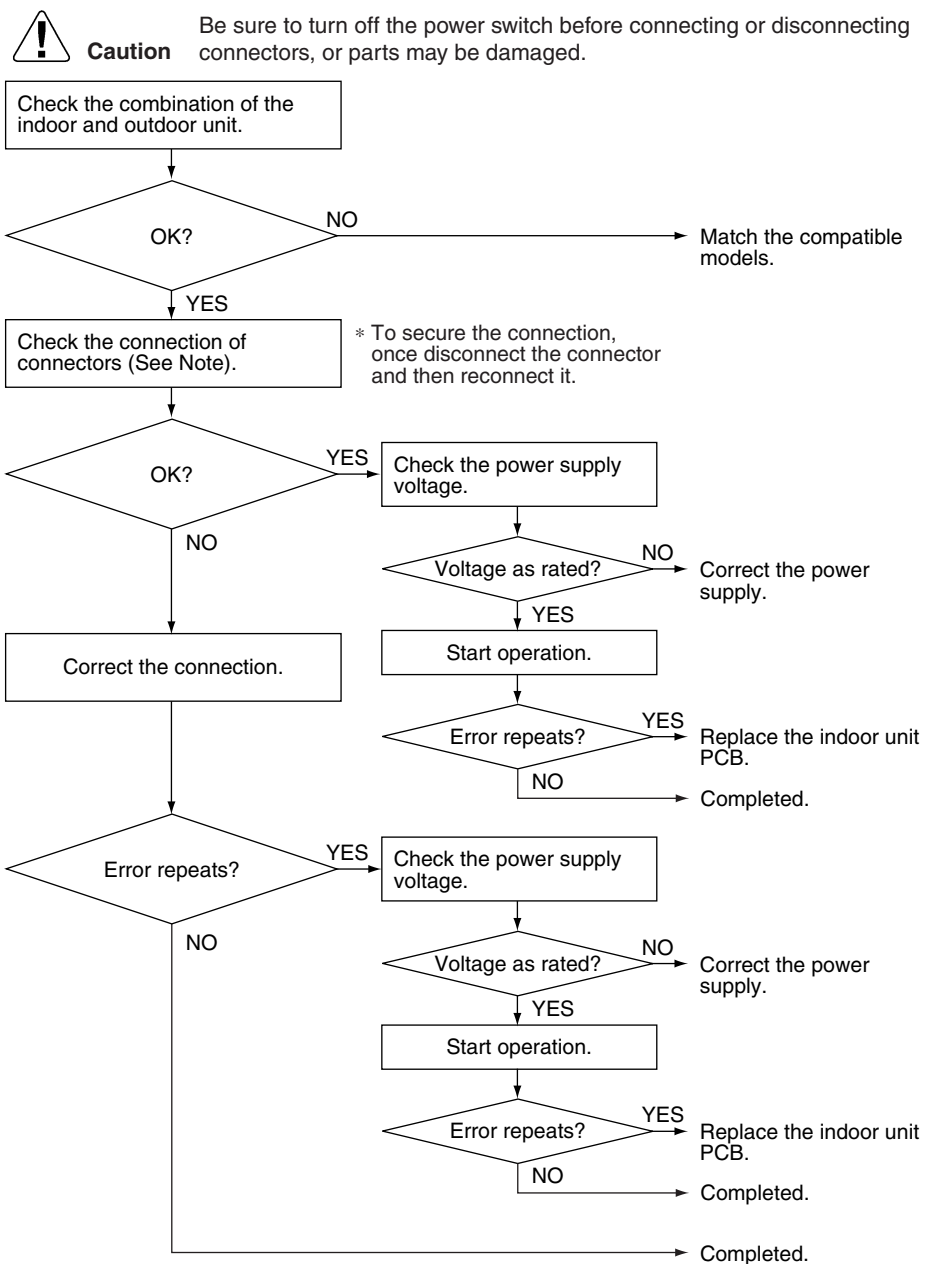

Note: Check the following connector.

Model Type	Connector
Wall Mounted Type	Terminal board ~ Control PCB (H1, H2, H3)

(R15310)

4.3 Freeze-up Protection Control or Heating Peak-cut Control

Error Code	A5
Method of Error Detection	<ul style="list-style-type: none"> ■ Freeze-up protection control During cooling operation, the freeze-up protection control (operation halt) is activated according to the temperature detected by the indoor heat exchanger thermistor. ■ Heating peak-cut control During heating operation, the temperature detected by the indoor heat exchanger thermistor is used for the heating peak-cut control (operation halt, outdoor fan stop, etc.)
Error Decision Conditions	<ul style="list-style-type: none"> ■ Freeze-up protection control During cooling operation, the indoor heat exchanger temperature is below 0°C. ■ Heating peak-cut control During heating operation, the indoor heat exchanger temperature is above 65°C
Supposed Causes	<ul style="list-style-type: none"> ■ Short-circuited air ■ Clogged air filter of the indoor unit ■ Dust accumulation on the indoor heat exchanger ■ Defective indoor heat exchanger thermistor ■ Defective indoor unit PCB

Troubleshooting

Check No.01
Refer to P.85

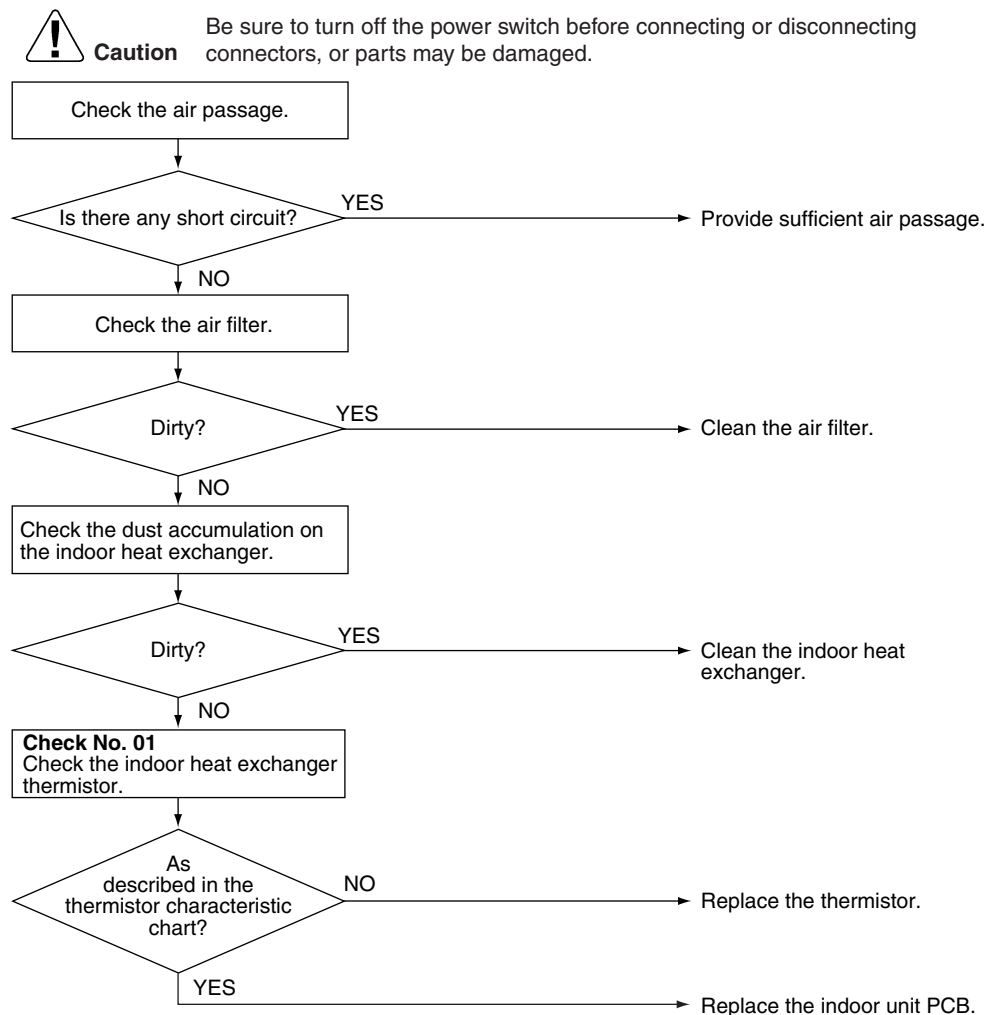

(R15715)

4.4 Fan Motor (DC Motor) or Related Abnormality

Error Code	FE
Method of Error Detection	The rotation speed detected by the Hall IC during fan motor operation is used to determine abnormal fan motor operation.
Error Decision Conditions	The detected rotation speed does not reach the demanded rotation speed of the target tap, and is less than 50% of the maximum fan motor rotation speed.
Supposed Causes	<ul style="list-style-type: none">■ Disconnection of connector■ Foreign matters stuck in the fan■ Layer short inside the fan motor winding■ Breaking of wire inside the fan motor■ Breaking of the fan motor lead wires■ Defective capacitor of the fan motor■ Defective indoor unit PCB

Troubleshooting



Check No.03
Refer to P.86



Caution

Be sure to turn off the power switch before connecting or disconnecting connectors, or parts may be damaged.

Turn off the power supply.
(Unplug the power cable or turn the breaker off.)

Note: The motor may break when the motor connector is disconnected with the power supply on.
(Turn off the power supply before connecting the connector also.)

Check the connector for connection.

* To secure the connection, once disconnect the connector and then reconnect it.

OK?

NO

Correct the connection.

YES

Foreign matters in or around the fan?

YES

Remove the foreign matters.

NO

Rotate the fan by hand.

Fan rotates smoothly?

NO

Abnormal sound occurs?

NO

Check No. 03
Check the fan motor for breakdown or short circuit.

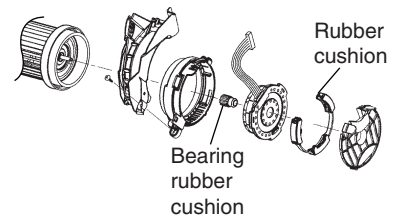

Is the rubber cushion properly fitted?

YES

Replace the bearing rubber cushion.

NO

Correct the position of rubber cushion or replace the rubber cushion.

Resistance OK?

NO

Replace the indoor fan motor.

YES

Turn the power on again.

Check No. 03
Check the motor control voltage.

Is the motor control voltage 15 VDC generated?

NO

Replace the indoor unit PCB (1).

YES

Check No. 03
Check the indoor unit PCB for rotation pulse.

Is the rotation pulse generated?

NO

Replace the indoor fan motor.

YES

Replace the indoor unit PCB (1).

(R18153)

4.5 Thermistor or Related Abnormality (Indoor Unit)

Error Code	Ⓛ4,Ⓛ9
Method of Error Detection	The temperatures detected by the thermistors determine thermistor errors.
Error Decision Conditions	The thermistor input is more than 4.96 V or less than 0.04 V during compressor operation.
Supposed Causes	<ul style="list-style-type: none"> ■ Disconnection of connector ■ Thermistor corresponding to the error code is defective ■ Defective indoor unit PCB

Troubleshooting

Check No.01
 Refer to P.85

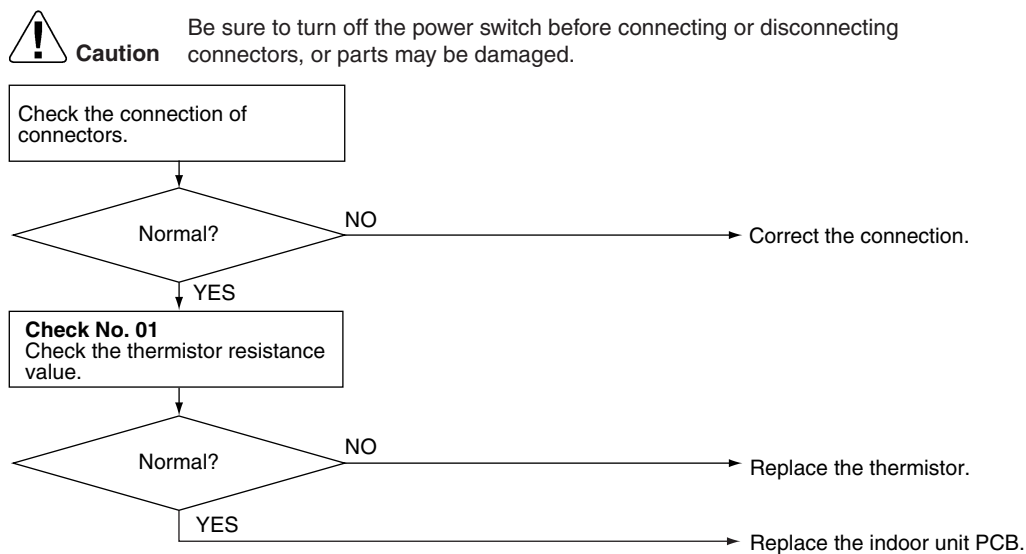

(R15717)

Ⓛ4 : Indoor heat exchanger thermistor

Ⓛ9 : Room temperature thermistor

4.6 Refrigerant Shortage

Error Code	U0																																	
Method of Error Detection	<p>Refrigerant shortage detection I: Refrigerant shortage is detected by checking the input current value and the compressor running frequency. If the refrigerant is short, the input current is lower than the normal value.</p> <p>Refrigerant shortage detection II: Refrigerant shortage is detected by checking the discharge pipe temperature and the opening of the electronic expansion valve. If the refrigerant is short, the discharge pipe temperature tends to rise.</p>																																	
Error Decision Conditions	<p>Refrigerant shortage detection I: The following conditions continue for 7 minutes.</p> <ul style="list-style-type: none"> ◆ Input current × input voltage ≤ A × output frequency + B ◆ Output frequency > C <table border="1" style="width: 100%; text-align: center;"> <thead> <tr> <th></th> <th>A (-)</th> <th>B (W)</th> <th>C (Hz)</th> </tr> </thead> <tbody> <tr> <td>20/25 class</td> <td>828/256</td> <td>-10</td> <td>50</td> </tr> <tr> <td>35 class</td> <td>777/256</td> <td>-15</td> <td>50</td> </tr> </tbody> </table> <p>Refrigerant shortage detection II: The following conditions continue for 80 seconds.</p> <ul style="list-style-type: none"> ◆ Opening of the electronic expansion valve ≥ D ◆ Discharge pipe temperature > E × target discharge pipe temperature + F <table border="1" style="width: 100%; text-align: center;"> <thead> <tr> <th colspan="2"></th> <th>D (pulse)</th> <th>E (-)</th> <th>F (°C)</th> </tr> </thead> <tbody> <tr> <td rowspan="2">20/25 class</td> <td>Cooling</td> <td rowspan="2">470</td> <td>190/128</td> <td>-7</td> </tr> <tr> <td>Heating</td> <td>211/128</td> <td>-11</td> </tr> <tr> <td rowspan="2">35 class</td> <td>Cooling</td> <td rowspan="2">470</td> <td>160/128</td> <td>-1.5</td> </tr> <tr> <td>Heating</td> <td>172/128</td> <td>-8</td> </tr> </tbody> </table> <ul style="list-style-type: none"> ■ If the error repeats, the system is shut down. ■ Reset condition: Continuous run for about 60 minutes without any other error 		A (-)	B (W)	C (Hz)	20/25 class	828/256	-10	50	35 class	777/256	-15	50			D (pulse)	E (-)	F (°C)	20/25 class	Cooling	470	190/128	-7	Heating	211/128	-11	35 class	Cooling	470	160/128	-1.5	Heating	172/128	-8
	A (-)	B (W)	C (Hz)																															
20/25 class	828/256	-10	50																															
35 class	777/256	-15	50																															
		D (pulse)	E (-)	F (°C)																														
20/25 class	Cooling	470	190/128	-7																														
	Heating		211/128	-11																														
35 class	Cooling	470	160/128	-1.5																														
	Heating		172/128	-8																														
Supposed Causes	<ul style="list-style-type: none"> ■ Disconnection of the discharge pipe thermistor, indoor or outdoor heat exchanger thermistor, room or outdoor temperature thermistor ■ Closed stop valve ■ Refrigerant shortage (refrigerant leakage) ■ Poor compression performance of compressor ■ Defective electronic expansion valve 																																	

Troubleshooting

Check No.01
 Refer to P.85

Check No.12
 Refer to P.87

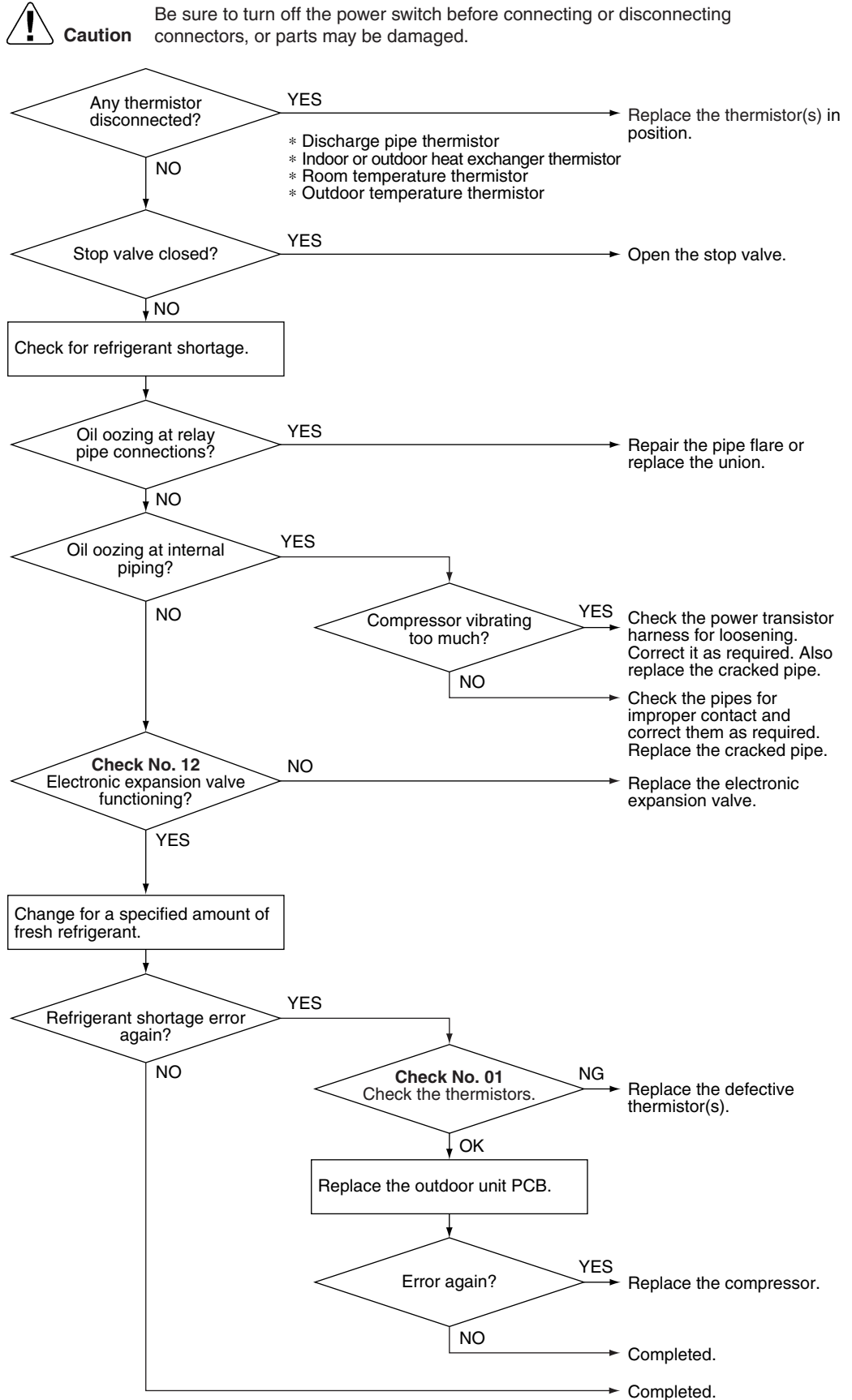

(R18930)

4.7 Low-voltage Detection or Over-voltage Detection

Error Code	U2
Method of Error Detection	<p>Low-voltage detection: An abnormal voltage drop is detected by the DC voltage detection circuit.</p> <p>Over-voltage detection: An abnormal voltage rise is detected by the over-voltage detection circuit.</p>
Error Decision Conditions	<p>Low-voltage detection:</p> <ul style="list-style-type: none"> ■ The voltage detected by the DC voltage detection circuit is below 180 V. ■ The compressor stops if the error occurs, and restarts automatically after 3-minute standby. <p>Over-voltage detection:</p> <ul style="list-style-type: none"> ■ An over-voltage signal is fed from the over-voltage detection circuit to the microcomputer. ■ The compressor stops if the error occurs, and restarts automatically after 3-minute standby.
Supposed Causes	<ul style="list-style-type: none"> ■ Power supply voltage is not as specified. ■ Defective DC voltage detection circuit ■ Defective over-voltage detection circuit ■ Defective PAM control part ■ Disconnection of compressor harness ■ Short circuit inside the fan motor winding ■ Noise ■ Momentary fall of voltage ■ Momentary power failure ■ Defective outdoor unit PCB

Troubleshooting

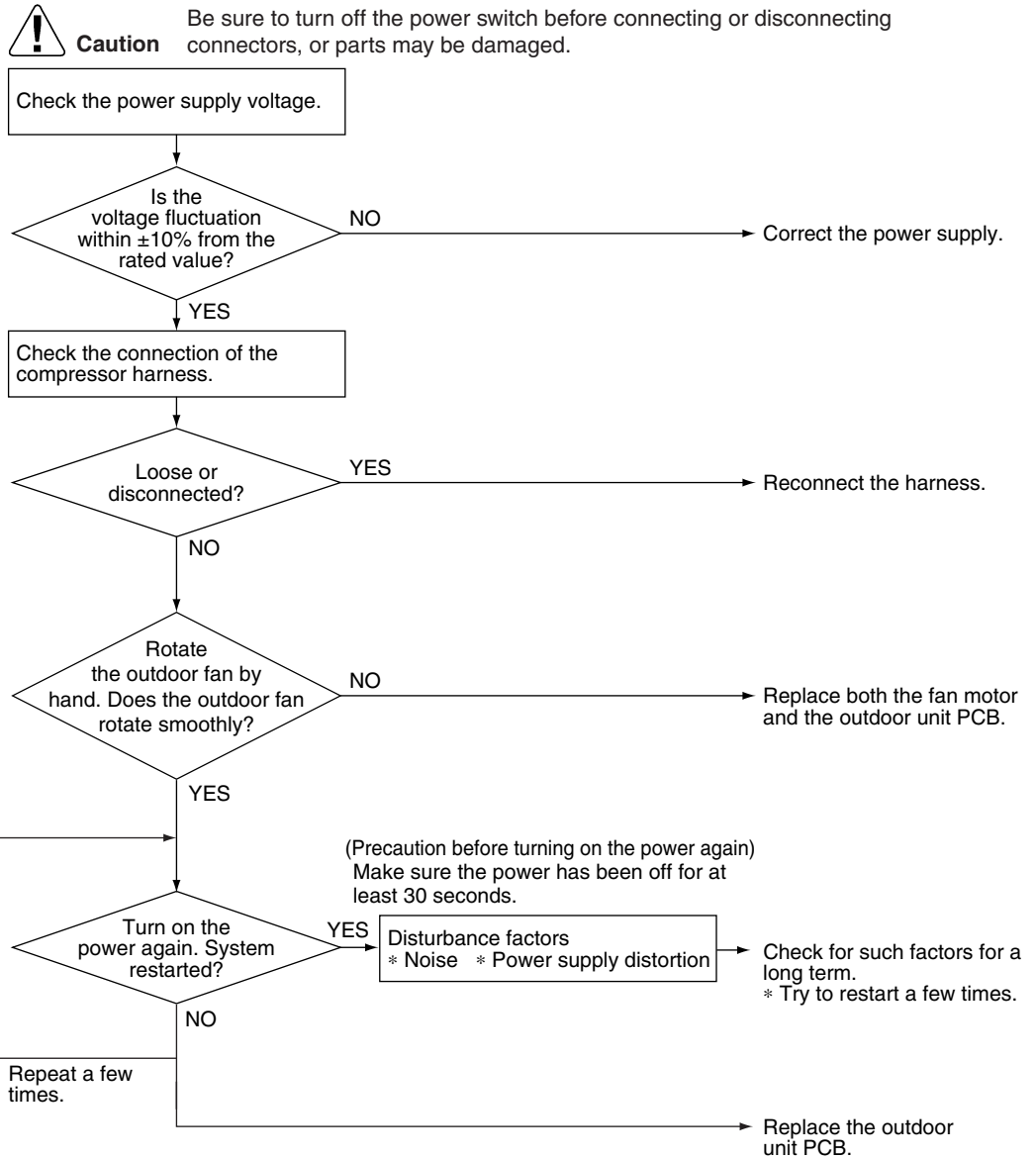

(R19100)

4.8 Signal Transmission Error (between Indoor Unit and Outdoor Unit)

Error Code	U4
Method of Error Detection	The data received from the outdoor unit in signal transmission is checked whether it is normal.
Error Decision Conditions	The data sent from the outdoor unit cannot be received normally, or the content of the data is abnormal.
Supposed Causes	<ul style="list-style-type: none">■ Reduction of power supply voltage■ Wiring error■ Breaking of the connection wires between the indoor and outdoor units (wire No. 3)■ Defective outdoor unit PCB■ Short circuit inside the fan motor winding■ Defective indoor unit PCB■ Disturbed power supply waveform

Troubleshooting



Check No.11
Refer to P.87

**Caution**

Be sure to turn off the power switch before connecting or disconnecting connectors, or parts may be damaged.

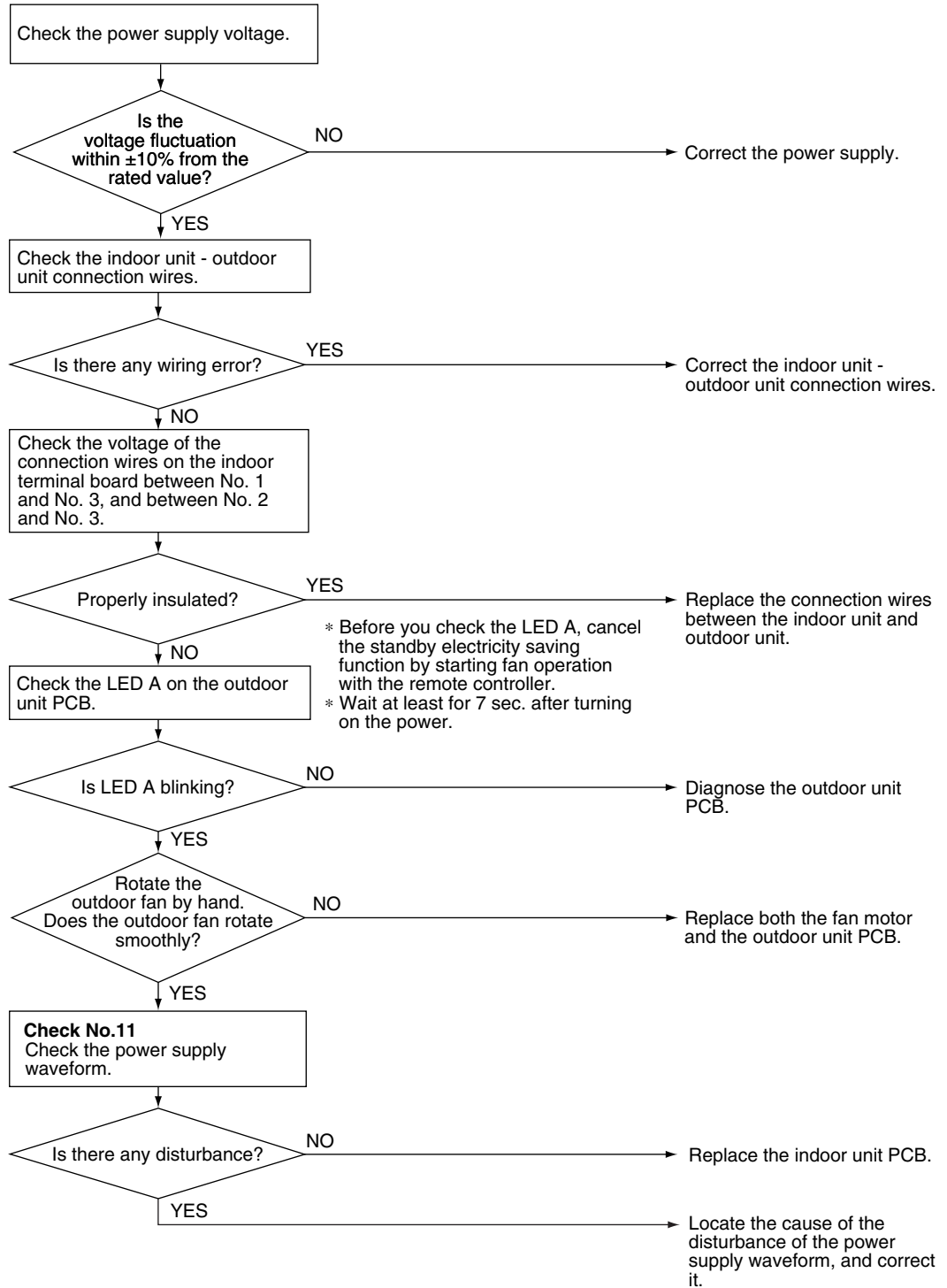

(R18180)

4.9 Unspecified Voltage (between Indoor Unit and Outdoor Unit)

Error Code	U9
Method of Error Detection	The supply power is detected for its requirements (different from pair type and multi type) by the indoor / outdoor transmission signal.
Error Decision Conditions	The pair type and multi type are interconnected.
Supposed Causes	<ul style="list-style-type: none"> ■ Wrong models interconnected ■ Wrong wiring of connecting wires ■ Wrong indoor unit PCB or outdoor unit PCB mounted ■ Defective indoor unit PCB ■ Defective outdoor unit PCB

Troubleshooting

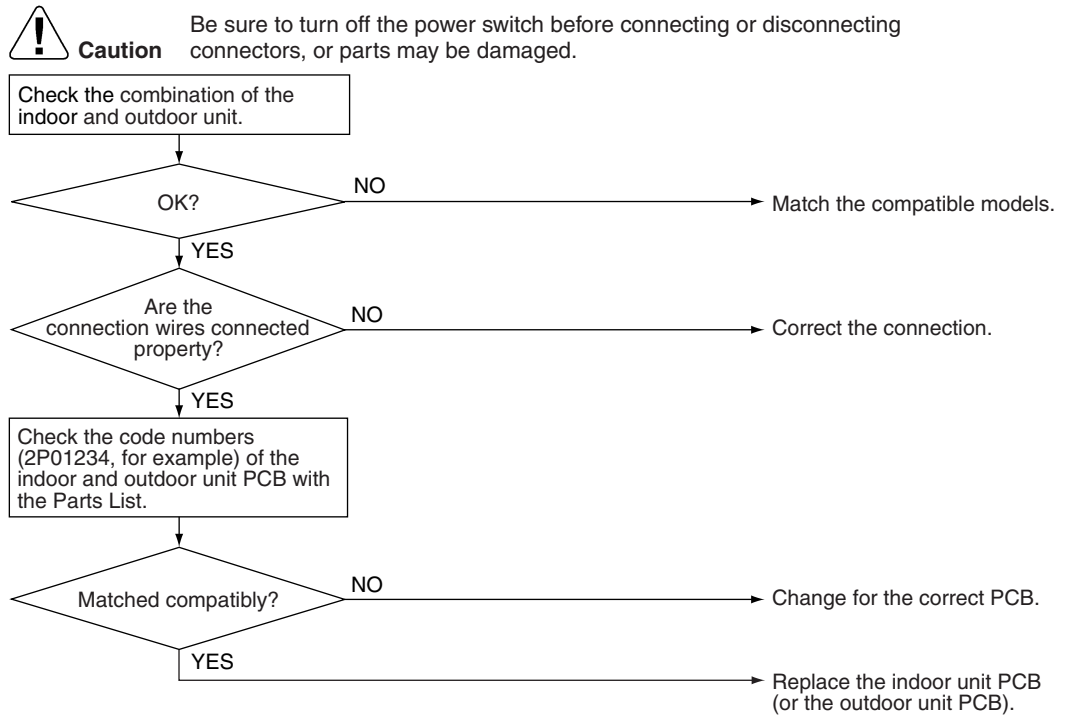

(R11707)

4.10 Outdoor Unit PCB Abnormality

Error Code **E1**

Method of Error Detection

- The system checks if the microprocessor is working in order.
- The system checks if the zero-cross signal comes in properly.

Error Decision Conditions

- The microprocessor program runs out of control.
- The zero-cross signal is not detected.

Supposed Causes

- Defective outdoor unit PCB
- Broken harness between PCBs
- Noise
- Momentary fall of voltage
- Momentary power failure

Troubleshooting

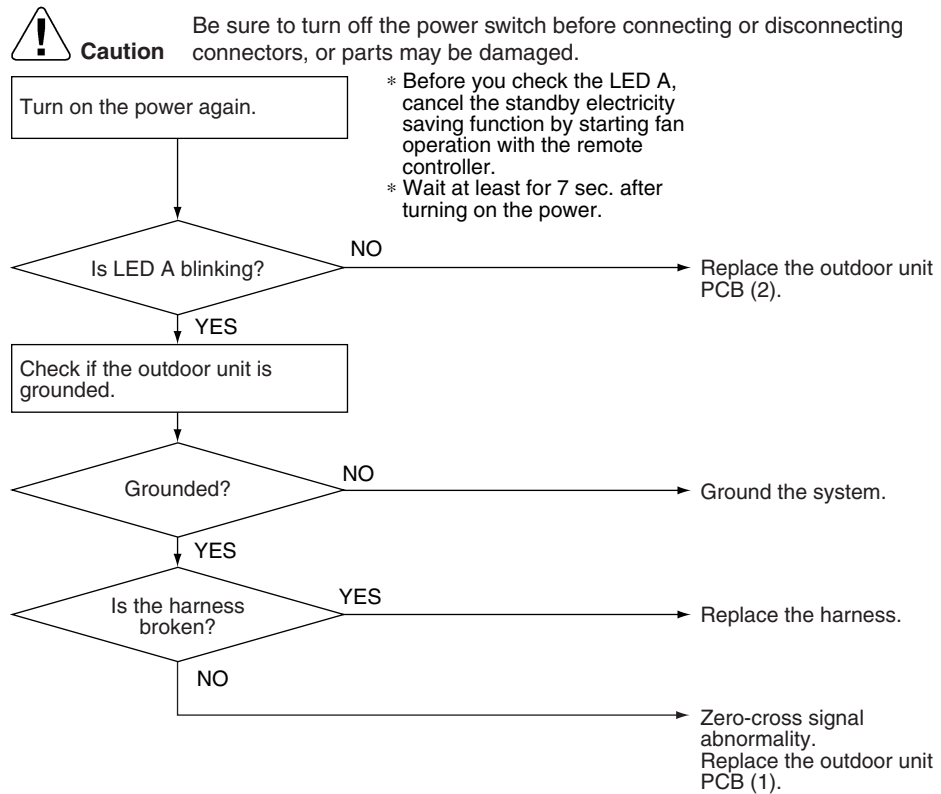

4.11 OL Activation (Compressor Overload)

Error Code	E5
Method of Error Detection	A compressor overload is detected through overload protector (OL).
Error Decision Conditions	<ul style="list-style-type: none">■ If the error repeats, the system is shut down.■ Reset condition: Continuous run for about 60 minutes without any other error
Supposed Causes	<ul style="list-style-type: none">■ Disconnection of discharge pipe thermistor■ Defective discharge pipe thermistor■ Disconnection of connector [S40]■ Disconnection of 2 terminals of OL (Q1L)■ Defective OL (Q1L)■ Broken OL harness■ Defective electronic expansion valve or coil■ Defective four way valve or coil■ Defective outdoor unit PCB■ Refrigerant shortage■ Water mixed in refrigerant■ Defective stop valve

Troubleshooting



Check No.01
Refer to P.85



Check No.12
Refer to P.87



Check No.13
Refer to P.88



Check No.14
Refer to P.88

**Caution**

Be sure to turn off the power switch before connecting or disconnecting connectors, or parts may be damaged.

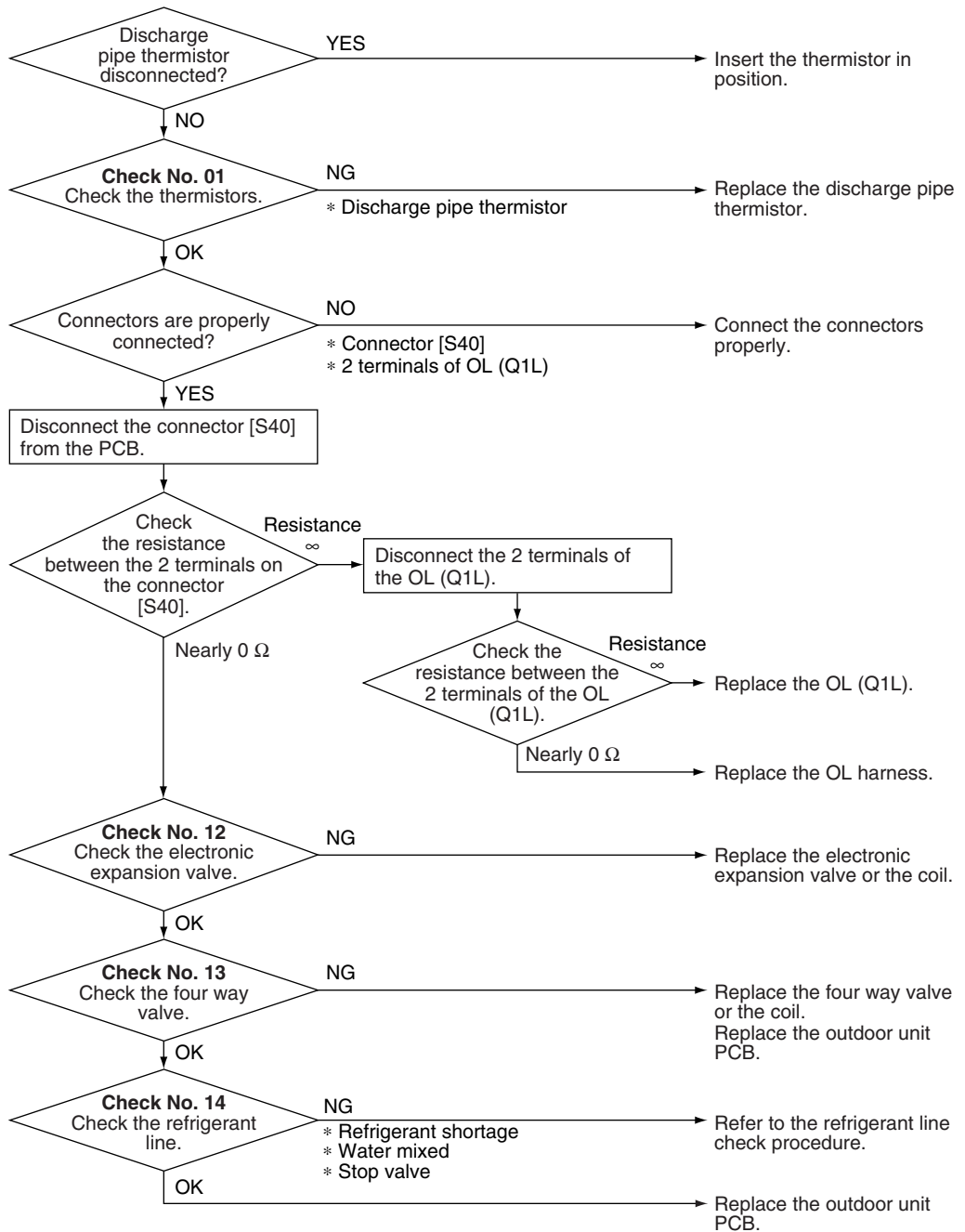

(R18316)

**Note:**

OL (Q1L) activating temperature: 120°C
OL (Q1L) recovery temperature: 95°C

4.12 Compressor Lock

Error Code	EE
Method of Error Detection	A compressor lock is detected by checking the compressor running condition through the position detection circuit.
Error Decision Conditions	<ul style="list-style-type: none"> ■ Operation stops due to overcurrent. ■ If the error repeats, the system is shut down. ■ Reset condition: Continuous run for about 11 minutes without any other error
Supposed Causes	<ul style="list-style-type: none"> ■ Compressor locked ■ Compressor harness disconnected

Troubleshooting

Check No.15
 Refer to P.89

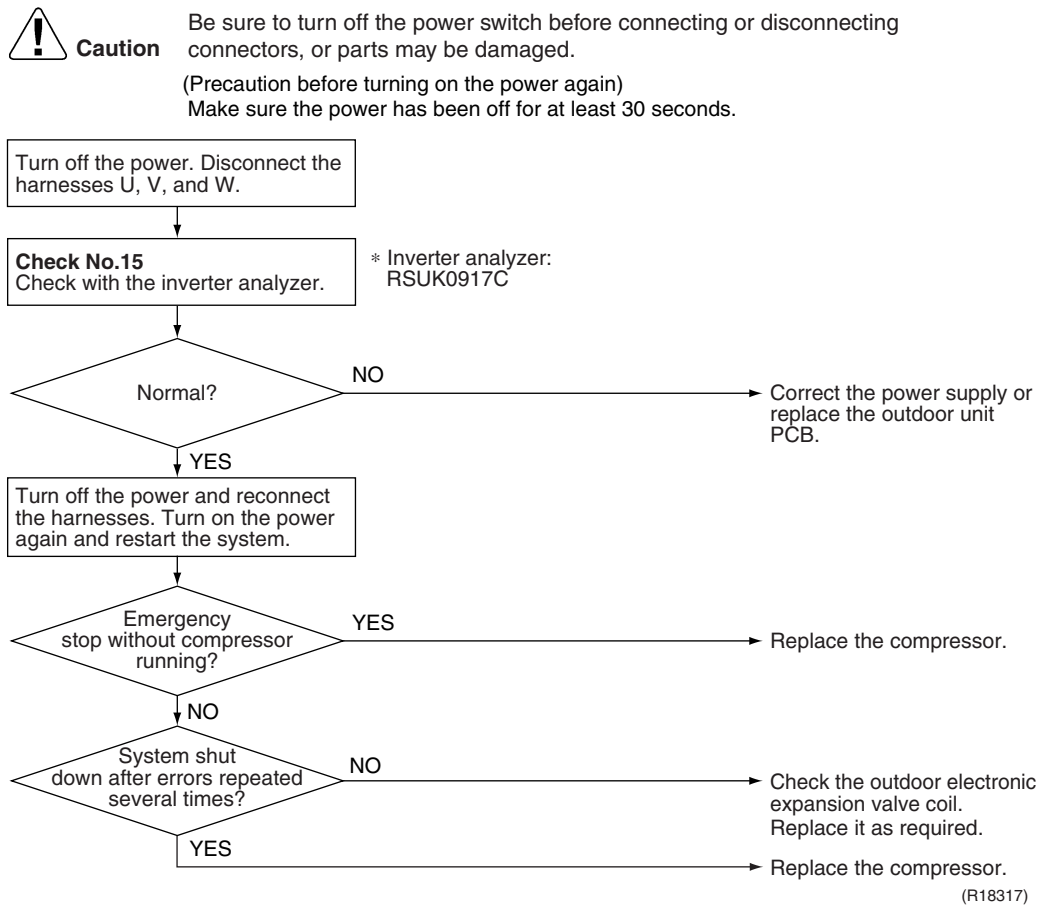

4.13 DC Fan Lock

Error Code	E7
Method of Error Detection	An error is determined with the high-voltage fan motor rotation speed detected by the Hall IC.
Error Decision Conditions	<ul style="list-style-type: none"> ■ The fan does not start in about 15 ~ 60 seconds even when the fan motor is running. ■ If the error repeats, the system is shut down. ■ Reset condition: Continuous run for about 11 minutes without any other error
Supposed Causes	<ul style="list-style-type: none"> ■ Disconnection of the fan motor ■ Foreign matter stuck in the fan ■ Defective fan motor ■ Defective outdoor unit PCB

Troubleshooting

Check No.16
 Refer to P.90

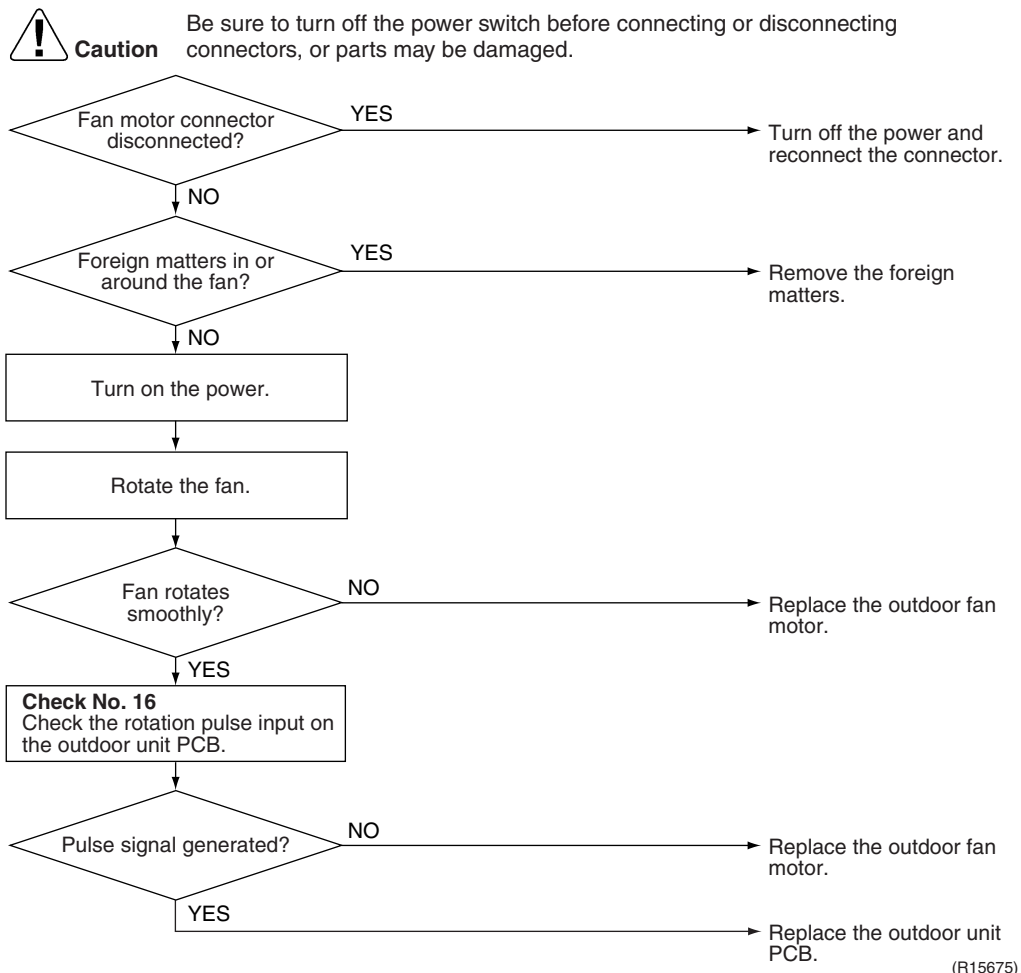

4.14 Input Overcurrent Detection

Error Code	E8
Method of Error Detection	An input overcurrent is detected by checking the input current value with the compressor running.
Error Decision Conditions	The current exceeds about 14 A for 2.5 seconds with the compressor running. (The upper limit of the current decreases when the outdoor temperature exceeds a certain level.)
Supposed Causes	<ul style="list-style-type: none"> ■ Power supply voltage is not as specified. ■ Outdoor temperature is out of operation range. ■ Short circuit ■ Power supply voltage is not as specified. ■ Defective outdoor unit PCB ■ Defective compressor ■ Defective power module

Troubleshooting

Check No.15
 Refer to P.89

Check No.17
 Refer to P.91

Check No.18
 Refer to P.91

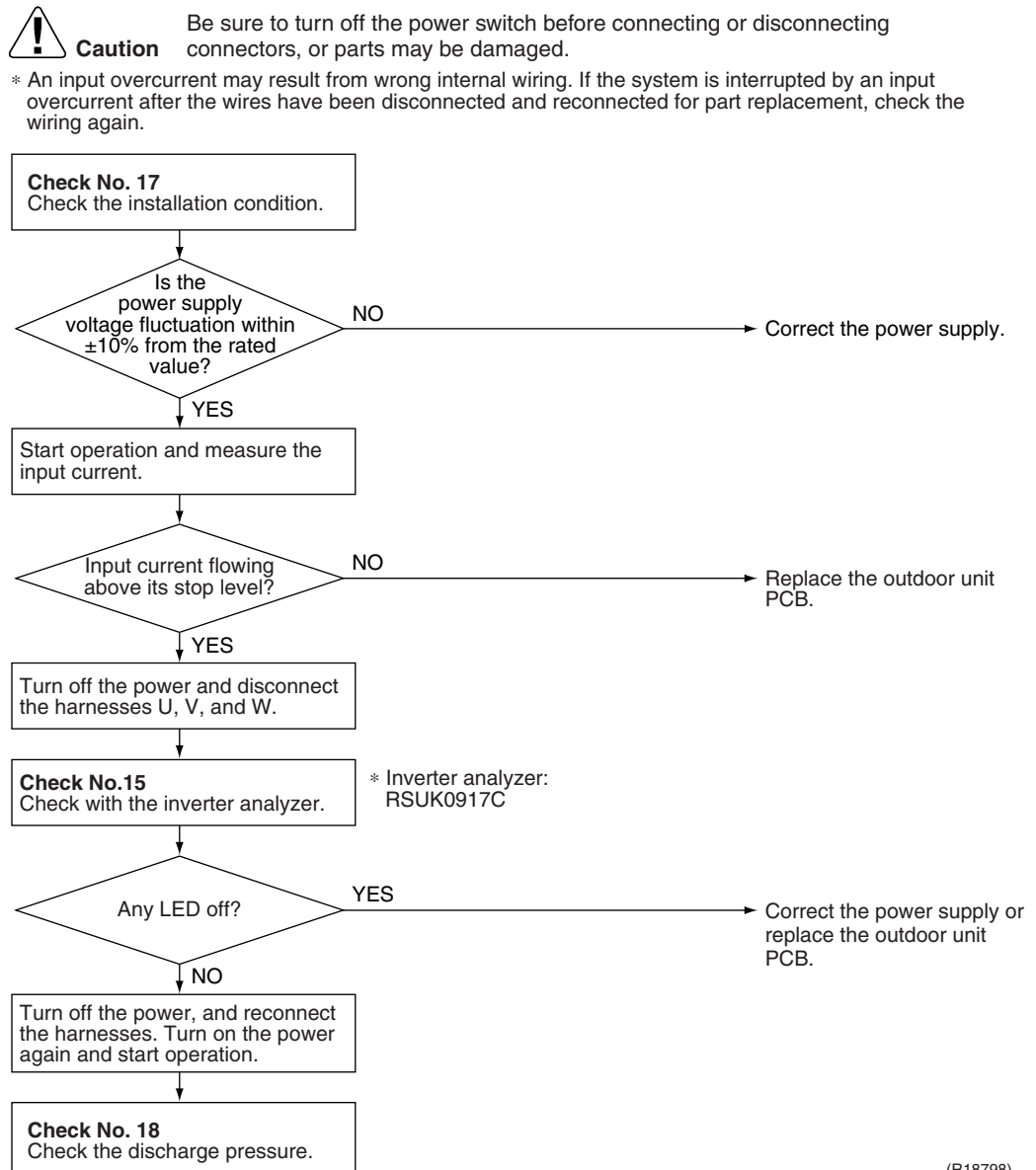

(R18798)

4.15 Four Way Valve Abnormality

Error Code	E8
Method of Error Detection	The room temperature thermistor and the indoor heat exchanger thermistor are checked if they function within their normal ranges in each operation mode.
Error Decision Conditions	<p>A following condition continues over 10 minutes after operating for 5 minutes.</p> <ul style="list-style-type: none"> ■ Cooling / Dry <ul style="list-style-type: none"> A – B < -5°C ■ Heating <ul style="list-style-type: none"> B – A < -5°C <p>A: Room thermistor temperature B: Indoor heat exchanger temperature</p> <ul style="list-style-type: none"> ■ If the error repeats, the system is shut down. ■ Reset condition: Continuous run for about 60 minutes without any other error
Supposed Causes	<ul style="list-style-type: none"> ■ Disconnection of four way valve coil ■ Defective four way valve, coil, or harness ■ Defective outdoor unit PCB ■ Defective thermistor ■ Refrigerant shortage ■ Water mixed in refrigerant ■ Defective stop valve

Troubleshooting

Check No.01
 Refer to P.85

Check No.13
 Refer to P.88

Check No.14
 Refer to P.88

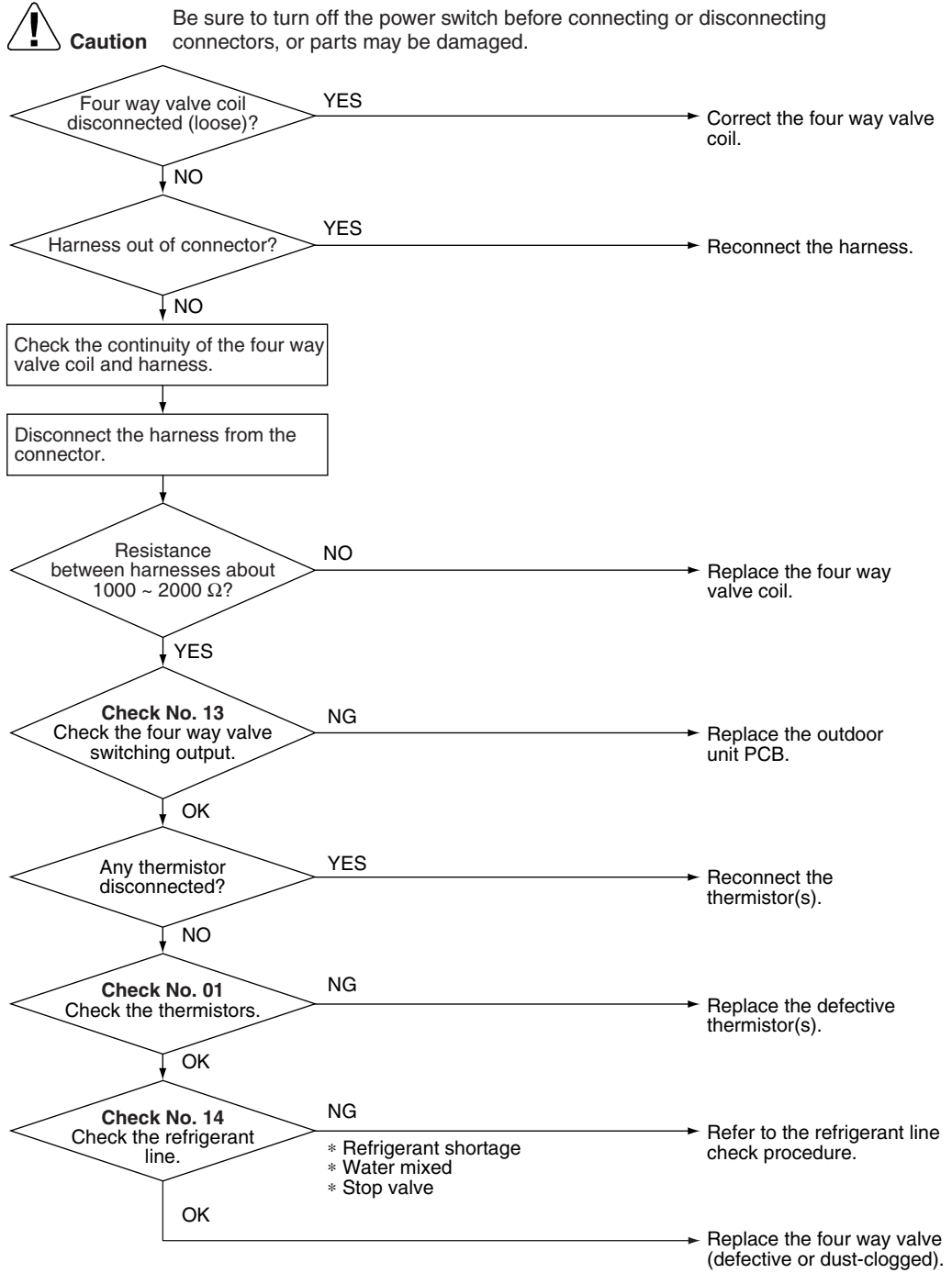



(R15824)

4.16 Discharge Pipe Temperature Control

Error Code	F3												
Method of Error Detection	An error is determined with the temperature detected by the discharge pipe thermistor.												
Error Decision Conditions	<ul style="list-style-type: none"> ■ If the temperature detected by the discharge pipe thermistor rises above A°C, the compressor stops. ■ The error is cleared when the discharge pipe temperature has dropped below B°C. <table border="1"> <thead> <tr> <th></th> <th>A (°C)</th> <th>B (°C)</th> </tr> </thead> <tbody> <tr> <td>(1) above 45 Hz (rising), above 40 Hz (dropping)</td> <td>110</td> <td>97</td> </tr> <tr> <td>(2) 30 ~ 45 Hz (rising), 25 ~ 40 Hz (dropping)</td> <td>105</td> <td>92</td> </tr> <tr> <td>(3) below 30 Hz (rising), below 25 Hz (dropping)</td> <td>99</td> <td>86</td> </tr> </tbody> </table> <ul style="list-style-type: none"> ■ If the error repeats, the system is shut down. ■ Reset condition: Continuous run for about 60 minutes without any other error 		A (°C)	B (°C)	(1) above 45 Hz (rising), above 40 Hz (dropping)	110	97	(2) 30 ~ 45 Hz (rising), 25 ~ 40 Hz (dropping)	105	92	(3) below 30 Hz (rising), below 25 Hz (dropping)	99	86
	A (°C)	B (°C)											
(1) above 45 Hz (rising), above 40 Hz (dropping)	110	97											
(2) 30 ~ 45 Hz (rising), 25 ~ 40 Hz (dropping)	105	92											
(3) below 30 Hz (rising), below 25 Hz (dropping)	99	86											
Supposed Causes	<ul style="list-style-type: none"> ■ Defective discharge pipe thermistor (Defective outdoor heat exchanger thermistor or outdoor temperature thermistor) ■ Defective electronic expansion valve or coil ■ Refrigerant shortage ■ Defective four way valve ■ Water mixed in refrigerant ■ Defective stop valve ■ Defective outdoor unit PCB 												

Troubleshooting



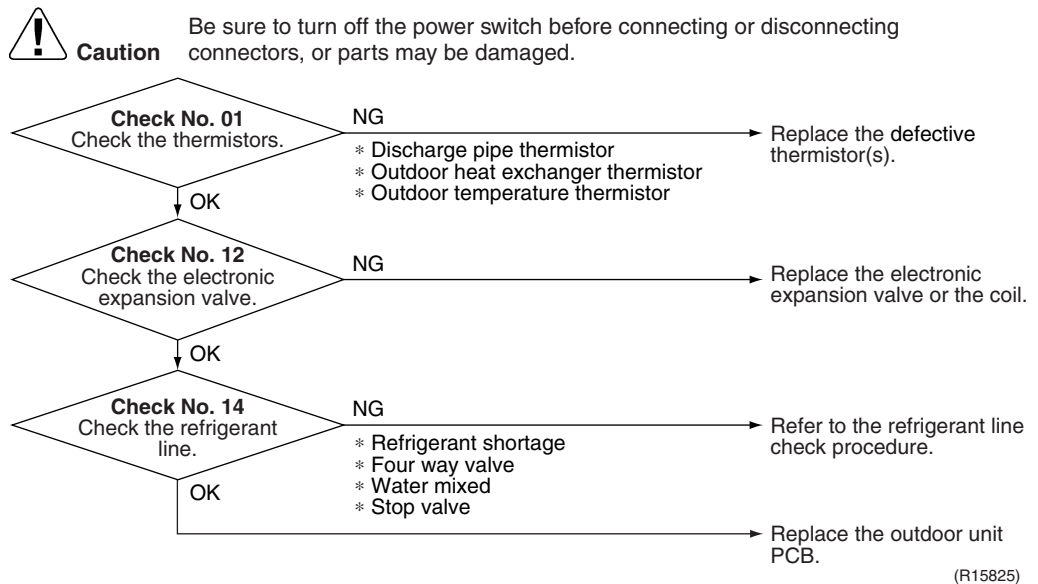

-  **Check No.01**
Refer to P.85
-  **Check No.12**
Refer to P.87
-  **Check No.14**
Refer to P.88



4.17 High Pressure Control in Cooling

Error Code	F6
Method of Error Detection	High-pressure control (operation halt, frequency drop, etc.) is activated in cooling operation if the temperature sensed by the outdoor heat exchanger thermistor exceeds the limit.
Error Decision Conditions	<ul style="list-style-type: none"> ■ The temperature sensed by the outdoor heat exchanger thermistor rises above about 60°C. ■ The error is cleared when the temperature drops below about 50°C.
Supposed Causes	<ul style="list-style-type: none"> ■ The installation space is not large enough. ■ Dirty outdoor heat exchanger ■ Defective outdoor fan motor ■ Defective stop valve ■ Defective electronic expansion valve or coil ■ Defective outdoor heat exchanger thermistor ■ Defective outdoor unit PCB

Troubleshooting

-  **Check No.01**
Refer to P.85
-  **Check No.12**
Refer to P.87
-  **Check No.17**
Refer to P.91
-  **Check No.18**
Refer to P.91
-  **Check No.19**
Refer to P.92

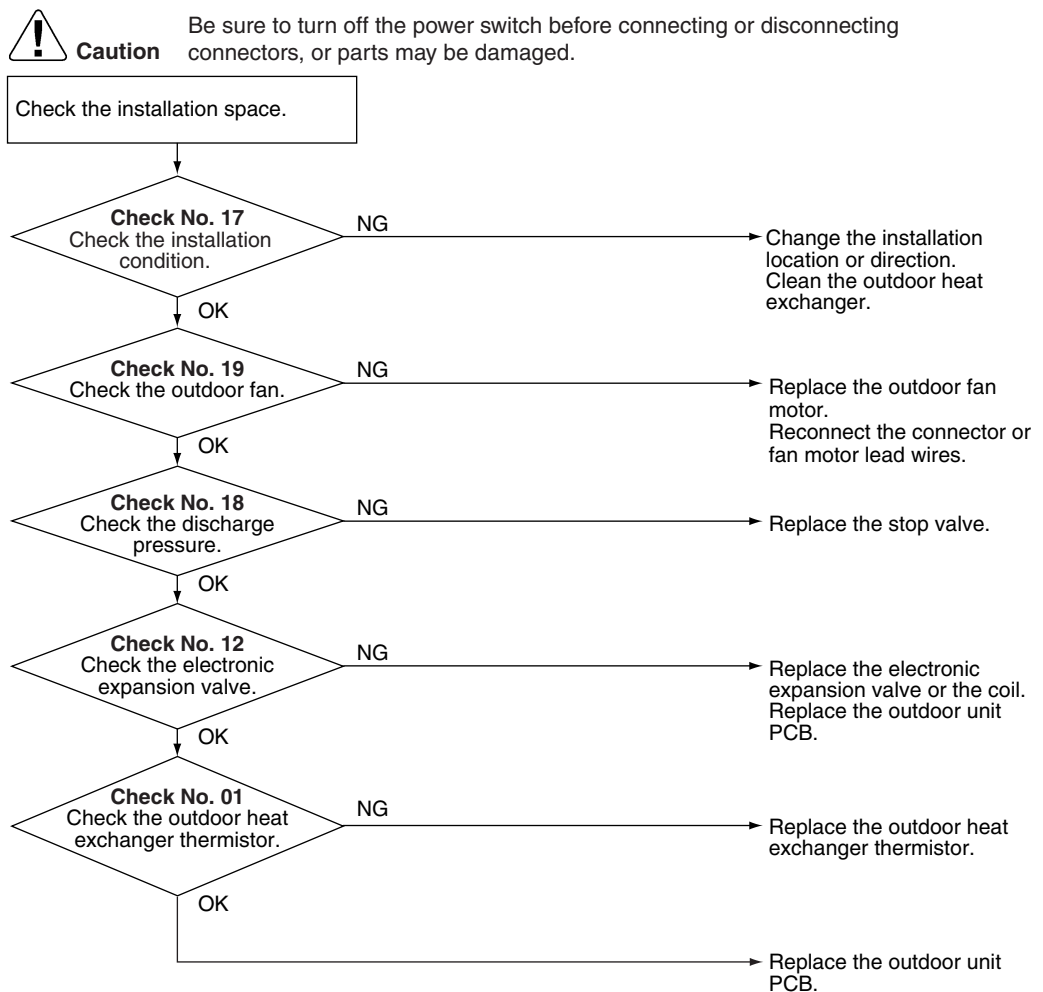

(R15667)

4.18 Compressor System Sensor Abnormality

Error Code	H0
Method of Error Detection	<ul style="list-style-type: none"> ■ The system checks the DC current before the compressor starts.
Error Decision Conditions	<ul style="list-style-type: none"> ■ The DC current before compressor start-up is out of the range 0.5 ~ 4.5 V (sensor output converted to voltage value) ■ The DC voltage before compressor start-up is below 50 V.
Supposed Causes	<ul style="list-style-type: none"> ■ Broken or disconnected harness ■ Defective outdoor unit PCB
Troubleshooting	

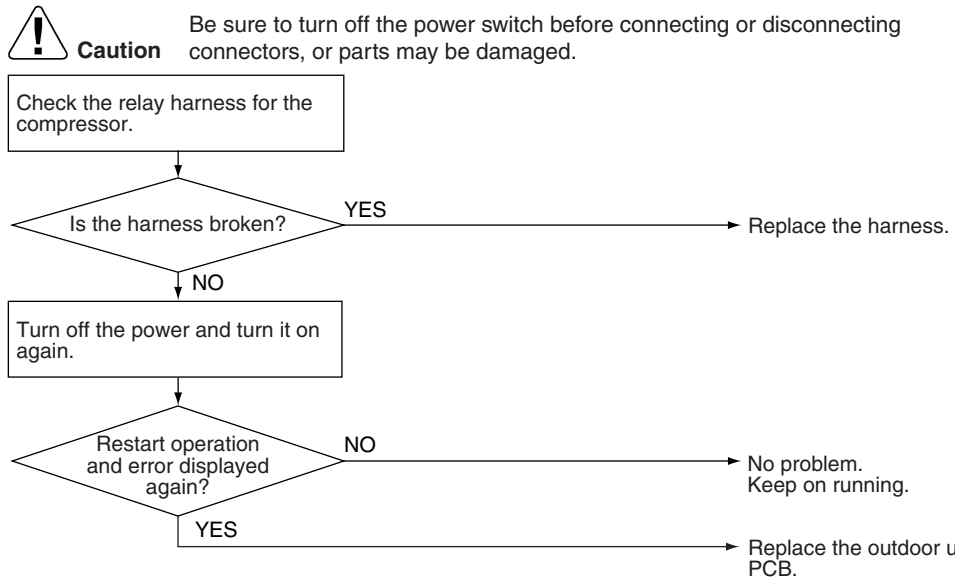

(R11712)

4.19 Position Sensor Abnormality

Error Code	H6
Method of Error Detection	A compressor start-up failure is detected by checking the compressor running condition through the position detection circuit.
Error Decision Conditions	<ul style="list-style-type: none">■ If the error repeats, the system is shut down.■ Reset condition: Continuous run for about 11 minutes without any other error
Supposed Causes	<ul style="list-style-type: none">■ Power supply voltage is not as specified.■ Start-up failure caused by the closed stop valve■ Defective outdoor unit PCB■ Disconnection of the compressor relay cable■ Input voltage is outside the specified range.■ Defective compressor

Troubleshooting

Check No.15
 Refer to P.89

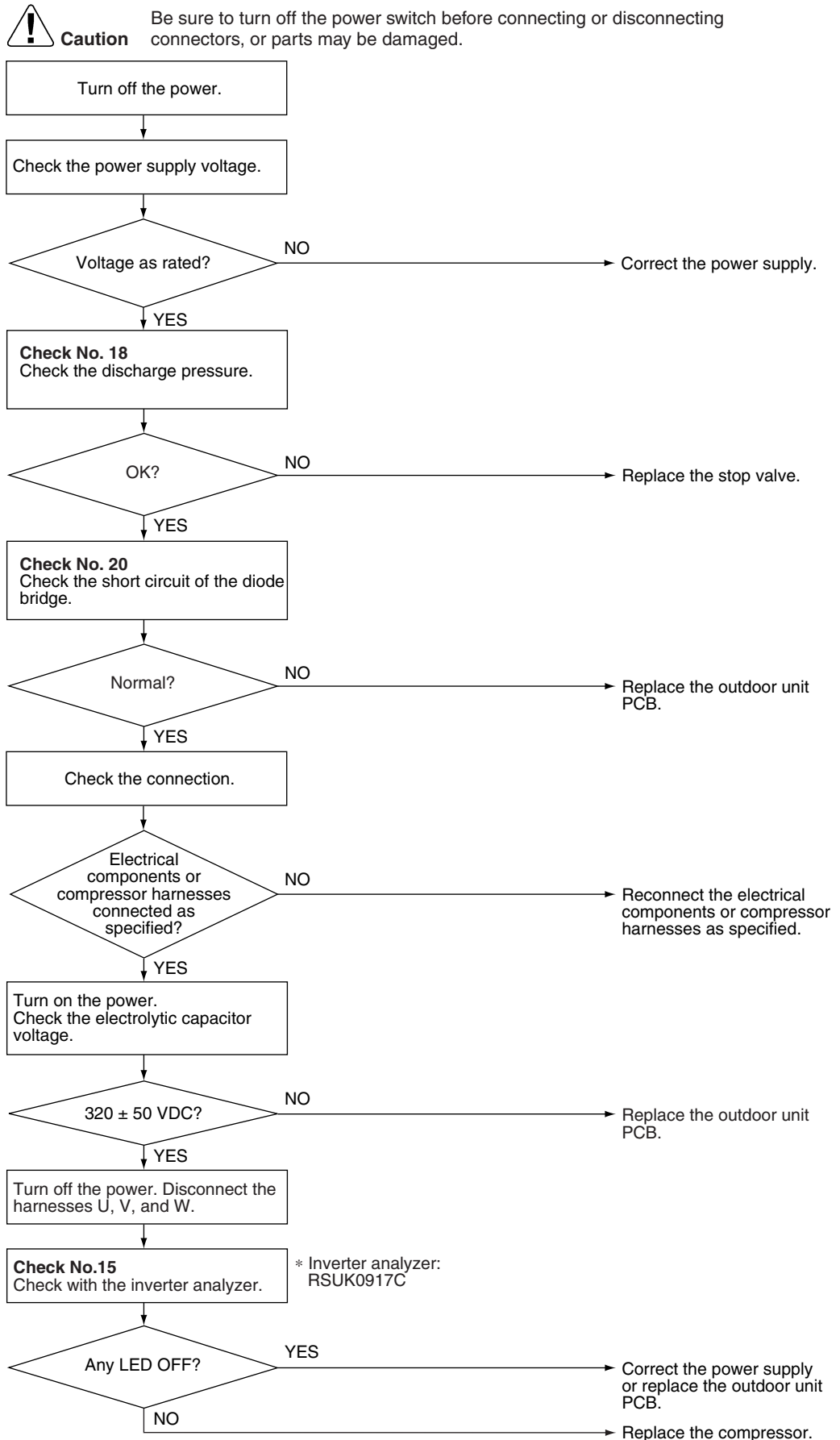

Check No.18
 Refer to P.91

Check No.20
 Refer to P.92



(R18319)

4.20 DC Voltage / Current Sensor Abnormality

Error Code	H2
Method of Error Detection	DC voltage or DC current sensor abnormality is identified based on the compressor running frequency and the input current.
Error Decision Conditions	<ul style="list-style-type: none"> ■ The compressor running frequency is above 52 Hz. (The input current is also below 0.1 A.) ■ If the error repeats, the system is shut down. ■ Reset condition: Continuous run for about 60 minutes without any other error
Supposed Causes	<ul style="list-style-type: none"> ■ Defective outdoor unit PCB
Troubleshooting	<p> Caution Be sure to turn off the power switch before connecting or disconnecting connectors, or parts may be damaged.</p> <p>Replace the outdoor unit PCB.</p>

4.21 Thermistor or Related Abnormality (Outdoor Unit)

Error Code	<i>H3, U3, U5, P4</i>
Method of Error Detection	This fault is identified based on the thermistor input voltage to the microcomputer. A thermistor fault is identified based on the temperature sensed by each thermistor.
Error Decision Conditions	<ul style="list-style-type: none"> ■ The thermistor input voltage is above 4.96 V or below 0.04 V with the power on. ■ <i>U3</i> error is judged if the discharge pipe temperature is lower than the heat exchanger temperature.
Supposed Causes	<ul style="list-style-type: none"> ■ Disconnection of the connector for the thermistor ■ Thermistor corresponding to the error code is defective ■ Defective heat exchanger thermistor in the case of <i>U3</i> error (outdoor heat exchanger thermistor in cooling operation, or indoor heat exchanger thermistor in heating operation) ■ Defective outdoor unit PCB
Troubleshooting	<p>In case of “<i>P4</i>”</p> <p> Caution Be sure to turn off the power switch before connecting or disconnecting connectors, or parts may be damaged.</p> <p>Replace the outdoor unit PCB.</p> <p><i>P4</i> : Radiation fin thermistor</p>

Troubleshooting



Check No.01
 Refer to P.85

In case of "H3" "J3" "J5"

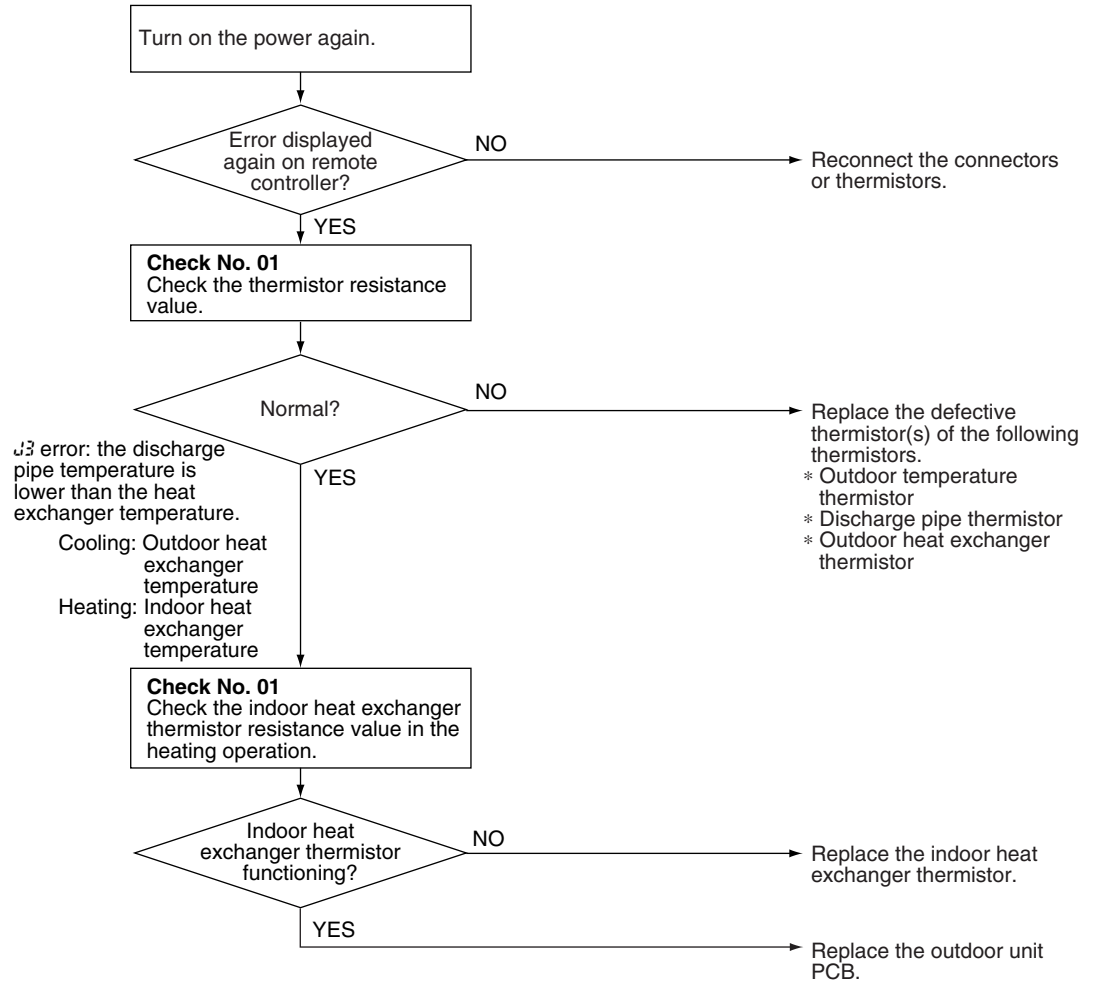

Caution

Be sure to turn off the power switch before connecting or disconnecting connectors, or parts may be damaged.



J3 error: the discharge pipe temperature is lower than the heat exchanger temperature.
 Cooling: Outdoor heat exchanger temperature
 Heating: Indoor heat exchanger temperature

(R16059)

- H3 : Outdoor temperature thermistor
- J3 : Discharge pipe thermistor
- J5 : Outdoor heat exchanger thermistor

4.22 Electrical Box Temperature Rise

Error Code	L3						
Method of Error Detection	An electrical box temperature rise is detected by checking the radiation fin thermistor with the compressor off.						
Error Decision Conditions	<ul style="list-style-type: none"> ■ With the compressor off, the radiation fin temperature is above A°C. ■ The error is cleared when the radiation fin temperature drops below B°C. ■ To cool the electrical components, the outdoor fan starts when the radiation fin temperature rises above C°C and stops when it drops below B°C. <table border="1" style="width: 100%; text-align: center;"> <thead> <tr> <th>A (°C)</th> <th>B (°C)</th> <th>C (°C)</th> </tr> </thead> <tbody> <tr> <td>93</td> <td>70</td> <td>78</td> </tr> </tbody> </table>	A (°C)	B (°C)	C (°C)	93	70	78
A (°C)	B (°C)	C (°C)					
93	70	78					
Supposed Causes	<ul style="list-style-type: none"> ■ Defective outdoor fan motor ■ Short circuit ■ Defective radiation fin thermistor ■ Disconnection of connector ■ Defective outdoor unit PCB 						

Troubleshooting

Check No.17
Refer to P.91

Check No.19
Refer to P.92

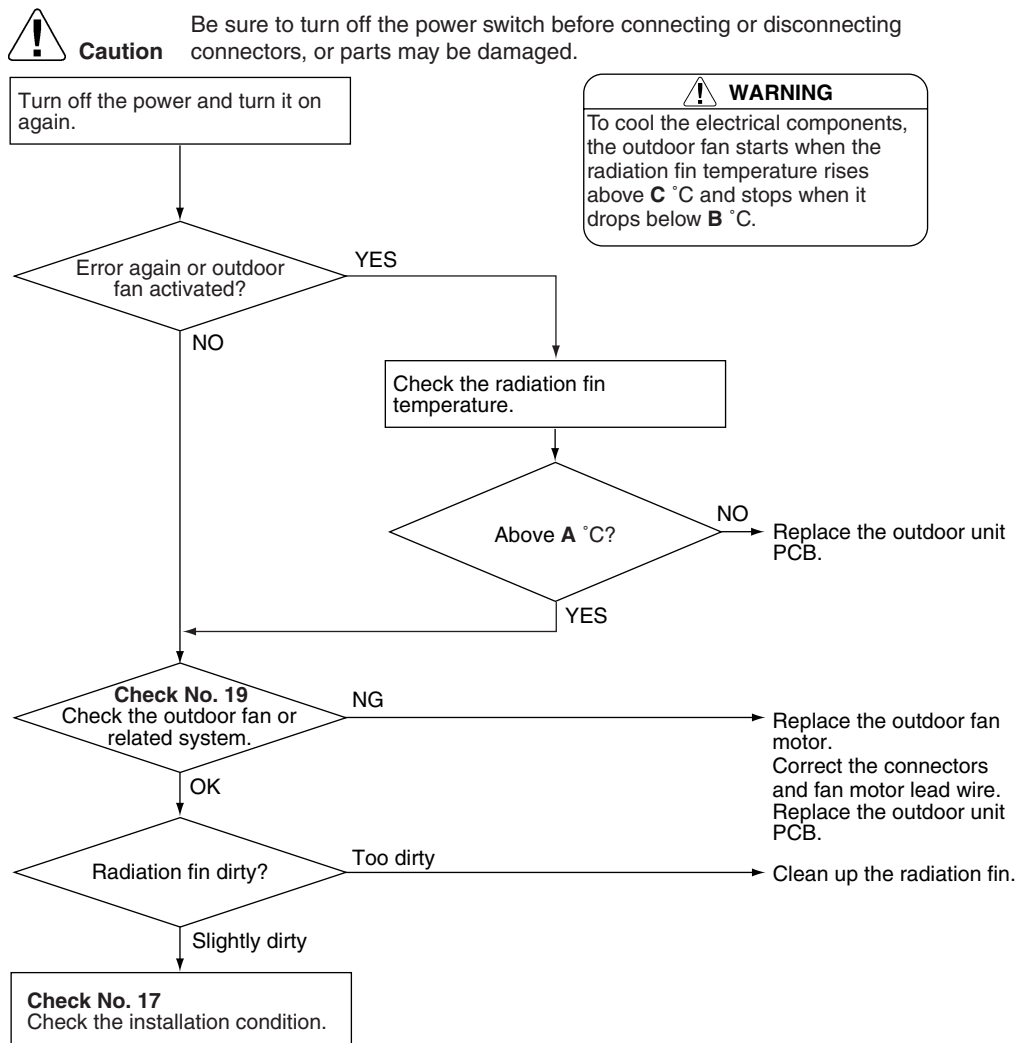

(R19118)

4.23 Radiation Fin Temperature Rise

Error Code L4

Method of Error Detection A radiation fin temperature rise is detected by checking the radiation fin thermistor with the compressor on.

- Error Decision Conditions**
- If the radiation fin temperature with the compressor on is above **A**°C.
 - The error is cleared when the radiation fin temperature drops below **B**°C.
 - If the error repeats, the system is shut down.
 - Reset condition: Continuous run for about 60 minutes without any other error

A (°C)	B (°C)
93	78

- Supposed Causes**
- Defective outdoor fan motor
 - Short circuit
 - Defective radiation fin thermistor
 - Disconnection of connector
 - Defective outdoor unit PCB
 - Silicon grease is not applied properly on the radiation fin after replacing the outdoor unit PCB.

Troubleshooting

Check No.17
 Refer to P.91

Check No.19
 Refer to P.92



Caution Be sure to turn off the power switch before connecting or disconnecting connectors, or parts may be damaged.

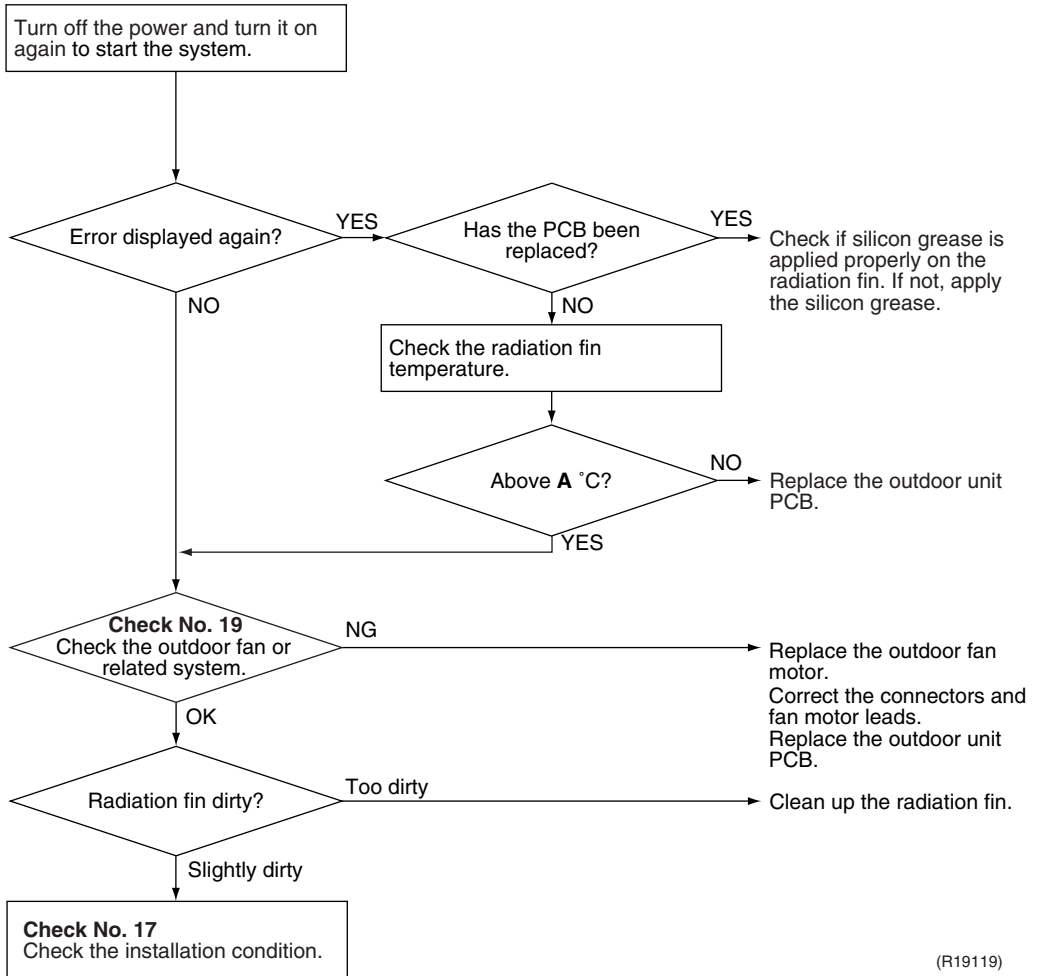

(R19119)

A (°C)
93



Note: Refer to “Silicon Grease on Power Transistor / Diode Bridge” on page 98 for detail.

4.24 Output Overcurrent Detection

Error CodeU5

Method of Error Detection

An output overcurrent is detected by checking the current that flows in the inverter DC section.

Error Decision Conditions

- A position signal error occurs while the compressor is running.
 - A rotation speed error occurs while the compressor is running.
 - An output overcurrent signal is fed from the output overcurrent detection circuit to the microcomputer.
 - If the error repeats, the system is shut down.
 - Reset condition: Continuous run for about 11 minutes without any other error
-

Supposed Causes

- Poor installation condition
- Closed stop valve
- Defective power module
- Wrong internal wiring
- Abnormal power supply voltage
- Defective outdoor unit PCB
- Defective compressor

Troubleshooting

Check No.15
Refer to P.89

Check No.17
Refer to P.91

Check No.18
Refer to P.91



Check No.22
Refer to P.93



Caution

Be sure to turn off the power switch before connecting or disconnecting connectors, or parts may be damaged.

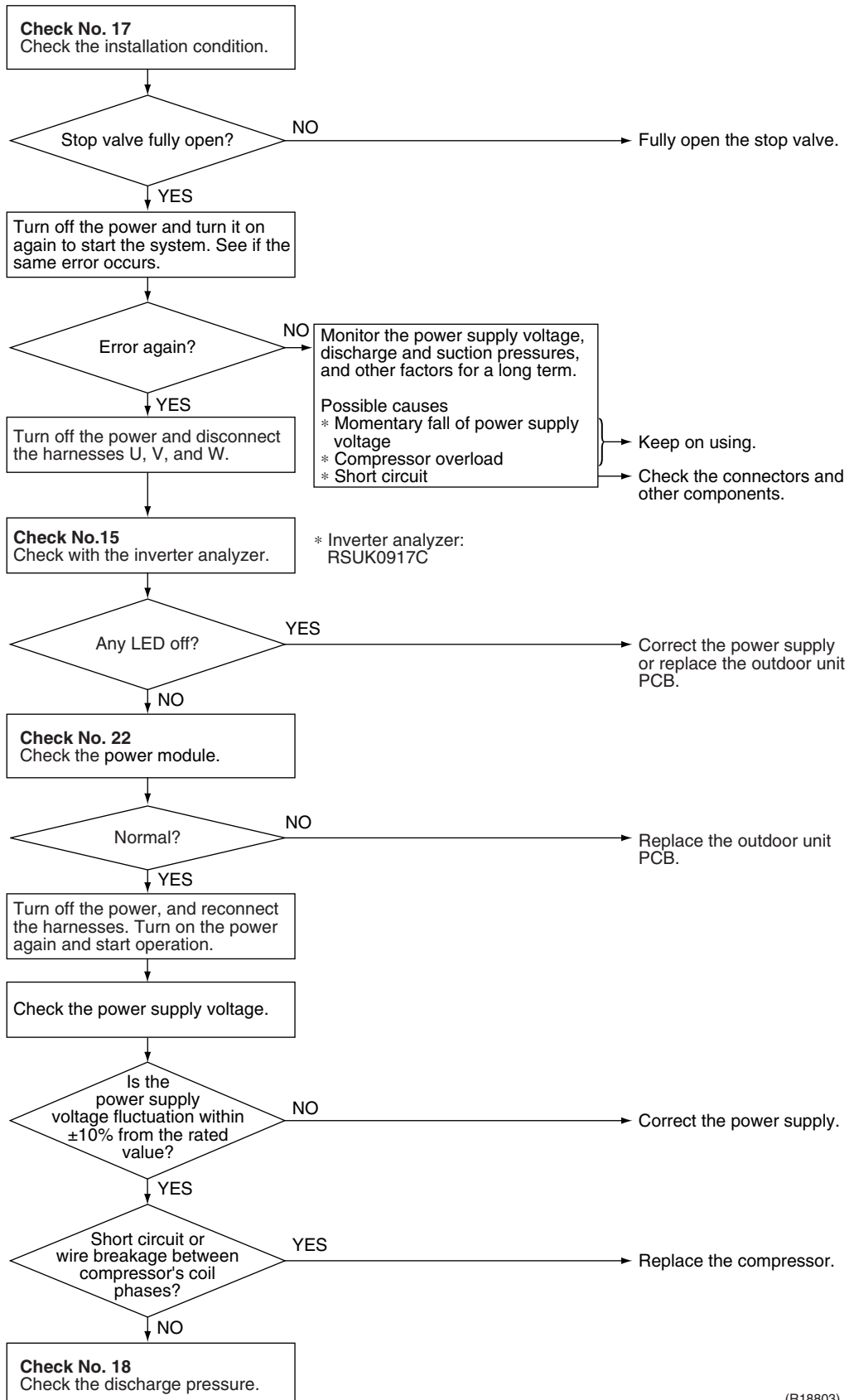
* An output overcurrent may result from wrong internal wiring. If the system is interrupted by an output overcurrent after the wires have been disconnected and reconnected for part replacement, check the wiring again.



(R18803)

5. Check

5.1 Thermistor Resistance Check

Check No.01

Disconnect the connectors of the thermistors from the PCB, and measure the resistance of each thermistor using tester.

The data is for reference purpose only.

Thermistor temperature (°C)	Resistance (kΩ)	
	Room temperature thermistor	Other thermistors
-20	73.4	197.8
-15	57.0	148.2
-10	44.7	112.1
-5	35.3	85.60
0	28.2	65.93
5	22.6	51.14
10	18.3	39.99
15	14.8	31.52
20	12.1	25.02
25	10.0	20.00
30	8.2	16.10
35	6.9	13.04
40	5.8	10.62
45	4.9	8.707
50	4.1	7.176

(R25°C = 10 kΩ, B = 3435 K) (R25°C = 20 kΩ, B = 3950 K)

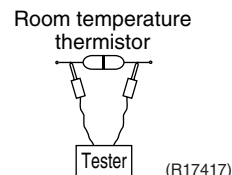
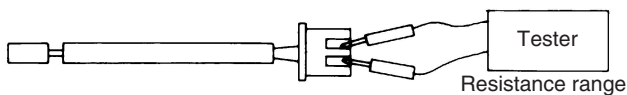
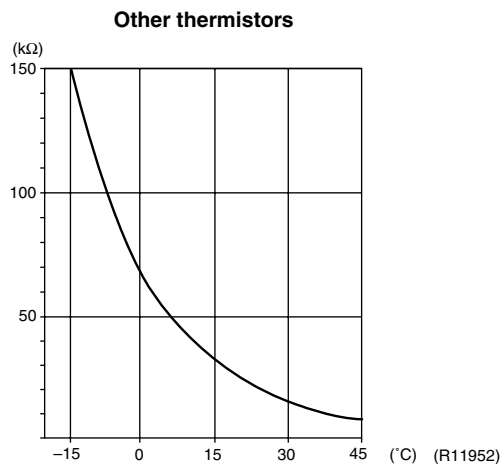
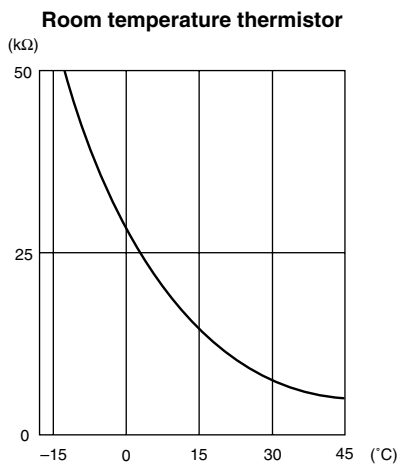

(R18296)

(R17417)

- When the room temperature thermistor is soldered on a PCB, remove the PCB from the control PCB to measure the resistance.
- When the connector of indoor heat exchanger thermistor is soldered on a PCB, remove the thermistor and measure the resistance.

5.2 Fan Motor Connector Output Check

Check No.03

- ◆ Fan motor wire breakdown / short circuit check
 1. Check the connector for connection.
 2. Turn the power off.
 3. Check if each resistance at the phases U - V and V - W is $90 \Omega \sim 100 \Omega$ (between the pins 12 - 9, and between 9 - 6).

- ◆ Motor control voltage check
 1. Check the connector for connection.
 2. Check the motor control voltage is generated (between the pins 2 - 3).

- ◆ Rotation pulse check
 1. Check the connector for connection.
 2. Turn the power on and stop the operation.
 3. Check if the Hall IC generates the rotation pulse 4 times when the fan motor is manually rotated once (between the pins 1 - 3).

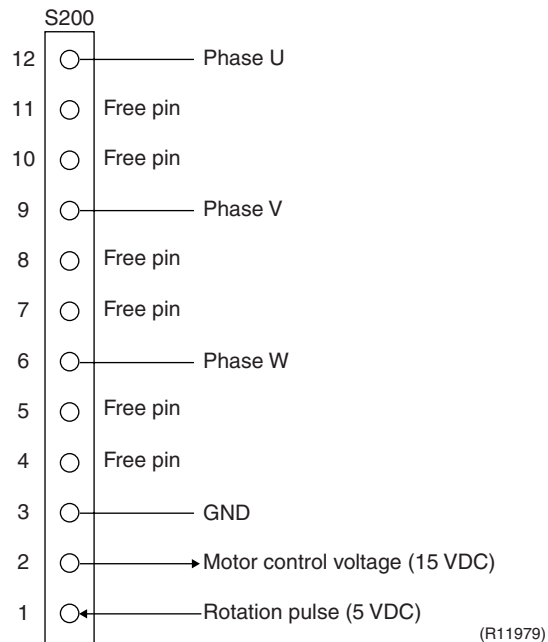

5.3 Power Supply Waveforms Check

Check No.11

Measure the power supply waveform between No. 1 and No. 2 on the terminal board, and check the waveform disturbance.

- Check if the power supply waveform is a sine wave. (Fig.1)
- Check if there is waveform disturbance near the zero cross. (sections circled in Fig.2)

Fig.1

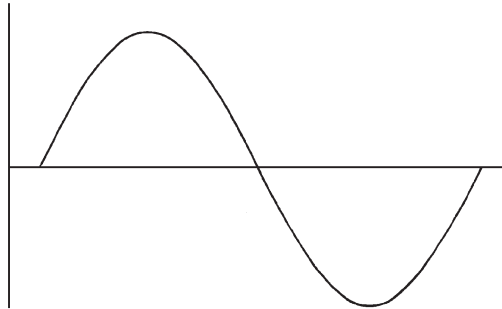

(R1736)

Fig.2

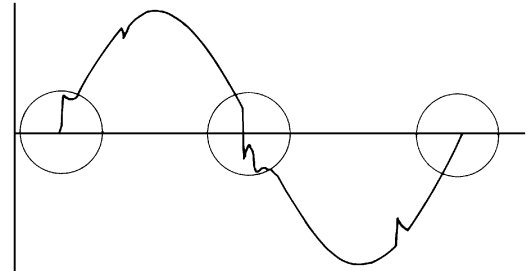

(R1444)

5.4 Electronic Expansion Valve Check

Check No.12

Conduct the followings to check the electronic expansion valve (EV).

1. Check if the EV connector is correctly connected to the PCB.
2. Turn the power off and on again, and check if the EV generates a latching sound.
3. If the EV does not generate a latching sound in the above step 2, disconnect the connector and check the continuity using a tester.
4. Check the continuity between the pins 1 - 6, 3 - 6, 2 - 5, 4 - 5 (between the pins 1 - 6, 2 - 6, 3 - 6, 4 - 6 for the harness 5P models). If there is no continuity between the pins, the EV coil is faulty.
5. If the continuity is confirmed in step 3, the outdoor unit PCB is faulty.

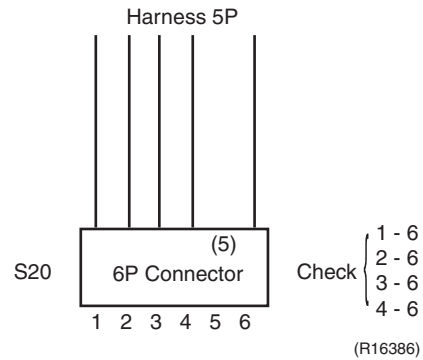
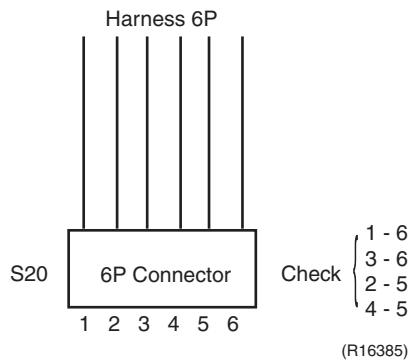

Note: Please note that the latching sound varies depending on the valve type.

5.5 Four Way Valve Performance Check

Check No.13

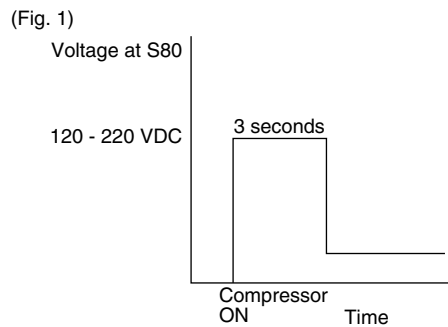
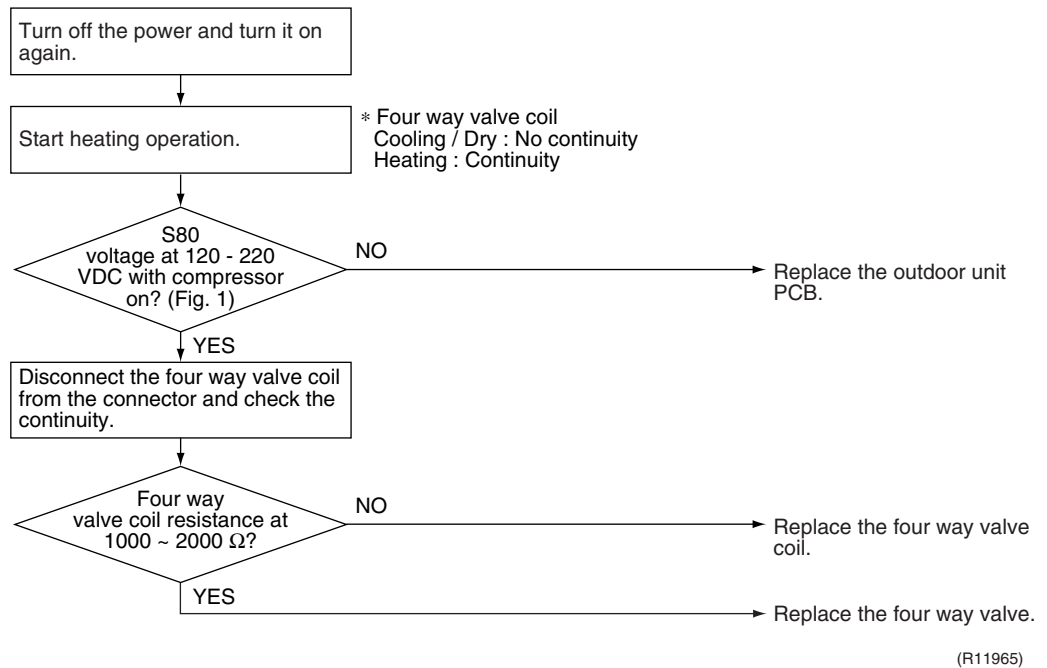

(R19102)

5.6 Inverter Units Refrigerant System Check

Check No.14

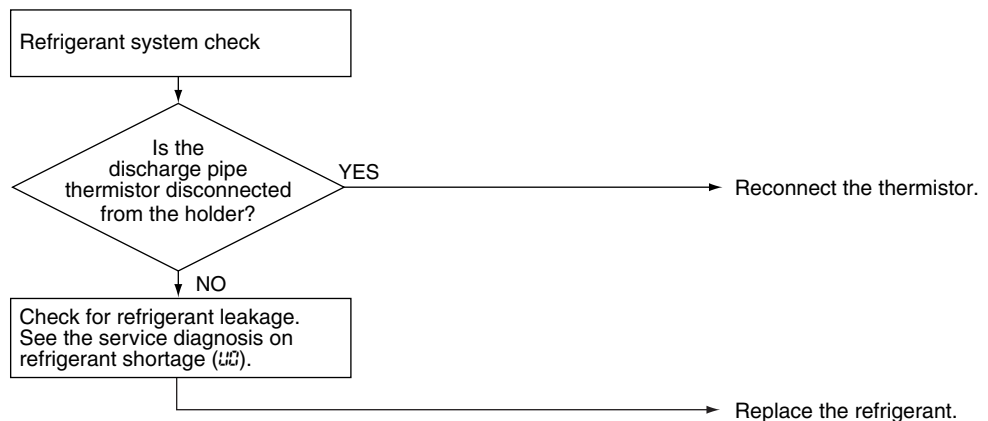

(R15833)

5.7 Inverter Analyzer Check

Check No.15

■ Characteristics

Inverter analyzer: RSUK0917C

If an abnormal stop occurs due to compressor startup failure or overcurrent output when using an inverter unit, it is difficult to judge whether the stop is caused by the compressor failure or some other failure (main PCB, power module, etc.). The inverter analyzer makes it possible to judge the cause of trouble easily and securely. (Connect an inverter analyzer as a quasi-compressor instead of compressor and check the output of the inverter)

■ Operation Method

Step 1

Be sure to turn the power off.

Step 2

Connect an inverter analyzer in place of the compressor.

Note:

Make sure the charged voltage of the built-in smoothing electrolytic capacitor drops to 10 VDC or below before carrying out the service work.

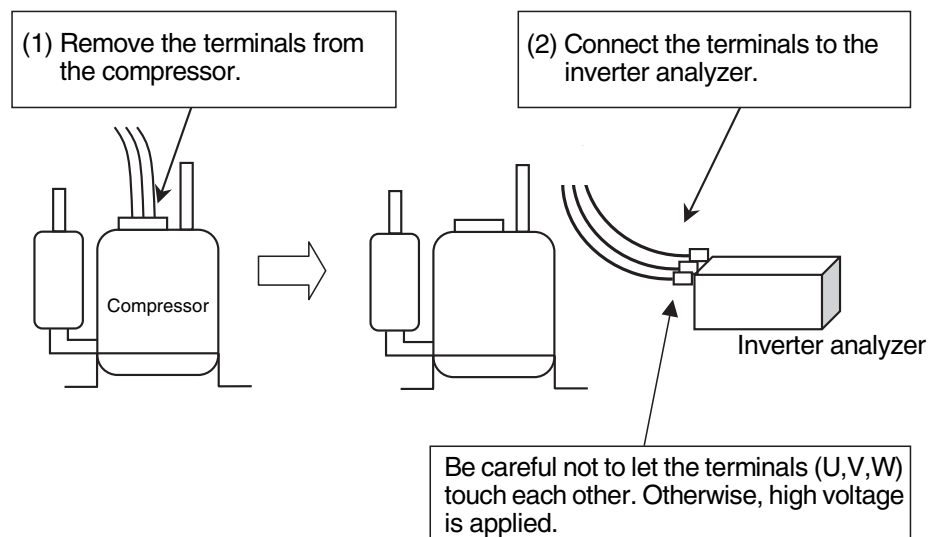

(R18322)

Reference:

If the terminals of the compressor are not FASTON terminals (difficult to remove the wire on the terminals), it is possible to connect wires available on site to the outdoor unit from the output side of the PCB. (Do not connect the wires to the compressor at the same time, otherwise it may result in incorrect detection.)

Step 3

Activate power transistor test operation from the indoor unit with the remote controller.

- (1) Turn the system on.
- (2) Select FAN operation with the [MODE] button on the remote controller.
- (3) Press the center of the [TEMP] button and the [MODE] button at the same time.
→ 00 is displayed with the figure of ten's place blinking.
- (4) Press the [MODE] button.
→ 01 is displayed with the figure of one's place blinking.
- (5) Press the [MODE] button.
→ 7 is displayed.
- (6) Press the [ON/OFF] button.
→ Power transistor test operation starts.

■ **Diagnose method (Diagnose according to 6 LEDs lighting status.)**

- (1) If all the LEDs are lit uniformly, the compressor is defective.
→ Replace the compressor.
- (2) If the LEDs are not lit uniformly, check the power module.
→ Refer to **Check No.22**.
- (3) If NG in **Check No.22**, replace the power module.
(Replace the main PCB. The power module is united with the main PCB.)
If OK in **Check No.22**, check if there is any solder cracking on the PCB.
- (4) If any solder cracking is found, replace the PCB or repair the soldered section.
If there is no solder cracking, replace the PCB.



Caution

- (1) When the output frequency is low, the LEDs blink slowly. As the output frequency increases, the LEDs blink quicker. (The LEDs look like they are lit.)
- (2) On completion of the inverter analyzer diagnosis, be sure to re-crimp the FASTON terminals. Otherwise, the terminals may be burned due to loosening.

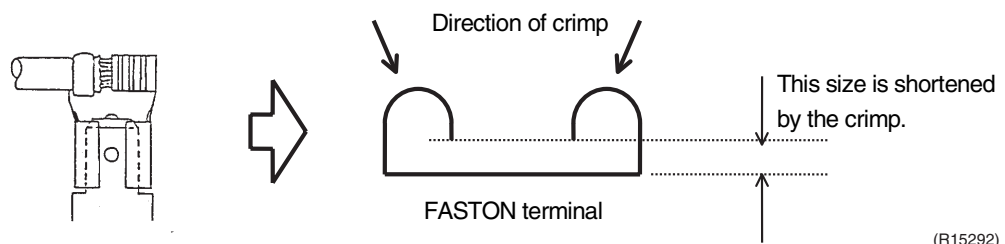

(R15292)

5.8 Rotation Pulse Check on the Outdoor Unit PCB

Check No.16

1. Check that the voltage between the pins 10 - 11 is 15 VDC.
2. Check if the Hall IC generates the rotation pulse (0 ~ 15 VDC) 4 times between the pins 10 - 12, 10 - 13, when the fan motor is manually rotated once.

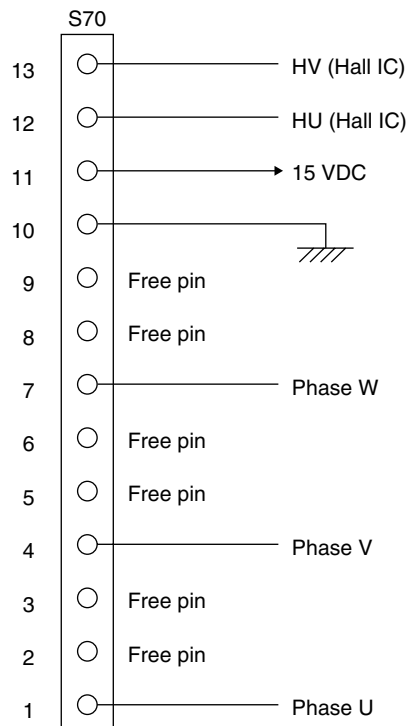

(R11907)

5.9 Installation Condition Check

Check No.17

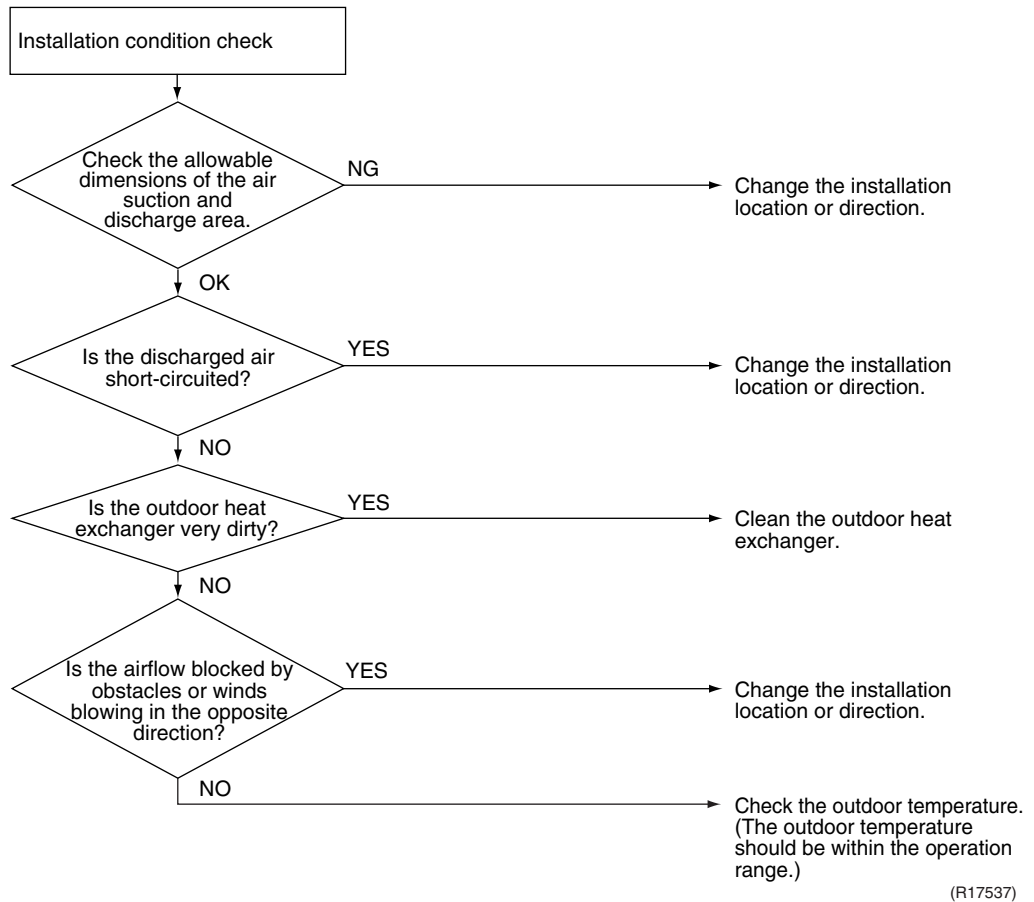

5.10 Discharge Pressure Check

Check No.18

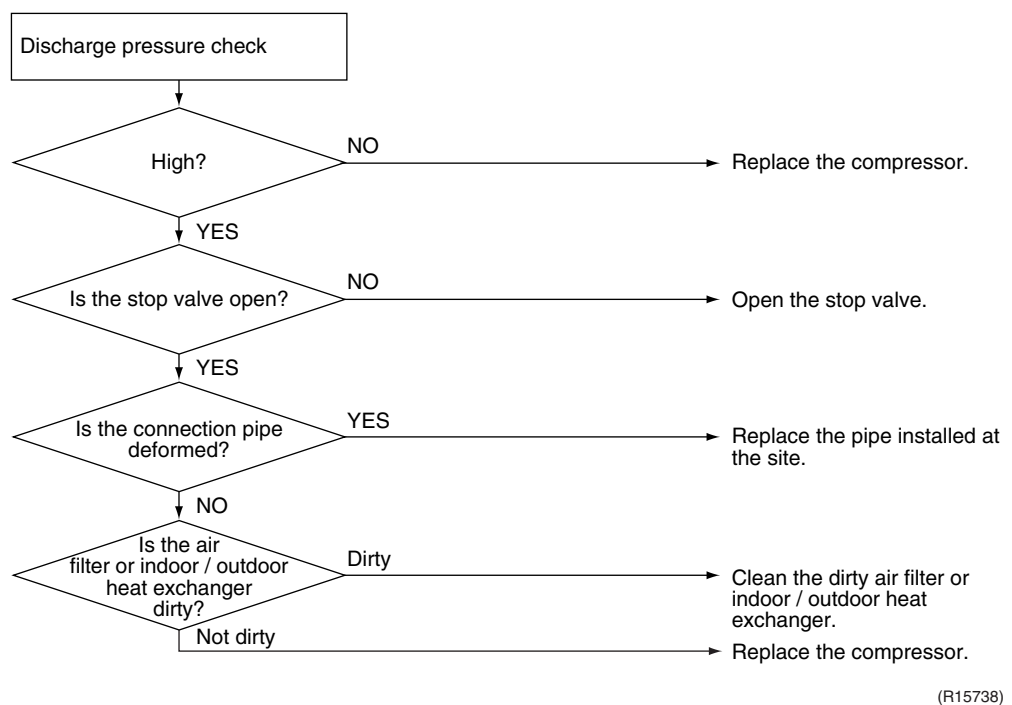

5.11 Outdoor Fan System Check

Check No.19

DC motor

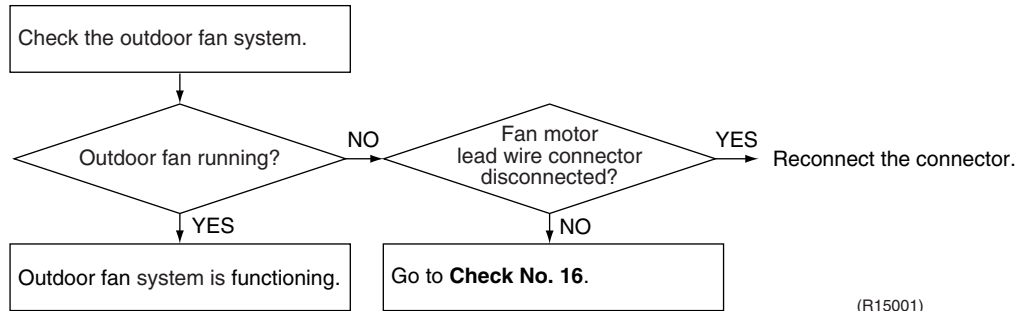

(R15001)

5.12 Main Circuit Short Check

Check No.20



Note: Make sure that the voltage between (+) and (-) of the diode bridge (DB1) is approximately 0 V before checking.

- Measure the resistance between the pins of the DB1 referring to the table below.
- If the resistance is ∞ or less than 1 k Ω , short circuit occurs on the main circuit.

Negative (-) terminal of tester (positive terminal (+) for digital tester)	~ (2, 3)	+ (4)	~ (2, 3)	- (1)
Positive (+) terminal of tester (negative terminal (-) for digital tester)	+ (4)	~ (2, 3)	- (1)	~ (2, 3)
Resistance is OK.	several k Ω ~ several M Ω	∞	∞	several k Ω ~ several M Ω
Resistance is NG.	0 Ω or ∞	0	0	0 Ω or ∞

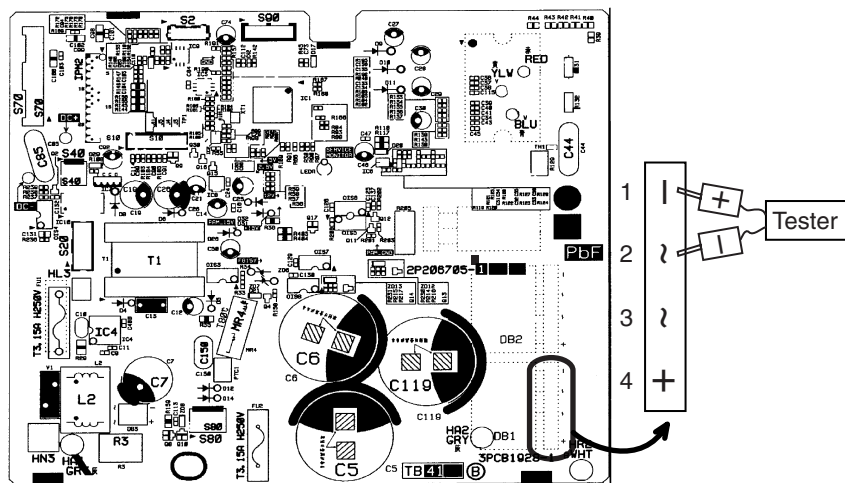

(R19120)

5.13 Power Module Check

Check No.22



Note: Make sure that the voltage between (+) and (-) of the power module is approximately 0 V before checking.

- Disconnect the compressor harness connector from the outdoor unit PCB. To disengage the connector, press the protrusion on the connector.
- Follow the procedure below to measure resistance between the terminals of the power module and the terminals of the compressor with a multi-tester. Evaluate the measurement results referring to the following table.

Negative (-) terminal of tester (positive terminal (+) for digital tester)	Power module (+)	UVW	Power module (-)	UVW
Positive (+) terminal of tester (negative terminal (-) for digital tester)	UVW	Power module (+)	UVW	Power module (-)
Resistance is OK.	several kΩ ~ several MΩ			
Resistance is NG.	0 Ω or ∞			

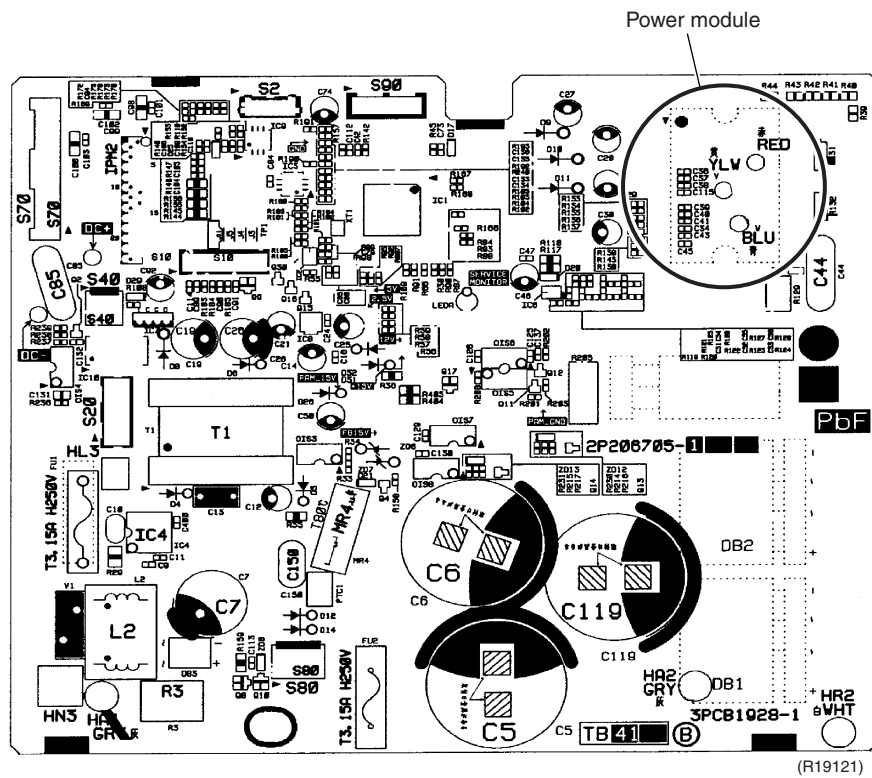

Part 7

Tips for Servicing

1. Tips for Servicing	95
1.1 Pump Down Operation	95
1.2 Forced Cooling Operation	95
2. Trial Operation	96
3. Field Settings	97
3.1 When 2 Units are Installed in 1 Room.....	97
3.2 Jumper Settings	97
4. Silicon Grease on Power Transistor / Diode Bridge	98

1. Tips for Servicing

1.1 Pump Down Operation

Outline

In order to protect the environment, be sure to conduct pump down operation when relocating or disposing the unit.

Detail

- 1) Remove the valve caps from the liquid stop valve and the gas stop valve.
- 2) Carry out forced cooling operation.
- 3) After 5 to 10 minutes, close the liquid stop valve with a hexagonal wrench.
- 4) After 2 to 3 minutes, close the gas stop valve and stop the forced cooling operation.

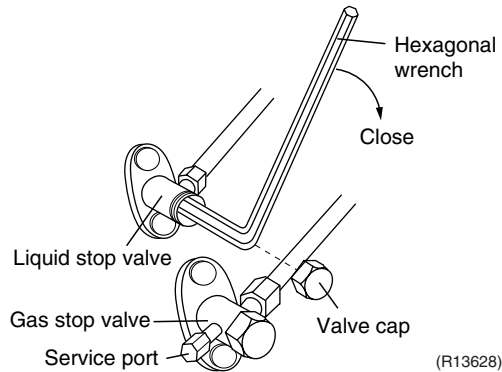

Refer to forced cooling operation below.

1.2 Forced Cooling Operation

Item	Forced Cooling
Conditions	The forced cooling operation is allowed when both of the following conditions are met. 1) The outdoor unit is not abnormal and not in the 3-minute standby mode. 2) The outdoor unit is not operating.
Start	Press the forced cooling operation [ON/OFF] button (SW1) on the indoor unit for 5 seconds.
Command frequency	58 Hz
End	The forced cooling operation ends when any of the following conditions is fulfilled. 1) The operation ends automatically after 15 minutes. 2) Press the forced cooling operation [ON/OFF] button (SW1) on the indoor unit again. 3) Press the [ON/OFF] button on the remote controller.
Others	Protection functions have priority over all other functions during forced cooling operation.

Indoor Unit

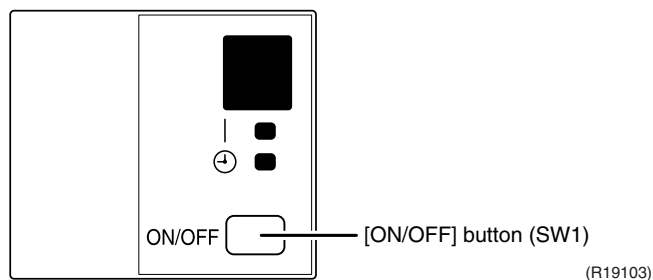

Caution

When pressing the button, do not touch the terminal board. It has a high voltage and may cause electric shock.

2. Trial Operation

Outline

1. Measure the power supply voltage and make sure that it falls within the specified range.
2. Trial operation should be carried out in either cooling or heating operation.
In cooling operation, select the lowest programmable temperature (18°C); in heating operation, select the highest programmable temperature (30°C).
 - ◆ Trial operation may be disabled in either operation mode depending on the room temperature.
 - ◆ After trial operation is complete, set the temperature to a normal level.
(26°C ~ 28°C in cooling, 20°C ~ 24°C in heating)
 - ◆ For protection, the system does not start for 3 minutes after it is turned off.
3. Carry out the trial operation in accordance with the operation manual to ensure that all functions and parts, such as flap movement, are working properly.



Note:

- The air conditioner requires a small amount of power in standby mode. If the system is not to be used for some time after installation, shut off the circuit breaker to eliminate unnecessary power consumption.
- If the circuit breaker trips to shut off the power to the air conditioner, the system backs up the operation mode. The system then restarts operation with the previous operation mode when the circuit breaker is restored.

Detail

ARC433 Series

- (1) Press the [ON/OFF] button to turn on the system.
- (2) Press the center of the [TEMP] button and the [MODE] button at the same time.
- (3) Press the [MODE] button twice.
(? appears on the display to indicate that trial operation is selected.)
- (4) Press the [MODE] button and select operation mode.
- (5) Trial operation terminates in approx. 30 minutes and switches into normal mode. To quit trial operation, press the [ON/OFF] button.

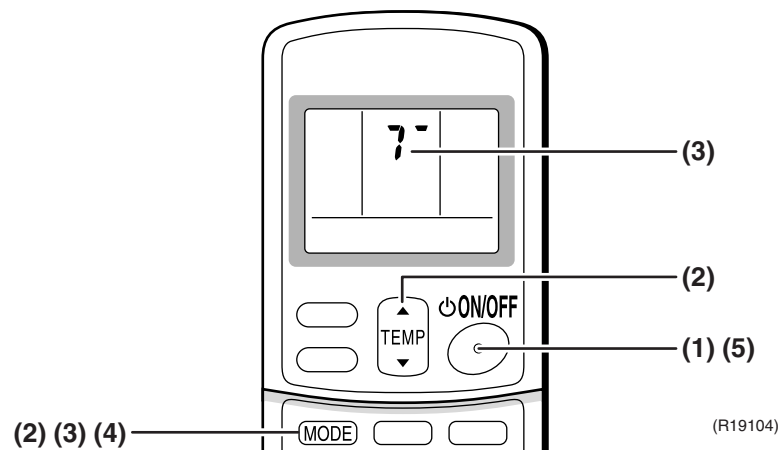

3. Field Settings

3.1 When 2 Units are Installed in 1 Room

Outline

When 2 indoor units are installed in 1 room, 1 of the 2 indoor units and the corresponding wireless remote controller can be set for different addresses. Both the indoor unit PCB and the wireless remote controller need alteration.

Indoor Unit PCB

- Cut the address setting jumper JA on the control PCB.

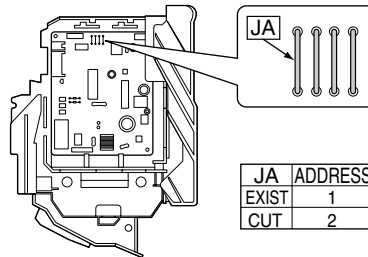

(R12007)



Caution

Replace the PCB if you accidentally cut a wrong jumper.

Jumpers are necessary for electronic circuit. Improper operation may occur if you cut any of them.

Wireless Remote Controller

- Cut the address setting jumper.

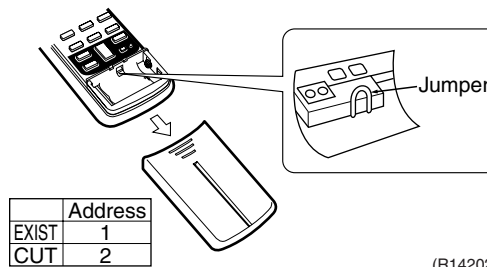

(R14202)

3.2 Jumper Settings

Indoor Unit

Jumper	Function	When connected (factory setting)	When cut
JB	Fan speed setting when compressor stops for thermostat OFF. (effective only in cooling operation)	Fan speed setting; Remote controller setting	Fan speed setting; "0" (The fan stops.)
JC	Power failure recovery function	Auto-restart	The unit does not resume operation after recovering from a power failure. Timer settings are cleared.

Outdoor Unit

Jumper	Function	When connected (factory setting)	When cut
J5	Improvement of defrost performance	Standard control	Reinforced control (ex. The frequency increases, the duration time of defrost lengthens.)



Caution

Replace the PCB if you accidentally cut a wrong jumper.

Jumpers are necessary for electronic circuit. Improper operation may occur if you cut any of them.



For the location of the jumper, refer to the following pages.

Indoor unit: P.14.

Outdoor unit: P.16.

4. Silicon Grease on Power Transistor / Diode Bridge

Outline

Apply the specified silicon grease to the heat radiation part of a power transistor / diode bridge when you replace an outdoor unit PCB. The silicon grease encourages the heat radiation of a power transistor / diode bridge.

Detail

1. Wipe off the old silicon grease completely.
2. Apply the silicon grease evenly. See the illustrations below for examples of application.
3. Tighten the screws of the power transistor / diode bridge.
4. Make sure that the heat radiation parts are firmly contacted to the radiation fin.

Note: Smoke emission may be caused by bad heat radiation when the silicon grease is not appropriately applied.

- OK: Evenly applied

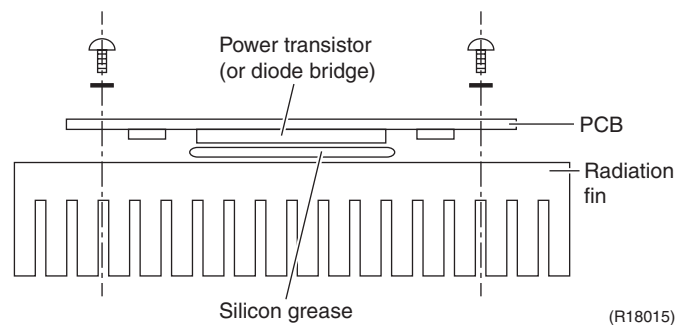

- NG: Not evenly applied

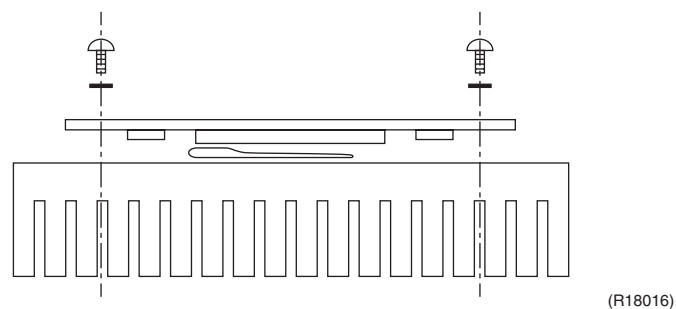

- NG: Foreign matter is stuck.

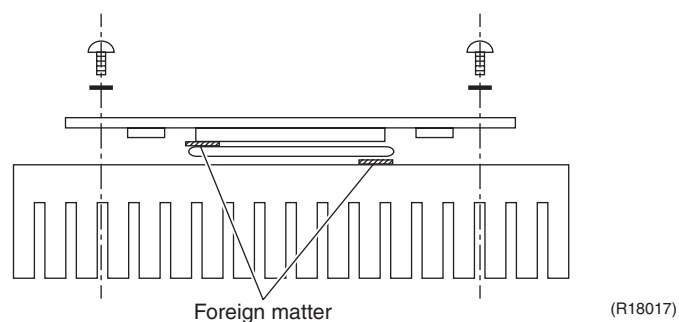

Part 8

Appendix

1. Piping Diagrams.....	100
1.1 Indoor Unit.....	100
1.2 Outdoor Unit.....	101
2. Wiring Diagrams.....	102
2.1 Indoor Unit.....	102
2.2 Outdoor Unit.....	102
3. Removal Procedure (Booklet No.)	103

1. Piping Diagrams

1.1 Indoor Unit

FTX20/25/35JV1B, FTX20/25/35J2V1B, ATX20/25/35JV1B, ATX20/25/35J2V1B

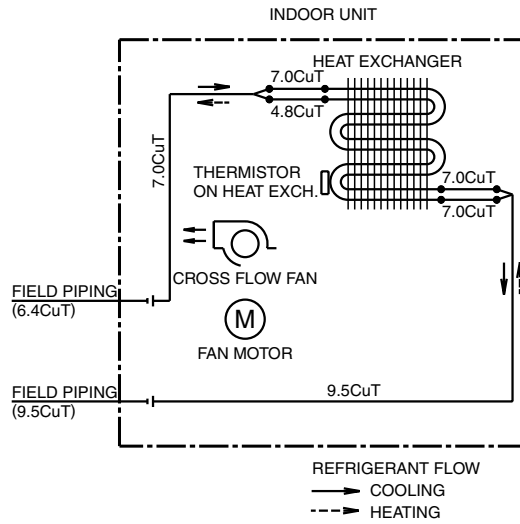

4D058926R

1.2 Outdoor Unit

RX20/25JV1B, RX20/25J3V1B, ARX20/25JV1B, ARX20/25J3V1B

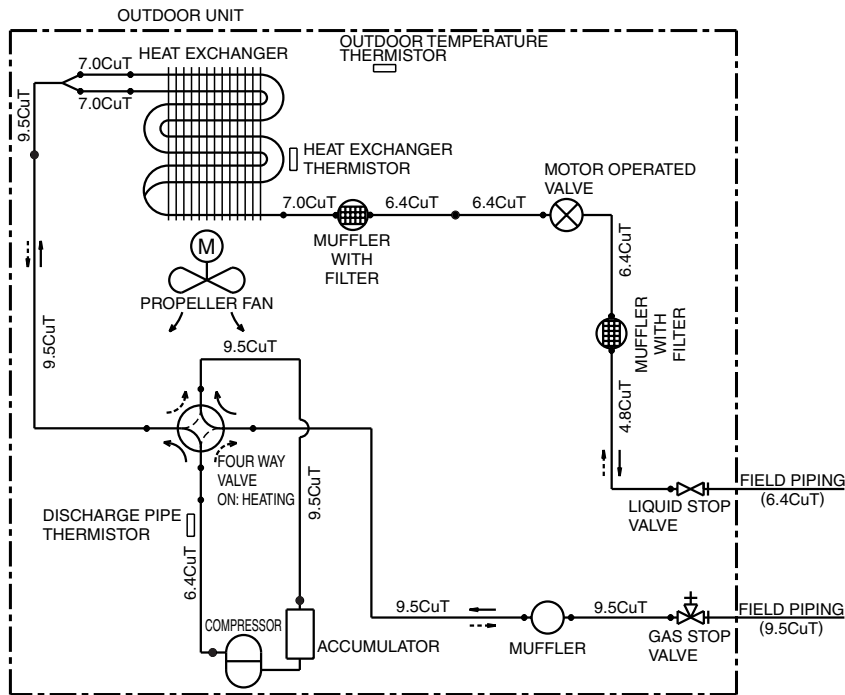

C: 3D058716C

RX35JV1B, RX35J3V1B, ARX35JV1B, ARX35J3V1B

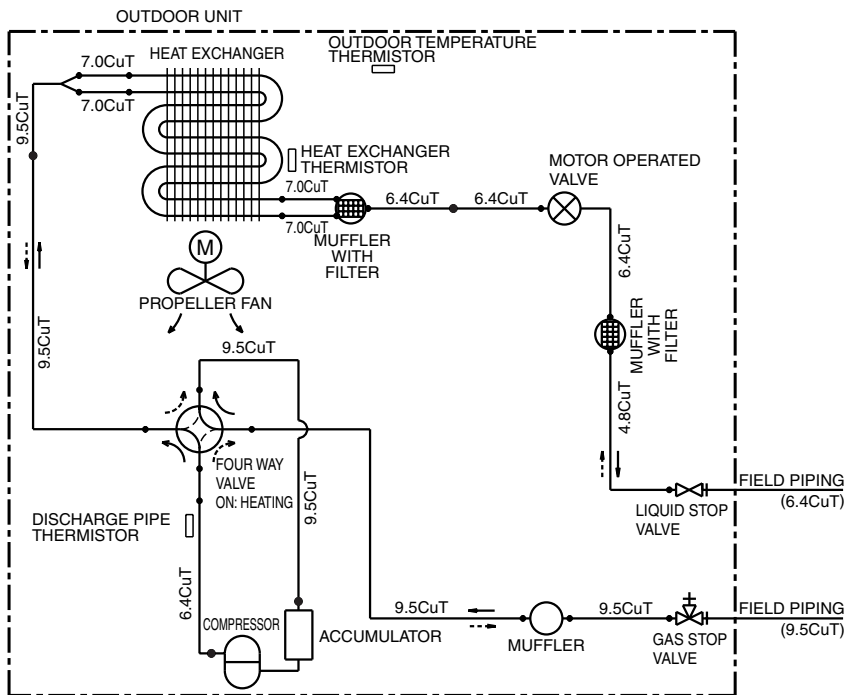

C: 3D058714C

2. Wiring Diagrams

2.1 Indoor Unit

FTX20/25/35JV1B, FTX20/25/35J2V1B, ATX20/25/35JV1B, ATX20/25/35J2V1B

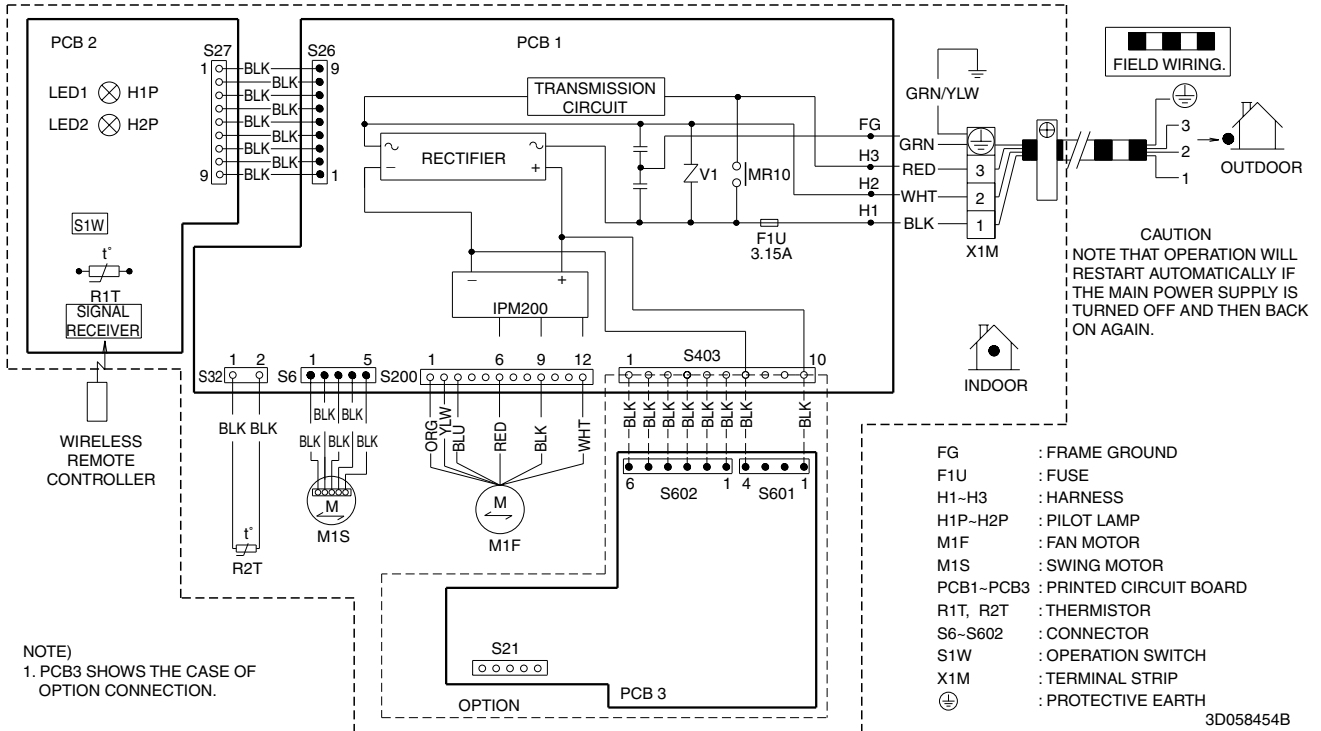

2.2 Outdoor Unit

RX20/25/35JV1B, RX20/25/35J3V1B, ARX20/25/35JV1B, ARX20/25/35J3V1B

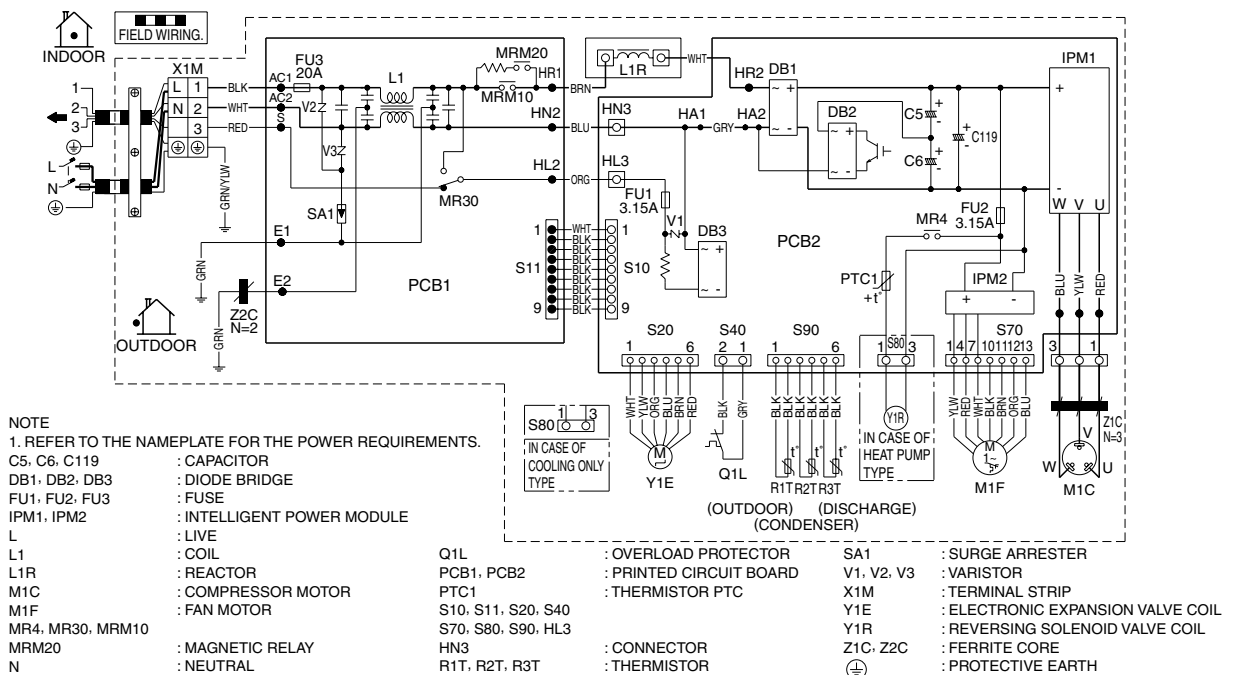

3. Removal Procedure (Booklet No.)

Refer to the following booklets for removal procedure.

*FTX20/25/35JV1B, ATX20/25/35JV1B

 Refer to **Si041051**.

*FTX20/25/35J2V1B, ATX20/25/35J2V1B

 Refer to **Si041264**.

*RX20/25/35JV1B, ARX20/25/35JV1B

 Refer to **Si001073**.

*RX20/25/35J3V1B, ARX20/25/35J3V1B

 Refer to **Si001276**.

Revision History

Month / Year	Version	Revised contents
03 / 2010	SiBE041010	First edition
06 / 2013	SiBE041010EA	Model addition: FTX20/25/35J2V1B, ATX20/25/35J2V1B, RX20/25/35J3V1B, ARX20/25/35J3V1B

Warning



- Daikin products are manufactured for export to numerous countries throughout the world. Prior to purchase, please confirm with your local authorised importer, distributor and/or retailer whether this product conforms to the applicable standards, and is suitable for use, in the region where the product will be used. This statement does not purport to exclude, restrict or modify the application of any local legislation.
- Ask a qualified installer or contractor to install this product. Do not try to install the product yourself. Improper installation can result in water or refrigerant leakage, electrical shock, fire or explosion.
- Use only those parts and accessories supplied or specified by Daikin. Ask a qualified installer or contractor to install those parts and accessories. Use of unauthorised parts and accessories or improper installation of parts and accessories can result in water or refrigerant leakage, electrical shock, fire or explosion.
- Read the User's Manual carefully before using this product. The User's Manual provides important safety instructions and warnings. Be sure to follow these instructions and warnings.

If you have any enquiries, please contact your local importer, distributor and/or retailer.

Cautions on product corrosion

1. Air conditioners should not be installed in areas where corrosive gases, such as acid gas or alkaline gas, are produced.
2. If the outdoor unit is to be installed close to the sea shore, direct exposure to the sea breeze should be avoided. If you need to install the outdoor unit close to the sea shore, contact your local distributor.

Dealer

DAIKIN INDUSTRIES, LTD.

Head Office:
Umeda Center Bldg., 2-4-12, Nakazaki-Nishi,
Kita-ku, Osaka, 530-8323 Japan

Tokyo Office:
JR Shinagawa East Bldg., 2-18-1, Konan,
Minato-ku, Tokyo, 108-0075 Japan

http://www.daikin.com/global_ac/

©All rights reserved