

DAIKIN

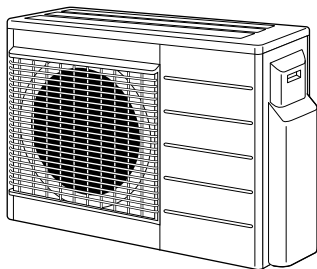

INSTALLATION MANUAL

R410A Split Series



Models

3MXS40K3V1B2

3MXS52E4V1B2

3AMX52E4V1B2

01 Addendum to instructions delivered with the equipment:

The English text is the original instruction. Other languages are translations of the original instructions.

02 Ergänzung zu den mit der Ausrüstung gelieferten Instruktionen:

Bei der englischen Textfassung handelt es sich um das Original. Bei den Anleitungen in anderen Sprachen handelt es sich um Übersetzungen des Originals.

03 Addendum aux instructions fournies avec l'équipement:

Le texte anglais correspond aux instructions d'origine. Les autres langues sont les traductions des instructions d'origine.

04 Bijvoegsel voor bij de apparatuur geleverde instructies:

De Engelse tekst is de oorspronkelijke versie. Andere talen zijn vertalingen van de oorspronkelijke instructies.

05 Anexo a las instrucciones suministradas con el equipo:

El texto en inglés constituye las instrucciones originales. El resto de los idiomas son traducciones de las instrucciones originales.

06 Aggiunta alle istruzioni in dotazione con l'apparecchio:

Il testo in inglese corrisponde alle istruzioni originali. Le altre lingue sono traduzioni delle istruzioni originali.

07 Προσθήκη οδηγιών που παρέχονται με τον εξοπλισμό:

Το αγγλικό κείμενο είναι οι πρωτότυπες οδηγίες. Οι άλλες γλώσσες είναι μεταφράσεις των πρωτότυπων οδηγιών.

08 Adenda às instruções fornecidas com o equipamento:

As instruções foram redigidas originalmente em inglês. As versões noutras línguas são traduções da redacção original.

09 Дополнение к инструкциям, прилагаемым к оборудованию:

Оригиналом инструкции является текст на английском языке. Текст на других языках является переводом с оригинала.

10 Tillegg til veiledningen levert sammen med dette utstyr:

Veiledningens originalspråk er engelsk. Andre språk er oversettelser av den originale veiledning.

11 Tillägg till instruktionerna som medföljer utrustningen:

Den engelska texten är originalinstruktionerna. Övriga språk är översättningar av originalinstruktionerna.

12 Tillegg til instruksjoner som følger med utstyret:

Den engelske teksten inneholder originalinstruksjonene. Andre språk er oversettelser av originalinstruksjonene.

13 Lisäys laitteiston mukana toimitettuihin ohjeisiin:

Englanninkielinen teksti on alkuperäinen ohje. Muut kielet ovat alkuperäisten ohjeiden käännöksiä.

14 Dodatek k polynům dodávaným k zařízení:

Originální návod je v angličtině. Ostatní jazyky jsou překladem originálního návodu.

15 Dodatek uputama isporučenin s opremom:

Engleski tekst je originalna uputa. Ostali jezici su prijevodi originalne upute.

16 Kiegészítés a berendezéshoz mellékelt útmutatóhoz:

Az útmutató eredeti szövege az angol nyelvű szöveg. A többi nyelvű változat az útmutató eredeti szövegének a fordítása.

17 Uzuprečienie informacij odnošne instrukcij dostarczanych z urzadzeniem:

Originalna instrukcija opracowana w języku angielskim. Instrukcje w pozostałych językach są tłumaczeniami instrukcji oryginalnej.

18 Anexa la instrucțiunile livrate cu echipamentul:

Textul în limba engleză este instrucțiunea originală. Celelalte limbi sunt traduceri ale instrucțiunilor originale.

19 Dodatek k navodilom, priložen opremi:

Izvorni jezik tih navodil je engleski. Navodila v drugih jezicah so prevodi navodil v izvornem jeziku.

20 Lisa varustusega koos tamiud juhenditole:

Inglisekeelne tekst on originaaljuhend. Teised keeled on originaaljuhendite tõlked.

21 Дополнение към инструкциите, предоставени с оборудването:

Текстът на английски език е оригиналната инструкция. Текстовете на останалите езици са преводи на оригиналните инструкции.

22 Priedas prie instrukcijų, pristatytų su įranga:

Anglišką tekstą yra originali instrukcija. Tekstai kitomis kalbomis yra šios instrukcijos originalo vertimas.

23 Papildinājums kopā ar iekārtām piegādātajām instrukcijām:

Originālā instrukcija ir teksts angļu valodā. Teksti pārējos valodās ir oriģinālo instrukciju tulkojumi.

24 Doplněk k polynom dodávaným spolu so zařízením:

Originální návod je v angličtině. Ostatní jazyky jsou překlady originálního návodu.

25 Ekigman ile birlikte verilen talimatlara ek:

İngilizce metin asıl talimattır. Diğer diller asıl talimattan çevrilidir.



Safety Precautions

- The precautions described herein are classified as WARNING and CAUTION. They both contain important information regarding safety. Be sure to observe all precautions without fail.
- Meaning of WARNING and CAUTION notices

 **WARNING**.....**Failure to follow these instructions properly may result in personal injury or loss of life.**

 **CAUTION**.....**Failure to observe these instructions properly may result in property damage or personal injury, which may be serious depending on the circumstances.**

- The safety marks shown in this manual have the following meanings:

| | | |
|---|---|--|
|  Be sure to follow the instructions. |  Be sure to establish an earth connection. |  Never attempt. |
|---|---|--|

- After completing installation, conduct a trial operation to check for faults and explain to the customer how to operate the air conditioner and take care of it with the aid of the operation manual.

WARNING



- Ask your dealer or qualified personnel to carry out installation work.
Do not attempt to install the air conditioner yourself. Improper installation may result in water leakage, electric shocks or fire.
- Install the air conditioner in accordance with the instructions in this installation manual.
Improper installation may result in water leakage, electric shocks or fire.
- Be sure to use only the specified accessories and parts for installation work.
Failure to use the specified parts may result in the unit falling, water leakage, electric shocks or fire.
- Install the air conditioner on a foundation strong enough to withstand the weight of the unit.
A foundation of insufficient strength may result in the equipment falling and causing injury.
- Electrical work must be performed in accordance with relevant local and national regulations and with instructions in this installation manual. Be sure to use a dedicated power supply circuit only.
Insufficiency of power circuit capacity and improper workmanship may result in electric shocks or fire.
- Use a cable of suitable length.
Do not use tapped wires or an extension lead, as this may cause overheating, electric shocks or fire.
- Make sure that all wiring is secured, the specified wires are used, and that there is no strain on the terminal connections or wires.
Improper connections or securing of wires may result in abnormal heat build-up or fire.
- When wiring the power supply and connecting the wiring between the indoor and outdoor units, position the wires so that the control box lid can be securely fastened.
Improper positioning of the control box lid may result in electric shocks, fire or over heating terminals.
- If refrigerant gas leaks during installation, ventilate the area immediately. 
Toxic gas may be produced if the refrigerant comes into contact with fire.
- After completing installation, check for refrigerant gas leakage. 
Toxic gas may be produced if the refrigerant gas leaks into the room and comes into contact with a source of fire, such as a fan heater, stove or cooker.
- When installing or relocating the air conditioner, be sure to bleed the refrigerant circuit to ensure it is free of air, and use only the specified refrigerant (R410A).
The presence of air or other foreign matter in the refrigerant circuit causes abnormal pressure rise, which may result in equipment damage and even injury.
- During installation, attach the refrigerant piping securely before running the compressor.
If the refrigerant pipes are not attached and the stop valve is open when the compressor is run, air will be sucked in, causing abnormal pressure in the refrigeration cycle, which may result in equipment damage and even injury.
- During pump-down, stop the compressor before removing the refrigerant piping.
If the compressor is still running and the stop valve is open during pump-down, air will be sucked in when the refrigerant piping is removed, causing abnormal pressure in the refrigeration cycle, which may result in equipment damage and even injury.
- Be sure to earth the air conditioner. 
Do not earth the unit to a utility pipe, lightning conductor or telephone earth lead. Imperfect earthing may result in electric shocks.
- Be sure to install an earth leakage breaker.
Failure to install an earth leakage breaker may result in electric shocks or fire.

CAUTION

- Do not install the air conditioner at any place where there is a danger of flammable gas leakage. 
In the event of a gas leakage, build-up of gas near the air conditioner may cause a fire to break out.
- While following the instructions in this installation manual, install drain piping to ensure proper drainage and insulate piping to prevent condensation.
Improper drain piping may result in indoor water leakage and property damage.
- Tighten the flare nut according to the specified method such as with a torque wrench.
If the flare nut is too tight, it may crack after prolonged use, causing refrigerant leakage.
- Make sure to provide for adequate measures in order to prevent that the outdoor unit be used as a shelter by small animals.
Small animals making contact with electrical parts can cause malfunctions, smoke or fire. Please instruct the customer to keep the area around the unit clean.
- The temperature of refrigerant circuit will be high, please keep the inter-unit wire away from copper pipes that are not thermally insulated.
- Sound pressure level is less than 70dB(A).

Accessories

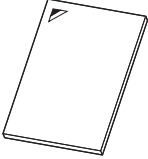
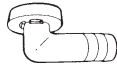
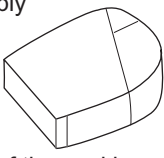
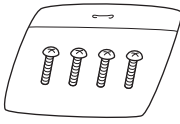
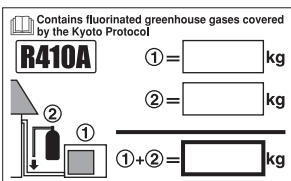
Accessories supplied with the outdoor unit:

| | | | |
|--|---|--|---|
| <p>Ⓐ Installation Manual</p>  <p>It is on the bottom of the packing case.</p> | 1 | <p>Ⓑ Drain plug</p>  <p>It is on the bottom of the packing case.</p> | 1 |
| <p>Ⓒ Reducer assembly</p>  <p>It is on the bottom of the packing case. (3MXS52*, 3AMX52*)</p> | 1 | <p>Ⓓ Screw bag (For fixing electrical wire anchor bands)</p>  <p>It is on the bottom of the packing case.</p> | 1 |
| <p>Ⓔ Refrigerant charge label</p>  | 1 | <p>Ⓕ Multilingual fluorinated greenhouse gases label</p>  <p>It is on the bottom of the packing case.</p> | 1 |

Precautions for Selecting the Location

- 1) Choose a place solid enough to bear the weight and vibration of the unit, where the operation noise will not be amplified.
- 2) Choose a location where the hot air discharged from the unit or the operation noise, will not cause a nuisance to the neighbors of the user.
- 3) Avoid places near a bedroom and the like, so that the operation noise will cause no trouble.
- 4) There must be sufficient spaces for carrying the unit into and out of the site.
- 5) There must be sufficient space for air passage and no obstructions around the air inlet and the air outlet.
- 6) The site must be free from the possibility of flammable gas leakage in a nearby place.
Locate the unit so that the noise and the discharged hot air will not annoy the neighbors.
- 7) Install units, power cords and inter-unit wires at least 3m away from television and radio sets. This is to prevent interference to images and sounds. (Noises may be heard even if they are more than 3m away depending on radio wave conditions.)
- 8) In coastal areas or other places with salty atmosphere of sulfate gas, corrosion may shorten the life of the air conditioner.
- 9) Since drain flows out of the outdoor unit, do not place under the unit anything which must be kept away from moisture.

NOTE:

Cannot be installed hanging from ceiling or stacked.

⚠ CAUTION

When operating the air conditioner in a low outdoor ambient temperature, be sure to follow the instructions described below.

- To prevent exposure to wind, install the outdoor unit with its suction side facing the wall.
- Never install the outdoor unit at a site where the suction side may be exposed directly to wind.
- To prevent exposure to wind, it is recommended to install a baffle plate on the air discharge side of the outdoor unit.
- In heavy snowfall areas, select an installation site where the snow will not affect the unit.

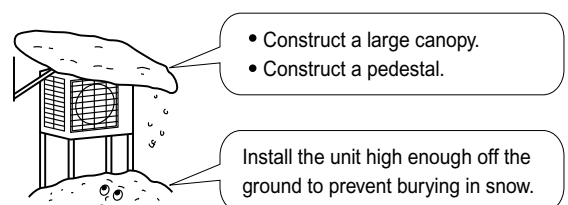

Indoor/Outdoor Unit Installation Drawings

For installation of the indoor units, refer to the installation manual which was provided with the units.
(The diagram shows a wall-mounted indoor unit.)

⚠ CAUTION

- Do not connect the embedded branch piping and the outdoor unit when only carrying out piping work without connecting the indoor unit in order to add another indoor unit later.
Make sure no dirt or moisture gets into either side of the embedded branch piping.
See "7 Refrigerant piping work" on page 9 for details.
- It is impossible to connect the indoor unit for one room only. **Be sure to connect at least 2 rooms.**

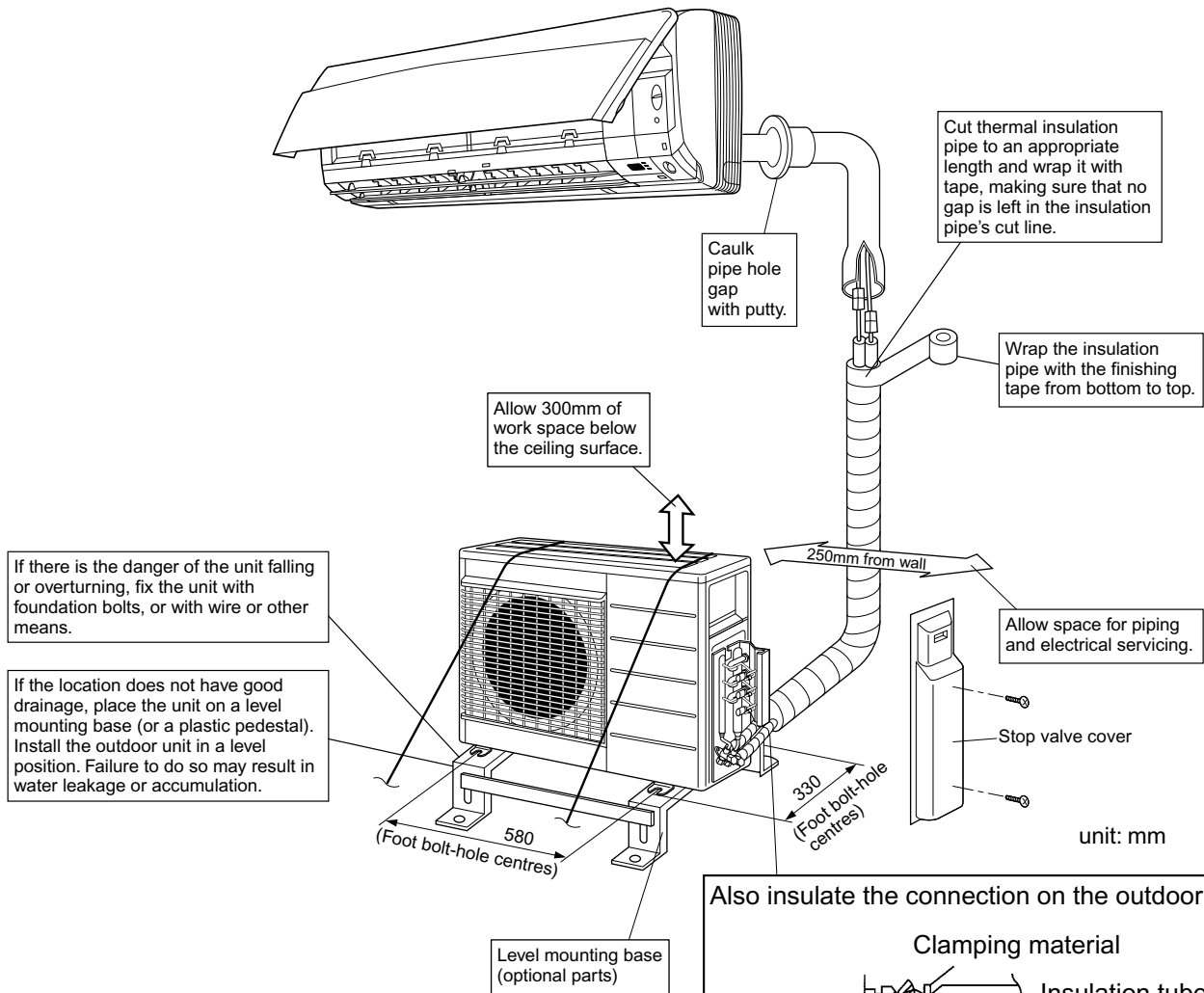

Also insulate the connection on the outdoor unit.

Clamping material
Insulation tube
Tape
Service lid

Use tape or insulating material on all connections to prevent air from getting in between the copper piping and the insulation tube.
Be sure to do this if the outdoor unit is installed above.

Installation

- Install the unit horizontally.
- The unit may be installed directly on a concrete verandah or a solid place if drainage is good.
- If the vibration may possibly be transmitted to the building, use a vibration-proof rubber (field supply).

1. Connections (connection port)

Install the indoor unit according to the table below, which shows the relationship between the class of indoor unit and the corresponding port.

The total indoor unit class that can be connected to this unit:

Heat pump type: 3MXS40* – Up to 7.0kW
 3MXS52* – Up to 9.0kW
 3AMX52* – Up to 9.0kW

| Port | 3MXS40* | 3MXS52* 3AMX52* |
|------|-------------------|---|
| A | 15 , 20 , 25 , 35 | 15 , 20 , 25 , 35 , 42 |
| B | 15 , 20 , 25 , 35 | 15 , 20 , 25 , 35 , 42 |
| C | 15 , 20 , 25 , 35 | # 15, # 20, # 25, # 35, # 42, 50 |

○ : Use a reducer to connect pipes.

: Use No. 2 and 4 reducers

Refer to "How to Use Reducers" on page 10 for information on reducer numbers and their shapes.

Precautions on Installation

- Check the strength and level of the installation ground so that the unit will not cause any operating vibration or noise after installed.
- In accordance with the foundation drawing in fix the unit securely by means of the foundation bolts. (Prepare 4 sets of M8 or M10 foundation bolts, nuts and washers each which are available on the market.)
- It is best to screw in the foundation bolts until their ends are 20mm from the foundation surface.

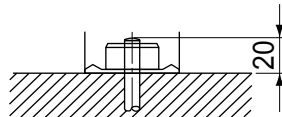

Outdoor Unit Installation Guideline

- Where a wall or other obstacle is in the path of outdoor unit's inlet or outlet airflow, follow the installation guidelines below.
- For any of the below installation patterns, the wall height on the exhaust side should be 1200mm or less.

Wall facing one side

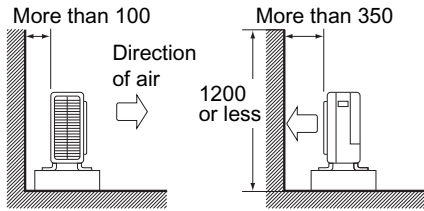

Side view

Walls facing two sides

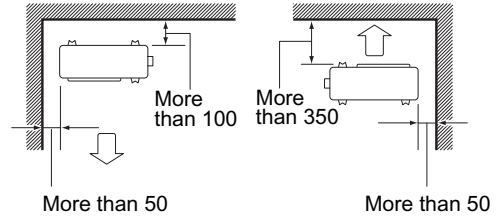

Top view

Walls facing three sides

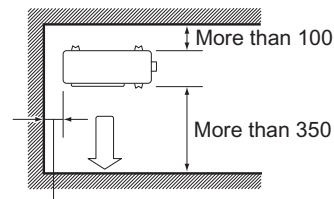

Top view

unit: mm

Selecting a Location for Installation of the Indoor Units

- The maximum allowable length of refrigerant piping, and the maximum allowable height difference between the outdoor and indoor units, are listed below.
(The shorter the refrigerant piping, the better the performance. Connect so that the piping is as short as possible. **Shortest allowable length per room is 3m.**)

| | |
|--|------------------------|
| Outdoor unit capacity class | 3MXS40, 3MXS52, 3AMX52 |
| Piping to each indoor unit | 25m max. |
| Total length of piping between all units | 50m max. |

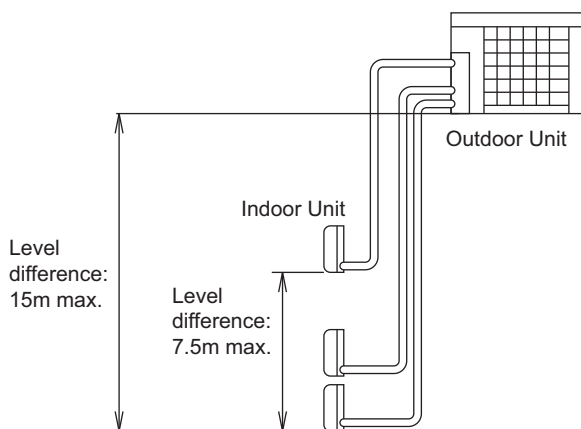

If the outdoor unit is positioned higher than the indoor units.

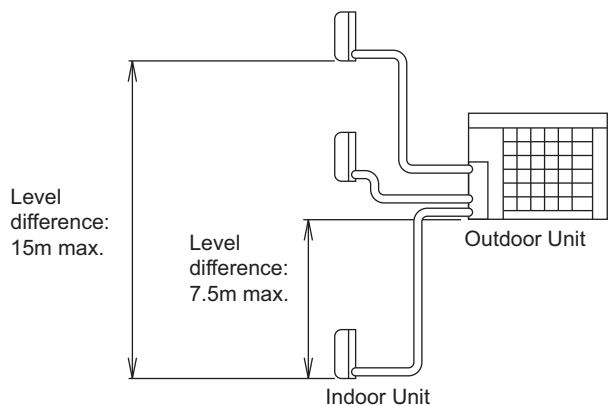

If the outdoor unit is positioned otherwise.
(If lower than one or more indoor units)

Refrigerant Piping Work

1. Installing outdoor unit

- 1) When installing the outdoor unit, refer to “Precautions for Selecting the Location” and the “Indoor/Outdoor Unit Installation Drawings”.
- 2) If drain work is necessary, follow the procedures below.

2. Drain work

- 1) Use the drain plug for drainage.
- 2) If the drain port is covered by a mounting base or floor surface, place additional foot bases of at least 30mm in height under the outdoor unit's feet.
- 3) In cold areas, do not use a drain hose with the outdoor unit. (Otherwise, drain water may freeze, impairing heating performance.)

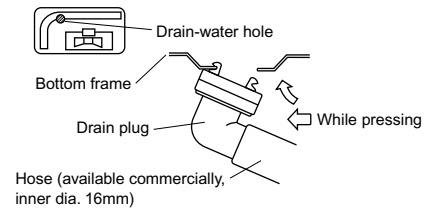

3. Refrigerant piping

⚠ CAUTION

- Use the flare nut fixed to the main unit. (To prevent cracking of the flare nut by aged deterioration.)
- To prevent gas leakage, apply refrigeration oil only to the inner surface of the flare. (Use refrigeration oil for R410A.)
- Use torque wrenches when tightening the flare nuts to prevent damage to the flare nuts and gas leakage.

Align the centres of both flares and tighten the flare nuts 3 or 4 turns by hand. Then tighten them fully with the torque wrenches.

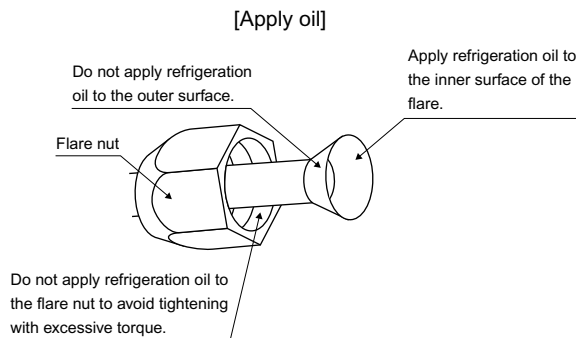

| Flare nut tightening torque | |
|-----------------------------|-------------------------------------|
| Flare nut for $\phi 6.4$ | 14.2-17.2N · m (144-175kgf · cm) |
| Flare nut for $\phi 9.5$ | 32.7-39.9N · m (333-407kgf · cm) |
| Flare nut for $\phi 12.7$ | 49.5-60.3N · m (505-615kgf · cm) |
| Flare nut for $\phi 15.9$ | 61.8-75.4N · m (630-769kgf · cm) |

| Valve cap tightening torque | |
|-------------------------------------|-------------------------------------|
| Gas pipe | Liquid pipe |
| 48.1-59.7N · m (490-610kgf · cm) | 26.5-32.3N · m (270-330kgf · cm) |
| Service port cap tightening torque | |
| 10.8-14.7N · m (110-150kgf · cm) | |

4. Purging air and checking gas leakage

WARNING

- Do not mix any substance other than the specified refrigerant (R410A) into the refrigeration cycle.
 - When refrigerant gas leaks occur, ventilate the room as soon and as much as possible.
 - R410A, as well as other refrigerants, should always be recovered and never be released directly into the environment.
 - Use a vacuum pump for R410A exclusively. Using the same vacuum pump for different refrigerants may damage the vacuum pump or the unit.
-
- When piping work is completed, it is necessary to purge the air and check for gas leakage.
 - If using additional refrigerant, perform air purging from the refrigerant pipes and indoor unit using a vacuum pump, then charge additional refrigerant.
 - Use a hexagonal wrench (4mm) to operate the stop valve rod.
 - All refrigerant pipe joints should be tightened with a torque wrench at the specified tightening torque.
 - 1) Connect projection side of charging hose (which comes from gauge manifold) to gas stop valve's service port.
 - 2) Fully open gauge manifold's low-pressure valve (Lo) and completely close its high-pressure valve (Hi).
(High-pressure valve subsequently requires no operation.)
 - 3) Apply vacuum pumping. Check that the compound pressure gauge reads -0.1MPa (-76cmHg).
Evacuation for **at least 1 hour** is recommended.
 - 4) Close gauge manifold's low-pressure valve (Lo) and stop vacuum pump.
(Leave as is for 4-5 minutes and make sure the coupling meter needle does not go back.
If it does go back, this may indicate the presence of moisture or leaking from connecting parts. After inspecting all the connection and loosening then retightening the nuts, repeat steps 2-4.)
 - 5) Remove covers from liquid stop valve and gas stop valve.
 - 6) Turn the liquid stop valve's rod 90 degrees counterclockwise with a hexagonal wrench to open valve.
Close it after 5 seconds, and check for gas leakage.
Using soapy water, check for gas leakage from indoor unit's flare and outdoor unit's flare and valve rods.
After the check is complete, wipe all soapy water off.
 - 7) Disconnect charging hose from gas stop valve's service port, then fully open liquid and gas stop valves.
(Do not attempt to turn valve rod beyond its stop.)
 - 8) Tighten valve caps and service port caps for the liquid and gas stop valves with a torque wrench at the specified torques.
See "3 Refrigerant piping" on page 6 for details.

Refrigerant Piping Work

5. Refilling the refrigerant

Check the type of refrigerant to be used on the machine nameplate.

Precautions when adding R410A

Fill from the gas pipe in liquid form.

It is a mixed refrigerant, so adding it in gas form may cause the refrigerant composition to change, preventing normal operation.

- 1) Before filling, check whether the cylinder has a siphon attached or not. (It should have something like "liquid filling siphon attached" displayed on it.)

Filling a cylinder with an attached siphon

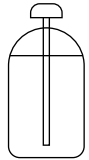

Stand the cylinder upright when filling.

(There is a siphon pipe inside, so the cylinder need not be upside-down to fill with liquid.)

Filling other cylinders



Turn the cylinder upside-down when filling.

- 2) Be sure to use the R410A tools to ensure pressure and to prevent foreign objects entering.

6. Charging with refrigerant

- 1) If the total length of piping for all rooms exceeds the figure listed below, additionally charge with **20g** of refrigerant (R410A) for each additional meter of piping.

| | |
|--------------------------------------|------------------------|
| Outdoor capacity class | 3MXS40, 3MXS52, 3AMX52 |
| Total length of piping for all rooms | 30m |

Important information regarding the refrigerant used

This product contains fluorinated greenhouse gases covered by the Kyoto Protocol.
Do not vent gases into the atmosphere.

Refrigerant type: **R410A**

GWP⁽¹⁾ value: **1975** ⁽¹⁾ GWP = global warming potential

Please fill in with indelible ink,

- ① the factory refrigerant charge of the product,
- ② the additional refrigerant amount charged in the field and
- ①+② the total refrigerant charge

on the refrigerant charge label supplied with the product.

The filled out label must be adhered in the proximity of the product charging port (e.g. onto the inside of the stop valve cover).

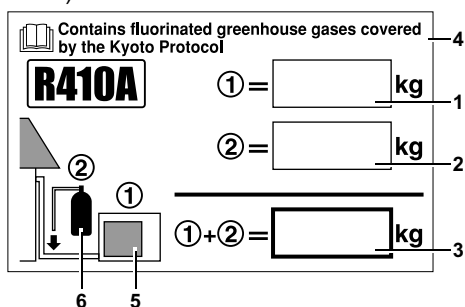

1 factory refrigerant charge of the product: see unit name plate

2 additional refrigerant amount charged in the field
(Refer to the above information for the quantity of refrigerant replenishment.)

3 total refrigerant charge

4 Contains fluorinated greenhouse gases covered by the Kyoto Protocol

5 outdoor unit

6 refrigerant cylinder and manifold for charging

NOTE:

National implementation of EU regulation on certain fluorinated greenhouse gases may require to provide the appropriate official national language on the unit. Therefore an additional multilingual fluorinated greenhouse gases label is supplied with the unit.

Sticking instructions are illustrated on the backside of that label.

⚠ CAUTION

Even though the stop valve is fully closed, the refrigerant may slowly leak out; do not leave the flare nut removed for a long period of time.

7. Refrigerant piping work

Cautions on pipe handling

- 1) Protect the open end of the pipe against dust and moisture.
- 2) All pipe bends should be as gentle as possible. Use a pipe bender for bending.

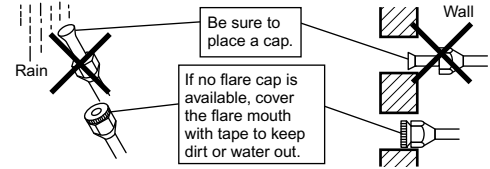

Selection of copper and heat insulation materials

When using commercial copper pipes and fittings, observe the following:

- 1) Insulation material: Polyethylene foam
Heat transfer rate: 0.041 to 0.052W/mK (0.035 to 0.045kcal/mh°C)
Refrigerant gas pipe's surface temperature reaches 110°C max.
Choose heat insulation materials that will withstand this temperature.
- 2) Be sure to insulate both the gas and liquid piping and to provide insulation dimensions as below.

| | |
|------------------------|---|
| Gas pipe | O.D.: 9.5mm, 12.7mm / Thickness: 0.8mm (C1220T-O) O.D.: 15.9mm / Thickness: 1.0mm (C1220T-O) |
| Liquid pipe | O.D.: 6.4mm / Thickness: 0.8mm (C1220T-O) |
| Gas pipe insulation | I.D.: 12-15mm, I.D.: 16-20mm / Thickness: 13mm min. |
| Liquid pipe insulation | I.D.: 8-10mm / Thickness: 10mm min. |
| Minimum bend radius | O.D.: 6.4mm, 9.5mm / 30mm or more O.D.: 12.7mm / 40mm or more O.D.: 15.9mm / 50mm or more |

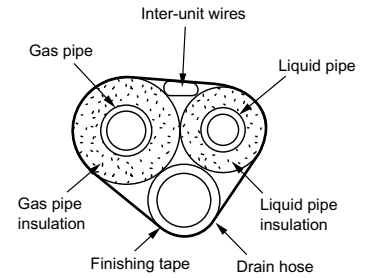

- 3) Use separate thermal insulation pipes for gas and liquid refrigerant pipes.

8. Flaring the pipe end

- 1) Cut the pipe end with a pipe cutter.
- 2) Remove burrs with the cut surface facing downward so that the chips do not enter the pipe.
- 3) Put the flare nut on the pipe.
- 4) Flare the pipe.
- 5) Check that the flaring is properly made.

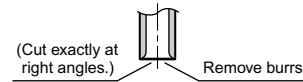

| Flaring | | | |
|--|----------------------|--------------------------|-------------------------------|
| Set exactly at the position shown below. | | | |
| | Flare tool for R410A | Conventional flare tool | |
| | Clutch-type | Clutch-type (Rigid-type) | Wing-nut type (Imperial-type) |
| A | 0-0.5mm | 1.0-1.5mm | 1.5-2.0mm |

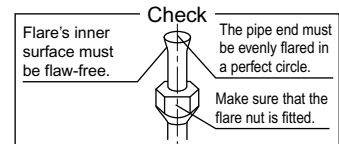

⚠ WARNING

- Do not use mineral oil on flared part.
- Prevent mineral oil from getting into the system as this would reduce the lifetime of the units.
- Never use piping which has been used for previous installations. Only use parts which are delivered with the unit.
- Never install a dryer to this R410A unit in order to guarantee its lifetime.
- The drying material may dissolve and damage the system.
- Incomplete flaring may cause refrigerant gas leakage.

How to Use Reducers

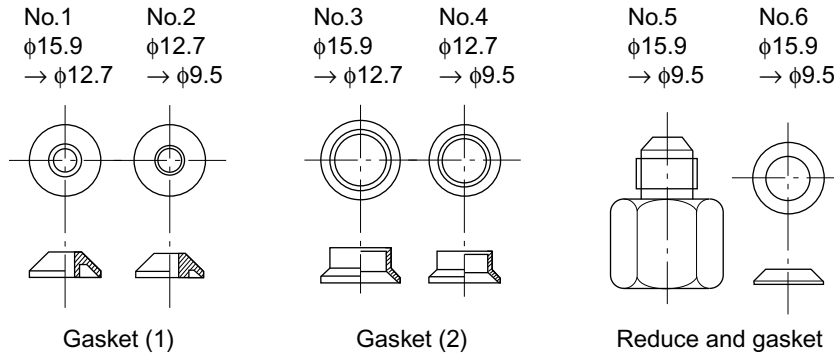

Use the reducers supplied with the unit as described below.

1) Connecting a pipe of φ12.7 to a gas pipe connection port for φ15.9:

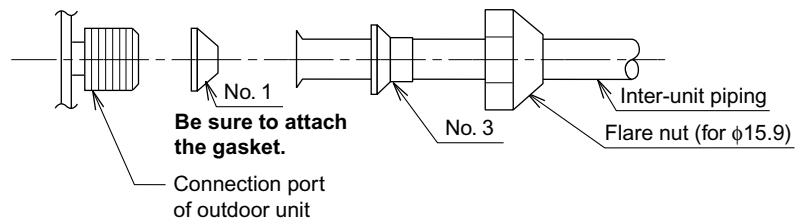

2) Connecting a pipe of φ9.5 to a gas pipe connection port for φ15.9:

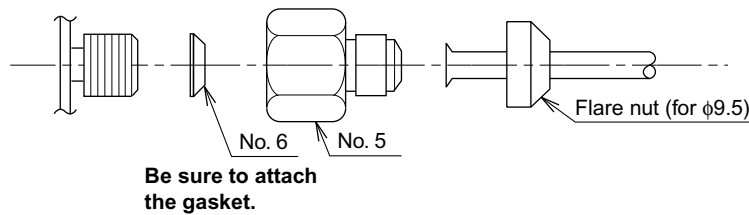

3) Connecting a pipe of φ9.5 to a gas pipe connection port for φ12.7:

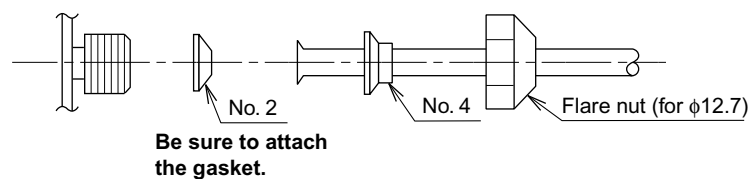

- When using the reducer packing shown above, be careful not to overtighten the nut, or the smaller pipe may be damaged. (about 2/3 - 1 the normal torque)
- Apply a coat of refrigeration oil to the threaded connection port of the outdoor unit where the flare nut comes in.
- Use an appropriate wrench to avoid damaging the connection thread by overtightening the flare nut.

| Flare nut tightening torque | |
|-----------------------------|---------------------------------|
| Flare nut for φ9.5 | 32.7–39.9N·m (333–407kgf·cm) |
| Flare nut for φ12.7 | 49.5–60.3N·m (505–615kgf·cm) |
| Flare nut for φ15.9 | 61.8–75.4N·m (630–769kgf·cm) |

Pump Down Operation

In order to protect the environment, be sure to pump down when relocating or disposing of the unit.

- 1) Remove the valve cap from liquid stop valve and gas stop valve.
- 2) Carry out forced cooling operation.
- 3) After five to ten minutes, close the liquid stop valve with a hexagonal wrench.
- 4) After two to three minutes, close the gas stop valve and stop forced cooling operation.

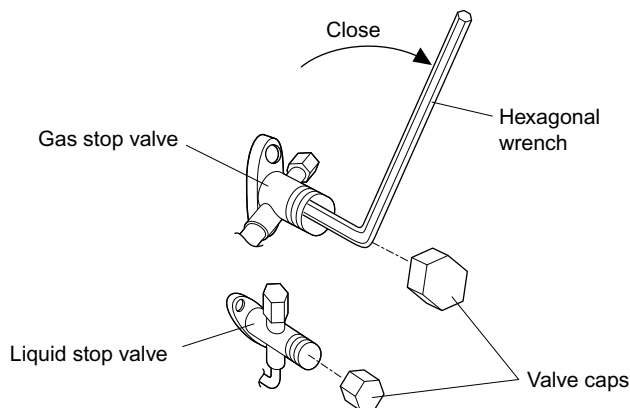

1. Forced operation

- 1) Turn the Operation Mode switch (SW2) to "COOL".
- 2) Press the Forced Operation switch (SW1) to begin forced cooling. Press the Forced Operation switch (SW1) again to stop forced cooling.

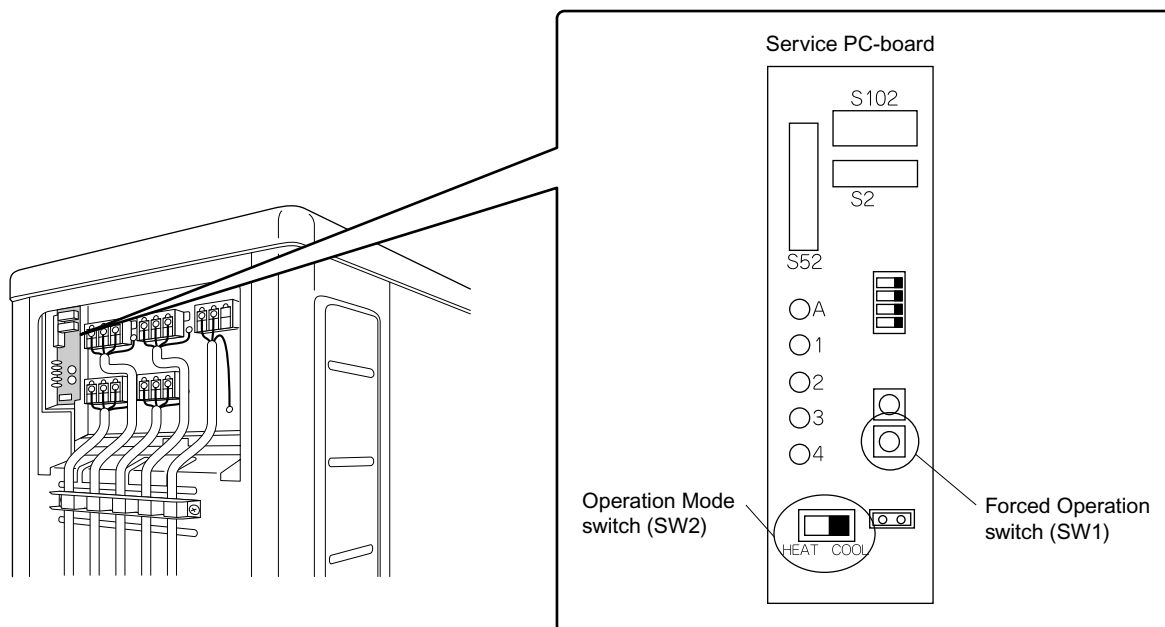

Wiring

⚠ WARNING

- Do not use tapped wires, stranded wires, extension cords, or starburst connections, as they may cause overheating, electrical shock, or fire.
- Do not use locally purchased electrical parts inside the product. (Do not branch the power for the drain pump, etc., from the terminal block.) Doing so may cause electric shock or fire.
- Be sure to install an earth leakage breaker. (One that can handle higher harmonics.)
(This unit uses an inverter, which means that an earth leakage breaker capable of handling harmonics must be used, in order to prevent malfunctioning of the earth leakage breaker itself.)
- Use an all-pole disconnection type breaker with at least 3 mm between the contact point gaps.
- Do not connect the power wire to the indoor unit. Doing so may cause electric shock or fire.

Equipment complying with EN/IEC 61000-3-12⁽¹⁾ according to the following table:

| Model | Compliance with EN/IEC 61000-3-12 |
|--------------|-----------------------------------|
| 3MXS40K3V1B2 | NO |
| 3MXS52E4V1B2 | YES |
| 3AMX52E4V1B2 | YES |

- Do not turn on the safety breaker until all work is completed.
 - Strip the insulation from the wire (20mm).
 - Connect the inter-unit wires between the indoor and outdoor units **so that the terminal numbers match**. Tighten the terminal screws securely. We recommend a flathead screwdriver be used to tighten the screws. The screws are packed with the terminal board.

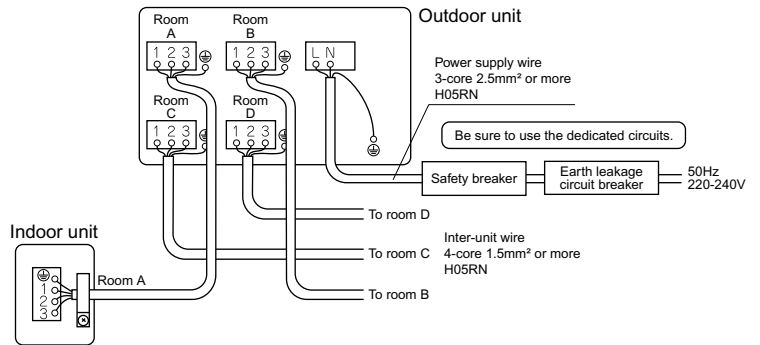

⚠ CAUTION

When connecting the connection wires to the terminal board using a single core wire, be sure to perform curling. Problems with the work may cause heat and fires.

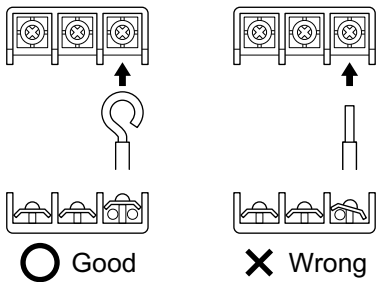

- Ground terminal installation
Use the following method when installing the round crimp-style terminal.

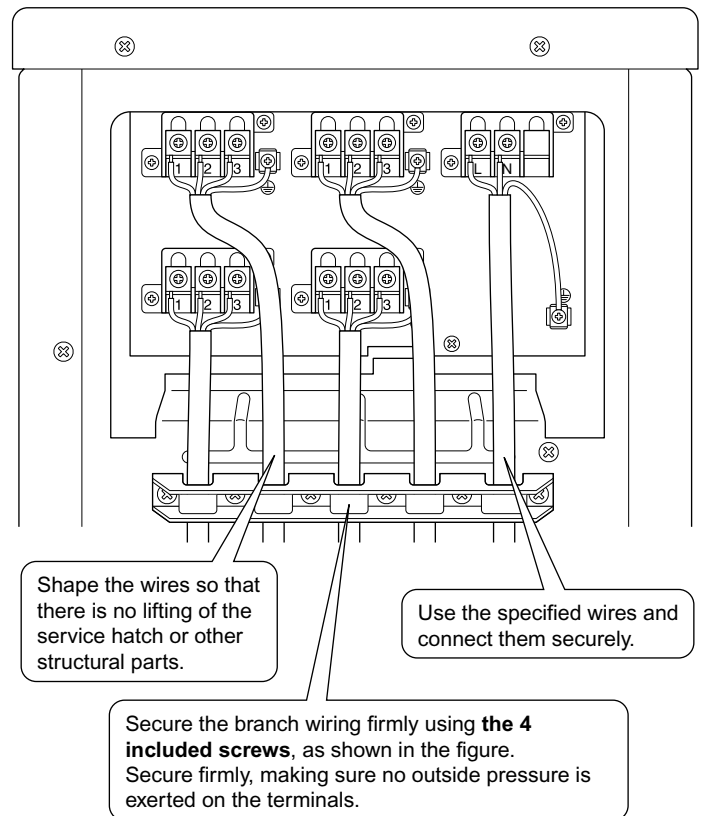
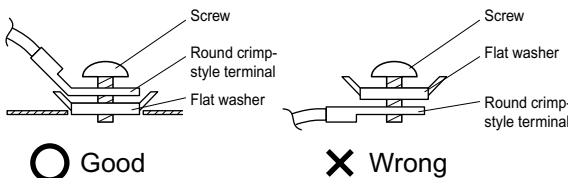

- Pull the wire and make sure that it does not disconnect. Then fix the wire in place with a wire stop.

■ Earth

This air conditioner must be earthed.

For earthing, follow the applicable local standard for electrical installations.

(1) European/International Technical Standard setting the limits for harmonic currents produced by equipment connected to public low-voltage systems with input current >16 A and ≤75 A per phase.

Priority Room Setting

- To use priority room setting, initial settings must be made when the unit is installed. Explain the priority room setting, as described below, to the customer, and confirm whether or not the customer wants to use priority room setting. Setting it in the guest and living rooms is convenient.

1. About the priority room setting function

The indoor unit for which priority room setting is applied takes priority in the following cases.

1-1. Operation mode priority

The operation mode of the indoor unit which is set for priority room setting takes priority. If the set indoor unit is operating, all other indoor units do not operate and enter standby mode, according to the operation mode of the set indoor unit.

1-2. Priority during high-power operation

If the indoor unit which is set for priority room setting is operating at high power, the capabilities of other indoor units will be somewhat reduced. Power supply gives priority to the indoor unit which is set for priority room setting.

1-3. Quiet operation priority

Setting the indoor unit to quiet operation will make the outdoor unit run quietly.

Service PC-board

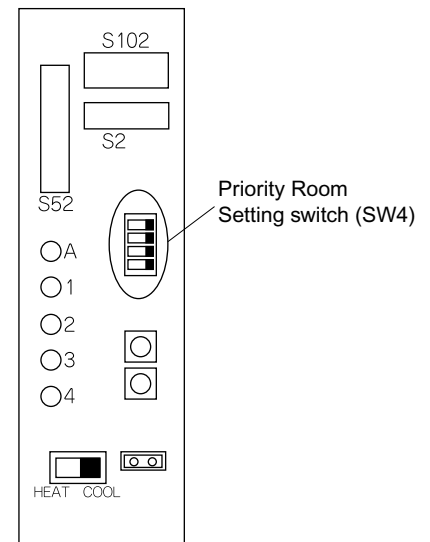

Setting procedure

Slide the switch to the ON side for the switch that corresponds to the piping connected to the indoor unit to be set. (In the figure below, it is room A.)

Once the settings are complete, reset the power.

Be sure to only set one room

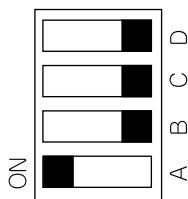

Night Quiet Mode Setting

- If night quiet mode is to be used, initial settings must be made when the unit is installed.
Explain night quiet mode, as described below, to the customer, and confirm whether or not the customer wants to use night quiet mode.

About night quiet mode

The night quiet mode function reduces operating noise of the outdoor unit at night-time. This function is useful if the customer is worried about the effects of the operating noise on the neighbors.
However, if night quiet mode is running, cooling/heating capacity will be saved.

Setting procedure

Remove the SW5 jumper switch.
Once the settings are complete, reset the power.

NOTE:

Install the removed jumper switch as described below. This switch will be needed to later disable this setting.

Service PC-board

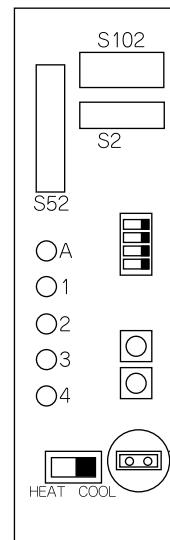

Night Quiet Mode setting switch (SW5)

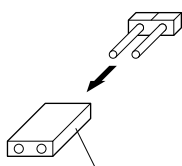

Jumper switch

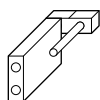

After removing

COOL/ HEAT Mode Lock <S15>

- Use the S15 connector to set the unit to only cool or heat.
Setting to only heat (H): short-circuit pins 1 and 3 of the connector <S15>
Setting to only cool (C): short-circuit pins 3 and 5 of the connector <S15>
The following specifications apply to the connector housing and pins.

JST products Housing: VHR-5N
 Pin: SVH-21T-1,1

Note that forced operation is also possible in COOL/HEAT mode.

COOL mode (C)

HEAT mode (H)

5<C>3<H>1

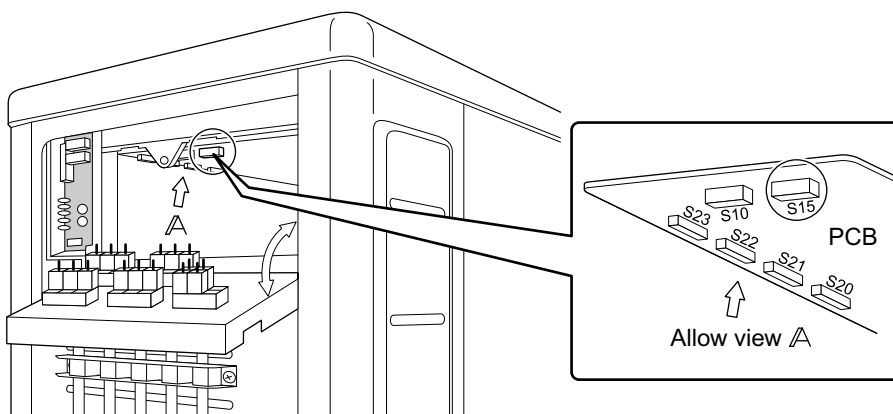

Trial Operation and Testing

- Before starting the test run, measure the voltage at the primary side of the safety breaker. Check that it is 220-240V.
- Check that all liquid and gas stop valves are fully open.
- Check that piping and wiring all match. The wiring error check can be conveniently used for underground wiring and other wiring that cannot be directly checked.

1. Wiring error check

- This product is capable of automatic correction of wiring error.
- Press the “wiring error check switch” on the outdoor unit service monitor print board. However, the wiring error check switch will not function for one minute after the safety breaker is turned on, or depending on the outside air conditions (See NOTE 2.). Approximately 10–15 minutes after the switch is pressed, the errors in the connection wiring will be corrected.

The service monitor LEDs indicate whether or not correction is possible, as shown in the table below. For details about how to read the LED display, refer to the service guide.

Service PC-board

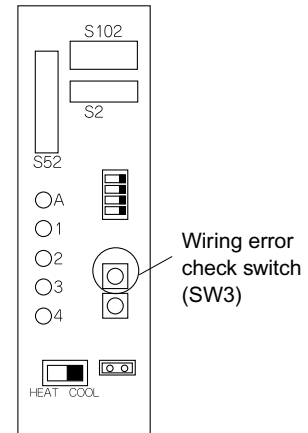

If self-correction is not possible, check the indoor unit wiring and piping in the usual manner.

| LED | 1 | 2 | 3 | 4 | Message |
|--------|---------------------------------------|---|---|---|---------------------------------|
| Status | All Flashing | | | | Automatic correction impossible |
| | Flashing One after another | | | | Automatic correction completed |
| | ☀ (One or more of LEDs 1 to 4 are ON) | | | | Abnormal stop [NOTE. 4] |

Wiring correct example

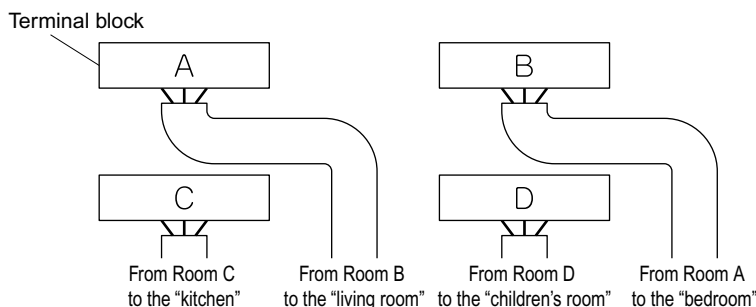

* The figure at left shows branch wiring.

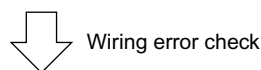

LED lighting sequence after a wiring correction.

Order of LED flashing: 2 → 1 → 3 → 4

NOTE:

- 1) For two rooms, LED 3 and 4 are not displayed, and for three rooms, LED 4 is not displayed.
- 2) If the outside air temperature is **5°C or less**, the wiring error check function will not operate.
- 3) After wiring error check operation is completed, LED indication will continue until ordinary operation starts. This is normal.
- 4) Follow the product diagnosis procedures. (Check the nameplate on the underside of the stop valve.)

Trial Operation and Testing

2. Trial operation and testing

- 1) To test cooling, set for the lowest temperature. To test heating, set for the highest temperature. (Depending on the room temperature, only heating or cooling (but not both) may be possible.)
- 2) After the unit is stopped, it will not start again (heating or cooling) for approximately 3 minutes.
- 3) During the test run, first check the operation of each unit individually. Then also check the simultaneous operation of all indoor units.
Check both heating and cooling operation.
- 4) After running the unit for approximately 20 minutes, measure the temperatures at the indoor unit inlet and outlet. If the measurements are above the values shown in the table below, then they are normal.

| | Cooling | Heating |
|---|-------------|--------------|
| Temperature difference between inlet and outlet | Approx. 8°C | Approx. 20°C |

(When running in one room)

- 5) During cooling operation, frost may form on the gas stop valve or other parts. This is normal.
- 6) Operate the indoor units in accordance with the included operation manual. Check that they operate normally.

3. Items to check

| Check item | Consequences of trouble | Check |
|---|--|-------|
| Are the indoor units installed securely? | Falling, vibration, noise | |
| Has an inspection been made to check for gas leakage? | No cooling, no heating | |
| Has complete thermal insulation been done (gas pipes, liquid pipes, indoor portions of the drain hose extension)? | Water leakage | |
| Is the drainage secure? | Water leakage | |
| Are the ground wire connections secure? | Danger in the event of a ground fault | |
| Are the electric wires connected correctly? | No cooling, no heating | |
| Is the wiring in accordance with the specifications? | Operation failure, burning | |
| Are the inlets/outlets of the indoor and outdoor units free of any obstructions? | No cooling, no heating | |
| Are the stop valves open? | No cooling, no heating | |
| Do the marks match on the wiring and piping for each indoor unit? | No cooling, no heating | |
| Is the priority room setting set for 2 or more rooms? | The priority room setting will not function. | |

ATTENTION

- Have the customer actually operate the unit while looking at the manual included with the indoor unit. Instruct the customer how to operate the unit correctly (particularly cleaning of the air filters, operation procedures, and temperature adjustment).
- Even when the air conditioner is not operating, it consumes some electric power. If the customer is not going to use the unit soon after it is installed, turn off the breaker to avoid wasting electricity.
- If additional refrigerant has been charged because of long piping, list the amount added on the nameplate on the reverse side of the stop valve cover.

DAIKIN INDUSTRIES CZECH REPUBLIC s.r.o.

U Nové Hospody 1/1155, 301 00 Plzeň Skvrňany, Czech Republic

DAIKIN EUROPE N.V.

Zandvoordestraat 300, B-8400 Oostende, Belgium

EAC

3P401524-2 2015.02

Copyright 2015 Daikin