

DAIKIN

INSTALLATION MANUAL

R410A Split Series

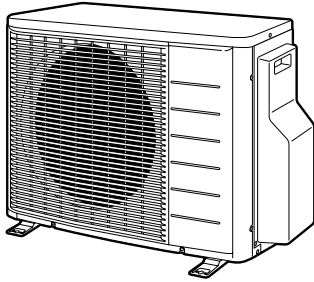

Models

2MXS40G2V1B 2MKS40G2V1B
2MXS50G2V1B 2MKS50G2V1B
2MXS40H2V1B 2MKS40H2V1B
2MXS50H2V1B 2MKS50H2V1B
2AMX40G2V1B
2AMX50G2V1B
2AMX40F2V1B
2AMX50F2V1B

Installation manual
R410A Split series

English

Installationsanleitung
Split-Baureihe R410A

Deutsch

Manuel d'installation
Série split R410A

Français

Montagehandleiding
R410A Split-systeem

Nederlands

Manual de instalación
Serie Split R410A

Español

Manuale d'installazione
Serie Multiambienti R410A

Italiano

Εγχειρίδιο εγκατάστασης
διαιρούμενης σειράς R410A

Ελληνικά

Manual de Instalação
Série split R410A

Portugues

Руководство по монтажу
Серия R410A с раздельной установкой

Русский

Montaj kılavuzları
R410A Split serisi

Türkçe



Safety Precautions

- The precautions described herein are classified as WARNING and CAUTION. They both contain important information regarding safety. Be sure to observe all precautions without fail.
- Meaning of WARNING and CAUTION notices





 **WARNING Failure to follow these instructions properly may result in personal injury or loss of life.**



 **CAUTION Failure to observe these instructions properly may result in property damage or personal injury, which may be serious depending on the circumstances.**

- The safety marks shown in this manual have the following meanings:

 Be sure to follow the instructions.	 Be sure to establish an earth connection.	 Never attempt.
---	---	--



- After completing installation, conduct a trial operation to check for faults and explain to the customer how to operate the air conditioner and take care of it with the aid of the operation manual.

 WARNING	
<ul style="list-style-type: none"> • Ask your dealer or qualified personnel to carry out installation work. Do not attempt to install the air conditioner yourself. Improper installation may result in water leakage, electric shocks or fire. 	
<ul style="list-style-type: none"> • Install the air conditioner in accordance with the instructions in this installation manual. Improper installation may result in water leakage, electric shocks or fire. 	
<ul style="list-style-type: none"> • Be sure to use only the specified accessories and parts for installation work. Failure to use the specified parts may result in the unit falling, water leakage, electric shocks or fire. 	
<ul style="list-style-type: none"> • Install the air conditioner on a foundation strong enough to withstand the weight of the unit. A foundation of insufficient strength may result in the equipment falling and causing injury. 	
<ul style="list-style-type: none"> • Electrical work must be performed in accordance with relevant local and national regulations and with instructions in this installation manual. Be sure to use a dedicated power supply circuit only. Insufficiency of power circuit capacity and improper workmanship may result in electric shocks or fire. 	
<ul style="list-style-type: none"> • Use a cable of suitable length. Do not use tapped wires or an extension lead, as this may cause overheating, electric shocks or fire. 	
<ul style="list-style-type: none"> • Make sure that all wiring is secured, the specified wires are used, and that there is no strain on the terminal connections or wires. Improper connections or securing of wires may result in abnormal heat build-up or fire. 	
<ul style="list-style-type: none"> • When wiring the power supply and connecting the wiring between the indoor and outdoor units, position the wires so that the control box lid can be securely fastened. Improper positioning of the control box lid may result in electric shocks, fire or over heating terminals. 	
<ul style="list-style-type: none"> • If refrigerant gas leaks during installation, ventilate the area immediately. Toxic gas may be produced if the refrigerant comes into contact with fire. 	
<ul style="list-style-type: none"> • After completing installation, check for refrigerant gas leakage. Toxic gas may be produced if the refrigerant gas leaks into the room and comes into contact with a source of fire, such as a fan heater, stove or cooker. 	
<ul style="list-style-type: none"> • When installing or relocating the air conditioner, be sure to bleed the refrigerant circuit to ensure it is free of air, and use only the specified refrigerant (R410A). The presence of air or other foreign matter in the refrigerant circuit causes abnormal pressure rise, which may result in equipment damage and even injury. 	
<ul style="list-style-type: none"> • During installation, attach the refrigerant piping securely before running the compressor. If the compressor is not attached and the stop valve is open when the compressor is run, air will be sucked in, causing abnormal pressure in the refrigeration cycle, which may result in equipment damage and even injury. 	
<ul style="list-style-type: none"> • During pump-down, stop the compressor before removing the refrigerant piping. If the compressor is still running and the stop valve is open during pump-down, air will be sucked in when the refrigerant piping is removed, causing abnormal pressure in the refrigeration cycle, which may result in equipment damage and even injury. 	
<ul style="list-style-type: none"> • Be sure to earth the air conditioner. Do not earth the unit to a utility pipe, lightning conductor or telephone earth lead. Imperfect earthing may result in electric shocks. 	
<ul style="list-style-type: none"> • Be sure to install an earth leakage breaker. Failure to install an earth leakage breaker may result in electric shocks or fire. 	

 CAUTION	
<ul style="list-style-type: none"> • Do not install the air conditioner at any place where there is a danger of flammable gas leakage. In the event of a gas leakage, build-up of gas near the air conditioner may cause a fire to break out. 	
<ul style="list-style-type: none"> • While following the instructions in this installation manual, install drain piping to ensure proper drainage and insulate piping to prevent condensation. Improper drain piping may result in indoor water leakage and property damage. 	
<ul style="list-style-type: none"> • Tighten the flare nut according to the specified method such as with a torque wrench. If the flare nut is too tight, it may crack after prolonged use, causing refrigerant leakage. 	
<ul style="list-style-type: none"> • Make sure to provide for adequate measures in order to prevent that the outdoor unit be used as a shelter by small animals. Small animals making contact with electrical parts can cause malfunctions, smoke or fire. Please instruct the customer to keep the area around the unit clean. 	

Accessories

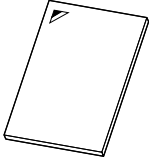
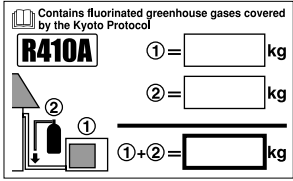
Accessories supplied with the outdoor unit:

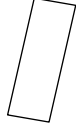
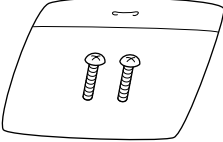
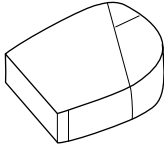
<p>Installation Manual</p>  <p>There is on the bottom packing case.</p>	<p>1</p>	<p>Refrigerant charge label</p>  <p>There is on the bottom packing case.</p>	<p>1</p>
<p>Drain plug (Heat pump-Models)</p>  <p>There is on the bottom packing case.</p>	<p>1</p>	<p>Multilingual fluorinated greenhouse gases label</p>  <p>There is on the bottom packing case.</p>	<p>1</p>
<p>Screw bag (For fixing the wire retainer)</p>  <p>There is on the bottom packing case.</p>	<p>1</p>	<p>Reducer assy (Only 50 class)</p>  <p>There is on the bottom packing case.</p>	<p>1</p>

Precautions for Selecting the Location

- 1) Choose a place solid enough to bear the weight and vibration of the unit, where the operation noise will not be amplified.
- 2) Choose a location where the hot air discharged from the unit or the operation noise, will not cause a nuisance to the neighbors of the user.
- 3) Avoid places near a bedroom and the like, so that the operation noise will cause no trouble.
- 4) There must be sufficient spaces for carrying the unit into and out of the site.
- 5) There must be sufficient space for air passage and no obstructions around the air inlet and the air outlet.
- 6) The site must be free from the possibility of flammable gas leakage in a nearby place.
Locate the unit so that the noise and the discharged hot air will not annoy the neighbors.
- 7) Install units, power cords and inter-unit cables at least 3 meter away from television and radio sets. This is to prevent interference to images and sounds. (Noises may be heard even if they are more than 3 meter away depending on radio wave conditions.)
- 8) In coastal areas or other places with salty atmosphere of sulfate gas, corrosion may shorten the life of the air conditioner.
- 9) Since drain flows out of the outdoor unit, do not place under the unit anything which must be kept away from moisture.

NOTE:

Cannot be installed hanging from ceiling or stacked.

CAUTION

When operating the air conditioner in a low outdoor ambient temperature, be sure to follow the instructions described below.

- 1) To prevent exposure to wind, install the outdoor unit with its suction side facing the wall.
- 2) Never install the outdoor unit at a site where the suction side may be exposed directly to wind.
- 3) To prevent exposure to wind, it is recommended to install a baffle plate on the air discharge side of the outdoor unit.
- 4) In heavy snowfall areas, select an installation site where the snow will not affect the unit.

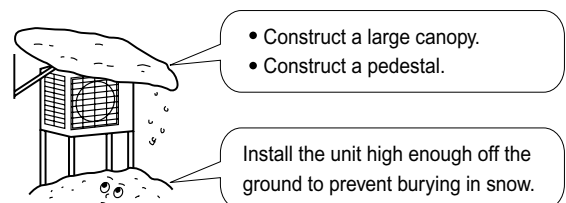

Indoor/Outdoor Unit Installation Drawings

For installation of the indoor units, refer to the installation manual which was provided with the units.
(The diagram shows a wall-mounted indoor unit.)

⚠ CAUTION

Do not connect the embedded branch piping and the outdoor unit when only carrying out piping work without connecting the indoor unit in order to add another indoor unit later.
Make sure no dirt or moisture gets into either side of the embedded branch piping.
See "Precautions for Laying Refrigerant Piping" on page 9 for details.

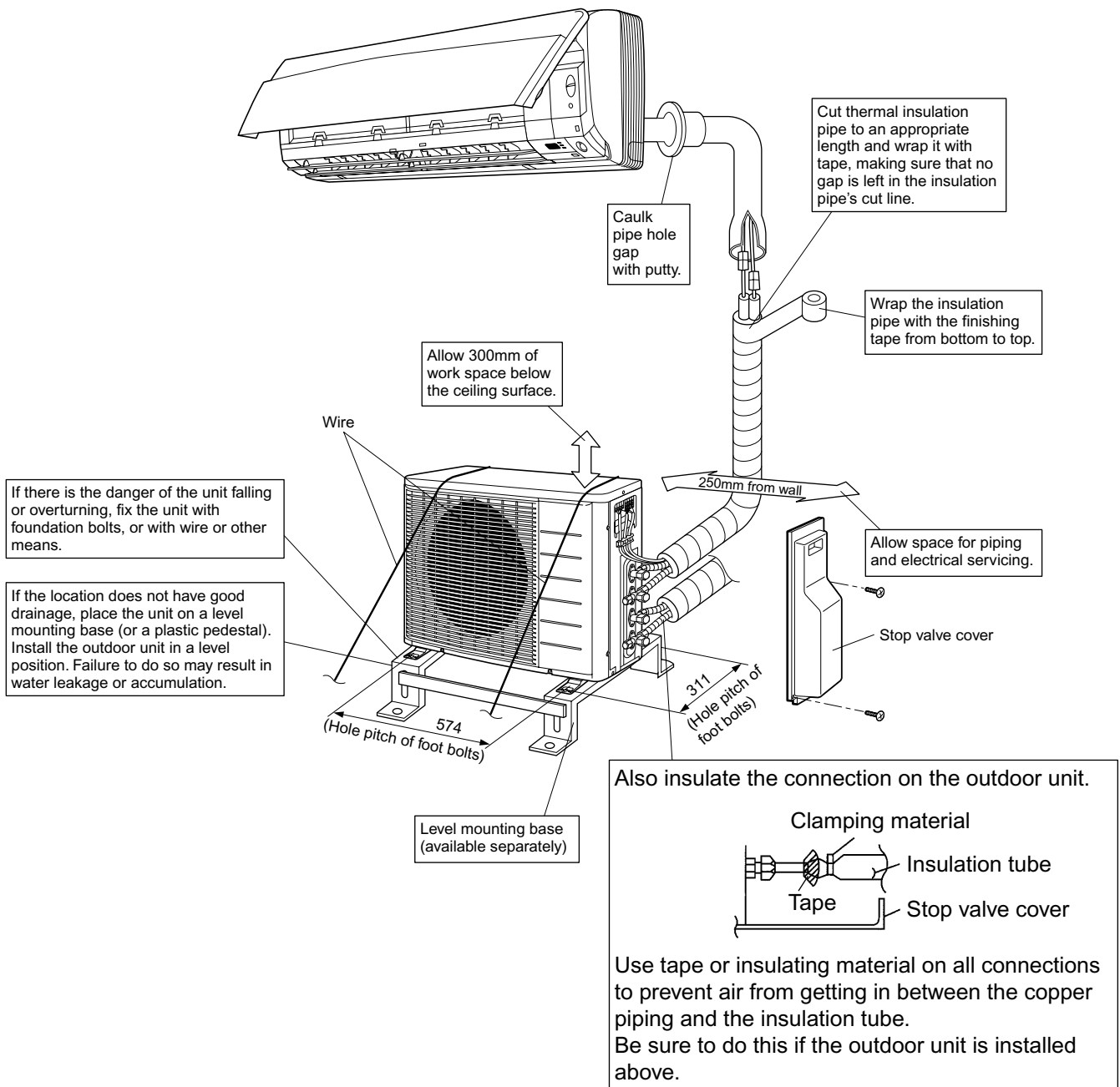

Installation

- Install the unit horizontally.
- The unit may be installed directly on a concrete verandah or a solid place if drainage is good.
- If the vibration may possibly be transmitted to the building, use a vibration-proof rubber (field supply).

1. Connections (connection port)

Install the indoor unit according to the table below, which shows the relationship between the class of indoor unit and the corresponding port.

The total indoor unit class that can be connected to this unit:

2AMX40F* 2AMX40G* 2MXS40G* 2MKS40G* 2MXS40H* 2MKS40H*	}	Up to 6.0kW	2AMX50F* 2AMX50G* 2MXS50G* 2MKS50G* 2MXS50H* 2MKS50H*	}	Up to 8.5kW
--	---	-------------	--	---	-------------

Port	2AMX40F*	2AMX50F*	2AMX40G* 2MXS40G* 2MKS40G* 2MXS40H* 2MKS40H*	2AMX50G* 2MXS50G* 2MKS50G* 2MXS50H* 2MKS50H*
A	20, 25, 35	20, 25, 35	20, 25, 35	20, 25, 35, 42
B	20, 25, 35	⓪, ⓪, ⓪, 50	20, 25, 35	⓪, ⓪, ⓪, ⓪, 50

⓪ : Use a reducer to connect pipes.

Refer to "How to Use Reducers" for information on reducer numbers and their shapes.

How to Use Reducers

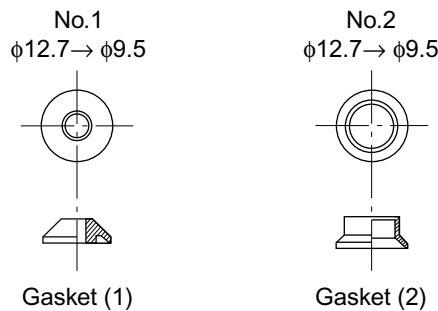

Use the reducers supplied with the unit as described below.

- Connecting a pipe of φ9.5 to a gas pipe connection port for φ12.7:

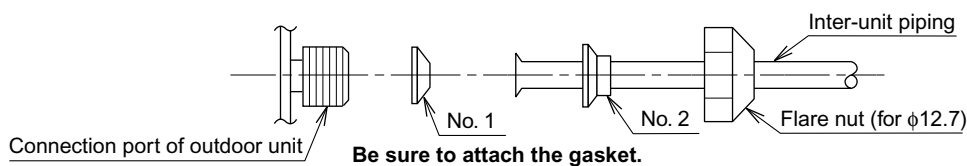

- When using the reducer packing shown above, be careful not to overtighten the nut, or the smaller pipe may be damaged. (about 2/3 - 1 the normal torque)
- Apply a coat of refrigeration oil to the threaded connection port of the outdoor unit where the flare nut comes in.
- Use an appropriate wrench to avoid damaging the connection thread by overtightening the flare nut.

Flare nut tightening torque	
Flare nut for φ12.7	49.5–60.3N·m (505–615kgf·cm)

Precautions on Installation

- Check the strength and level of the installation ground so that the unit will not cause any operating vibration or noise after installed.
- In accordance with the foundation drawing in fix the unit securely by means of the foundation bolts. (Prepare four sets of M8 or M10 foundation bolts, nuts and washers each which are available on the market.)
- It is best to screw in the foundation bolts until their length are 20mm from the foundation surface.

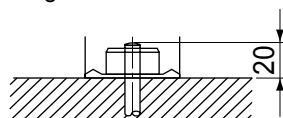

Outdoor Unit Installation Guideline

- Where a wall or other obstacle is in the path of outdoor unit's intake or exhaust airflow, follow the installation guidelines below.
- For any of the below installation patterns, the wall height on the exhaust side should be 1200mm or less.

Wall facing one side

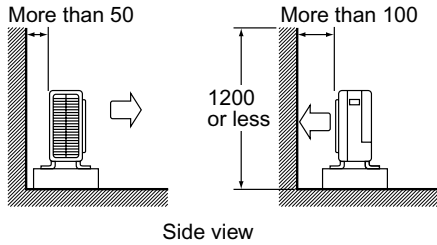

Walls facing two sides

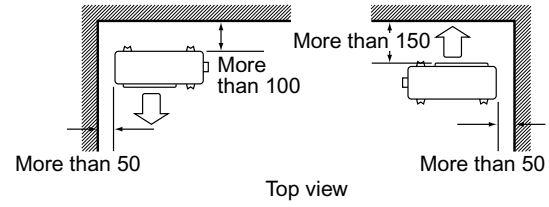

Walls facing three sides

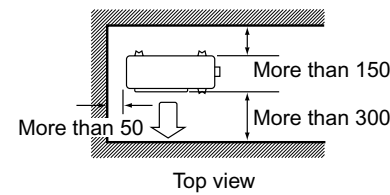

Unit: mm

Selecting a Location for Installation of the Indoor Units

- The maximum allowable length of refrigerant piping, and the maximum allowable height difference between the outdoor and indoor units, are listed below.
(The shorter the refrigerant piping, the better the performance. Connect so that the piping is as short as possible. **Shortest allowable length per room is 3m.**)

Piping to each indoor unit	20m max.
Total length of piping between all units	30m max.

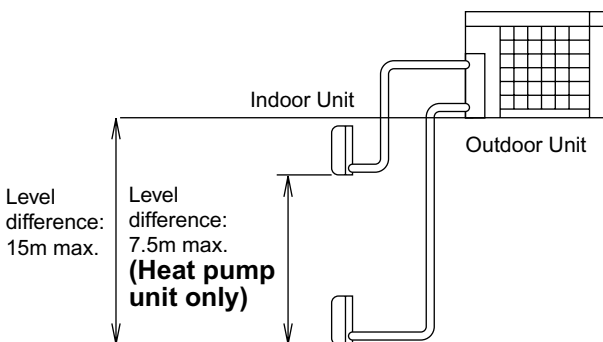

If the outdoor unit is positioned higher than the indoor units.

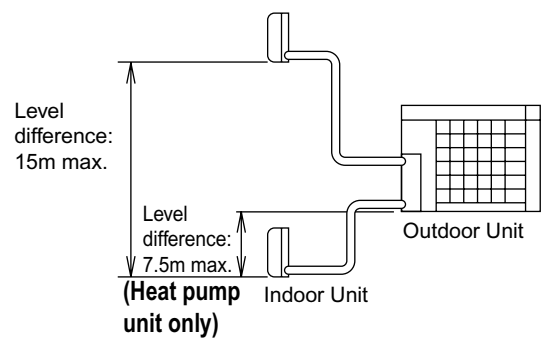

If the outdoor unit is positioned otherwise.
(If lower than one or more indoor units.)

Refrigerant Piping Work

1. Installing outdoor unit

- 1) When installing the outdoor unit, refer to "Precautions for Selecting the Location" on page 2 and the "Indoor/Outdoor Unit Installation Drawings" on page 3.
- 2) If drain work is necessary, follow the procedures below.

2. Drain work (Heat pump only)

- 1) Use drain plug for drainage.
- 2) If the drain port is covered by a mounting base or floor surface, place additional foot bases of at least 30mm in height under the outdoor unit's feet.
- 3) In cold areas, do not use a drain hose with the outdoor unit. (Otherwise, drain water may freeze, impairing heating performance.)

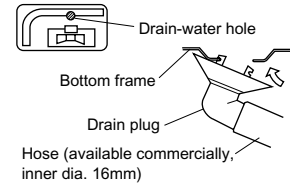

3. Refrigerant piping

⚠ CAUTION

- 1) Use the flare nut fixed to the main unit. (To prevent cracking of the flare nut by aged deterioration.)
- 2) To prevent gas leakage, apply refrigeration oil only to the inner surface of the flare. (Use refrigeration oil for R410A.)
- 3) Use torque wrenches when tightening the flare nuts to prevent damage to the flare nuts and gas leakage.

Align the centres of both flares and tighten the flare nuts 3 or 4 turns by hand. Then tighten them fully with the torque wrenches.

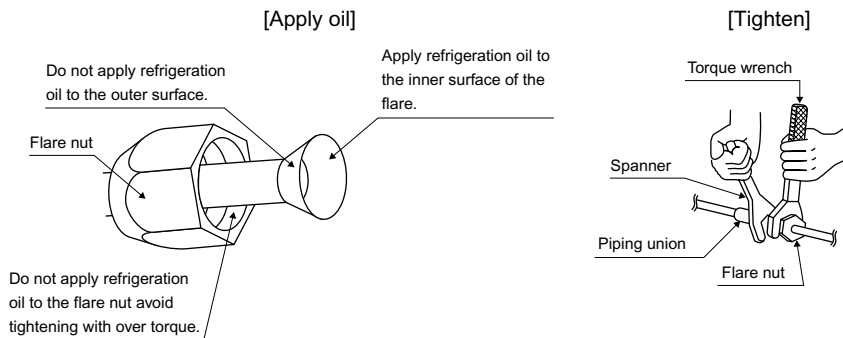

Flare nut tightening torque	
Flare nut for $\phi 6.4$	14.2-17.2N • m (144-175kgf • cm)
Flare nut for $\phi 9.5$	32.7-39.9N • m (333-407kgf • cm)
Flare nut for $\phi 12.7$	49.5-60.3N • m (505-615kgf • cm)

Valve cap tightening torque		
Gas side		Liquid side
3/8 inch	1/2 inch	1/4 inch
21.6-27.4N • m (220-280kgf • cm)	48.1-59.7N • m (490-610kgf • cm)	21.6-27.4N • m (220-280kgf • cm)
Service port cap tightening torque	10.8-14.7N • m (110-150kgf • cm)	

Refrigerant Piping Work

4. Purging air and checking gas leakage

⚠ WARNING

- 1) Do not mix any substance other than the specified refrigerant (R410A) into the refrigeration cycle.
- 2) When refrigerant gas leaks occur, ventilate the room as soon and as much as possible.
- 3) R410A, as well as other refrigerants, should always be recovered and never be released directly into the environment.
- 4) Be sure to check for gas leaks.

- Be sure to perform vacuum pumping for all the rooms at the same time.
- Be sure to use the special tools for the R410A (gauge manifold, charge hose, vacuum pump, vacuum pump adapter, etc.).
- Use a hexagonal wrench (4mm) to operate the stop valve rod.
- All refrigerant pipe joints should be tightened with a torque wrench at the specified tightening torque.

1) Connect the charge hose protrusions (the side for pushing the pin) for low pressure and high pressure on the gauge manifold to the gas stop valve service port for rooms **A and B**.



2) Fully open gauge manifold's low-pressure valve (Lo) and high-pressure valve (Hi).



3) Apply vacuum pumping for 20 minutes or longer. Check that the compound pressure gauge reads -0.1MPa (-76cmHg).



4) After checking the vacuum, close the low pressure and high pressure valves on the gauge manifold and stop the vacuum pump. (Leave as is for 4-5 minutes and make sure the coupling meter needle does not go back.) If it does go back, this may indicate the presence of moisture or leaking from connecting parts. After inspecting all the connection and loosening then retightening the nuts, repeat steps 2) → 3) → 4).



5) Remove the valve caps on the liquid and gas stop valves at the pipes for rooms A and B.



6) Open the valve rods on the liquid stop valves for rooms A and B by turning them 90° counterclockwise using a hex wrench. Close them 5 seconds later and check for gas leaks. After checking for gas leaks, check the areas around flares on the indoor unit, and the areas around flares and valve rods on the outdoor unit by applying soapy water. Wipe down thoroughly after the check is complete.



7) Remove the charge hose from the gas stop valve service ports at the pipes for rooms A and B and completely open the liquid and gas stop valves at the pipes for rooms A and B. (Stop the valve rods as far as they go and do not attempt to turn them any further.)



8) Use a torque wrench to tighten the valve caps and service port caps on the liquid and gas stop valves at the pipes for rooms A and B to the designated torque.

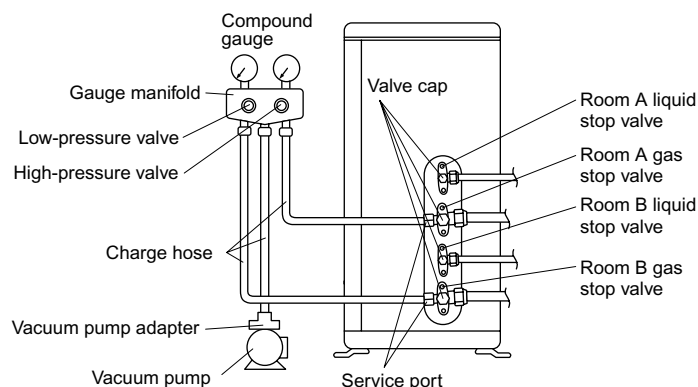

5. Refilling the refrigerant

Check the type of refrigerant to be used on the machine nameplate.

Precautions when adding R410A

Fill from the liquid pipe in liquid form.

It is a mixed refrigerant, so adding it in gas form may cause the refrigerant composition to change, preventing normal operation.

- 1) Before filling, check whether the cylinder has a siphon attached or not. (It should have something like "liquid filling siphon attached" displayed on it.)

Filling a cylinder with an attached siphon

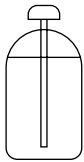

Stand the cylinder upright when filling.

(There is a siphon pipe inside, so the cylinder need not be upside-down to fill with liquid.)

Filling other cylinders



Turn the cylinder upside-down when filling.

- 2) Be sure to use the R410A tools to ensure pressure and to prevent foreign objects entering.

6. Charging with refrigerant

- If the total length of piping for all rooms exceeds 20m, additionally charge with **(R410A) 20g** of refrigerant for each additional meter of piping.

Important information regarding the refrigerant used

This product contains fluorinated greenhouse gases covered by the Kyoto Protocol.

Do not vent gases into the atmosphere.

Refrigerant type: **R410A**

GWP⁽¹⁾ value: **1975**

⁽¹⁾ GWP = global warming potential

Please fill in with indelible ink,

- ① the factory refrigerant charge of the product,
- ② the additional refrigerant amount charged in the field and
- ①+② the total refrigerant charge

on the refrigerant charge label supplied with the product.

The filled out label must be adhered in the proximity of the product charging port (e.g. onto the inside of the stop valve cover).

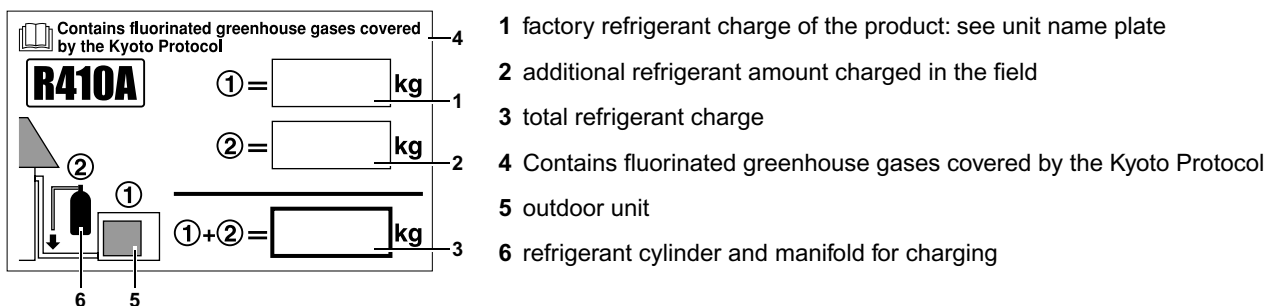

NOTE:

National implementation of EU regulation on certain fluorinated greenhouse gases may require to provide the appropriate official national language on the unit. Therefore an additional multilingual fluorinated greenhouse gases label is supplied with the unit.

Sticking instructions are illustrated on the backside of that label.

⚠ CAUTION

- 1) Even though the stop valve is fully closed, the refrigerant may slowly leak out; do not leave the flare nut removed for a long period of time.
- 2) Do not overfill with refrigerant. This will break the compressor.

Refrigerant Piping Work

Precautions for Laying Refrigerant Piping

• Cautions on pipe handling

- 1) Protect the open end of the pipe against dust and moisture.
- 2) All pipe bends should be as gentle as possible. Use a pipe bender for bending.

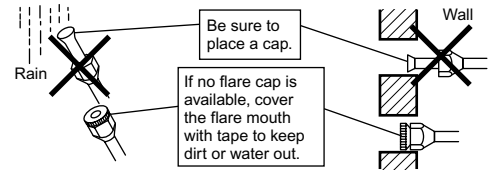

• Selection of copper and heat insulation materials

When using commercial copper pipes and fittings, observe the following:

- 1) Insulation material: Polyethylene foam
Heat transfer rate: 0.041 to 0.052W/mK (0.035 to 0.045kcal/mh°C)
Refrigerant gas pipe's surface temperature reaches 110°C max.
Choose heat insulation materials that will withstand this temperature.
- 2) Be sure to insulate both the gas and liquid piping and to provide insulation dimensions as below.

Gas pipe		Liquid pipe	Gas pipe insulation	Liquid pipe insulation
O.D.9.5mm	O.D.12.7mm	O.D.6.4mm	I.D.12-15mm	I.D.8-10mm
Minimum bend radius			Thickness 13mm Min	Thickness 10mm Min
30mm or more	40mm or more	30mm or more		
Thickness 0.8mm (C1220T-O)				

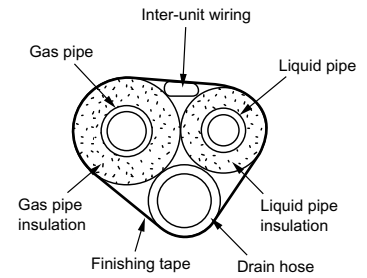

- 3) Use separate thermal insulation pipes for gas and liquid refrigerant pipes.

• Flaring the pipe end

- 1) Cut the pipe end with a pipe cutter.
- 2) Remove burrs with the cut surface facing downward so that the chips do not enter the pipe.
- 3) Put the flare nut on the pipe.
- 4) Flare the pipe.
- 5) Check that the flaring is properly made.



Flaring			
Set exactly at the position shown below.			
A	Flare tool for R410A	Conventional flare tool	
	Clutch-type	Clutch-type (Rigid-type)	Wing-nut type (Imperial-type)
	0-0.5mm	1.0-1.5mm	1.5-2.0mm

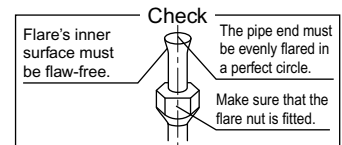

⚠ WARNING

- 1) Do not use mineral oil on flared part.
- 2) Prevent mineral oil from getting into the system as this would reduce the lifetime of the units.
- 3) Never use piping which has been used for previous installations. Only use parts which are delivered with the unit.
- 4) Do never install a drier to this R410A unit in order to guarantee its lifetime.
- 5) The drying material may dissolve and damage the system.
- 6) Incomplete flaring may cause refrigerant gas leakage.

Pump Down Operation

In order to protect the environment, be sure to pump down when relocating or disposing of the unit.

- 1) Remove the valve caps on the liquid and the gas stop valves at the pipes for rooms A and B.
- 2) Run the unit on forced cooling. (Refer to the below.)
- 3) After 5 to 10 minutes, close the liquid stop valves at the pipes for rooms A and B using a hex wrench.
- 4) After 2 to 3 minutes, stop the forced cooling operation as quickly as possible after the gas stop valves at the pipes for rooms A and B have been shut off.
- 5) Turn the power breaker off.

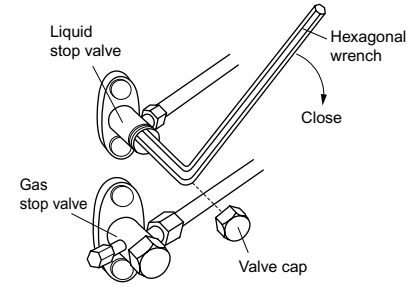

⚠ CAUTION

Run the air conditioner to cool both rooms A and B when performing a pump down.

1. Forced cooling operation

1-1. Using the indoor unit start/stop button.

- 1) Press the start/stop button on the indoor unit in either room A or B for 5 seconds continuously. The units in both rooms will start.
- 2) Forced cooling operation will end after around 15 minutes and the unit will stop automatically. Press the start/stop button on the indoor unit to force the operation to stop.
- 3) **Use this method to force cooling operation when the outside temperature is 10°C or lower.**

1-2. Using the wireless remote controller.

- 1) Select cooling operation and press the start/stop button. (The unit will start.)
- 2) Press the temperature ▲ button, ▼ button, and the "mode" button at the same time.
- 3) Press the "mode" button twice.
(7 will be displayed and the unit will go into test-run mode.)
- 4) Test-run mode will end after around 30 minutes and the unit will stop automatically. Press the start/stop button to force the test-run to stop.

⚠ CAUTION

If the outside temperature is 10°C or lower, the safety device might start, preventing operation. In this situation, warm the outside temperature thermistor on the outdoor unit to 10°C or warmer. Operation will start.

Wiring

⚠ WARNING

- 1) Do not use tapped wires, stranded wires (**CAUTION 1**)), extension cords, or starburst connections, as they may cause overheating, electrical shock, or fire.
- 2) Do not use locally purchased electrical parts inside the product. (Do not branch the power for the drain pump, etc., from the terminal block.) Doing so may cause electric shock or fire.
- 3) Be sure to install an earth leakage breaker. (One that can handle higher harmonics.)
(This unit uses an inverter, which means that it must be used an earth leakage breaker capable handling harmonics in order to prevent malfunctioning of the earth leakage breaker itself.)
- 4) Use an all-pole disconnection type breaker with at least 3mm between the contact point gaps.
- 5) Do not connect the power wire to the indoor unit. Doing so may cause electric shock or fire.

- Do not turn ON the safety breaker until all work is completed.

- 1) Strip the insulation from the wire (20mm).
- 2) Connect the connection wires between the indoor and outdoor units **so that the terminal numbers match**. Tighten the terminal screws securely. We recommend a flathead screwdriver be used to tighten the screws. The screws are packed with the terminal board.

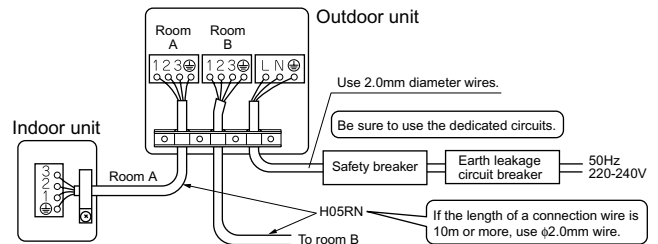

⚠ CAUTION

- 1) In case using stranded wires is unavoidable for some reason, make sure to install the round crimp-style terminals on the tip. Place the round crimp-style terminals on the wires up to the covered part and secure in place.
- 2) When connecting the connection wires to the terminal board using a single core wire, be sure to perform curling. Problems with the work may cause heat and fires.

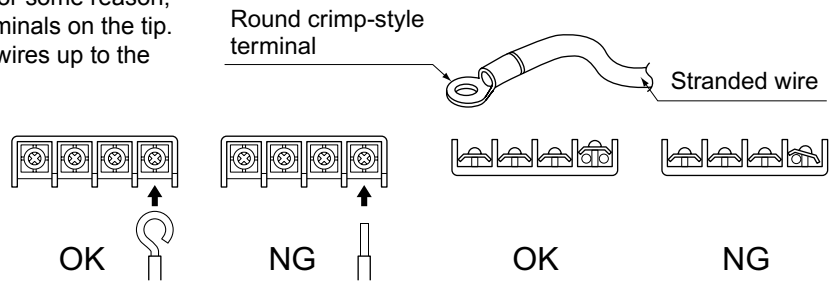

- 3) Pull the wire and make sure that it does not disconnect. Then fix the wire in place with a wire retainer.

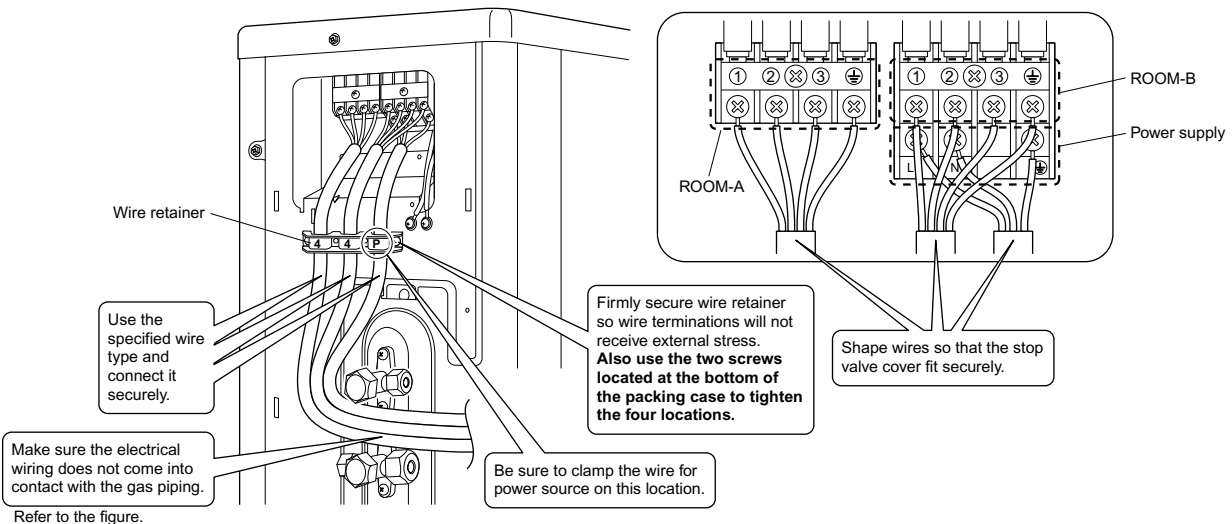

Make sure connecting the piping and connecting wiring fit into .

(Incorrect handling will make it hard to attach the stop valve cover, causing deformation.)

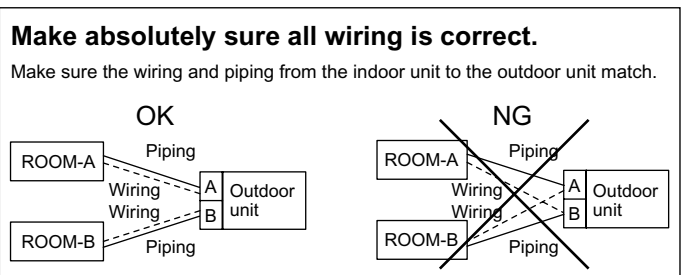
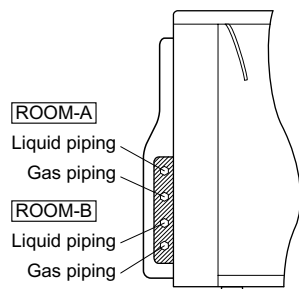

Maximum Power Input Limitation Setting

⚠ WARNING

Always shut off the power supply breaker before starting.

- The Maximum Power Input Limitation needs to be set when the unit is installed.
- This function limits the power input of the unit to 1700W.
- It is recommended for locations with low-capacity circuit breakers.

⚠ CAUTION

This function is only for the 2MKS40 and 2MKS50.

- Set as follows.
 - 1) Remove the two screws on the side and remove the top plate of the outdoor unit.
 - 2) Remove one screw from the upper electric box cover.
 - 3) Remove the upper electric box cover by sliding it, being careful not to bend the electric box hook.
 - 4) Remove the lower electric box cover.
 - 5) Cut the jumper (J4) of the PCB inside.
 - 6) Go back through step 4) → 3) → 2) → 1). Make sure all components are well secured when doing this.

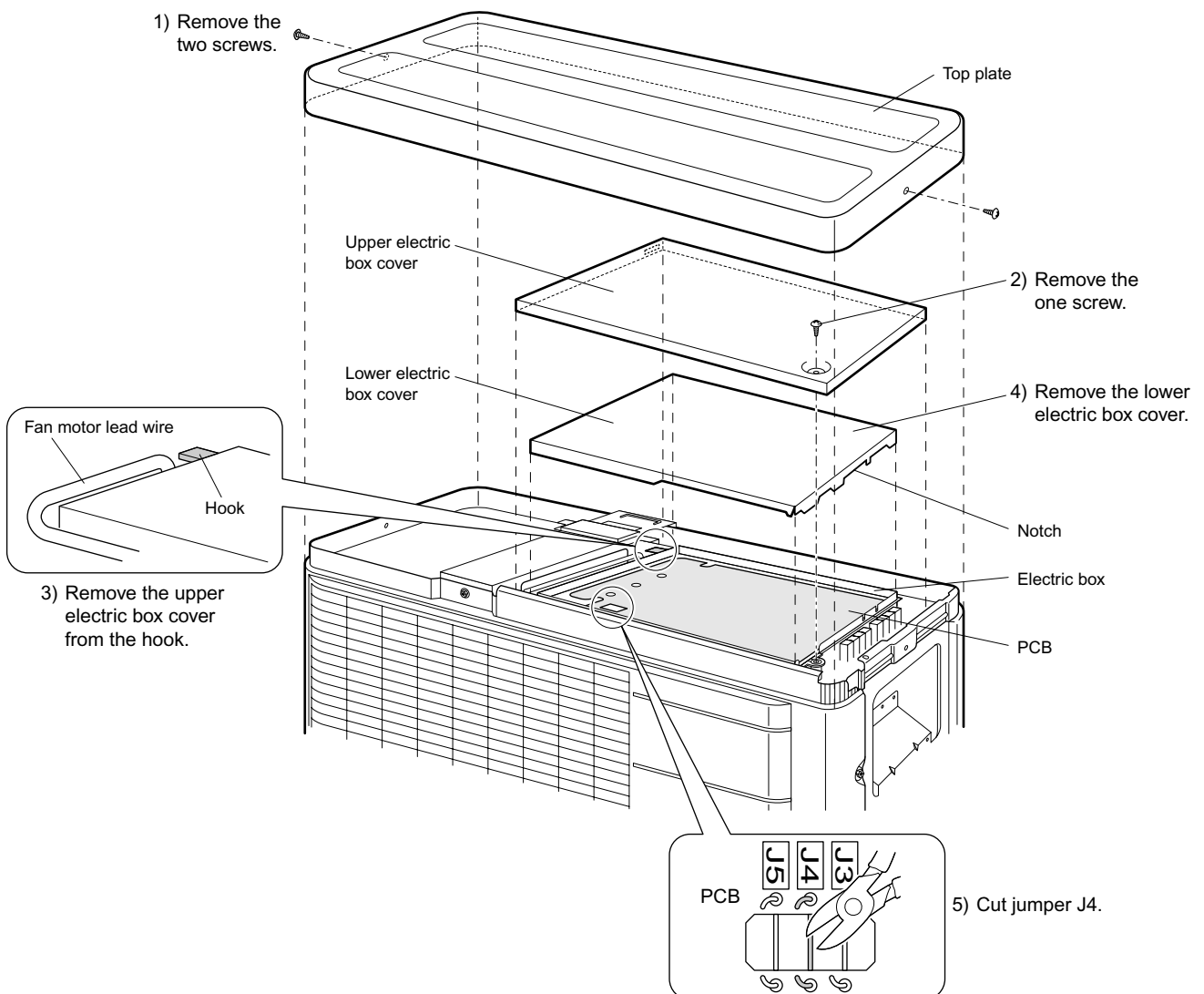

⚠ CAUTION

- When removing the upper electric box cover, be careful not to bend the hook.
- When returning the lower electric box cover, return the notch to the stop valve side.
- When returning the upper electric box cover, be careful not to pinch the fan motor lead wire.

ECONO Mode Prohibition Setting

⚠ WARNING

Always shut off the power supply breaker before starting.

- This setting disables the input control signal from the remote controller.
- Use this setting when you wish to block reception of input controls (cooling/heating) from indoor unit remote controllers.
- Set as follows.

- 1) Remove the two screws on the side and remove the top plate of the outdoor unit.
- 2) Remove one screw from the upper electric box cover.
- 3) Remove the upper electric box cover by sliding it, being careful not to bend the electric box hook.
- 4) Remove the lower electric box cover.
- 5) Cut the jumper (J3) of the PCB inside.
- 6) Go back through step 4) → 3) → 2) → 1). Make sure all components are well secured when doing this.

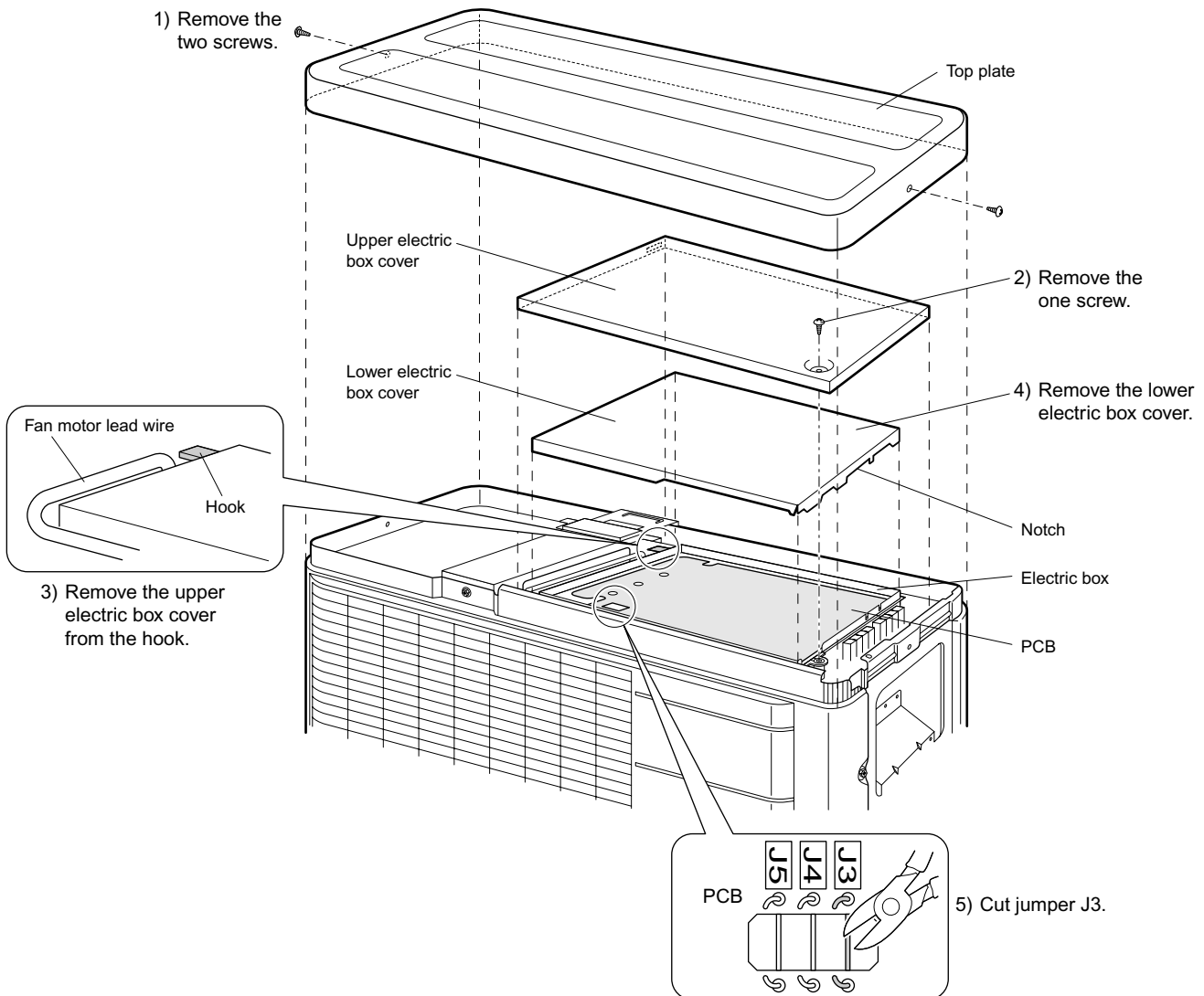

⚠ CAUTION

- When removing the upper electric box cover, be careful not to bend the hook.
- When returning the lower electric box cover, return the notch to the stop valve side.
- When returning the upper electric box cover, be careful not to pinch the fan motor lead wire.

Test Run and Final Check

- Before starting the test run, measure the voltage at the primary side of the safety breaker.
- Check that all liquid and gas stop valves are fully open.
- Check that piping and wiring all match.

1. Test run and final check

- 1) To test cooling, set for the lowest temperature. To test heating, set for the highest temperature. (Depending on the room temperature, only heating or cooling (but not both) may be possible.)
- 2) After the unit is stopped, it will not start again (heating or cooling) for approximately 3 minutes.
- 3) During the test run, first check the operation of each unit individually. Then also check the simultaneous operation of all indoor units.
Check both heating and cooling operation.
- 4) After running the unit for approximately 20 minutes, measure the temperatures at the indoor unit inlet and outlet. If the measurements are above the values shown in the table below, then they are normal.

	Cooling	Heating
Temperature difference between inlet and outlet	Approx. 8°C	Approx. 15°C

(When running in one room)

- 5) During cooling operation, frost may form on the gas stop valve or other parts. This is normal.
- 6) Operate the indoor units in accordance with the included operation manual. Check that they operate normally.

2. Items to check

Check item	Consequences of trouble	Check
Are the indoor units installed securely?	Falling, vibration, noise	
Has an inspection been made to check for gas leakage?	No cooling, no heating	
Has complete thermal insulation been done (gas pipes, liquid pipes, indoor portions of the drain hose extension)?	Water leakage	
Is the drainage secure?	Water leakage	
Are the ground wire connections secure?	Danger in the event of a ground fault	
Are the electric wires connected correctly?	No cooling, no heating	
Is the wiring in accordance with the specifications?	Operation failure, burning	
Are the inlets/outlets of the indoor and outdoor units free of any obstructions? Are the stop valves open?	No cooling, no heating	
Do the marks match (room A, room B) on the wiring and piping for each indoor unit?	No cooling, no heating	

■ ATTENTION

- 1) Have the customer actually operate the unit while looking at the manual included with the indoor unit. Instruct the customer how to operate the unit correctly (particularly cleaning of the air filters, operation procedures, and temperature adjustment).
- 2) Even when the air conditioner is not operating, it consumes some electric power. If the customer is not going to use the unit soon after it is installed, turn OFF the breaker to avoid wasting electricity.
- 3) If additional refrigerant has been charged because of long piping, list the amount added on the nameplate on the reverse side of the stop valve cover.

DAIKIN INDUSTRIES, LTD.

Head office:
Umeda Center Bldg., 2-4-12, Nakazaki-Nishi,
Kita-ku, Osaka, 530-8323 Japan

Tokyo office:
JR Shinagawa East Bldg., 2-18-1, Konan,
Minato-ku, Tokyo, 108-0075 Japan
http://www.daikin.com/global_ac/

DAIKIN EUROPE NV

Zandvoordestraat 300, B-8400 Oostende, Belgium



Two-dimensional bar code is a code for manufacturing.

3P210724-1C M07B062C (1010) HT