

# Service Manual

# SUPER MULTI *NX*

## D-Series / E-Series



**[Applied Models]**

- Inverter Multi : Cooling Only
- Inverter Multi : Heat Pump

# **SUPER MULTI NX D-Series / E-Series**

## **●Cooling Only**

### **Indoor Unit**

FTKS25DVM	FDKS25CAVMB	FFQ25B8V1B
FTKS35DVM	FDKS35CAVMB	FFQ35B8V1B
FTKS50BVMB	FDKS50CVMB	FFQ50B8V1B
FTKS60BVMB	FDKS60CVMB	FFQ60B8V1B
FTKS71BVMB	FDKS25EAVMB	
FTKS20DVMA	FDKS35EAVMB	
FTKS25EVMA	CDKS25CVMA	
FTKS35EVMA	CDKS35CVMA	
FTKS50FVM	CDKS50CVMA	
FTKS60FVM	CDKS60CVMA	
FTKS71FVM	CDKS25DVMT	
FTKS50FVMA	CDKS35DVMT	
FTKS60FVMA	CDKS50DVMT	
FTKS71FVMA	CDKS60DVMT	
FTKS20DVMT	CDKS25EAVMA	
FTKS25DVMT	CDKS35EAVMA	
FTKS35DVMT	CDKS25EAVMT	
FTKS50DVMT	CDKS35EAVMT	
FTKS60DVMT		
FTKS71DVMT		
FTKS50FVLT		
FTKS60FVLT		
FTKS71FVLT		

### **Outdoor Unit**

3MKS58EVMA	3MKS90EVLT	3MKS50DVM
3MKS75EVMA	4MKS100EVLT	4MKS71DVM
4MKS90EVMA		3MKS50ESG
		3MKS71ESG
		4MKS80ESG

**●Heat Pump****Indoor Unit**

FTXS20DVMA  
FTXS25EVMA  
FTXS35EVMA  
FTXS50FVMA  
FTXS60FVMA  
FTXS71FVMA  
FTXS20DVMT  
FTXS25DVMT  
FTXS35DVMT  
FTXS50DVMT  
FTXS60DVMT  
FTXS71DVMT  
FTXS50FVLT  
FTXS60FVLT  
FTXS71FVLT

FDXS25CVMA  
FDXS35CVMA  
FDXS50CVMA  
FDXS60CVMA  
CDXS25DVMT  
CDXS35DVMT  
CDXS50DVMT  
CDXS60DVMT  
CDXS25EAVMA  
CDXS35EAVMA  
CDXS25EAVMT  
CDXS35EAVMT

FLXS25BVMA  
FLXS35BVMA  
FLXS50BVMA  
FLXS60BVMA  
FVXS35BVMA  
FVXS50BVMA  
FFQ25B8V1B  
FFQ35B8V1B  
FFQ50B8V1B  
FFQ60B8V1B

**Outdoor Unit**

3MXS52EVMA  
3MXS68EVMA  
4MXS80EVMA

3MXS90EVLT  
4MXS100EVLT

1. Introduction .....	vii
1.1 Safety Cautions .....	vii
1.2 Used Icons .....	xi
<b>Part 1 List of Functions .....</b>	<b>1</b>
1. List of Functions .....	2
1.1 Cooling Only .....	2
1.2 Heat Pump .....	10
<b>Part 2 Specifications .....</b>	<b>17</b>
1. Specifications .....	18
1.1 Indoor Units - Cooling Only .....	18
1.2 Outdoor Units - Cooling Only .....	32
1.3 Indoor Units - Heat Pump .....	38
1.4 Outdoor Units - Heat Pump .....	48
<b>Part 3 Printed Circuit Board Connector Wiring Diagram .....</b>	<b>51</b>
1. Printed Circuit Board Connector Wiring Diagram .....	52
1.1 Wall Mounted Type .....	52
1.2 Duct Connected Type .....	56
1.3 Floor / Ceiling Suspended Dual Type .....	58
1.4 Floor Standing Type .....	61
1.5 Ceiling Mounted Cassette Type (600x600) .....	64
1.6 Outdoor Units – E Series (50-58 Class, 80-100 Class) .....	67
1.7 Outdoor Units – E Series (68-75 Class) .....	70
1.8 Outdoor Units – D Series .....	73
<b>Part 4 Function and Control .....</b>	<b>77</b>
1. Main Functions .....	78
1.1 Frequency Principle .....	78
1.2 Power-Airflow Dual Flaps, Wide Angle Louvers and Auto-Swing .....	80
1.3 Fan Speed Control for Indoor Units .....	81
1.4 Programme Dry Function .....	82
1.5 Automatic Operation .....	83
1.6 Thermostat Control .....	84
1.7 Night Set Mode .....	85
1.8 ECONO Mode .....	86
1.9 MOLD PROOF Operation .....	87
1.10 INTELLIGENT EYE (Wall Mounted Type Only) .....	88
1.11 HOME LEAVE Operation .....	90
1.12 Inverter POWERFUL Operation .....	91
1.13 Other Functions .....	92
2. Function of Main Structural Parts .....	94
2.1 Main Structural Parts .....	94
2.2 Function of Thermistor .....	95
3. Control Specification .....	99
3.1 Mode Hierarchy .....	99
3.2 Frequency Control .....	100
3.3 Controls at Mode Changing / Start-up .....	103

3.4	Discharge Pipe Temperature Control.....	104
3.5	Input Current Control.....	104
3.6	Freeze-up Protection Control .....	105
3.7	Heating Peak-cut Control .....	105
3.8	Fan Control.....	106
3.9	Liquid Compression Protection Function 2.....	106
3.10	Defrost Control .....	107
3.11	Low Hz High Pressure Limit .....	108
3.12	Electronic Expansion Valve Control .....	108
3.13	Malfunctions .....	112
3.14	Forced Operation Mode .....	113
3.15	Wiring-Error Check.....	114
3.16	Additional Function.....	116

## **Part 5 Operation Manual ..... 119**

1.	System Configuration.....	120
1.1	Operation Instructions .....	120
2.	Instruction.....	121
2.1	FTK(X)S, CDK(X)S, FDK(X)S, FLXS, FVXS Series.....	121
2.2	FFQ 25/35/50/60 B.....	189

## **Part 6 Service Diagnosis..... 201**

1.	Caution for Diagnosis.....	202
1.1	Troubleshooting with Operation Lamp .....	202
2.	Problem Symptoms and Measures .....	204
3.	Service Check Function .....	205
4.	Code Indication on the Remote Controller .....	208
4.1	Error Codes and Description of Fault .....	208
5.	Troubleshooting .....	209
5.1	Indoor Units .....	209
5.2	Outdoor Units .....	210
5.3	Indoor Unit PCB Abnormality .....	211
5.4	Freeze-up Protection Control or High Pressure Control.....	212
5.5	Fan Motor or Related Abnormality .....	214
5.6	Thermistor or Related Abnormality (Indoor Unit).....	217
5.7	Shutter Drive Motor / Shutter Limit Switch Abnormality .....	218
5.8	Signal Transmission Error (between Indoor and Outdoor Units).....	219
5.9	Unspecified Voltage (between Indoor and Outdoor Units) .....	221
5.10	Freeze-up Protection Control .....	222
5.11	Outdoor Unit PCB Abnormality.....	224
5.12	OL Activation (Compressor Overload) .....	225
5.13	Compressor Lock .....	226
5.14	DC Fan Lock .....	228
5.15	Input Over Current Detection .....	229
5.16	Four Way Valve Abnormality .....	231
5.17	Discharge Pipe Temperature Control.....	233
5.18	High Pressure Control in Cooling .....	234
5.19	Compressor Sensor System Abnormality .....	236
5.20	Position Sensor Abnormality .....	238
5.21	CT or Related Abnormality .....	239

5.22	Thermistor or Related Abnormality (Outdoor Unit)	241
5.23	Electrical Box Temperature Rise	243
5.24	Radiation Fin Temperature Rise	247
5.25	Output Over Current Detection	251
5.26	Insufficient Gas	253
5.27	Low-voltage Detection or Over-voltage Detection	257
5.28	Signal Transmission Error (on Outdoor Unit PCB)	258
5.29	Anti-icing Function in Other Rooms / Unspecified Voltage (between Indoor and Outdoor Units)	259
6.	Check	260
6.1	How to Check	260

## **Part 7 Removal Procedure ..... 271**

1.	Outdoor Unit – E Series (50 / 52 / 58 Class)	272
1.1	Removal of the Panels and Plates	272
1.2	Removal of the Electrical Box	277
1.3	Removal of the PCB	284
1.4	Removal of the Propeller Fan / Fan Motor	290
1.5	Removal of the Sound Blanket	292
1.6	Removal of Electronic Expansion Valve Coil, Four Way Valve Coil and Thermistor	296
1.7	Removal of the Distributor	299
1.8	Removal of the Four Way Valve	300
1.9	Removal of the Compressor	301
2.	Outdoor Unit – E Series (68 / 71 / 75 Class), D Series	303
2.1	Removal of the Outer Panels	303
2.2	Removal of the Electrical BOX	304
2.3	Removal of the PCB	308
2.4	Removal of the Fan Motor	311
2.5	Removal of the Sound Blanket	312
2.6	Removal of the Four Way Valve Coil, Solenoid Valve Coil, Electronic Expansion Valve Coil and Thermistor	313
2.7	Removal of the Four Way Valve, Solenoid Valve and Shunt	315
2.8	Removal of the Solenoid Valve and Shunt	316
2.9	Removal of the Compressor	317
3.	Outdoor Unit – E Series (80 / 90 / 100 Class)	318
3.1	Removal of Outer Panels	318
3.2	Removal of the Electrical Box	334
3.3	Removal of PCB	340
3.4	Removal of Fan Motor	344
3.5	Removal of Coils / Thermistors	345
3.6	Removal of Sound Blanket	351
3.7	Removal of Compressor	354

## **Part 8 Others ..... 355**

1.	Others	356
1.1	Test Run from the Remote Controller	356
1.2	Jumper Settings	357
1.3	Application of Silicon Grease to a Power Transistor and a Diode Bridge	358





---

<b>Part 9 Appendix.....</b>	<b>359</b>
1. Piping Diagrams.....	360
1.1 Indoor Units.....	360
1.2 Outdoor Units.....	364
2. Wiring Diagrams.....	370
2.1 Indoor Units.....	370
2.2 Outdoor Units.....	376
<b>Index .....</b>	<b>i</b>
<b>Drawings &amp; Flow Charts .....</b>	<b>vii</b>







# 1. Introduction

## 1.1 Safety Cautions



### Cautions and Warnings









- Be sure to read the following safety cautions before conducting repair work.
- The caution items are classified into “ **Warning**” and “ **Caution**”. The “ **Warning**” items are especially important since they can lead to death or serious injury if they are not followed closely. The “ **Caution**” items can also lead to serious accidents under some conditions if they are not followed. Therefore, be sure to observe all the safety caution items described below.
- About the pictograms
  - △ This symbol indicates the item for which caution must be exercised.  
The pictogram shows the item to which attention must be paid.
  - This symbol indicates the prohibited action.  
The prohibited item or action is shown in the illustration or near the symbol.
  - This symbol indicates the action that must be taken, or the instruction.  
The instruction is shown in the illustration or near the symbol.
- After the repair work is complete, be sure to conduct a test operation to ensure that the equipment operates normally, and explain the cautions for operating the product to the customer.

### 1.1.1 Cautions Regarding Safety of Workers











 <b>Warning</b>	
Be sure to disconnect the power cable plug from the plug socket before disassembling the equipment for repair. Working on the equipment that is connected to the power supply may cause an electrical shock. If it is necessary to supply power to the equipment to conduct the repair or inspecting the circuits, do not touch any electrically charged sections of the equipment.	
If the refrigerant gas is discharged during the repair work, do not touch the discharged refrigerant gas. The refrigerant gas may cause frostbite.	
When disconnecting the suction or discharge pipe of the compressor at the welded section, evacuate the refrigerant gas completely at a well-ventilated place first. If there is a gas remaining inside the compressor, the refrigerant gas or refrigerating machine oil discharges when the pipe is disconnected, and it may cause injury.	
If the refrigerant gas leaks during the repair work, ventilate the area. The refrigerant gas may generate toxic gases when it contacts flames.	
The step-up capacitor supplies high-voltage electricity to the electrical components of the outdoor unit. Be sure to discharge the capacitor completely before conducting repair work. A charged capacitor may cause an electrical shock.	
Do not start or stop the air conditioner operation by plugging or unplugging the power cable plug. Plugging or unplugging the power cable plug to operate the equipment may cause an electrical shock or fire.	













 <b>Warning</b>	
Be sure to wear a safety helmet, gloves, and a safety belt when working at a high place (more than 2m). Insufficient safety measures may cause a fall accident.	
In case of R410A refrigerant models, be sure to use pipes, flare nuts and tools for the exclusive use of the R410A refrigerant. The use of materials for R22 refrigerant models may cause a serious accident such as a damage of refrigerant cycle as well as an equipment failure.	





 <b>Caution</b>	
Do not repair the electrical components with wet hands. Working on the equipment with wet hands may cause an electrical shock.	
Do not clean the air conditioner by splashing water. Washing the unit with water may cause an electrical shock.	
Be sure to provide the grounding when repairing the equipment in a humid or wet place, to avoid electrical shocks.	
Be sure to turn off the power switch and unplug the power cable when cleaning the equipment. The internal fan rotates at a high speed, and cause injury.	
Be sure to conduct repair work with appropriate tools. The use of inappropriate tools may cause injury.	
Be sure to check that the refrigerating cycle section has cooled down enough before conducting repair work. Working on the unit when the refrigerating cycle section is hot may cause burns.	
Use the welder in a well-ventilated place. Using the welder in an enclosed room may cause oxygen deficiency.	

## 1.1.2 Cautions Regarding Safety of Users

 <b>Warning</b>	
<p>Be sure to use parts listed in the service parts list of the applicable model and appropriate tools to conduct repair work. Never attempt to modify the equipment. The use of inappropriate parts or tools may cause an electrical shock, excessive heat generation or fire.</p>	
<p>If the power cable and lead wires have scratches or deteriorated, be sure to replace them. Damaged cable and wires may cause an electrical shock, excessive heat generation or fire.</p>	
<p>Do not use a joined power cable or extension cable, or share the same power outlet with other electrical appliances, since it may cause an electrical shock, excessive heat generation or fire.</p>	
<p>Be sure to use an exclusive power circuit for the equipment, and follow the local technical standards related to the electrical equipment, the internal wiring regulations, and the instruction manual for installation when conducting electrical work. Insufficient power circuit capacity and improper electrical work may cause an electrical shock or fire.</p>	
<p>Be sure to use the specified cable for wiring between the indoor and outdoor units. Make the connections securely and route the cable properly so that there is no force pulling the cable at the connection terminals. Improper connections may cause excessive heat generation or fire.</p>	
<p>When wiring between the indoor and outdoor units, make sure that the terminal cover does not lift off or dismount because of the cable. If the cover is not mounted properly, the terminal connection section may cause an electrical shock, excessive heat generation or fire.</p>	
<p>Do not damage or modify the power cable. Damaged or modified power cable may cause an electrical shock or fire. Placing heavy items on the power cable, and heating or pulling the power cable may damage the cable.</p>	
<p>Do not mix air or gas other than the specified refrigerant (R410A / R22) in the refrigerant system. If air enters the refrigerating system, an excessively high pressure results, causing equipment damage and injury.</p>	
<p>If the refrigerant gas leaks, be sure to locate the leaking point and repair it before charging the refrigerant. After charging refrigerant, make sure that there is no refrigerant leak. If the leaking point cannot be located and the repair work must be stopped, be sure to perform pump-down and close the service valve, to prevent the refrigerant gas from leaking into the room. The refrigerant gas itself is harmless, but it may generate toxic gases when it contacts flames, such as fan and other heaters, stoves and ranges.</p>	
<p>When relocating the equipment, make sure that the new installation site has sufficient strength to withstand the weight of the equipment. If the installation site does not have sufficient strength and if the installation work is not conducted securely, the equipment may fall and cause injury.</p>	





 <b>Warning</b>	
Check to make sure that the power cable plug is not dirty or loose, then insert the plug into a power outlet securely. If the plug has dust or loose connection, it may cause an electrical shock or fire.	
Be sure to install the product correctly by using the provided standard installation frame. Incorrect use of the installation frame and improper installation may cause the equipment to fall, resulting in injury.	For unitary type only 
Be sure to install the product securely in the installation frame mounted on the window frame. If the unit is not securely mounted, it may fall and cause injury.	For unitary type only 
When replacing the coin battery in the remote controller, be sure to disposed of the old battery to prevent children from swallowing it. If a child swallows the coin battery, see a doctor immediately.	

 <b>Caution</b>	
Installation of a leakage breaker is necessary in some cases depending on the conditions of the installation site, to prevent electrical shocks.	
Do not install the equipment in a place where there is a possibility of combustible gas leaks. If the combustible gas leaks and remains around the unit, it may cause a fire.	
Check to see if the parts and wires are mounted and connected properly, and if the connections at the soldered or crimped terminals are secure. Improper installation and connections may cause excessive heat generation, fire or an electrical shock.	
If the installation platform or frame has corroded, replace it. Corroded installation platform or frame may cause the unit to fall, resulting in injury.	
Check the grounding, and repair it if the equipment is not properly grounded. Improper grounding may cause an electrical shock.	

 <b>Caution</b>	
Be sure to measure the insulation resistance after the repair, and make sure that the resistance is 1 MΩ or higher. Faulty insulation may cause an electrical shock.	
Be sure to check the drainage of the indoor unit after the repair. Faulty drainage may cause the water to enter the room and wet the furniture and floor.	
Do not tilt the unit when removing it. The water inside the unit may spill and wet the furniture and floor.	
Be sure to install the packing and seal on the installation frame properly. If the packing and seal are not installed properly, water may enter the room and wet the furniture and floor.	For unitary type only  

## 1.2 Used Icons

Icons are used to attract the attention of the reader to specific information. The meaning of each icon is described in the table below:

Icon	Type of Information	Description
 Note:	Note	A “note” provides information that is not indispensable, but may nevertheless be valuable to the reader, such as tips and tricks.
 Caution	Caution	A “caution” is used when there is danger that the reader, through incorrect manipulation, may damage equipment, lose data, get an unexpected result or has to restart (part of) a procedure.
 Warning	Warning	A “warning” is used when there is danger of personal injury.
	Reference	A “reference” guides the reader to other places in this binder or in this manual, where he/she will find additional information on a specific topic.



# Part 1

# List of Functions

1. List of Functions .....	2
1.1 Cooling Only .....	2
1.2 Heat Pump .....	10

# 1. List of Functions

## 1.1 Cooling Only

Category	Functions	FTKS25/35DVM	FTKS50-71BVMB	Category	Functions	FTKS25/35DVM	FTKS50-71BVMB
Basic Function	Inverter (with Inverter Power Control)	○	○	Health & Clean	Air Purifying Filter	—	—
	Operation Limit for Cooling (°CDB)	—	—		Photocatalytic Deodorizing Filter	—	—
	Operation Limit for Heating (°CWB)	—	—		Air Purifying Filter with Photocatalytic Deodorizing Function	—	○
PAM Control	—	—	Titanium Apatite Photocatalytic Air-Purifying Filter		○	—	
Compressor	Oval Scroll Compressor	—	—		Mold Proof Air Filter	○	○
	Swing Compressor	—	—		Wipe-clean Flat Panel	○	○
	Rotary Compressor	—	—		Washable Grille	—	—
	Reluctance DC Motor	—	—		Mold Proof Operation	○	—
Comfortable Airflow	Power-Airflow Flap	—	—		Heating Dry Operation	—	—
	Power-Airflow Dual Flaps	○	○		Good-Sleep Cooling Operation	—	—
	Power-Airflow Diffuser	—	—	Timer	24-Hour On/Off Timer	○	○
	Wide-Angle Louvers	○	○		Night Set Mode	○	○
	Vertical Auto-Swing (Up and Down)	○	○	Worry Free "Reliability & Durability"	Auto-Restart (after Power Failure)	○	○
	Horizontal Auto-Swing (Right and Left)	—	○		Self-Diagnosis (Digital, LED) Display	○	○
	3-D Airflow	—	○		Wiring Error Check	—	—
	Comfort Airflow Mode	—	—	Flexibility	Anticorrosion Treatment of Outdoor Heat Exchanger	—	—
3-Step Airflow (H/P Only)	—	—	Multi-Split / Split Type Compatible Indoor Unit		○	○	
Comfort Control	Auto Fan Speed	○	○		Flexible Voltage Correspondence	○	○
	Indoor Unit Quiet Operation	○	○		High Ceiling Application	—	—
	Night Quiet Mode (Automatic)	—	—		Chargeless	—	—
	Outdoor Unit Quiet Operation (Manual)	—	—		Either Side Drain (Right or Left)	○	○
	Intelligent Eye	○	○		Power Selection	—	—
	Quick Warming Function	—	—		Remote Control	5-Rooms Centralized Controller (Option)	○
	Hot-Start Function	—	—	Remote Control Adaptor (Normal Open-Pulse Contact) (Option)		○	○
Automatic Defrosting	—	—	Remote Control Adaptor (Normal Open Contact) (Option)	○		○	
Operation	Automatic Operation	—	—	Remote Controller	DIII-NET Compatible (Adaptor) (Option)	○	○
	Programme Dry Function	○	○		Wireless	○	○
	Fan Only	○	○	Wired	—	—	
Lifestyle Convenience	New Powerful Operation (Non-Inverter)	—	—				
	Inverter Powerful Operation	○	○				
	Priority-Room Setting	—	—				
	Cooling / Heating Mode Lock	—	—				
	Home Leave Operation	—	○				
	ECONO Mode	○	—				
	Indoor Unit On/Off Switch	○	○				
	Signal Reception Indicator	○	○				
	Temperature Display	—	—				
Another Room Operation	—	—					

**Note:** ○ : Holding Functions  
— : No Functions

Category	Functions				Category	Functions			
		FTKS20DVMA FTKS25/35EVMA	FTKS50-71FVM	FTKS50-71FVMA			FTKS20DVMA FTKS25/35EVMA	FTKS50-71FVM	FTKS50-71FVMA
Basic Function	Inverter (with Inverter Power Control)	○	○	○	Health & Clean	Air Purifying Filter	—	—	—
	Operation Limit for Cooling (°CDB)	—	—	—		Photocatalytic Deodorizing Filter	—	—	—
	Operation Limit for Heating (°CWB)	—	—	—		Air Purifying Filter with Photocatalytic Deodorizing Function	—	—	—
	PAM Control	—	—	—		Titanium Apatite Photocatalytic Air-Purifying Filter	○	○	○
Compressor	Oval Scroll Compressor	—	—	—	Mold Proof Air Filter	○	○	○	
	Swing Compressor	—	—	—	Wipe-clean Flat Panel	○	○	○	
	Rotary Compressor	—	—	—	Washable Grille	—	—	—	
	Reluctance DC Motor	—	—	—	Mold Proof Operation	○	—	—	
Comfortable Airflow	Power-Airflow Flap	—	—	—	Heating Dry Operation	—	—	—	
	Power-Airflow Dual Flaps	○	○	○	Good-Sleep Cooling Operation	—	—	—	
	Power-Airflow Diffuser	—	—	—	Timer	24-Hour On/Off Timer	○	○	○
	Wide-Angle Louvers	○	○	○		Night Set Mode	○	○	○
	Vertical Auto-Swing (Up and Down)	○	○	○	Worry Free “Reliability & Durability”	Auto-Restart (after Power Failure)	○	○	○
	Horizontal Auto-Swing (Right and Left)	—	○	○		Self-Diagnosis (Digital, LED) Display	○	○	○
	3-D Airflow	—	○	○		Wiring-Error Check	—	—	—
	Comfort Airflow Mode	—	—	—		Anticorrosion Treatment of Outdoor Heat Exchanger	—	—	—
3-Step Airflow (H/P Only)	—	—	—	Flexibility	Multi-Split / Split Type Compatible Indoor Unit	○	○	○	
Comfort Control	Auto Fan Speed	○	○		○	Flexible Voltage Correspondence	○	○	○
	Indoor Unit Quiet Operation	○	○	○	High Ceiling Application	—	—	—	
	Night Quiet Mode (Automatic)	—	—	—	Chargeless	—	—	—	
	Outdoor Unit Quiet Operation (Manual)	—	—	—	Either Side Drain (Right or Left)	○	○	○	
	Intelligent Eye	○	○	○	Power-Selection	—	—	—	
	Quick Warming Function	—	—	—	Remote Control	5-Rooms Centralized Controller (Option)	○	○	○
	Hot-Start Function	—	—	—		Remote Control Adaptor (Normal Open-Pulse Contact) (Option)	○	○	○
	Automatic Defrosting	—	—	—		Remote Control Adaptor (Normal Open Contact) (Option)	○	○	○
Operation	Automatic Operation	—	—	—	Remote Controller	DIII-NET Compatible (Adaptor) (Option)	○	○	○
	Programme Dry Function	○	○	○		Wireless	○	○	○
	Fan Only	○	○	○		Wired	—	—	—
Lifestyle Convenience	New Powerful Operation (Non-Inverter)	—	—	—					
	Inverter Powerful Operation	○	○	○					
	Priority-Room Setting	—	—	—					
	Cooling / Heating Mode Lock	—	—	—					
	Home Leave Operation	—	○	○					
	ECONO Mode	○	—	—					
	Indoor Unit On/Off Switch	○	○	○					
	Signal Reception Indicator	○	○	○					
	Temperature Display	—	—	—					
Another Room Operation	—	—	—						

**Note:** ○ : Holding Functions  
— : No Functions



Category	Functions	FTKS20-35DVMT	FTKS50-71DVMT	FTKS50-71FVLT	Category	Functions	FTKS20-35DVMT	FTKS50-71DVMT	FTKS50-71FVLT
Basic Function	Inverter (with Inverter Power Control)	○	○	○	Health & Clean	Air Purifying Filter	—	—	—
	Operation Limit for Cooling (°CDB)	—	—	—		Photocatalytic Deodorizing Filter	—	—	—
	Operation Limit for Heating (°CWB)	—	—	—		Air Purifying Filter with Photocatalytic Deodorizing Function	—	○	—
	PAM Control	—	—	—		Titanium Apatite Photocatalytic Air-Purifying Filter	○	—	○
Compressor	Oval Scroll Compressor	—	—	—	Mold Proof Air Filter	○	○	○	
	Swing Compressor	—	—	—	Wipe-clean Flat Panel	○	○	○	
	Rotary Compressor	—	—	—	Washable Grille	—	—	—	
	Reluctance DC Motor	—	—	—	Mold Proof Operation	○	—	—	
Comfortable Airflow	Power-Airflow Flap	—	—	—	Heating Dry Operation	—	—	—	
	Power-Airflow Dual Flaps	○	○	○	Good-Sleep Cooling Operation	—	—	—	
	Power-Airflow Diffuser	—	—	—	Timer	24-Hour On/Off Timer	○	○	○
	Wide-Angle Louvers	○	○	○		Night Set Mode	○	○	○
	Vertical Auto-Swing (Up and Down)	○	○	○	Worry Free "Reliability & Durability"	Auto-Restart (after Power Failure)	○	○	○
	Horizontal Auto-Swing (Right and Left)	—	○	○		Self-Diagnosis (Digital, LED) Display	○	○	○
	3-D Airflow	—	○	○		Wiring-Error Check	—	—	—
	Comfort Airflow Mode	—	—	—		Anticorrosion Treatment of Outdoor Heat Exchanger	—	—	—
	3-Step Airflow (H/P Only)	—	—	—	Flexibility	Multi-Split / Split Type Compatible Indoor Unit	○	○	○
Comfort Control	Auto Fan Speed	○	○	○		Flexible Voltage Correspondence	○	○	—
	Indoor Unit Quiet Operation	○	○	○		High Ceiling Application	—	—	—
	Night Quiet Mode (Automatic)	—	—	—	Chargeless	—	—	—	
	Outdoor Unit Quiet Operation (Manual)	—	—	—	Either Side Drain (Right or Left)	○	○	○	
	Intelligent Eye	○	○	○	Power-Selection	—	—	—	
	Quick Warming Function	—	—	—	Remote Control	5-Rooms Centralized Controller (Option)	○	○	○
	Hot-Start Function	—	—	—		Remote Control Adaptor (Normal Open-Pulse Contact) (Option)	○	○	○
	Automatic Defrosting	—	—	—		Remote Control Adaptor (Normal Open Contact) (Option)	○	○	○
Operation	Automatic Operation	—	—	—	Remote Controller	DIII-NET Compatible (Adaptor) (Option)	○	○	○
	Programme Dry Function	○	○	○		Wireless	○	○	○
	Fan Only	○	○	○		Wired	—	—	—
Lifestyle Convenience	New Powerful Operation (Non-Inverter)	—	—	—					
	Inverter Powerful Operation	○	○	○					
	Priority-Room Setting	—	—	—					
	Cooling / Heating Mode Lock	—	—	—					
	Home Leave Operation	—	○	○					
	ECONO Mode	○	—	—					
	Indoor Unit On/Off Switch	○	○	○					
	Signal Reception Indicator	○	○	○					
	Temperature Display	—	—	—					
Another Room Operation	—	—	—						

**Note:** ○ : Holding Functions  
 — : No Functions

Category	Functions	FDKS25/35CAVMB	FDKS50/60CVMB	Category	Functions	FDKS25/35CAVMB	FDKS50/60CVMB	
Basic Function	Inverter (with Inverter Power Control)	○	○	Health & Clean	Air Purifying Filter	—	—	
	Operation Limit for Cooling (°CDB)	—	—		Photocatalytic Deodorizing Filter	—	—	
	Operation Limit for Heating (°CWB)	—	—		Air Purifying Filter with Photocatalytic Deodorizing Function	—	—	
	PAM Control	—	—		Titanium Apatite Photocatalytic Air-Purifying Filter	—	—	
Compressor	Oval Scroll Compressor	—	—		Mold Proof Air Filter	○	○	
	Swing Compressor	—	—		Wipe-clean Flat Panel	—	—	
	Rotary Compressor	—	—		Washable Grille	—	—	
	Reluctance DC Motor	—	—		Mold Proof Operation	—	—	
Comfortable Airflow	Power-Airflow Flap	—	—		Heating Dry Operation	—	—	
	Power-Airflow Dual Flaps	—	—		Good-Sleep Cooling Operation	—	—	
	Power-Airflow Diffuser	—	—		Timer	24-Hour On/Off Timer	○	○
	Wide-Angle Louvers	—	—			Night Set Mode	○	○
	Vertical Auto-Swing (Up and Down)	—	—	Worry Free "Reliability & Durability"	Auto-Restart (after Power Failure)	○	○	
	Horizontal Auto-Swing (Right and Left)	—	—		Self-Diagnosis (Digital, LED) Display	○	○	
	3-D Airflow	—	—		Wiring-Error Check	—	—	
	Comfort Airflow Mode	—	—		Anticorrosion Treatment of Outdoor Heat Exchanger	—	—	
Comfort Control	3-Step Airflow (H/P Only)	—	—	Flexibility	Multi-Split / Split Type Compatible Indoor Unit	○	○	
	Auto Fan Speed	○	○		Flexible Voltage Correspondence	○	○	
	Indoor Unit Quiet Operation	○	○		High Ceiling Application	—	—	
	Night Quiet Mode (Automatic)	—	—		Chargeless	—	—	
	Outdoor Unit Quiet Operation (Manual)	—	—		Either Side Drain (Right or Left)	—	—	
	Intelligent Eye	—	—		Power-Selection	—	—	
	Quick Warming Function	—	—	Remote Control	5-Rooms Centralized Controller (Option)	○	○	
	Hot-Start Function	—	—		Remote Control Adaptor (Normal Open-Pulse Contact) (Option)	○	○	
Operation	Automatic Defrosting	—	—	Remote Control Adaptor (Normal Open Contact) (Option)	Remote Control Adaptor (Normal Open Contact) (Option)	○	○	
	Automatic Operation	—	—		DIII-NET Compatible (Adaptor) (Option)	○	○	
	Programme Dry Function	○	○		Remote Controller	Wireless	○	○
Fan Only	○	○	Wired	—		—		
Lifestyle Convenience	New Powerful Operation (Non-Inverter)	—	—					
	Inverter Powerful Operation	○	○					
	Priority-Room Setting	—	—					
	Cooling / Heating Mode Lock	—	—					
	Home Leave Operation	○	○					
	ECONO Mode	—	—					
	Indoor Unit On/Off Switch	○	○					
	Signal Reception Indicator	○	○					
	Temperature Display	—	—					
Another Room Operation	—	—						

**Note:** ○ : Holding Functions  
— : No Functions

Category	Functions			Category	Functions		
		FDKS25/35EAVMB	CDKS25-60CVMA CDKS25-60DVMT CDKS25/35EAVMA(T)			FDKS25/35EAVMB	CDKS25-60CVMA CDKS25-60DVMT CDKS25/35EAVMA(T)
Basic Function	Inverter (with Inverter Power Control)	○	○	Health & Clean	Air Purifying Filter	—	—
	Operation Limit for Cooling (°CDB)	—	—		Photocatalytic Deodorizing Filter	—	—
	Operation Limit for Heating (°CWB)	—	—		Air Purifying Filter with Photocatalytic Deodorizing Function	—	—
	PAM Control	—	—		Titanium Apatite Photocatalytic Air-Purifying Filter	—	—
Compressor	Oval Scroll Compressor	—	—	Timer	Longlife Filter	—	—
	Swing Compressor	—	—		Mold Proof Air Filter	○	○
	Rotary Compressor	—	—		Wipe-clean Flat Panel	—	—
	Reluctance DC Motor	—	—		Washable Grille	—	—
Comfortable Airflow	Power-Airflow Flap	—	—	Worry Free "Reliability & Durability"	Mold Proof Operation	—	—
	Power-Airflow Dual Flaps	—	—		Heating Dry Operation	—	—
	Power-Airflow Diffuser	—	—		Good-Sleep Cooling Operation	—	—
	Wide-Angle Louvers	—	—		24-Hour On/Off Timer	○	○
	Vertical Auto-Swing (Up and Down)	—	—		Night Set Mode	○	○
	Horizontal Auto-Swing (Right and Left)	—	—		Auto-Restart (after Power Failure)	○	○
	3-D Airflow	—	—		Self-Diagnosis (Digital, LED) Display	○	○
	Comfort Airflow Mode	—	—		Wiring-Error Check	—	—
Comfort Control	Auto Fan Speed	○	○	Flexibility	Anticorrosion Treatment of Outdoor Heat Exchanger	—	—
	Indoor Unit Quiet Operation	○	○		Multi-Split / Split Type Compatible Indoor Unit	○	—
	Night Quiet Mode (Automatic)	—	—		Flexible Voltage Correspondence	○	○
	Outdoor Unit Quiet Operation (Manual)	—	—		High Ceiling Application	—	—
	Intelligent Eye	—	—	Chargeless	—	—	
	Quick Warming Function	—	—	Either Side Drain (Right or Left)	—	—	
	Hot-Start Function	—	—	Power-Selection	—	—	
	Automatic Defrosting	—	—	Remote Control	5-Rooms Centralized Controller (Option)	○	○
			Remote Control Adaptor (Normal Open-Pulse Contact) (Option)		○	○	
Operation	Automatic Operation	—	—	Remote Controller	Remote Control Adaptor (Normal Open Contact) (Option)	○	○
	Programme Dry Function	○	○		DIII-NET Compatible (Adaptor) (Option)	○	○
	Fan Only	○	○		Wireless	○	○
Lifestyle Convenience	New Powerful Operation (Non-Inverter)	—	—	Remote Controller	Wired	—	—
	Inverter Powerful Operation	○	○				
	Priority-Room Setting	—	—				
	Cooling / Heating Mode Lock	—	—				
	Home Leave Operation	○	○				
	ECONO Mode	—	—				
	Indoor Unit On/Off Switch	○	○				
	Signal Reception Indicator	○	○				
	Temperature Display	—	—				
Another Room Operation	—	—					

**Note:** ○ : Holding Functions  
— : No Functions

Category	Functions	FFQ25-60B8V1B	3MKS58EVMA 3MKS79EVMA 4MKS90EVMA	Category	Functions	FFQ25-60B8V1B	3MKS58EVMA 3MKS79EVMA 4MKS90EVMA
Basic Function	Inverter (with Inverter Power Control)	○	○	Health & Clean	Air Purifying Filter	—	—
	Operation Limit for Cooling (°CDB)	—	10 ~ 46		Photocatalytic Deodorizing Filter	—	—
	Operation Limit for Heating (°CWB)	—	—		Air Purifying Filter with Photocatalytic Deodorizing Function	—	—
	PAM Control	—	○		Titanium Apatite Photocatalytic Air-Purifying Filter	—	—
Compressor	Oval Scroll Compressor	—	—	Longlife Filter (Option)	○	—	
	Swing Compressor	—	○	Mold Proof Air Filter	○	—	
	Rotary Compressor	—	—	Wipe-clean Flat Panel	—	—	
	Reluctance DC Motor	—	○	Washable Grille	—	—	
Comfortable Airflow	Power-Airflow Flap	—	—	Filter Cleaning Indicator	○	—	
	Power-Airflow Dual Flaps	—	—	Mold Proof Operation	—	—	
	Power-Airflow Diffuser	—	—	Heating Dry Operation	—	—	
	Wide-Angle Louvers	—	—	Good-Sleep Cooling Operation	—	—	
	Vertical Auto-Swing (Up and Down)	○	—	Timer	24-Hour On/Off Timer	○ ★	—
	Horizontal Auto-Swing (Right and Left)	—	—		Night Set Mode	—	—
	3-D Airflow	—	—	Worry Free "Reliability & Durability"	Auto-Restart (after Power Failure)	○	—
	Comfort Airflow Mode	—	—		Self-Diagnosis (Digital, LED) Display	○	○
3-Step Airflow (H/P Only)	—	—	Wiring-Error Check		—	○	
Comfort Control	Auto Fan Speed	—	—	Anticorrosion Treatment of Outdoor Heat Exchanger	—	○	
	Indoor Unit Quiet Operation	—	—	Flexibility	Multi-Split / Split Type Compatible Indoor Unit	○	—
	Night Quiet Mode (Automatic)	—	○		Flexible Voltage Correspondence	—	○
	Outdoor Unit Quiet Operation (Manual)	—	○		High Ceiling Application	—	—
	Intelligent Eye	—	—		Chargeless	—	○
	Quick Warming Function	—	—	Either Side Drain (Right or Left)	—	—	
	Hot-Start Function	—	—	Power-Selection	—	—	
	Automatic Defrosting	—	—	Remote Control	5-Rooms Centralized Controller (Option)	—	—
Operation	Automatic Operation	—	—		Remote Control Adaptor (Normal Open-Pulse Contact) (Option)	—	—
	Programme Dry Function	○	—		Remote Control Adaptor (Normal Open Contact) (Option)	—	—
	Fan Only	○	—	DIII-NET Compatible (Adaptor) (Option)	○	—	
Lifestyle Convenience	New Powerful Operation (Non-Inverter)	—	—	Remote Controller	Wireless	○	—
	Inverter Powerful Operation	—	—		Wired	○	—
	Priority-Room Setting	—	○				
	Cooling / Heating Mode Lock	—	—				
	Home Leave Operation	—	—				
	ECONO Mode	—	—				
	Indoor Unit On/Off Switch	—	—				
	Signal Reception Indicator	—	—				
	Temperature Display	—	—				
Another Room Operation	—	—					

**Note:** ○ : Holding Functions  
— : No Functions

★ : 72-Hour On/Off Timer

Category	Functions	3MKS90EVL 4MKS100EVL	3MKS50DVM 4MKS71DVM	Category	Functions	3MKS90EVL 4MKS100EVL	3MKS50DVM 4MKS71DVM	
Basic Function	Inverter (with Inverter Power Control)	○	○	Health & Clean	Air Purifying Filter with Bacteriostatic & Virustatic Functions	—	—	
	Operation Limit for Cooling (°CDB)	10 46	-10 46		Photocatalytic Deodorizing Filter	—	—	
	Operation Limit for Heating (°CWB)	—	—		Air Purifying Filter with Photocatalytic Deodorizing Function	—	—	
	PAM Control	○	○		Titanium Apatite Photocatalytic Air-Purifying Filter	—	—	
Compressor	Oval Scroll Compressor	—	—		Mold Proof Air Filter	—	—	
	Swing Compressor	○	○		Wipe-clean Flat Panel	—	—	
	Rotary Compressor	—	—		Washable Grille	—	—	
	Reluctance DC Motor	○	○		Mold Proof Operation	—	—	
Comfortable Airflow	Power-Airflow Flap	—	—		Heating Dry Operation	—	—	
	Power-Airflow Dual Flaps	—	—		Good-Sleep Cooling Operation	—	—	
	Power-Airflow Diffuser	—	—	Timer	24-Hour On/Off Timer	—	—	
	Wide-Angle Louvers	—	—		Night Set Mode	—	—	
	Vertical Auto-Swing (Up and Down)	—	—	Worry Free "Reliability & Durability"	Auto-Restart (after Power Failure)	—	—	
	Horizontal Auto-Swing (Right and Left)	—	—		Self-Diagnosis (Digital, LED) Display	○	○	
	3-D Airflow	—	—		Wiring-Error Check	○	○	
	Comfort Airflow Mode	—	—		Anticorrosion Treatment of Outdoor Heat Exchanger	○	○	
Comfort Control	3-Step Airflow (H/P Only)	—	—	Flexibility	Multi-Split / Split Type Compatible Indoor Unit	—	—	
	Auto Fan Speed	—	—		Flexible Voltage Correspondence	—	○	
	Indoor Unit Quiet Operation	—	—		High Ceiling Application	—	—	
	Night Quiet Mode (Automatic)	○	○		Chargeless	○	○	
	Outdoor Unit Quiet Operation (Manual)	○	○		Either Side Drain (Right or Left)	—	—	
	Intelligent Eye	—	—		Power-Selection	—	○	
	Quick Warming Function	—	—		Remote Control	5-Rooms Centralized Controller (Option)	—	—
	Hot-Start Function	—	—			Remote Control Adaptor (Normal Open-Pulse Contact) (Option)	—	—
Automatic Defrosting	—	—	Remote Control Adaptor (Normal Open Contact) (Option)	—		—		
Operation	Automatic Operation	—	—	DIII-NET Compatible (Adaptor) (Option)		—	—	
	Programme Dry Function	—	—	Remote Controller	Wireless	—	—	
	Fan Only	—	—		Wired	—	—	
Lifestyle Convenience	New Powerful Operation (Non-Inverter)	—	—					
	Inverter Powerful Operation	—	—					
	Priority-Room Setting	○	○					
	Cooling / Heating Mode Lock	—	—					
	Home Leave Operation	—	—					
	ECONO Mode	—	—					
	Indoor Unit On/Off Switch	—	—					
	Signal Reception Indicator	—	—					
Temperature Display	—	—						
Another Room Operation	—	—						

**Note:** ○ : Holding Functions  
— : No Functions

Category	Functions	3MKS50/71ESG	4MKS80ESG	Category	Functions	3MKS50/71ESG	4MKS80ESG
Basic Function	Inverter (with Inverter Power Control)	○	○	Health & Clean	Air Purifying Filter	—	—
	Operation Limit for Cooling (°CDB)	-10 ~ 46	10 ~ 46		Photocatalytic Deodorizing Filter	—	—
	Operation Limit for Heating (°CWB)	—	—		Air Purifying Filter with Photocatalytic Deodorizing Function	—	—
	PAM Control	○	○		Titanium Apatite Photocatalytic Air-Purifying Filter	—	—
Compressor	Oval Scroll Compressor	—	—	Mold Proof Air Filter	—	—	
	Swing Compressor	○	○	Wipe-clean Flat Panel	—	—	
	Rotary Compressor	—	—	Washable Grille	—	—	
	Reluctance DC Motor	○	○	Mold Proof Operation	—	—	
Comfortable Airflow	Power-Airflow Flap	—	—	Heating Dry Operation	—	—	
	Power-Airflow Dual Flaps	—	—	Good-Sleep Cooling Operation	—	—	
	Power-Airflow Diffuser	—	—	Timer	24-Hour On/Off Timer	—	—
	Wide-Angle Louvers	—	—		Night Set Mode	—	—
	Vertical Auto-Swing (Up and Down)	—	—	Worry Free "Reliability & Durability"	Auto-Restart (after Power Failure)	—	—
	Horizontal Auto-Swing (Right and Left)	—	—		Self-Diagnosis (Digital, LED) Display	○	○
	3-D Airflow	—	—		Wiring-Error Check	○	○
	Comfort Airflow Mode	—	—		Anticorrosion Treatment of Outdoor Heat Exchanger	○	○
Comfort Control	3-Step Airflow (H/P Only)	—	—	Flexibility	Multi-Split / Split Type Compatible Indoor Unit	—	—
	Auto Fan Speed	—	—		Flexible Voltage Correspondence	—	—
	Indoor Unit Quiet Operation	—	—		High Ceiling Application	—	—
	Night Quiet Mode (Automatic)	○	○		Chargeless	○	○
	Outdoor Unit Quiet Operation (Manual)	○	○		Either Side Drain (Right or Left)	—	—
	Intelligent Eye	—	—		Power-Selection	○	○
	Quick Warming Function	—	—		Remote Control	5-Rooms Centralized Controller (Option)	—
Hot-Start Function	—	—	Remote Control Adaptor (Normal Open-Pulse Contact) (Option)	—		—	
Automatic Defrosting	—	—	Remote Control Adaptor (Normal Open Contact) (Option)	—		—	
Operation	Automatic Operation	—	—	Remote Controller	DIII-NET Compatible (Adaptor) (Option)	—	—
	Programme Dry Function	—	—		Wireless	—	—
	Fan Only	—	—		Wired	—	—
Lifestyle Convenience	New Powerful Operation (Non-Inverter)	—	—				
	Inverter Powerful Operation	—	—				
	Priority-Room Setting	○	○				
	Cooling / Heating Mode Lock	—	—				
	Home Leave Operation	—	—				
	ECONO Mode	—	—				
	Indoor Unit On/Off Switch	—	—				
	Signal Reception Indicator	—	—				
	Temperature Display	—	—				
Another Room Operation	—	—					

**Note:** ○ : Holding Functions  
— : No Functions

## 1.2 Heat Pump

Category	Functions			Category	Functions			
		FTXS20DVMA FTXS25/39EVMA	FTXS50-71FVMA			FTXS20DVMA FTXS25/39EVMA	FTXS50-71FVMA	
Basic Function	Inverter (with Inverter Power Control)	○	○	Health & Clean	Air Purifying Filter	—	—	
	Operation Limit for Cooling (°CDB)	—	—		Photocatalytic Deodorizing Filter	—	—	
	Operation Limit for Heating (°CWB)	—	—		Air Purifying Filter with Photocatalytic Deodorizing Function	—	—	
	PAM Control	—	—		Titanium Apatite Photocatalytic Air-Purifying Filter	○	○	
Compressor	Oval Scroll Compressor	—	—	Timer	Longlife Filter (Option)	—	—	
	Swing Compressor	—	—		Mold Proof Air Filter	○	○	
	Rotary Compressor	—	—		Wipe-clean Flat Panel	○	○	
	Reluctance DC Motor	—	—		Washable Grille	—	—	
Comfortable Airflow	Power-Airflow Flap	—	—	Worry Free "Reliability & Durability"	Filter Cleaning Indicator	—	—	
	Power-Airflow Dual Flaps	○	○		Mold Proof Operation	○	—	
	Power-Airflow Diffuser	—	—		Heating Dry Operation	—	—	
	Wide-Angle Louvers	○	○		Good-Sleep Cooling Operation	—	—	
	Vertical Auto-Swing (Up and Down)	○	○		Flexibility	24-Hour On/Off Timer	○	○
	Horizontal Auto-Swing (Right and Left)	—	○			Night Set Mode	○	○
	3-D Airflow	—	○			Auto-Restart (after Power Failure)	○	○
	Comfort Airflow Mode	—	—			Self-Diagnosis (Digital, LED) Display	○	○
Comfort Control	3-Step Airflow (H/P Only)	—	—	Remote Control	Wiring-Error Check	—	—	
	Auto Fan Speed	○	○		Anticorrosion Treatment of Outdoor Heat Exchanger	—	—	
	Indoor Unit Quiet Operation	○	○		Flexibility	Multi-Split / Split Type Compatible Indoor Unit	○	○
	Night Quiet Mode (Automatic)	—	—			Flexible Voltage Correspondence	○	○
	Outdoor Unit Quiet Operation (Manual)	—	—			High Ceiling Application	—	—
	Intelligent Eye	○	○			Chargeless	—	—
	Quick Warming Function	—	—		Either Side Drain (Right or left)	○	○	
	Hot-Start Function	○	○		Power-Selection	—	—	
Automatic Defrosting	—	—	Remote Control	5-Rooms Centralized Controller (Option)	○	○		
Operation	Automatic Operation	○		○	Remote Control Adaptor (Normal Open-Pulse Contact) (Option)	○	○	
	Programme Dry Function	○		○	Remote Control Adaptor (Normal Open Contact) (Option)	○	○	
	Fan Only	○		○	DIII-NET Compatible (Adaptor) (Option)	○	○	
Lifestyle Convenience	New Powerful Operation (Non-Inverter)	—	—	Remote Controller	Wireless	○	○	
	Inverter Powerful Operation	○	○		Wired	—	—	
	Priority-Room Setting	—	—					
	Cooling / Heating Mode Lock	—	—					
	Home Leave Operation	—	○					
	ECONO Mode	○	—					
	Indoor Unit On/Off Switch	○	○					
	Signal Reception Indicator	○	○					
	Temperature Display	—	—					
Another Room Operation	—	—						

**Note:** ○ : Holding Functions  
— : No Functions

Category	Functions				Category	Functions			
		FTXS20-35DVMT	FTXS50-71DVMT	FTXS50-71FVLT			FTXS20-35DVMT	FTXS50-71DVMT	FTXS50-71FVLT
Basic Function	Inverter (with Inverter Power Control)	○	○	○	Health & Clean	Air Purifying Filter	—	—	—
	Operation Limit for Cooling (°CDB)	—	—	—		Photocatalytic Deodorizing Filter	—	—	—
	Operation Limit for Heating (°CWB)	—	—	—		Air Purifying Filter with Photocatalytic Deodorizing Function	—	○	—
	PAM Control	—	—	—		Titanium Apatite Photocatalytic Air-Purifying Filter	○	—	○
Compressor	Oval Scroll Compressor	—	—	—	Longlife Filter	—	—	—	
	Swing Compressor	—	—	—	Mold Proof Air Filter	○	○	○	
	Rotary Compressor	—	—	—	Wipe-clean Flat Panel	○	○	○	
	Reluctance DC Motor	—	—	—	Washable Grille	—	—	—	
Comfortable Airflow	Power-Airflow Flap	—	—	—	Mold Proof Operation	○	—	—	
	Power-Airflow Dual Flaps	○	○	○	Heating Dry Operation	—	—	—	
	Power-Airflow Diffuser	—	—	—	Good-Sleep Cooling Operation	—	—	—	
	Wide-Angle Louvers	○	○	○	Timer	24-Hour On/Off Timer	○	○	○
	Vertical Auto-Swing (Up and Down)	○	○	○		Night Set Mode	○	○	○
	Horizontal Auto-Swing (Right and Left)	—	○	○	Worry Free "Reliability & Durability"	Auto-Restart (after Power Failure)	○	○	○
	3-D Airflow	—	○	○		Self-Diagnosis (Digital, LED) Display	○	○	○
	Comfort Airflow Mode	—	—	—		Wiring-Error Check	—	—	—
3-Step Airflow (H/P Only)	—	—	—	Anticorrosion Treatment of Outdoor Heat Exchanger		—	—	—	
Comfort Control	Auto Fan Speed	○	○	○	Flexibility	Multi-Split / Split Type Compatible Indoor Unit	○	○	○
	Indoor Unit Quiet Operation	○	○	○		Flexible Voltage Correspondence	○	○	—
	Night Quiet Mode (Automatic)	—	—	—		High Ceiling Application	—	—	—
	Outdoor Unit Quiet Operation (Manual)	—	—	—		Chargeless	—	—	—
	Intelligent Eye	○	○	○		Either Side Drain (Right or Left)	○	○	○
	Quick Warming Function	—	—	—	Power-Selection	—	—	—	
	Hot-Start Function	○	○	○	Remote Control	5-Rooms Centralized Controller (Option)	○	○	○
	Automatic Defrosting	—	—	—		Remote Control Adaptor (Normal Open-Pulse Contact) (Option)	○	○	○
				Remote Control Adaptor (Normal Open Contact) (Option)		○	○	○	
Operation	Automatic Operation	○	○	○	Remote Controller	DIII-NET Compatible (Adaptor) (Option)	○	○	○
	Programme Dry Function	○	○	○		Wireless	○	○	○
	Fan Only	○	○	○		Wired	—	—	—
Lifestyle Convenience	New Powerful Operation (Non-Inverter)	—	—	—					
	Inverter Powerful Operation	○	○	○					
	Priority-Room Setting	—	—	—					
	Cooling / Heating Mode Lock	—	—	—					
	Home Leave Operation	—	○	○					
	ECONO Mode	○	—	—					
	Indoor Unit On/Off Switch	○	○	○					
	Signal Reception Indicator	○	○	○					
	Temperature Display	—	—	—					
Another Room Operation	—	—	—						

**Note:** ○ : Holding Functions  
— : No Functions



Category	Functions	FDXS25-60CVMA	CDXS25-60DVMT	Category	Functions	FDXS25-60CVMA	CDXS25-60DVMT	
Basic Function	Inverter (with Inverter Power Control)	○	○	Health & Clean	Air Purifying Filter	—	—	
	Operation Limit for Cooling (°CDB)	—	—		Photocatalytic Deodorizing Filter	—	—	
	Operation Limit for Heating (°CWB)	—	—		Air Purifying Filter with Photocatalytic Deodorizing Function	—	—	
	PAM Control	—	—		Titanium Apatite Photocatalytic Air-Purifying Filter	—	—	
Compressor	Oval Scroll Compressor	—	—		Longlife Filter (Option)	—	—	
	Swing Compressor	—	—		Mold Proof Air Filter	○	○	
	Rotary Compressor	—	—		Wipe-clean Flat Panel	—	—	
	Reluctance DC Motor	—	—		Washable Grille	—	—	
Comfortable Airflow	Power-Airflow Flap	—	—		Mold Proof Operation	—	—	
	Power-Airflow Dual Flaps	—	—		Heating Dry Operation	—	—	
	Power-Airflow Diffuser	—	—		Good-Sleep Cooling Operation	—	—	
	Wide-Angle Louvers	—	—		Timer	24-Hour On/Off Timer	○	○
	Vertical Auto-Swing (Up and Down)	—	—			Night Set Mode	○	○
	Horizontal Auto-Swing (Right and Left)	—	—		Worry Free "Reliability & Durability"	Auto-Restart (after Power Failure)	○	○
	3-D Airflow	—	—			Self-Diagnosis (Digital, LED) Display	○	○
	Comfort Airflow Mode	—	—			Wiring-Error Check	—	—
3-Step Airflow (H/P Only)	—	—	Anticorrosion Treatment of Outdoor Heat Exchanger	—		—		
Comfort Control	Auto Fan Speed	○	○	Flexibility	Multi-Split / Split Type Compatible Indoor Unit	○	—	
	Indoor Unit Quiet Operation	○	○		Flexible Voltage Correspondence	○	○	
	Night Quiet Mode (Automatic)	—	—		High Ceiling Application	—	—	
	Outdoor Unit Quiet Operation (Manual)	—	—		Chargeless	—	—	
	Intelligent Eye	—	—		Either Side Drain (Right or left)	—	—	
	Quick Warming Function	—	—		Power-Selection	—	—	
	Hot-Start Function	○	○	Remote Control	5-Rooms Centralized Controller (Option)	○	○	
	Automatic Defrosting	—	—		Remote Control Adaptor (Normal Open-Pulse Contact) (Option)	○	○	
Operation	Automatic Operation	○	○	Remote Controller	Remote Control Adaptor (Normal Open Contact) (Option)	○	○	
	Programme Dry Function	○	○		DIII-NET Compatible (Adaptor) (Option)	○	○	
	Fan Only	○	○		Wireless	○	○	
Lifestyle Convenience	New Powerful Operation (Non-Inverter)	—	—	Wired	—	—		
	Inverter Powerful Operation	○	○					
	Priority-Room Setting	—	—					
	Cooling / Heating Mode Lock	—	—					
	Home Leave Operation	○	○					
	ECONO Mode	—	—					
	Indoor Unit On/Off Switch	○	○					
	Signal Reception Indicator	○	○					
	Temperature Display	—	—					
Another Room Operation	—	—						

**Note:** ○ : Holding Functions  
— : No Functions

Category	Functions	CDXS25/35EAVMA(T)	Category	Functions	CDXS25/35EAVMA(T)	
Basic Function	Inverter (with Inverter Power Control)	○	Health & Clean	Air Purifying Filter	—	
	Operation Limit for Cooling (°CDB)	—		Photocatalytic Deodorizing Filter	—	
	Operation Limit for Heating (°CWB)	—		Air Purifying Filter with Photocatalytic Deodorizing Function	—	
	PAM Control	—		Titanium Apatite Photocatalytic Air-Purifying Filter	—	
Compressor	Oval Scroll Compressor	—		Longlife Filter (Option)	—	
	Swing Compressor	—		Mold Proof Air Filter	○	
	Rotary Compressor	—		Wipe-clean Flat Panel	—	
	Reluctance DC Motor	—		Washable Grille	—	
Comfortable Airflow	Power-Airflow Flap	—		Filter Cleaning Indicator	—	
	Power-Airflow Dual Flaps	—		Mold Proof Operation	—	
	Power-Airflow Diffuser	—		Heating Dry Operation	—	
	Wide-Angle Louvers	—		Good-Sleep Cooling Operation	—	
	Vertical Auto-Swing (Up and Down)	—		Timer	24-Hour On/Off Timer	○
	Horizontal Auto-Swing (Right and Left)	—			Night Set Mode	○
	3-D Airflow	—		Worry Free "Reliability & Durability"	Auto-Restart (after Power Failure)	○
	Comfort Airflow Mode	—			Self-Diagnosis (Digital, LED) Display	○
3-Step Airflow (H/P Only)	—	Wiring-Error Check	—			
Comfort Control	Auto Fan Speed	○	Anticorrosion Treatment of Outdoor Heat Exchanger	—		
	Indoor Unit Quiet Operation	○	Flexibility	Multi-Split / Split Type Compatible Indoor Unit	—	
	Night Quiet Mode (Automatic)	—		Flexible Voltage Correspondence	○	
	Outdoor Unit Quiet Operation (Manual)	—		High Ceiling Application	—	
	Intelligent Eye	—		Chargeless	—	
	Quick Warming Function	—		Either Side Drain (Right or left)	—	
	Hot-Start Function	○		Power-Selection	—	
	Automatic Defrosting	—	Remote Control	5-Rooms Centralized Controller (Option)	○	
Operation	Automatic Operation	○		Remote Control Adaptor (Normal Open-Pulse Contact) (Option)	○	
	Programme Dry Function	○		Remote Control Adaptor (Normal Open Contact) (Option)	○	
	Fan Only	○	DIII-NET Compatible (Adaptor) (Option)	○		
Lifestyle Convenience	New Powerful Operation (Non-Inverter)	—	Remote Controller	Wireless	○	
	Inverter Powerful Operation	○		Wired	—	
	Priority-Room Setting	—				
	Cooling / Heating Mode Lock	—				
	Home Leave Operation	○				
	ECONO Mode	—				
	Indoor Unit On/Off Switch	○				
	Signal Reception Indicator	○				
	Temperature Display	—				
	Another Room Operation	—				

**Note:** ○ : Holding Functions  
— : No Functions

Category	Functions	FLXS25-60BVMA	FVXS35/50BVMA	FCQ25-60B8V1B	Category	Functions	FLXS25-60BVMA	FVXS35/50BVMA	FCQ25-60B8V1B
Basic Function	Inverter (with Inverter Power Control)	○	○	○	Health & Clean	Air Purifying Filter	○	○	—
	Operation Limit for Cooling (°CDB)	—	—	—		Photocatalytic Deodorizing Filter	○	○	—
	Operation Limit for Heating (°CWB)	—	—	—		Air Purifying Filter with Photocatalytic Deodorizing Function	—	—	—
	PAM Control	—	—	—		Titanium Apatite Photocatalytic Air-Purifying Filter	—	—	—
Compressor	Oval Scroll Compressor	—	—	—	Longlife Filter (Option)	—	—	○	
	Swing Compressor	—	—	—	Mold Proof Air Filter	○	○	○	
	Rotary Compressor	—	—	—	Wipe-clean Flat Panel	—	—	—	
	Reluctance DC Motor	—	—	—	Washable Grille	—	○	—	
Comfortable Airflow	Power-Airflow Flap	○	○	—	Filter Cleaning Indicator	—	—	○	
	Power-Airflow Dual Flaps	—	—	—	Mold Proof Operation	—	—	—	
	Power-Airflow Diffuser	—	—	—	Heating Dry Operation	—	—	—	
	Wide-Angle Louvers	—	○	—	Good-Sleep Cooling Operation	—	—	—	
	Vertical Auto-Swing (Up and Down)	○	○	○	Timer	24-Hour On/Off Timer	○	○	○ ★
	Horizontal Auto-Swing (Right and Left)	—	—	—		Night Set Mode	○	○	—
	3-D Airflow	—	—	—	Worry Free "Reliability & Durability"	Auto-Restart (after Power Failure)	○	○	○
	Comfort Airflow Mode	—	—	—		Self-Diagnosis (Digital, LED) Display	○	○	○
3-Step Airflow (H/P Only)	—	○	—	Wiring-Error Check		—	—	—	
Comfort Control	Auto Fan Speed	○	○	—	Anticorrosion Treatment of Outdoor Heat Exchanger	—	—	—	
	Indoor Unit Quiet Operation	○	○	—	Flexibility	Multi-Split / Split Type Compatible Indoor Unit	○	○	○
	Night Quiet Mode (Automatic)	—	—	—		Flexible Voltage Correspondence	○	○	—
	Outdoor Unit Quiet Operation (Manual)	—	—	—		High Ceiling Application	—	—	—
	Intelligent Eye	—	—	—		Chargeless	—	—	—
	Quick Warming Function	—	—	—		Either Side Drain (Right or Left)	—	○	—
	Hot-Start Function	○	○	○		Power-Selection	—	—	—
Automatic Defrosting	—	—	—	Remote Control	5-Rooms Centralized Controller (Option)	○	○	—	
Operation	Automatic Operation	○	○		○	Remote Control Adaptor (Normal Open-Pulse Contact) (Option)	○	○	—
	Programme Dry Function	○	○		○	Remote Control Adaptor (Normal Open Contact) (Option)	○	○	—
	Fan Only	○	○	○	DIII-NET Compatible (Adaptor) (Option)	○	○	○	
Lifestyle Convenience	New Powerful Operation (Non-Inverter)	—	—	—	Remote Controller	Wireless	○	○	○
	Inverter Powerful Operation	○	○	—		Wired	—	—	○
	Priority-Room Setting	—	—	—					
	Cooling / Heating Mode Lock	—	—	—					
	Home Leave Operation	○	○	—					
	ECONO Mode	—	—	—					
	Indoor Unit On/Off Switch	○	○	—					
	Signal Reception Indicator	○	○	—					
	Temperature Display	—	—	—					
Another Room Operation	—	—	—						

**Note:** ○ : Holding Functions  
— : No Functions

★ : 72-Hour On/Off Timer

Category	Functions	3MXS52E VMA 3MXS68E VMA	4MXS80E VMA	Category	Functions	3MXS52E VMA 3MXS68E VMA	4MXS80E VMA
Basic Function	Inverter (with Inverter Power Control)	○	○	Health & Clean	Air Purifying Filter	—	—
	Operation Limit for Cooling (°CDB)	-5 ~ 46	-10 ~ 46		Photocatalytic Deodorizing Filter	—	—
	Operation Limit for Heating (°CWB)	-15 ~ 15.5	-15 ~ 15.5		Air Purifying Filter with Photocatalytic Deodorizing Function	—	—
	PAM Control	○	○		Titanium Apatite Photocatalytic Air-Purifying Filter	—	—
Compressor	Oval Scroll Compressor	—	—	Timer	Longlife Filter (Option)	—	—
	Swing Compressor	○	○		Mould Proof Air Filter	—	—
	Rotary Compressor	—	—		Wipe-clean Flat Panel	—	—
	Reluctance DC Motor	○	○		Washable Grille	—	—
Comfortable Airflow	Power-Airflow Flap	—	—	Worry Free "Reliability & Durability"	Filter Cleaning Indicator	—	—
	Power-Airflow Dual Flaps	—	—		Mold Proof Operation	—	—
	Power-Airflow Diffuser	—	—		Heating Dry Operation	—	—
	Wide-Angle Louvers	—	—		Good-Sleep Cooling Operation	—	—
	Vertical Auto-Swing (Up and Down)	—	—		24-Hour On/Off Timer	—	—
	Horizontal Auto-Swing (Right and Left)	—	—		Night Set Mode	—	—
	3-D Airflow	—	—		Auto-Restart (after Power Failure)	—	—
	Comfort Airflow Mode	—	—		Self-Diagnosis (Digital, LED) Display	○	○
Comfort Control	3-Step Airflow (H/P Only)	—	—	Flexibility	Wiring-Error Check	○	○
	Auto Fan Speed	—	—		Anticorrosion Treatment of Outdoor Heat Exchanger	○	○
	Indoor Unit Quiet Operation	—	—		Multi-Split / Split Type Compatible Indoor Unit	—	—
	Night Quiet Mode (Automatic)	○	○		Flexible Voltage Correspondence	○	○
	Outdoor Unit Quiet Operation (Manual)	○	○		High Ceiling Application	—	—
	Intelligent Eye	—	—		Chargeless	30m	40m
	Quick Warming Function	○	○		Either Side Drain (Right or Left)	—	—
	Hot-Start Function	—	—		Power-Selection	—	—
Operation	Automatic Defrosting	○	○	Remote Control	5-Rooms Centralized Controller (Option)	—	—
	Automatic Operation	—	—		Remote Control Adaptor (Normal Open-Pulse Contact) (Option)	—	—
	Programme Dry Function	—	—		Remote Control Adaptor (Normal Open Contact) (Option)	—	—
Lifestyle Convenience	Fan Only	—	—	Remote Controller	DIII-NET Compatible (Adaptor) (Option)	—	—
	New Powerful Operation (Non-Inverter)	—	—		Wireless	—	—
	Inverter Powerful Operation	—	—		Wired	—	—
	Priority-Room Setting	○	○				
	Cooling / Heating Mode Lock	○	○				
	Home Leave Operation	—	—				
	ECONO Mode	—	—				
	Indoor Unit On/Off Switch	—	—				
	Signal Reception Indicator	—	—				
Temperature Display	—	—					
Another Room Operation	—	—					

**Note:** ○ : Holding Functions  
— : No Functions

Category	Functions	3MXS90EVL 4MXS100EVL	Category	Functions	3MXS90EVL 4MXS100EVL
Basic Function	Inverter (with Inverter Power Control)	○	Health & Clean	Air Purifying Filter	—
	Operation Limit for Cooling (°CDB)	-10 ~ 46		Photocatalytic Deodorizing Filter	—
	Operation Limit for Heating (°CWB)	-15 ~ 15.5		Air Purifying Filter with Photocatalytic Deodorizing Function	—
	PAM Control	○		Titanium Apatite Photocatalytic Air-Purifying Filter	—
Compressor	Oval Scroll Compressor	—	Timer	Longlife Filter	—
	Swing Compressor	○		Mold Proof Air Filter	—
	Rotary Compressor	—		Wipe-clean Flat Panel	—
	Reluctance DC Motor	○		Washable Grille	—
Comfortable Airflow	Power-Airflow Flap	—	Worry Free "Reliability & Durability"	Mold Proof Operation	—
	Power-Airflow Dual Flaps	—		Heating Dry Operation	—
	Power-Airflow Diffuser	—		Good-Sleep Cooling Operation	—
	Wide-Angle Louvers	—		24-Hour On/Off Timer	—
	Vertical Auto-Swing (Up and Down)	—		Night Set Mode	—
	Horizontal Auto-Swing (Right and Left)	—		Auto-Restart (after Power Failure)	—
	3-D Airflow	—		Self-Diagnosis (Digital, LED) Display	○
	Comfort Airflow Mode	—		Wiring-Error Check	○
Comfort Control	3-Step Airflow (H/P Only)	—	Flexibility	Anticorrosion Treatment of Outdoor Heat Exchanger	○
	Auto Fan Speed	—		Multi-Split / Split Type Compatible Indoor Unit	—
	Indoor Unit Quiet Operation	—		Flexible Voltage Correspondence	—
	Night Quiet Mode (Automatic)	○		High Ceiling Application	—
	Outdoor Unit Quiet Operation (Manual)	○		Chargeless	40m
	Intelligent Eye	—		Either Side Drain (Right or Left)	—
	Quick Warming Function	○		Power-Selection	—
	Hot-Start Function	—		Remote Control	5-Rooms Centralized Controller (Option)
Automatic Defrosting	○	Remote Control Adaptor (Normal Open-Pulse Contact) (Option)	—		
Operation	Automatic Operation	—	Remote Control Adaptor (Normal Open Contact) (Option)		—
	Programme Dry Function	—	DIII-NET Compatible (Adaptor) (Option)	—	
	Fan Only	—	Remote Controller	Wireless	—
Lifestyle Convenience	New Powerful Operation (Non-Inverter)	—		Wired	—
	Inverter Powerful Operation	—			
	Priority-Room Setting	○			
	Cooling / Heating Mode Lock	○			
	Home Leave Operation	—			
	ECONO Mode	—			
	Indoor Unit On/Off Switch	—			
	Signal Reception Indicator	—			
	Temperature Display	—			
Another Room Operation	—				

**Note:** ○ : Holding Functions  
 — : No Functions

# Part 2

# Specifications

1. Specifications .....	18
1.1 Indoor Units - Cooling Only .....	18
1.2 Outdoor Units - Cooling Only .....	32
1.3 Indoor Units - Heat Pump .....	38
1.4 Outdoor Units - Heat Pump .....	48

# 1. Specifications

## 1.1 Indoor Units - Cooling Only

### Wall Mounted Type

50Hz 230V

Model			FTKS25DVM	FTKS35DVM
Rated Capacity			2.5kW Class	3.5kW Class
Front Panel Color			White	White
Air Flow Rates	m <sup>3</sup> /min (cfm)	H	8.7 (307)	8.9 (314)
		M	6.7 (237)	6.9 (242)
		L	4.7 (166)	4.8 (169)
		SL	3.9 (138)	4.0 (141)
Fan	Type	Cross Flow Fan		Cross Flow Fan
	Motor Output	W	40	40
	Speed	Steps	5 Steps, Quiet, Auto	5 Steps, Quiet, Auto
Air Direction Control			Right, Left, Horizontal, Downward	Right, Left, Horizontal, Downward
Air Filter			Removable-Washable-Mildew Proof	Removable-Washable-Mildew Proof
Running Current (Rated)	A	0.16	0.18	
Power Consumption (Rated)	W	35	40	
Power Factor	%	95.1	96.6	
Temperature Control			Microcomputer Control	Microcomputer Control
Dimensions (HxWxD)	mm	283x800x195	283x800x195	
Packaged Dimensions (HxWxD)	mm	265x855x340	265x855x340	
Weight	kg	9	9	
Gross Weight	kg	12	12	
Operation Sound	H/L/SL	dBA	37/25/22	39/26/23
Heat Insulation			Both Liquid and Gas Pipes	Both Liquid and Gas Pipes
Piping Connection	Liquid	mm	φ 6.4	φ 6.4
	Gas	mm	φ 9.5	φ 9.5
	Drain	mm	φ18.0	φ18.0
Drawing No.			3D049321	3D049322

Model			FTKS50BVM	FTKS60BVM
Rated Capacity			5.0kW Class	6.0kW Class
Front Panel Color			White	White
Air Flow Rates	m <sup>3</sup> /min (cfm)	H	11.4 (402)	16.2 (572)
		M	9.7 (342)	13.6 (480)
		L	8.0 (282)	11.4 (402)
		SL	7.1 (251)	10.2 (360)
Fan	Type	Cross Flow Fan		Cross Flow Fan
	Motor Output	W	40	43
	Speed	Steps	5 Steps, Quiet, Auto	5 Steps, Quiet, Auto
Air Direction Control			Right, Left, Horizontal, Downward	Right, Left, Horizontal, Downward
Air Filter			Removable-Washable-Mildew Proof	Removable-Washable-Mildew Proof
Running Current (Rated)	A	0.18	0.18	
Power Consumption (Rated)	W	40	40	
Power Factor	%	96.6	96.6	
Temperature Control			Microcomputer Control	Microcomputer Control
Dimensions (HxWxD)	mm	290x795x238	290x1,050x238	
Packaged Dimensions (HxWxD)	mm	280x840x338	337x1,147x366	
Weight	kg	9	12	
Gross Weight	kg	13	17	
Operation Sound	H/M/L/SL	dBA	44/40/35/32	45/41/36/33
Sound Power	H	dBA	63	63
Heat Insulation			Both Liquid and Gas Pipes	Both Liquid and Gas Pipes
Piping Connection	Liquid	mm	φ 6.4	φ 6.4
	Gas	mm	φ12.7	φ12.7
	Drain	mm	φ18.0	φ18.0
Drawing No.			3D040781A	3D040782A

## Conversion Formulae

$\text{kcal/h} = \text{kW} \times 860$   
 $\text{Btu/h} = \text{kW} \times 3414$   
 $\text{cfm} = \text{m}^3/\text{min} \times 35.3$

50Hz 230V

Model			FTKS71BVMB		
Rated Capacity			7.1kW Class		
Front Panel Color			White		
Air Flow Rates	m <sup>3</sup> /min (cfm)	H	16.7 (590)		
		M	14.2 (501)		
		L	11.6 (409)		
		SL	10.6 (374)		
Fan	Type	Cross Flow Fan			
	Motor Output	W	43		
	Speed	Steps	5 Steps, Quiet, Auto		
Air Direction Control			Right, Left, Horizontal, Downward		
Air Filter			Removable-Washable-Mildew Proof		
Running Current (Rated)		A	0.20		
Power Consumption (Rated)		W	45		
Power Factor		%	96.4		
Temperature Control			Microcomputer Control		
Dimensions (HxWxD)		mm	290x1,050x238		
Packaged Dimensions (HxWxD)		mm	337x1,147x366		
Weight		kg	12		
Gross Weight		kg	17		
Operation Sound	H/M/L/SL	dBA	46/42/37/34		
Sound Power	H	dBA	63		
Heat Insulation			Both Liquid and Gas Pipes		
Piping Connection	Liquid	mm	φ 6.4		
	Gas	mm	φ15.9		
	Drain	mm	φ18.0		
Drawing No.			3D040783A		

50Hz 220-230-240V / 60Hz 220-230V

Model			FTKS20DVMA			FTKS25EVMA		
Rated Capacity			2.0kW Class			2.5kW Class		
Front Panel Color			White			White		
Air Flow Rates	m <sup>3</sup> /min (cfm)	H	8.7 (307)			8.7 (307)		
		M	6.7 (237)			6.7 (237)		
		L	4.7 (166)			4.7 (166)		
		SL	3.9 (138)			3.9 (138)		
Fan	Type	Cross Flow Fan						
	Motor Output	W	40			40		
	Speed	Steps	5 Steps, Quiet, Auto			5 Steps, Quiet, Auto		
Air Direction Control			Right, Left, Horizontal, Downward			Right, Left, Horizontal, Downward		
Air Filter			Removable-Washable-Mildew Proof			Removable-Washable-Mildew Proof		
Running Current (Rated)		A	0.17-0.16-0.15/0.17-0.16			0.17-0.16-0.15/0.17-0.16		
Power Consumption (Rated)		W	35			35		
Power Factor		%	93.6-95.1-97.2/93.6-95.1			93.6-95.1-97.2/93.6-95.1		
Temperature Control			Microcomputer Control			Microcomputer Control		
Dimensions (HxWxD)		mm	283x800x195			283x800x195		
Packaged Dimensions (HxWxD)		mm	265x855x340			265x855x340		
Weight		kg	9			9		
Gross Weight		kg	12			12		
Operation Sound	H/M/L/SL	dBA	37/—/25/22			37/31/25/22		
Sound Power	H	dBA	—			61		
Heat Insulation			Both Liquid and Gas Pipes			Both Liquid and Gas Pipes		
Piping Connection	Liquid	mm	φ 6.4			φ 6.4		
	Gas	mm	φ 9.5			φ 9.5		
	Drain	mm	φ18.0			φ18.0		
Drawing No.			3D049754			3D054408		

## Conversion Formulae

kcal/h=kW×860  
 Btu/h=kW×3414  
 cfm=m<sup>3</sup>/min×35.3



50Hz 220-230-240V / 60Hz 220-230V

Model			FTKS35EVMA		
Rated Capacity			3.5kW Class		
Front Panel Color			White		
Air Flow Rates	m <sup>3</sup> /min (cfm)	H	8.9 (314)		
		M	6.9 (244)		
		L	4.8 (169)		
		SL	4.0 (141)		
Fan	Type	Cross Flow Fan			
	Motor Output	W	40		
	Speed	Steps	5 Steps, Quiet, Auto		
Air Direction Control			Right, Left, Horizontal, Downward		
Air Filter			Removable-Washable-Mildew Proof		
Running Current (Rated)		A	0.19-0.18-0.17/0.19-0.18		
Power Consumption (Rated)		W	40		
Power Factor		%	95.7-96.6-98.0/95.7-96.6		
Temperature Control			Microcomputer Control		
Dimensions (HxWxD)		mm	283x800x195		
Packaged Dimensions (HxWxD)		mm	265x855x340		
Weight		kg	9		
Gross Weight		kg	12		
Operation Sound	H/M/L/SL	dBA	38/32/26/23		
Sound Power	H	dBA	62		
Heat Insulation			Both Liquid and Gas Pipes		
Piping Connection	Liquid	mm	φ 6.4		
	Gas	mm	φ 9.5		
	Drain	mm	φ18.0		
Drawing No.			3D054409		

50Hz 230V

Model			FTKS50FVM			FTKS60FVM		
Rated Capacity			5.0kW Class			6.0kW Class		
Front Panel Color			White			White		
Air Flow Rates	m <sup>3</sup> /min (cfm)	H	14.7 (519)			16.2 (572)		
		M	12.6 (445)			13.9 (491)		
		L	10.2 (360)			11.5 (406)		
		SL	9.2 (325)			10.0 (353)		
Fan	Type	Cross Flow Fan						
	Motor Output	W	43			43		
	Speed	Steps	5 Steps, Quiet, Auto			5 Steps, Quiet, Auto		
Air Direction Control			Right, Left, Horizontal, Downward			Right, Left, Horizontal, Downward		
Air Filter			Removable-Washable-Mildew Proof			Removable-Washable-Mildew Proof		
Running Current (Rated)		A	0.15			0.18		
Power Consumption (Rated)		W	34			40		
Power Factor		%	98.6			96.6		
Temperature Control			Microcomputer Control			Microcomputer Control		
Dimensions (HxWxD)		mm	290x1,050x238			290x1,050x238		
Packaged Dimensions (HxWxD)		mm	337x1,147x366			337x1,147x366		
Weight		kg	12			12		
Gross Weight		kg	17			17		
Operation Sound	H/M/L/SL	dBA	43/39/34/31			45/41/36/33		
Heat Insulation			Both Liquid and Gas Pipes			Both Liquid and Gas Pipes		
Piping Connection	Liquid	mm	φ 6.4			φ 6.4		
	Gas	mm	φ12.7			φ12.7		
	Drain	mm	φ18.0			φ18.0		
Drawing No.			3D056225			3D056226		

Conversion Formulae
kcal/h=kWx860
Btu/h=kWx3414
cfm=m <sup>3</sup> /minx35.3

50Hz 230V

Model			FTKS71FVM		
Rated Capacity			7.1kW Class		
Front Panel Color			White		
Air Flow Rates	m <sup>3</sup> /min (cfm)	H	17.4 (614)		
		M	14.6 (516)		
		L	11.9 (420)		
		SL	10.7 (378)		
Fan	Type	Cross Flow Fan			
	Motor Output	W	43		
	Speed	Steps	5 Steps, Quiet, Auto		
Air Direction Control			Right, Left, Horizontal, Downward		
Air Filter			Removable-Washable-Mildew Proof		
Running Current (Rated)		A	0.20		
Power Consumption (Rated)		W	45		
Power Factor		%	97.8		
Temperature Control			Microcomputer Control		
Dimensions (HxWxD)		mm	290x1,050x238		
Packaged Dimensions (HxWxD)		mm	337x1,147x366		
Weight		kg	12		
Gross Weight		kg	17		
Operation Sound	H/M/L/SL	dBA	46/42/37/34		
Sound Power	H	dBA	—		
Heat Insulation			Both Liquid and Gas Pipes		
Piping Connection	Liquid	mm	φ 6.4		
	Gas	mm	φ15.9		
	Drain	mm	φ18.0		
Drawing No.			3D056227		

50Hz 220-230-240V / 60Hz 220-230V

Model			FTKS50FVMA			FTKS60FVMA		
Rated Capacity			5.0kW Class			6.0kW Class		
Front Panel Color			White			White		
Air Flow Rates	m <sup>3</sup> /min (cfm)	H	14.7 (519)			16.2 (572)		
		M	12.6 (445)			13.9 (491)		
		L	10.2 (360)			11.5 (406)		
		SL	9.2 (325)			10.0 (353)		
Fan	Type	Cross Flow Fan						
	Motor Output	W	43			43		
	Speed	Steps	5 Steps, Quiet, Auto			5 Steps, Quiet, Auto		
Air Direction Control			Right, Left, Horizontal, Downward			Right, Left, Horizontal, Downward		
Air Filter			Removable-Washable-Mildew Proof			Removable-Washable-Mildew Proof		
Running Current (Rated)		A	0.16-0.15-0.15/0.16-0.15			0.19-0.18-0.17/0.19-0.18		
Power Consumption (Rated)		W	34			40		
Power Factor		%	96.6-98.6-94.4/96.6-98.6			95.7-96.6-98.0/95.7-96.6		
Temperature Control			Microcomputer Control			Microcomputer Control		
Dimensions (HxWxD)		mm	290x1,050x238			290x1,050x238		
Packaged Dimensions (HxWxD)		mm	337x1,147x366			337x1,147x366		
Weight		kg	12			12		
Gross Weight		kg	17			17		
Operation Sound	H/M/L/SL	dBA	44/40/35/32			45/41/36/33		
Sound Power	H	dBA	60			61		
Heat Insulation			Both Liquid and Gas Pipes			Both Liquid and Gas Pipes		
Piping Connection	Liquid	mm	φ 6.4			φ 6.4		
	Gas	mm	φ12.7			φ12.7		
	Drain	mm	φ18.0			φ18.0		
Drawing No.			3D054876			3D054877		

## Conversion Formulae

kcal/h=kW×860  
 Btu/h=kW×3414  
 cfm=m<sup>3</sup>/min×35.3

50Hz 220-230-240V / 60Hz 220-230V

Model			FTKS71FVMA		
Rated Capacity			7.1kW Class		
Front Panel Color			White		
Air Flow Rates	m <sup>3</sup> /min (cfm)	H	17.4 (614)		
		M	14.6 (516)		
		L	11.9 (420)		
		SL	11.2 (395)		
Fan	Type	Cross Flow Fan			
	Motor Output	W	43		
	Speed	Steps	5 Steps, Quiet, Auto		
Air Direction Control			Right, Left, Horizontal, Downward		
Air Filter			Removable-Washable-Mildew Proof		
Running Current (Rated)		A	0.21-0.20-0.19/0.21-0.20		
Power Consumption (Rated)		W	45		
Power Factor		%	97.4-97.8-98.7/97.4-97.8		
Temperature Control			Microcomputer Control		
Dimensions (HxWxD)		mm	290x1,050x238		
Packaged Dimensions (HxWxD)		mm	337x1,147x366		
Weight		kg	12		
Gross Weight		kg	17		
Operation Sound	H/M/L/SL	dBA	46/42/37/34		
Sound Power	H	dBA	62		
Heat Insulation			Both Liquid and Gas Pipes		
Piping Connection	Liquid	mm	φ 6.4		
	Gas	mm	φ15.9		
	Drain	mm	φ18.0		
Drawing No.			3D054878A		

60Hz 220V

Model			FTKS20DVMT			FTKS25DVMT		
Capacity			2.0kW Class			2.5kW Class		
Front Panel Color			White			White		
Air Flow Rates	m <sup>3</sup> /min (cfm)	H	8.7 (307)			8.7 (307)		
		M	6.7 (237)			6.7 (237)		
		L	4.7 (166)			4.7 (166)		
		SL	3.9 (138)			3.9 (138)		
Fan	Type	Cross Flow Fan						
	Motor Output	W	40			40		
	Speed	Steps	5 Steps, Quiet, Auto			5 Steps, Quiet, Auto		
Air Direction Control			Right, Left, Horizontal, Downward			Right, Left, Horizontal, Downward		
Air Filter			Removable-Washable-Mildew Proof			Removable-Washable-Mildew Proof		
Running Current		A	0.17			0.17		
Power Consumption		W	35			35		
Power Factor		%	93.6			93.6		
Temperature Control			Microcomputer Control			Microcomputer Control		
Dimensions (HxWxD)		mm	283x800x195			283x800x195		
Packaged Dimensions (HxWxD)		mm	265x855x340			265x855x340		
Weight		kg	9			9		
Gross Weight		kg	12			12		
Operation Sound	H/L/SL	dBA	38/25/22			38/25/22		
Heat Insulation			Both Liquid and Gas Pipes			Both Liquid and Gas Pipes		
Piping Connection	Liquid	mm	φ 6.4			φ 6.4		
	Gas	mm	φ 9.5			φ 9.5		
	Drain	mm	φ18.0			φ18.0		
Drawing No.			3D049894A			3D049895A		

Conversion Formulae
kcal/h=kWx860
Btu/h=kWx3414
cfm=m <sup>3</sup> /minx35.3

60Hz 220V

Model			FTKS35DVMT	FTKS50DVMT
Capacity			3.5kW Class	5.0kW Class
Front Panel Color			White	White
Air Flow Rates	m <sup>3</sup> /min (cfm)	H	8.9 (314)	11.4 (402)
		M	6.9 (244)	9.7 (342)
		L	4.8 (169)	8.0 (282)
		SL	4.0 (141)	7.1 (251)
Fan	Type	Cross Flow Fan		Cross Flow Fan
	Motor Output	W	40	40
	Speed	Steps	5 Steps, Quiet, Auto	5 Steps, Quiet, Auto
Air Direction Control			Right, Left, Horizontal, Downward	Right, Left, Horizontal, Downward
Air Filter			Removable-Washable-Mildew Proof	Removable-Washable-Mildew Proof
Running Current		A	0.19	0.19
Power Consumption		W	40	40
Power Factor		%	95.7	95.7
Temperature Control			Microcomputer Control	Microcomputer Control
Dimensions (HxWxD)		mm	283x800x195	290x795x238
Packaged Dimensions (HxWxD)		mm	265x855x340	280x840x338
Weight		kg	9	9
Gross Weight		kg	12	13
Operation Sound	H/L/SL	dBA	39/—/26/23	44/40/35/32
Heat Insulation			Both Liquid and Gas Pipes	Both Liquid and Gas Pipes
Piping Connection	Liquid	mm	φ 6.4	φ 6.4
	Gas	mm	φ 9.5	φ12.7
	Drain	mm	φ18.0	φ18.0
Drawing No.			3D049896A	3D049986

## Conversion Formulae

$\text{kcal/h} = \text{kW} \times 860$   
 $\text{Btu/h} = \text{kW} \times 3414$   
 $\text{cfm} = \text{m}^3/\text{min} \times 35.3$

60Hz 220V

Model			FTKS60DVMT	FTKS71DVMT
Capacity			6.0kW Class	7.1kW Class
Front Panel Color			White	White
Air Flow Rates	m <sup>3</sup> /min (cfm)	H	16.2 (572)	16.7 (590)
		M	13.6 (480)	14.2 (501)
		L	11.4 (402)	11.6 (409)
		SL	10.2 (360)	10.6 (374)
Fan	Type	Cross Flow Fan		Cross Flow Fan
	Motor Output	W	43	43
	Speed	Steps	5 Steps, Quiet, Auto	5 Steps, Quiet, Auto
Air Direction Control			Right, Left, Horizontal, Downward	Right, Left, Horizontal, Downward
Air Filter			Removable-Washable-Mildew Proof	Removable-Washable-Mildew Proof
Running Current		A	0.21	0.23
Power Consumption		W	45	50
Power Factor		%	97.4	98.8
Temperature Control			Microcomputer Control	Microcomputer Control
Dimensions (HxWxD)		mm	290x1,050x238	290x1,050x238
Packaged Dimensions (HxWxD)		mm	337x1,147x366	337x1,147x366
Weight		kg	12	12
Gross Weight		kg	17	17
Operation Sound	H/L/SL	dBA	45/41/36/33	46/42/37/34
Heat Insulation			Both Liquid and Gas Pipes	Both Liquid and Gas Pipes
Piping Connection	Liquid	mm	φ 6.4	φ 6.4
	Gas	mm	φ12.7	φ15.9
	Drain	mm	φ18.0	φ18.0
Drawing No.			3D049987	3D049988

Model			FTKS50FVLT	FTKS60FVLT
Capacity			5.0kW Class	6.0kW Class
Front Panel Color			White	White
Air Flow Rates	m <sup>3</sup> /min (cfm)	H	14.7 (519)	16.2 (572)
		M	12.4 (438)	13.6 (480)
		L	10.3 (364)	11.4 (403)
		SL	9.5 (335)	10.2 (360)
Fan	Type	Cross Flow Fan		Cross Flow Fan
	Motor Output	W	43	43
	Speed	Steps	5 Steps, Quiet, Auto	5 Steps, Quiet, Auto
Air Direction Control			Right, Left, Horizontal, Downward	Right, Left, Horizontal, Downward
Air Filter			Removable / Washable / Mildew Proof	Removable / Washable / Mildew Proof
Running Current		A	0.16	0.19
Power Consumption		W	34	40
Power Factor		%	96.6	95.7
Temperature Control			Microcomputer Control	Microcomputer Control
Dimensions (HxWxD)		mm	290x1,050x238	290x1,050x238
Packaged Dimensions (HxWxD)		mm	337x1,147x366	337x1,147x366
Weight		kg	12	12
Gross Weight		kg	17	17
Operation Sound	H/M/L/SL	dBA	43/39/34/31	45/41/36/33
Heat Insulation			Both Liquid and Gas Pipes	Both Liquid and Gas Pipes
Piping Connection	Liquid	mm	φ 6.4	φ 6.4
	Gas	mm	φ12.7	φ12.7
	Drain	mm	φ18.0	φ18.0
Drawing No.			3D056228	3D056229

Conversion Formulae
kcal/h=kW×860
Btu/h=kW×3414
cfm=m <sup>3</sup> /min×35.3

60Hz 220V

Model			FTKS71FVLT
Capacity			7.1kW Class
Front Panel Color			White
Air Flow Rates	m <sup>3</sup> /min (cfm)	H	17.4 (614)
		M	14.6 (516)
		L	11.6 (410)
		SL	10.6 (374)
Fan	Type	Cross Flow Fan	
	Motor Output	W	43
	Speed	Steps	5 Steps, Quiet, Auto
Air Direction Control			Right, Left, Horizontal, Downward
Air Filter			Removable / Washable / Mildew Proof
Running Current		A	0.21
Power Consumption		W	45
Power Factor		%	97.4
Temperature Control			Microcomputer Control
Dimensions (HxWxD)		mm	290x1,050x238
Packaged Dimensions (HxWxD)		mm	337x1,147x366
Weight		kg	12
Gross Weight		kg	17
Operation Sound	H/M/L/SL	dBA	46/42/37/34
Heat Insulation			Both Liquid and Gas Pipes
Piping Connection	Liquid	mm	φ 6.4
	Gas	mm	φ15.9
	Drain	mm	φ18.0
Drawing No.			3D056230

Conversion Formulae
kcal/h=kW×860
Btu/h=kW×3414
cfm=m <sup>3</sup> /min×35.3

Duct Connected Type

50Hz 230V

Model			FDKS25CAVMB	FDKS35CAVMB
Rated Capacity			2.5kW Class	3.5kW Class
Front Panel Color			—	—
Air Flow Rates	m <sup>3</sup> /min (cfm)	H	9.5 (335)	10.0 (353)
		M	8.8 (311)	9.3 (328)
		L	8.0 (282)	8.5 (300)
		SL	6.7 (237)	7.0 (247)
Fan	Type	Sirocco Fan		Sirocco Fan
	Motor Output	W	62	62
	Speed	Steps	5 Steps, Quiet, Auto	5 Steps, Quiet, Auto
Air Filter			Removable-Washable-Mildew Proof	Removable-Washable-Mildew Proof
Running Current (Rated)		A	0.47	0.47
Power Consumption (Rated)		W	100	100
Power Factor		%	92.5	92.5
Temperature Control			Microcomputer Control	Microcomputer Control
Dimensions (HxWxD)		mm	200x900x620	200x900x620
Packaged Dimensions (HxWxD)		mm	266x1,106x751	266x1,106x751
Weight		kg	25	25
Gross Weight		kg	31	31
Operation Sound	H/M/L/SL	dBA	35/33/31/29	35/33/31/29
External Static Pressure		Pa	40	40
Moisture Removal		L/h	1.2	1.9
Heat Insulation			Both Liquid and Gas Pipes	Both Liquid and Gas Pipes
Piping Connection	Liquid	mm	φ 6.4	φ 6.4
	Gas	mm	φ 9.5	φ 9.5
	Drain	mm	VP20 (O.D. φ26 / I.D. φ20)	VP20 (O.D. φ26 / I.D. φ20)
Drawing No.			3D048947C	3D048948C

Model			FDKS50CVMB	FDKS60CVMB
Rated Capacity			5.0kW Class	6.0kW Class
Front Panel Color			—	—
Air Flow Rates	m <sup>3</sup> /min (cfm)	H	12.0 (424)	16.0 (565)
		M	11.0 (388)	14.8 (523)
		L	10.0 (353)	13.5 (477)
		SL	8.4 (297)	11.2 (395)
Fan	Type	Sirocco Fan		Sirocco Fan
	Motor Output	W	130	130
	Speed	Steps	5 Steps, Quiet, Auto	5 Steps, Quiet, Auto
Air Filter			Removable-Washable-Mildew Proof	Removable-Washable-Mildew Proof
Running Current (Rated)		A	0.64	0.74
Power Consumption (Rated)		W	140	160
Power Factor		%	95.1	94.0
Temperature Control			Microcomputer Control	Microcomputer Control
Dimensions (HxWxD)		mm	200x900x620	200x1,100x620
Packaged Dimensions (HxWxD)		mm	266x1,106x751	266x1,306x751
Weight		kg	27	30
Gross Weight		kg	34	37
Operation Sound	H/M/L/SL	dBA	37/35/33/31	38/36/34/32
External Static Pressure		Pa	40	40
Moisture Removal		L/h	2.9	3.9
Heat Insulation			Both Liquid and Gas Pipes	Both Liquid and Gas Pipes
Piping Connection	Liquid	mm	φ 6.4	φ 6.4
	Gas	mm	φ12.7	φ12.7
	Drain	mm	VP20 (O.D. φ26 / I.D. φ20)	VP20 (O.D. φ26 / I.D. φ20)
Drawing No.			3D052134A	3D052135

**Note:** 1. The operating sound is based on the rear side suction inlet and the external static pressure 40 Pa. Operating sound for under side suction inlet: [operating sound for rear side suction inlet]+5 dB. However, when installation to which the external static pressure becomes low is carried out, 5 dB or more may go up.

Conversion Formulae
kcal/h=kW×860
Btu/h=kW×3414
cfm=m <sup>3</sup> /min×35.3

50Hz 230V

Model			FDKS25EAVMB	FDKS35EAVMB
Rated Capacity			2.5kW Class	3.5kW Class
Front Panel Color			—	—
Air Flow Rates	m <sup>3</sup> /min (cfm)	H	8.7 (307)	8.7 (307)
		M	8.0 (282)	8.0 (282)
		L	7.3 (258)	7.3 (258)
		SL	6.2 (219)	6.2 (219)
Fan	Type		Sirocco Fan	Sirocco Fan
	Motor Output	W	62	62
	Speed	Steps	5 Steps, Quiet, Auto	5 Steps, Quiet, Auto
Air Filter			Removable-Washable-Mildew Proof	Removable-Washable-Mildew Proof
Running Current (Rated)		A	0.48	0.48
Power Consumption (Rated)		W	71	71
Power Factor		%	64.3	64.3
Temperature Control			Microcomputer Control	Microcomputer Control
Dimensions (HxWxD)		mm	200x700x620	200x700x620
Packaged Dimensions (HxWxD)		mm	274x906x751	274x906x751
Weight		kg	21	21
Gross Weight		kg	29	29
Operation Sound	H/M/L/SL	dBA	35/33/31/29	35/33/31/29
External Static Pressure		Pa	30	30
Moisture Removal		L/h	1.2	1.9
Heat Insulation			Both Liquid and Gas Pipes	Both Liquid and Gas Pipes
Piping Connection	Liquid	mm	φ 6.4	φ 6.4
	Gas	mm	φ 9.5	φ 9.5
	Drain	mm	VP20 (O.D.φ 26 / I.D.φ 20)	VP20 (O.D.φ 26 / I.D.φ 20)
Drawing No.			3D051882A	3D051884A

Model			CDKS25CVMA	CDKS35CVMA
Rated Capacity			2.5kW Class	3.5kW Class
Front Panel Color			—	—
Air Flow Rates	m <sup>3</sup> /min (cfm)	H	9.5 (335)	10.0 (353)
		M	8.8 (311)	9.3 (328)
		L	8.0 (282)	8.5 (300)
		SL	6.7 (237)	7.0 (247)
Fan	Type		Sirocco Fan	Sirocco Fan
	Motor Output	W	62	62
	Speed	Steps	5 Steps, Quiet, Auto	5 Steps, Quiet, Auto
Air Filter			Removable-Washable-Mildew Proof	Removable-Washable-Mildew Proof
Running Current (Rated)		A	0.47	0.47
Power Consumption (Rated)		W	100	100
Power Factor		%	92.5	92.5
Temperature Control			Microcomputer Control	Microcomputer Control
Dimensions (HxWxD)		mm	200x900x620	200x900x620
Packaged Dimensions (HxWxD)		mm	266x1,106x751	266x1,106x751
Weight		kg	25	25
Gross Weight		kg	31	31
Operation Sound	H/M/L/SL	dBA	35/33/31/29	35/33/31/29
Moisture Removal		L/h	1.2	1.9
Heat Insulation			Both Liquid and Gas Pipes	Both Liquid and Gas Pipes
Piping Connection	Liquid	mm	φ 6.4	φ 6.4
	Gas	mm	φ 9.5	φ 9.5
	Drain	mm	VP20 (O.D.φ 26 / I.D.φ 20)	VP20 (O.D.φ 26 / I.D.φ 20)
Drawing No.			3D049723	3D049724

## Conversion Formulae

kcal/h=kW×860  
 Btu/h=kW×3414  
 cfm=m<sup>3</sup>/min×35.3



50Hz 230V

Model			CDKS50CVMA	CDKS60CVMA
Rated Capacity			5.0kW Class	6.0kW Class
Front Panel Color			—	—
Air Flow Rates	m <sup>3</sup> /min (cfm)	H	12.0 (424)	16.0 (565)
		M	11.0 (388)	14.8 (523)
		L	10.0 (353)	13.5 (477)
		SL	8.4 (297)	11.2 (395)
Fan	Type	Sirocco Fan		Sirocco Fan
	Motor Output	W	130	130
	Speed	Steps	5 Steps, Quiet, Auto	5 Steps, Quiet, Auto
Air Filter			Removable-Washable-Mildew Proof	Removable-Washable-Mildew Proof
Running Current (Rated)		A	0.64	0.74
Power Consumption (Rated)		W	140	160
Power Factor		%	95.1	94.0
Temperature Control			Microcomputer Control	Microcomputer Control
Dimensions (HxWxD)		mm	200x900x620	200x1,100x620
Packaged Dimensions (HxWxD)		mm	266x1,106x751	266x1,306x751
Weight		kg	27	30
Gross Weight		kg	34	37
Operation Sound	H/M/L/SL	dBA	37/35/33/31	38/36/34/32
Moisture Removal		L/h	2.9	3.9
Heat Insulation			Both Liquid and Gas Pipes	Both Liquid and Gas Pipes
Piping Connection	Liquid	mm	φ 6.4	φ 6.4
	Gas	mm	φ12.7	φ12.7
	Drain	mm	VP20 (O.D. φ 26 / I.D. φ 20)	VP20 (O.D. φ 26 / I.D. φ 20)
Drawing No.			3D049725	3D049726

60Hz 220V

Model			CDKS25DVMT	CDKS35DVMT
Capacity			2.5kW Class	3.5kW Class
Front Panel Color			—	—
Air Flow Rates	m <sup>3</sup> /min (cfm)	H	9.5 (335)	10.0 (353)
		M	8.8 (311)	9.3 (328)
		L	8.0 (282)	8.5 (300)
		SL	6.7 (237)	7.0 (247)
Fan	Type	Sirocco Fan		Sirocco Fan
	Motor Output	W	62	62
	Speed	Steps	5 Steps, Quiet, Auto	5 Steps, Quiet, Auto
Air Filter			Removable-Washable-Mildew Proof	Removable-Washable-Mildew Proof
Running Current (Rated)		A	0.47	0.47
Power Consumption (Rated)		W	100	100
Power Factor		%	92.5	92.5
Temperature Control			Microcomputer Control	Microcomputer Control
Dimensions (HxWxD)		mm	200x900x620	200x900x620
Packaged Dimensions (HxWxD)		mm	266x1,106x751	266x1,106x751
Weight		kg	25	25
Operation Sound	H/M/L/SL	dBA	35/33/31/29	35/33/31/29
External Static Pressure		Pa	40	40
Moisture Removal		l/h	1.2	1.9
Heat Insulation			Both Liquid and Gas Pipes	Both Liquid and Gas Pipes
Piping Connection	Liquid	mm	φ 6.4	φ 6.4
	Gas	mm	φ 9.5	φ 9.5
	Drain	mm	VP20(O.D. φ 26 / I.D. φ 20)	VP20(O.D. φ 26 / I.D. φ 20)
Drawing No.			3D049719	3D049720

**Note:** 1. The operating sound is based on the rear side suction inlet and the external static pressure 40 Pa. Operating sound for under side suction inlet: [operating sound for rear side suction inlet]+5 dB. However, when installation to which the external static pressure becomes low is carried out, 5 dB or more may go up.

Conversion Formulae
kcal/h=kWx860
Btu/h=kWx3414
cfm=m <sup>3</sup> /minx35.3

60Hz 220V

Model			CDKS50DVMT	CDKS60DVMT
Capacity			5.0kW Class	6.0kW Class
Front Panel Color			—	—
Air Flow Rates	m <sup>3</sup> /min (cfm)	H	12.0 (424)	16.0 (565)
		M	11.0 (388)	14.8 (523)
		L	10.0 (353)	13.5 (477)
		SL	8.4 (297)	11.2 (395)
Fan	Type	Sirocco Fan		Sirocco Fan
	Motor Output	W	130	130
	Speed	Steps	5 Steps, Quiet, Auto	5 Steps, Quiet, Auto
Air Filter			Removable-Washable-Mildew Proof	Removable-Washable-Mildew Proof
Running Current (Rated)		A	0.64	0.74
Power Consumption (Rated)		W	140	160
Power Factor		%	95.1	94.0
Temperature Control			Microcomputer Control	Microcomputer Control
Dimensions (HxWxD)		mm	200x900x620	200x1,100x620
Packaged Dimensions (HxWxD)		mm	266x1,106x751	266x1,306x751
Weight		kg	27	30
Operation Sound	H/M/L/SL	dBA	37/35/33/31	38/36/34/32
External Static Pressure		Pa	40	40
Moisture Removal		l/h	2.9	3.9
Heat Insulation			Both Liquid and Gas Pipes	Both Liquid and Gas Pipes
Piping Connection	Liquid	mm	φ 6.4	φ 6.4
	Gas	mm	φ12.7	φ12.7
	Drain	mm	VP20 (O.D.φ 26 / I.D.φ 20)	VP20 (O.D.φ 26 / I.D.φ 20)
Drawing No.			3D049721	3D049722

50Hz 220-230-240V / 60Hz 220-230V

Model			CDKS25EAVMA	CDKS35EAVMA
Rated Capacity			2.5kW Class	3.5kW Class
Front Panel Color			—	—
Air Flow Rates	m <sup>3</sup> /min (cfm)	H	8.7 (307)	8.7 (307)
		M	8.0 (282)	8.0 (282)
		L	7.3 (258)	7.3 (258)
		SL	6.2 (219)	6.2 (219)
Fan	Type	Sirocco Fan		Sirocco Fan
	Motor Output	W	62	62
	Speed	Steps	5 Steps, Quiet, Auto	5 Steps, Quiet, Auto
Air Filter			Removable-Washable-Mildew Proof	Removable-Washable-Mildew Proof
Running Current (Rated)		A	0.47-0.48-0.49/0.52-0.53	0.47-0.48-0.49/0.52-0.53
Power Consumption (Rated)		W	70-71-72/72-73	70-71-72/72-73
Power Factor		%	67.7-64.3-61.2/62.9-59.9	67.7-64.3-61.2/62.9-59.9
Temperature Control			Microcomputer Control	Microcomputer Control
Dimensions (HxWxD)		mm	200x700x620	200x700x620
Packaged Dimensions (HxWxD)		mm	274x906x751	274x906x751
Weight		kg	21	21
Gross Weight		kg	29	29
Operation Sound	H/M/L/SL	dBA	35/33/31/29	35/33/31/29
Moisture Removal		l/h	1.2	1.9
Heat Insulation			Both Liquid and Gas Pipes	Both Liquid and Gas Pipes
Piping Connection	Liquid	mm	φ 6.4	φ 6.4
	Gas	mm	φ 9.5	φ 9.5
	Drain	mm	VP20 (O.D.φ 26 / I.D.φ 20)	VP20 (O.D.φ 26 / I.D.φ 20)
Drawing No.			3D051142	3D051143

## Conversion Formulae

kcal/h=kWx860  
 Btu/h=kWx3414  
 cfm=m<sup>3</sup>/minx35.3

Model			CDKS25EAVMT	CDKS35EAVMT
Rated Capacity			2.5kW Class	3.5kW Class
Front Panel Color			—	—
Air Flow Rate	m <sup>3</sup> /min (cfm)	H	8.7 (307)	8.7 (307)
		M	8.0 (282)	8.0 (282)
		L	7.3 (258)	7.3 (258)
		SL	6.2 (219)	6.2 (219)
Fan	Type		Sirocco Fan	Sirocco Fan
	Motor Output	W	62	62
	Speed	Steps	5 Steps, Quiet, Auto	5 Steps, Quiet, Auto
Running Current (Rated)		A	0.52	0.52
Power Consumption (Rated)		W	72	72
Power Factor		%	62.9	62.9
Temperature Control			Microcomputer Control	Microcomputer Control
Dimensions (HxWxD)		mm	200x700x620	200x700x620
Packaged Dimensions (HxWxD)		mm	274x906x751	274x906x751
Weight		kg	21	21
Gross Weight		kg	29	29
Operation Sound	H/M/L/SL	dBA	35/33/31/29	35/33/31/29
External Static Pressure		Pa	30	30
Moisture Removal		L/h	1.2	1.9
Heat Insulation			Both Liquid and Gas Pipes	Both Liquid and Gas Pipes
Piping Connection	Liquid	mm	φ 6.4	φ 6.4
	Gas	mm	φ 9.5	φ 9.5
	Drain	mm	VP20 (O.D. φ 26 / I.D. φ 20)	VP20 (O.D. φ 26 / I.D. φ 20)
Drawing No.			3D052115	3D052116

**Note:** 1. The operating sound is based on the rear side suction inlet and the external static pressure 40 Pa. Operating sound for under side suction inlet: [operating sound for rear side suction inlet]+5 dB. However, when installation to which the external static pressure becomes low is carried out, 5 dB or more may go up.

Conversion Formulae
kcal/h=kW×860
Btu/h=kW×3414
cfm=m <sup>3</sup> /min×35.3

## Ceiling Mounted Cassette Type

50Hz 230V

Model			FFQ25B8V1B	FFQ35B8V1B
Rated Capacity			2.5kW Class	3.5kW Class
Decoration Panel	Color		White	White
	Dimensions (HxWxD)		55x700x700	55x700x700
Air Flow Rates	m <sup>3</sup> /min (cfm)	H	9.0 (318)	10.0 (353)
		M	—	—
		L	6.5 (230)	6.5 (230)
		SL	—	—
Fan	Type		Turbo Fan	Turbo Fan
	Motor Output	W	55	55
	Speed	Steps	2 Steps	2 Steps
Air Direction Control			Horizontal, Downward	Horizontal, Downward
Air Filter			Removable-Washable-Mildew Proof	Removable-Washable-Mildew Proof
Running Current (Rated)		A	0.37	0.40
Power Consumption (Rated)		W	73	84
Power Factor		%	85.8	91.3
Temperature Control			Microcomputer Control	Microcomputer Control
Dimensions (HxWxD) ★1		mm	260 (286)x575x575	260 (286)x575x575
Packaged Dimensions (HxWxD)		mm	370x687x674	370x687x674
Weight		kg	17.5	17.5
Gross Weight		kg	21	21
Operation Sound	H/L	dBA	29.5/24.5	32.0/25.0
Sound Power	H	dBA	46.5	49.0
Heat Insulation			Both Liquid and Gas Pipes	Both Liquid and Gas Pipes
Piping Connection	Liquid	mm	φ 6.4	φ 6.4
	Gas	mm	φ 9.5	φ 9.5
	Drain	mm	VP20 (O.D.φ 26 / I.D.φ 20)	VP20 (O.D.φ 26 / I.D.φ 20)
Drawing No.			3D040444A	3D040442A

50Hz 230V

Model			FFQ50B8V1B	FFQ60B8V1B
Rated Capacity			5.0kW Class	6.0kW Class
Decoration Panel	Color		White	White
	Dimensions (HxWxD)		55x700x700	55x700x700
Air Flow Rates	m <sup>3</sup> /min (cfm)	H	12.0 (424)	15.5 (530)
		M	—	—
		L	8.0 (283)	10.0 (353)
		SL	—	—
Fan	Type		Turbo Fan	Turbo Fan
	Motor Output	W	55	55
	Speed	Steps	2 Steps	2 Steps
Air Direction Control			Horizontal, Downward	Horizontal, Downward
Air Filter			Removable-Washable-Mildew Proof	Removable-Washable-Mildew Proof
Running Current (Rated)		A	0.49	0.61
Power Consumption (Rated)		W	97	120
Power Factor		%	86.1	85.5
Temperature Control			Microcomputer Control	Microcomputer Control
Dimensions (HxWxD) ★1		mm	260 (286)x575x575	260 (286)x575x575
Packaged Dimensions (HxWxD)		mm	370x687x674	370x687x674
Weight		kg	17.5	17.5
Gross Weight		kg	21	21
Operation Sound	H/L	dBA	36/27	41/32
Sound Power	H	dBA	53	58
Heat Insulation			Both Liquid and Gas Pipes	Both Liquid and Gas Pipes
Piping Connection	Liquid	mm	φ 6.4	φ 6.4
	Gas	mm	φ12.7	φ12.7
	Drain	mm	VP20 (O.D.φ 26 / I.D.φ 20)	VP20 (O.D.φ 26 / I.D.φ 20)
Drawing No.			3D040437	3D040431

★1 ( ) : dimension including control box

Conversion Formulae

$$\begin{aligned} \text{kcal/h} &= \text{kW} \times 860 \\ \text{Btu/h} &= \text{kW} \times 3414 \\ \text{cfm} &= \text{m}^3/\text{min} \times 35.3 \end{aligned}$$

## 1.2 Outdoor Units - Cooling Only

50Hz 230-240V

Model		3MKS58EVMA		3MKS75EVMA	
Cooling Capacity		kW	—		—
Power Consumption		W	—		—
Running Current		A	—		—
Casing Color			Ivory White	Ivory White	
Compressor	Type	Hermetically Sealed Swing Type		Hermetically Sealed Swing Type	
	Model	2YC36BXD		2YC45BXD	
	Motor Output	W	1,100		1,380
Refrigerant Oil	Model	FVC50K		FVC50K	
	Charge	L	0.65		0.75
Refrigerant	Type	R-410A		R-410A	
	Charge	kg	2.0		2.3
Air Flow Rates	m <sup>3</sup> /min	H	45		51
		L	45		45
	cfm	H	1,589		1,801
		L	1,589		1,589
Fan	Type	Propeller		Propeller	
	Motor Output	W	53		53
	Running Current	A	H: 0.33 / L: 0.33		H: 0.33 / L: 0.25
	Power Consumption	W	H: 43 / L: 43		H: 68 / L: 46
Starting Current		A	6.8		9.2
Dimensions (HxWxD)		mm	735x936x300		735x936x300
Packaged Dimensions (HxWxD)		mm	792x992x390		792x992x390
Weight		kg	49		58
Gross Weight		kg	56		64
Operation Sound		dBA	46		48
Sound Power		dBA	59		61
Piping Connection	Liquid	mm	φ 6.4x3		φ 6.4x3
	Gas	mm	φ 12.7x3		φ 12.7x2, φ 15.9x1
	Drain	mm	φ 18.0		φ 18.0
Heat Insulation			Both Liquid and Gas Pipes	Both Liquid and Gas Pipes	
No. of Wiring Connection			3 for Power Supply, 4 for Interunit Wiring	3 for Power Supply, 4 for Interunit Wiring	
Max. Interunit Piping Length		m	50 (for Total of Each Room)		60 (for Total of Each Room)
		m	25 (for One Room)		25 (for One Room)
Amount of Additional Charge		g/m	Chargeless		Chargeless
Max. Installation Height Difference		m	15 (between Indoor Unit and Outdoor Unit)		15 (between Indoor Unit and Outdoor Unit)
		m	15 (between Indoor Units)		15 (between Indoor Units)
Drawing No.			3D055029	3D055077	

**Note:** 1. The data are based on the conditions shown in the table below.

Cooling	Piping Length
Indoor ; 27°CDB/19°CWB Outdoor ; 35°CDB	7.5m

Conversion Formulae
kcal/h=kWx860 Btu/h=kWx3414 cfm=m <sup>3</sup> /minx35.3

50Hz 220-230-240V / 60Hz 220-230V

Model		4MKS90EVMA	
Cooling Capacity	kW	—	
Power Consumption	W	—	
Running Current	A	—	
Casing Color		Ivory White	
Compressor	Type	Hermetically Sealed Swing Type	
	Model	2YC63BXD	
	Motor Output	W	1,920
Refrigerant Oil	Model	FVC50K	
	Charge	L	0.75
Refrigerant	Type	R-410A	
	Charge	kg	3.1
Air Flow Rates	m <sup>3</sup> /min	H	54.5
		L	46.0
	cfm	H	1,924
		L	1,624
Fan	Type	Propeller	
	Motor Output	W	66
	Running Current	A	H: 0.97 / L: 0.69
	Power Consumption	W	H: 86 / L: 55
Starting Current	A	11.2	
Dimensions (HxWxD)	mm	770x900x320	
Packaged Dimensions (HxWxD)	mm	900x925x390	
Weight	kg	69	
Gross Weight	kg	79	
Operation Sound	dBA	48	
Sound Power	dBA	61	
Piping Connection	Liquid	mm	φ 6.4x4
	Gas	mm	φ 9.5x1, φ 12.7x1, φ 15.9x2
	Drain	mm	φ 25.0
Heat Insulation		Both Liquid and Gas Pipes	
No. of Wiring Connection		3 for Power Supply, 4 for Interunit Wiring	
Max. Interunit Piping Length	m	70 (for Total of Each Room)	
	m	25 (for One Room)	
Amount of Additional Charge	g/m	Chargeless	
Max. Installation Height Difference	m	15 (between Indoor Unit and Outdoor Unit)	
	m	7.5 (between Indoor Units)	
Drawing No.		3D052673#1	

**Note:** 1. The data are based on the conditions shown in the table below.

Cooling	Piping Length
Indoor ; 27°CDB/19°CWB Outdoor ; 35°CDB	7.5m

Conversion Formulae
kcal/h=kWx860 Btu/h=kWx3414 cfm=m <sup>3</sup> /minx35.3

Model			3MKS90EVLТ	4MKS100EVLТ
Cooling Capacity	kW		—	—
Power Consumption	W		—	—
Running Current	A		—	—
Casing Color			Ivory White	Ivory White
Compressor	Type	Hermetically Sealed Swing Type		
	Model	2YC63BXD		
	Motor Output	W	1,920	1,920
Refrigerant Oil	Model	FVC50K		
	Charge	L	0.75	0.75
Refrigerant	Type	R-410A		
	Charge	kg	3.1	3.1
Air Flow Rates	m <sup>3</sup> /min	H	54.5	54.5
		M	51.2	51.2
		L	46.0	46.0
	cfm	H	1,924	1,924
		M	1,808	1,808
		L	1,624	1,624
Fan	Type	Propeller		
	Motor Output	W	66	66
	Running Current	A	H: 0.97 / M: 0.86 / L: 0.69	H: 0.97 / M: 0.86 / L: 0.69
	Power Consumption	W	H: 86 / M: 73 / L: 55	H: 86 / M: 73 / L: 55
Starting Current	A		14.0	14.0
Dimensions (HxWxD)	mm		770x900x320	770x900x320
Packaged Dimensions (HxWxD)	mm		900x925x390	900x925x390
Weight	kg		69	69
Gross Weight	kg		78	79
Operation Sound	dBA		50	50
Piping Connection	Liquid	mm	φ 6.4x3	φ 6.4x4
	Gas	mm	φ 9.5x1, φ 12.7x1, φ 15.9x1	φ 9.5x1, φ 12.7x1, φ 15.9x2
	Drain	mm	φ 25.0	φ 25.0
Heat Insulation	Both Liquid and Gas Pipes			Both Liquid and Gas Pipes
No. of Wiring Connection	3 for Power Supply, 4 for Interunit Wiring			3 for Power Supply, 4 for Interunit Wiring
Max. Interunit Piping Length	m		70 (for Total of Each Room)	70 (for Total of Each Room)
	m		25 (for One Room)	25 (for One Room)
Amount of Additional Charge	g/m		Chargeless	Chargeless
Max. Installation Height Difference	m		15 (between Indoor Unit and Outdoor Unit)	15 (between Indoor Unit and Outdoor Unit)
	m		7.5 (between Indoor Units)	7.5 (between Indoor Units)
Drawing No.	3D052688#1			3D052684#1

**Note:** 1. The data are based on the conditions shown in the table below.

Cooling	Piping Length
Indoor ; 27°CDB/19°CWB Outdoor ; 35°CDB/24°CWB	7.5m

Conversion Formulae
kcal/h=kWx860 Btu/h=kWx3414 cfm=m <sup>3</sup> /minx35.3

50Hz 230V

Model		3MKS50DVM		4MKS71DVM		
Cooling Capacity	kW	—		—		
Power Consumption	W	—		—		
Running Current	A	—		—		
Casing Color		Ivory White		Ivory White		
Compressor	Type	Hermetically Sealed Swing Type		Hermetically Sealed Swing Type		
	Model	2YC32HXD		2YC45BXD		
	Motor Output	W	980	1,380		
Refrigerant Oil	Model	FVC50K		FVC50K		
	Charge	L	0.65	0.75		
Refrigerant	Type	R-410A		R-410A		
	Charge	kg	2.0	2.3		
Air Flow Rates	m <sup>3</sup> /min	H	44	51		
		L	37	45		
	cfm	H	1,554	1,801		
		L	1,306	1,589		
Fan	Type	Propeller		Propeller		
	Motor Output	W	53	53		
	Running Current	A	H: 0.24 / L: 0.17	H: 0.33 / L: 0.25		
	Power Consumption	W	H: 44 / L: 27	H: 68 / L: 46		
Starting Current	A	7.7		8.7		
Dimensions (HxWxD)	mm	735x936x300		735x936x300		
Packaged Dimensions (HxWxD)	mm	784x992x390		784x992x390		
Weight	kg	55		58		
Gross Weight	kg	60		64		
Operation Sound	dBA	46		48		
Sound Power	dBA	59		61		
Piping Connection	Liquid	mm	φ 6.4×3		φ 6.4×4	
	Gas	mm	φ 9.5×3		φ 9.5×2, φ 12.7×1, φ 15.9×1	
	Drain	mm	φ 18.0		φ 18.0	
Heat Insulation		Both Liquid and Gas Pipes		Both Liquid and Gas Pipes		
No. of Wiring Connection		3 for Power Supply, 4 for Interunit Wiring		3 for Power Supply, 4 for Interunit Wiring		
Max. Interunit Piping Length	m	45 (for Total of Each Room)		60 (for Total of Each Room)		
	m	25 (for One Room)		25 (for One Room)		
Amount of Additional Charge	g/m	Chargeless		Chargeless		
Max. Installation Height Difference	m	15 (between Indoor Unit and Outdoor Unit)		15 (between Indoor Unit and Outdoor Unit)		
	m	15 (between Indoor Units)		15 (between Indoor Units)		
Drawing No.		3D050092#1A		3D050093#1A		

**Note:** 1. The data are based on the conditions shown in the table below.

Cooling	Piping Length
Indoor ; 27°CDB/19°CWB Outdoor ; 35°CDB	7.5m

Conversion Formulae
kcal/h=kW×860 Btu/h=kW×3414 cfm=m <sup>3</sup> /min×35.3



Model		3MKS50ESG		3MKS71ESG	
Cooling Capacity	kW	—		—	
Power Consumption	W	—		—	
Running Current	A	—		—	
Casing Color		Ivory White		Ivory White	
Compressor	Type	Hermetically Sealed Swing Type		Hermetically Sealed Swing Type	
	Model	2YC36BXD		2YC45BXD	
	Motor Output	W	1,100	1,380	
Refrigerant Oil	Model	FVC50K		FVC50K	
	Charge	L	0.65	0.75	
Refrigerant	Type	R-410A		R-410A	
	Charge	kg	2.0	2.3	
Air Flow Rates	m <sup>3</sup> /min	H	45	51	
		L	—	45	
	cfm	H	1,589	1,801	
		L	—	1,589	
Fan	Type	Propeller		Propeller	
	Motor Output	W	53	53	
	Running Current	A	0.33	H: 0.33 / L: 0.25	
	Power Consumption	W	43	H: 68 / L: 46	
Starting Current	A	5.1		8.4	
Dimensions (HxWxD)	mm	735x936x300		735x936x300	
Packaged Dimensions (HxWxD)	mm	792x992x390		792x992x390	
Weight	kg	49		58	
Gross Weight	kg	56		64	
Operation Sound	dBA	46		48	
Sound Power	dBA	59		61	
Piping Connection	Liquid	mm	φ 6.4x3	φ 6.4x3	
	Gas	mm	φ 9.5x3	φ12.7x2, φ15.9x1	
	Drain	mm	φ18.0	φ18.0	
Heat Insulation		Both Liquid and Gas Pipes		Both Liquid and Gas Pipes	
No. of Wiring Connection		3 for Power Supply, 4 for Interunit Wiring		3 for Power Supply, 4 for Interunit Wiring	
Max. Interunit Piping Length	m	50 (for Total of Each Room)		60 (for Total of Each Room)	
	m	25 (for One Room)		25 (for One Room)	
Amount of Additional Charge	g/m	Chargeless		Chargeless	
Max. Installation Height Difference	m	15 (between Indoor Unit and Outdoor Unit)		15 (between Indoor Unit and Outdoor Unit)	
	m	15 (between Indoor Units)		15 (between Indoor Units)	
Drawing No.		C : 3D055038		3D055082	

**Note:** 1. The data are based on the conditions shown in the table below.

Cooling	Piping Length
Indoor ; 27°CDB/19°CWB Outdoor ; 35°CDB	7.5m

Conversion Formulae
kcal/h=kWx860 Btu/h=kWx3414 cfm=m <sup>3</sup> /minx35.3

50Hz 230V

Model		4MKS80ESG	
Cooling Capacity	kW	—	
Power Consumption	W	—	
Running Current	A	—	
Casing Color	Ivory White		
Compressor	Type	Hermetically Sealed Swing Type	
	Model	2YC63BXD#D	
	Motor Output	W	1,920
Refrigerant Oil	Model	FVC50K	
	Charge	L	0.75
Refrigerant	Type	R-410A	
	Charge	kg	3.1
Air Flow Rates	m <sup>3</sup> /min	H	54.5
		L	46.0
	cfm	H	1,924
		L	1,624
Fan	Type	Propeller	
	Motor Output	W	66
	Running Current	A	H: 0.97 / L: 0.69
	Power Consumption	W	H: 86 / L: 55
Starting Current	A	10.2	
Dimensions (HxWxD)	mm	770x900x320	
Packaged Dimensions (HxWxD)	mm	900x925x390	
Weight	kg	69	
Gross Weight	kg	79	
Operation Sound	dBA	48	
Sound Power	dBA	61	
Piping Connection	Liquid	mm	φ 6.4x4
	Gas	mm	φ 9.5x1, φ12.7x1, φ15.9x2
	Drain	mm	φ25
Heat Insulation	Both Liquid and Gas Pipes		
No. of Wiring Connection	3 for Power Supply, 4 for Interunit Wiring		
Max. Interunit Piping Length	m	70 (for Total of Each Room)	
	m	25 (for One Room)	
Amount of Additional Charge	g/m	Chargeless	
Max. Installation Height Difference	m	15 (between Indoor Unit and Outdoor Unit)	
	m	7.5 (between Indoor Units)	
Drawing No.	3D052629#1		

**Note:** 1. The data are based on the conditions shown in the table below.

Cooling	Piping Length
Indoor ; 27°CDB/19°CWB Outdoor ; 35°CDB	7.5m

Conversion Formulae
kcal/h=kWx860 Btu/h=kWx3414 cfm=m <sup>3</sup> /minx35.3

# 1.3 Indoor Units - Heat Pump

## Wall Mounted Type

50Hz 220-230-240V / 60Hz 220-230V

Model			FTXS20DVMA		FTXS25EVMA	
			Cooling	Heating	Cooling	Heating
Rated Capacity			2.0kW Class		2.5kW Class	
Front Panel Color			White			
Air Flow Rates	m <sup>3</sup> /min (cfm)	H	8.7 (307)	9.4 (332)	8.7 (307)	9.4 (332)
		M	6.7 (237)	7.6 (268)	6.7 (237)	7.6 (268)
		L	4.7 (166)	5.8 (205)	4.7 (166)	5.8 (205)
		SL	3.9 (138)	5.0 (177)	3.9 (138)	5.0 (177)
Fan	Type	Cross Flow Fan				
	Motor Output	W	40			
	Speed	Steps	5 Steps, Quiet, Auto			
Air Direction Control			Right, Left, Horizontal, Downward		Right, Left, Horizontal, Downward	
Air Filter			Removable-Washable-Mildew Proof			
Running Current (Rated)		A	0.17-0.16-0.15/0.17-0.16	0.17-0.16-0.15/0.17-0.16	0.17-0.16-0.15/0.17-0.16	0.17-0.16-0.15/0.17-0.16
Power Consumption (Rated)		W	35	35	35	35
Power Factor		%	93.6-95.1-97.2/93.6-95.1	93.6-95.1-97.2/93.6-95.1	93.6-95.1-97.2/93.6-95.1	93.6-95.1-97.2/93.6-95.1
Temperature Control			Microcomputer Control			
Dimensions (HxWxD)		mm	283x800x195		283x800x195	
Packaged Dimensions (HxWxD)		mm	265x855x340		265x855x340	
Weight		kg	9			
Gross Weight		kg	12			
Operation Sound	H/M/L/SL	dBA	37/—/25/22	37/—/28/25	37/31/25/22	37/33/28/25
Sound Power	H	dBA	—	—	—	62
Heat Insulation			Both Liquid and Gas Pipes			
Piping Connection	Liquid	mm	φ 6.4		φ 6.4	
	Gas	mm	φ 9.5		φ 9.5	
	Drain	mm	φ18.0		φ18.0	
Drawing No.			3D049290		3D054406A	

Model			FTXS35EVMA		FTXS50FVMA	
			Cooling	Heating	Cooling	Heating
Rated Capacity			3.5kW Class		5.0kW Class	
Front Panel Color			White			
Air Flow Rates	m <sup>3</sup> /min (cfm)	H	8.9 (314)	9.7 (342)	14.7 (519)	16.2 (572)
		M	6.9 (242)	7.9 (277)	12.6 (445)	13.8 (487)
		L	4.8 (169)	6.0 (212)	10.2 (360)	11.5 (406)
		SL	4.0 (141)	5.2 (184)	9.2 (325)	10.2 (360)
Fan	Type	Cross Flow Fan				
	Motor Output	W	40			
	Speed	Steps	5 Steps, Quiet, Auto			
Air Direction Control			Right, Left, Horizontal, Downward		Right, Left, Horizontal, Downward	
Air Filter			Removable-Washable-Mildew Proof			
Running Current (Rated)		A	0.19-0.18-0.17/0.19-0.18	0.19-0.18-0.17/0.19-0.18	0.16-0.15-0.15/0.16-0.15	0.17-0.16-0.16/0.17-0.16
Power Consumption (Rated)		W	40	40	34	36
Power Factor		%	95.7-96.6-98.0/95.7-96.6	95.7-96.6-98.0/95.7-96.6	96.6-98.6-94.4/96.6-98.6	96.3-97.8-93.8/96.3-97.8
Temperature Control			Microcomputer Control			
Dimensions (HxWxD)		mm	283x800x195		290x1,050x238	
Packaged Dimensions (HxWxD)		mm	265x855x340		337x1,147x366	
Weight		kg	9			
Gross Weight		kg	12			
Operation Sound	H/M/L/SL	dBA	38/32/26/23	38/34/29/26	44/40/35/32	42/38/33/30
Sound Power	H	dBA	—	—	60	58
Heat Insulation			Both Liquid and Gas Pipes			
Piping Connection	Liquid	mm	φ 6.4		φ 6.4	
	Gas	mm	φ 9.5		φ12.7	
	Drain	mm	φ18.0		φ18.0	
Drawing No.			3D054407A		3D054879	

Conversion Formulae
kcal/h=kWx860
Btu/h=kWx3414
cfm=m <sup>3</sup> /minx35.3

## 50Hz 220-230-240V / 60Hz 220-230V

Model			FTXS60FVMA				FTXS71FVMA			
			Cooling		Heating		Cooling		Heating	
Rated Capacity			6.0kW Class				7.1kW Class			
Front Panel Color			White				White			
Air Flow Rates	m <sup>3</sup> /min (cfm)	H	16.2 (572)		17.4 (614)		17.4 (614)		21.5 (759)	
		M	13.9 (491)		15.3 (540)		14.6 (516)		18.0 (636)	
		L	11.5 (406)		12.8 (452)		11.9 (420)		14.4 (508)	
		SL	10.0 (353)		10.5 (371)		11.2 (395)		13.3 (470)	
Fan	Type	Cross Flow Fan				Cross Flow Fan				
	Motor Output	W	43		43		43		43	
	Speed	Steps	5 Steps, Quiet, Auto		5 Steps, Quiet, Auto		5 Steps, Quiet, Auto		5 Steps, Quiet, Auto	
Air Direction Control			Right, Left, Horizontal, Downward				Right, Left, Horizontal, Downward			
Air Filter			Removable-Washable-Mildew Proof				Removable-Washable-Mildew Proof			
Running Current (Rated)		A	0.19-0.18-0.17/0.19-0.18		0.21-0.20-0.19/0.21-0.20		0.21-0.20-0.19/0.21-0.20		0.28-0.27-0.26/0.28-0.27	
Power Consumption (Rated)		W	40		45		45		60	
Power Factor		%	95.7-96.6-98.0/95.7-96.6		97.4-97.8-98.7/97.4-97.8		97.4-97.8-98.7/97.4-97.8		97.4-96.6-96.2/97.4-96.6	
Temperature Control			Microcomputer Control				Microcomputer Control			
Dimensions (HxWxD)		mm	290x1,050x238				290x1,050x238			
Packaged Dimensions (HxWxD)		mm	337x1,147x366				337x1,147x366			
Weight		kg	12				12			
Gross Weight		kg	17				17			
Operation Sound	H/M/L/SL	dBA	45/41/36/33		44/40/35/32		46/42/37/34		46/42/37/34	
Sound Power	H	dBA	61		60		62		62	
Heat Insulation			Both Liquid and Gas Pipes				Both Liquid and Gas Pipes			
Piping Connection	Liquid	mm	φ 6.4		φ 6.4		φ 6.4		φ 6.4	
	Gas	mm	φ12.7		φ12.7		φ15.9		φ15.9	
	Drain	mm	φ18.0		φ18.0		φ18.0		φ18.0	
Drawing No.			3D054880				3D054881A			

## 60Hz 220V

Model			FTXS20DVMT				FTXS25DVMT			
			Cooling		Heating		Cooling		Heating	
Capacity			2.0kW Class				2.5kW Class			
Front Panel Color			White				White			
Air Flow Rates	m <sup>3</sup> /min (cfm)	H	8.7 (307)		9.4 (332)		8.7 (307)		9.4 (332)	
		M	6.7 (237)		7.6 (268)		6.7 (237)		7.6 (268)	
		L	4.7 (166)		5.8 (205)		4.7 (166)		5.8 (205)	
		SL	3.9 (138)		5.0 (177)		3.9 (138)		5.0 (177)	
Fan	Type	Cross Flow Fan				Cross Flow Fan				
	Motor Output	W	40		40		40		40	
	Speed	Steps	5 Steps, Quiet, Auto		5 Steps, Quiet, Auto		5 Steps, Quiet, Auto		5 Steps, Quiet, Auto	
Air Direction Control			Right, Left, Horizontal, Downward				Right, Left, Horizontal, Downward			
Air Filter			Removable / Washable / Mildew Proof				Removable / Washable / Mildew Proof			
Running Current		A	0.17		0.17		0.17		0.17	
Power Consumption		W	35		35		35		35	
Power Factor		%	93.6		93.6		93.6		93.6	
Temperature Control			Microcomputer Control				Microcomputer Control			
Dimensions (HxWxD)		mm	283x800x195				283x800x195			
Packaged Dimensions (HxWxD)		mm	265x855x340				265x855x340			
Weight		kg	9				9			
Gross Weight		kg	12				12			
Operation Sound	H/L/SL	dBA	38/25/22		38/28/25		38/25/22		38/28/25	
Heat Insulation			Both Liquid and Gas Pipes				Both Liquid and Gas Pipes			
Piping Connection	Liquid	mm	φ 6.4		φ 6.4		φ 6.4		φ 6.4	
	Gas	mm	φ 9.5		φ 9.5		φ 9.5		φ 9.5	
	Drain	mm	φ18.0		φ18.0		φ18.0		φ18.0	
Drawing No.			3D049891A				3D049892A			

## Conversion Formulae

$\text{kcal/h} = \text{kW} \times 860$   
 $\text{Btu/h} = \text{kW} \times 3414$   
 $\text{cfm} = \text{m}^3/\text{min} \times 35.3$

Model			FTXS35DVMT				FTXS50DVMT			
			Cooling		Heating		Cooling		Heating	
Capacity			3.5kW Class				5.0kW Class			
Front Panel Color			White				White			
Air Flow Rates	m <sup>3</sup> /min (cfm)	H	8.9 (314)	9.7 (342)	11.4 (402)	12.6 (445)				
		M	6.9 (244)	7.9 (279)	9.7 (342)	10.8 (381)				
		L	4.8 (169)	6.0 (212)	8.0 (282)	8.9 (314)				
		SL	4.0 (141)	5.2 (184)	7.1 (251)	7.7 (272)				
Fan	Type	Cross Flow Fan				Cross Flow Fan				
	Motor Output	W	40				40			
	Speed	Steps	5 Steps, Silent, Auto				5 Steps, Silent, Auto			
Air Direction Control			Right, Left, Horizontal, Downward				Right, Left, Horizontal, Downward			
Air Filter			Removable / Washable / Mildew Proof				Removable / Washable / Mildew Proof			
Running Current	A	0.19	0.19	0.19	0.19					
Power Consumption	W	40	40	40	40					
Power Factor	%	95.7	95.7	95.7	95.7					
Temperature Control			Microcomputer Control				Microcomputer Control			
Dimensions (HxWxD)	mm	283x800x195				290x795x238				
Packaged Dimensions (HxWxD)	mm	265x855x340				280x840x338				
Weight	kg	9				9				
Gross Weight	kg	12				13				
Operation Sound	H/M/L/SL	dBA	39/—/26/23	39/—/29/26	44/40/35/32	42/38/33/30				
Heat Insulation			Both Liquid and Gas Pipes				Both Liquid and Gas Pipes			
Piping Connection	Liquid	mm	φ 6.4				φ 6.4			
	Gas	mm	φ 9.5				φ12.7			
	Drain	mm	φ18.0				φ18.0			
Drawing No.			3D049893A				3D049983			

Model			FTXS60DVMT				FTXS71DVMT			
			Cooling		Heating		Cooling		Heating	
Capacity			6.0kW Class				7.1kW Class			
Front Panel Color			White				White			
Air Flow Rates	m <sup>3</sup> /min (cfm)	H	16.2 (572)	17.4 (614)	16.7 (590)	18.5 (653)				
		M	13.6 (480)	15.1 (533)	14.2 (501)	15.1 (533)				
		L	11.4 (402)	12.7 (448)	11.6 (409)	13.5 (477)				
		SL	10.2 (360)	11.4 (402)	10.6 (374)	12.1 (427)				
Fan	Type	Cross Flow Fan				Cross Flow Fan				
	Motor Output	W	43				43			
	Speed	Steps	5 Steps, Silent, Auto				5 Steps, Silent, Auto			
Air Direction Control			Right, Left, Horizontal, Downward				Right, Left, Horizontal, Downward			
Air Filter			Removable / Washable / Mildew Proof				Removable / Washable / Mildew Proof			
Running Current	A	0.21	0.21	0.23	0.23					
Power Consumption	W	45	45	50	50					
Power Factor	%	97.4	97.4	98.8	98.8					
Temperature Control			Microcomputer Control				Microcomputer Control			
Dimensions (HxWxD)	mm	290x1,050x238				290x1,050x238				
Packaged Dimensions (HxWxD)	mm	337x1,147x366				337x1,147x366				
Weight	kg	12				12				
Gross Weight	kg	17				17				
Operation Sound	H/M/L/SL	dBA	45/41/36/33	44/40/35/32	46/42/37/34	46/42/37/34				
Heat Insulation			Both Liquid and Gas Pipes				Both Liquid and Gas Pipes			
Piping Connection	Liquid	mm	φ 6.4				φ 6.4			
	Gas	mm	φ12.7				φ15.9			
	Drain	mm	φ18.0				φ18.0			
Drawing No.			3D049984				3D049985			

Conversion Formulae
kcal/h=kWx860
Btu/h=kWx3414
cfm=m <sup>3</sup> /minx35.3

60Hz 220V

Model			FTXS50FVLT		FTXS60FVLT	
			Cooling	Heating	Cooling	Heating
Capacity			5.0kW Class		6.0kW Class	
Front Panel Color			White		White	
Air Flow Rates	m <sup>3</sup> /min (cfm)	H	14.7 (519)	16.1 (569)	16.2 (572)	17.4 (614)
		M	12.4 (438)	13.9 (491)	13.6 (480)	15.1 (533)
		L	10.3 (364)	11.5 (406)	11.4 (403)	12.7 (448)
		SL	9.5 (335)	10.2 (360)	10.2 (360)	11.4 (403)
Fan	Type	Cross Flow Fan		Cross Flow Fan		
	Motor Output	W	43		43	
	Speed	Steps	5 Steps, Quiet, Auto		5 Steps, Quiet, Auto	
Air Direction Control			Right, Left, Horizontal, Downward		Right, Left, Horizontal, Downward	
Air Filter			Removable / Washable / Mildew Proof		Removable / Washable / Mildew Proof	
Running Current	A	0.16	0.17	0.19	0.21	
Power Consumption	W	34	36	40	45	
Power Factor	%	96.6	96.3	95.7	97.4	
Temperature Control			Microcomputer Control		Microcomputer Control	
Dimensions (HxWxD)	mm	290x1,050x238		290x1,050x238		
Packaged Dimensions (HxWxD)	mm	337x1,147x366		337x1,147x366		
Weight	kg	12		12		
Gross Weight	kg	17		17		
Operation Sound	H/M/L/SL	dBA	43/39/34/31	42/38/33/30	45/41/36/33	44/40/35/32
Heat Insulation			Both Liquid and Gas Pipes		Both Liquid and Gas Pipes	
Piping Connection	Liquid	mm	φ 6.4		φ 6.4	
	Gas	mm	φ12.7		φ12.7	
	Drain	mm	φ18.0		φ18.0	
Drawing No.			3D056231		3D056232	

Model			FTXS71FVLT	
			Cooling	Heating
Capacity			7.1kW Class	
Front Panel Color			White	
Air Flow Rates	m <sup>3</sup> /min (cfm)	H	17.4 (614)	19.7 (696)
		M	14.6 (516)	16.6 (586)
		L	11.6 (410)	13.5 (477)
		SL	10.6 (374)	12.1 (427)
Fan	Type	Cross Flow Fan		
	Motor Output	W	43	
	Speed	Steps	5 Steps, Quiet, Auto	
Air Direction Control			Right, Left, Horizontal, Downward	
Air Filter			Removable / Washable / Mildew Proof	
Running Current	A	0.21	0.23	
Power Consumption	W	45	50	
Power Factor	%	97.4	98.8	
Temperature Control			Microcomputer Control	
Dimensions (HxWxD)	mm	290x1,050x238		
Packaged Dimensions (HxWxD)	mm	337x1,147x366		
Weight	kg	12		
Gross Weight	kg	17		
Operation Sound	H/M/L/SL	dBA	46/42/37/34	46/42/37/34
Heat Insulation			Both Liquid and Gas Pipes	
Piping Connection	Liquid	mm	φ 6.4	
	Gas	mm	φ15.9	
	Drain	mm	φ18.0	
Drawing No.			3D056233	

## Conversion Formulae

kcal/h=kWx860  
 Btu/h=kWx3414  
 cfm=m<sup>3</sup>/minx35.3

Duct Connected Type

50Hz 220-230-240V / 60Hz 220-230V

Model			FDXS25CVMA		FDXS35CVMA	
			Cooling	Heating	Cooling	Heating
Rated Capacity			2.5kW Class		3.5kW Class	
Front Panel Color			—		—	
Air Flow Rates	m <sup>3</sup> /min (cfm)	H	9.5 (335)	9.5 (335)	10.0 (353)	10.0 (353)
		M	8.8 (311)	8.8 (311)	9.3 (328)	9.3 (328)
		L	8.0 (282)	8.0 (282)	8.5 (300)	8.5 (300)
		SL	6.7 (237)	6.7 (237)	7.0 (247)	7.0 (247)
Fan	Type	Sirocco Fan		Sirocco Fan		
	Motor Output	W	62		62	
	Speed	Steps	5 Steps, Quiet, Auto		5 Steps, Quiet, Auto	
Air Filter			Removable-Washable-Mildew Proof		Removable-Washable-Mildew Proof	
Running Current (Rated)		A	0.49-0.47-0.45/0.49-0.47	0.49-0.47-0.45/0.49-0.47	0.49-0.47-0.45/0.49-0.47	0.49-0.47-0.45/0.49-0.47
Power Consumption (Rated)		W	100		100	
Power Factor		%	92.8-92.5-92.6/92.8-92.5		92.8-92.5-92.6/92.8-92.5	
Temperature Control			Microcomputer Control		Microcomputer Control	
Dimensions (HxWxD)		mm	200x900x620		200x900x620	
Packaged Dimensions (HxWxD)		mm	266x1,106x751		266x1,106x751	
Weight		kg	25		25	
Gross Weight		kg	31		31	
Operation Sound	H/M/L/SL	dBA	35/33/31/29	35/33/31/29	35/33/31/29	35/33/31/29
External Static Pressure		Pa	40		40	
Moisture Removal		L/h	1.2	—	1.9	—
Heat Insulation			Both Liquid and Gas Pipes		Both Liquid and Gas Pipes	
Piping Connection	Liquid	mm	φ 6.4		φ 6.4	
	Gas	mm	φ 9.5		φ 9.5	
	Drain	mm	VP20 (O.D φ 26 / I.D φ 20)		VP20 (O.D φ 26 / I.D φ 20)	
Drawing No.			3D055393B		3D055394B	

Model			FDXS50CVMA		FDXS60CVMA	
			Cooling	Heating	Cooling	Heating
Rated Capacity			5.0kW Class		6.0kW Class	
Front Panel Color			—		—	
Air Flow Rates	m <sup>3</sup> /min (cfm)	H	12.0 (424)	12.0 (424)	16.0 (565)	16.0 (565)
		M	11.0 (388)	11.0 (388)	14.8 (523)	14.8 (523)
		L	10.0 (353)	10.0 (353)	13.5 (477)	13.5 (477)
		SL	8.4 (297)	8.4 (297)	11.2 (395)	11.2 (395)
Fan	Type	Sirocco Fan		Sirocco Fan		
	Motor Output	W	130		130	
	Speed	Steps	5 Steps, Quiet, Auto		5 Steps, Quiet, Auto	
Air Filter			Removable-Washable-Mildew Proof		Removable-Washable-Mildew Proof	
Running Current (Rated)		A	0.69-0.66-0.63/0.69-0.66	0.69-0.66-0.63/0.69-0.66	0.80-0.77-0.74/0.80-0.77	0.78-0.75-0.72/0.78-0.75
Power Consumption (Rated)		W	140		160	
Power Factor		%	92.2-92.2-92.6/92.2-92.2		90.9-90.3-90.1/90.9-90.3	
Temperature Control			Microcomputer Control		Microcomputer Control	
Dimensions (HxWxD)		mm	200x900x620		200x1,100x620	
Packaged Dimensions (HxWxD)		mm	266x1,106x751		266x1,306x751	
Weight		kg	27		30	
Gross Weight		kg	34		37	
Operation Sound	H/M/L/SL	dBA	37/35/33/31	37/35/33/31	38/36/34/32	38/36/34/32
Sound Power	H	dBA	55	55	56	56
External Static Pressure		Pa	40		40	
Moisture Removal		L/h	—		—	
Heat Insulation			Both Liquid and Gas Pipes		Both Liquid and Gas Pipes	
Piping Connection	Liquid	mm	φ 6.4		φ 6.4	
	Gas	mm	φ12.7		φ12.7	
	Drain	mm	VP20 (O.D φ 26 / I.D φ 20)		VP20 (O.D φ 26 / I.D φ 20)	
Drawing No.			3D054916A		3D054917A	

**Note:** 1. The operating sound is based on the rear side suction inlet and the external static pressure 40 Pa. Operating sound for under side suction inlet: [operating sound for rear side suction inlet] +5 dB. However, when installation to which the external static pressure becomes low is carried out, 5 dB or more may go up.

Conversion Formulae
kcal/h=kWx860
Btu/h=kWx3414
cfm=m <sup>3</sup> /minx35.3

60Hz 220V

Model			CDXS25DVMT		CDXS35DVMT	
			Cooling	Heating	Cooling	Heating
Capacity			2.5kW Class		3.5kW Class	
Front Panel Color			—		—	
Air Flow Rates		m <sup>3</sup> /min (cfm)	H	9.5 (335)	10.0 (353)	
			M	8.8 (311)	9.3 (328)	
			L	8.0 (282)	8.5 (300)	
			SL	6.7 (237)	7.0 (247)	
Fan	Type	Sirocco Fan		Sirocco Fan		
	Motor Output	W	62	62		
	Speed	Steps	5 Steps, Quiet, Auto	5 Steps, Quiet, Auto		
Air Filter			Removable / Washable / Mildew Proof		Removable / Washable / Mildew Proof	
Running Current (Rated)			A	0.47	0.47	
Power Consumption (Rated)			W	100	100	
Power Factor			%	92.5	92.5	
Temperature Control			Microcomputer Control		Microcomputer Control	
Dimensions (HxWxD)		mm	200x900x620		200x900x620	
Packaged Dimensions (HxWxD)		mm	266x1,106x751		266x1,106x751	
Weight		kg	25		25	
Operation Sound	H/M/L/SL	dBA	35/33/31/29		35/33/31/29	
External Static Pressure		Pa	40		40	
Moisture Removal		l/h	1.2		1.9	
Heat Insulation			Both Liquid and Gas Pipes		Both Liquid and Gas Pipes	
Piping Connection		Liquid	mm	φ 6.4	φ 6.4	
		Gas	mm	φ 9.5	φ 9.5	
		Drain	mm	VP20 (O.D.φ 26 / I.D.φ 20)	VP20 (O.D.φ 26 / I.D.φ 20)	
Drawing No.			3D049727		3D049728	

Model			CDXS50DVMT		CDXS60DVMT	
			Cooling	Heating	Cooling	Heating
Capacity			5.0kW Class		6.0kW Class	
Front Panel Color			—		—	
Air Flow Rates		m <sup>3</sup> /min (cfm)	H	12.0 (424)	16.0 (565)	
			M	11.0 (388)	14.8 (523)	
			L	10.0 (353)	13.5 (477)	
			SL	8.4 (297)	11.2 (395)	
Fan	Type	Sirocco Fan		Sirocco Fan		
	Motor Output	W	130	130		
	Speed	Steps	5 Steps, Quiet, Auto	5 Steps, Quiet, Auto		
Air Filter			Removable / Washable / Mildew Proof		Removable / Washable / Mildew Proof	
Running Current (Rated)			A	0.64	0.74	
Power Consumption (Rated)			W	140	160	
Power Factor			%	95.1	94.0	
Temperature Control			Microcomputer Control		Microcomputer Control	
Dimensions (HxWxD)		mm	200x900x620		200x1,100x620	
Packaged Dimensions (HxWxD)		mm	266x1,106x751		266x1,306x751	
Weight		kg	27		30	
Operation Sound	H/M/L/SL	dBA	37/35/33/31		38/36/34/32	
External Static Pressure		Pa	40		40	
Moisture Removal		l/h	2.9		3.9	
Heat Insulation			Both Liquid and Gas Pipes		Both Liquid and Gas Pipes	
Piping Connection		Liquid	mm	φ 6.4	φ 6.4	
		Gas	mm	φ12.7	φ12.7	
		Drain	mm	VP20 (O.D.φ 26 / I.D.φ 20)	VP20 (O.D.φ 26 / I.D.φ 20)	
Drawing No.			3D049729		3D049730	

- Note:**
- The operating sound is based on the rear side suction inlet and the external static pressure 40 Pa. Operating sound for under side suction inlet: [operating sound for rear side suction inlet] +5 dB. However, when installation to which the external static pressure becomes low is carried out, 5 dB or more may go up.

## Conversion Formulae

$kcal/h = kW \times 860$   
 $Btu/h = kW \times 3414$   
 $cfm = m^3/min \times 35.3$



50Hz 220-230-240V / 60Hz 220-230V

Model			CDXS25EAVMA				CDXS35EAVMA				
			Cooling		Heating		Cooling		Heating		
Rated Capacity			2.5kW Class				3.5kW Class				
Front Panel Color			—				—				
Air Flow Rates		m <sup>3</sup> /min (cfm)	H	8.7 (307)	8.7 (307)	8.7 (307)	8.7 (307)				
			M	8.0 (282)	8.0 (282)	8.0 (282)	8.0 (282)				
			L	7.3 (258)	7.3 (258)	7.3 (258)	7.3 (258)				
			SL	6.2 (219)	6.2 (219)	6.2 (219)	6.2 (219)				
Fan	Type	Sirocco Fan				Sirocco Fan					
	Motor Output	W	62				62				
	Speed	Steps	5 Steps, Quiet, Auto				5 Steps, Quiet, Auto				
Air Filter			—				Removable-Washable-Mildew Proof				
Running Current (Rated)			A	0.47-0.48-0.49/0.52-0.53	0.47-0.48-0.49/0.52-0.53	0.47-0.48-0.49/0.52-0.53	0.47-0.48-0.49/0.52-0.53				
Power Consumption (Rated)			W	70-71-72/72-73	70-71-72/72-73	70-71-72/72-73	70-71-72/72-73				
Power Factor			%	67.7-64.3-61.2/62.9-59.9	67.7-64.3-61.2/62.9-59.9	67.7-64.3-61.2/62.9-59.9	67.7-64.3-61.2/62.9-59.9				
Temperature Control			Microcomputer Control				Microcomputer Control				
Dimensions (HxWxD)			mm	200x700x620				200x700x620			
Packaged Dimensions (HxWxD)			mm	274x906x751				274x906x751			
Weight			kg	21				21			
Gross Weight			kg	29				29			
Operation Sound	H/M/L/SL	dBA	35/33/31/29	35/33/31/29	35/33/31/29	35/33/31/29					
External Static Pressure			Pa	30				30			
Moisture Removal			L/h	1.2	—	1.9	—				
Heat Insulation			Both Liquid and Gas Pipes				Both Liquid and Gas Pipes				
Piping Connection		Liquid	mm	φ 6.4				φ 6.4			
		Gas	mm	φ 9.5				φ 9.5			
		Drain	mm	VP20 (O.D.φ 26 / I.D.φ 20)				VP20 (O.D.φ 26 / I.D.φ 20)			
Drawing No.			3D051140				3D051141				

60Hz 220V

Model			CDXS25EAVMT				CDXS35EAVMT				
			Cooling		Heating		Cooling		Heating		
Capacity			2.5kW Class				3.5kW Class				
Front Panel Color			—				—				
Air Flow Rates		m <sup>3</sup> /min (cfm)	H	8.7 (307)	8.7 (307)	8.7 (307)	8.7 (307)				
			M	8.0 (282)	8.0 (282)	8.0 (282)	8.0 (282)				
			L	7.3 (258)	7.3 (258)	7.3 (258)	7.3 (258)				
			SL	6.2 (219)	6.2 (219)	6.2 (219)	6.2 (219)				
Fan	Type	Sirocco Fan				Sirocco Fan					
	Motor Output	W	62				62				
	Speed	Steps	5 Steps, Quiet, Auto				5 Steps, Quiet, Auto				
Air Filter			Removable / Washable / Mildew Proof				Removable / Washable / Mildew Proof				
Running Current (Rated)			A	0.52				0.52			
Power Consumption (Rated)			W	72				72			
Power Factor			%	62.9				62.9			
Temperature Control			Microcomputer Control				Microcomputer Control				
Dimensions (HxWxD)			mm	200x700x620				200x700x620			
Packaged Dimensions (HxWxD)			mm	274x906x751				274x906x751			
Weight			kg	21				21			
Gross Weight			kg	29				29			
Operation Sound	H/M/L/SL	dBA	35/33/31/29	35/33/31/29	35/33/31/29	35/33/31/29					
External Static Pressure			Pa	30				30			
Moisture Removal			l/h	1.2				1.9			
Heat Insulation			Both Liquid and Gas Pipes				Both Liquid and Gas Pipes				
Piping Connection		Liquid	mm	φ 6.4				φ 6.4			
		Gas	mm	φ 9.5				φ 9.5			
		Drain	mm	VP20(O.D.φ 26/I.D.φ 20)				VP20(O.D.φ 26/I.D.φ 20)			
Drawing No.			3D052113				3D052114				

**Note:** 1. The operating sound is based on the rear side suction inlet and the external static pressure 30 Pa. Operating sound for under side suction inlet: [operating sound for rear side suction inlet] +6 dB. However, when installation to which the external static pressure becomes low is carried out, 6 dB or more may go up.

Conversion Formulae
kcal/h=kWx860
Btu/h=kWx3414
cfm=m <sup>3</sup> /minx35.3

## Floor / Ceiling Suspended Dual Type

50Hz 230V

Model			FLXS25BVMA		FLXS35BVMA	
			Cooling	Heating	Cooling	Heating
Rated Capacity			2.5kW Class		3.5kW Class	
Front Panel Color			Almond White		Almond White	
Air Flow Rates	m <sup>3</sup> /min (cfm)	H	7.6 (268)	9.2 (325)	8.6 (304)	9.8 (346)
		M	6.8 (240)	8.3 (293)	7.6 (268)	8.9 (314)
		L	6.0 (212)	7.4 (261)	6.6 (233)	8.0 (282)
		SL	5.2 (184)	6.6 (233)	5.6 (198)	7.2 (254)
Fan	Type	Sirocco Fan		Sirocco Fan		
	Motor Output	W	34		34	
	Speed	Steps	5 Steps, Quiet, Auto		5 Steps, Quiet, Auto	
Air Direction Control			Right, Left, Horizontal, Downward		Right, Left, Horizontal, Downward	
Air Filter			Removable-Washable-Mildew Proof		Removable-Washable-Mildew Proof	
Running Current (Rated)	A	0.32	0.34	0.36	0.36	
Power Consumption (Rated)	W	70	74	78	78	
Power Factor	%	95.1	94.6	94.2	94.2	
Temperature Control			Microcomputer Control		Microcomputer Control	
Dimensions (HxWxD)	mm	490x1,050x200		490x1,050x200		
Packaged Dimensions (HxWxD)	mm	280x1,100x566		280x1,100x566		
Weight	kg	16		16		
Gross Weight	kg	22		22		
Operation Sound	H/M/L/SL	dBA	37/34/31/28	37/34/31/29	38/35/32/29	39/36/33/30
Heat Insulation			Both Liquid and Gas Pipes		Both Liquid and Gas Pipes	
Piping Connection	Liquid	mm	φ 6.4		φ 6.4	
	Gas	mm	φ 9.5		φ 9.5	
	Drain	mm	φ18.0		φ18.0	
Drawing No.			3D046600		3D046601	

50Hz 220-230-240V / 60Hz 220-230V

Model			FLXS50BVMA		FLXS60BVMA	
			Cooling	Heating	Cooling	Heating
Rated Capacity			5.0kW Class		5.7kW Class	
Front Panel Color			Almond White		Almond White	
Air Flow Rates	m <sup>3</sup> /min (cfm)	H	11.4 (403)	12.1 (427)	12.0 (424)	12.8 (452)
		M	10.0 (353)	9.8 (346)	10.7 (378)	10.6 (374)
		L	8.5 (300)	7.5 (265)	9.3 (328)	8.4 (297)
		SL	7.5 (265)	6.8 (240)	8.3 (293)	7.5 (265)
Fan	Type	Sirocco Fan		Sirocco Fan		
	Motor Output	W	34		34	
	Speed	Steps	5 Steps, Quiet, Auto		5 Steps, Quiet, Auto	
Air Direction Control			Right, Left, Horizontal, Downward		Right, Left, Horizontal, Downward	
Air Filter			Removable-Washable-Mildew Proof		Removable-Washable-Mildew Proof	
Running Current (Rated)	A	0.47-0.45-0.43/0.47-0.45	0.47-0.45-0.43/0.47-0.45	0.49-0.47-0.45/0.49-0.47	0.47-0.45-0.43/0.47-0.45	
Power Consumption (Rated)	W	96	96	98	96	
Power Factor	%	92.8-92.8-93.0/92.8-92.8	92.8-92.8-93.0/92.8-92.8	90.9-90.7-90.7/90.9-90.7	92.8-92.8-93.0/92.8-92.8	
Temperature Control			Microcomputer Control		Microcomputer Control	
Dimensions (HxWxD)	mm	490x1,050x200		490x1,050x200		
Packaged Dimensions (HxWxD)	mm	280x1,100x566		280x1,100x566		
Weight	kg	17		17		
Gross Weight	kg	24		24		
Operation Sound	H/M/L/SL	dBA	47/43/39/36	46/41/35/33	48/45/41/39	47/42/37/34
Sound Power	H	dBA	63	62	64	63
Heat Insulation			Both Liquid and Gas Pipes		Both Liquid and Gas Pipes	
Piping Connection	Liquid	mm	φ 6.4		φ 6.4	
	Gas	mm	φ12.7		φ12.7	
	Drain	mm	φ18.0		φ18.0	
Drawing No.			3D055049		3D055050	

## Conversion Formulae

$\text{kcal/h} = \text{kW} \times 860$   
 $\text{Btu/h} = \text{kW} \times 3414$   
 $\text{cfm} = \text{m}^3/\text{min} \times 35.3$

Floor Standing Type

50Hz 220-230-240V / 60Hz 220-230V

Model			FVXS35BVMA		FVXS50BVMA	
			Cooling	Heating	Cooling	Heating
Rated Capacity			3.5kW Class		5.0kW Class	
Front Panel Color			Almond White		Almond White	
Air Flow Rates	m <sup>3</sup> /min (cfm)	H	8.3 (293)	9.2 (325)	10.8 (381)	13.2 (466)
		M	6.3 (222)	7.1 (251)	9.2 (325)	11.3 (399)
		L	4.3 (152)	5.0 (177)	7.7 (272)	9.4 (332)
		SL	3.4 (120)	3.6 (127)	6.7 (237)	8.3 (293)
Fan	Type	Cross Flow Fan		Cross Flow Fan		
	Motor Output	W	14+14		14+14	
	Speed	Steps	5 Steps, Quiet, Auto		5 Steps, Quiet, Auto	
Air Direction Control			Right, Left, Horizontal, Upward		Right, Left, Horizontal, Upward	
Air Filter			Removable-Washable-Mildew Proof		Removable-Washable-Mildew Proof	
Running Current (Rated)		A	0.16-0.15-0.14/0.16-0.15	0.16-0.15-0.14/0.16-0.15	0.27-0.26-0.25/0.27-0.26	0.33-0.32-0.31/0.33-0.32
Power Consumption (Rated)		W	32		55	
Power Factor		%	90.9-92.8-95.2/90.9-92.8	90.9-92.8-95.2/90.9-92.8	92.6-92.0-91.7/92.6-92.0	96.4-95.1-94.1/96.4-95.1
Temperature Control			Microcomputer Control		Microcomputer Control	
Dimensions (HxWxD)		mm	600x650x195		600x650x195	
Packaged Dimensions (HxWxD)		mm	714x770x294		714x770x294	
Weight		kg	13		13	
Gross Weight		kg	19		19	
Operation Sound	H/M/L/SL	dBA	39/33/27/24	39/33/26/23	44/40/36/33	45/40/36/33
Sound Power	H	dBA	—		56	57
Heat Insulation			Both Liquid and Gas Pipes		Both Liquid and Gas Pipes	
Piping Connection	Liquid	mm	φ 6.4		φ 6.4	
	Gas	mm	φ 9.5		φ 12.7	
	Drain	mm	φ 20.0		φ 20.0	
Drawing No.			3D054434A		3D055051	

Conversion Formulae
kcal/h=kW×860
Btu/h=kW×3414
cfm=m <sup>3</sup> /min×35.3

Ceiling Mounted Cassette Type

50Hz 230V

Model			FFQ25B8V1B		FFQ35B8V1B	
			Cooling	Heating	Cooling	Heating
Rated Capacity			2.5kW Class		3.5kW Class	
Decoration Panel	Color	White		White		
	Dimensions (HxWxD)	55x700x700		55x700x700		
Air Flow Rates	m <sup>3</sup> /min (cfm)	H	9.0 (318)	9.0 (318)	10.0 (353)	10.0 (353)
		M	—	—	—	—
		L	6.5 (230)	6.5 (230)	6.5 (230)	6.5 (230)
		SL	—	—	—	—
Fan	Type	Turbo Fan		Turbo Fan		
	Motor Output	W	55		55	
	Speed	Steps	2 Steps		2 Steps	
Air Direction Control			Horizontal, Downward		Horizontal, Downward	
Air Filter			—		—	
Running Current (Rated)		A	0.37	0.32	0.40	0.36
Power Consumption (Rated)		W	73		84	
Power Factor		%	85.8	87.0	91.3	91.8
Temperature Control			Microcomputer Control		Microcomputer Control	
Dimensions (HxWxD) ★		mm	260(286)x575x575		260(286)x575x575	
Packaged Dimensions (HxWxD)		mm	370x687x674		370x687x674	
Weight		kg	17.5		17.5	
Gross Weight		kg	21		21	
Operation Sound	H/L	dBA	29.5/24.5	29.5/24.5	32.0/25.0	32.0/25.0
Sound Power	H	dBA	46.5	—	49.0	—
Heat Insulation			Both Liquid and Gas Pipes		Both Liquid and Gas Pipes	
Piping Connection	Liquid	mm	φ 6.4		φ 6.4	
	Gas	mm	φ 9.5		φ 9.5	
	Drain	mm	VP20 (O.D φ 26 / I.D φ 20)		VP20 (O.D φ 26 / I.D φ 20)	
Drawing No.			3D040445		3D040443	

Note: ★ ( ) : dimension including control box

Conversion Formulae
kcal/h=kW×860
Btu/h=kW×3414
cfm=m <sup>3</sup> /min×35.3

50Hz 240V

Model			FFQ50B8V1B		FFQ60B8V1B	
			Cooling	Heating	Cooling	Heating
Rated Capacity			5.0kW Class		6.0kW Class	
Decoration Panel	Color		White		White	
	Dimensions (HxWxD)		55x700x700		55x700x700	
Air Flow Rates	m <sup>3</sup> /min (cfm)	H	13.0 (459)	13.0 (459)	15.5 (547)	15.5 (547)
		M	—	—	—	—
		L	8.0 (283)	8.0 (283)	11.0 (388)	11.0 (388)
		SL	—	—	—	—
Fan	Type		Turbo Fan		Turbo Fan	
	Motor Output	W	55		55	
	Speed	Steps	2 Steps		2 Steps	
Air Direction Control			Horizontal, Downward		Horizontal, Downward	
Air Filter			—		—	
Running Current (Rated)		A	0.51	0.46	0.63	0.57
Power Consumption (Rated)		W	117	109	140	131
Power Factor		%	95.6	98.7	92.6	95.8
Temperature Control			Microcomputer Control		Microcomputer Control	
Dimensions (HxWxD) ★		mm	260(286)x575x575		260(286)x575x575	
Packaged Dimensions (HxWxD)		mm	370x687x674		370x687x674	
Weight		kg	17.5		17.5	
Gross Weight		kg	21		21	
Operation Sound	H/L	dBA	38.0/28.0	38.0/28.0	42.0/34.0	42.0/34.0
Sound Power	H	dBA	55.0	—	59.0	—
Heat Insulation			Both Liquid and Gas Pipes		Both Liquid and Gas Pipes	
Piping Connection	Liquid	mm	φ 6.4		φ 6.4	
	Gas	mm	φ 12.7		φ 12.7	
	Drain	mm	VP20 (O.D φ 26 / I.D φ 20)		VP20 (O.D φ 26 / I.D φ 20)	
Drawing No.			3D040440		3D040435	

★ ( ) : dimension including control box

## Conversion Formulae

kcal/h=kW×860  
 Btu/h=kW×3414  
 cfm=m<sup>3</sup>/min×35.3

# 1.4 Outdoor Units - Heat Pump

50Hz 230-240V

Model			3MXS52EVMA		3MXS68EVMA	
			Cooling	Heating	Cooling	Heating
Cooling Capacity	kW	---		---		
Power Consumption	W	---		---		
Running Current	A	---		---		
Casing Color		Ivory White		Ivory White		
Compressor	Type	Hermetically Sealed Swing Type		Hermetically Sealed Swing Type		
	Model	2YC36BXD		2YC45BXD		
Motor Output	W	1,100		1,380		
Refrigerant Oil	Model	FVC50K		FVC50K		
	Charge	L	0.65		0.75	
Refrigerant	Type	R-410A		R-410A		
	Charge	kg	2.0		2.6	
Air Flow Rates	m³/min	H	45	45	51	47.6
		L	45	43	45	45
	cfm	H	1,589	1,589	1,801	1,681
		L	1,589	1,518	1,589	1,589
Fan	Type	Propeller		Propeller		
	Motor Output	W	53		53	
	Running Current	A	H: 0.33 / L: 0.33	H: 0.33 / L: 0.31	H: 0.33 / L: 0.25	H: 0.31 / L: 0.25
	Power Consumption	W	H: 43 / L: 43	H: 43 / L: 41	H: 68 / L: 46	H: 63 / L: 46
Starting Current	A	6.3		9.0		
Dimensions (HxWxD)	mm	735x936x300		735x936x300		
Packaged Dimensions (HxWxD)	mm	792x992x390		792x992x390		
Weight	kg	49		59		
Gross Weight	kg	56		64		
Operation Sound	dBA	46	47	48	49	
Sound Power	dBA	59	60	61	62	
Piping Connection	Liquid	mm	φ 6.4x3		φ 6.4x3	
	Gas	mm	φ 9.5x2, φ 12.7x1		φ 12.7x3	
	Drain	mm	φ 18.0		φ 18.0	
Heat Insulation		Both Liquid and Gas Pipes		Both Liquid and Gas Pipes		
No. of Wiring Connection		3 for Power Supply, 4 for Interunit Wiring		3 for Power Supply, 4 for Interunit Wiring		
Max. Interunit Piping Length	m	50 (for Total of Each Room)		60 (for Total of Each Room)		
	m	25 (for One Room)		25 (for One Room)		
Amount of Additional Charge	g/m	20 (30m or more)		20 (30m or more)		
Max. Installation Height Difference	m	15 (between Indoor Unit and Outdoor Unit)		15 (between Indoor Unit and Outdoor Unit)		
	m	7.5 (between Indoor Units)		7.5 (between Indoor Units)		
Drawing No.		3D055012		3D055072		

**Note:** 1. The data are based on the conditions shown in the table below.

Cooling	Heating	Piping Length
Indoor ; 27°CDB/19°CWB Outdoor ; 35°CDB	Indoor ; 20°CDB Outdoor ; 7°CDB/6°CWB	7.5m

Conversion Formulae
kcal/h=kWx860 Btu/h=kWx3414 cfm=m³/minx35.3

50Hz 220-230-240V / 60Hz 220-230V

Model			4MXS80EVMA	
			Cooling	Heating
Cooling Capacity	kW		—	
Power Consumption	W		—	
Running Current	A		—	
Casing Color	Ivory White			
Compressor	Type	Hermetically Sealed Swing Type		
	Model	2YC63BXD		
	Motor Output	W	1,920	
Refrigerant Oil	Model	FVC50K		
	Charge	L	0.75	
Refrigerant	Type	R-410A		
	Charge	kg	3.1	
Air Flow Rates	m <sup>3</sup> /min	H	54.5	46.0
		L	46.0	14.7
	cfm	H	1,924	1,624
		L	1,624	519
Fan	Type	Propeller		
	Motor Output	W	66	
	Running Current	A	H: 0.97 / L: 0.69	H: 0.69 / L: 0.55
	Power Consumption	W	H: 86 / L: 55	H: 55 / L: 9
Starting Current	A	9.7		
Dimensions (HxWxD)	mm	770x900x320		
Packaged Dimensions (HxWxD)	mm	900x925x390		
Weight	kg	72		
Gross Weight	kg	81		
Operation Sound	dB(A)	48	49	
Sound Power	dB(A)	61	62	
Piping Connection	Liquid	mm	φ 6.4x4	
	Gas	mm	φ 9.5x1, φ 12.7x1, φ 15.9x2	
	Drain	mm	φ 25	
Heat Insulation	Both Liquid and Gas Pipes			
No. of Wiring Connection	3 for Power Supply, 4 for Interunit Wiring			
Max. Interunit Piping Length	m	70 (for Total of Each Room)		
	m	25 (for One Room)		
Amount of Additional Charge	g/m	20 (40m or more)		
Max. Installation Height Difference	m	15 (between Indoor Unit and Outdoor Unit)		
	m	7.5 (between Indoor Units)		
Drawing No.	3D052664#1			

**Note:** 1. The data are based on the conditions shown in the table below.

Cooling	Heating	Piping Length
Indoor ; 27°CDB/19°CWB Outdoor ; 35°CDB	Indoor ; 20°CDB Outdoor ; 7°CDB/6°CWB	7.5m

Conversion Formulae
kcal/h=kW×860 Btu/h=kW×3414 cfm=m <sup>3</sup> /min×35.3

Model		3MXS90EVL				4MXS100EVL				
		Cooling		Heating		Cooling		Heating		
Cooling Capacity	kW	—				—				
Power Consumption	W	—				—				
Running Current	A	—				—				
Casing Color		Ivory White				Ivory White				
Compressor	Type	Hermetically Sealed Swing Type				Hermetically Sealed Swing Type				
	Model	2YC63BXD				2YC63BXD				
	Motor Output	W	1,920		1,920		1,920			
Refrigerant Oil	Model	FVC50K				FVC50K				
	Charge	L	0.75		0.75		0.75			
Refrigerant	Type	R-410A				R-410A				
	Charge	kg	3.1		3.1		3.1			
Air Flow Rates	m <sup>3</sup> /min	H	54.5	51.2	54.5	51.2	51.2	51.2		
		M	51.2	—	51.2	—	—	—		
		L	46.0	14.7	46.0	14.7	14.7	14.7		
	cfm	H	1,924	1,808	1,924	1,808	1,808	1,808		
		M	1,808	—	1,808	—	—	—		
		L	1,624	519	1,624	519	519	519		
Fan	Type	Propeller				Propeller				
	Motor Output	W	66		66		66			
	Running Current	A	H: 0.97 / M: 0.86 / L: 0.69		H: 0.69 / L: 0.05		H: 0.97 / M: 0.86 / L: 0.69			
	Power Consumption	W	H: 86 / M: 73 / L: 55		H: 73 / L: 9		H: 86 / M: 73 / L: 55			
Starting Current	A	14.0				14.0				
Dimensions (HxWxD)	mm	770x900x320				770x900x320				
Packaged Dimensions (HxWxD)	mm	900x925x390				900x925x390				
Weight	kg	72				72				
Gross Weight	kg	81				81				
Operation Sound	dBA	50	51	50	51	50	51	50		
Piping Connection	Liquid	mm	φ 6.4x3				φ 6.4x4			
	Gas	mm	φ 9.5x1, φ 12.7x1, φ 15.9x1				φ 9.5x1, φ 12.7x1, φ 15.9x2			
	Drain	mm	φ 25.0				φ 25.0			
Heat Insulation		Both Liquid and Gas Pipes				Both Liquid and Gas Pipes				
No. of Wiring Connection		3 for Power Supply, 4 for Interunit Wiring				3 for Power Supply, 4 for Interunit Wiring				
Max. Interunit Piping Length	m	70 (for Total of Each Room)				70 (for Total of Each Room)				
	m	25 (for One Room)				25 (for One Room)				
Amount of Additional Charge	g/m	20 (40m or more)				20 (40m or more)				
Max. Installation Height Difference	m	15 (between Indoor Unit and Outdoor Unit)				15 (between Indoor Unit and Outdoor Unit)				
	m	7.5 (between Indoor Units)				7.5 (between Indoor Units)				
Drawing No.		3D052686#1				3D052682#1				

**Note:** 1. The data are based on the conditions shown in the table below.

Cooling	Heating	Piping Length
Indoor ; 27°CDB/19°CWB Outdoor ; 35°CDB/24°CWB	Indoor ; 20°CDB Outdoor ; 7°CDB/6°CWB	7.5m

Conversion Formulae
kcal/h=kW×860 Btu/h=kW×3414 cfm=m <sup>3</sup> /min×35.3

# Part 3

# Printed Circuit Board

# Connector Wiring Diagram

1. Printed Circuit Board Connector Wiring Diagram.....	52
1.1 Wall Mounted Type .....	52
1.2 Duct Connected Type.....	56
1.3 Floor / Ceiling Suspended Dual Type.....	58
1.4 Floor Standing Type .....	61
1.5 Ceiling Mounted Cassette Type (600×600).....	64
1.6 Outdoor Units – E Series (50-58 Class, 80-100 Class) .....	67
1.7 Outdoor Units – E Series (68-75 Class) .....	70
1.8 Outdoor Units – D Series .....	73



# 1. Printed Circuit Board Connector Wiring Diagram

## 1.1 Wall Mounted Type

### 1.1.1 FTK(X)S 25/35 E, FTK(X)S 20~35 D

#### Connectors

#### PCB(1) (Control PCB)

- |        |   |
|--------|---|
| 1) S1  | Connector for DC fan motor                    |
| 2) S6  | Connector for swing motor (horizontal blades) |
| 3) S21 | Connector for centralized control (HA)        |
| 4) S26 | Connector for display PCB                     |
| 5) S28 | Connector for signal receiver PCB             |
| 6) S32 | Connector for heat exchanger thermistor       |
| 7) S35 | Connector for INTELLIGENT EYE sensor PCB      |

#### PCB(2) (Signal Receiver PCB)

- |        |                           |
|--------|---------------------------|
| 1) S29 | Connector for control PCB |
|--------|---------------------------|

#### PCB(3) (Display PCB)

- |        |                           |
|--------|---------------------------|
| 1) S27 | Connector for control PCB |
|--------|---------------------------|

#### PCB(4) (INTELLIGENT EYE sensor PCB)

- |        |                           |
|--------|---------------------------|
| 1) S36 | Connector for control PCB |
|--------|---------------------------|



#### Note:

Other designations

#### PCB(1) (Control PCB)

- |          |  |
|----------|--|
| 1) V1    | Varistor   |
| 2) JA    | Address setting jumper                                 |
| JB       | Fan speed setting when compressor is OFF on thermostat |
| JC       | Power failure recovery function (auto-restart)         |
|          | * Refer to page 357 for detail.                        |
| 3) LED A | LED for service monitor (green)                        |
| 4) FU1   | Fuse (3.15A)   |

#### PCB(3) (Display PCB)

- |               |                                  |
|---------------|----------------------------------|
| 1) SW1 (S1W)  | Forced operation ON / OFF switch |
| 2) LED1       | LED for operation (green)        |
| 3) LED2       | LED for timer (yellow)           |
| 4) LED3       | LED for INTELLIGENT EYE (green)  |
| 5) RTH1 (R1T) | Room temperature thermistor      |

PCB Detail

PCB(1): Control PCB (indoor unit)

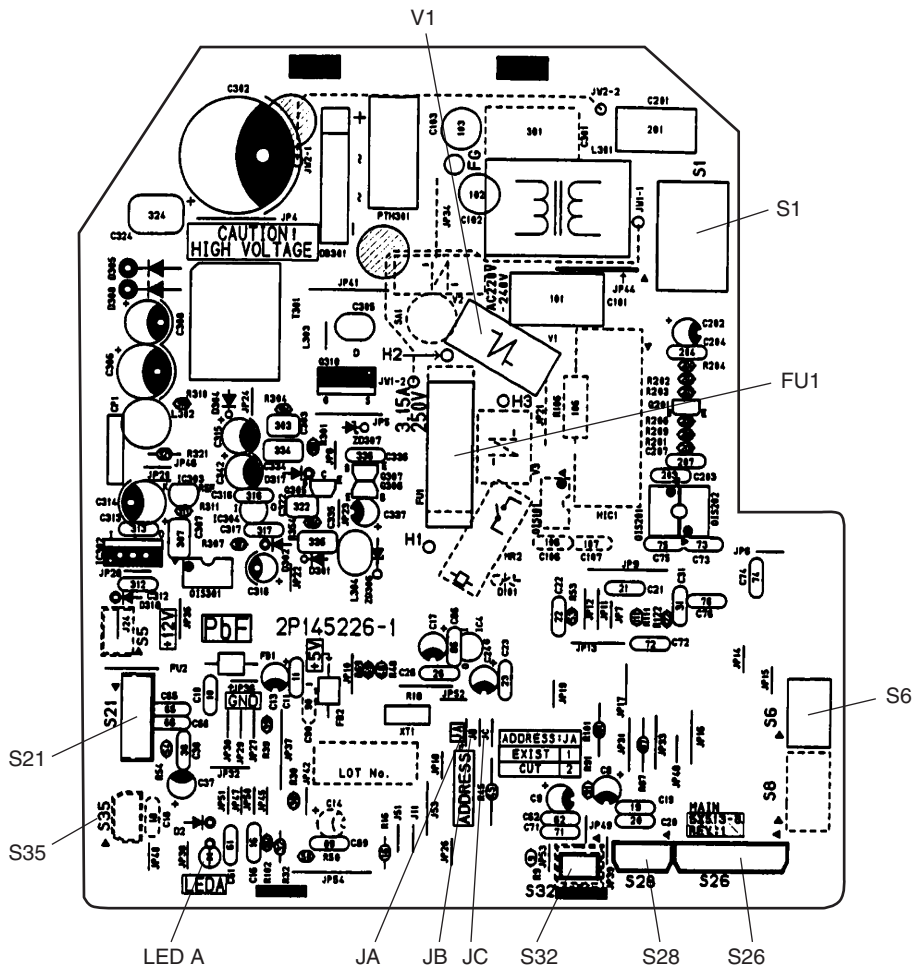

(R4288)

PCB(2): Signal Receiver PCB

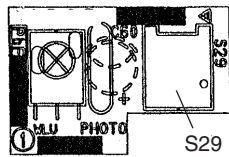

(R4289)

PCB(3): Display PCB

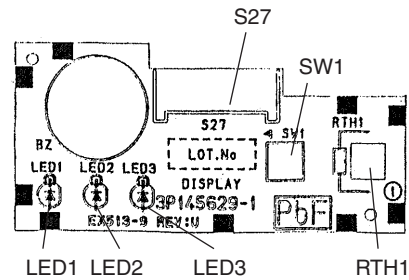

(R4290)

PCB(4): INTELLIGENT EYE sensor PCB

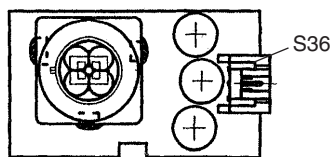

(R4291)

## 1.1.2 FTK(X)S 50~71F, FTK(X)S 50~71 D, FTKS 50~71 B

### Connectors

#### PCB(1) (Control PCB)

- 1) **S1** Connector for DC fan motor
- 2) **S6** Connector for swing motor (horizontal blades)
- 3) **S8** Connector for swing motor (vertical blades)
- 4) **S21** Connector for [centralized control \(HA\)](#)
- 5) **S26** Connector for buzzer PCB
- 6) **S28** Connector for signal receiver PCB
- 7) **S32** Connector for heat exchanger thermistor
- 8) **S35** Connector for Intelligent Eye sensor PCB

#### PCB(2) (Signal Receiver PCB)

- 1) **S29** Connector for control PCB

#### PCB(3) (Buzzer PCB)

- 1) **S27** Connector for control PCB
- 2) **S38** Connector for display PCB

#### PCB(4) (Display PCB)

- 1) **S37** Connector for buzzer PCB

#### PCB(5) (INTELLIGENT EYE sensor PCB)

- 1) **S36** Connector for control PCB



#### Note:

Other designations

#### PCB(1) (Control PCB)

- 1) **V1** [Varistor](#)
- 2) **JA** [Address setting jumper](#)
- JB** [Fan speed setting](#) when compressor is OFF on thermostat
- JC** [Power failure recovery function](#)
- \* Refer to page 357 for detail.
- 3) **LED A** LED A for service monitor (green)
- 4) **FU1** [Fuse](#) (3.15A)

#### PCB(2) (Signal Receiver PCB)

- 1) **SW1 (S1W)** Forced operation ON/OFF switch

#### PCB(3) (Buzzer PCB)

- 1) **RTH1 (R1T)** Room temperature thermistor

#### PCB(4) (Display PCB)

- 4) **LED1** LED for operation (green)
- 5) **LED2** LED for timer (yellow)
- 6) **LED3** LED for HOME LEAVE operation (red)

PCB Detail

PCB(1): Control PCB (indoor unit)

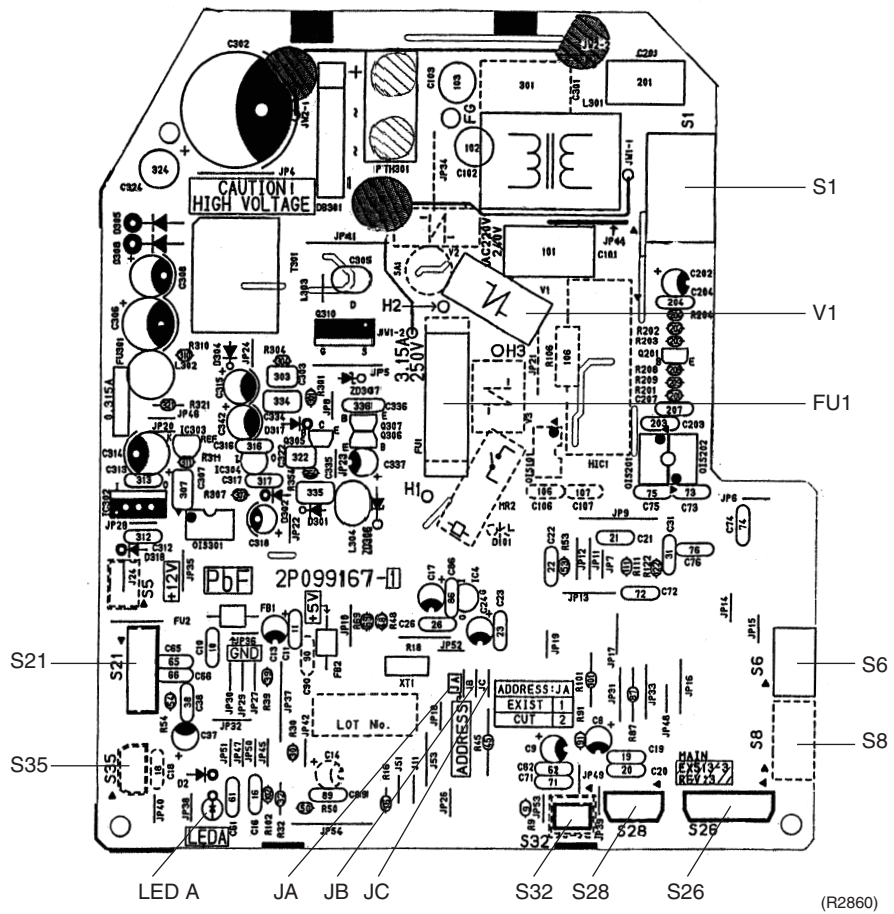

PCB(2): Signal Receiver PCB

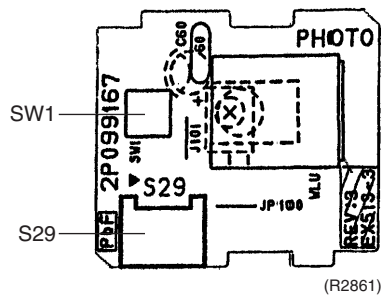

PCB(3): Buzzer PCB

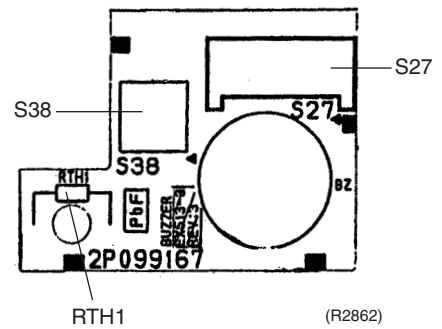

PCB(4): Display PCB

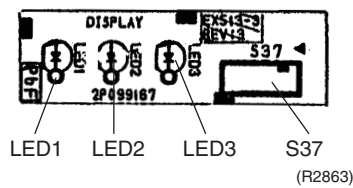

PCB(5): INTELLIGENT EYE sensor PCB

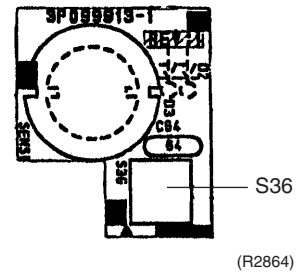

# 1.2 Duct Connected Type

## Connectors

### PCB(1) (Control PCB)

- 1) S1 Connector for AC fan motor
- 2) S7 Connector for AC fan motor
- 3) S21 Connector for centralized control to 5 rooms
- 4) S26 Connector for display PCB
- 5) S32 Connector for heat exchanger thermistor

### PCB(2) (Display PCB)

- 1) S1 Connector for control PCB



**Note:**

Other designations

### PCB(1) (Control PCB)

- 1) V1 Varistor
  - 2) JA Address setting jumper
  - JB Fan speed setting when compressor is OFF on thermostat
  - JC Power failure recovery function
- \* Refer to page 357 for more detail.
- 3) LED A LED for service monitor (green)
  - 4) FU1 Fuse (3.15A)

### PCB(2) (Display PCB)

- 1) SW1 (S1W) Forced operation ON/OFF switch
- 2) LED1 LED for operation (green)
- 3) LED2 LED for timer (yellow)
- 4) LED3 LED for HOME LEAVE operation (red)
- 5) RTH1 (R1T) Room temperature thermistor

## PCB Detail

### PCB (1): Control PCB (indoor unit)

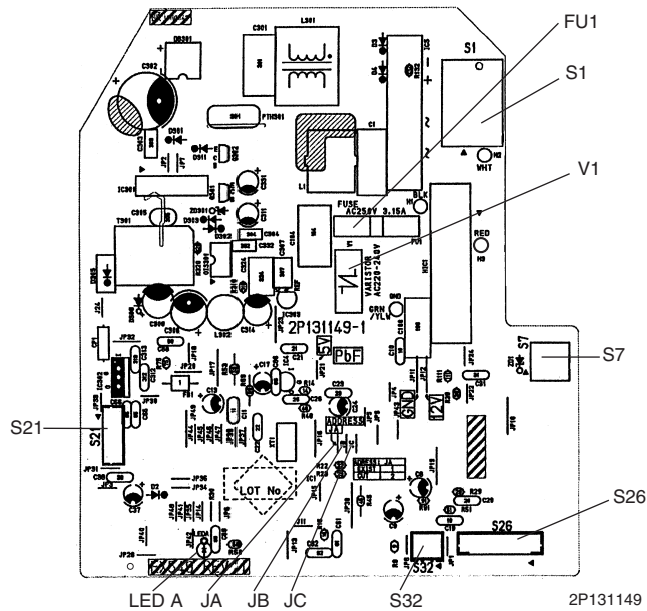

PCB Detail

PCB (2): Display PCB

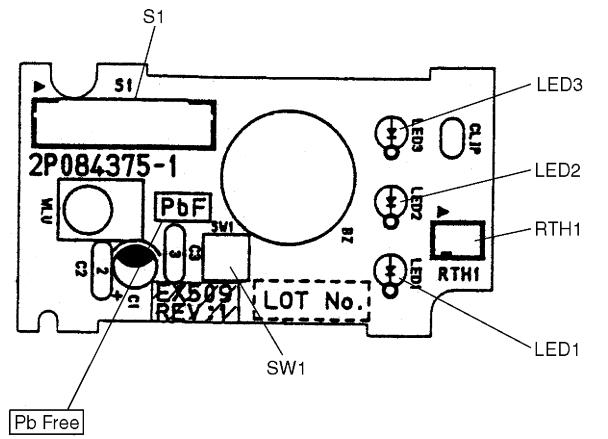

2P084375

## 1.3 Floor / Ceiling Suspended Dual Type

### Connectors

#### PCB(1) (Control PCB)

- 1) [S6](#) Connector for swing motor (horizontal swing)
- 2) [S7](#) Connector for AC fan motor
- 3) [S21](#) Connector for [centralized control](#)
- 4) [S24](#) Connector for display PCB
- 5) [S26](#) Connector for signal receiver PCB
- 6) [S32](#) Connector for heat exchanger thermistor
- 7) [S37](#) Connector for power supply PCB

#### PCB(2) (Power Supply PCB)

- 1) [S36](#) Connector for control PCB

#### PCB(3) (Display PCB)

- 1) [S25](#) Connector for control PCB

#### PCB(4) (Signal Receiver PCB)

- 1) [S27](#) Connector for control PCB
- 2) [S31](#) Connector for room temperature thermistor



#### Note:

Other designations

#### PCB(1) (Control PCB)

- 1) [JA](#) [Address setting jumper](#)
- [JB](#) [Fan speed setting](#) when compressor is OFF on thermostat
- [JC](#) [Power failure recovery function \(auto-restart\)](#)  
\* Refer to page 357 for detail.
- 2) [SW2](#) Select switch ceiling or floor
- 3) [LED A](#) LED for service monitor (green)

#### PCB(2) (Power Supply PCB)

- 1) [V1](#) [Varistor](#)
- 1) [FU1](#) [Fuse \(3.15A\)](#)

#### PCB(3) (Display PCB)

- 1) [LED1](#) LED for operation (green)
- 2) [LED2](#) LED for timer (yellow)
- 3) [LED3](#) LED for HOME LEAVE operation (red)

#### PCB(4) (Signal Receiver PCB)

- 1) [SW1 \(S1W\)](#) [Forced operation ON/OFF switch](#)

PCB Detail

PCB (1): Control PCB (indoor unit)

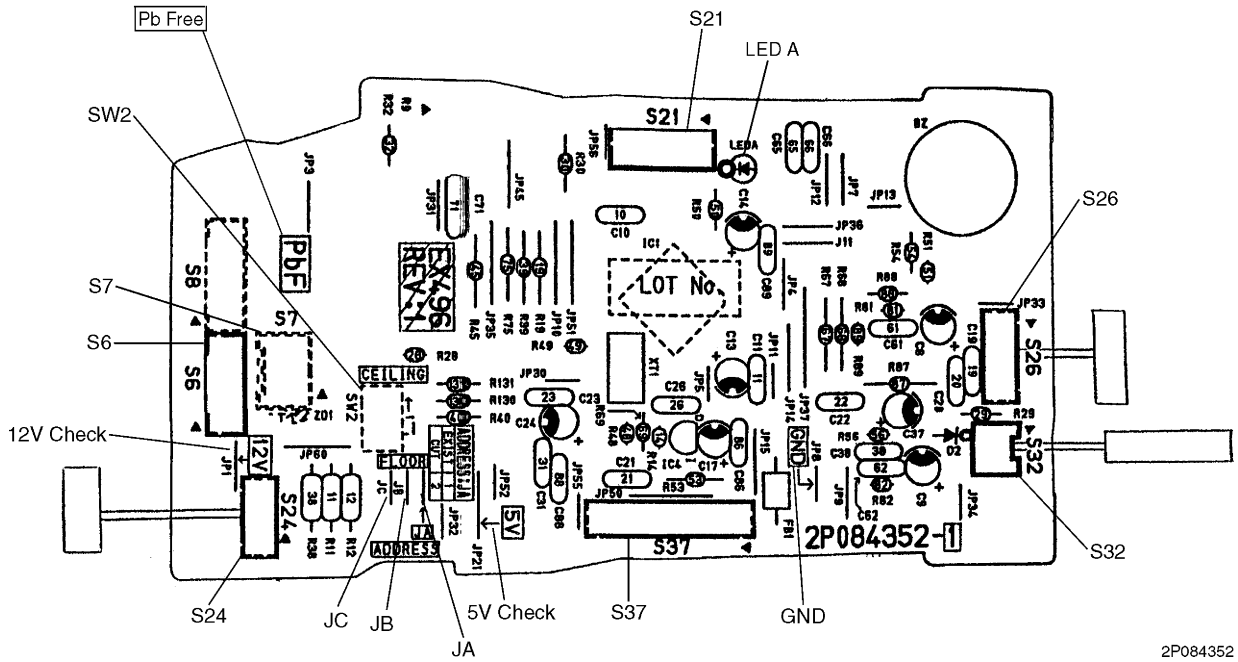

2P084352

PCB Detail

PCB (2): Power Supply PCB

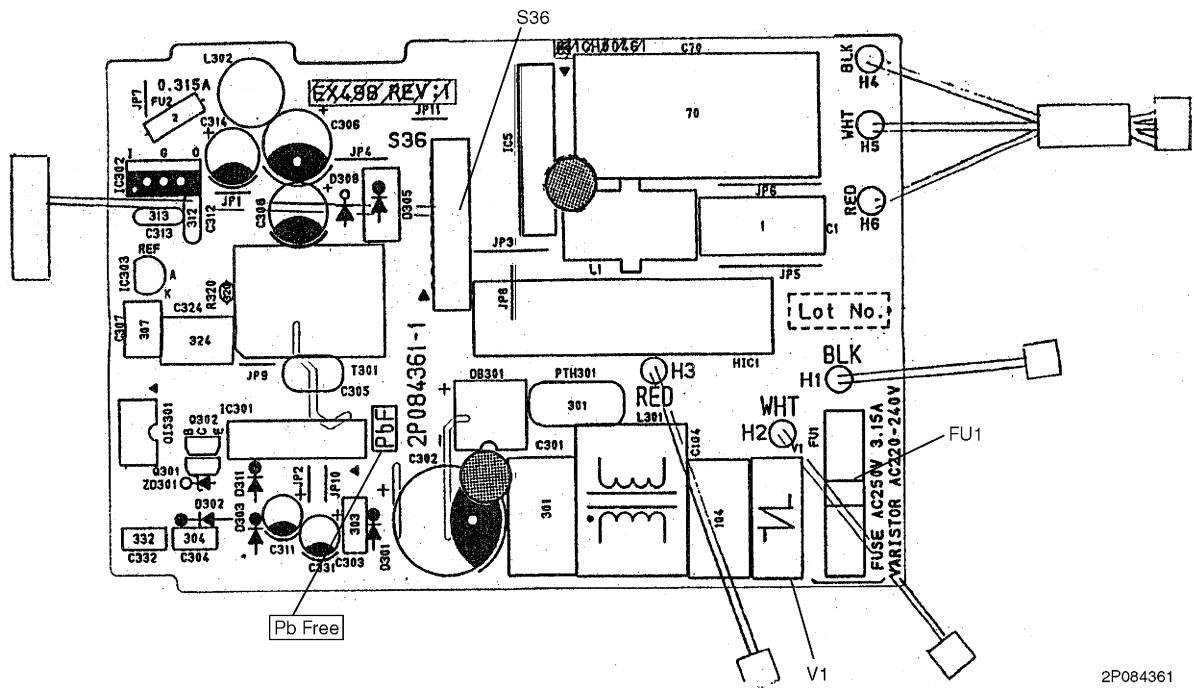

2P084361



PCB (3): Display PCB

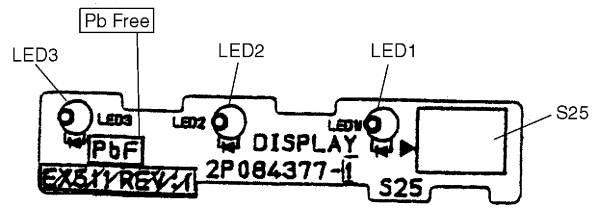

2P084377

PCB (4): Signal Receiver PCB

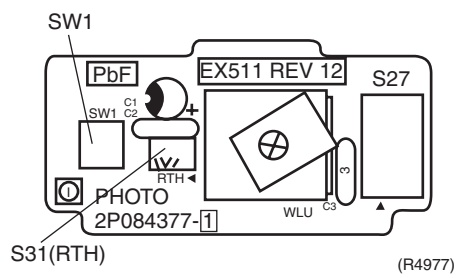

## 1.4 Floor Standing Type

### Connectors

#### PCB(1) (Power Supply PCB)

- 1) [S8](#), [S202](#), [S204](#) Connector for control PCB

#### PCB(2) (Control PCB)

- 1) [S6](#) Connector for swing motor and lower air outlet motor
- 2) [S21](#) Connector for [centralized control](#)
- 3) [S23](#) Connector for display PCB
- 4) [S31](#), [S32](#) Connector for room temperature / heat exchanger thermistor
- 5) [S7](#), [S201](#), [S203](#) Connector for power supply PCB
- 6) [S25](#) Connector for signal receiver PCB
- 7) [S301](#), [S302](#) Connector for DC fan motors

#### PCB(3) (Signal Receiver PCB)

- 1) [S26](#) Connector for control PCB

#### PCB(4) (Display PCB)

- 1) [S24](#) Connector for control PCB



#### Note:

Other Designations

#### PCB(2) (Control PCB)

- 1) [V1](#) [Varistor](#)
- 2) [JA](#) [Address setting jumper](#)
- [JB](#) [Fan speed setting](#) when compressor is OFF on thermostat
- [JC](#) [Power failure recovery function \(auto-restart\)](#)  
\* Refer to page 357 for detail.
- 3) [FU](#) [Fuse](#) (3.15A)
- 4) [LED A](#) LED for service monitor (green)

#### PCB(3) (Signal Receiver PCB)

- 1) [SW2](#) Changing upward air flow limit switch
- 2) [SW4](#) Discharge changeover switch

#### PCB(4) (Display PCB)

- 1) [SW1](#) ([S1W](#)) [Forced operation ON/OFF switch](#)
- 2) [LED11](#) LED for operation (green)
- 3) [LED12](#) LED for timer (yellow)
- 4) [LED14](#) LED for HOME LEAVE operation (red)

PCB Detail

PCB (1): Power Supply PCB (35 class)

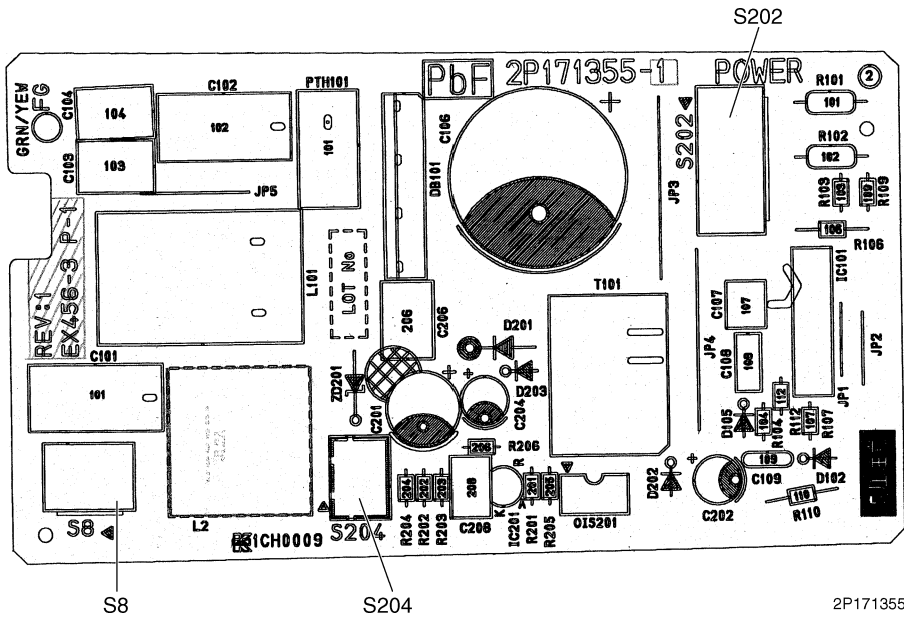

PCB Detail

PCB (1): Power Supply PCB (50 class)

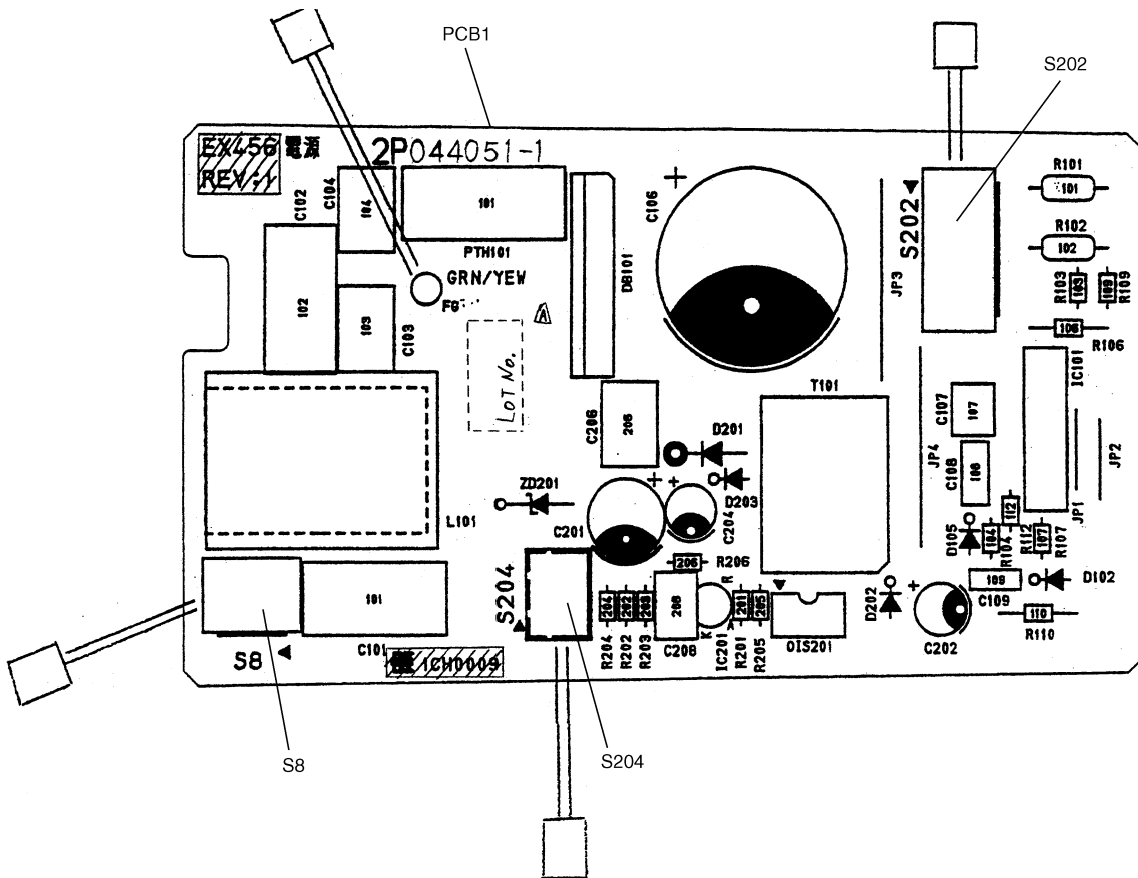

2P044051

PCB Detail

PCB (2): Control PCB (indoor unit)

PCB (3): Display PCB

PCB (4): Signal Receiver PCB

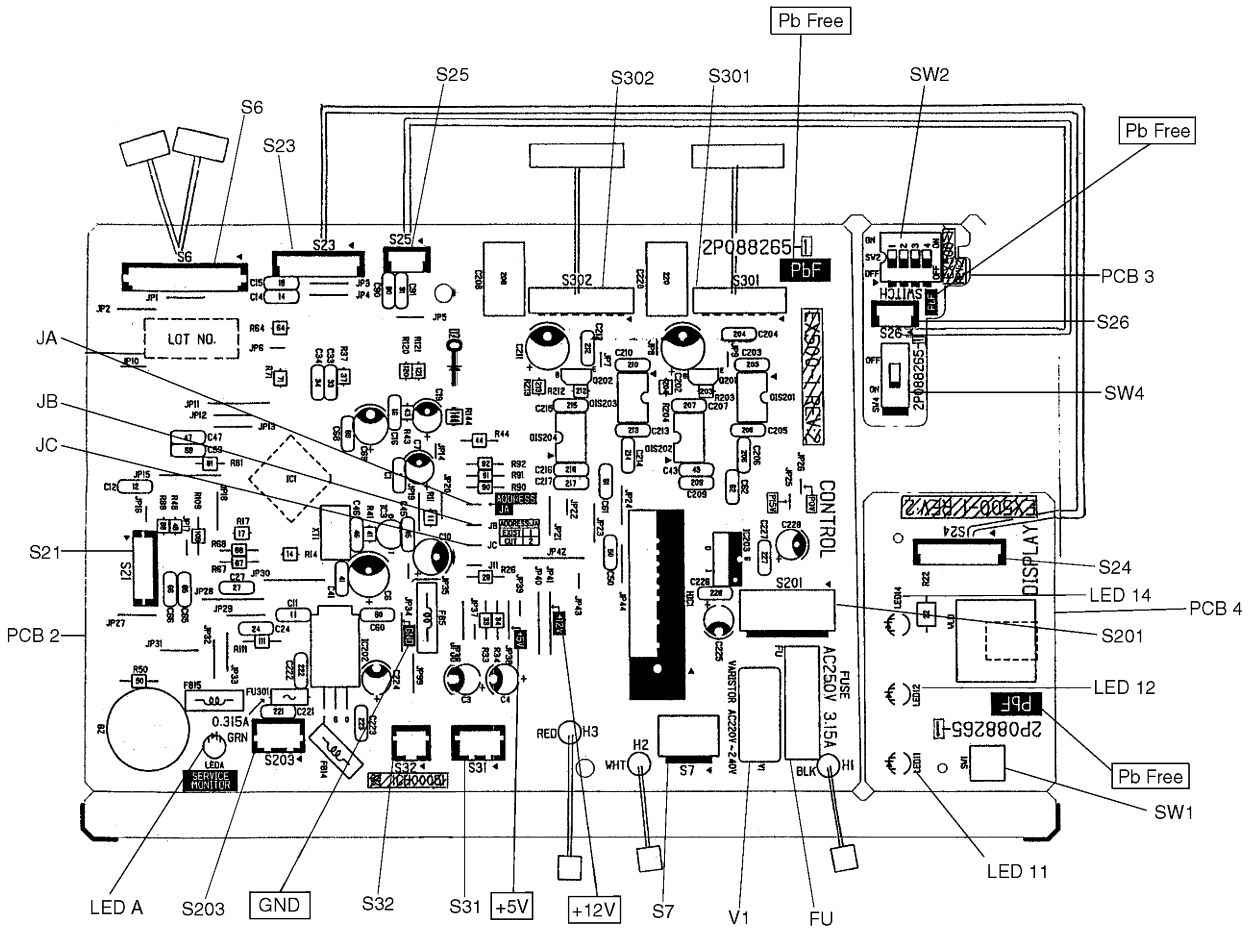

2P088265

## 1.5 Ceiling Mounted Cassette Type (600×600)

### Connectors

#### PCB(1)(Control PCB [A1P])

- |                |  |
|----------------|--|
| 1) X5A         | Connector for terminal strip (for wired remote controller)                         |
| 2) X10A, X11A  | Connector for transformer  |
| 3) X15A        | Connector for float switch   |
| 4) X17A, X18A  | Connector for heat exchanger thermistor  |
| 5) X19A        | Connector for room temperature thermistor  |
| 6) X20A        | Connector for fan motor  |
| 7) X24A        | Connector for signal receiver PCB<br>(when the wireless remote controller is used) |
| 8) X25A        | Connector for drain pump motor   |
| 9) X27A        | Connector for terminal strip (for inter unit wiring)                               |
| 10) X33A       | Optional connector for wiring adaptor PCB  |
| 11) X35A       | Optional connector for group control adaptor                                       |
| 12) X36A       | Connector for swing motor  |
| 13) X40A       | Optional connector for ON/OFF input from outside                                   |
| 14) X60A, X61A | Optional connector for interface adaptor   |

#### PCB(2)(Signal Receiver PCB [A3P])

- |        |                           |
|--------|---------------------------|
| 1) X1A | Connector for display PCB |
| 2) X2A | Connector for control PCB |

#### PCB(3)(Display PCB [A4P])

- |        |                                   |
|--------|-----------------------------------|
| 1) X1A | Connector for signal receiver PCB |
|--------|-----------------------------------|



#### Note:

Other designation

#### PCB(1)(Control PCB [A1P])

- |        |                     |
|--------|---------------------|
| 1) HAP | Service monitor LED |
|--------|---------------------|

#### PCB(2)(Signal Receiver PCB [A3P])

- |        |                        |
|--------|------------------------|
| 1) SS2 | Address setting switch |
|--------|------------------------|

#### PCB(3)(Display PCB [A4P])

- |              |                                    |
|--------------|------------------------------------|
| 1) BS1       | Forced operation ON/OFF switch     |
| 2) LED1(H1P) | LED for operation (red)            |
| 3) LED2(H2P) | LED for timer (green)              |
| 4) LED3(H3P) | LED for filter cleaning sign (red) |
| 5) LED4(H4P) | LED for defrost operation (orange) |

PCB Detail

PCB(1): Control PCB (A1P) (indoor unit)

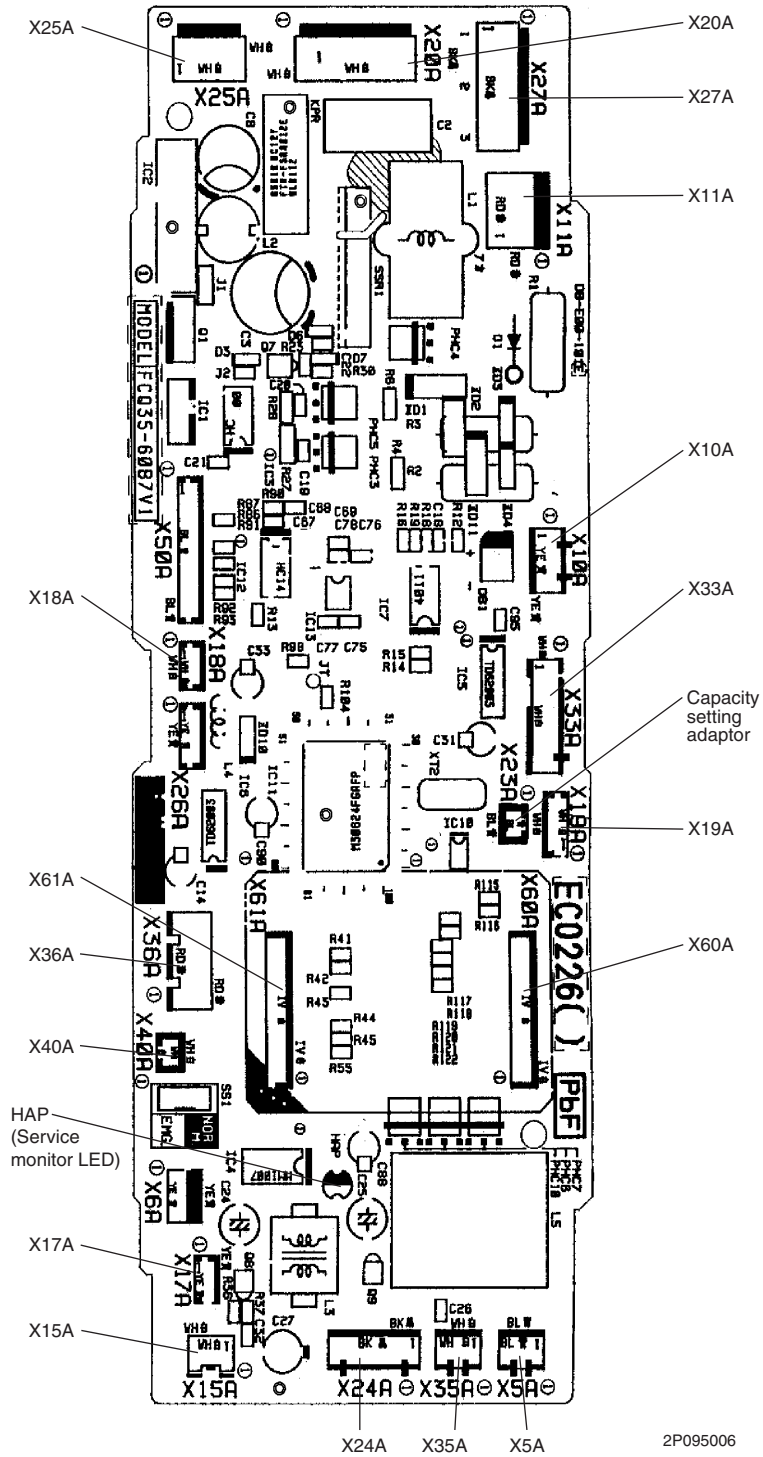

PCB Detail

PCB(2): Signal Receiver PCB (A3P)

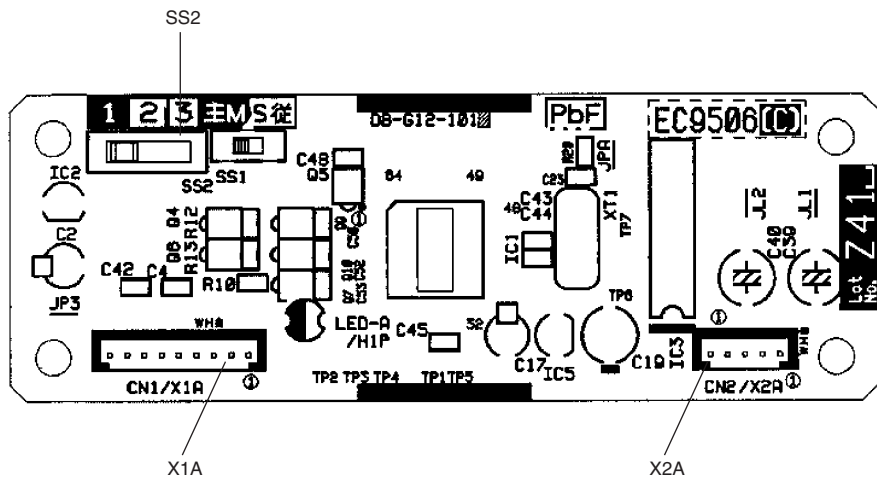

(R4873)

PCB(3): Display PCB (A4P)

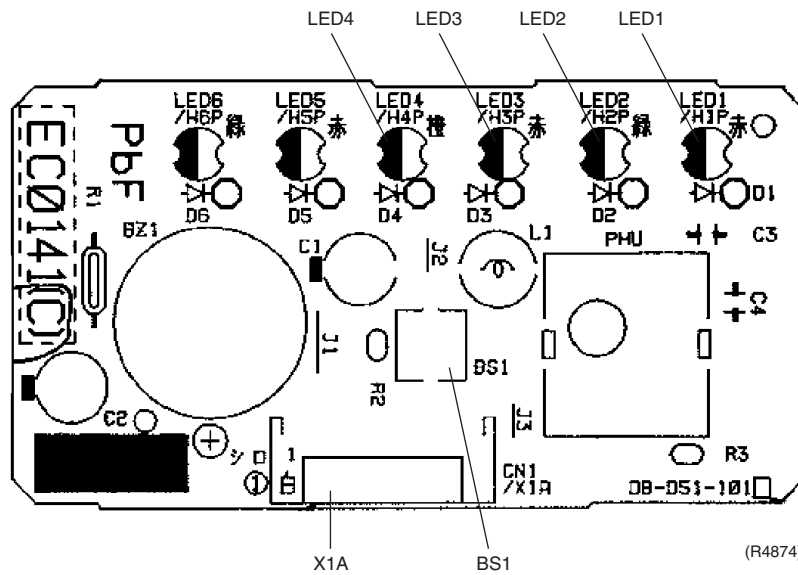

(R4874)

## 1.6 Outdoor Units – E Series (50-58 Class, 80-100 Class)

### Connectors

#### PCB(1)(Main PCB)

- |              |  |
|--------------|--|
| 1) S10       | Connector for terminal strip (indoor-outdoor transmission)                     |
| 2) S15       | Connector for COOL / HEAT mode lock  |
| 3) S20       | Connector for electronic expansion valve coil A port (white)                   |
| 4) S21       | Connector for electronic expansion valve coil B port (red)                     |
| 5) S22       | Connector for electronic expansion valve coil C port (blue)                    |
| 6) S23       | Connector for electronic expansion valve coil D port (yellow)                  |
| 7) S40       | Connector for overload protector   |
| 8) S51, S101 | Connector for service monitor PCB  |
| 9) S70       | Connector for fan motor  |
| 10) S80      | Connector for four way valve coil  |
| 11) S90      | Connector for thermistors<br>(outdoor air, heat exchanger, and discharge pipe) |
| 12) S92      | Connector for gas pipe thermistor  |
| 13) S93      | Connector for liquid pipe thermistor   |
| 14) AC1, AC2 | Connector for terminal strip (power supply)                                    |
| 15) HR1, HR2 | Connector for reactor  |

#### PCB(2)(Service Monitor PCB)

- |              |                           |
|--------------|---------------------------|
| 1) S52, S102 | Connector for control PCB |
|--------------|---------------------------|



#### Note:

Other Designations

#### PCB(1)(Main PCB)

- |               |                           |
|---------------|---------------------------|
| 1) FU1        | Fuse (30A)                |
| 2) FU2, FU3   | Fuse (3.15A)              |
| 3) V2, V3, V5 | Varistor                  |
| V6, V11       | (for 50-58 class models)  |
| V9, V100      | (for 80-100 class models) |

#### PCB(2)(Service Monitor PCB)

- |                |                                 |
|----------------|---------------------------------|
| 1) LED A       | Service monitor LED (green)     |
| 2) LED1 - LED4 | Service monitor LED (red)       |
| 3) SW1         | Forced operation ON/OFF switch  |
| 4) SW3         | Wiring error check switch       |
| 5) SW4         | Priority room setting switch    |
| 6) SW5         | Night quiet mode setting switch |



PCB Detail

PCB(1): Main PCB (50-58 class models)

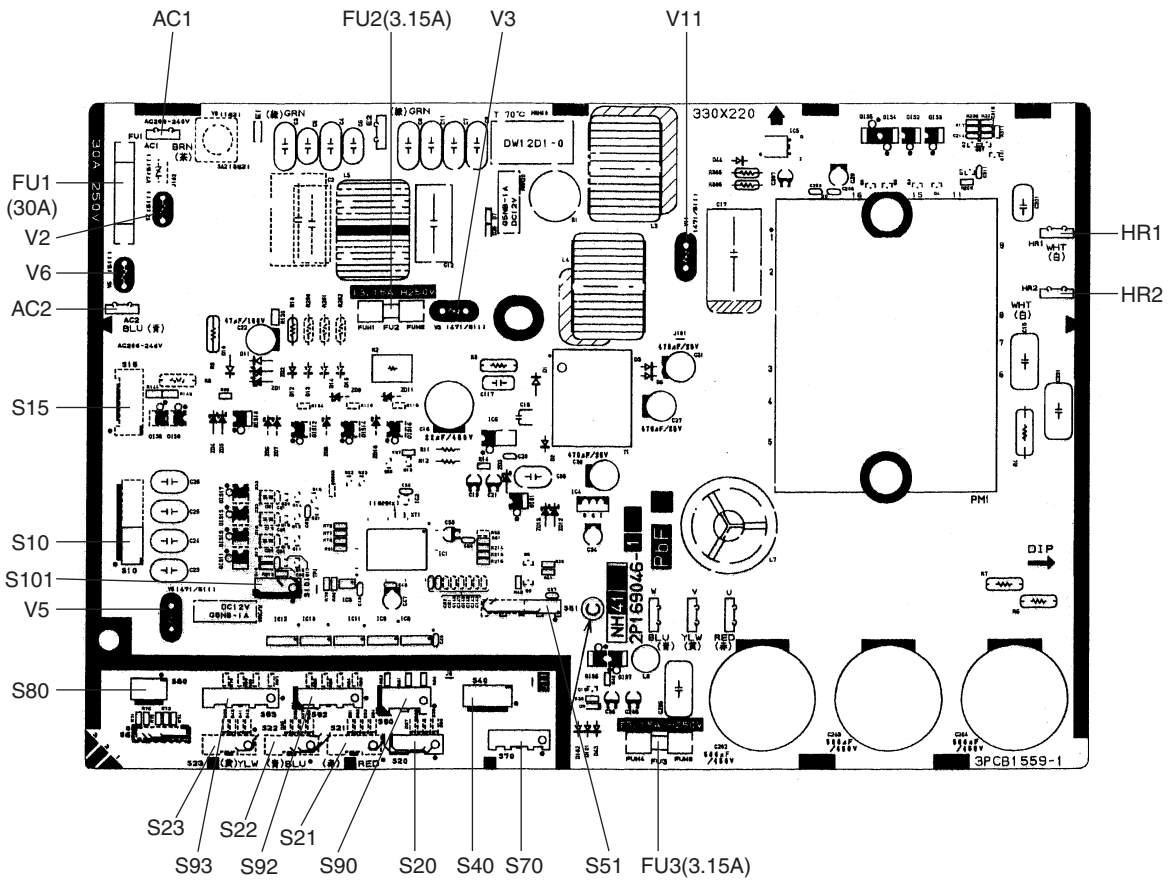

(R6041)

PCB(1): Main PCB (80-100 class models)

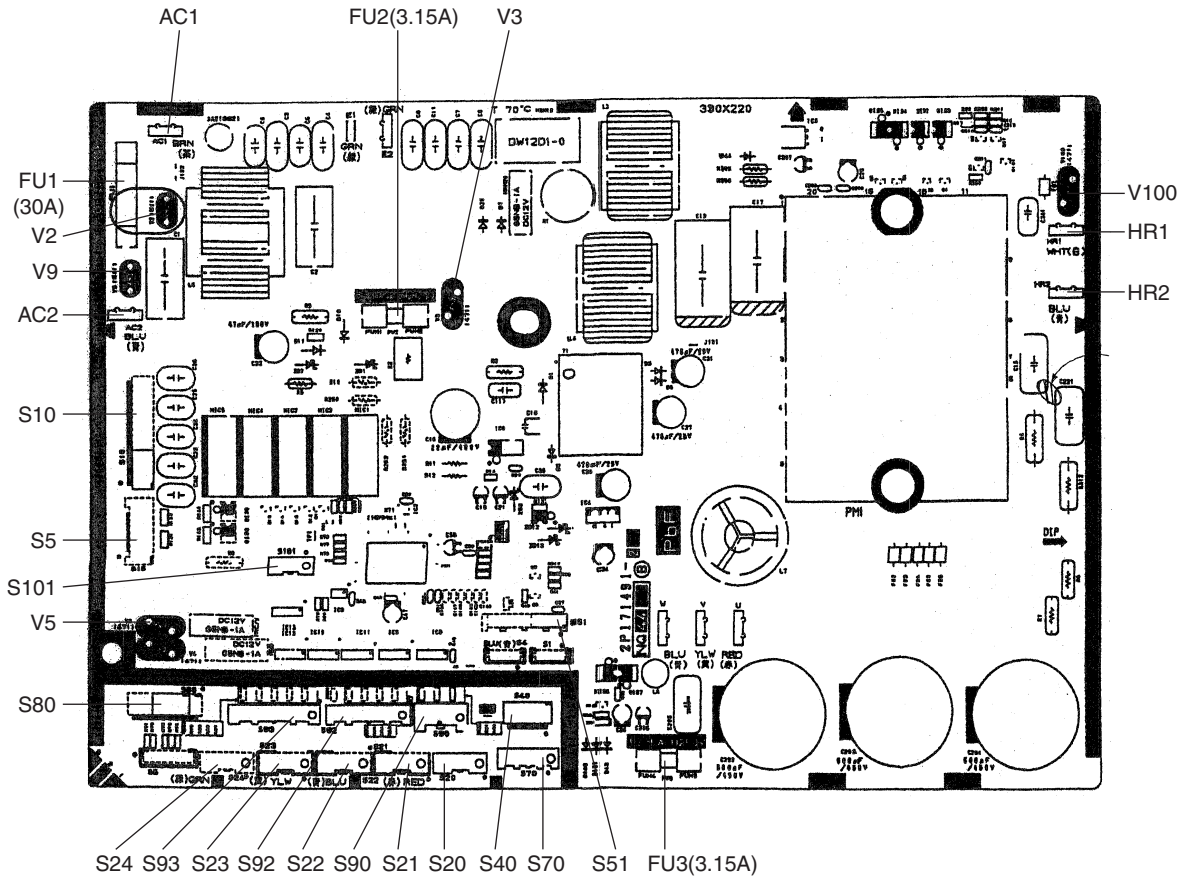

(R6060)

PCB(2): Service Monitor PCB

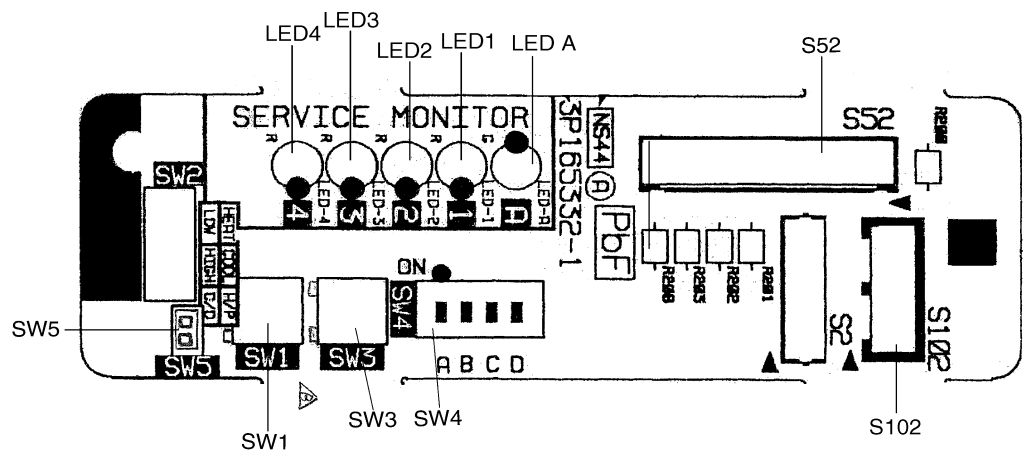

3P165332

## 1.7 Outdoor Units – E Series (68-75 Class)

---

### Connectors

#### Control PCB

1) S10	Connector for terminal strip (indoor - outdoor transmission)
2) S20	Connector for electronic expansion valve coil A port
3) S21	Connector for electronic expansion valve coil B port
4) S22	Connector for electronic expansion valve coil C port
5) S31	Connector for CN14 on SPM
6) S32	Connector for CN11 on SPM
7) S33	Connector for S34 on inverter PCB (MID2)
8) S40	Connector for overload protector
9) S51	Connector for S52 on service monitor PCB
10) S52	Connector for S51 on PCB
11) S71	Connector for S72 on inverter PCB (MID2)
12) S80	Connector for four way valve coil
13) S90	Connector for thermistors (outdoor air, heat exchanger, and discharge pipe)
14) S91	Connector for fin thermistor
15) S92	Connector for gas pipe thermistor
16) S93	Connector for liquid pipe thermistor
17) S101	Connector for S102 on service monitor PCB
18) S102	Connector for S101 on PCB1
19) AC1	Connector for HAC1 or filter PCB
20) AC2	Connector for terminal strip (power supply)
21) E	Connector for earth
22) H1, H2	Connector for diode bridge
23) LED A, LED1 to 4	Service monitor LED
24) FU2	Fuse (3.15 A)
25) V2, V5	Varistor

---

#### Filter PCB (PCB 3)

1) FU1	Fuse (30A)
2) V3	Varistor
3) HAC1	Connector for AC1 or PCB
4) HE2	Connector for earth
5) HL	Connector for terminal strip (Power supply)

---

#### Inverter PCB (MID 2)

1) S34	Connector for S33 on PCB
2) S70	Connector for fan motor
3) S72	Connector for S71 on PCB
4) FU201	Fuse (3.15A)
5) N, U, V, W	Connector for compressor

SPM

- 1) CN11 Connector for S32 on PCB
- 2) CN14 Connector for S31 on PCB
- 3) L1, L2 Connector for reactor

PCB Detail

PCB (1): Control PCB (outdoor unit)  
 PCB (2): Service monitor PCB

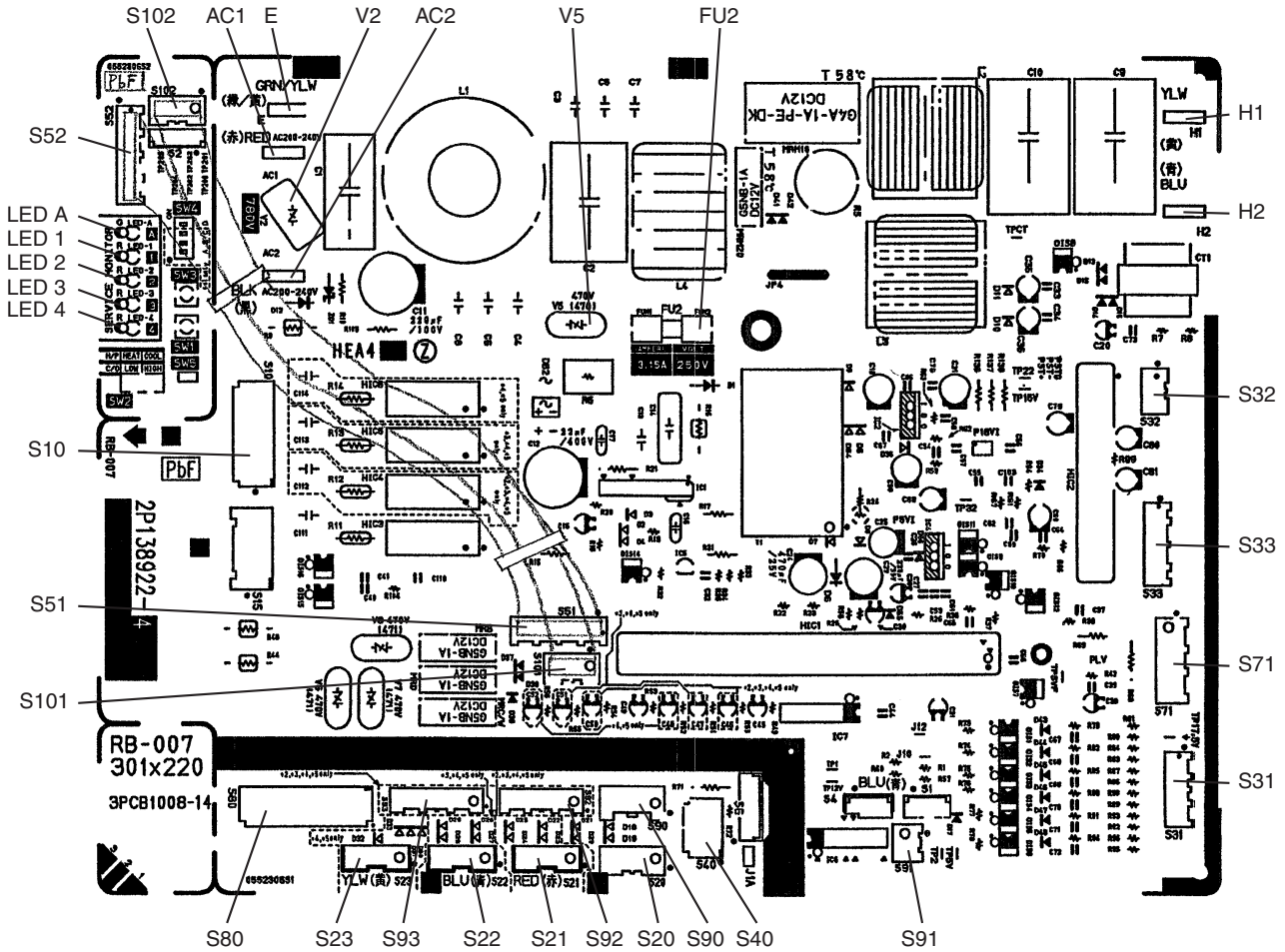

2P138922

PCB (3): Filter PCB

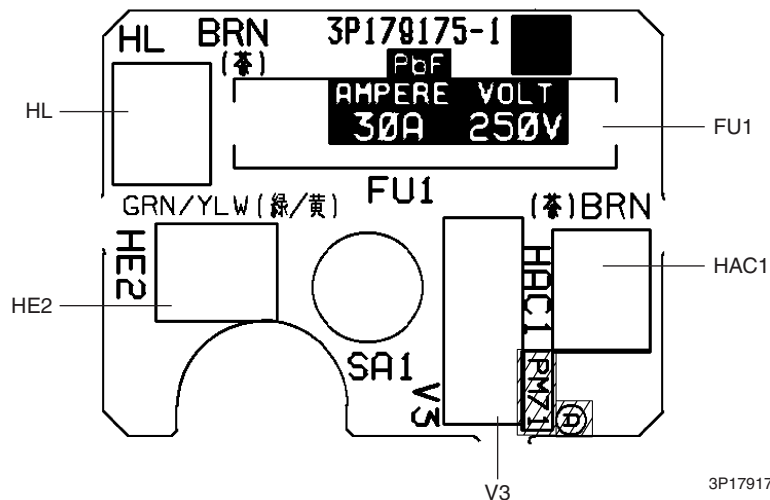

3P179175

Inverter PCB (MID2)

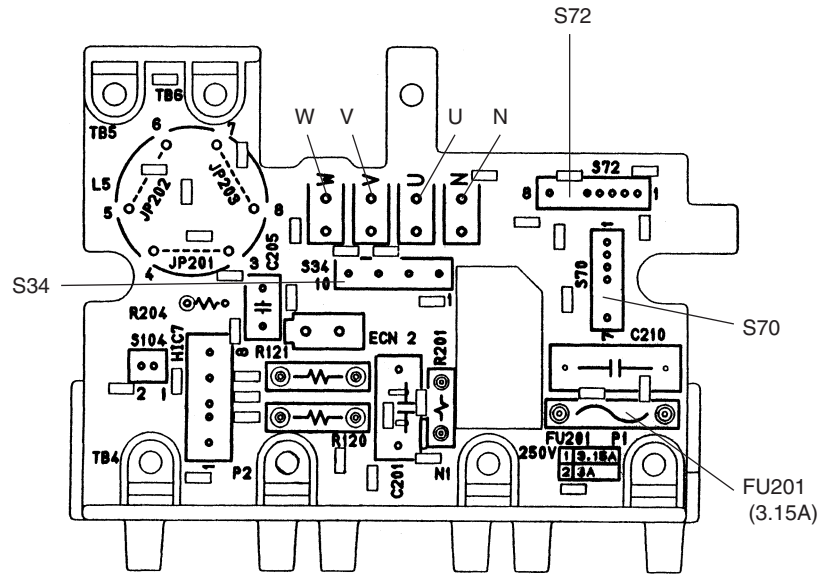

3P080085

SPM

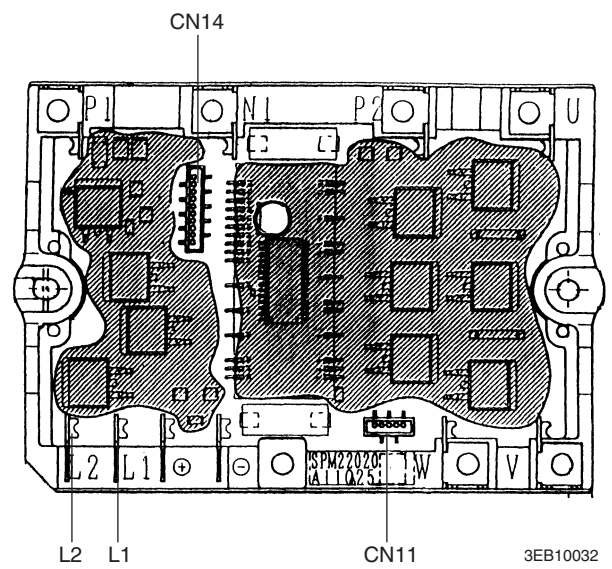

3EB10032

## 1.8 Outdoor Units – D Series

---

### Connectors

#### Control PCB

1) S10	Connector for S11 on MID1
2) S20	Connector for electronic expansion valve coil A port
3) S21	Connector for electronic expansion valve coil B port
4) S22	Connector for electronic expansion valve coil C port
5) S23	Connector for electronic expansion valve coil D port
6) S31	Connector for CN14 on SPM
7) S32	Connector for CN11 on SPM
8) S33	Connector for S34 on inverter PCB (MID2)
9) S40	Connector for overload protector
10) S51	Connector for S52 on service monitor PCB
11) S52	Connector for S51 on PCB
12) S71	Connector for S72 on inverter PCB (MID2)
13) S80	Connector for four way valve coil
14) S90	Connector for thermistors (outdoor air, heat exchanger, and discharge pipe)
15) S91	Connector for fin thermistor
16) S92	Connector for gas pipe thermistor
17) S93	Connector for liquid pipe thermistor
18) S101	Connector for S102 on service monitor PCB
19) S102	Connector for S101 on PCB
20) AC1	Connector for HL on MID1
21) AC2	Connector for HN on MID1
22) E	Connector for earth
23) H1, H2	Connector for diode bridge
24) LED A, LED1 to 4	Service monitor LED
25) FU2	Fuse (3.15 A)
26) V2, V5	Varistor

---

#### MID 1

1) S11	Connector for S10 on PCB1
2) FU1	Fuse (30A)
3) V3	Varistor
4) HE	Connector for earth
5) HL	Connector for AC1 on PCB
6) HN	Connector for AC2 on PCB

---

#### Inverter PCB (MID 2)

1) S34	Connector for S33 on PCB
2) S70	Connector for fan motor
3) S72	Connector for S71 on PCB
4) FU201	Fuse (3.15A)
5) N, U, V, W	Connector for compressor

SPM

- 1) CN11 Connector for S32 on PCB
- 2) CN14 Connector for S31 on PCB
- 3) L1, L2 Connector for reactor

PCB Detail

PCB (1): Control PCB (outdoor unit)  
 PCB (2): Service monitor PCB

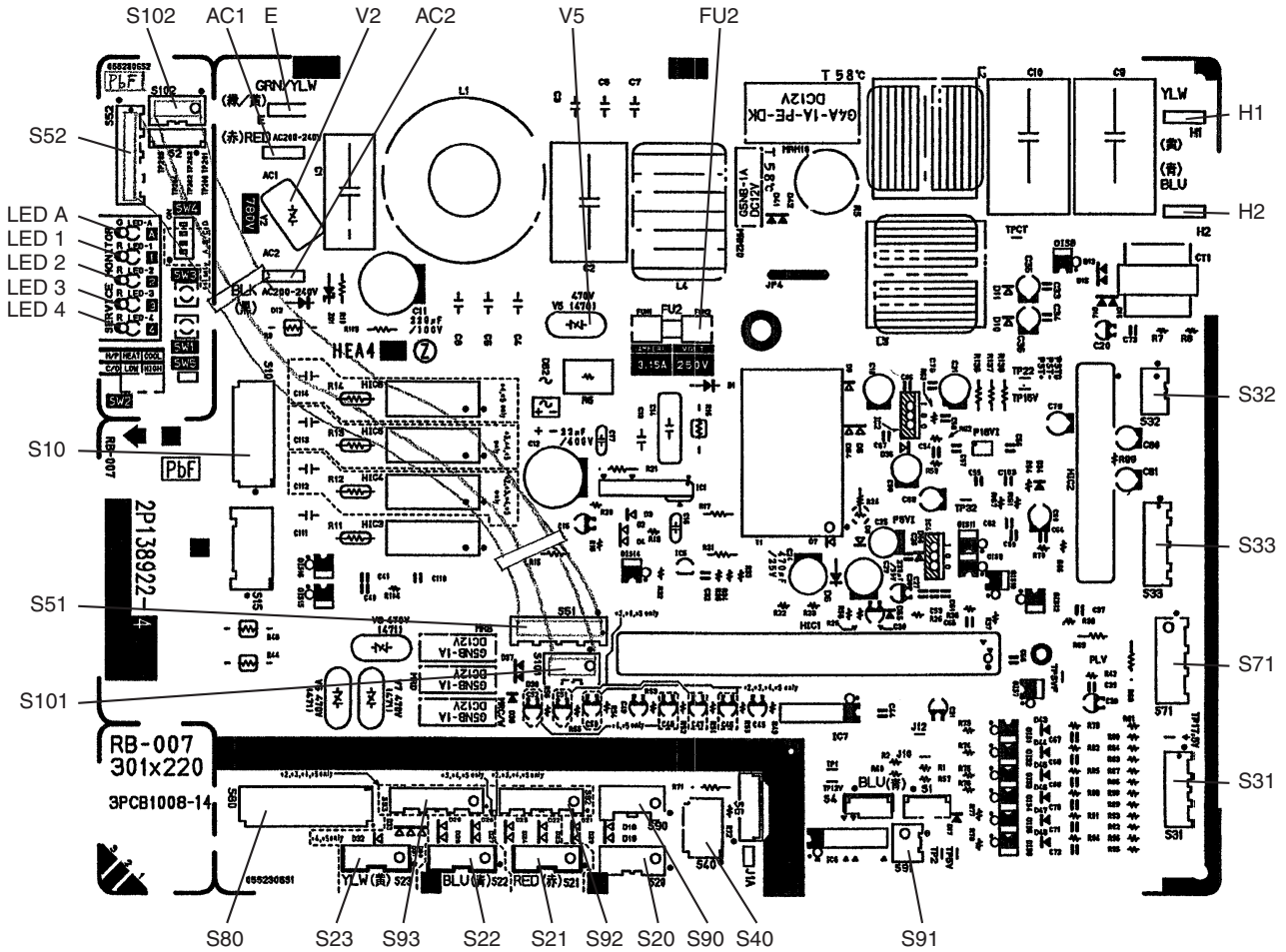

2P138922

MID1

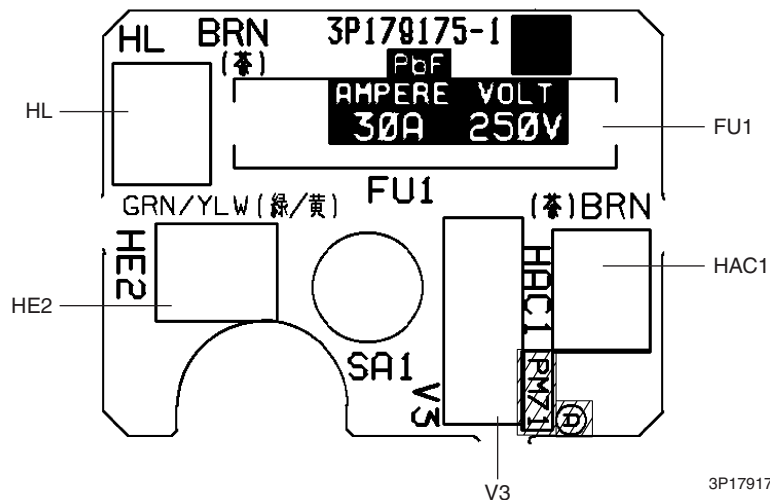

3P179175

Inverter PCB (MID2)

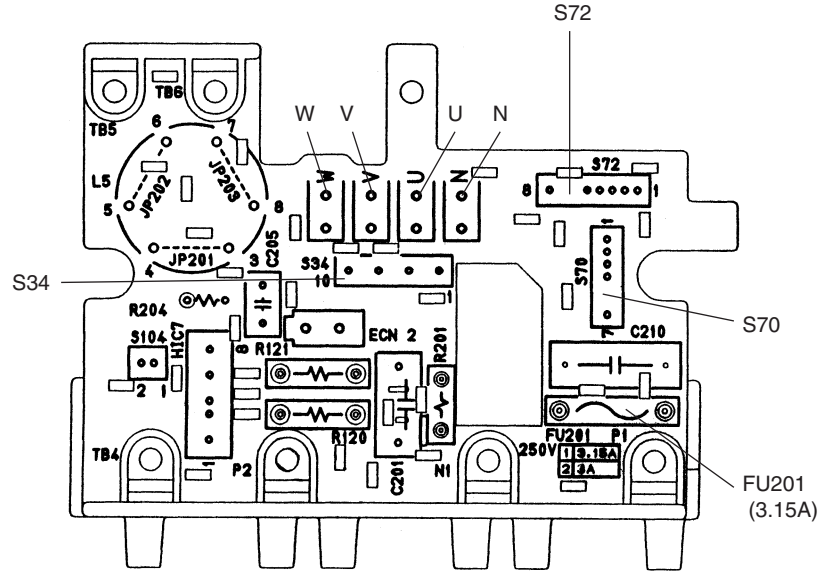

3P080085

SPM

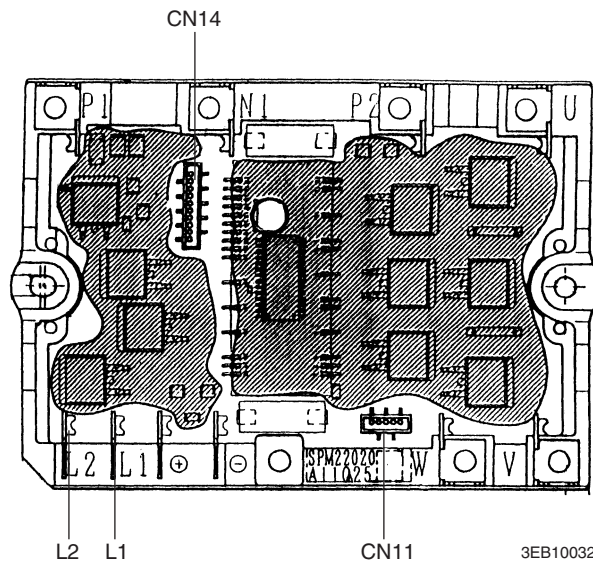

3EB10032





# Part 4

## Function and Control

1. Main Functions.....	78
1.1 Frequency Principle.....	78
1.2 Power-Airflow Dual Flaps, Wide Angle Louvers and Auto-Swing .....	80
1.3 Fan Speed Control for Indoor Units.....	81
1.4 Programme Dry Function .....	82
1.5 Automatic Operation.....	83
1.6 Thermostat Control.....	84
1.7 Night Set Mode.....	85
1.8 ECONO Mode .....	86
1.9 MOLD PROOF Operation .....	87
1.10 INTELLIGENT EYE (Wall Mounted Type Only) .....	88
1.11 HOME LEAVE Operation .....	90
1.12 Inverter POWERFUL Operation .....	91
1.13 Other Functions.....	92
2. Function of Main Structural Parts.....	94
2.1 Main Structural Parts.....	94
2.2 Function of Thermistor .....	95
3. Control Specification .....	99
3.1 Mode Hierarchy .....	99
3.2 Frequency Control.....	100
3.3 Controls at Mode Changing / Start-up.....	103
3.4 Discharge Pipe Temperature Control.....	104
3.5 Input Current Control.....	104
3.6 Freeze-up Protection Control .....	105
3.7 Heating Peak-cut Control .....	105
3.8 Fan Control.....	106
3.9 Liquid Compression Protection Function 2.....	106
3.10 Defrost Control .....	107
3.11 Low Hz High Pressure Limit .....	108
3.12 Electronic Expansion Valve Control .....	108
3.13 Malfunctions .....	112
3.14 Forced Operation Mode .....	113
3.15 Wiring-Error Check.....	114
3.16 Additional Function.....	116

# 1. Main Functions

**i** Note: See the list of functions for the functions applicable to different models.

## 1.1 Frequency Principle

### Main Control Parameters

The compressor is frequency-controlled during normal operation. The target frequency is set by the following 2 parameters coming from the operating indoor unit:

- The load condition of the operating indoor unit
- The difference between the room temperature and the set temperature

### Additional Control Parameters

The target frequency is adapted by additional parameters in the following cases:

- Frequency restrictions
- Initial settings
- Forced cooling / heating operation

### Inverter Principle

To regulate the capacity, a frequency control is needed. The inverter makes it possible to vary the rotation speed of the compressor. The following table explains the conversion principle:

Phase	Description
1	The supplied AC power source is converted into the DC power source for the present.
2	The DC power source is reconverted into the three phase AC power source with variable frequency. <ul style="list-style-type: none"> <li>■ When the frequency increases, the rotation speed of the compressor increases resulting in an increased refrigerant circulation. This leads to a higher amount of the heat exchange per unit.</li> <li>■ When the frequency decreases, the rotation speed of the compressor decreases resulting in a decreased refrigerant circulation. This leads to a lower amount of the heat exchange per unit.</li> </ul>

### Drawing of Inverter

The following drawing shows a schematic view of the inverter principle:

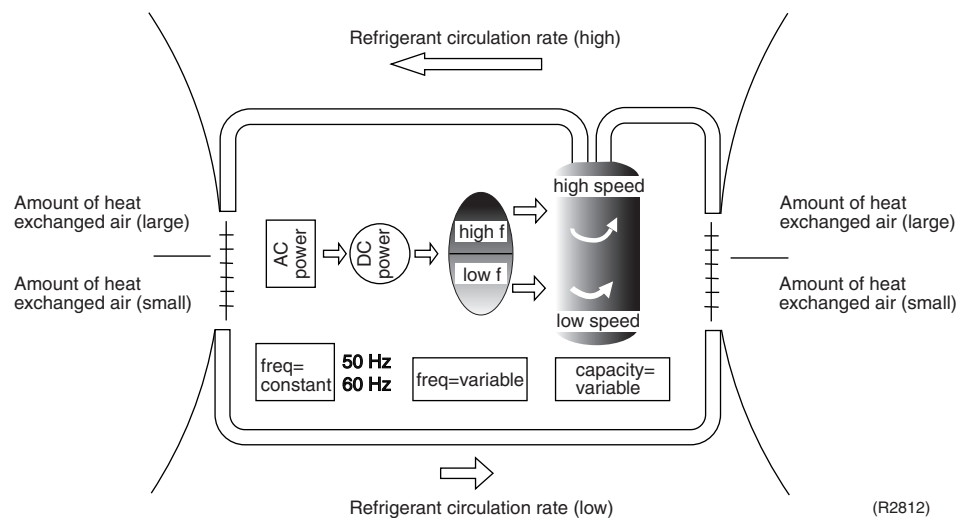

### Inverter Features

The inverter provides the following features:

- The regulating capacity can be changed according to the changes in the outdoor air temperature and cooling / heating load.
- Quick heating and quick cooling  
The compressor rotational speed is increased when starting the heating (or cooling). This enables a quick set temperature.

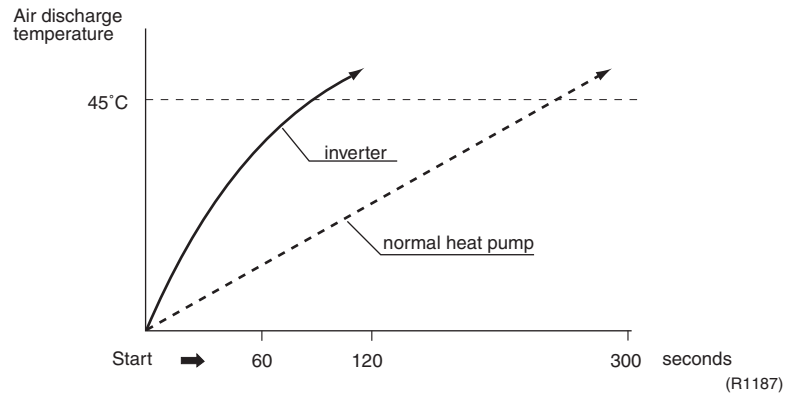

- Even during extreme cold weather, the high capacity is achieved. It is maintained even when the outdoor air temperature is 2°C.
- Comfortable air conditioning  
A detailed adjustment is integrated to ensure a fixed room temperature. It is possible to air condition with a small room temperature variation.
- Energy saving heating and cooling  
Once the set temperature is reached, the energy saving operation enables to maintain the room temperature at low power.

### Frequency Limits

The following table shows the functions that define the minimum and maximum frequency:

Frequency limits	Limited during the activation of following functions
Low	<ul style="list-style-type: none"> <li>■ Four way valve operation compensation. Refer to page 103.</li> </ul>
High	<ul style="list-style-type: none"> <li>■ Input current control. Refer to page 104.</li> <li>■ Compressor protection function. Refer to page 103.</li> <li>■ Heating Peak-cut control. Refer to page 105.</li> <li>■ Freeze-up protection. Refer to page 105.</li> <li>■ Defrost control. Refer to page 107.</li> </ul>

### Forced Cooling / Heating Operation

For more information, refer to "Forced operation mode" on page 113.

## 1.2 Power-Airflow Dual Flaps, Wide Angle Louvers and Auto-Swing

### Power-airflow Dual Flaps

The large flaps send a large volume of air downwards to the floor. The flap provides an optimum control area in cooling, heating and dry mode.

#### Heating Mode

During heating mode, the large flap enables direct warm air straight downwards. The flap presses the warm air above the floor to reach the entire room.

#### Cooling Mode

During cooling mode, the flap retracts into the indoor unit. Then, cool air can be blown far and pervaded all over the room.

### Wide-Angle Louvers

The louvers, made of elastic synthetic resin, provide a wide range of airflow that guarantees a comfortable air distribution.

### Auto-Swing

#### In case of FTK(X)S20-35D, FTK(X)S25/35E

The following table explains the auto swing process for heating, cooling, dry and fan :

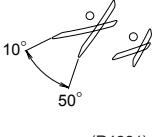
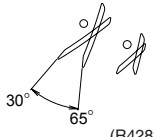
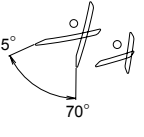
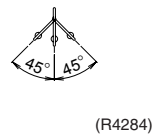
Vertical Swing (up and down)			Horizontal Swing (right and left: manual)
Cooling / Dry	Heating	Fan	
 <p>(R4281)</p>	 <p>(R4282)</p>	 <p>(R4283)</p>	 <p>(R4284)</p>

### 3-D Airflow

#### Wall Mounted Type 50-71 Class

- Alternative repetition of vertical and horizontal swing motions enables uniform air-conditioning of the entire room. This function is effective for starting the air conditioner.
- When the horizontal swing and vertical swing are both set to auto mode, the airflow become 3-D airflow and the horizontal swing and vertical swing motions are alternated. The order of swing motion is such that it turns counterclockwise, starting from the right upper point as viewed to the front side of the indoor unit.

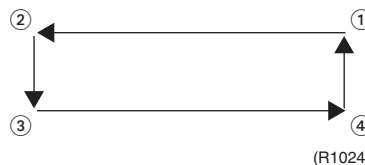

## 1.3 Fan Speed Control for Indoor Units

### Control Mode

The airflow rate can be automatically controlled depending on the difference between the set temperature and the room temperature. This is done through rotation speed control, or phase and Hall IC control.



For more information about Hall IC, refer to the troubleshooting for fan motor on page 214.

### Fan speed Steps

Phase control and fan speed control contains 9 steps: LLL, LL, SL, L, ML, M, MH, H and HH. In automatic operation, the step "SL" is not available.

Step	Wall mounted type 50-60 class		Wall mounted type 20-35 class, 71 class Duct connected type Floor standing type Floor/ceiling suspended type	
	Cooling	Heating	Cooling	Heating
LLL	 (R6037)	 (R6036)	 (R6037)	 (R6036)
LL				
L				
ML				
M				
MH				
H				
HH (Powerful)	H+90	H+90	H+50	H+50

= Within this range the airflow rate is automatically controlled when the FAN setting button is set to automatic.



### Note:

1. Fan stops during defrost operation.
2. In time of thermostat OFF, the fan rotates at the following speed.  
Cooling : The fan keeps rotating at the set tap.  
Heating : The fan stops.

### Automatic Air Flow Control for Heating

On heating mode, the indoor fan speed will be regulated according to the indoor heat exchanger temperature and the difference between the room temperature and the required set point.

### Automatic Air Flow Control for Cooling

The following drawing explains the principle of fan speed control for cooling:

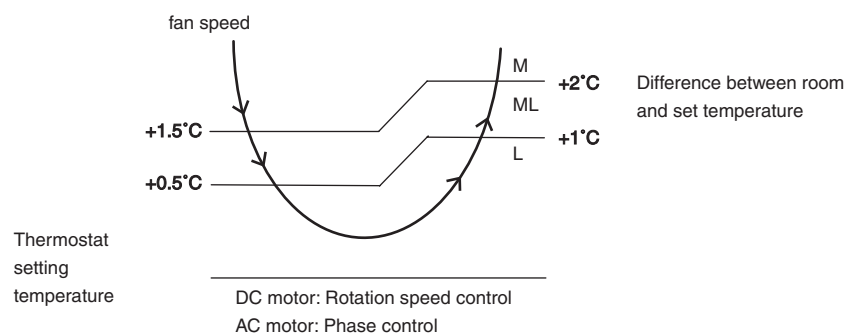

## 1.4 Programme Dry Function

Programme dry function removes humidity while preventing the room temperature from lowering.

Since the microcomputer controls both the temperature and air flow volume, the temperature adjustment and fan adjustment buttons are inoperable in this mode.

### In Case of Inverter Units

The microcomputer automatically sets the temperature and fan settings. The difference between the room temperature at startup and the temperature set by the microcomputer is divided into two zones. Then, the unit operates in the dry mode with an appropriate capacity for each zone to maintain the temperature and humidity at a comfortable level.

Room temperature at startup	Set temperature X	Thermostat OFF point Y	Thermostat ON point Z
24°C or more	Room temperature at startup	X - 2.5°C	X - 0.5°C or Y + 0.5°C (zone B) continues for 10 min.
23.5°C ∴ 18°C		X - 2.0°C	X - 0.5°C or Y + 0.5°C (zone B) continues for 10 min.
17.5°C ∴	18°C	X - 2.0°C	X - 0.5°C = 17.5°C or Y + 0.5°C (zone B) continues for 10 min.

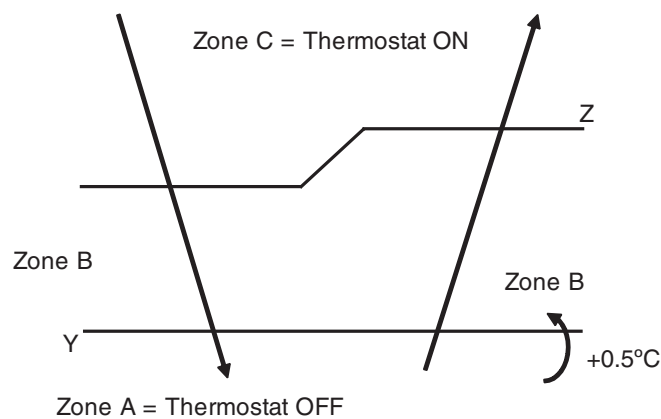

(R6841)

## 1.5 Automatic Operation

### Automatic Cooling / Heating Function (Heat Pump Only)

When the AUTO mode is selected with the remote controller, the microcomputer automatically determines the operation mode from cooling and heating according to the room temperature and setting temperature at the time of the operation startup, and automatically operates in that mode.

The unit automatically switches the operation mode to cooling or heating to maintain the room temperature at the main unit setting temperature.

#### Detailed Explanation of the Function

1. Remote controller setting temperature is set as automatic cooling / heating setting temperature (18 to 30°C).
2. Main unit setting temperature equals remote controller setting temperature.
3. Operation ON / OFF point and mode switching point are as follows.
  - ① Heating → Cooling switching point:  
Room temperature  $\geq$  Main unit setting temperature +2.5 deg.
  - ② Cooling → Heating switching point:  
Room temperature  $<$  Main unit setting temperature -2.5 deg.
  - ③ Thermostat ON / OFF point is the same as the ON / OFF point of cooling or heating operation.
4. During initial operation
  - Room temperature  $\geq$  Remote controller setting temperature: Cooling operation
  - Room temperature  $<$  Remote controller setting temperature: Heating operation

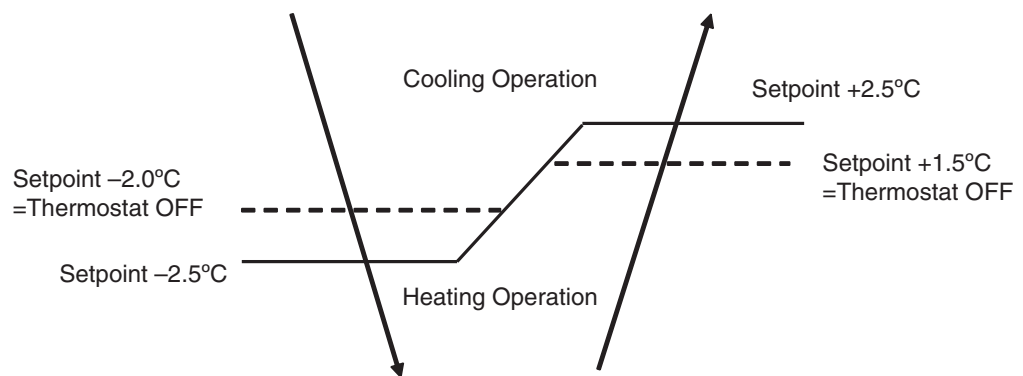

(R6842)

Ex: When the set point is 25°C

Cooling Operation → 23°C: Thermostat OFF → 22°C: Switch to Heating Operation

Heating Operation → 26.5°C: Thermostat OFF → 27.5°C: Switch to Cooling Operation



## 1.6 Thermostat Control

Thermostat control is based on the difference between the room temperature and the setpoint.

### Thermostat OFF Condition

- ◆ The temperature difference is in the zone A.

### Thermostat ON Condition

- ◆ The temperature difference is above the zone C after being in the zone A.
- ◆ The system resumes from defrost control in any zones except A.
- ◆ The operation turns on in any zones except A.
- ◆ The monitoring time has passed while the temperature difference is in the zone B.  
(Cooling / Dry : 10 minutes, Heating : 10 seconds)

### Cooling / Dry

- ◆ Wall Mounted Type

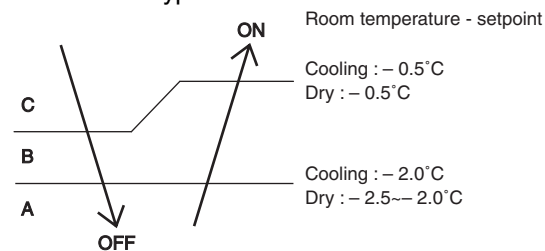

(R4668)

- ◆ Floor standing Type
- ◆ Floor/Ceiling suspended Type
- ◆ Duct Connected Type

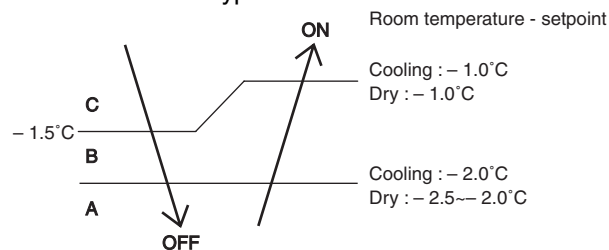

(R6032)

### Heating

- ◆ Wall Mounted Type

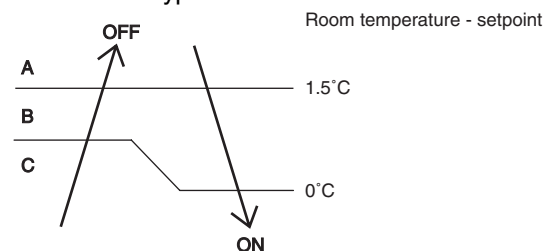

(R4669)

- ◆ Floor standing Type
- ◆ Floor/Ceiling suspended Type
- ◆ Duct Connected Type

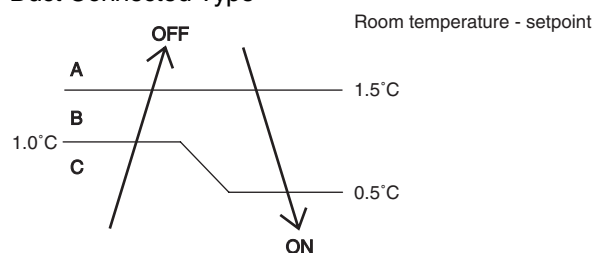

(R6033)

## 1.7 Night Set Mode

When the OFF timer is set, the Night Set circuit automatically activates. The Night Set circuit maintains the airflow setting made by users.

### The Night Set Circuit

The Night Set circuit continues heating or cooling the room at the set temperature for the first one hour, then automatically raises the temperature setting slightly in the case of cooling, or lowers it slightly in the case of heating, for economical operations. This prevents excessive heating in winter and excessive cooling in summer to ensure comfortable sleeping conditions, and also conserves electricity.

### Cooling Operation

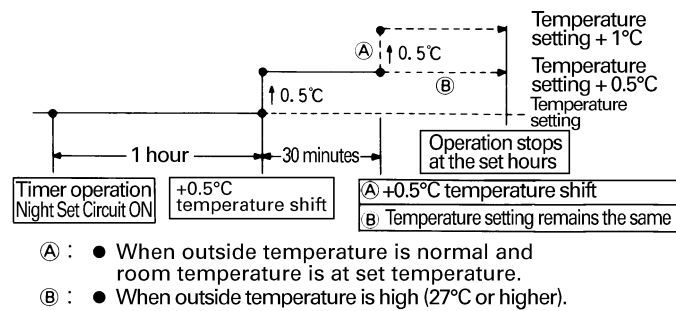

(R1361)

In case of FTK(X)S25-35E, FTK(X)S20-35D, FTK(X)S50-71F the temperature rises once.

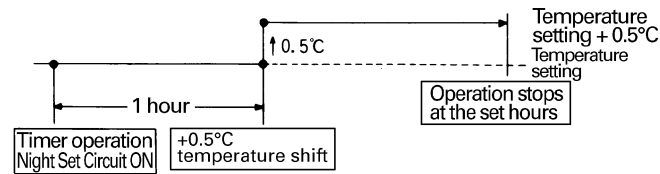

(R4421)

### Heating Operation

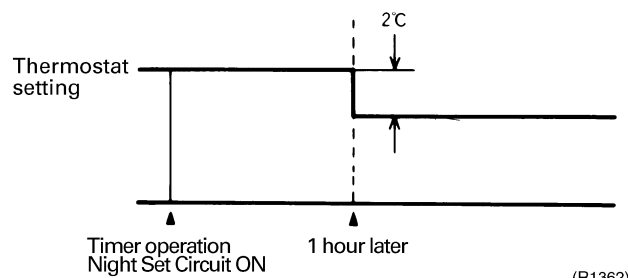

(R1362)

## 1.8 ECONO Mode

### Outline

#### FTK(X)S20-35D, FTK(X)S25/35E

The "ECONO mode" reduces the maximum operating current and power consumption by approx. 30% during start up etc..

This mode is particularly convenient for energy-saving-oriented users. It is also a major bonus for those whose breaker capacities do not allow the use of multiple electrical devices and air conditioners.

It is easily activated from the wireless remote controller by pushing the ECONO button.

- When this function is ON, the maximum capacity is also down. (Approx. 20%)
- This function can only be set when the unit is running. Pressing the operation stop button causes the settings to be canceled.
- This function and POWERFUL operation cannot be used at the same time. The latest command has the priority.

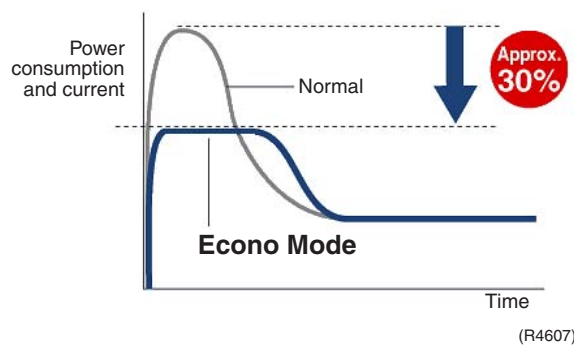

### Details

- ECONO mode can be activated while the unit is running. The remote controller can send the ECONO command when the unit is in COOL, HEAT, DRY, or AUTO operation.
- When the ECONO command is valid, the upper limit of frequency is restricted.

Refer to page 117 for "ECONO-mode-proof setting".

## 1.9 MOLD PROOF Operation

### FTK(X)S20-35D, FTK(X)S25/35E

MOLD PROOF operation is a function which reduces the spread of mold by using Fan mode to lower the humidity inside the indoor unit.

---

#### Outline

MOLD PROOF operation starts when the following conditions are met.

1. MOLD PROOF is set on the remote controller.
  2. Cooling or dry operation stops.
- ◆ MOLD PROOF operation will operate for approximately one hour after dry or cooling mode is turned off.
  - ◆ The indoor fan rotates at 550 rpm.

**Note:**

1. This function is not designed to remove existing dust or mold.
2. MOLD PROOF operation is not available when the unit is turned off using the OFF TIMER.

## 1.10 INTELLIGENT EYE (Wall Mounted Type Only)

This is the function that detects existence of humans in the room by a human motion sensor (INTELLIGENT EYE) and reduces the capacity when there is no human in the room in order to save electricity.

### Processing

#### 1. Detection method by Intelligent Eye

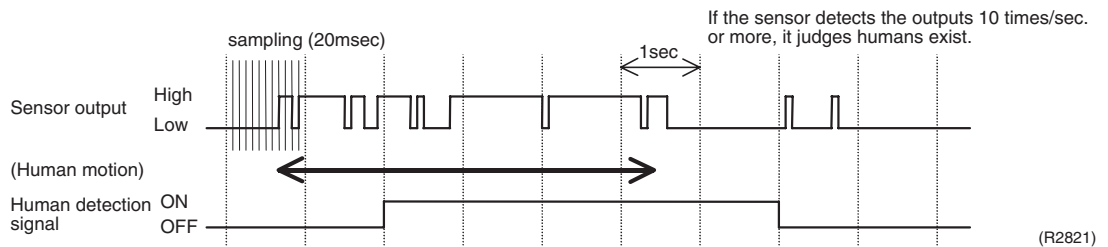

- This sensor detects human motion by receiving infrared rays and displays the pulse wave output.
- A microcomputer in an indoor unit carries out a sampling every 20 msec. and if it detects 10 cycles of the wave in one second in total (corresponding to  $20\text{msec.} \times 10 = 100\text{msec.}$ ), it judges human is in the room as the motion signal is ON.

#### 2. The motions (for example: in cooling)

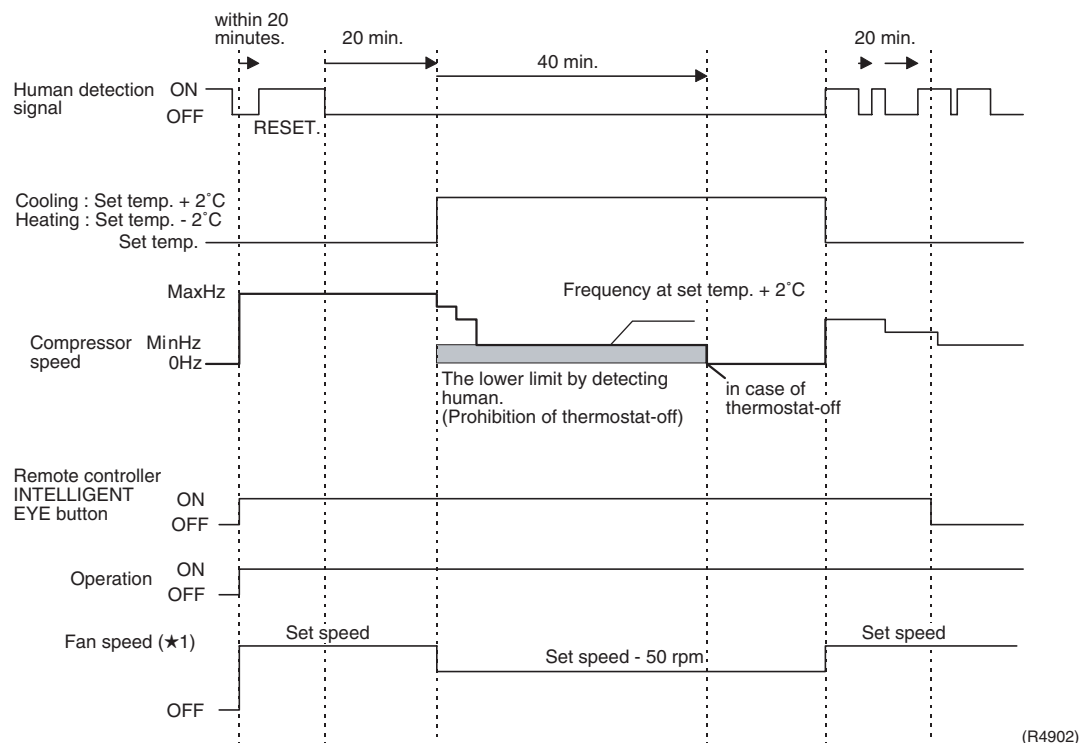

- When a microcomputer doesn't have a signal from the sensor in 20 minutes, it judges that nobody is in the room and operates the unit in temperature shifted 2°C from the set temperature. (Cooling/Dry : 2°C higher, Heating : 2°C lower and Auto : according to the operation mode at that time.)
- ★1 In case of Fan mode, the fan speed reduces by 50 rpm.

- Since the set temperature is shifted by 2°C higher for 40 minutes, compressor speed becomes low and can realize energy saving operation. But as thermostat is prone to be off by the fact that the set temperature has been shifted, the thermostat-off action is prohibited in 40 minutes so as to prevent this phenomena.  
After this 40 minutes, the prohibition of the thermostat-off is cancelled and it can realize the conditions to conduct thermostat-off depending on the room temperature. In or after this 40 minutes, if the sensor detects human motion detection signal, it let the set temperature and the fan speed return to the original set point, keeping a normal operation.

---

**Others**

- The dry operation can't command the setting temperature with a remote controller, but internally the set temperature is shifted by 1°C.

## 1.11 HOME LEAVE Operation

### Outline

In order to respond to the customer's need for immediate heating and cooling of the room after returning home or for house care, a measure to switch the temperature and air volume from that for normal time over to outing time by one touch is provided. (This function responds also to the need for keeping up with weak cooling or heating.)

This time, we seek for simplicity of operation by providing the special temperature and air volume control for outing to be set by the exclusive button.

### Detail of the Control

#### 1. Start of Function

The function starts when the [HOME LEAVE] button is pressed in cooling mode or heating mode (including stopping and powerful operation). If this button is pressed while the operation is stopped, the function becomes effective when the operation is started. If this button is pressed in powerful operation, the powerful operation is reset and this function becomes effective.

- The [HOME LEAVE] button is ineffective in dry mode and fan mode.

#### 2. Details of Function

A mark representing [HOME LEAVE] is indicated on the liquid crystal display of the remote controller. The indoor unit is operated according to the set temperature and air volume for HOME LEAVE which were pre-set in the memory of the remote controller.

The LED (Red) of indoor unit representing [HOME LEAVE] lights up. (It goes out when the operation is stopped.)

#### 3. End of Function

The function ends when the [HOME LEAVE] button is pressed again during [HOME LEAVE] operation or when the powerful operation button is pressed.

#### Scene <cooling>

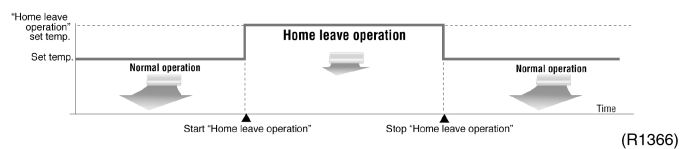

#### Scene <Heating>

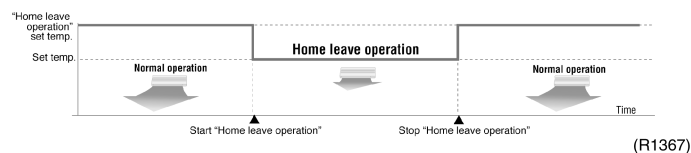
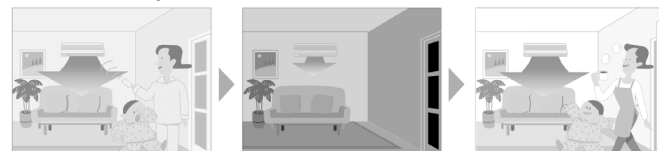

### Others

The set temperature and set air volume are memorized in the remote controller. When the remote controller is reset due to replacement of battery, it is necessary to set the temperature and air volume again for [HOME LEAVE].

## 1.12 Inverter POWERFUL Operation

### Outline

In order to exploit the cooling and heating capacity to full extent, operate the air conditioner by increasing the indoor fan rotating speed and the compressor frequency.

### Details of the Control

When POWERFUL button is pushed in each operation mode, the fan speed / setting temperature will be converted to the following states in a period of twenty minutes.

#### In case of FTK(X)S20-35D, FTK(X)S25/35E

Operation mode	Fan speed	Target set temperature
COOL	H tap + 50 rpm	18°C
DRY	Dry rotating speed + 50 rpm	Normally targeted temperature in dry operation; Approx. -2°C
HEAT	H tap + 50 rpm	30°C
FAN	H tap + 50 rpm	—
AUTO	Same as cooling / heating in POWERFUL operation	The target is kept unchanged

Ex.) : POWERFUL operation in cooling mode.

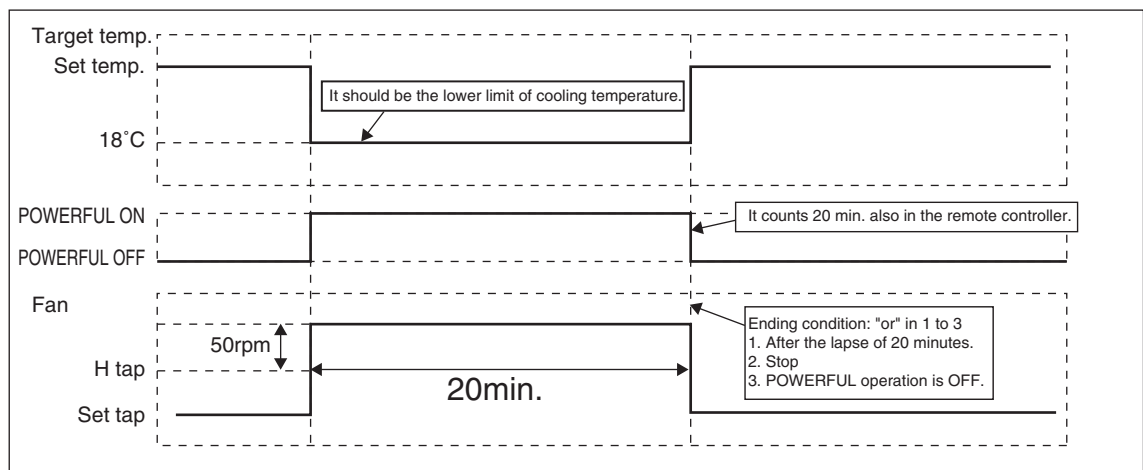

(R4560)



Refer to "Fan Speed control" on page 81 for detail.



## 1.13 Other Functions

### 1.13.1 Hot Start Function

#### Heat Pump Only

In order to prevent the cold air blast that normally comes when heating is started, the temperature of the heat exchanger of the indoor unit is detected, and either the air flow is stopped or is made very weak thereby carrying out comfortable heating of the room.

\*The cold air blast is also prevented using a similar control when the defrosting operation is started or when the thermostat gets turned ON.

### 1.13.2 Signal Receiving Sign

When the indoor unit receives a signal from the remote controller, the unit emits a signal receiving sound.

### 1.13.3 ON/OFF Button on Indoor Unit

An ON/OFF button is provided on the front panel of the unit. Use this button when the remote controller is missing or if its battery has run out.

Every press of the button switches from ON to OFF or from OFF to ON.

**In case of FTK(X)S20-35D, FTK(X)S25/35E**

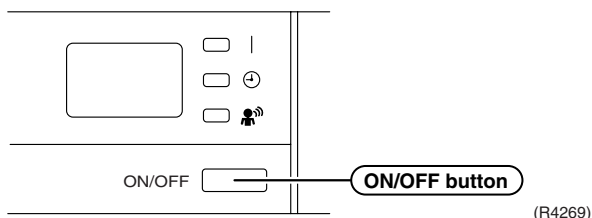

- Push this button once to start operation. Push once again to stop it.
- This button is useful when the remote controller is missing.
- The operation mode refers to the following table.

	Mode	Temperature setting	Air flow rate
Cooling Only	COOL	22°C	AUTO
Heat Pump	AUTO	25°C	AUTO

- In the case of multi system operation, there are times when the unit does not activate with this button.

#### <Forced operation mode>

Forced operation mode will be set by pressing the ON/OFF button for between 5 to 9 sec. while the unit is not operating.



**Note:** When the ON/OFF button is pressed for 10 sec. or more, the operation will be stopped. See page 113 for the detail of "Forced Operation Mode".

### 1.13.4 Titanium Apatite Photocatalytic Air-Purifying Filter

**For FTK(X)S20-35D, FTK(X)S25/35E, FTK(X)S50-71F**

This filter combines the Air Purifying Filter and Titanium Apatite Photocatalytic Deodorizing Filter in a single highly effective unit. The filter traps microscopic particles, decompose odours and even deactivates bacteria and viruses. It lasts for three years without replacement if washed about once every six months.

### 1.13.5 Photocatalytic Deodorizing Filter

**For FLXS25-60B, FVXS35/50B**

Photocatalytic Deodorizing Filter demonstrates powerful oxidation characteristics when subjected to harmless ultraviolet light. Photocatalytic deodorizing power is recovered simply by exposing the filter to the sun for 6 hours once every 6 months.

### 1.13.6 Air-Purifying Filter

**For FLXS25-60B, FVXS35/50B**

A double structure made up of a bacteriostatic filter and an Air-Purifying Filter traps dust, mildew, mites, tobacco smoke, and allergy-causing pollen. Replace the Air-Purifying Filter once every 3 months.

### 1.13.7 Air Purifying Filter with Photocatalytic Deodorizing Function

**For FTKS50-71B, FTK(X)S50-71D**

This filter incorporates the benefits the Air Purifying Filter and Photocatalytic Deodorizing Filter in a single unit. Combining the two filters in this way increases the active surface area of the new filter. This larger surface area allows the filter to effectively trap microscopic particles, decompose odours and deactivate bacteria and viruses even for the high volume of air required to air-condition large living rooms. The filter can be used for approximately 3 years if periodic maintenance is performed.

### 1.13.8 Mold Proof Air Filter (Prefilter)

**For all indoor units**

The filter net is treated with mold resisting agent TBZ (harmless, colorless, and odorless). Due to this treatment, the amount of mold growth is much smaller than that of normal filters.

### 1.13.9 Self-Diagnosis Digital Display

The microcomputer continuously monitors main operating conditions of the indoor unit, outdoor unit and the entire system. When an abnormality occur, the LCD remote controller displays error code. These indications allow prompt maintenance operations.

### 1.13.10 Auto-restart Function

Even if a power failure (including one for just a moment) occurs during the operation, the operation restarts in the condition before power failure automatically when power is restored. (Note) It takes 3 minutes to restart the operation because the 3 minute stand-by function is activated.

## 2. Function of Main Structural Parts

### 2.1 Main Structural Parts

#### Heat Pump Model

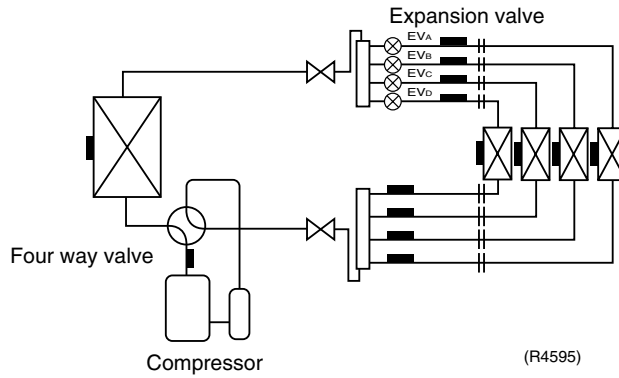

#### Cooling Only Model

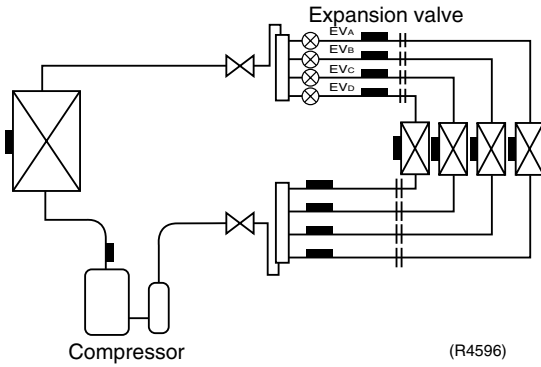

**Note:** Expansion Valve : In Case of 2 port model.....EVA-B, 3 port model.....EVA-C, 4 port model.....EVA-D

## 2.2 Function of Thermistor

### 2.2.1 Heat Pump Model

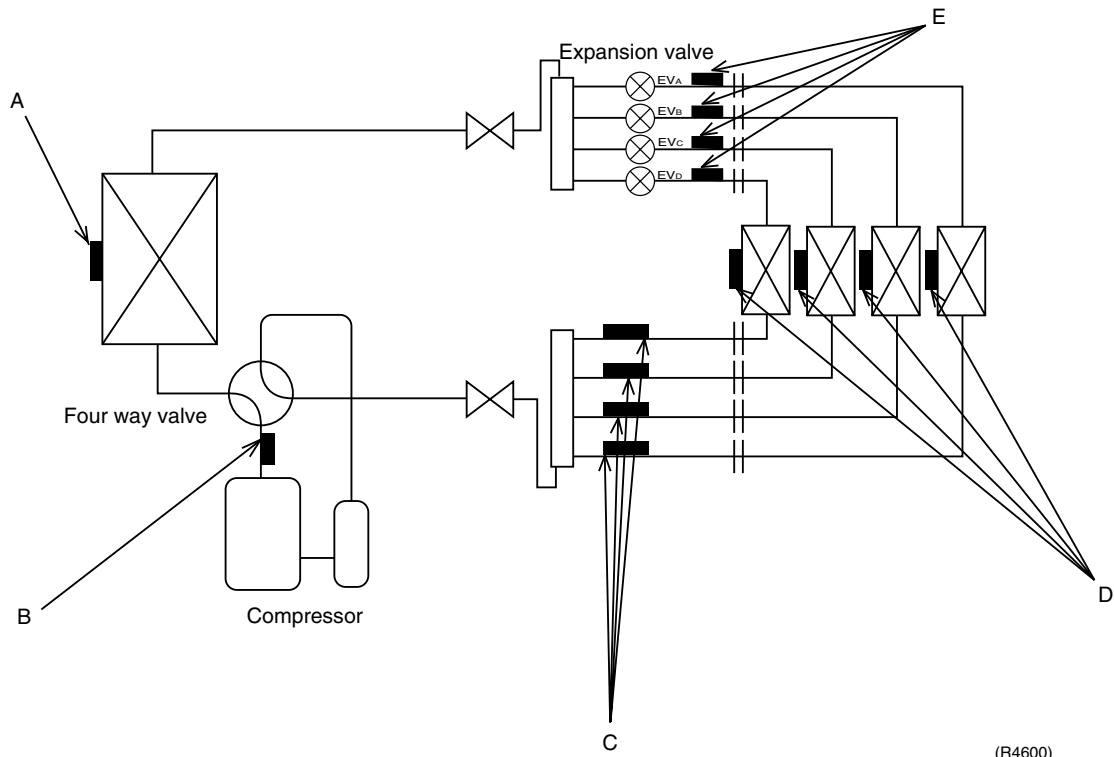

#### A Outdoor Heat Exchanger Thermistor

1. The outdoor heat exchanger thermistor is used for controlling target discharge temperature. The system sets a target discharge temperature according to the outdoor and indoor heat exchanger temperature, and controls the electronic expansion valve opening so that the target discharge temperature can be obtained.
2. The outdoor heat exchanger thermistor is used for detecting disconnection of the discharge thermistor when cooling.  
When the discharge pipe temperature becomes lower than the outdoor heat exchanger temperature, the discharge pipe thermistor is judged as disconnected.

#### B Discharge Pipe Thermistor

1. The discharge pipe thermistor is used for controlling temperature of the discharge pipe. If the temperature of discharge pipe (used in place of the inner temperature of the compressor) rises abnormally, the operating frequency drops or the operation halts.
2. The discharge pipe thermistor is used for detecting disconnection of the discharge thermistor.

#### C Gas Pipe Thermistor

1. In cooling, the gas pipe thermistors are used for gas pipe isothermal control. The system controls electronic expansion valve opening so that gas pipe temperature in each room becomes equal.

---

#### D Indoor Heat Exchanger Thermistor

1. The indoor heat exchanger thermistors are used for controlling target discharge temperature.  
The system sets a target discharge pipe temperature according to the outdoor and indoor heat exchanger temperature, and controls the electronic expansion valve opening so that the target discharge temperature can be obtained.
2. The indoor heat exchanger thermistors are used for preventing freezing.  
During the cooling operation, if the temperature drops abnormally, the operating frequency becomes lower, then the operation halts.
3. The indoor heat exchanger thermistors are used for anti-icing control.  
During the cooling operation, if the heat exchanger temperature in the room where operation is halted becomes  $-1^{\circ}\text{C}$ , or if the room temperature - heat exchanger temperature in the room where operation is halted becomes  $\geq 10^{\circ}\text{C}$ , it is assumed as icing.
4. During heating: the indoor heat exchanger thermistors are used for detecting disconnection of the discharge pipe thermistor.  
When the discharge pipe temperature becomes lower than the indoor heat exchanger temperature, the discharge pipe thermistor is judged as disconnected.  
The indoor heat exchanger thermistors are also used for preventing abnormal high pressure.
5. The indoor heat exchanger thermistors are used for detecting incorrect wiring.  
During checking incorrect wiring, refrigerant is passed in order from the port A to detect a heat exchanger temperature, and then wiring and piping will be checked.
6. The indoor heat exchanger thermistors are used for sub-cooling control.  
The actual sub-cooling is calculated from the liquid pipe temperature and the heat exchanger temperature. The system controls the electronic expansion valve opening to reach the target sub-cooling.
7. The indoor heat exchanger thermistors are used for heating isothermal control of heat exchanger.  
When heating: if the difference in temperature of each room is greater than  $8^{\circ}\text{C}$ , the electronic expansion valve of the room in which the temperature is higher is opened.

---

#### E Liquid Pipe Thermistor

1. In heating, the liquid pipe thermistors are used for sub-cooling control.  
The system calculates the actual sub-cooling with the liquid pipe temperature and the maximum heat exchanger temperature among all rooms, and controls the opening of the electronic expansion valve to reach the target sub-cooling.

## 2.2.2 Cooling Only Model

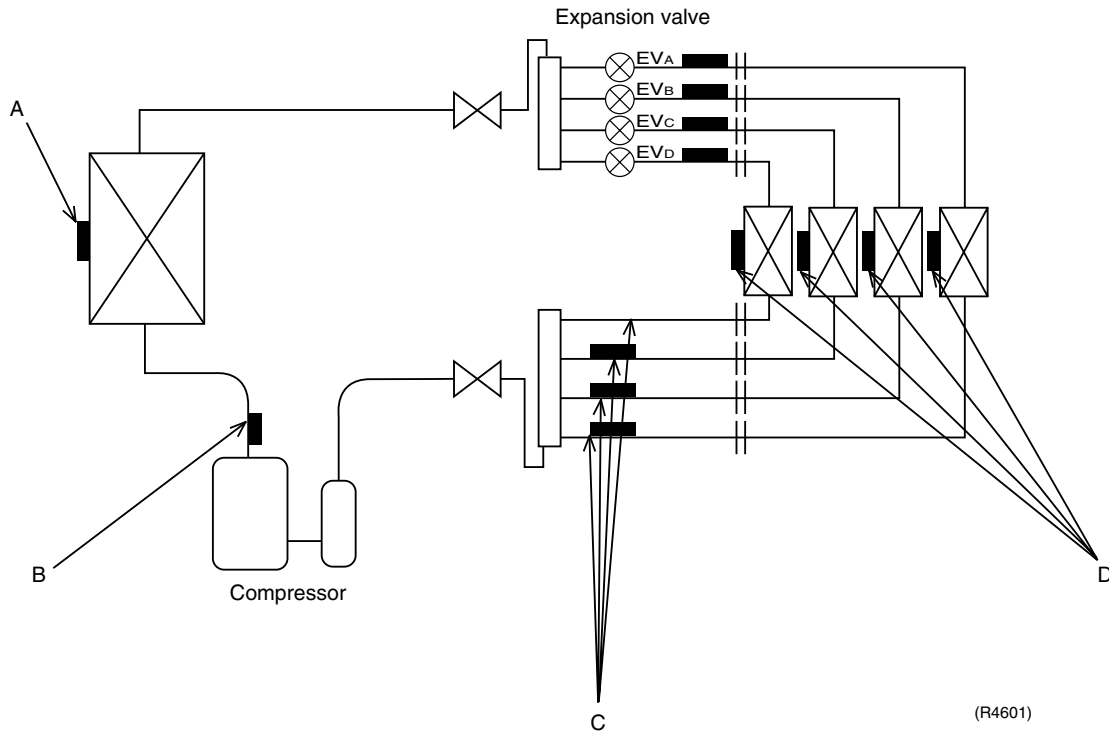

### A Outdoor Heat Exchanger Thermistor

1. The outdoor heat exchanger thermistor is used for controlling target discharge temperature. The system sets a target discharge temperature according to the outdoor and indoor heat exchanger temperature, and controls the electronic expansion valve opening so that the target discharge temperature can be obtained.
2. The outdoor heat exchanger thermistor is used for detecting disconnection of the discharge thermistor when cooling. When the discharge pipe temperature becomes lower than the outdoor heat exchanger temperature, the discharge pipe thermistor is judged as disconnected.

### B Discharge Pipe Thermistor

1. The discharge pipe thermistor is used for controlling temperature of the discharge pipe. If the temperature of discharge pipe (used in place of the inner temperature of the compressor) rises abnormally, the operating frequency drops or the operation halts.
2. The discharge pipe thermistor is used for detecting disconnection of the discharge thermistor.

### C Gas Pipe Thermistor

1. In cooling, the gas pipe thermistors are used for gas pipe isothermal control. The system controls electronic expansion valve opening so that gas pipe temperature in each room becomes equal.

**D Indoor Heat Exchanger Thermistor**

1. The indoor heat exchanger thermistors are used for controlling target discharge temperature.  
The system sets a target discharge pipe temperature according to the outdoor and indoor heat exchanger temperature, and controls the electronic expansion valve opening so that the target discharge temperature can be obtained.
2. The indoor heat exchanger thermistors are used for preventing freezing.  
During the cooling operation, if the temperature drops abnormally, the operating frequency becomes lower, then the operation halts.
3. The indoor heat exchanger thermistors are used for anti-icing control.  
During the cooling operation, if the heat exchanger temperature in the room where operation is halted becomes  $-1^{\circ}\text{C}$ , or if the room temperature - heat exchanger temperature in the room where operation is halted becomes  $\geq 10^{\circ}\text{C}$ , it is assumed as icing.
4. The indoor heat exchanger thermistors are used for detecting incorrect wiring.  
During checking incorrect wiring, refrigerant is passed in order from the port A to detect a heat exchanger temperature, and then wiring and piping will be checked.

## 3. Control Specification

### 3.1 Mode Hierarchy

#### Outline

There are two modes; the mode selected in user's place (normal air conditioning mode) and forced operation mode for installation and providing service.

#### Detail

##### 1. For heat pump model

There are following modes; stop, cooling (includes drying), heating (include defrosting)

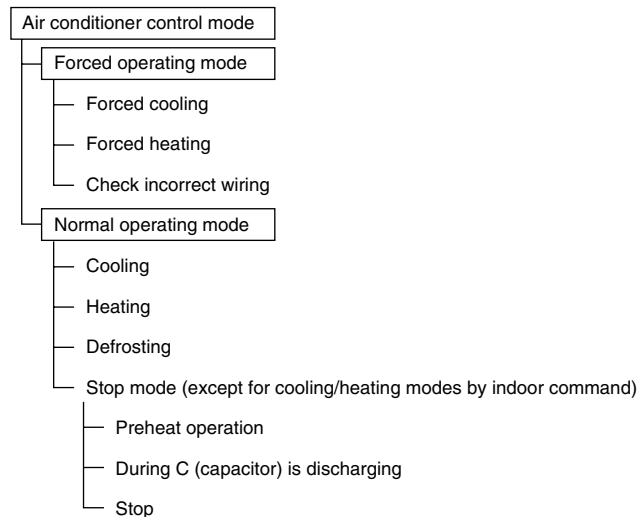

(R1373)

##### 2. For cooling only model

There are following models; stop and cooling (including drying).

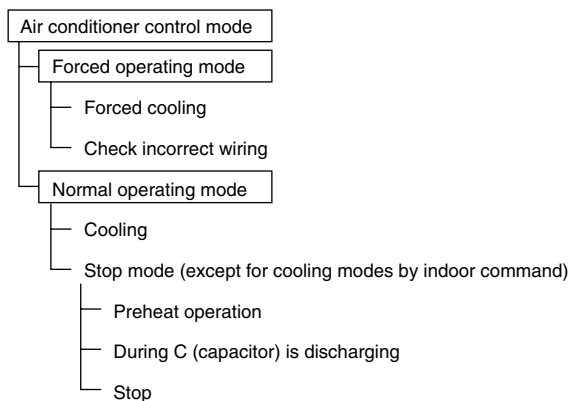

(R1374)



#### Note:

Unless specified otherwise, an indoor dry operation command must be regarded as cooling operation. An indoor fan operation command cannot be made in a multiple indoor unit. (A forced fan command to the indoor unit from the outdoor unit must be made during forced operation.)

#### Determine Operating Mode

Judge the operating mode command set by each room in accordance with the instructing procedure, and determine the operating mode of the system.

The following procedure will be taken as the modes conflict with each other.

\*1. The system will follow the mode determined first. (First-push, first-set)

\*2. For the rooms set with different mode, select stand-by mode. (Operation lamp flashes)



## 3.2 Frequency Control

### Outline

Frequency that corresponds to each room's capacity will be determined according to the difference in the temperature of each room and the temperature that is set by the remote controller.

The function is explained as follows.

1. How to determine frequency.
2. Frequency command from an indoor unit. (The difference between a room temperature and the temperature set by the remote controller.)
3. Frequency command from an indoor unit. (The ranked capacity of the operating room).
4. Frequency initial setting.
5. PI control.

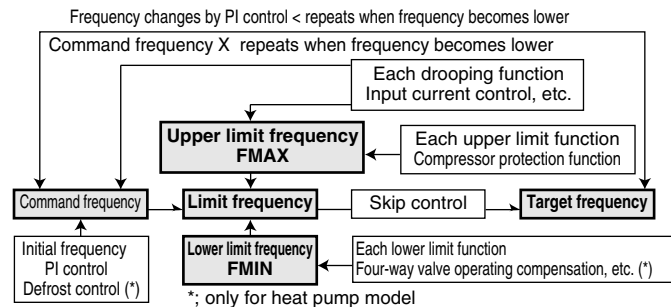

(R1375)

### Detail

#### How to Determine Frequency

The compressor's frequency will finally be determined by taking the following steps.

#### For Heat Pump Model

##### 1. Determine command frequency

- ◆ Command frequency will be determined in the following order of priority.
  - 1.1 Limiting frequency by drooping function
  - ◆ Input current, discharge pipes, low Hz high pressure limit, peak cutting, freeze-up protection, dew prevention, fin thermistor temperature.
  - 1.2 Limiting defrost control time
  - 1.3 Forced cooling / heating
  - 1.4 Indoor frequency command

##### 2. Determine upper limit frequency

- ◆ Set a minimum value as an upper limit frequency among the frequency upper limits of the following functions:  
Compressor protection, input current, discharge pipes, Low Hz high pressure, peak cutting, freeze-up protection, defrost.

##### 3. Determine lower limit frequency

- ◆ Set a maximum value as a lower limit frequency among the frequency lower limits of the following functions:  
Four way valve operating compensation, draft prevention, pressure difference upkeep.

##### 4. Determine prohibited frequency

- ◆ There is a certain prohibited frequency such as a power supply frequency.

#### For Cooling Only Model

##### 1. Determine command frequency

- ◆ Command frequency will be determined in the following order of priority.
  - 1.1 Limiting frequency by drooping function
  - ◆ Input current, discharge pipes, freeze-up protection, dew prevention, fin thermistor temperature.
  - 1.2 Indoor frequency command

**2. Determine upper limit frequency**

- ◆ Set a minimum value as an upper limit frequency among the frequency upper limits of the following functions:  
Compressor protection, input current, discharge pipes, freeze-up protection, dew prevention, fin thermistor temperature.

**3. Determine lower limit frequency**

- ◆ Set a maximum value as an lower limit frequency among the frequency lower limits of the following functions:  
Pressure difference upkeep.

**4. Determine prohibited frequency**

- ◆ There is a certain prohibited frequency such as a power supply frequency.

**Indoor Frequency Command ( $\Delta D$  signal)**

The difference between a room temperature and the temperature set by the remote controller will be taken as the " $\Delta D$  signal" and is used for frequency command.

Temperature difference	$\Delta D$ signal	Temperature difference	$\Delta D$ signal	Temperature difference	$\Delta D$ signal	Temperature difference	$\Delta D$ signal
0	*Th OFF	2.0	4	4.0	8	6.0	C
0.5	1	2.5	5	4.5	9	6.5	D
1.0	2	3.0	6	5.0	A	7.0	E
1.5	3	3.5	7	5.5	B	7.5	F

\*Th OFF = Thermostat OFF

**Indoor Unit Capacity (S value)**

The capacity of the indoor unit is a "S" value and is used for frequency command.

Capacity	S value	Capacity	S value
2.5 kW	25	6.0 kW	60
3.5 kW	35	7.1 kW	71
5.0 kW	50		

**Frequency Initial Setting****<Outline>**

When starting the compressor, or when conditions are varied due to the change of the operating room, the frequency must be initialized according to the total of a maximum  $\Delta D$  value of each room and a total value of Q ( $\Sigma Q$ ) of the operating room (the room in which the thermostat is set to ON).  
Q value: Indoor unit output determined from indoor unit volume, air flow rate and other factors.

**PI Control (Determine Frequency Up / Down by  $\Delta D$  Signal)****1. P control**

Calculate a total of the  $\Delta D$  value in each sampling time (20 seconds), and adjust the frequency according to its difference from the frequency previously calculated.

**2. I control**

If the operating frequency is not change more than a certain fixed time, adjust the frequency up and down according to the  $\Sigma \Delta D$  value, obtaining the fixed  $\Sigma \Delta D$  value.

When the  $\Sigma \Delta D$  value is small...lower the frequency.

When the  $\Sigma \Delta D$  value is large...increase the frequency.

**3. Limit of frequency variation width**

When the difference between input current and input current drooping value is less than 1.5 A, the frequency increase width must be limited.

**4. Frequency management when other controls are functioning**

- ◆ When each frequency is drooping;  
Frequency management is carried out only when the frequency droops.
- ◆ For limiting lower limit  
Frequency management is carried out only when the frequency rises.

**5. Upper and lower limit of frequency by PI control**

The frequency upper and lower limits are set depending on the total of S values of a room. When low noise commands come from the indoor unit more than one room or when outdoor unit low noise or quiet commands come from all the rooms, the upper limit frequency must be lowered than the usual setting.

## 3.3 Controls at Mode Changing / Start-up

### 3.3.1 Preheating Operation

#### Outline

Operate the inverter in the open phase operation with the conditions including the preheating command from the indoor, the outdoor air temperature and discharge pipe temperature.

#### Detail

##### Preheating ON Condition

- When outdoor air temperature is below 10.5°C and discharge pipe temperature is below 10.5°C, inverter in open phase operation starts. (The power consumption of compressor during preheat operation is 35 W.)

##### OFF Condition

- When outdoor air temperature is higher than 12°C or discharge pipe temperature is higher than 12°C, inverter in open phase operation stops.

### 3.3.2 Four Way Valve Switching

#### Outline

##### Heat Pump Only

During the heating operation current must be conducted and during cooling and defrosting current must not be conducted. In order to eliminate the switching sound (as the four way valve coil switches from ON to OFF) when the heating is stopped, the delay switch of the four way valve must be carried out after the operation stopped.

#### Detail

The OFF delay of four way valve  
Energize the coil for 150 sec after unit operation is stopped.

### 3.3.3 Four Way Valve Operation Compensation

#### Outline

##### Heat Pump Only

At the beginning of the operation as the four way valve is switched, acquire the differential pressure required for activating the four way valve by having output the operating frequency, which is more than a certain fixed frequency, for a certain fixed time.

#### Detail

##### Starting Conditions

- When starting compressor for heating.
- When the operating mode changes from the previous time.
- When starting compressor for rushing defrosting or resetting.
- When starting compressor for the first time after the reset with the power is ON.  
Set the lower limit frequency to 39 (model by model) Hz for 70 seconds with any conditions 1 through 4 above.

### 3.3.4 3-Minute Stand-by

Prohibit to turn ON the compressor for 3 minutes after turning it off.  
(Except when defrosting. (Only for Heat Pump Model).)

### 3.3.5 Compressor Protection Function

When turning the compressor from OFF to ON, the upper limit of frequency must be set as follows. (The function must not be used when defrosting (only for heat pump model).)

	2YC32	2YC36	2YC45, 2YC63
FCG 3	85	85	80
FCG 2	70	70	65
FCG 1	55	55	55
TCG 1	120	150	120
TCG 2	200	180	200
TCG 3	470	300	470

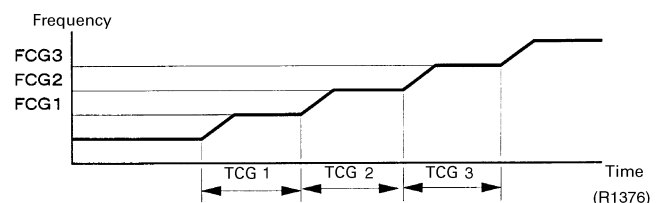

### 3.4 Discharge Pipe Temperature Control

**Outline** The discharge pipe temperature is used as the compressor's internal temperature. If the discharge pipe temperature rises above a certain level, the operating frequency upper limit is set to keep this temperature from going up further.

**Detail** **Zones (typical value)**

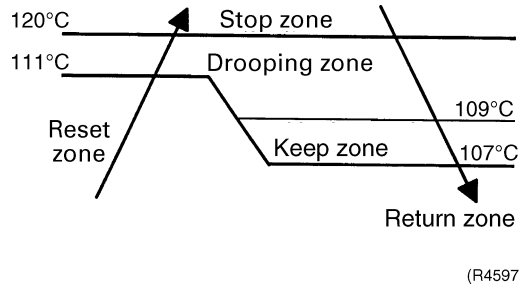

**Management within the Zone**

Zone	Control contents
Stop zone	When the temperature reaches the stop zone, stop the compressor and correct abnormality.
Drooping zone	Start the timer, and the frequency will be drooping.
Keep zone	Keep the frequency upper limit.
Return / Reset zone	Cancel the frequency upper limit.

### 3.5 Input Current Control

**Outline** Detect an input current by the CT during the compressor is running, and set the frequency upper limit from such input current. In case of heat pump model, this control is the upper limit control function of the frequency which takes priority of the lower limit of four way valve activating compensation.

**Detail** The frequency control will be made within the following zones.

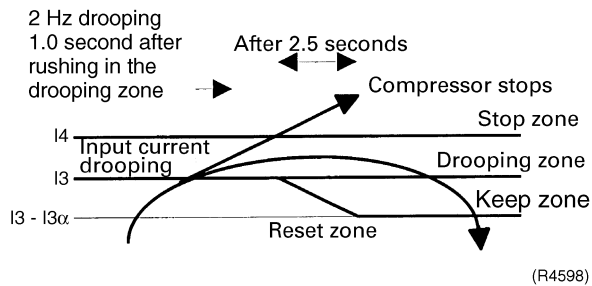

When a “stop current” continues for 2.5 seconds after rushing on the stop zone, the compressor operation stops.  
 If a “drooping current” is continues for 1.0 second after rushing on the drooping zone, the frequency will be 2 Hz drooping.  
 Repeating the above drooping continues until the current rushes on the drooping zone without change.  
 In the keep zone, the frequency limit will remain.  
 In the return / reset zone, the frequency limit will be cancelled.

**Limitation of current drooping and stop value according to the outdoor air temperature**

1. In case the operation mode is cooling
  - ◆ The current droops when outdoor air temperature becomes higher than a certain level (model by model).
2. In case the operation mode is heating (only for heat pump model)
  - ◆ The current droops when outdoor air temperature becomes higher than a certain level (model by model).

### 3.6 Freeze-up Protection Control

**Outline** During cooling operation, the signals being sent from the indoor unit allow the operating frequency limitation and then prevent freezing of the indoor heat exchanger. (The signal from the indoor unit must be divided into the zones as the followings.

**Detail** **Conditions for Start Controlling**  
 Judge the controlling start with the indoor heat exchanger temperature after 2 sec from operation start and after 30 sec from changing number of operation room.  
**Control in Each Zone**

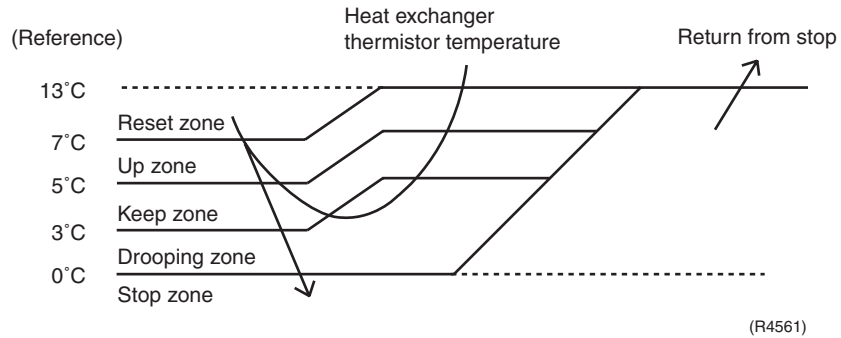

### 3.7 Heating Peak-cut Control

**Outline** **Heat Pump Only**  
 During heating operation, the signals being sent form the indoor unit allow the operating frequency limitation and prevent abnormal high pressure. (The signal from the indoor unit must be divided as follows.)

**Detail** **Conditions for Start Controlling**  
 Judge the controlling start with the indoor heat exchanger temperature after 2 min from operation start and after A sec from changing number of operation room.  
**Control in Each Zone**  
 The maximum value of heat exchange intermediate temperature of each indoor unit controls the following (excluding stopped rooms).

	A
When increase	30
When decrease	2

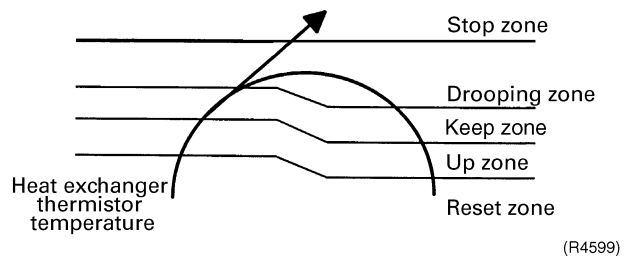

## 3.8 Fan Control

---

### Outline

- Fan control is carried out with following condition.
1. Fan ON control for electric component cooling fan
  2. Fan control when defrosting
  3. Fan OFF delay when stopped
  4. ON/OFF control when cooling operation
  5. Fan control when the number of heating rooms decreases
  6. Fan control when forced operation
  7. Fan control in indoor / outdoor quiet operation
  8. Fan control for pressure difference upkeep
- 

### Detail

#### Fan OFF Control when Stopped

- ◆ Fan OFF delay for 60 seconds must be made when the compressor is stopped.

#### Fan control when the number of heating room decreases (Only for Heat Pump Model)

When the outdoor air temperature is more than 10°C, the fan must be turned OFF for 30 seconds.

#### Tap Control in Indoor / Outdoor Unit Silent Operation

1. When Cooling Operation  
When the outdoor air temperature is less than 37°C, the fan tap must be set to L.
2. When Heating Operation  
When the outdoor air temperature is more than 4°C, the fan tap must be turned to L (only for heat pump model).

## 3.9 Liquid Compression Protection Function 2

---

### Outline

In order to obtain the dependability of the compressor, the compressor must be stopped according to the conditions of the temperature of the outdoor air and outdoor heat exchanger.

---

### Detail

#### Heat Pump Model

- ◆ Operation stops depending on the outdoor air temperature.  
Compressor operation turns OFF under the conditions that the system is in cooling operation and outdoor air temperature is below -5°C (52-68 class) or -10°C (80-100 class).

#### Cooling Only Model

- ◆ Operation stops depending on the outdoor air temperature.  
Compressor operation turns OFF under the condition that outdoor air temperature is below 10°C (E series) or -10°C (D series).

## 3.10 Defrost Control

### Outline

#### Heat Pump Only

Defrosting is carried out by the cooling cycle (reverse cycle). The defrosting time or outdoor heat exchanger temperature must be more than its fixed value when finishing.

### Detail

#### Conditions for Starting Defrost

Under the conditions that the system is in heating operation, 6 minutes after the compressor is started and more than 38 minutes of accumulated time pass since the start of the operation or ending the defrosting.

When the outdoor air temperature and the outdoor heat exchanger temperature meet the following condition for 60 seconds, the defrost control starts.

$$A < -(19/256) \times B + (45/64) \times C$$

A: outdoor heat exchanger temperature

B: output frequency

C: outdoor air temperature

#### Conditions for Canceling Defrost

The target heat exchanger temperature as the canceling condition is selected in the range of  $4^{\circ}\text{C} \leq T_e \leq 12^{\circ}\text{C}$  according to the air temperature as the following formula.

$$\text{The target heat exchanger temperature} = -(45/64) \times (\text{ambient temperature}) + 14$$

The defrost operation surely operates in 120 seconds after the start. (A→B)

After then the defrost operation stops at the following conditions.

1. When the heat exchanger temperature reaches the target heat exchanger temperature. (B→C)
2. When 650 seconds have passed after the start even if the heat exchanger temperature does not reaches the target heat exchanger temperature. (C)

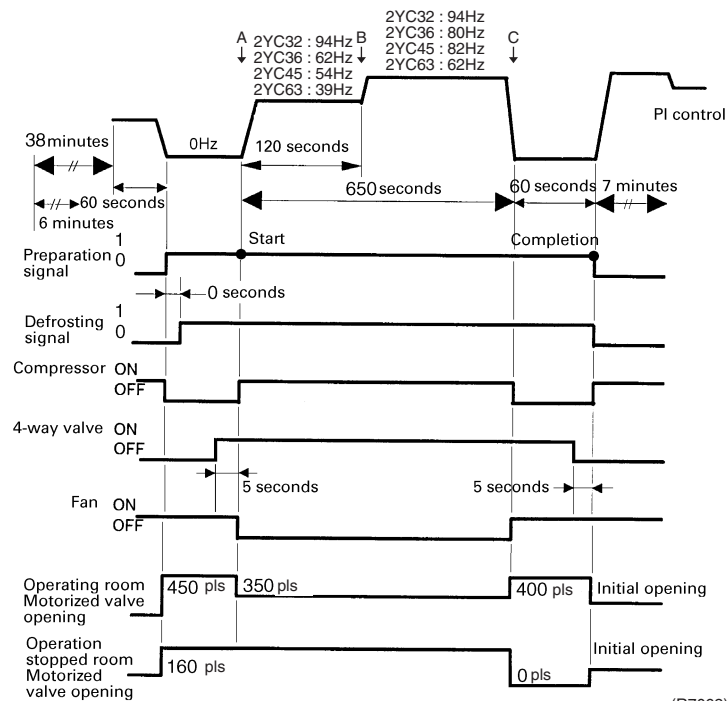



## 3.11 Low Hz High Pressure Limit

### Outline

#### Heat Pump Only

Set the upper limit of high pressure in a low Hz zone. Set the upper limit of the indoor heat exchanger temperature by its operating frequency of Hz. Separate into three zones, reset zone, keep zone and drooping zone and the frequency control must be carried out in such zones.

### Detail

#### Separate into Zones

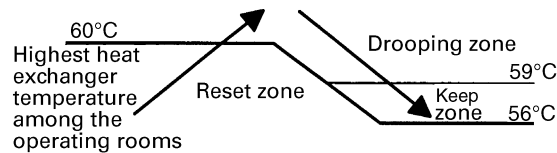

(R4820)



**Note:** Drooping: The system stops 2 minutes after staying in the drooping zone.

## 3.12 Electronic Expansion Valve Control

### Outline

The following items are included in the electronic expansion valve control.

#### Electronic expansion valve is fully closed

1. Electronic expansion valve is fully closed when turning on the power.
2. Pressure equalizing control

#### Room Distribution Control

1. Gas pipe isothermal control (distribution control in cooling)
2. SC control (distribution control in heating)

#### Open Control

1. Electronic expansion valve control when starting operation
2. Control when frequency changed
3. Control for defrosting (only for heat pump model)
4. Oil recover control
5. Control when a discharge pipe temperature is abnormally high
6. Control when the discharge pipe thermistor is disconnected
7. Control for indoor unit freeze-up protection

#### Feedback Control

1. Discharge pipe temperature control

#### Distribution control for each room

1. Liquid pipe temperature control (with all ports connected and all rooms being air-conditioned)
2. Liquid pipe temperature control for stopped rooms
3. Dew prevention function for indoor rotor

Detail

The followings are the examples of control which function in each mode by the electronic expansion valve control.

Operation pattern		Gas pipe isothermal control	SC control (only for heat pump model)	Control when frequency changed	Control for abnormally high discharge pipe temperature	Oil recovery control	Indoor freeze-up protection control	Liquid pipe temperature control	Liquid pipe temperature control for stopped rooms	Dew prevention control for indoor rotor
<pre> graph TD     A[When power is turned ON] --&gt; B[Cooling, 1 room operation]     B --&gt; C[Cooling, 2 rooms operation to Cooling, 4 rooms operation]     C --&gt; D[Stop]     D --&gt; E[Heating, 1 room operation (only for heat pump model)]     E --&gt; F[Heating, 2 rooms operation to Heating, 4 rooms operation (only for heat pump model)]     F --&gt; G[Stop]     G --&gt; H[Heating operation (only for heat pump model)]     H --&gt; I[Control of discharge pipe thermistor disconnection]     I --&gt; J[Stop]                     </pre>	○ : function × : not function									
	Fully closed when power is turned ON	×	×	×	×	×	×	×	×	×
	Open control when starting	×	×	×	○	○	○	×	×	×
	(Control of target discharge pipe temperature)	×	×	○	○	○	○	×	×	○
	Control when the operating room is changed	×	×	×	○	○	○	×	×	○
	(Control of target discharge pipe temperature)	○	×	○	○	○	○	×	×	○
	Pressure equalizing control	×	×	×	×	×	×	×	×	×
	Open control when starting	×	×	×	○	×	×	×	×	×
	(Control of target discharge pipe temperature)	×	○ All rooms ×	○	○	×	×	○ All rooms ○	○ All rooms ×	×
	Control when the operating room is changed	×	×	×	○	×	×	×	×	×
	(Control of target discharge pipe temperature)	×	○ All rooms ×	○	○	×	×	○ All rooms ○	○ All rooms ×	×
	(Defrost control FD=1) (only for heat pump model)	×	×	×	×	×	×	×	×	×
	Pressure equalizing control	×	×	×	×	×	×	×	×	×
	Open control when starting	×	×	×	○	×	×	×	×	×
	Continue	×	○ All rooms ×	×	×	×	×	○ All rooms ○	○ All rooms ×	×
	Pressure equalizing control	×	×	×	×	×	×	×	×	×

(R3056)

### 3.12.1 Fully Closing with Power ON

Initialize the electronic expansion valve when turning on the power, set the opening position and develop pressure equalizing.

### 3.12.2 Pressure Equalization Control

When the compressor is stopped, open and close the electronic expansion valve and develop pressure equalization.

### 3.12.3 Opening Limit

#### Outline

Limit a maximum and minimum opening of the electronic expansion valve in the operating room.

#### Detail

- ◆ A maximum electronic expansion valve opening in the operating room: 450 pulses
  - ◆ A minimum electronic expansion valve opening in the operating room: 75 pulses
- The electronic expansion valve is fully closed in the room where cooling is stopped and is opened with fixed opening during defrosting.

### 3.12.4 Gas Pipe Isothermal Control During Cooling

When the units are operating in multiple rooms, detect the gas piping temperature and correct the electronic expansion valve opening so that the temperature of the gas pipe in each room becomes identical.

- ◆ When the gas pipe temperature > the average gas pipe temperature,  
→ open the electronic expansion valve in that room
- ◆ When the gas pipe temperature < the average gas pipe temperature,  
→ close the electronic expansion valve in that room

The temperatures are monitored every 40 seconds.

### 3.12.5 SC Control

#### Outline

#### Heat Pump Only

Detect the temperature of liquid pipe and heat exchanger of the rooms and compensate the electronic expansion valve opening so that the SC of each room becomes the target SC.

- ◆ When the actual SC is > target SC, open the electronic expansion valve of the room.
- ◆ When the actual SC is < target SC, close the electronic expansion valve of the room.

#### Detail

#### Start Functioning Conditions

After finishing the open control (630 seconds after the beginning of the operation), control all the electronic expansion valve in the operating room.

#### Determine Electronic Expansion Valve Opening

Adjust the electronic expansion valve so that the temperature difference between the maximum heat exchanger temperature of connected room and the temperature of liquid pipe thermistor becomes constant.

### 3.12.6 Starting Operation Control / Changing Operation Room

Control the electronic expansion valve opening when the system is starting or the operating room is changed, and prevent the system to be super heated or moistened.

### 3.12.7 Disconnection of the Discharge Pipe Thermistor

#### Outline

Detect a disconnected discharge pipe thermistor by comparing the discharge pipe temperature with the condensation temperature. If any is disconnected, open the electronic expansion valve according to the outdoor air temperature and the operating frequency and operate for a specified time, and then stop.

After 3 minutes of waiting, restart the unit and check if any is disconnected. If any is disconnected stop the system after operating for a specified time. If the disconnection is detected 4 times in succession, then the system will be down.

#### Detail

##### Detect Disconnection

If a 630-second timer for open control becomes over, and a 9-minute timer for the compressor operation continuation is not counting time, the following adjustment must be made.

1. When the operation mode is cooling  
When the discharge pipe temperature is lower than the outdoor heat exchanger temperature, the discharge pipe thermistor disconnection must be ascertained.
2. When the operation mode is heating (only for heat pump model)  
When the discharge pipe temperature is lower than the max temperature of operating room heat exchanger, the discharge pipe thermistor disconnection must be ascertained.

##### Adjustment when the thermistor is disconnected

When compressor stop repeats specified time, the system should be down.

### 3.12.8 Control when frequency is changed

When the target pipe temperature control is active, if the target frequency is changed for a specified value in a certain time period, cancel the target discharge pipe temperature control and change the opening of the target electronic expansion valve according to the shift.

### 3.12.9 High Temperature of the Discharge Pipe

When the compressor is operating, if the discharge pipe temperature exceeds a certain value, open the electronic expansion valve and remove the refrigerant to the low pressure side and lower discharge temperature.

### 3.12.10 Oil Recovery Function

#### Outline

The electronic expansion valve opening in the cooling stopped room must be set as to open for a certain time at a specified interval so that the oil in the cooling stopped room may not be accumulated.

#### Detail

During cooling operation, every 1 hour continuous operation, the electronic expansion valves in the operation stopped room must be opened by 80 pulses for specified time.

### 3.12.11 Target Discharge Pipe Temperature Control

Obtain the target discharge pipe temperature from the indoor and outdoor heat exchange temperature, and adjust the electronic expansion valve opening so that the actual discharge pipe temperature become close to that temperature. (Indirect SH control using the discharge pipe temperature)

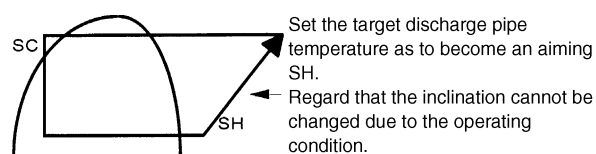

(R1389)

Determine a correction value of the electronic expansion valve compensation and drive it according to the deflection of the target discharge temperature and actual discharge temperature, and the discharge temperature variation by the 20 sec.

## 3.13 Malfunctions

### 3.13.1 Sensor Malfunction Detection

Sensor malfunction may occur either in the thermistor or current transformer (CT) system.

#### Relating to Thermistor Malfunction

1. Outdoor heat exchanger thermistor
2. Discharge pipe thermistor
3. Fin thermistor
4. Gas pipe thermistor
5. Outdoor air temperature thermistor
6. Liquid pipe thermistor

#### Relating to CT Malfunction

When the output frequency is more than 55 Hz (model by model) and the input current is less than 1.25A, carry out abnormal adjustment.

### 3.13.2 Detection of Overload and Over Current

#### Outline

In order to protect the inverter, detect an excessive output current, and for protecting compressor, monitor the OL operation.

#### Detail

- ◆ If the OL (compressor head) temperature exceeds 130°C (120°C for 2YC36), the compressor gets interrupted.
- ◆ If the inverter current exceeds 30 A, the compressor gets interrupted too.

### 3.13.3 Insufficient Gas Control

#### Outline

#### I Detecting by power consumption

If the power consumption is below the specified value and the frequency is higher than the specified frequency, it is regarded as insufficient gas.

The power consumption is weak comparing with that in the normal operation when gas is insufficient, and gas insufficiency is detected by checking a power consumption.

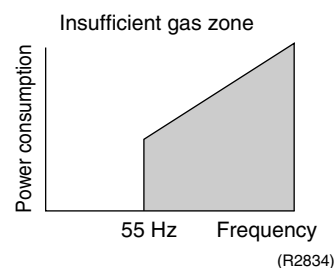

#### II Detecting by discharge pipe temperature

If the discharge temperature is higher than the target discharge pipe temperature, and the electronic expansion valve is fully open (450 pulses) more than the specified time, it is regarded as insufficient gas.

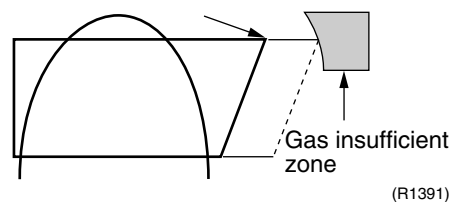

Refer to "Insufficient Gas" on page 253 for detail.

### 3.13.4 Preventing Indoor Freezing

During cooling, if the heat exchanger temperature in the operation stopped room becomes below the specified temperature for the specified time, open the electronic expansion valve in the operation stopped room as specified, and carry out the fully closed operation. After this, if freezing abnormality occurs more than specified time, the system shall be down as the system abnormality.

## 3.14 Forced Operation Mode

### Outline

Forced operating mode includes functions such as; forced cooling, forced heating, incorrect wiring, incorrect piping check.

Operating mode must be selected by operating the forced operation switch.

### Detail

#### Forced Cooling, Forced Heating (Only for Heat Pump Model)

Item	Forced Cooling	Forced Heating
Forced operation allowing conditions	1) The indoor unit is not abnormal, but the indoor unit which is not in the freezing prohibiting zone is present in more than 1 room.	1) The indoor unit is not abnormal. The indoor unit which is not in the peak-cut prohibited zone is present in more than 1 room.
	2) The outdoor unit is not abnormal and not in the 3-minute stand-by mode.	←
	3) The operating mode of the outdoor unit is the stop mode.	←
	4) The slide selection switch of the forced operation is the cooling mode. The forced operation is allowed when the above "and" conditions are met.	4) The slide selection switch of the forced operation is the heating mode. The forced operation is allowed when the above "and" conditions are met.
Starting / adjustment	If the forced operation switch is pressed as the above conditions are met.	←
1) Determine operating room	All rooms	One of the available units runs. Priority is given to the youngest number's room in alphabetical order. (A > B > C > D)
2) Command frequency	<ul style="list-style-type: none"> <li>◆ 2YC32, 2YC36: 52 Hz</li> <li>◆ 2YC45: 42 Hz</li> <li>◆ 2YC63: 31 Hz</li> </ul>	<ul style="list-style-type: none"> <li>◆ 2YC32: 42 Hz (outdoor air: 2°C)</li> <li>◆ 2YC36: 42 Hz (outdoor air: 0°C)</li> <li>◆ 2YC45: 35 Hz (outdoor air: 2°C)</li> <li>◆ 2YC63: 26 Hz (outdoor air: 2°C)</li> </ul>
3) Electronic expansion valve opening	It depends on the capacity of the operating indoor unit.	←
4) Outdoor unit adjustment	Compressor is in operation.	←
5) Indoor unit adjustment	The command of forced operation is transmitted to the indoor unit.	←
End	1) When the forced operation switch is pressed again.	←
	2) The operation is to end automatically after 60 min.	←
Others	The protect functions are prior to all others in the forced operation.	←

## 3.15 Wiring-Error Check

### Outline

The convenient Wiring Error Check function is designed for the microcomputer to correct wiring errors itself.

If local wiring is unclear in the case of buried piping, for example, just press the wiring error check switch that is behind the right-hand panel of the outdoor unit. Even if the connections for Room A and Room B are confused, the system may run without a hassle. Note that this check function does not work in the following cases.

- ◆ For about 30 seconds after the power is turned on (during initial setup).
- ◆ For 3-minute standby period after the compressor has stopped.
- ◆ When the outdoor air temperature is below 5°C.
- ◆ If the indoor unit is in trouble (also in case of all-room transmission failure).

When the piping and wiring are perfect, there is no need to use this function.

### Operation

1. Remove the 5 screws from the service panel (right side panel) and detach the panel.
2. Press the wiring error check switch on the service monitor PCB, and the wiring error check function is activated.
3. In about 10-15 minutes, the checking will end automatically.
4. When the checking is over, the service monitor LED indicators start flashing.

LED	1	2	3	4	Judgment
Status	All flashing at once				Self-correction impossible
	Flashing one after another				Self-correction complete

Self-correction complete...The LED indicators 1 ~ 4 flash one after another.

Self-correction impossible...The LED indicators flash all at the same time.

- ◆ Transmission failure occurs at any of the indoor units.
- ◆ The indoor unit heat exchanger thermistor is disconnected.
- ◆ An indoor unit is in trouble (if a trouble occurs during the wiring error checking).

Emergency stop...Any of the LED indicators 1 ~ 4 stays on.



#### Note:

1. It takes about 10-15 minutes (after pressing the wiring error check switch) to complete the checking. (Wrong wiring between the upper and lower units cannot be self-corrected.)
2. Wrongly connected liquid and gas pipes cannot be self-corrected either. Be sure to make the liquid pipe and the gas pipe in pairs.
3. To forced-terminate the wiring error check procedure halfway, press the wiring error check switch again.  
In this case, the microcomputer's memory gets back to its initial status (Room A wiring → Port A piping, Room B wiring → Port B piping).
4. In replacing the outdoor unit PCB, be sure to use this function.
5. Make the power slide setting after doing the wiring error checking. (Otherwise, if the wiring is reversed, the air-conditioners being connected are set up in the reverse way.)

### Basic Knowledge

- ◆ This function works in this way. Refrigerant is let flow from Port A and on. The temperatures of the indoor unit heat exchanger thermistors are detected one by one to check up the matching between the pipes and wiring.
- ◆ With this function on, freezing (crackling) noise may be heard from the indoor unit. This is not a problem. (This is because the heat exchange temperature is made to drop below 0°C in order to increase the detection accuracy.)
- ◆ The indoor fan is made to turn on and off at the same time.

**Checking the current setting data on the microcomputer memory**

Those data can be checked by looking at the service monitor LED indicators, when the wiring error checking is over, during forced operation, at the stop of the system. The LED indicators stop flashing when the forced operation is over.  
 LED1...Room A wiring, LED2...Room B wiring  
 1st flashing LED...Port A piping, 2nd flashing LED...Port B piping  
 The first stay-on LED means the room that is connected with Port A. The next stay-on LED means the one connected with Port B.

**Example**

Let's suppose the LED indicators are flashing as follows.

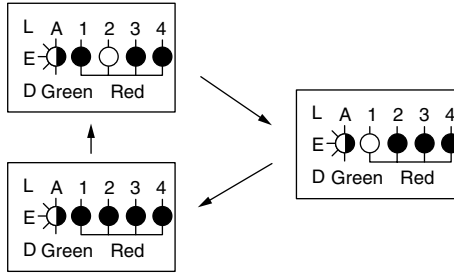

The above means that Port A is connected with Port B and Port B with Room A (or self-corrected this way.)

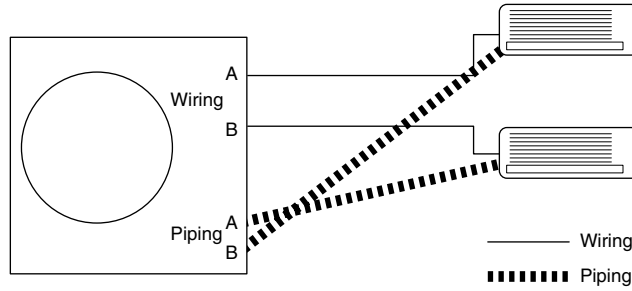



## 3.16 Additional Function

### 3.16.1 Connection Pipe Condensation Preventing Function

This control is intended to adjust the electronic expansion valve opening so that the outdoor unit gas pipe temperature (GDN) be kept below 8°C.

### 3.16.2 Priority Room Setting

Electronic expansion valves are controlled to provide the unit designated as the priority room with the capacity of other room units.

(Distribution of capacity: Priority room unit ---  $\Delta D$  Max., other room units ---  $\Delta D - \alpha$ )

- ◆ Setting method
  - Turn off the circuit breaker before changing the setting.
  - Only one room can be set as the priority room.
- ◆ Control start conditions
  - Priority room setting is made.
  - AND
  - “Powerful” signal from the priority room unit is received.



**Note:** The operation mode of the priority room unit has precedence.

- ◆ Cancellation of control
  - The control function is canceled when the “Powerful” operation mode is switched off or 20 minutes elapse after “Powerful Operation” started.

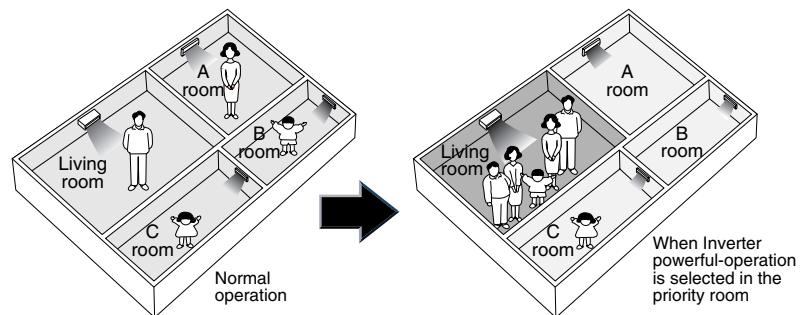

**The prioritised room will be heated/cooled much more quickly**

(R1396)

### 3.16.3 POWERFUL Operation Mode

Compressor operating frequency is increased to PI Max. (Max. Hz of operating room unit  $\Sigma S$ ) and outdoor unit airflow rate is increased.

### 3.16.4 Voltage Detection Function

Power supply voltage is detected each time equipment operation starts.

### 3.16.5 Cooling / Heating Mode Lock

Use the S15 connector to set the unit to only cool or heat.

Setting to only heat (H): Short-circuit pins 1 and 3 of the connector <S15>.

Setting to only cool (C): short-circuit pins 3 and 5 of the connector <S15>.

The following specifications apply to the connector housing and pins.

JST products Housing: VHR-5N

Pin: SVH-21T-1, 1

Note that forced operation is also possible in COOL / HEAT mode.

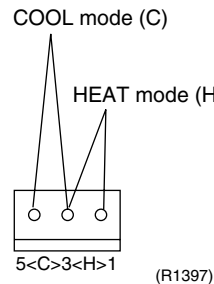

### 3.16.6 ECONO-mode-proof Setting (E series 50-58 class, 80-100 class)

#### Outline

When installing in hotels, you can make ECONO mode ineffective on the outdoor unit.

#### Operation

The ECONO mode can be switched over between "effective" and "ineffective" by pressing the forced operation switch (SW1) and wiring error check switch (SW3) at the same time and holding them for 5 seconds while the compressor is stopped. The LEDs are lit in turn for 15 seconds to show the ECONO mode status.

The factory setting is "effective".

	effective → ineffective	ineffective → effective
LED flashing order	4 → 3 → 2 → 1	1 → 2 → 3 → 4



# Part 5

# Operation Manual

1. System Configuration.....	120
1.1 Operation Instructions .....	120
2. Instruction.....	121
2.1 FTK(X)S, CDK(X)S, FDK(X)S, FLXS, FVXS Series.....	121
2.2 FFQ 25/35/50/60 B.....	189

# 1. System Configuration

## 1.1 Operation Instructions

After the installation and test operation of the room air conditioner have been completed, it should be operated and handled as described below. Every user would like to know the correct method of operation of the room air conditioner, to check if it is capable of cooling (or heating) well, and to know a clever method of using it.

In order to meet this expectation of the users, giving sufficient explanations taking enough time can be said to reduce about 80% of the requests for servicing. However good the installation work is and however good the functions are, the customer may blame either the room air conditioner or its installation work because of improper handling. The installation work and handing over of the unit can only be considered to have been completed when its handling has been explained to the user without using technical terms but giving full knowledge of the equipment.

## 2. Instruction

### 2.1 FTK(X)S, CDK(X)S, FDK(X)S, FLXS, FVXS Series

#### 2.1.1 Manual Contents and Reference Page

Model Series	Wall Mounted Type		
	FTK(X)S20/25/35D FTK(X)S25/35E	FTK(X)S50/60/71F	FTK(X)S50/60/71D FTKS50/60/71B
<b>Read before Operation</b>			
Safety Precautions	122	122	122
Names of Parts	124	127	130
Preparation before Operation ★1	142	142	142
<b>Operation</b>			
AUTO, DRY, COOL, HEAT, FAN Operation ★1	145	145	145
Adjusting the Air Flow Direction	147	149	—
POWERFUL Operation ★1	155	155	155
OUTDOOR UNIT QUIET Operation ★1	156	156	—
ECONO Operation	157	—	—
MOLD PROOF Operation	158	—	—
HOME LEAVE Operation ★2	—	159	159
INTELLIGENT EYE Operation	161	163	163
TIMER Operation ★1	165	165	165
Note for Multi System	167	167	167
<b>Care</b>			
Care and Cleaning	169	172	175
<b>Trouble Shooting</b>			
Trouble Shooting	186	186	186
Drawing No.	3P194550-4 3P194539-2 3P194537-4 3P194539-3	3P192025-1 3P194539-1 3P182978-3	3P142638-9L 3P194444-2

Model Series	Duct Connected Type	Floor/Ceiling Suspended Dual Type	Floor standing Type
	CDKS25/35/50/60C FDK(X)S25/35/50/60C CDK(X)S25/35/50/60D FDKS25/35E, CDK(X)S25/35E	FLXS25/35/50/60B	FVXS35/50B
<b>Read before Operation</b>			
Safety Precautions	122	122	122
Names of Parts	133	136	139
Preparation before Operation ★1	142	142	142
<b>Operation</b>			
AUTO, DRY, COOL, HEAT, FAN Operation ★1	145	145	145
Adjusting the Air Flow Direction	—	151	153
POWERFUL Operation ★1	155	155	155
OUTDOOR UNIT QUIET Operation ★1	156	156	165
ECONO Operation	—	—	—
MOLD PROOF Operation	—	—	—
HOME LEAVE Operation ★2	159	159	159
INTELLIGENT EYE Operation	—	—	—
TIMER Operation ★1	165	165	165
Note for Multi System	167	167	167
<b>Care</b>			
Care and Cleaning	178	180	183
<b>Trouble Shooting</b>			
Trouble Shooting	186	186	186
Drawing No.	3P196326-5, 3P196326-8B 3P196326-7, 3P196326-9B 3P156657-1D, 3P196326-6 3P132000-5E	3D194537-7	3D141308-2F

★ 1 : Illustrations are for wall mounted type FTK(X)S20D as representative.

★ 2 : Illustrations are for wall mounted type FTK(X)S50/60/71F as representative.

## 2.1.2 Safety Precautions

# Safety precautions

- Keep this manual where the operator can easily find them.
- Read this manual attentively before starting up the unit.
- For safety reason the operator must read the following cautions carefully.
- This manual classifies precautions into WARNING and CAUTION. Be sure to follow all precautions below: they are all important for ensuring safety.



### WARNING

If you do not follow these instructions exactly, the unit may cause property damage, personal injury or loss of life.



### CAUTION

If you do not follow these instructions exactly, the unit may cause minor or moderate property damage or personal injury.



Never do.



Be sure to follow the instructions.



Be sure to earth the air conditioner.



Never cause the air conditioner (including the remote controller) to get wet.



Never touch the air conditioner (including the remote controller) with a wet hand.





### WARNING

- In order to avoid fire, explosion or injury, do not operate the unit when harmful, among which flammable or corrosive gases, are detected near the unit. 
- It is not good for health to expose your body to the air flow for a long time.
- Do not put a finger, a rod or other objects into the air outlet or inlet. As the fan is rotating at a high speed, it will cause injury.
- Do not attempt to repair, relocate, modify or reinstall the air conditioner by yourself. Incorrect work will cause electric shocks, fire etc.  
For repairs and reinstallation, consult your Daikin dealer for advice and information.

- The refrigerant used in the air conditioner is safe. Although leaks should not occur, if for some reason any refrigerant happens to leak into the room, make sure it does not come in contact with any flame as of gas heaters, kerosene heaters or gas range. 
- If the air conditioner is not cooling (heating) properly, the refrigerant may be leaking, so call your dealer. When carrying out repairs accompanying adding refrigerant, check the content of the repairs with our service staff.
- Do not attempt to install the air conditioner by your self. Incorrect work will result in water leakage, electric shocks or fire. For installation, consult the dealer or a qualified technician.
- In order to avoid electric shock, fire or injury, if you detect any abnormally such as smell of fire, stop the operation and turn off the breaker. And call your dealer for instructions.



### CAUTION

- The air conditioner must be earthed. Incomplete earthing may result in electric shocks. Do not connect the earth line to a gas pipe, water pipe, lightning rod, or a telephone earth line. 
- In order to avoid any quality deterioration, do not use the unit for cooling precision instruments, food, plants, animals or works of art. 
- Never expose little children, plants or animals directly to the air flow.
- Do not place appliances which produce open fire in places exposed to the air flow from the unit or under the indoor unit. It may cause incomplete combustion or deformation of the unit due to the heat.
- Do not block air inlets nor outlets. Impaired air flow may result in insufficient performance or trouble.

- Do not stand or sit on the outdoor unit. Do not place any object on the unit to avoid injury, do not remove the fan guard.
- Do not place anything under the indoor or outdoor unit that must be kept away from moisture. In certain conditions, moisture in the air may condense and drip.
- After a long use, check the unit stand and fittings for damage.
- Do not touch the air inlet and aluminum fins of outdoor unit. It may cause injury.
- The appliance is not intended for use by young children or infirm persons without supervision.
- Young children should be supervised to ensure that they do not play with the appliance.

- 
- To avoid oxygen deficiency, ventilate the room sufficiently if equipment with burner is used together with the air conditioner.
  - Before cleaning, be sure to stop the operation, turn the breaker off or pull out the supply cord.
  - Do not connect the air conditioner to a power supply different from the one as specified. It may cause trouble or fire.
  - Depending on the environment, an earth leakage breaker must be installed. Lack of an earth leakage breaker may result in electric shocks.
  - Arrange the drain hose to ensure smooth drainage. Incomplete draining may cause wetting of the building, furniture etc.



- 
- Do not operate the air conditioner with wet hands.



- 
- Do not wash the indoor unit with excessive water, only use a slightly wet cloth.
  - Do not place things such as vessels containing water or anything else on top of the unit. Water may penetrate into the unit and degrade electrical insulations, resulting in an electric shock.



### Installation site.

- To install the air conditioner in the following types of environments, consult the dealer.
  - Places with an oily ambient or where steam or soot occurs.
  - Salty environment such as coastal areas.
  - Places where sulfide gas occurs such as hot springs.
  - Places where snow may block the outdoor unit.

The drain from the outdoor unit must be discharged to a place of good drainage.

### Consider nuisance to your neighbours from noises.

- For installation, choose a place as described below.
  - A place solid enough to bear the weight of the unit which does not amplify the operation noise or vibration.
  - A place from where the air discharged from the outdoor unit or the operation noise will not annoy your neighbours.

### Electrical work.

- For power supply, be sure to use a separate power circuit dedicated to the air conditioner.

### System relocation.

- Relocating the air conditioner requires specialized knowledge and skills. Please consult the dealer if relocation is necessary for moving or remodeling.



### 2.1.3 Names of Parts

FTK(X)S 20/25/35 D, FTK(X)S 25/35 E

## Names of parts

### ■ Indoor Unit

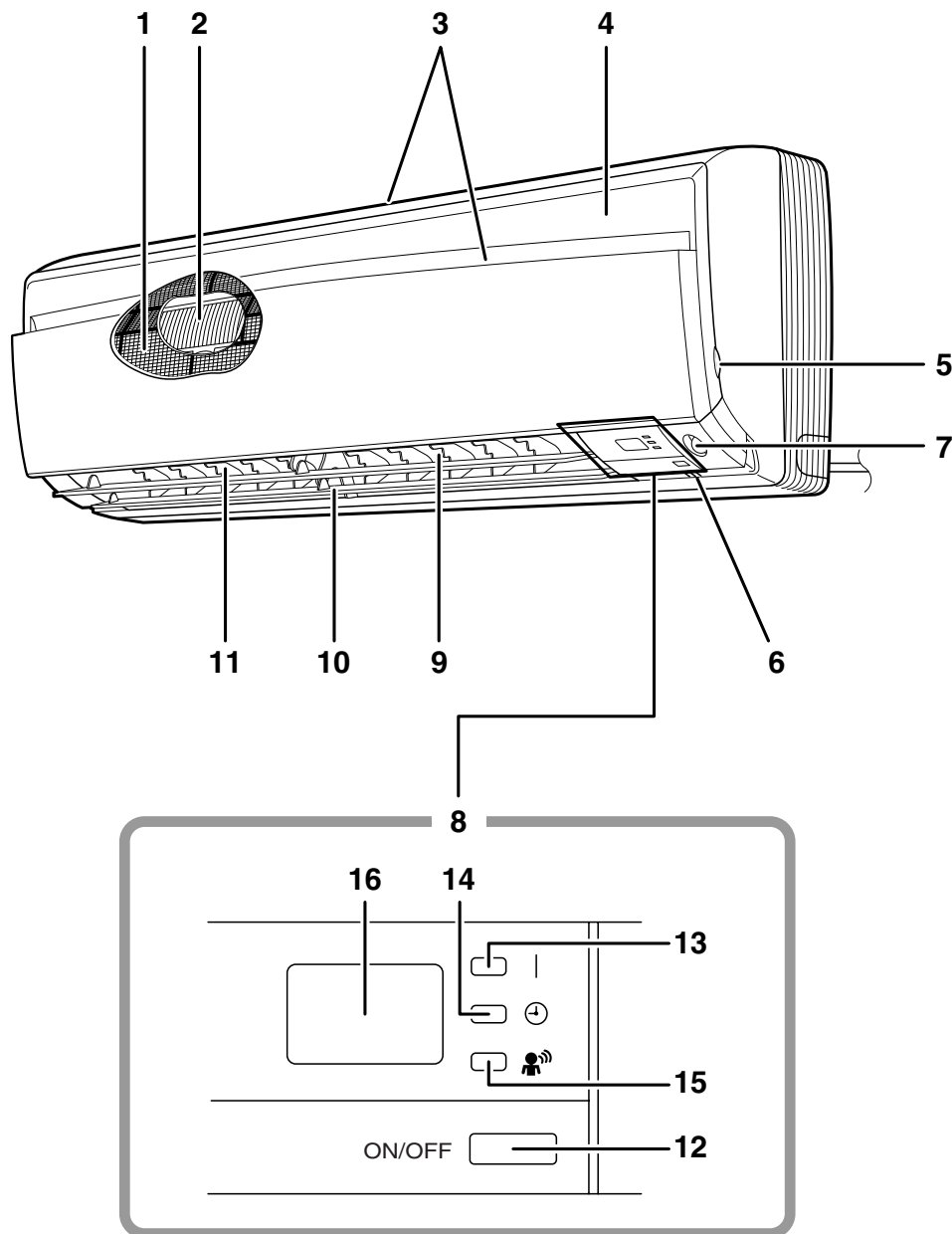

## ■ Outdoor Unit

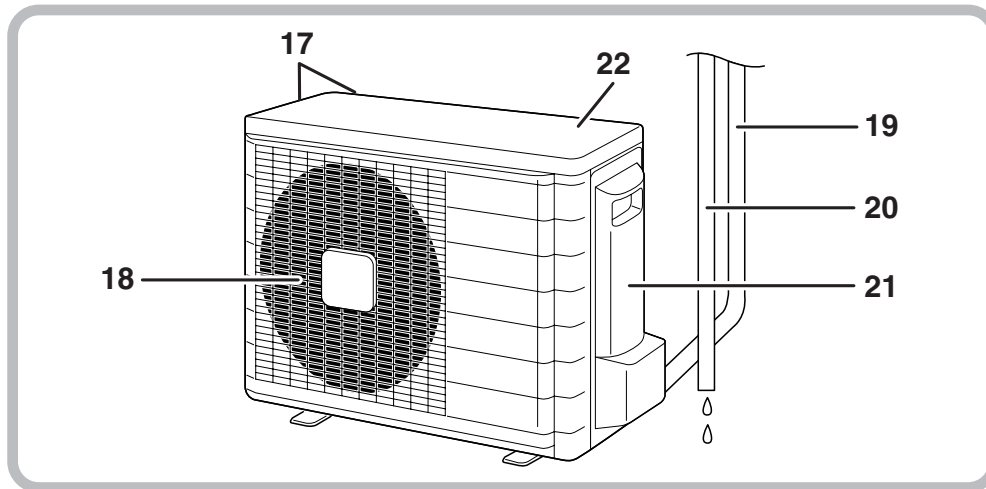

## ■ Indoor Unit

### 1. Air filter

### 2. Titanium Apatite Photocatalytic Air-Purifying Filter:

- These filters are attached to the inside of the air filters.

### 3. Air inlet

### 4. Front panel

### 5. Panel tab

### 6. Room temperature sensor:

- It senses the air temperature around the unit.

### 7. INTELLIGENT EYE sensor:

- It detects the movements of people and automatically switches between normal operation and energy saving operation.

### 8. Display

### 9. Air outlet

### 10. Flaps (horizontal blades)

### 11. louvers (vertical blades):

- The louvers are inside of the air outlet.

### 12. Indoor Unit ON/OFF switch:

- Push this switch once to start operation. Push once again to stop it.
- The operation mode refers to the following table.

	Mode	Temperature setting	Air flow rate
FTK	COOL	22°C	AUTO
FTX	AUTO	25°C	AUTO

- This switch is useful when the remote controller is missing.

### 13. Operation lamp (green)

### 14. TIMER lamp (yellow)

### 15. INTELLIGENT EYE lamp (green)

### 16. Signal receiver:

- It receives signals from the remote controller.
- When the unit receives a signal, you will hear a short beep.
  - Operation start .....beep-beep
  - Settings changed.....beep
  - Operation stop .....beeeep

## ■ Outdoor Unit

### 17. Air inlet: (Back and side)

### 18. Air outlet

### 19. Refrigerant piping and inter-unit cable

### 20. Drain hose

### 21. Earth terminal:

- It is inside of this cover.

### 22. Outside air temperature sensor:

- It senses the ambient temperature around the unit.

Appearance of the outdoor unit may differ from some models.

## ■ Remote Controller

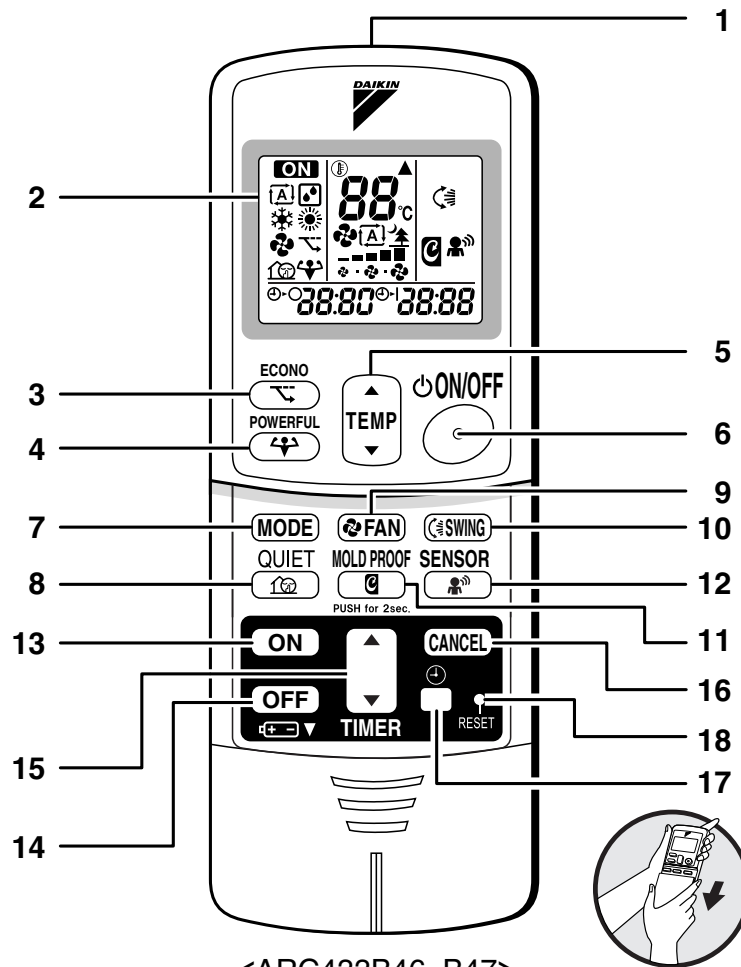

<ARC433B46, B47>

- |  |  |
|--|--|
| <p><b>1. Signal transmitter:</b></p> <ul style="list-style-type: none"> <li>• It sends signals to the indoor unit.</li> </ul> <p><b>2. Display:</b></p> <ul style="list-style-type: none"> <li>• It displays the current settings.<br/>(In this illustration, each section is shown with all its displays ON for the purpose of explanation.)</li> </ul> <p><b>3. ECONO button:</b><br/>ECONO operation</p> <p><b>4. POWERFUL button:</b><br/>POWERFUL operation</p> <p><b>5. TEMPERATURE adjustment buttons:</b></p> <ul style="list-style-type: none"> <li>• It changes the temperature setting.</li> </ul> <p><b>6. ON/OFF button:</b></p> <ul style="list-style-type: none"> <li>• Press this button once to start operation.<br/>Press once again to stop it.</li> </ul> <p><b>7. MODE selector button:</b></p> <ul style="list-style-type: none"> <li>• It selects the operation mode.<br/>(AUTO/DRY/COOL/HEAT/FAN)</li> </ul> | <p><b>8. QUIET button:</b> OUTDOOR UNIT QUIET operation</p> <p><b>9. FAN setting button:</b></p> <ul style="list-style-type: none"> <li>• It selects the air flow rate setting.</li> </ul> <p><b>10. SWING button</b></p> <p><b>11. MOLD PROOF button:</b><br/>MOLD PROOF operation</p> <p><b>12. SENSOR button:</b> INTELLIGENT EYE operation</p> <p><b>13. ON TIMER button</b></p> <p><b>14. OFF TIMER button</b></p> <p><b>15. TIMER Setting button:</b></p> <ul style="list-style-type: none"> <li>• It changes the time setting.</li> </ul> <p><b>16. TIMER CANCEL button:</b></p> <ul style="list-style-type: none"> <li>• It cancels the timer setting.</li> </ul> <p><b>17. CLOCK button</b></p> <p><b>18. RESET button:</b></p> <ul style="list-style-type: none"> <li>• Restart the unit if it freezes.</li> <li>• Use a thin object to push.</li> </ul> |
|--|--|

FTK(X)S 50/60/71 F

# Names of parts

## ■ Indoor Unit

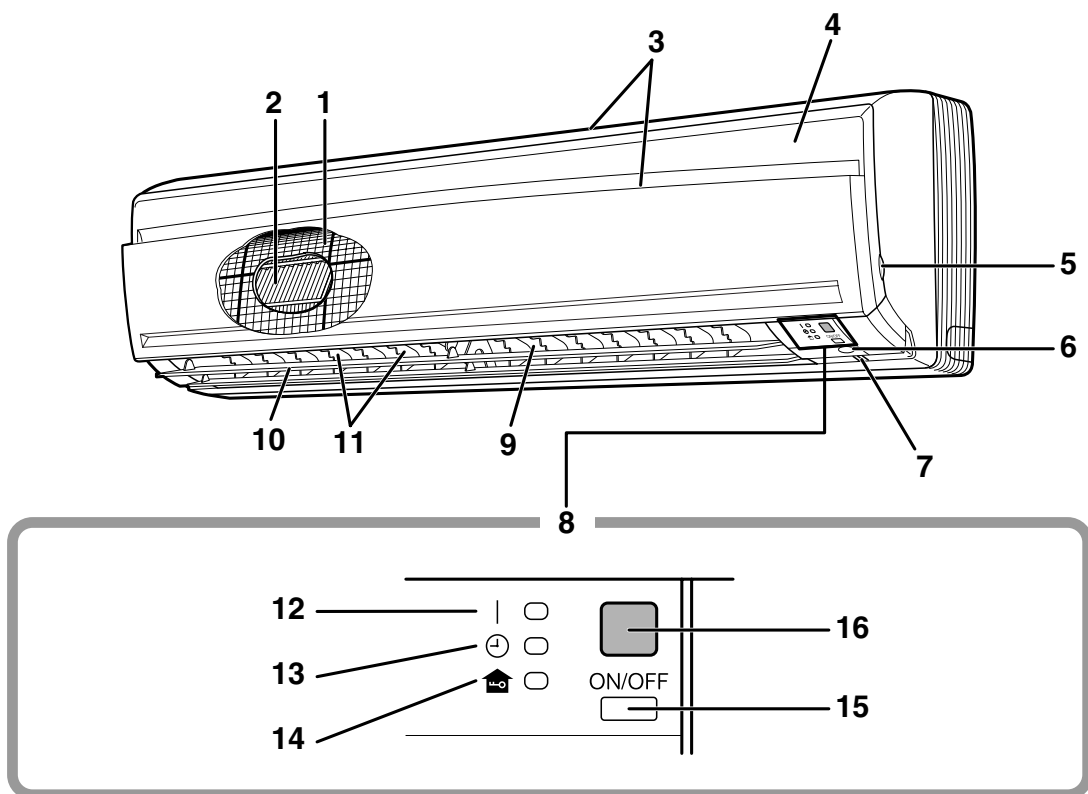

## Outdoor Unit

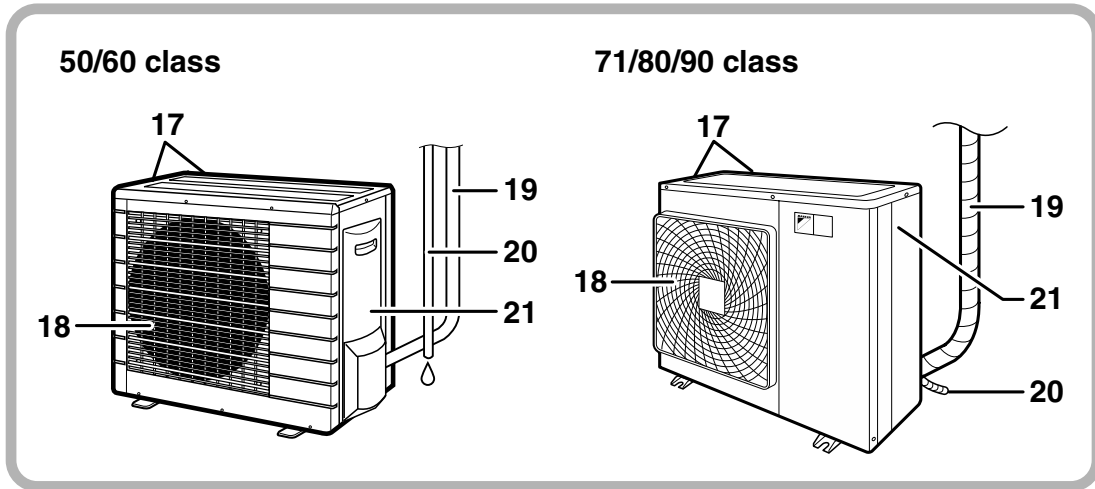

## Indoor Unit

1. Air filter
2. Titanium Apatite Photocatalytic Air-Purifying Filter
3. Air inlet
4. Front panel
5. Panel tab
6. INTELLIGENT EYE sensor:
  - It detects the movements of people and automatically switches between normal operation and energy saving operation.
7. Room temperature sensor:
  - It senses the air temperature around the unit.
8. Display
9. Air outlet
10. Flap (horizontal blade)
11. Louvers (vertical blades):
  - The Louvers are inside of the air outlet.
12. Operation lamp (green)
13. TIMER lamp (yellow)
14. HOME LEAVE lamp (red):
  - Lights up when you use HOME LEAVE Operation.
15. Indoor Unit ON/OFF switch:
  - Push this switch once to start operation. Push once again to stop it.
  - The operation mode refer to the following table.

	Mode	Temperature setting	Air flow rate
FTKS	COOL	22°C	AUTO
FTXS	AUTO	25°C	AUTO

  - This switch is useful when the remote controller is missing.
16. Signal receiver:
  - It receives signals from the remote controller.
  - When the unit receives a signal, you will hear a short beep.
    - Operation start .....beep-beep
    - Settings changed.....beep
    - Operation stop .....beeeep

## Outdoor Unit

17. Air inlet: (Back and side)
18. Air outlet
19. Refrigerant piping and inter-unit cable
20. Drain hose
21. Earth terminal:
  - It is inside of this cover.

Appearance of the outdoor unit may differ from some models.

## ■ Remote Controller

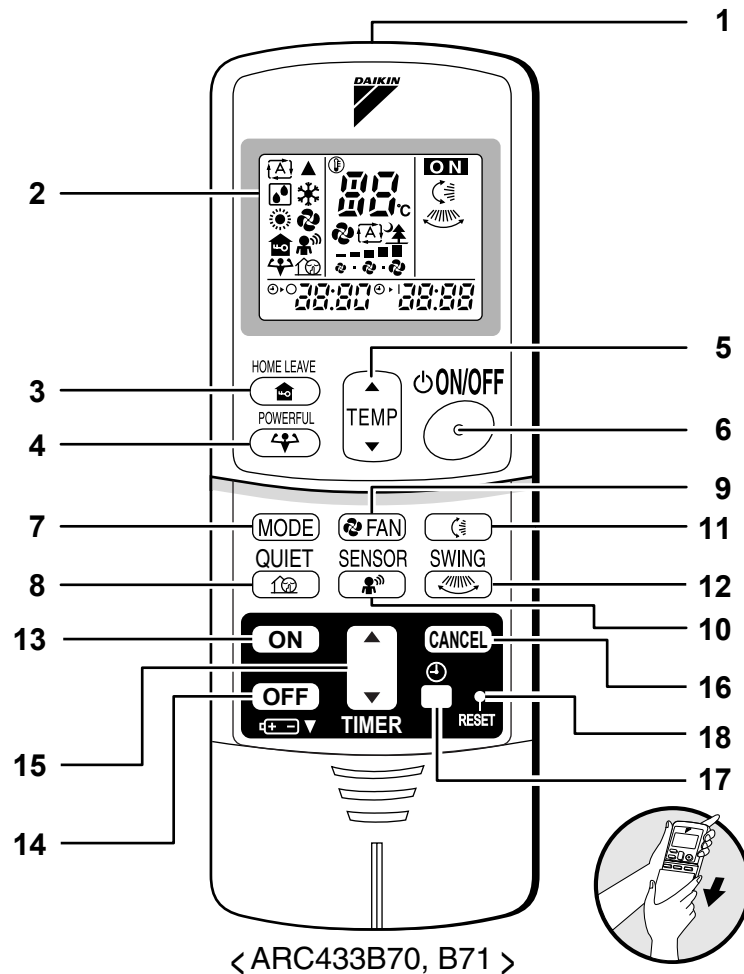

- 1. Signal transmitter:**
  - It sends signals to the indoor unit.
- 2. Display:**
  - It displays the current settings.  
(In this illustration, each section is shown with all its displays ON for the purpose of explanation.)
- 3. HOME LEAVE button:**  
HOME LEAVE operation
- 4. POWERFUL button:**  
POWERFUL operation
- 5. TEMPERATURE adjustment buttons:**
  - It changes the temperature setting.
- 6. ON/OFF button:**
  - Press this button once to start operation.  
Press once again to stop it.
- 7. MODE selector button:**
  - It selects the operation mode.  
(AUTO/DRY/COOL/HEAT/FAN)
- 8. QUIET button:** OUTDOOR UNIT QUIET operation
- 9. FAN setting button:**
  - It selects the air flow rate setting.
- 10. SENSOR button:** INTELLIGENT EYE operation
- 11. SWING button:**
  - Flap (Horizontal blade)
- 12. SWING button:**
  - Louver (Vertical blades)
- 13. ON TIMER button:**
- 14. OFF TIMER button:**
- 15. TIMER Setting button:**
  - It changes the time setting.
- 16. TIMER CANCEL button:**
  - It cancels the timer setting.
- 17. CLOCK button:**
- 18. RESET button:**
  - Restart the unit if it freezes.
  - Use a thin object to push.

FTK(X)S 50/60/71 D, FTKS 50/60/71 B

# Names of parts

## Indoor Unit

The illustration shows a 50-class unit

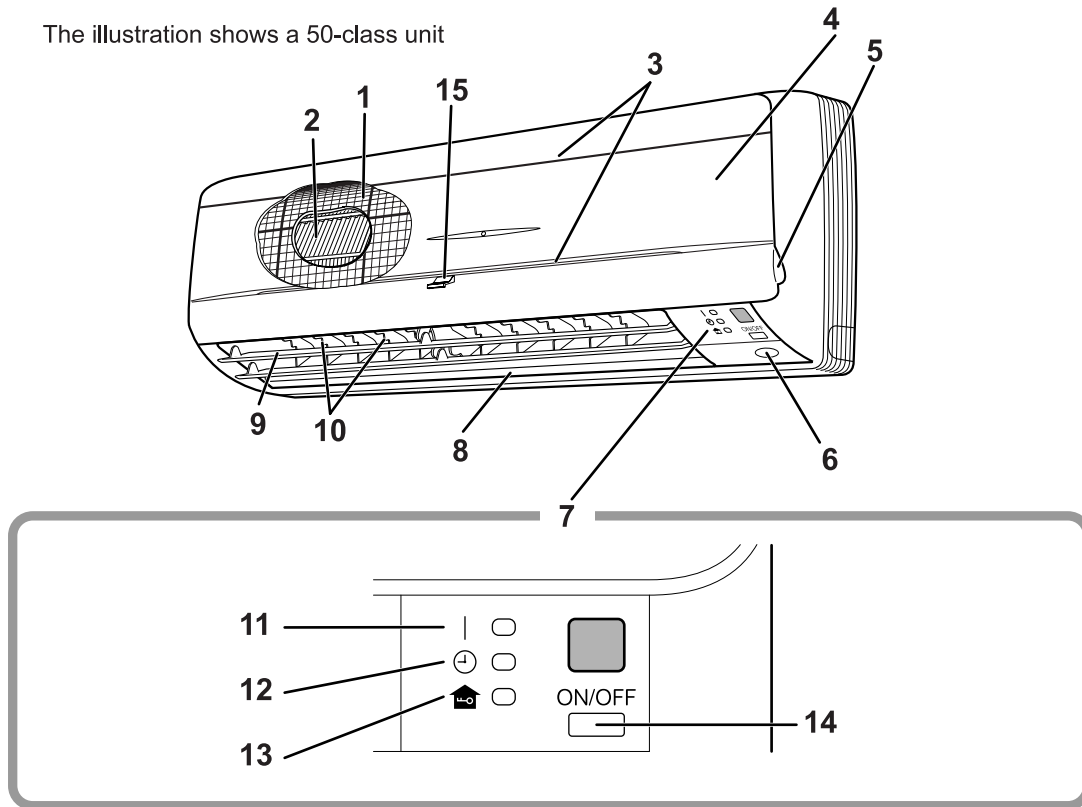

## Main unit control panel

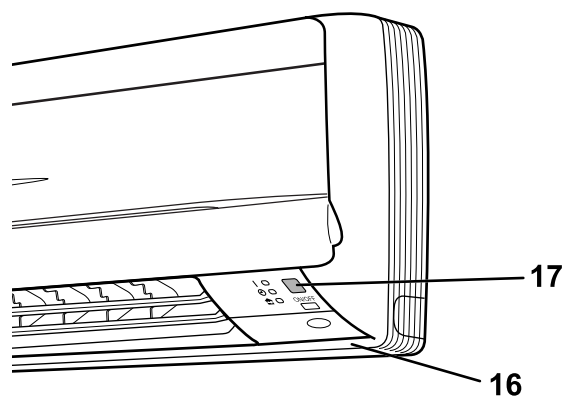

## ■ Outdoor Unit

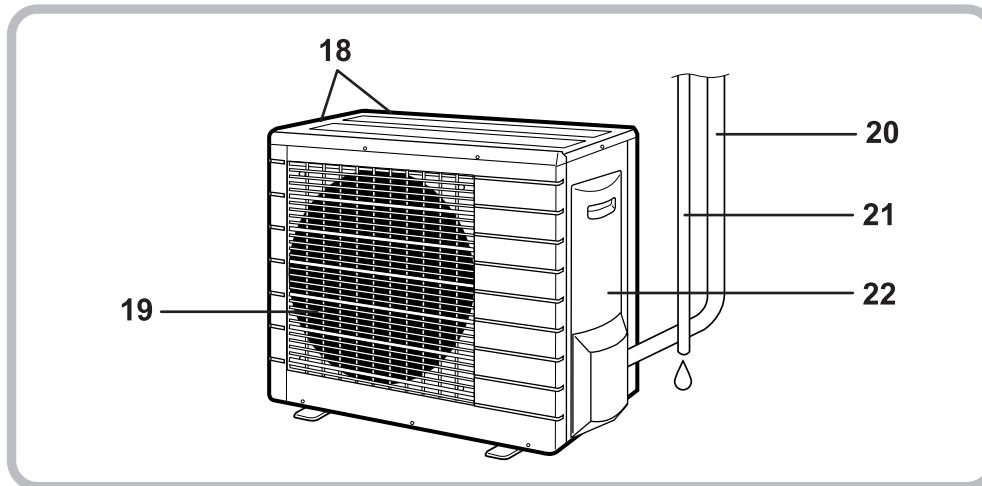

## ■ Indoor Unit

1. Air filter
2. Air purifying filter with photocatalytic deodorizing function:
  - These filters are attached to the inside of the air filters.
3. Air inlet
4. Front grille
5. Grille tab
6. INTELLIGENT EYE sensor:
  - It detects the movements of people and automatically switches between normal operation and energy saving operation.
7. Display
8. Air outlet
9. Flap (horizontal blade):
10. Louvers (vertical blades):
  - The Louvers are inside of the air outlet.
11. Operation lamp (green)
12. TIMER lamp (yellow):
13. HOME LEAVE lamp (red):
  - Lights up when you use HOME LEAVE Operation.
14. Indoor Unit ON/OFF switch:
  - Push this switch once to start operation. Push once again to stop it.
  - The operation mode refer to the following table.

	Mode	Temperature setting	Air flow rate
FTKS	COOL	22°C	AUTO
FTXS	AUTO	25°C	AUTO

  - This switch is useful when the remote controller is missing.
15. Packaging materials: 50 class only
  - If any packaging materials are included, please remove before operating.
16. Room temperature sensor:
  - It senses the air temperature around the unit.
17. Signal receiver:
  - It receives signals from the remote controller.
  - When the unit receives a signal, you will hear a short beep.
    - Operation start .....beep-beep
    - Settings changed.....beep
    - Operation stop .....beeeep

## ■ Outdoor Unit

18. Air inlet: (Back and side)
19. Air outlet
20. Refrigerant piping and inter-unit cable
21. Drain hose
22. Earth terminal:
  - It is inside of this cover.

Appearance of the outdoor unit may differ from some models.



## ■ Remote Controller

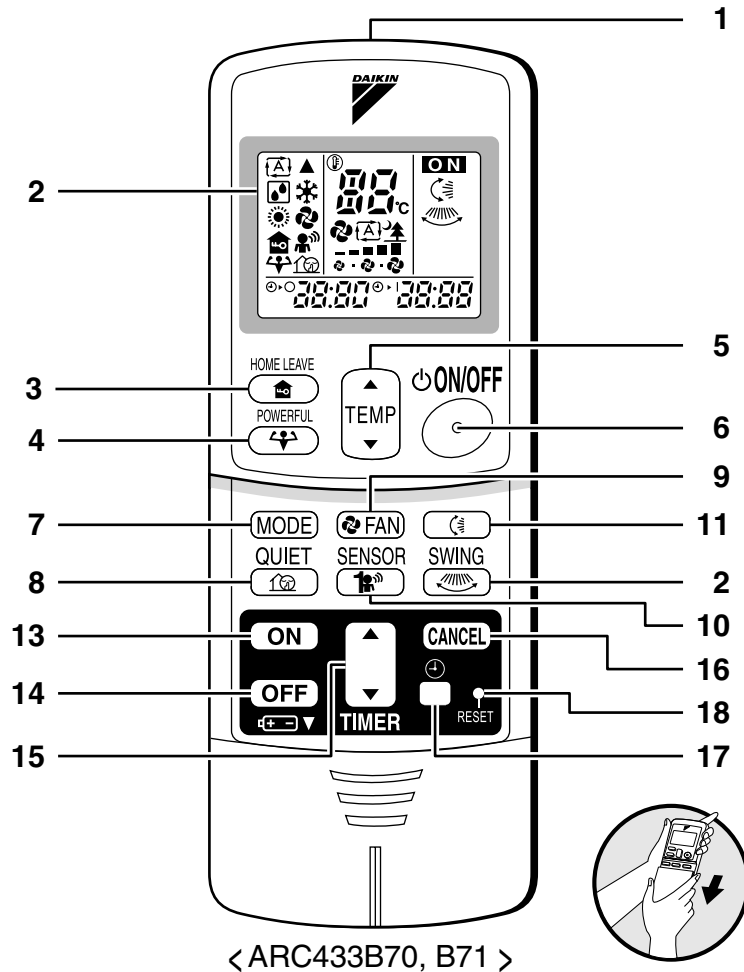

- |  |   |
|--|---|
| <p><b>1. Signal transmitter:</b></p> <ul style="list-style-type: none"> <li>• It sends signals to the indoor unit.</li> </ul> <p><b>2. Display:</b></p> <ul style="list-style-type: none"> <li>• It displays the current settings.<br/>(In this illustration, each section is shown with all its displays ON for the purpose of explanation.)</li> </ul> <p><b>3. HOME LEAVE button:</b><br/>for HOME LEAVE operation</p> <p><b>4. POWERFUL button:</b><br/>for POWERFUL operation</p> <p><b>5. TEMPERATURE adjustment buttons:</b></p> <ul style="list-style-type: none"> <li>• It changes the temperature of time setting.</li> </ul> <p><b>6. ON/OFF button:</b></p> <ul style="list-style-type: none"> <li>• Press this button once to start operation.<br/>Press once again to stop it.</li> </ul> <p><b>7. MODE selector button:</b></p> <ul style="list-style-type: none"> <li>• It selects the operation mode.<br/>(AUTO/DRY/COOL/HEAT/FAN)</li> </ul> <p><b>8. QUIET button:</b> for OUTDOOR UNIT QUIET operation</p> | <p><b>9. FAN setting button:</b></p> <ul style="list-style-type: none"> <li>• It selects the air flow rate setting.</li> </ul> <p><b>10. SENSOR button:</b> for INTELLIGENT EYE operation</p> <p><b>11. SWING button:</b></p> <ul style="list-style-type: none"> <li>• Flap (Horizontal blade)</li> </ul> <p><b>12. SWING button:</b></p> <ul style="list-style-type: none"> <li>• Louver (Vertical blades)</li> </ul> <p><b>13. ON TIMER button:</b></p> <p><b>14. OFF TIMER button:</b></p> <p><b>15. TIMER Setting button:</b></p> <ul style="list-style-type: none"> <li>• It changes the time setting.</li> </ul> <p><b>16. TIMER CANCEL button:</b></p> <ul style="list-style-type: none"> <li>• It cancels the timer setting.</li> </ul> <p><b>17. CLOCK button:</b></p> <p><b>18. RESET button:</b></p> <ul style="list-style-type: none"> <li>• Restart the unit if it freezes.</li> <li>• Use a thin object to push.</li> </ul> |
|--|---|

Duct Connected Type

# Names of parts

## ■ Indoor Unit

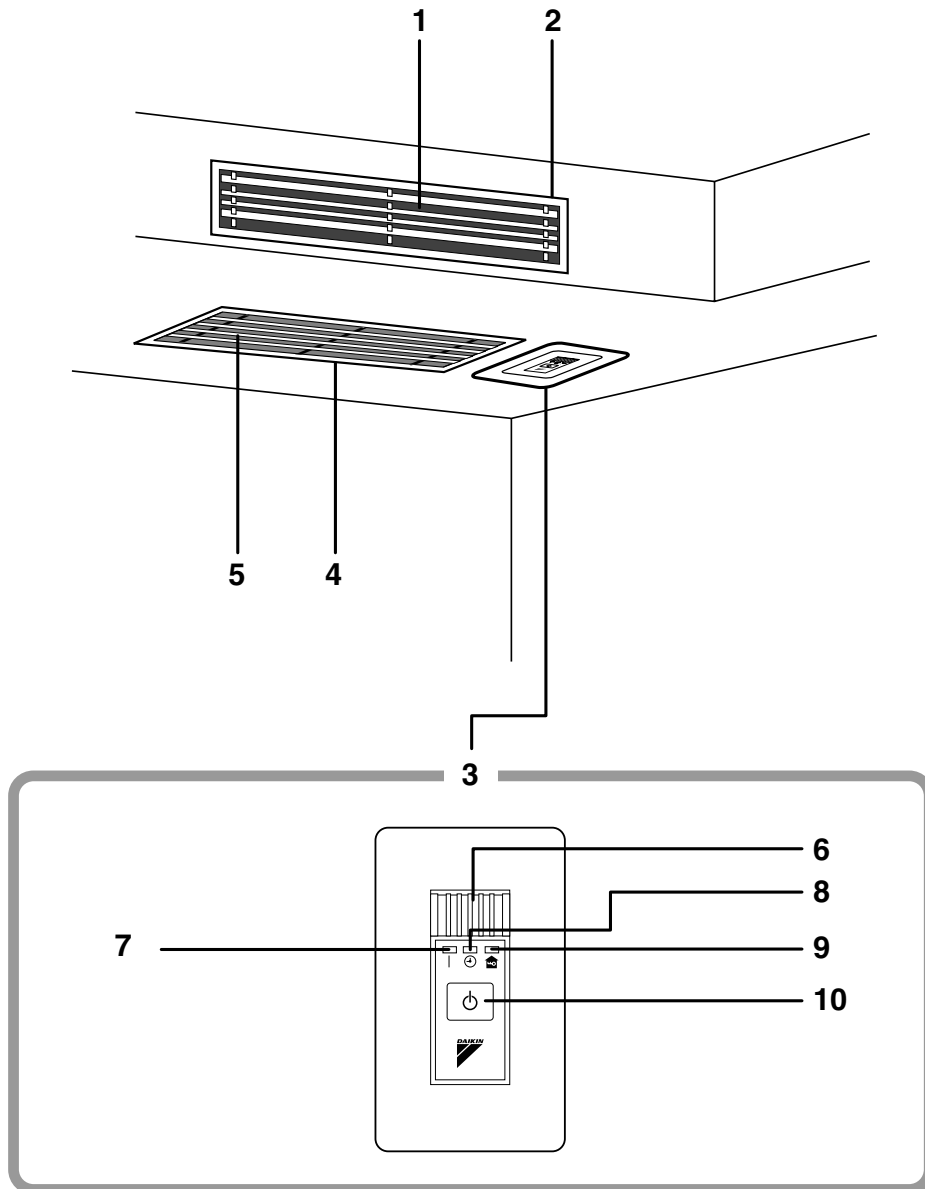

## ■ Outdoor Unit

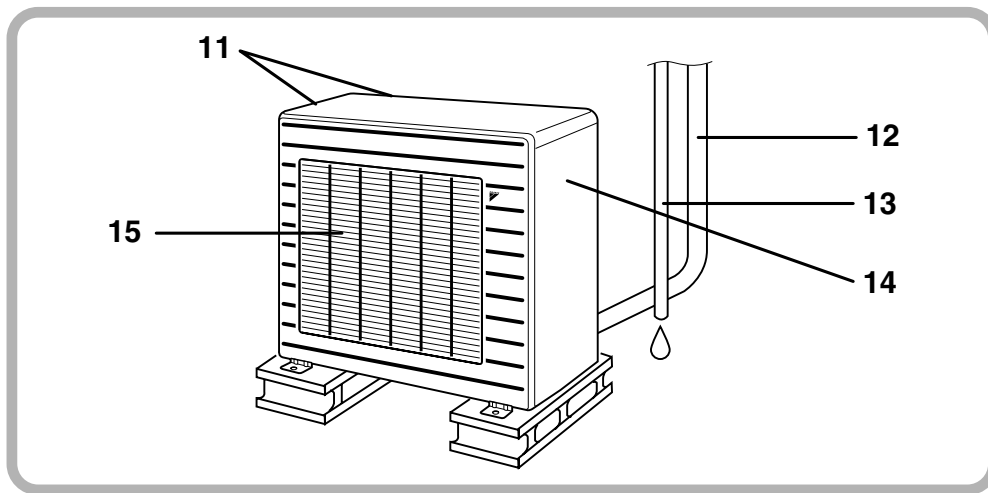

### ■ Indoor Unit

1. **Air outlet**
2. **Air outlet grille:** (Field supply)
  - Appearance of the Air outlet grille and Air inlet grille may differ with some models.
3. **Display, Control panel**
4. **Suction grille:** (Option)
  - Appearance of the suction grille and Air inlet grille may differ with some models.
5. **Air inlet**
6. **Room temperature sensor:**
  - It senses the air temperature around the unit.
7. **Operation lamp (green)**
8. **TIMER lamp (yellow)**
9. **HOME LEAVE lamp (red):**
  - Lights up when you use HOME LEAVE operation.

#### 10. Indoor Unit ON/OFF switch:

- Push this switch once to start operation. Push once again to stop it.
- This switch is useful when the remote controller is missing.

- The operation mode refers to the following table.

	Mode	Temperature setting	Air flow rate
CDKS	COOL	22°C	AUTO
C(F)DXS	AUTO	25°C	AUTO

### ■ Outdoor Unit

11. **Air inlet:** (Back and side)
12. **Refrigerant piping and inter-unit cable**
13. **Drain hose**
14. **Earth terminal:**
  - It is inside of this cover.
15. **Air outlet**

Appearance of the outdoor unit may differ from some models.

## ■ Remote Controller

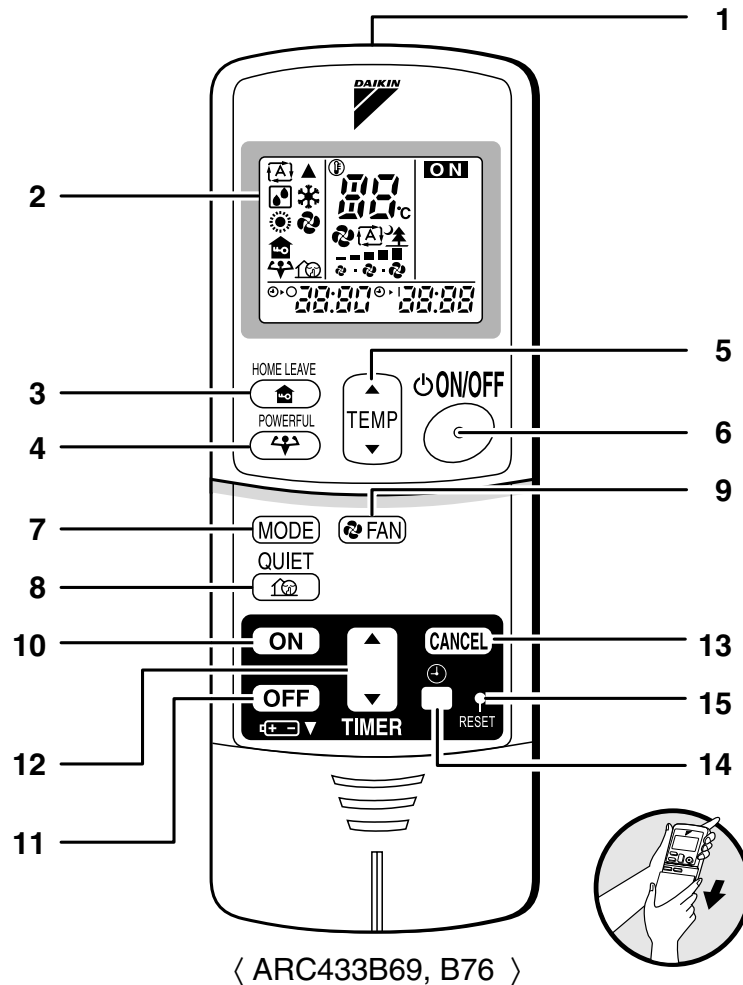

- |   |   |
|---|---|
| <p><b>1. Signal transmitter:</b></p> <ul style="list-style-type: none"> <li>• It sends signals to the indoor unit.</li> </ul> <p><b>2. Display:</b></p> <ul style="list-style-type: none"> <li>• It displays the current settings.<br/>(In this illustration, each section is shown with all its displays ON for the purpose of explanation.)</li> </ul> <p><b>3. HOME LEAVE button:</b><br/>HOME LEAVE operation</p> <p><b>4. POWERFUL button:</b><br/>POWERFUL operation</p> <p><b>5. TEMPERATURE adjustment buttons:</b></p> <ul style="list-style-type: none"> <li>• It changes the temperature setting.</li> </ul> <p><b>6. ON/OFF button:</b></p> <ul style="list-style-type: none"> <li>• Press this button once to start operation.<br/>Press once again to stop it.</li> </ul> | <p><b>7. MODE selector button:</b></p> <ul style="list-style-type: none"> <li>• It selects the operation mode.<br/>(AUTO/DRY/COOL/HEAT/FAN)</li> </ul> <p><b>8. QUIET button:</b> OUTDOOR UNIT QUIET operation</p> <p><b>9. FAN setting button:</b></p> <ul style="list-style-type: none"> <li>• It selects the air flow rate setting.</li> </ul> <p><b>10. ON TIMER button</b></p> <p><b>11. OFF TIMER button</b></p> <p><b>12. TIMER Setting button:</b></p> <ul style="list-style-type: none"> <li>• It changes the time setting.</li> </ul> <p><b>13. TIMER CANCEL button:</b></p> <ul style="list-style-type: none"> <li>• It cancels the timer setting.</li> </ul> <p><b>14. CLOCK button</b></p> <p><b>15. RESET button:</b></p> <ul style="list-style-type: none"> <li>• Restart the unit if it freezes.</li> <li>• Use a thin object to push.</li> </ul> |
|---|---|

## Floor/Ceiling Suspended Dual Type

# Names of parts

## ■ Indoor Unit

The indoor unit can be installed either to the ceiling or to a wall. The descriptions contained in this manual show the case when installation is being carried out to the ceiling. (The methods of operation used are the same when installing to a wall.)

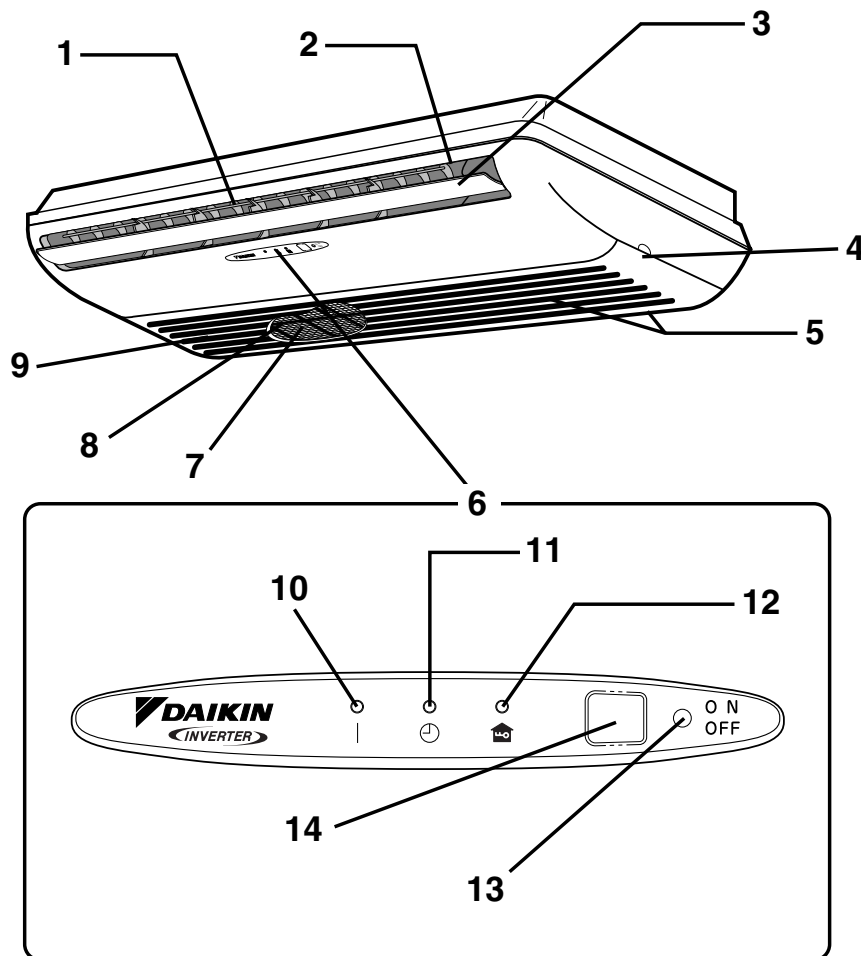

## ■ Opening the front grille

How to open the front grille :

### ⚠ CAUTION

- Before opening the front grille, be sure to stop the operation and turn the breaker OFF.

## ■ Outdoor Unit

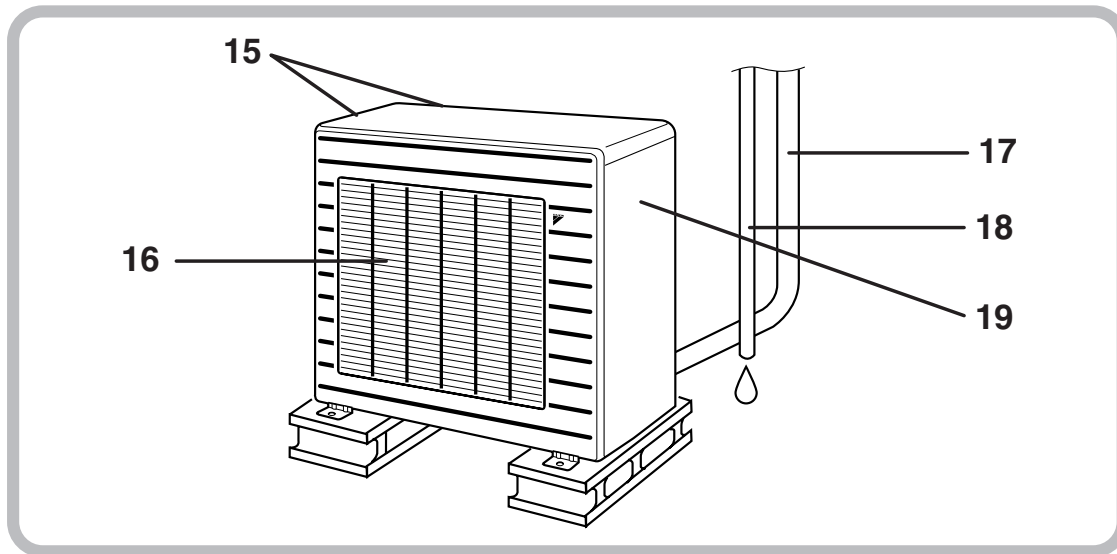

## ■ Indoor Unit

### 1. Louvers (vertical blades):

The louvers are inside of the air outlet.

### 2. Air outlet

### 3. Flap (horizontal blade)

### 4. Grille tab

### 5. Air inlet

### 6. Display

### 7. Air filter

### 8. Photocatalytic deodorizing filter or Air purifying filter:

- These filters are attached to the inside of the air filters.

### 9. Front grille

### 10. Operation lamp (green)

### 11. TIMER lamp (yellow)

### 12. HOME LEAVE lamp (red):

Lights up when you use HOME LEAVE Operation.

### 13. Indoor unit ON/OFF switch:

- Push this switch once to start operation. Push once again to stop it.
- The operation mode refers to the following table.

Mode	Temperature setting	Air flow rate
AUTO	25°C	AUTO

- Push the switch using an object with a sharp tip, such as a pen.
- This switch is useful when the remote controller is missing.

### 14. Signal receiver:

- It receives signals from the remote controller.
- When the unit receives a signal, you will hear a short beep.
  - Operation start .....beep-beep
  - Settings changed .....beep
  - Operation stop .....beeeeeeep

## ■ Outdoor Unit

15. Air inlet: (Back and side)

16. Air outlet

17. Refrigerant piping and inter-unit cable

18. Drain hose

19. Earth terminal:

- It is inside of this cover.

Appearance of the outdoor unit may differ from some models.

## ■ Remote Controller

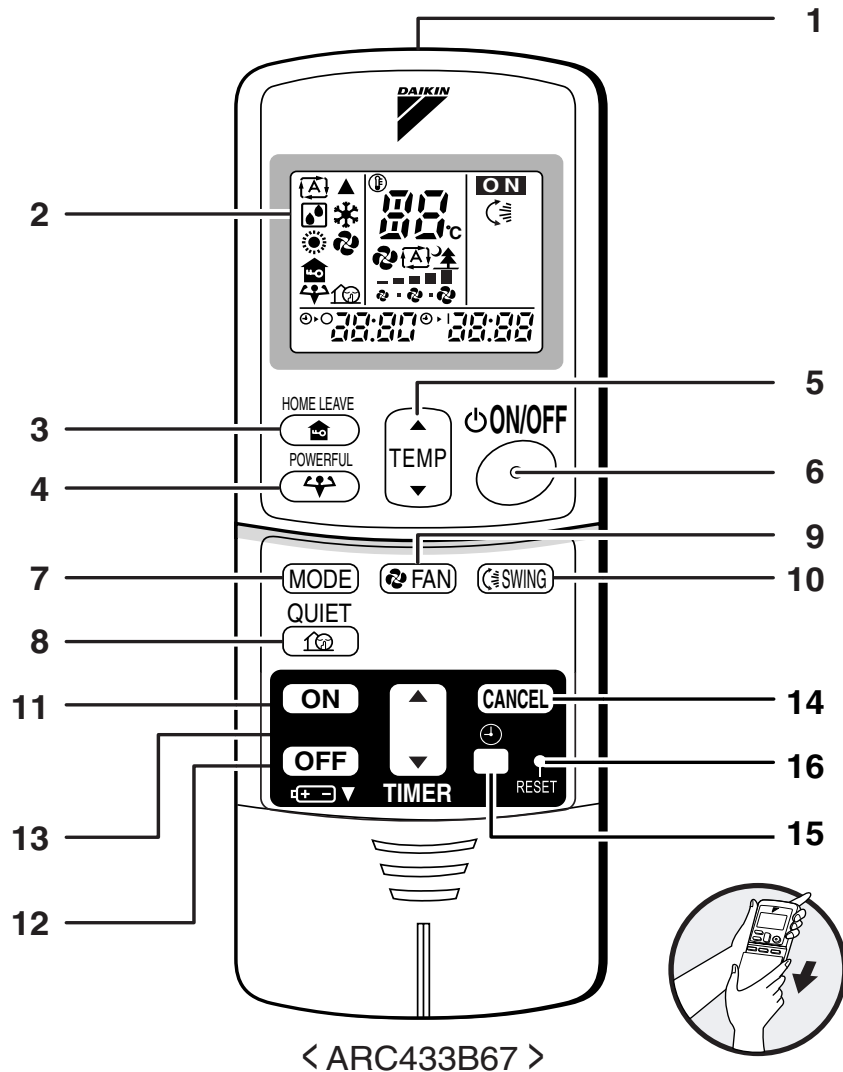

**1. Signal Transmitter:**

- It sends signals to the indoor unit.

**2. Display:**

- It displays the current settings.  
(In this illustration, each section is shown with all its displays ON for the purpose of explanation.)

**3. HOME LEAVE button:**

- for HOME LEAVE operation

**4. POWERFUL button:**

- for POWERFUL operation

**5. TEMPERATURE adjustment buttons:**

- It changes the temperature setting.

**6. ON/OFF button:**

- Press this button once to start operation.  
Press once again to stop it.

**7. MODE selector button:**

- It selects the operation mode.  
(AUTO/DRY/COOL/HEAT/FAN)

**8. QUIET button**

**9. FAN setting button:**

- It selects the air flow rate setting.

**10. SWING button**

**11. ON TIMER button**

**12. OFF TIMER button**

**13. TIMER Setting button:**

- It changes the time setting.

**14. TIMER CANCEL button:**

- It cancels the timer setting.

**15. CLOCK button**

**16. RESET button:**

- Restart the unit if it freezes.
- Use a thin object to push.

## Floor Standing Type

# Names of parts

## Indoor Unit

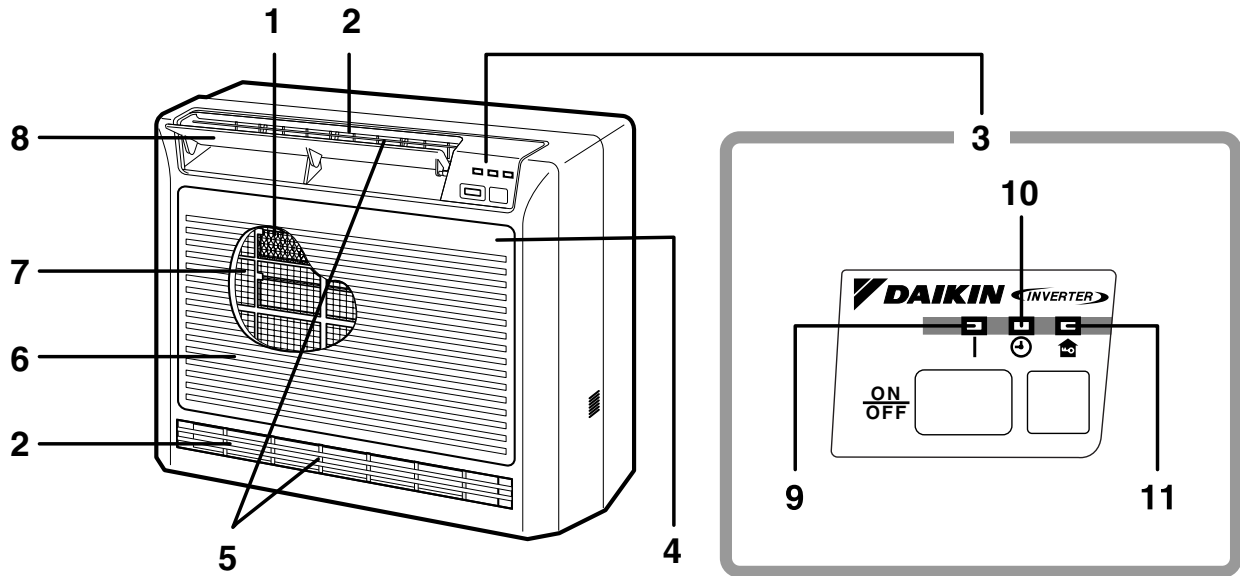

## Opening the front grille

How to open the grille:

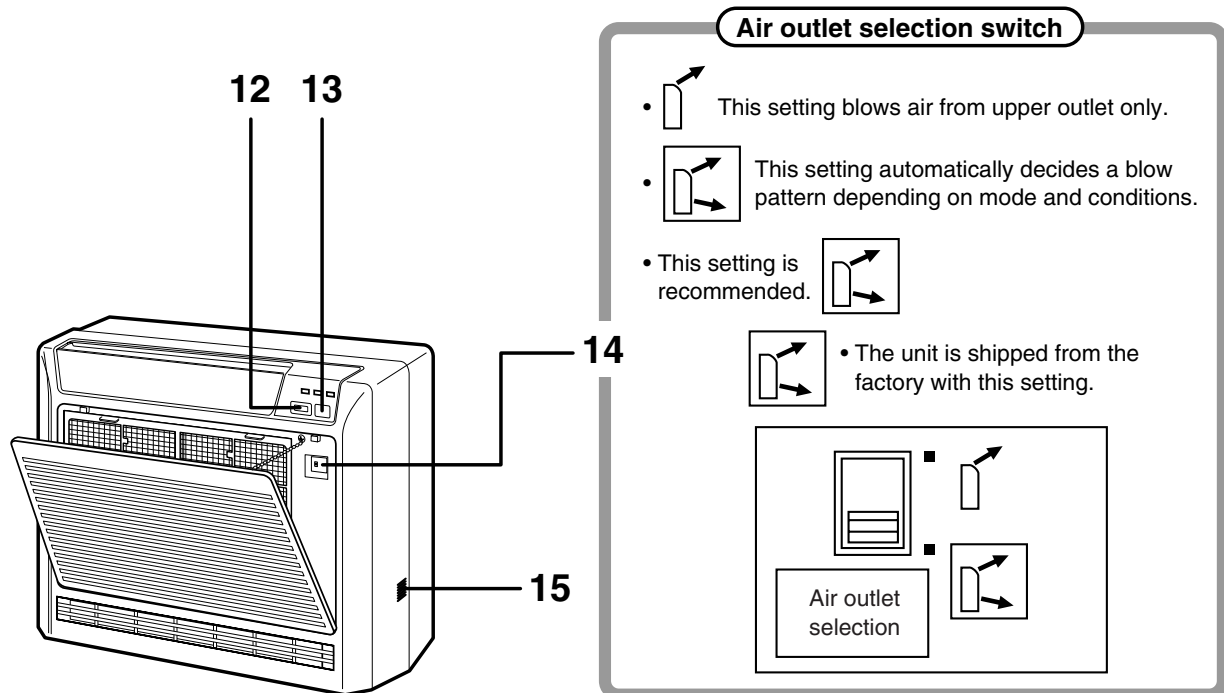

### ⚠ CAUTION

Before opening the front grille, be sure to stop the operation and turn the breaker OFF.  
Do not touch the metal parts on the inside of the indoor unit, as it may result in injury.



## ■ Outdoor Unit

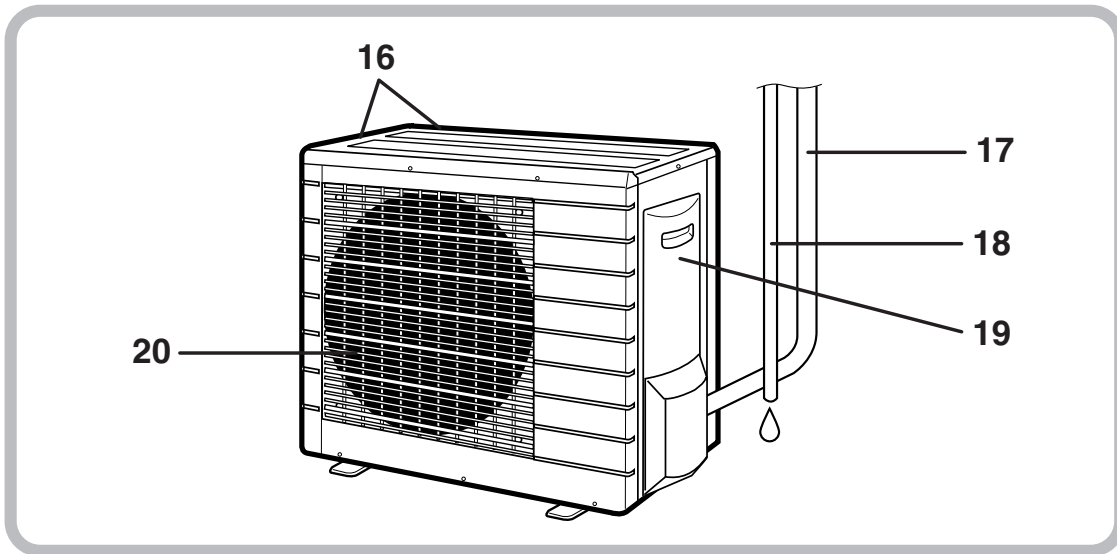

## ■ Indoor Unit

1. **Photocatalytic deodorizing filter and Air purifying filter:**
  - These filters are attached to the inside of the air filters.
2. **Air outlet**
3. **Display**
4. **Front grille**
5. **Louvers (vertical blades):**
  - The louvers are inside of the air outlet.
6. **Air inlet**
7. **Air filter**
8. **Flap (horizontal blade)**
9. **Operation lamp (green)**
10. **TIMER lamp (yellow)**
11. **HOME LEAVE lamp (red)**
12. **Indoor Unit ON/OFF switch:**
  - Push this switch once to start operation. Push once again to stop it.

- The operation mode refers to the following table.

Mode	Temperature setting	Air flow rate
AUTO	25°C	AUTO

- This switch is useful when the remote controller is missing.
13. **Signal receiver:**
    - Signals are received from the remote controller .
    - When the unit receives a signal, you will hear a short beep.
      - Operation start .....beep-beep
      - Settings changed .....beep
      - Operation stop .....beeeeeeep

### 14. Air outlet selection switch

### 15. Room temperature sensor:

- It senses the air temperature around the unit.

## ■ Outdoor Unit

16. **Air inlet:** (Back and side)
17. **Refrigerant piping and inter-unit cable**
18. **Drain hose**

### 19. Earth terminal:

- It is inside of this cover.

### 20. Air outlet

Appearance of the outdoor unit may differ from some models.

## ■ Remote Controller

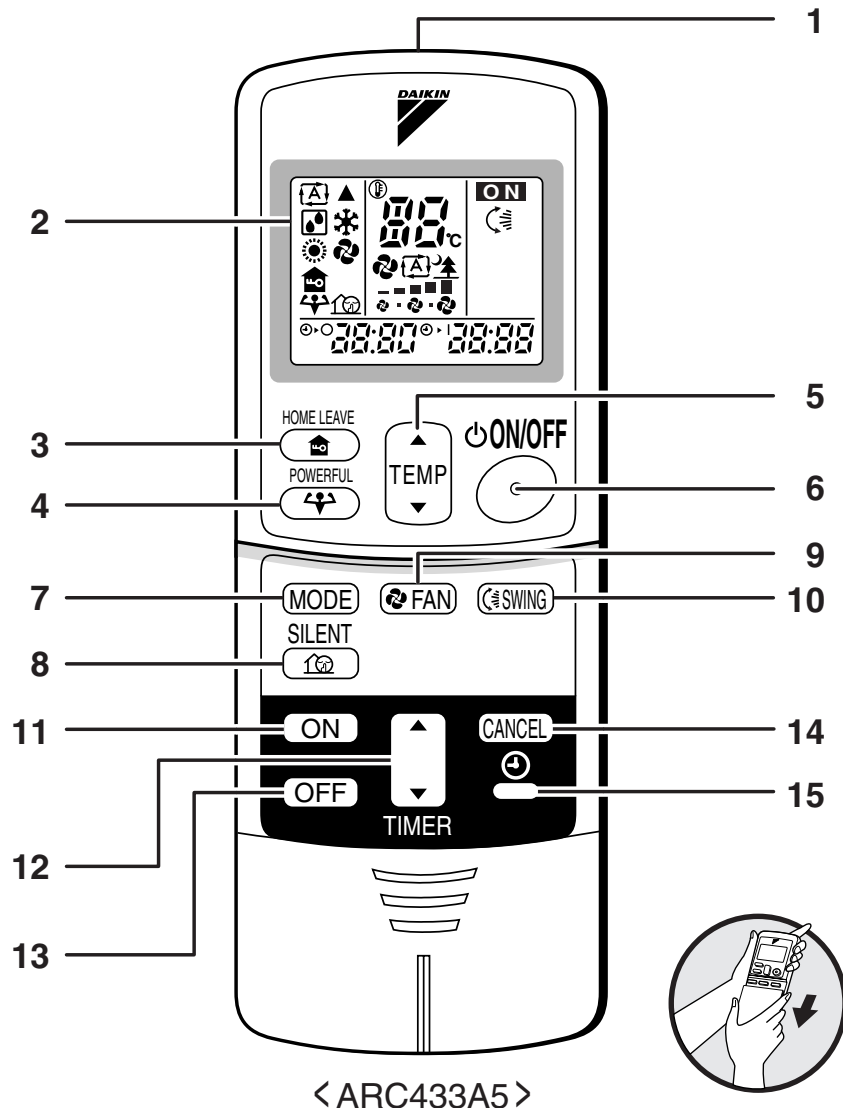

### 1. Signal transmitter:

- It sends signals to the indoor unit.

### 2. Display:

- It displays the current settings.  
(In this illustration, each section is shown with all its displays ON for the purpose of explanation.)

### 3. HOME LEAVE button:

for HOME LEAVE operation

### 4. POWERFUL button:

for POWERFUL operation

### 5. TEMPERATURE adjustment buttons:

- It changes the temperature setting.

### 6. ON/OFF button:

- Press this button once to start operation.  
Press once again to stop it.

### 7. MODE selector button:

- It selects the operation mode.  
(AUTO/DRY/COOL/HEAT/FAN)

### 8. SILENT button: for OUTDOOR UNIT SILENT operation

### 9. FAN setting button:

- It selects the air flow rate setting.

### 10. SWING button

### 11. ON TIMER button

### 12. TIMER Setting button:

- It changes the time setting.

### 13. OFF TIMER button

### 14. TIMER CANCEL button:

- It cancels the timer setting.

### 15. CLOCK button

## 2.1.4 Preparation Before Operation

# Preparation Before Operation

### ■ To set the batteries

1. Slide the front cover to take it off.
2. Set two dry batteries (AAA).
3. Set the front cover as before.

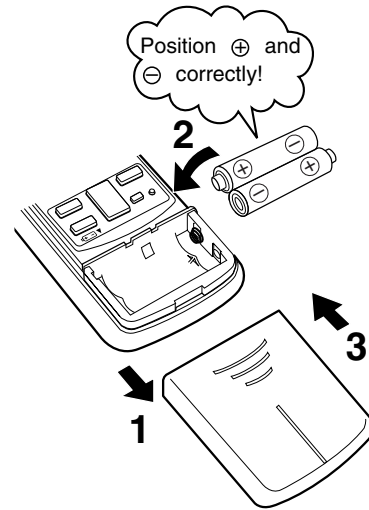

## ATTENTION

### ■ About batteries

- When replacing the batteries, use batteries of the same type, and replace the two old batteries together.
- When the system is not used for a long time, take the batteries out.
- We recommend replacing once a year, although if the remote controller display begins to fade or if reception deteriorates, please replace with new alkali batteries. Do not use manganese batteries.
- The attached batteries are provided for the initial use of the system.  
The usable period of the batteries may be short depending on the manufactured date of the air conditioner.

# Preparation Before Operation

## ■ To operate the remote controller

- To use the remote controller, aim the transmitter at the indoor unit. If there is anything to block signals between the unit and the remote controller, such as a curtain, the unit will not operate.
- Do not drop the remote controller. Do not get it wet.
- The maximum distance for communication is about 7 m.

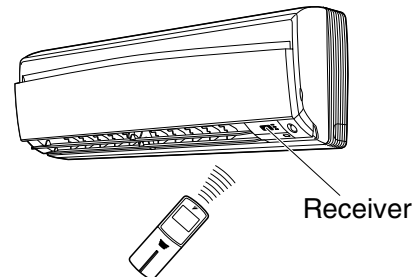

## ■ To fix the remote controller holder on the wall

1. Choose a place from where the signals reach the unit.
2. Fix the holder to a wall, a pillar, etc. with the screws supplied with the holder.
3. Place the remote controller in the remote controller holder.

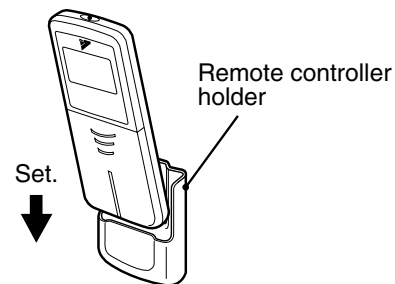

- To remove, pull it upwards.

## ATTENTION

### ■ About remote controller

- Never expose the remote controller to direct sunlight.
- Dust on the signal transmitter or receiver will reduce the sensitivity. Wipe off dust with soft cloth.
- Signal communication may be disabled if an electronic-starter-type fluorescent lamp (such as inverter-type lamps) is in the room. Consult the shop if that is the case.
- If the remote control signals happen to operate another appliance, move that appliance to somewhere else, or consult the shop.

## ■ To set the clock

### 1. Press “CLOCK button”.

0:00 is displayed.

 blinks.

### 2. Press “TIMER setting button” to set the clock to the present time.

Holding down “▲” or “▼” button rapidly increases or decreases the time display.

### 3. Press “CLOCK button”.

 blinks.

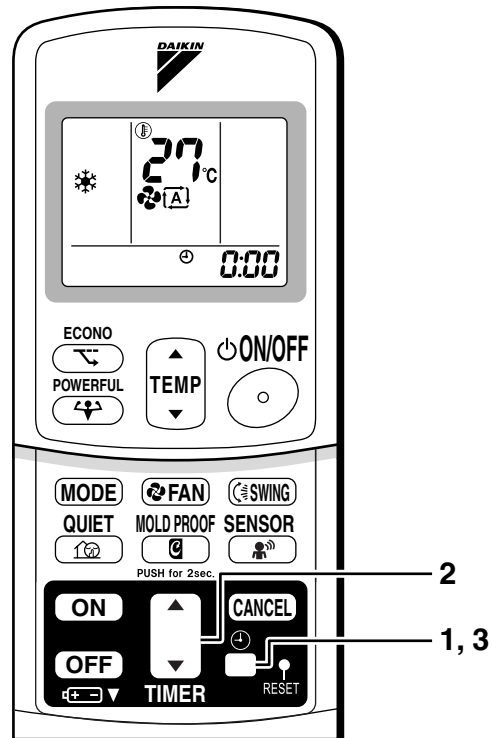

## ■ Turn the breaker ON

- Turning ON the breaker opens the flap, then closes it again. (This is a normal procedure.)

## NOTE

### ■ Tips for saving energy

- Be careful not to cool (heat) the room too much. Keeping the temperature setting at a moderate level helps save energy.
- Cover windows with a blind or a curtain. Blocking sunlight and air from outdoors increases the cooling (heating) effect.
- Clogged air filters cause inefficient operation and waste energy. Clean them once in about every two weeks.

#### Recommended temperature setting

For cooling: 26°C – 28°C  
For heating: 20°C – 24°C

### ■ Please note

- The air conditioner always consumes 15-35 watts of electricity even while it is not operating.
- If you are not going to use the air conditioner for a long period, for example in spring or autumn, turn the breaker OFF.
- Use the air conditioner in the following conditions.

Mode	Operating conditions	If operation is continued out of this range
COOL	Outdoor temperature: 10 to 46°C Indoor temperature: 18 to 32°C Indoor humidity: 80% max.	<ul style="list-style-type: none"> <li>• A safety device may work to stop the operation. (In multi system, it may work to stop the operation of the outdoor unit only.)</li> <li>• Condensation may occur on the indoor unit and drip.</li> </ul>
HEAT	Outdoor temperature: -10 to 20°C Indoor temperature: 10 to 30°C	<ul style="list-style-type: none"> <li>• A safety device may work to stop the operation.</li> </ul>
DRY	Outdoor temperature: 10 to 46°C Indoor temperature: 18 to 32°C Indoor humidity: 80% max.	<ul style="list-style-type: none"> <li>• A safety device may work to stop the operation.</li> <li>• Condensation may occur on the indoor unit and drip.</li> </ul>

- Operation outside this humidity or temperature range may cause a safety device to disable the system.

## 2.1.5 AUTO · DRY · COOL · HEAT · FAN Operation

# AUTO · DRY · COOL · HEAT · FAN Operation

The air conditioner operates with the operation mode of your choice.

From the next time on, the air conditioner will operate with the same operation mode.

### ■ To start operation

#### 1. Press “MODE selector button” and select a operation mode.

- Each pressing of the button advances the mode setting in sequence.

: AUTO

: DRY

: COOL

: HEAT

: FAN

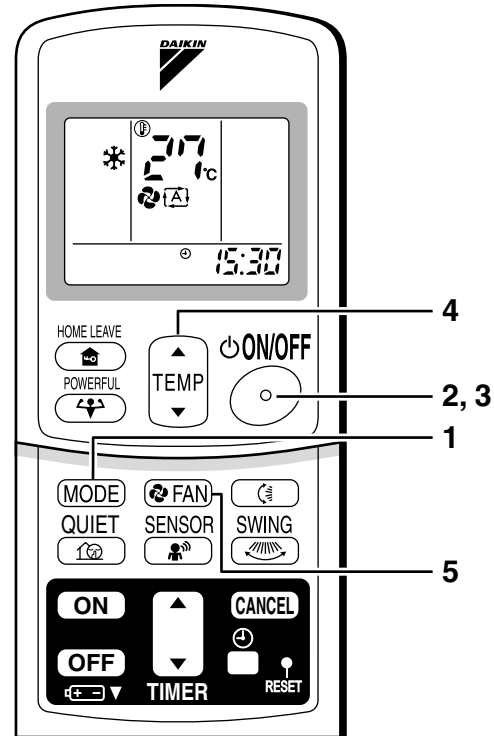
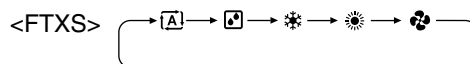
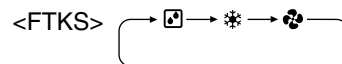

#### 2. Press “ON/OFF button”.

- The OPERATION lamp lights up.

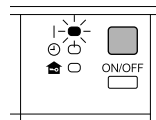

### ■ To stop operation

#### 3. Press “ON/OFF button” again.

- Then OPERATION lamp goes off.





### ■ To change the temperature setting

#### 4. Press “TEMPERATURE adjustment button”.

DRY or FAN mode	AUTO or COOL or HEAT mode
The temperature setting is not variable.	Press “▲” to raise the temperature and press “▼” to lower the temperature.
	Set to the temperature you like. 

## ■ To change the air flow rate setting

### 5. Press “FAN setting button”.

DRY mode	AUTO or HEAT or COOL or FAN mode
The air flow rate setting is not variable.	Five levels of air flow rate setting from “  ” to “  ” plus “  ” “  ” are available.
	

- Indoor unit quiet operation

When the air flow is set to “”, the noise from the indoor unit will become quieter. Use this when making the noise quieter.

The unit might lose capacity when the air flow rate is set to a weak level.

## NOTE

### ■ Note on HEAT operation

- Since this air conditioner heats the room by taking heat from outdoor air to indoors, the heating capacity becomes smaller in lower outdoor temperatures. If the heating effect is insufficient, it is recommended to use another heating appliance in combination with the air conditioner.
- The heat pump system heats the room by circulating hot air around all parts of the room. After the start of heating operation, it takes some time before the room gets warmer.
- In heating operation, frost may occur on the outdoor unit and lower the heating capacity. In that case, the system switches into defrosting operation to take away the frost.
- During defrosting operation, hot air does not flow out of indoor unit.

### ■ Note on COOL operation

- This air conditioner cools the room by blowing the hot air in the room outside, so if the outside temperature is high, performance drops.

### ■ Note on DRY operation

- The computer chip works to rid the room of humidity while maintaining the temperature as much as possible. It automatically controls temperature and fan strength, so manual adjustment of these functions is unavailable.

### ■ Note on AUTO operation

- In AUTO operation, the system selects a temperature setting and an appropriate operation mode (COOL or HEAT) based on the room temperature at the start of the operation.
- The system automatically reselects setting at a regular interval to bring the room temperature to user-setting level.
- If you do not like AUTO operation, you can manually select the operation mode and setting you like.

### ■ Note on air flow rate setting

- At smaller air flow rates, the cooling (heating) effect is also smaller.



## 2.1.6 Adjusting the Air Flow Direction

FTK(X)S 20 D, FTK(X)S 25/35 D(E)

# Adjusting the Air Flow Direction

You can adjust the air flow direction to increase your comfort.

### ■ To adjust the horizontal blades (flaps)

1. Press “SWING button”.
  - “” is displayed on the LCD and the flaps will begin to swing.
2. When the flaps have reached the desired position, press “SWING button” once more.
  - The flaps will stop moving.
  - “” disappears from the LCD.

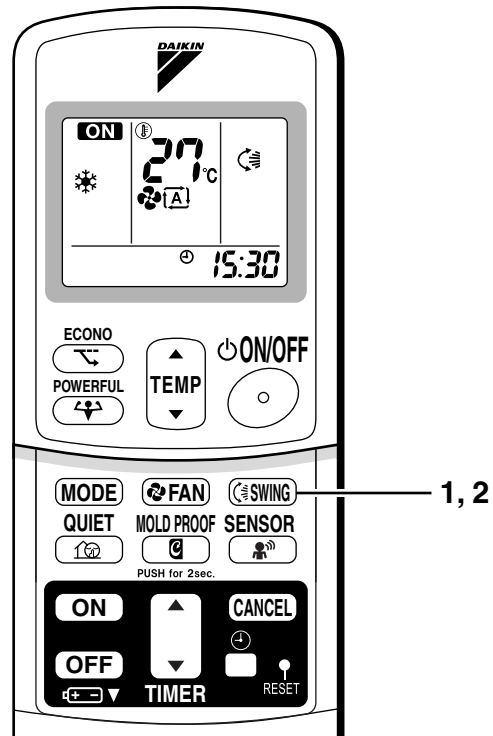



## ■ To adjust the vertical blades (louvres)

Hold the knob and move the louvres.

(You will find a knob on the left-side and the right-side blades.)

- When the unit is installed in the corner of a room, the direction of the louvres should be facing away from the wall.  
If they face the wall, the wall will block off the wind, causing the cooling (or heating) efficiency to drop.

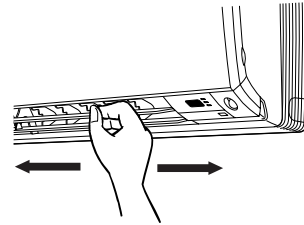

## Notes on flaps and louvres angles

- When “ **SWING button** ” is selected, the flaps swinging range depends on the operation mode. (See the figure.)
- If the unit is operated after being stopped with the flaps pointed down in cooling or dry operation, the flaps will automatically move to a horizontal position after about one hour to prevent condensation from forming on them.

### ■ ATTENTION

- Always use a remote controller to adjust the flaps angle. If you attempt to move it forcibly with hand when it is swinging, the mechanism may be broken.
- Be careful when adjusting the louvres. Inside the air outlet, a fan is rotating at a high speed.

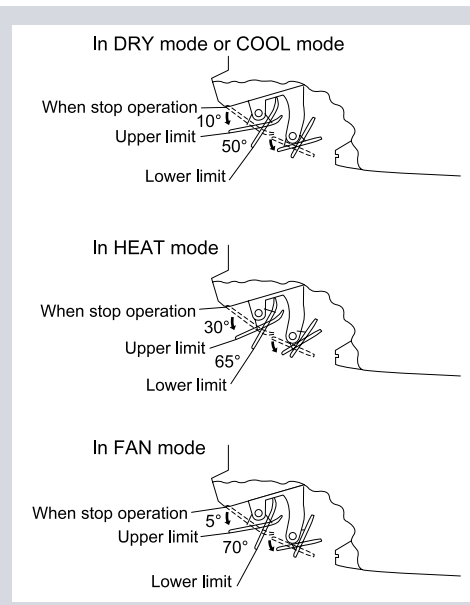





FTK(X)S 50/60/71 F

## Adjusting the Air Flow Direction



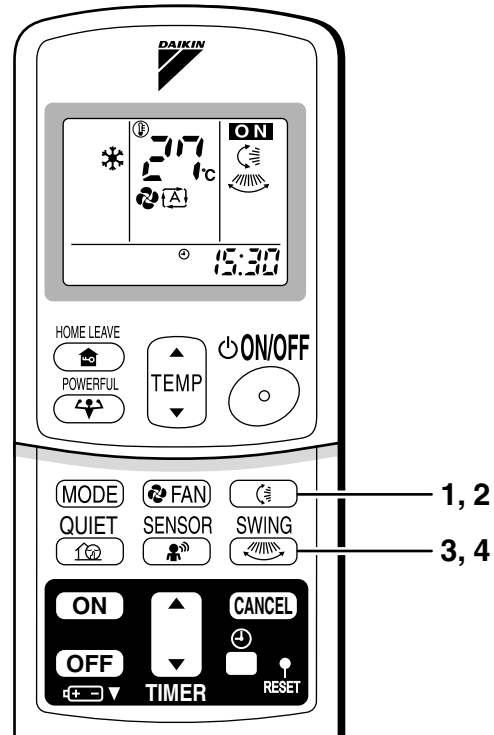

You can adjust the air flow direction to increase your comfort.

### ■ To adjust the horizontal blade (flap)

1. Press “SWING button ”.
  - “” is displayed on the LCD and the flaps will begin to swing.
2. When the flap has reached the desired position, press “SWING button ” once more.
  - The flap will stop moving.
  - “” disappears from the LCD.



### ■ To adjust the vertical blades (louvers)

3. Press “SWING button ”.
  4. When the louvers have reached the desired position, press the “SWING button ” once more.
- “” is displayed on the LCD.
  - The louvers will stop moving.
  - “” disappears from the LCD.

### ■ To 3-D Airflow

3. Press the “SWING button 

### ■ To cancel 3-D Airflow

4. Press either the “SWING button 

## Notes on louvers angles

### ■ ATTENTION

- Always use a remote controller to adjust the louvers angles. Inside the air outlet, a fan is rotating at a high speed.

## Notes on flap angle

- When “SWING button” is selected, the flaps swinging range depends on the operation mode. (See the figure.)

### Three-Dimensional (3-D) Airflow

- Using three-dimensional airflow circulates cold air, which tends to collect at the bottom of the room, and hot air, which tends to collect near the ceiling, throughout the room, preventing areas of cold and hot developing.

### ■ ATTENTION

- Always use a remote controller to adjust the flaps angle. If you attempt to move it forcibly with hand when it is swinging, the mechanism may be broken.
- Be careful when adjusting the louvers. Inside the air outlet, fan is rotating at a high speed.

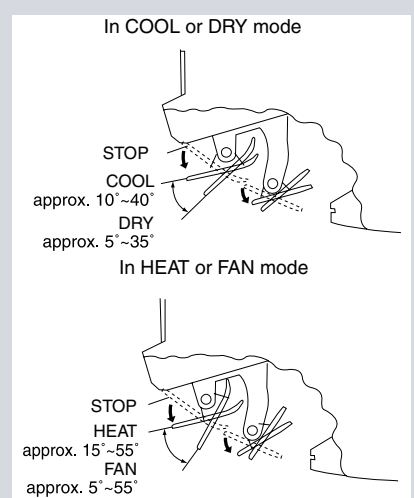

FLXS 25/35/50/60 B

# Adjusting the Air Flow Direction

You can adjust the air flow direction to increase your comfort.

## ■ To adjust the horizontal blade (flap)

1. Press “SWING button”.
  - “ is displayed on the LCD.
2. When the flaps have reached the desired position, press “SWING button” once more.

The flaps will stop moving.

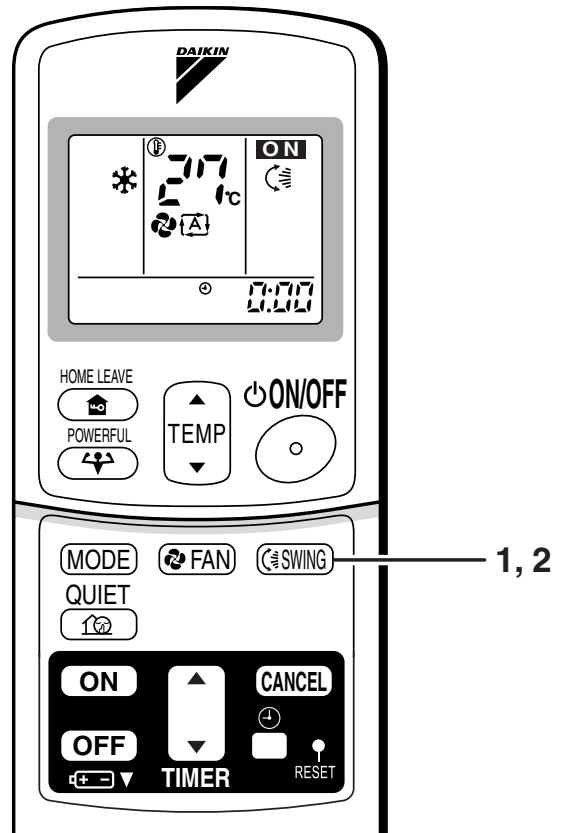

## ■ To adjust the vertical blades (louvers)

- When adjusting the louver, use a robust and stable stool and watch your steps carefully.  
Hold the knob and move the louvers.  
(You will find a knob on the left side and the right side blades.)

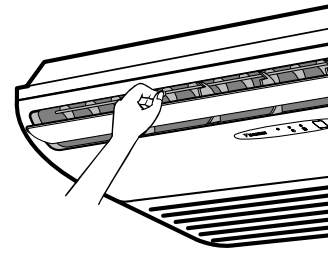

## Notes on flap and louvers angles

- Unless [SWING] is selected, you should set the flap at a near- horizontal angle in COOL or DRY mode to obtain the best performance.
- In COOL or DRY mode, if the flap is fixed at a downward position, the flap automatically moves in about 60 minutes to prevent condensation on it.

### ■ ATTENTION

- Always use a remote controller to adjust the flap angle.  
If you attempt to move it forcibly with hand when it is swinging, the mechanism may be broken.
- Be careful when adjusting the louvers. Inside the air outlet, a fan is rotating at a high speed.

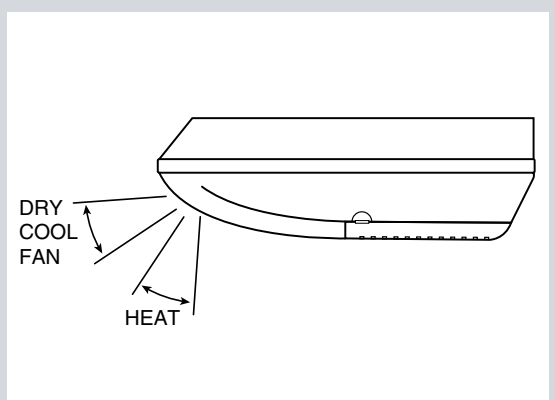

## Floor Standing Type

# Adjusting the Air Flow Direction

You can adjust the air flow direction to increase your comfort.

## ■ To adjust the horizontal blade (flap)

1. Press “SWING button”.
  - “” is displayed on the LCD.
2. When the flaps have reached the desired position, press “SWING button” once more.

The display will go blank.  
The flaps will stop moving.

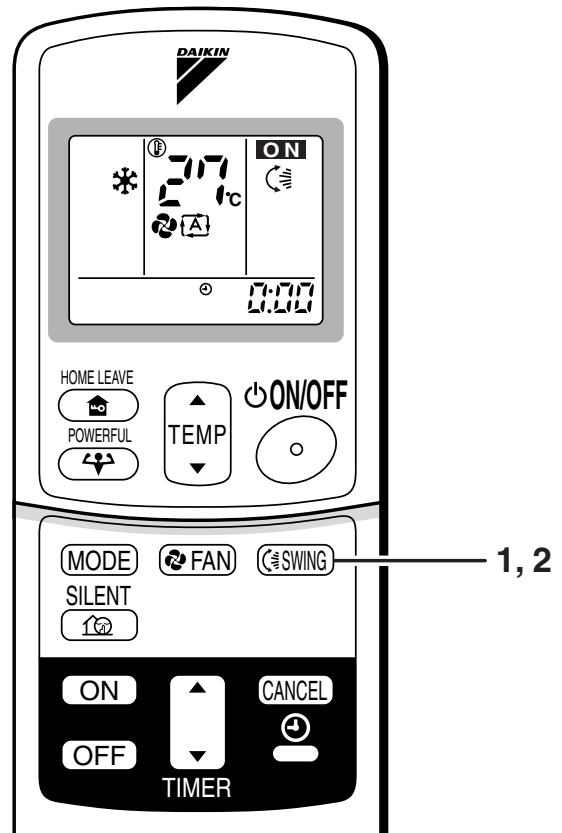

## ■ To adjust the vertical blades (louvers)

Hold the knob and move the louver.  
(You will find a knob on the left-side and the right-side blades.)

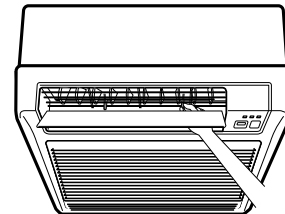

## Notes on flap and louvers angle

- Unless [ SWING ] is selected, you should set the flap at a near-horizontal angle in HEAT mode and at a upward position in COOL or DRY mode to obtain the best performance.

### ■ ATTENTION

- When adjusting the flap by hand, turn off the unit, and use the remote controller to restart the unit.
- Be careful when adjusting the louvers. Inside the air outlet, a fan is rotating at a high speed.

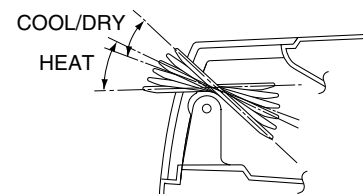

## ■ Air flow selection

- Make air flow selection according to what suits you.

### When setting the air flow selection switch to .

- Air conditioner automatically decides the appropriate blowing pattern depending on the operating mode/situation.

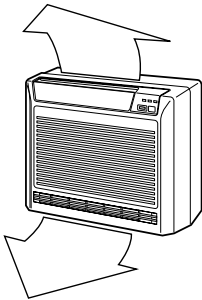
Operating mode	Situation	Blowing pattern
COOL mode	<ul style="list-style-type: none"> <li>• When the room has become fully cool, or when one hour has passed since turning on the air conditioner.</li> </ul>	<ul style="list-style-type: none"> <li>• So that air does not come into direct contact with people, air is blown upper air outlet, room temperature is equalised.</li> </ul>
	<ul style="list-style-type: none"> <li>• At start of operation or other times when the room is not fully cooled.</li> </ul>	<div style="text-align: center;">  </div> <ul style="list-style-type: none"> <li>• Air is blown from the upper and lower air outlets for high speed cooling during COOL mode, and for filling the room with warm air during HEAT mode.</li> </ul>
HEAT mode	<ul style="list-style-type: none"> <li>• At times other than below. (Normal time.)</li> </ul>	
	<ul style="list-style-type: none"> <li>• At start or when air temperature is low.</li> </ul>	

- During Dry mode, so that cold air does not come into direct contact with people, air is blown upper air outlet.

### When setting the air outlet selection switch to .

- Regardless of the operating mode or situation, air blows from the upper air outlet.
- Use this switch when you do not want air coming out of the lower air outlet. (While sleeping etc..)

## CAUTION

- Do not try to adjust the flap by hand.
- When adjusting by hand, the mechanism may not operate properly or condensation may drip from air outlets.

## 2.1.7 POWERFUL Operation

# POWERFUL Operation

POWERFUL operation quickly maximizes the cooling (heating) effect in any operation mode. You can get the maximum capacity .

### ■ To start POWERFUL operation

#### 1. Press “POWERFUL button”.

- POWERFUL operation ends in 20 minutes. Then the system automatically operates again with the settings which were used before POWERFUL operation.
- When using POWERFUL operation, there are some functions which are not available.
- “” is displayed on the LCD.

### ■ To cancel POWERFUL operation

#### 2. Press “POWERFUL button” again.

- “” disappears from the LCD.

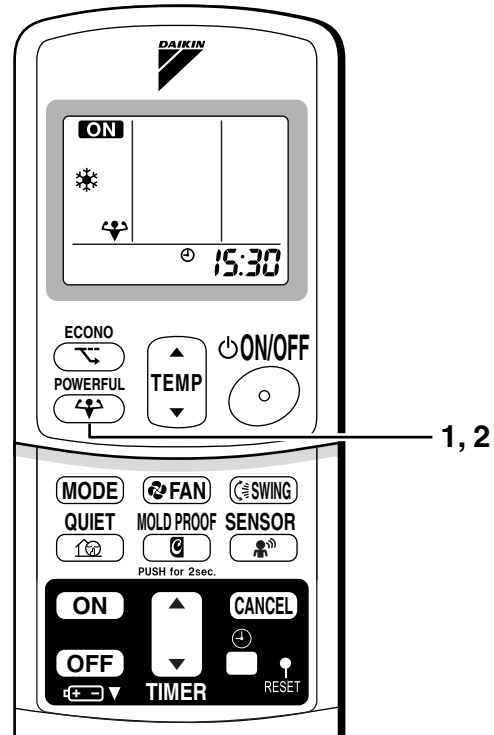

## NOTE

### ■ Notes on POWERFUL operation

- POWERFUL Operation cannot be used together with ECONO or QUIET Operation. Priority is given to the function of whichever button is pressed last.
- POWERFUL Operation can only be set when the unit is running. Pressing the operation stop button causes the settings to be canceled, and the “” disappears from the LCD.
- **In COOL and HEAT mode**  
To maximize the cooling (heating) effect, the capacity of outdoor unit must be increased and the air flow rate be fixed to the maximum setting.  
The temperature and air flow settings are not variable.
- **In DRY mode**  
The temperature setting is lowered by 2.5°C and the air flow rate is slightly increased.
- **In FAN mode**  
The air flow rate is fixed to the maximum setting.
- **When using priority-room setting**  
See “Note for multi system”.



## 2.1.8 OUTDOOR UNIT QUIET Operation

# OUTDOOR UNIT QUIET Operation

OUTDOOR UNIT QUIET operation lowers the noise level of the outdoor unit by changing the frequency and fan speed on the outdoor unit. This function is convenient during night.

### ■ To start OUTDOOR UNIT QUIET operation

#### 1. Press “QUIET button”.

- “” is displayed on the LCD.

### ■ To cancel OUTDOOR UNIT QUIET operation

#### 2. Press “QUIET button” again.

- “” disappears from the LCD.

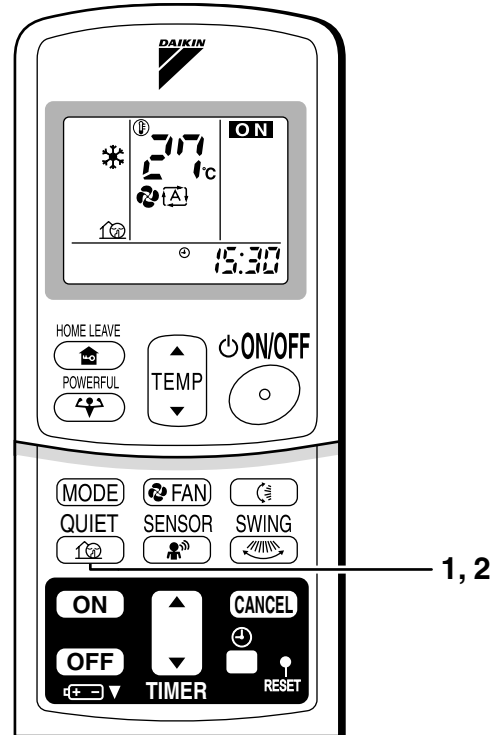

## NOTE

### ■ Note on OUTDOOR UNIT QUIET operation

- If using a multi system, this function will work only when the OUTDOOR UNIT QUIET operation is set on all operated indoor units.  
However, if using priority-room setting, see “Note for multi system”
- This function is available in COOL, HEAT, and AUTO modes.  
(This is not available in FAN and DRY mode.)
- POWERFUL operation and OUTDOOR UNIT QUIET operation cannot be used at the same time.  
Priority is given to the function of whichever button is pressed last.
- If operation is stopped using the remote controller or the main unit ON/OFF switch when using OUTDOOR UNIT QUIET operation, “” will remain on the remote controller display.

## 2.1.9 ECONO Operation

# ECONO Operation

ECONO operation is a function which enables efficient operation by lowering the maximum power consumption value.

### ■ To start ECONO operation

1. Press “ECONO button” .
  - “” is displayed on the LCD.

### ■ To cancel ECONO operation

2. Press “ECONO button” again.
  - “” disappears from the LCD.

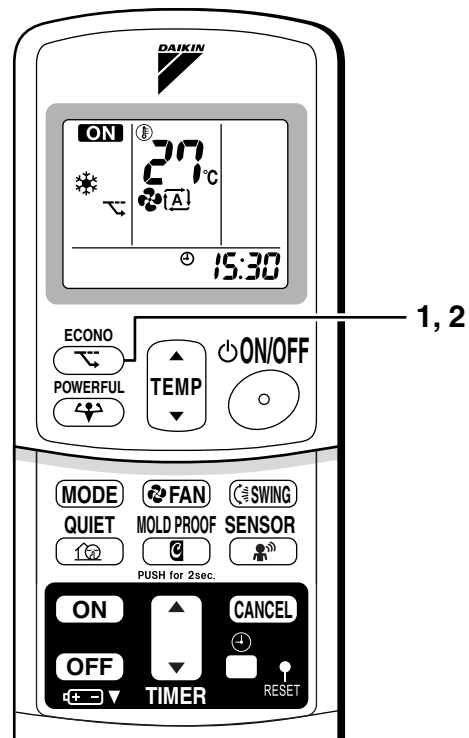

### NOTE

- ECONO Operation can only be set when the unit is running. Pressing the operation stop button causes the settings to be canceled, and the “” disappears from the LCD.
- ECONO operation is a function which enables efficient operation by limiting the power consumption of the outdoor unit (operating frequency).
- ECONO operation functions in AUTO, COOL, DRY, and HEAT modes.
- POWERFUL operation and ECONO operation cannot be used at the same time. Priority is given to the function of whichever button is pressed last.
- Power consumption may not drop even if ECONO operation is used, when the level of power consumption is already low.

## 2.1.10 MOLD PROOF Operation

# MOLD PROOF Operation

MOLD PROOF operation is a function which reduces the spread of mold by using Fan mode to lower the humidity inside the indoor unit.

### ■ To set MOLD PROOF operation

1. Press and hold the MOLD PROOF button for two seconds.
  - “” is displayed on the LCD.

### ■ To cancel MOLD PROOF operation

2. Press and hold the MOLD PROOF button for two seconds one more time.
  - “” disappears from the LCD.

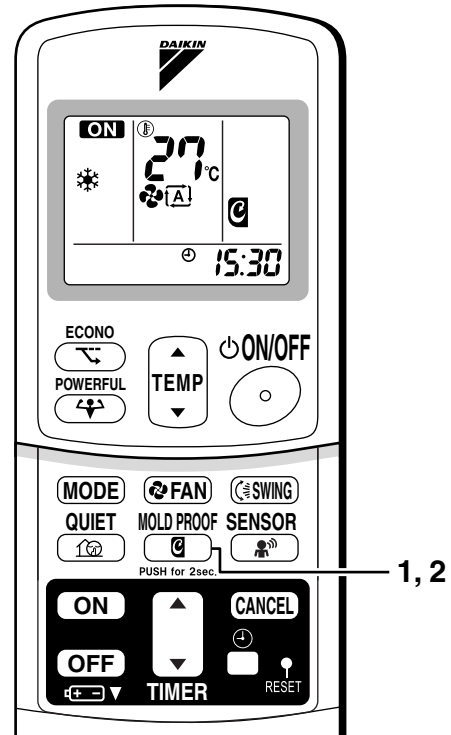

### NOTE

- MOLD PROOF operation will operate for approximately one hour after dry or cooling mode is turned off.
- This function is not designed to remove existing dust or mold.
- MOLD PROOF operation is not available when the unit is turned off using the OFF TIMER.

## 2.1.11 HOME LEAVE Operation

# HOME LEAVE Operation

HOME LEAVE operation is a function which allows you to record your preferred temperature and air flow rate settings.

### ■ To start HOME LEAVE operation

#### 1. Press “HOME LEAVE button”.

- “” is displayed on the LCD.
- The HOME LEAVE lamp lights up.

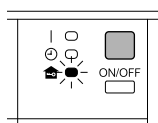

### ■ To cancel HOME LEAVE operation

#### 2. Press “HOME LEAVE button” again.



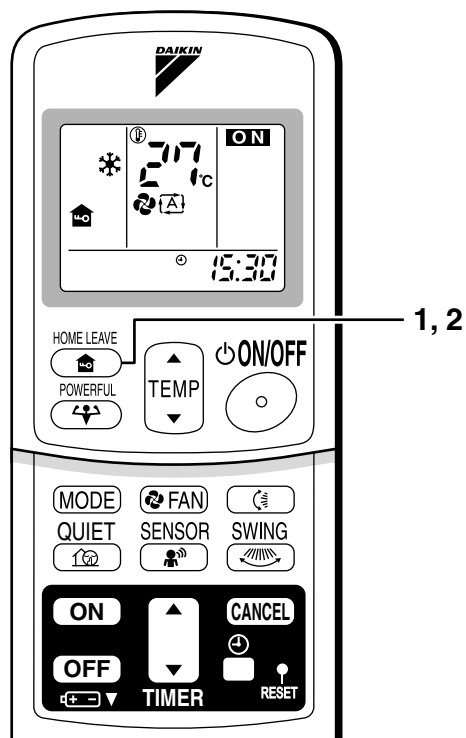



- “” disappears from the LCD.
- The HOME LEAVE lamp goes off.





### Before using HOME LEAVE operation.

#### To set the temperature and air flow rate for HOME LEAVE operation

When using HOME LEAVE operation for the first time, please set the temperature and air flow rate for HOME LEAVE operation. Record your preferred temperature and air flow rate.

	Initial setting		Selectable range	
	temperature	Air flow rate	temperature	Air flow rate
Cooling	25°C	“  ”	18-32°C	5 step, “  ” and “  ”
Heating	25°C	“  ”	10-30°C	5 step, “  ” and “  ”

1. Press “HOME LEAVE button”. Make sure “” is displayed in the remote controller display.

2. Adjust the set temperature with “” or “” as you like.

3. Adjust the air flow rate with “FAN” setting button as you like.

Home leave operation will run with these settings the next time you use the unit. To change the recorded information, repeat steps 1 – 3.

## ■ What's the HOME LEAVE operation?

Is there a set temperature and air flow rate which is most comfortable, a set temperature and air flow rate which you use the most? HOME LEAVE operation is a function that allows you to record your favorite set temperature and air flow rate. You can start your favorite operation mode simply by pressing the HOME LEAVE button on the remote controller. This function is convenient in the following situations.

## ■ Useful in these cases

### 1. Use as an energy-saving mode.

Set the temperature 2-3°C higher (cooling) or lower (heating) than normal. Setting the fan strength to the lowest setting allows the unit to be used in energy-saving mode. Also convenient for use while you are out or sleeping.

#### • Every day before you leave the house...

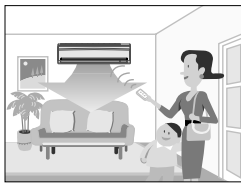

When you go out, push the "HOME LEAVE Operation" button, and the air conditioner will adjust capacity to reach the preset temperature for HOME LEAVE Operation.



When you return, you will be welcomed by a comfortably air conditioned room.

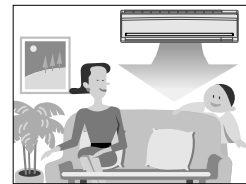

Push the "HOME LEAVE Operation" button again, and the air conditioner will adjust capacity to the set temperature for normal operation.

#### • Before bed...

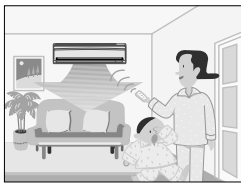

Set the unit to HOME LEAVE Operation before leaving the living room when going to bed.

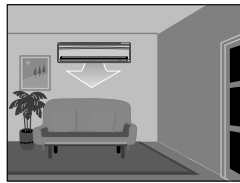

The unit will maintain the temperature in the room at a comfortable level while you sleep.



When you enter the living room in the morning, the temperature will be just right. Disengaging HOME LEAVE Operation will return the temperature to that set for normal operation. Even the coldest winters will pose no problem!

### 2. Use as a favorite mode.

Once you record the temperature and air flow rate settings you most often use, you can retrieve them by pressing HOME LEAVE button. You do not have to go through troublesome remote controller operations.

## NOTE

- Once the temperature and air flow rate for HOME LEAVE operation are set, those settings will be used whenever HOME LEAVE operation is used in the future. To change these settings, please refer to the "Before using HOME LEAVE operation" section above.
- HOME LEAVE operation is only available in COOL and HEAT mode. Cannot be used in AUTO, DRY, and FAN mode.
- HOME LEAVE operation runs in accordance with the previous operation mode (COOL or HEAT) before using HOME LEAVE operation.
- HOME LEAVE operation and POWERFUL operation cannot be used at the same time. Last button that was pressed has priority.
- The operation mode cannot be changed while HOME LEAVE operation is being used.
- When operation is shut off during HOME LEAVE operation, using the remote controller or the indoor unit ON/OFF switch, "🏠" will remain on the remote controller display.

## 2.1.12 INTELLIGENT EYE Operation

FTK(X)S 20/25/35 D, FTK(X)S 25/35 E

# INTELLIGENT EYE Operation

“INTELLIGENT EYE” is the infrared sensor which detects the human movement.

### ■ To start INTELLIGENT EYE operation

1. Press “SENSOR button”.
  - “” is displayed on the LCD.

### ■ To cancel the INTELLIGENT EYE operation

2. Press “SENSOR button” again.
  - “” disappears from the LCD.

[EX.]

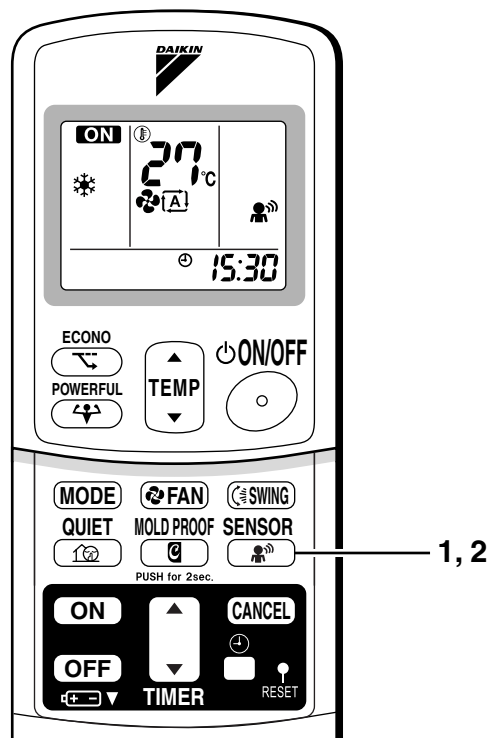
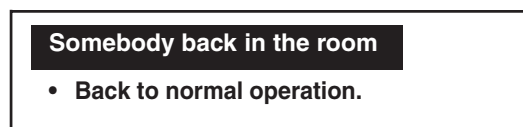
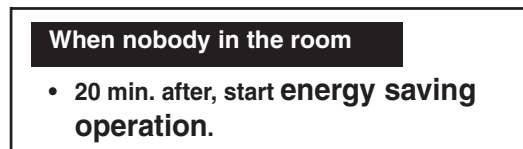

## “INTELLIGENT EYE” is useful for Energy Saving

### ■ Energy saving operation

- Change the temperature  $-2^{\circ}\text{C}$  in heating /  $+2^{\circ}\text{C}$  in cooling /  $+2^{\circ}\text{C}$  in dry mode from set temperature.
- Decrease the air flow rate slightly in fan operation. (In FAN mode only)

## Notes on “INTELLIGENT EYE”

- Application range is as follows.

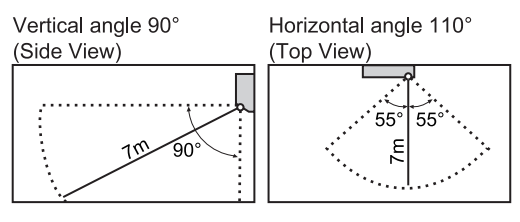

- Sensor may not detect moving objects further than 7m away. (Check the application range)
- Sensor detection sensitivity changes according to indoor unit location, the speed of passersby, temperature range, etc.
- The sensor also mistakenly detects pets, sunlight, fluttering curtains and light reflected off of mirrors as passersby.
- INTELLIGENT EYE operation will not go on during powerful operation.
- Night set mode will not go on during you use INTELLIGENT EYE operation.

## ⚠ CAUTION

- Do not place large objects near the sensor.  
Also keep heating units or humidifiers outside the sensor's detection area. This sensor can detect objects it shouldn't as well as not detect objects it should.
- Do not hit or violently push the INTELLIGENT EYE sensor. This can lead to damage and malfunction.

FTK(X)S 50/60/71 F, FTKS 50/60/71 B

# INTELLIGENT EYE Operation

“INTELLIGENT EYE” is the infrared sensor which detects the human movement.

## ■ To start INTELLIGENT EYE operation

1. Press “SENSOR button”.
  - “” is displayed on the LCD.

## ■ To cancel the INTELLIGENT EYE operation

2. Press “SENSOR button” again.
  - “” disappears from the LCD.

[EX.]

**When somebody in the room**

- Normal operation



**When nobody in the room**

- 20 min. after, start energy saving operation.



**Somebody back in the room**

- Back to normal operation.

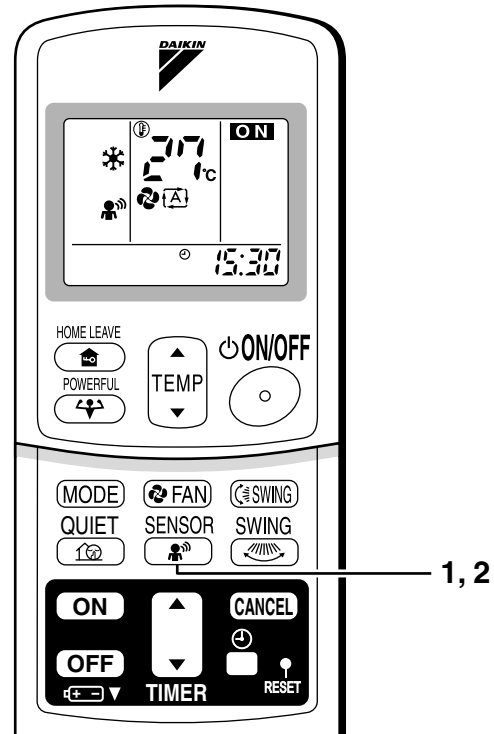



## “INTELLIGENT EYE” is useful for Energy Saving.

### ■ Energy saving operation

- Change the temperature  $-2^{\circ}\text{C}$  in heating /  $+2^{\circ}\text{C}$  in cooling /  $+1^{\circ}\text{C}$  in dry mode from set temperature.
- Decrease the air flow rate slightly in fan operation. (In FAN mode only)

## Notes on “INTELLIGENT EYE”

- Application range is as follows.

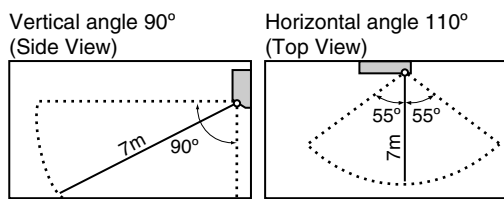

- Sensor may not detect moving objects further than 7m away. (Check the application range)
- Sensor detection sensitivity changes according to indoor unit location, the speed of passersby, temperature range, etc.
- The sensor also mistakenly detects pets, sunlight, fluttering curtains and light reflected off of mirrors as passersby.
- INTELLIGENT EYE operation will not go on during powerful operation.
- Night set mode will not go on during you use INTELLIGENT EYE operation.

## CAUTION

- Do not place large objects near the sensor.  
Also keep heating units or humidifiers outside the sensor's detection area. This sensor can detect objects it shouldn't as well as not detect objects it should.
- Do not hit or violently push the INTELLIGENT EYE sensor. This can lead to damage and malfunction.

## 2.1.13 TIMER Operation

# TIMER Operation

Timer functions are useful for automatically switching the air conditioner on or off at night or in the morning. You can also use OFF TIMER and ON TIMER in combination.

### ■ To use OFF TIMER operation

- Check that the clock is correct.  
If not, set the clock to the present time.

#### 1. Press “OFF TIMER button”.

0:00 is displayed.

⊖○ blinks.

#### 2. Press “TIMER Setting button” until the time setting reaches the point you like.

- Every pressing of either button increases or decreases the time setting by 10 minutes. Holding down either button changes the setting rapidly.

#### 3. Press “OFF TIMER button” again.

- The TIMER lamp lights up.

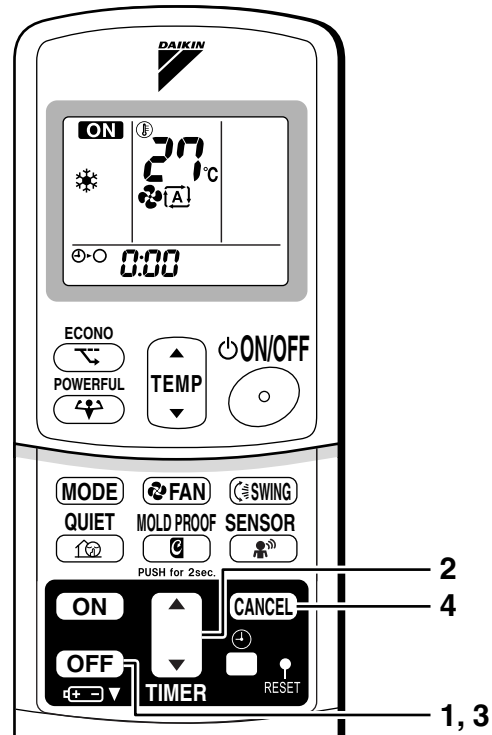
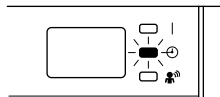

### ■ To cancel the OFF TIMER operation

#### 4. Press “CANCEL button”.

- The TIMER lamp goes off.

## NOTE

- When TIMER is set, the present time is not displayed.
- Once you set ON, OFF TIMER, the time setting is kept in the memory. (The memory is canceled when remote controller batteries are replaced.)
- When operating the unit via the ON/OFF Timer, the actual length of operation may vary from the time entered by the user. (Maximum approx. 10 minutes)

#### ■ NIGHT SET MODE

When the OFF TIMER is set, the air conditioner automatically adjusts the temperature setting (0.5°C up in COOL, 2.0°C down in HEAT) to prevent excessive cooling (heating) for your pleasant sleep.

## ■ To use ON TIMER operation

- Check that the clock is correct. If not, set the clock to the present time

### 1. Press “ON TIMER button”.

6:00 is displayed.

⊕-| blinks.

### 2. Press “TIMER Setting button” until the time setting reaches the point you like.

- Every pressing of either button increases or decreases the time setting by 10 minutes. Holding down either button changes the setting rapidly.

### 3. Press “ON TIMER button” again.

- The TIMER lamp lights up.

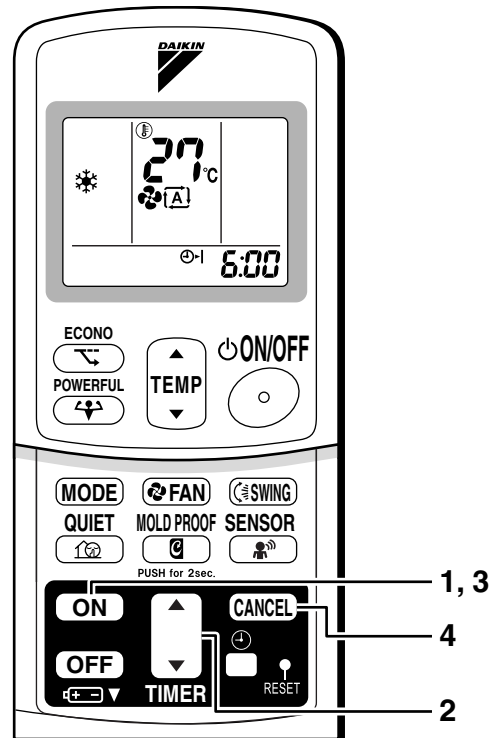
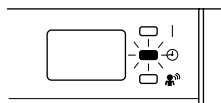

## ■ To cancel ON TIMER operation

### 4. Press “CANCEL button”.

- The TIMER lamp goes off.

## ■ To combine ON TIMER and OFF TIMER

- A sample setting for combining the two timers is shown below.

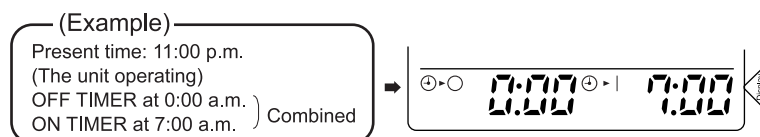

## ATTENTION

### ■ In the following cases, set the timer again.

- After a breaker has turned OFF.
- After a power failure.
- After replacing batteries in the remote controller.

## 2.1.14 Note for Multi System

# Note for Multi System

### << What is a “Multi System”? >>

This system has one outdoor unit connected to multiple indoor units.

## ■ Selecting the Operation Mode

### 1. With the Priority Room Setting present but inactive or not present.

When more than one indoor unit is operating, priority is given to the first unit that was turned on.

In this case, set the units that are turned on later to the same operation mode (\*1) as the first unit.

Otherwise, they will enter the Standby Mode, and the operation lamp will flash; this does not indicate malfunction.

(\*1)

- COOL, DRY and FAN mode may be used at the same time.
- AUTO mode automatically selects COOL mode or HEAT mode based on the room temperature. Therefore, AUTO mode is available when selecting the same operation mode as that of the room with the first unit to be turned on.

#### <CAUTION>

Normally, the operation mode in the room where the unit is first run is given priority, but the following situations are exceptions, so please keep this in mind.

If the operation mode of the first room is **FAN Mode**, then using **Heating Mode** in any room after this will give priority to **heating**. In this situation, the air conditioner running in FAN Mode will go on standby, and the operation lamp will flash.

### 2. With the Priority Room Setting active.

See “Priority Room Setting” on the next page.

## ■ NIGHT QUIET Mode (Available only for cooling operation)

NIGHT QUIET Mode requires initial programming during installation. Please consult your retailer or dealer for assistance. NIGHT QUIET Mode reduces the operation noise of the outdoor unit during the night time hours to prevent annoyance to neighbors.

- The NIGHT QUIET Mode is activated when the temperature drops 5°C or more below the highest temperature recorded that day. Therefore, when the temperature difference is less than 5°C, this function will not be activated.
- NIGHT QUIET Mode reduces slightly the cooling efficiency of the unit.

## ■ OUTDOOR UNIT QUIET Operation

### 1. With the Priority Room Setting present but inactive or not present.

When using the OUTDOOR UNIT QUIET operation feature with the Multi system, set all indoor units to OUTDOOR UNIT QUIET operation using their remote controllers.

When clearing OUTDOOR UNIT QUIET operation, clear one of the operating indoor units using their remote controller. However OUTDOOR UNIT QUIET operation display remains on the remote controller for other rooms.

We recommend you release all rooms using their remote controllers.

### 2. With the Priority Room Setting active.

See “Priority Room Setting” on the next page.

## ■ Cooling / Heating Mode Lock (Available only for heat pump models)

The Cooling / Heating Mode Lock requires initial programming during installation. Please consult your retailer or dealer for assistance. The Cooling / Heating Mode Lock sets the unit forcibly to either Cooling or Heating Mode. This function is convenient when you wish to set all indoor units connected to the Multi system to the same operation mode.

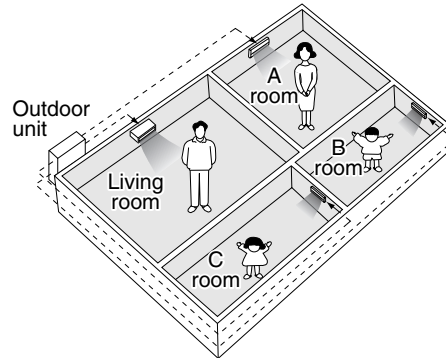

## ■ Priority Room Setting

The Priority Room Setting requires initial programming during installation. Please consult your retailer or dealer for assistance.

The room designated as the Priority Room takes priority in the following situations;

### 1. Operation Mode Priority.

As the operation mode of the Priority Room takes precedence, the user can select a different operation mode from other rooms.

〈Example〉

\* Room A is the Priority Room in the examples.

When COOL mode is selected in Room A while operating the following modes in Room B,C and D :

Operation mode in Room B, C and D	Status of Room B, C and D when the unit in Room A is in COOL mode
COOL or DRY or FAN	Current operation mode maintained
HEAT	The unit enters Standby Mode. Operation resumes when the Room A unit stops operating.
AUTO	If the unit is set to COOL mode, operation continues. If set to HEAT mode, it enters Standby Mode. Operation resumes when the Room A unit stops operating.

### 2. Priority when POWERFUL operation is used.

〈Example〉

\* Room A is the Priority Room in the examples.

The indoor units in Rooms A,B,C and D are all operating. If the unit in Room A enters POWERFUL operation, operation capacity will be concentrated in Room A. In such a case, the cooling (heating) efficiency of the units in Rooms B,C and D may be slightly reduced.

### 3. Priority when using OUTDOOR UNIT QUIET operation.

〈Example〉

\* Room A is the Priority Room in the examples.

Just by setting the unit in Room A to QUIET operation, the air conditioner starts OUTDOOR UNIT QUIET operation.

You don't have to set all the operated indoor units to QUIET operation.

## 2.1.15 Care and Cleaning

FTK(X)S 20 D, FTK(X)S 25/35 E

# Care and Cleaning

**⚠ CAUTION** Before cleaning, be sure to stop the operation and turn the breaker OFF.

## Units

### ■ Indoor unit, Outdoor unit and Remote controller

1. Wipe them with dry soft cloth.

### ■ Front panel

#### 1. Open the front panel.

- Hold the panel by the tabs on the two sides and lift it until it stops with a click.

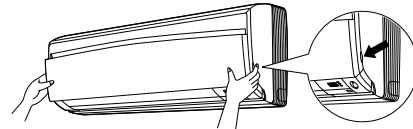

#### 2. Remove the front panel.

- Lift the front panel up, slide it slightly to the right, and remove it from the horizontal axle.

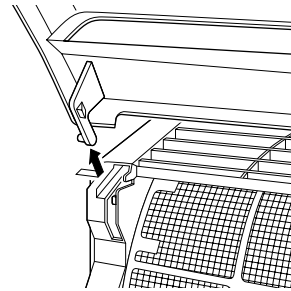

#### 3. Clean the front panel.

- Wipe it with a soft cloth soaked in water.
- Only neutral detergent may be used.
- In case of washing the panel with water, dry it with cloth, dry it up in the shade after washing.

#### 4. Attach the front panel.

- Set the 2 keys of the front panel into the slots and push them in all the way.
- Close the front panel slowly and push the panel at the 3 points.  
( 1 on each side and 1 in the middle.)

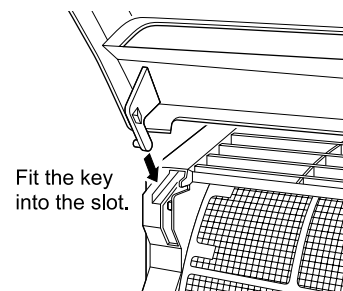

### ⚠ CAUTION

- Don't touch the metal parts of the indoor unit. If you touch those parts, this may cause an injury.
- When removing or attaching the front panel, use a robust and stable stool and watch your steps carefully.
- When removing or attaching the front panel, support the panel securely with hand to prevent it from falling.
- For cleaning, do not use hot water above 40°C, benzene, gasoline, thinner, nor other volatile oils, polishing compound, scrubbing brushes, nor other hand stuff.
- After cleaning, make sure that the front panel is securely fixed.

## Filters

1. **Open the front panel.**
2. **Pull out the air filters.**
  - Push a little upwards the tab at the center of each air filter, then pull it down.
3. **Take off the Titanium Apatite Photocatalytic Air-Purifying Filter.**
  - Hold the recessed parts of the frame and unhook the four claws.
4. **Clean or replace each filter.**  
See below.

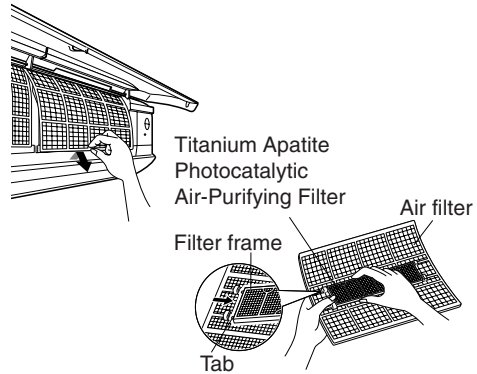
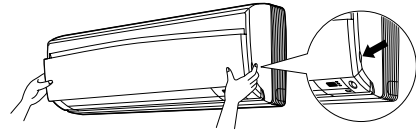

5. **Set the air filter, Titanium Apatite Photocatalytic Air-Purifying Filter as they were and close the front panel.**
  - Insert claws of the filters into slots of the front panel. Close the front panel slowly and push the panel at the 3 points. (1 on each sides and 1 in the middle.)

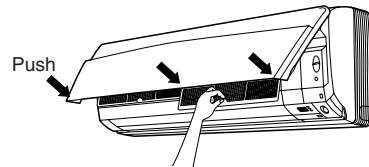

### ■ Air Filter

1. **Wash the air filters with water or clean them with vacuum cleaner.**
  - If the dust does not come off easily, wash them with neutral detergent thinned with lukewarm water, then dry them up in the shade.
  - It is recommended to clean the air filters every two weeks.

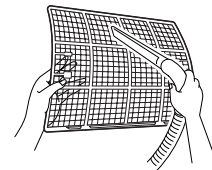

### ■ Titanium Apatite Photocatalytic Air-Purifying Filter.

The Titanium Apatite Photocatalytic Air-Purifying Filter can be renewed by washing it with water once every 6 months. We recommend replacing it once every 3 years.



#### [ Maintenance ]

1. **Remove dust with a vacuum cleaner and wash lightly with water.**
2. **If it is very dirty, soak it for 10 to 15 minutes in water mixed with a neutral cleaning agent.**
3. **Do not remove filter from frame when washing with water.**
4. **After washing, shake off remaining water and dry in the shade.**
5. **Since the material is made out of paper, do not wring out the filter when removing water from it.**

#### [ Replacement ]

1. **Remove the tabs on the filter frame and replace with a new filter.**
  - Dispose of the old filter as flammable waste.

## NOTE

- Operation with dirty filters:
  - (1) cannot deodorize the air.                      (2) cannot clean the air.
  - (3) results in poor heating or cooling.            (4) may cause odour.
- To order Titanium Apatite Photocatalytic Air-Purifying Filter contact to the service shop there you bought the air conditioner.
- Dispose of old filters as burnable waste.

Item	Part No.
Titanium Apatite Photocatalytic Air-Purifying Filter. (without frame) 1 set	KAF970A46

## Check

Check that the base, stand and other fittings of the outdoor unit are not decayed or corroded.
Check that nothing blocks the air inlets and the outlets of the indoor unit and the outdoor unit.
Check that the drain comes smoothly out of the drain hose during COOL or DRY operation. <ul style="list-style-type: none"> <li>• If no drain water is seen, water may be leaking from the indoor unit. Stop operation and consult the service shop if this is the case.</li> </ul>

## ■ Before a long idle period

- 1. Operate the “fan only” for several hours on a fine day to dry out the inside.**
  - Press “MODE selector button” and select “fan” operation.
  - Press “ON/OFF button” and start operation.
- 2. Clean the air filters and set them again.**
- 3. Take out batteries from the remote controller.**
- 4. Turn OFF the breaker for the room air conditioner.**
  - When a multi outdoor unit is connected, make sure the heating operation is not used at the other room before you use the fan operation.



FTK(X)S 50/60/71 F

# Care and Cleaning



**CAUTION** Before cleaning, be sure to stop the operation and turn the breaker OFF.

## Units

### Indoor unit, outdoor unit and remote controller

1. Wipe them with dry soft cloth.

### Front panel

#### 1. Open the front panel.

- Hold the panel by the tabs on the two sides and lift it until it stops with a click.

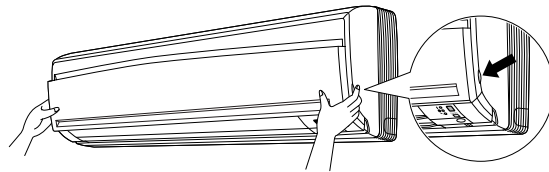

#### 2. Remove the front panel.

- Open the front panel further while sliding it to either the left or right and pulling it toward you. This will disconnect the rotation dowel on one side. Then disconnect the rotation dowel on the other side in the same manner.

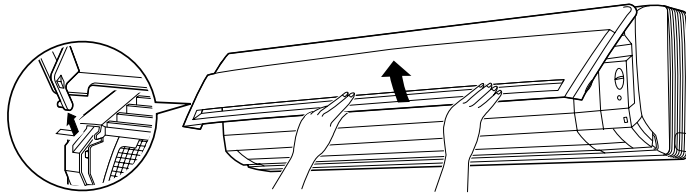

#### 3. Clean the front panel.

- Wipe it with a soft cloth soaked in water.
- Only neutral detergent may be used.
- In case of washing the panel with water, dry it with cloth, dry it up in the shade after washing.

#### 4. Attach the front panel.

- Align the rotation dowels on the left and right of the front panel with the slots, then push them all the way in.
- Close the front panel slowly. (Press the panel at both sides and the center.)

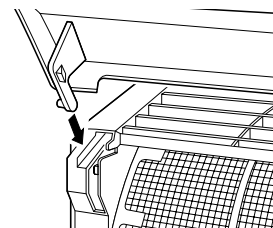

### CAUTION

- Don't touch the metal parts of the indoor unit. If you touch those parts, this may cause an injury.
- When removing or attaching the front panel, use a robust and stable stool and watch your steps carefully.
- When removing or attaching the front panel, support the panel securely with hand to prevent it from falling.
- For cleaning, do not use hot water above 40°C, benzine, gasoline, thinner, nor other volatile oils, polishing compound, scrubbing brushes, nor other hand stuff.
- After cleaning, make sure that the front panel is securely fixed.

## Filters

### 1. Open the front panel.

### 2. Pull out the air filters.

- Push a little upwards the tab at the center of each air filter, then pull it down.

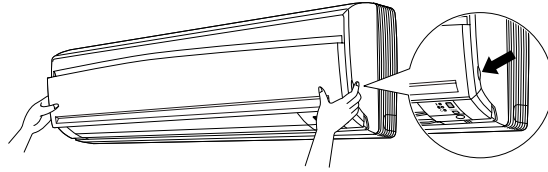

### 3. Take off the Titanium Apatite Photocatalytic Air-Purifying Filter.

- Press the top of the air-cleaning filter onto the tabs (3 at top). Then press the bottom of the filter up slightly, and press it onto the tabs (3 at bottom).

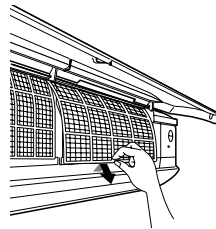

tabs (3 at top)

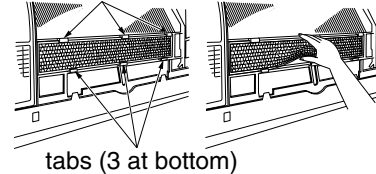

tabs (3 at bottom)

### 4. Clean or replace each filter.

See figure.

### 5. Set the air filter and the Titanium Apatite Photocatalytic Air-Purifying Filter as they were and close the front panel.

- Press the front panel at both sides and the center.

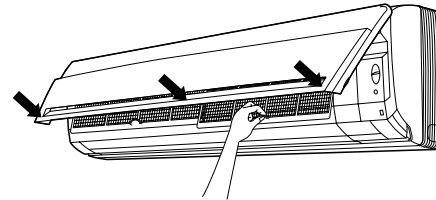

## ■ Air Filter

### 1. Wash the air filters with water or clean them with vacuum cleaner.

- If the dust does not come off easily, wash them with neutral detergent thinned with lukewarm water, then dry them up in the shade.
- It is recommended to clean the air filters every two weeks.

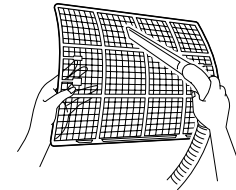

## ■ Titanium Apatite Photocatalytic Air-purifying Filter

The Titanium Apatite Photocatalytic Air-Purifying Filter can be renewed by washing it with water once every 6 months. We recommend replacing it once every 3 years.

### [ Maintenance ]

1. Remove dust with a vacuum cleaner and wash lightly with water.
2. If it is very dirty, soak it for 10 to 15 minutes in water mixed with a neutral cleaning agent.
3. After washing, shake off remaining water and dry in the shade.
4. Since the material is made out of polyester, do not wring out the filter when removing water from it.

### [ Replacement ]

1. Remove the tabs on the filter frame and replace with a new filter.
  - Dispose of the old filter as non-flammable waste.

## NOTE

- Operation with dirty filters:
  - (1) cannot deodorize the air.                      (2) cannot clean the air.
  - (3) results in poor heating or cooling.            (4) may cause odour.
- To order Titanium Apatite Photocatalytic Air-Purifying Filter contact to the service shop there you bought the air conditioner.
- Dispose of old filters as non-flammable waste.

Item	Part No.
Titanium Apatite Photocatalytic Air-Purifying Filter. (without frame) 1 set	KAF952B42

## Check

Check that the base, stand and other fittings of the outdoor unit are not decayed or corroded.
Check that nothing blocks the air inlets and the outlets of the indoor unit and the outdoor unit.
Check that the drain comes smoothly out of the drain hose during COOL or DRY operation. <ul style="list-style-type: none"> <li>• If no drain water is seen, water may be leaking from the indoor unit. Stop operation and consult the service shop if this is the case.</li> </ul>

## ■ Before a long idle period

1. Operate the “FAN only” for several hours on a fine day to dry out the inside.
  - Press “MODE button” and select “FAN” operation.
  - Press “ON/OFF button” and start operation.
2. After operation stops, turn off the breaker for the room air conditioner.
3. Clean the air filters and set them again.
4. Take out batteries from the remote controller.

NOTE) When a multi outdoor unit is connected, make sure the heating operation is not used at the other room before you use the fan operation.

FTK(X)S 50/60/71 D, FTKS 50/60/71 B

# Care and Cleaning

**⚠ CAUTION** Before cleaning, be sure to stop the operation and turn the breaker OFF.

## Units

### ■ Indoor unit, Outdoor unit and Remote controller

1. Wipe them with dry soft cloth.

### ■ Front grille

#### 1. Open the front grille.

- Hold the grille by the tabs on the two sides and lift it until it stops with a click.

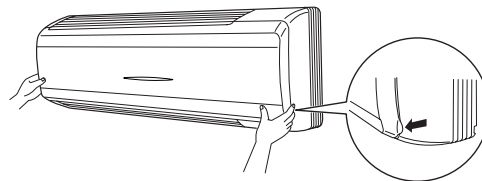

#### 2. Remove the front grille.

- Open the front panel further while sliding it to either the left or right and pulling it toward you. This will disconnect the rotation dowel on one side. Then disconnect the rotation dowel on the other side in the same manner.

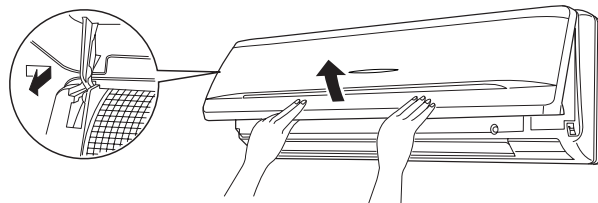

#### 3. Clean the front grille

- Wipe it with a soft cloth soaked in water.
- Only neutral detergent may be used.
- In case of washing the grille with water, dry it with cloth, dry it up in the shade after washing.

#### 4. Attach the front grille

- Align the rotation dowels on the left and right of the front panel with the slots, then push them all the way in.
- Close the front panel slowly. (Press the panel at both sides and the center.)

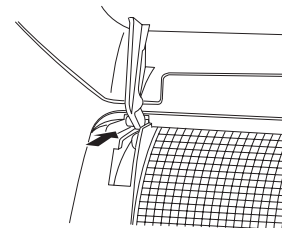

### ⚠ CAUTION

- When the packaging materials are attached to the front panel, please remove them.
- Don't touch the metal parts of the indoor unit. If you touch those parts, this may cause an injury.
- When removing or attaching the front grille, use a robust and stable stool and watch your steps carefully.
- When removing or attaching the front grille, support the grille securely with hand to prevent it from falling.
- For cleaning, do not use hot water above 40 °C, benzine, gasoline, thinner, nor other volatile oils, polishing compound, scrubbing brushes, nor other hand stuff.
- After cleaning, make sure that the front grille is securely fixed.

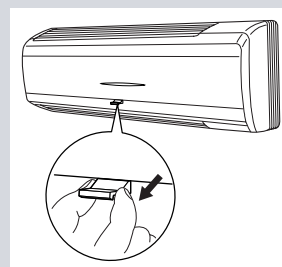

## Filters

1. Open the front grille.
2. Pull out the air filters.

- Push a little upwards the tab at the center of each air filter, then pull it down.

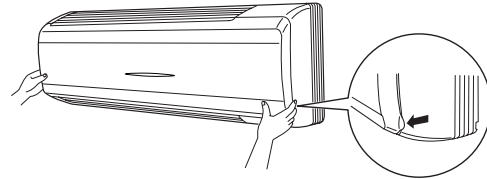

3. Take off the air purifying filter with photocatalytic deodorizing function.

- Press the top of the air-cleaning filter onto the tabs (3 tabs at top). Then press the bottom of the filter up slightly, and press it onto the tabs (2 at bottom)(3 at bottom).

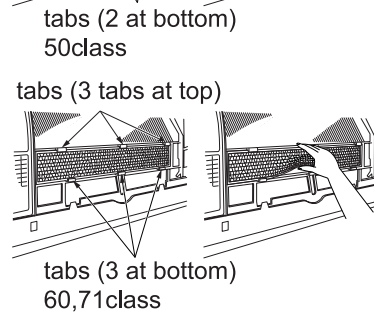
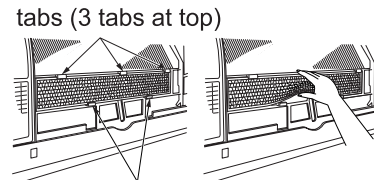
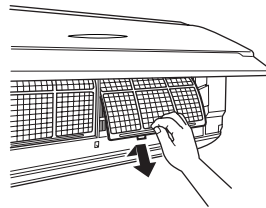

4. Clean or replace each filter.

See figure.

5. Set the air filter and the air purifying filter with photocatalytic deodorizing function as they were and close the front grille.

- Press the front panel at both sides and the center.

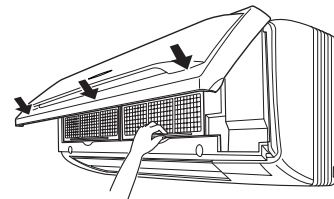

### ■ Air Filter

1. Wash the air filters with water or clean them with vacuum cleaner.

- If the dust does not come off easily, wash them with neutral detergent thinned with lukewarm water, then dry them up in the shade.
- It is recommended to clean the air filters every two weeks.

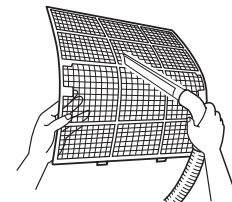

### ■ Air purifying filter with photocatalytic deodorizing function. (gray)

The air purifying filter with photocatalytic deodorizing function can be renewed by washing it with water once every 6 months. We recommend replacing it once every 3 years.

#### [ Maintenance ]

1. Remove dust with a vacuum cleaner and wash lightly with water.
2. If it is very dirty, soak it for 10 to 15 minutes in water mixed with a neutral cleaning agent.
3. After washing, shake off remaining water and dry in the shade.
4. Since the material is made out of paper, do not wring out the filter when removing water from it.

#### [ Replacement ]

1. Remove the tabs on the filter frame and replace with a new filter.

- Dispose of the old filter as flammable waste.

## Check

Check that the base, stand and other fittings of the outdoor unit are not decayed or corroded.
Check that nothing blocks the air inlets and the outlets of the indoor unit and the outdoor unit.
Check that the drain comes smoothly out of the drain hose during COOL or DRY operation. <ul style="list-style-type: none"> <li>If no drain water is seen, water may be leaking from the indoor unit. Stop operation and consult the service shop if this is the case.</li> </ul>

## ■ Before a long idle period

- Operate the “FAN only” for several hours on a fine day to dry out the inside.**
  - Press “MODE” button and select “FAN” operation.
  - Press “ON/OFF” button and start operation.
- After operation stops, turn off the breaker for the room air conditioner.**
- Clean the air filters and set them again.**
- Take out batteries from the remote controller.**
  - When a multi outdoor unit is connected, make sure the heating operation is not used at the other room before you use the fan operation. (page 22)

## NOTE

- Operation with dirty filters:
  - (1) cannot deodorize the air.                      (2) cannot clean the air.
  - (3) results in poor heating or cooling.            (4) may cause odour.
- To order air purifying filter with photocatalytic deodorizing function contact to the service shop there you bought the air conditioner.
- Dispose of old filters as burnable waste.

Item	Part No.
Air purifying filter with photocatalytic deodorizing function. (without frame) 1 set	KAF952A42

## Duct Connected Type

# Care and Cleaning



**CAUTION** • Only a qualified service person is allowed to perform maintenance.

- Before cleaning, be sure to stop the operation and turn the breaker OFF.

## ■ Cleaning the air filter

### 1. Removing the air filter.

- Rear suction  
Pull the bottom side of the air filter backwards, over the 3 bends.
- Bottom suction  
Pull the filter over the 3 bends situated at the backside of the unit.

### 2. Cleaning the air filter.

Remove dust from the air filter using a vacuum cleaner and gently rinse them in cool water. Do not use detergent or hot water to avoid filter shrinking or deformation. After cleaning dry them in the shade.

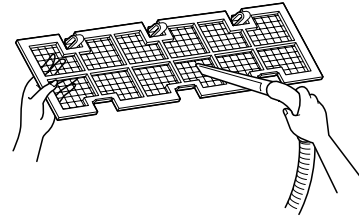

### 3. Replacing the air filter.

- Rear suction  
Hook the filter behind the flap situated at the top of the unit and push the other side gently over the 3 bends.
- Bottom suction  
Hook the filter behind the flap situated at the middle of the unit and push the other side gently over the 3 bends.

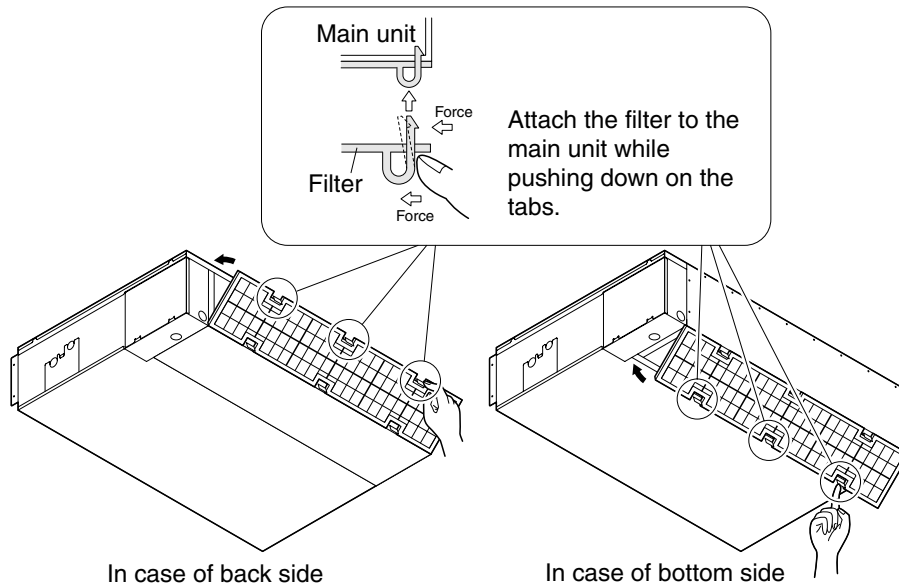

## ■ Cleaning the drain pan

- Clean the drain pan periodically, or drain piping may be clogged with dust and may result in water leakage. Ask your DAIKIN dealer to clean them.
- Prepare a cover locally to prevent any dust in the air around the indoor unit from getting in the drain pan, if there is a great deal of dust present.

### CAUTION

- Do not operate the air conditioner without filters, this to avoid dust accumulation inside the unit.
- Do not remove the air filter except when cleaning. Unnecessary handling may damage the filter.
- Do not use gasoline, benzene, thinner, polishing powder, liquid insecticide, It may cause discoloring or warping.
- Do not let the indoor unit get wet. It may cause an electric shock or a fire.
- Operation with dusty air filters lowers the cooling and heating capacity and wastes energy.
- The suction grille is option.
- Do not use water or air of 50°C or higher for cleaning air filters and outside panels.

### Check

Check that the base, stand and other fittings of the outdoor unit are not decayed or corroded.
Check that nothing blocks the air inlets and the outlets of the indoor unit and the outdoor unit.
Check that the drain comes smoothly out of the drain hose during COOL or DRY operation. <ul style="list-style-type: none"> <li>• If no drain water is seen, water may be leaking from the indoor unit. Stop operation and consult the service shop if this is the case.</li> </ul>



## ■ Before a long idle period

- 1. Operate the “Fan only” for several hours on a fine day to dry out the inside.**
  - Press “MODE selector button” and select “FAN” operation.
  - Press “ON/OFF button” and start operation.
- 2. After operation stops, turn off the breaker for the room air conditioner.**
- 3. Clean the air filters and set them again.**
- 4. Take out batteries from the remote controller.**
  - When a multi outdoor unit is connected, make sure the heating operation is not used at the other room before you use the fan operation.



## Floor/Ceiling Suspended Dual Type

# Care and Cleaning



**CAUTION** Before cleaning, be sure to stop the operation and turn the breaker OFF.

## Units

### ■ Indoor unit, Outdoor unit and Remote controller

1. Wipe them with dry soft cloth.

### ■ Front grille

#### 1. Open the front grille.

- Hold the grille by the tabs on the two sides and lift it until it stops.

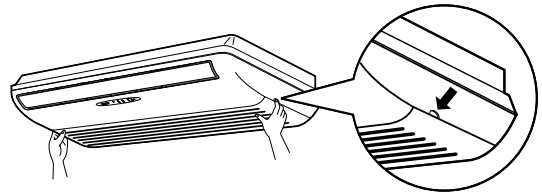

#### 2. Clean the front grille

- Wipe it with a soft cloth soaked in water.
- Only neutral detergent may be used.
- In case of washing the grille with water, dry it with cloth, dry it up in the shade after washing.

#### 3. Close the front grille

- Push the grille at the 5 points indicated by ↑.
- Operation without air filters may result in troubles as dust will accumulate inside the indoor unit.

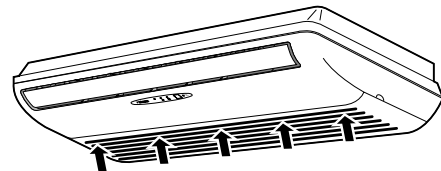

### CAUTION

- Don't touch the metal parts of the indoor unit. If you touch those parts, this may cause an injury.
- When opening and closing the front grille, use a robust and stable stool and watch your steps carefully.
- When opening and closing the front grille, support the grille securely with hand to prevent it from falling.
- For cleaning, do not use hot water above 40 °C, benzene, gasoline, thinner, nor other volatile oils, polishing compound, scrubbing brushes, nor other hand stuff.
- After cleaning, make sure that the front grille is securely fixed.

## Filters

### 1. Open the front grille.

### 2. Pull out the air filters.

- Push upwards the tab at the center of each air filter, then pull it down.

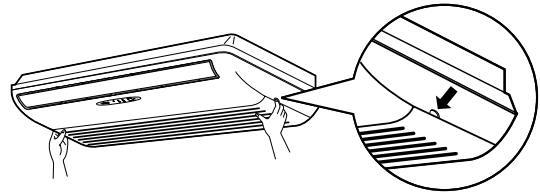

### 3. Take off the air purifying filter, photocatalytic deodorizing filter.

- Hold the recessed parts of the frame and unhook the four claws.

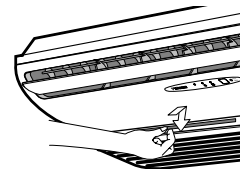

### 4. Clean or replace each filter.

See figure.

Air purifying filter  
or Photocatalytic  
deodorizing filter

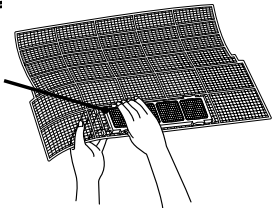

### 5. Set the air filter, air purifying filter and photocatalytic deodorizing filter as they were and close the front grille.

- Insert claws of the filters into slots of the front grille.
- Push the grille at the 5 points.

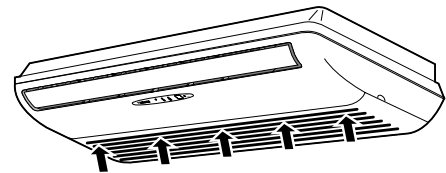

## ■ Air Filter

### 1. Wash the air filters with water or clean them with vacuum cleaner.

- If the dust does not come off easily, wash them with neutral detergent thinned with lukewarm water, then dry them up in the shade.
- It is recommended to clean the air filters every two weeks.

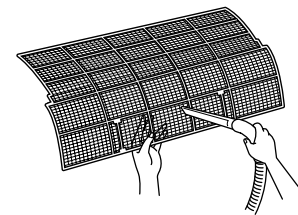

## ■ Air Purifying Filter (green)

(Replace approximately once every 3 months.)

### 1. Detach the filter element and attach a new one.

- Insert with the green side up.
- It is recommended to replace the air purifying filter every three months.

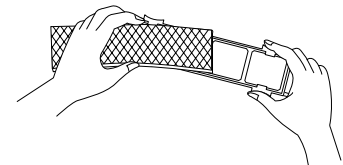

## ■ Photocatalytic Deodorizing Filter (gray)

### [ Maintenance ]

### 1. Dry the photocatalytic deodorizing filter in the sun.

- After removing the dust with a vacuum cleaner, place the filter in the sun for approximately 6 hours. By drying the photocatalytic deodorizing filter in the sun, its deodorizing and antibacterial capabilities are regenerated.
- Because the filter material is paper, it can not be cleaned with water.
- It is recommended dry the filter once every 6 months.

### [ Replacement ]

### 1. Detach the filter element and attach a new one.

## Check

Check that the base, stand and other fittings of the outdoor unit are not decayed or corroded.
Check that nothing blocks the air inlets and the outlets of the indoor unit and the outdoor unit.
Check that the drain comes smoothly out of the drain hose during COOL or DRY operation. <ul style="list-style-type: none"> <li>• If no drain water is seen, water may be leaking from the indoor unit. Stop operation and consult the service shop if this is the case.</li> </ul>

## ■ Before a long idle period

### 1. Operate the “FAN only” for several hours on a fine day to dry out the inside.

- Press “MODE selector button” and select “FAN” operation.
- Press “ON/OFF button” and start operation.

### 2. After operation stops, turn off the breaker for the room air conditioner.

### 3. Clean the air filters and set them again.

### 4. Take out batteries from the remote controller.

- When a multi outdoor unit is connected, make sure the heating operation is not used at the other room before you use the fan operation.

## NOTE

- Operation with dirty filters :
  - (1) cannot deodorize the air.                      (2) cannot clean the air.
  - (3) results in poor heating or cooling.            (4) may cause odour.
- The air purifying filter and Photocatalytic deodorizing filter cannot be reused, even if washed.
- In principle, there is no need to replace the photocatalytic deodorizing filter. Remove the dust periodically with a vacuum cleaner. However, it is recommended to replace the filter in the following cases.
  - (1) The paper material is torn or broken during cleaning.
  - (2) The filter has become extremely dirty after long use.
- To order air purifying filter or Photocatalytic deodorizing filter, contact to the service shop where you bought the air conditioner.
- Dispose of old air filters as non-burnable waste and Photocatalytic deodorizing filters as burnable waste.

Item	Part No.
Photocatalytic deodorizing filter (with frame)	KAZ917B41
Photocatalytic deodorizing filter (without frame)	KAZ917B42
Air purifying filter (with frame)	KAF925B41
Air purifying filter (without frame)	KAF925B42

## Floor Standing Type

# Care and Cleaning



**CAUTION** Before cleaning, be sure to stop the operation and turn the breaker OFF.

## Units

### ■ Indoor unit, Outdoor unit and Remote controller

1. Wipe them with dry soft cloth.

### ■ Front grille

#### 1. Open the front grille.

- Press the two  places on the left and right of the front grille.

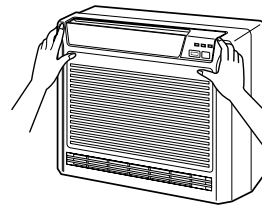

#### 2. Remove the front grille.

- Remove the chain.
- Allowing the grille to fall forward will enable you to remove it.

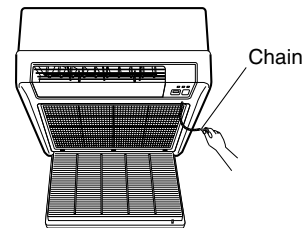

#### 3. Clean the front grille

- Wipe softly with a damp cloth.
- Only neutral detergent may be used.
- In case of washing the grille with water, dry it with cloth, dry it up in the shade after washing.

#### 4. Attach the front grille.

- Insert the front grille into the grooves of the unit (3 places).
- Attach the chain to the right, inner-side of the front grille.
- Close the grille slowly.

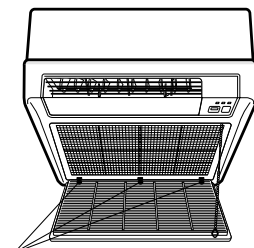

Place front grille in grooves.



### CAUTION

- Hold the front grille firmly so that it does not fall.
- Do not touch the metal parts on the inside of the indoor unit, as it may result in injury.
- When removing or attaching the front grille, use a robust and stable stool and watch your steps carefully.
- When removing or attaching the front grille, support the grille securely with hand to prevent it from falling.
- For cleaning, do not use hot water above 40 °C, benzene, gasoline, thinner, nor other volatile oils, polishing compound, scrubbing brushes, nor other hand stuff.
- After cleaning, make sure that the front grille is securely fixed.

## Filters

### 1. Open the front grille.

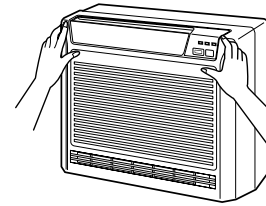

### 2. Remove the air filter.

- Press the claws on the right and left of the air filter down slightly, then pull upward.

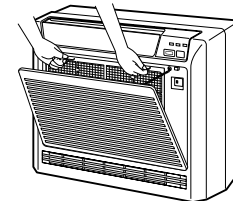

### 3. Take off the air purifying filter, Photocatalytic deodorizing filter.

- Hold the tabs of the frame, and remove the claws in 4 places.

### 4. Clean or replace each filter.

See figure.

Air purifying filter or photocatalytic deodorizing filter

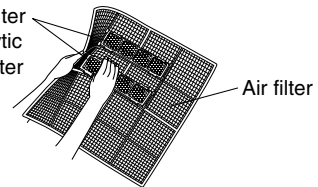

### 5. Set the air filter, air purifying filter and photocatalytic deodorizing filter as they were and close the front grille.

- Operation without air filters may result in troubles as dust will accumulate inside the indoor unit.

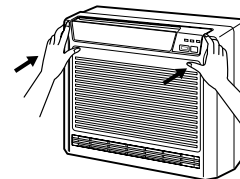

## ■ Air Filter

### 1. Wash the air filters with water or clean them with vacuum cleaner.

- If the dust does not come off easily, wash them with neutral detergent thinned with lukewarm water, then dry them up in the shade.
- It is recommended to clean the air filters every two weeks.

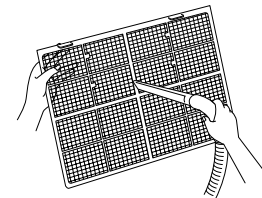

## ■ Air Purifying Filter (green)

(Replace approximately once every 3 months.)

### 1. Detach the filter element and attach a new one.

- Insert with the green side up.
- It is recommended to replace the air purifying filter every three months.

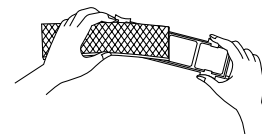

## ■ Photocatalytic Deodorizing Filter (gray)

### [ Maintenance ]

#### 1. Dry the photocatalytic deodorizing filter in the sun.

- After removing the dust with a vacuum cleaner, place the filter in the sun for approximately 6 hours. By drying the photocatalytic deodorizing filter in the sun, its deodorizing and antibacterial capabilities are regenerated.
- Because the filter material is paper, it can not be cleaned with water.
- It is recommended dry the filter once every 6 months.

### [ Replacement ]

#### 1. Detach the filter element and attach a new one.

## Check

Check that the base, stand and other fittings of the outdoor unit are not decayed or corroded.
Check that nothing blocks the air inlets and the outlets of the indoor unit and the outdoor unit.
Check that the drain comes smoothly out of the drain hose during COOL or DRY operation. <ul style="list-style-type: none"> <li>If no drain water is seen, water may be leaking from the indoor unit. Stop operation and consult the service shop if this is the case.</li> </ul>

## ■ Before a long idle period

- 1. Operate the “FAN only” for several hours on a fine day to dry out the inside.**
  - Press “MODE selector button” and select “FAN” operation.
  - Press “ON/OFF button” and start operation.
- 2. After operation stops, turn off the breaker for the room air conditioner.**
- 3. Clean the air filters and set them again.**
- 4. Take out batteries from the remote controller.**
  - When a multi outdoor unit is connected, make sure the heating operation is not used at the other room before you use the fan operation.

## NOTE

- Operation with dusty air filters lowers the cooling (heating) capacity and wastes energy. Air is also prevented from flowing smoothly through the unit creating a noise.
- Operation with dirty filters :
  - (1) cannot deodorize the air.
  - (2) cannot clean the air.
  - (3) results in poor heating or cooling.
  - (4) may cause odour.
- The air purifying filter and Photocatalytic deodorizing filter cannot be reused, even if washed.
- In principle, there is no need to replace the photocatalytic deodorizing filter. Remove the dust periodically with a vacuum cleaner. However, it is recommended to replace the filter in the following cases.
  - (1) The paper material is torn or broken during cleaning.
  - (2) The filter has become extremely dirty after long use.
- To order air purifying filter or Photocatalytic deodorizing filter, contact to the service shop where you bought the air conditioner.
- Dispose of old air filters as non-burnable waste and Photocatalytic deodorizing filters as burnable waste.

Item	Part No.
Photocatalytic deodorizing filter (with frame)	KAZ917B41
Photocatalytic deodorizing filter (without frame)	KAZ917B42
Air purifying filter (with frame)	KAF925B41
Air purifying filter (without frame)	KAF925B42

## 2.1.16 Troubleshooting

# Trouble Shooting

### These cases are not troubles.

The following cases are not air conditioner troubles but have some reasons. You may just continue using it.

Case	Explanation
<b>Operation does not start soon.</b> <ul style="list-style-type: none"> <li>• When ON/OFF button was pressed soon after operation was stopped.</li> <li>• When the mode was reselected.</li> </ul>	<ul style="list-style-type: none"> <li>• This is to protect the air conditioner. You should wait for about 3 minutes.</li> </ul>
<b>Hot air does not flow out soon after the start of heating operation.</b>	<ul style="list-style-type: none"> <li>• The air conditioner is warming up. You should wait for 1 to 4 minutes. (The system is designed to start discharging air only after it has reached a certain temperature.)</li> </ul>
<b>The heating operation stops suddenly and a flowing sound is heard.</b>	<ul style="list-style-type: none"> <li>• The system is taking away the frost on the outdoor unit. You should wait for about 3 to 8 minutes.</li> </ul>
<b>The outdoor unit emits water or steam.</b>	<ul style="list-style-type: none"> <li>■ In HEAT mode <ul style="list-style-type: none"> <li>• The frost on the outdoor unit melts into water or steam when the air conditioner is in defrost operation.</li> </ul> </li> <li>■ In COOL or DRY mode <ul style="list-style-type: none"> <li>• Moisture in the air condenses into water on the cool surface of outdoor unit piping and drips.</li> </ul> </li> </ul>
<b>Mists come out of the indoor unit.</b>	<ul style="list-style-type: none"> <li>■ This happens when the air in the room is cooled into mist by the cold air flow during cooling operation.</li> </ul>
<b>The indoor unit gives out odour.</b>	<ul style="list-style-type: none"> <li>■ This happens when smells of the room, furniture, or cigarettes are absorbed into the unit and discharged with the air flow. (If this happens, we recommend you to have the indoor unit washed by a technician. Consult the service shop where you bought the air conditioner.)</li> </ul>
<b>The outdoor fan rotates while the air conditioner is not in operation.</b>	<ul style="list-style-type: none"> <li>■ After operation is stopped: <ul style="list-style-type: none"> <li>• The outdoor fan continues rotating for another 60 seconds for system protection.</li> </ul> </li> <li>■ While the air conditioner is not in operation: <ul style="list-style-type: none"> <li>• When the outdoor temperature is very high, the out door fan starts rotating for system protection.</li> </ul> </li> </ul>
<b>The operation stopped suddenly. (OPERATION lamp is on)</b>	<ul style="list-style-type: none"> <li>■ For system protection, the air conditioner may stop operating on a sudden large voltage fluctuation. It automatically resumes operation in about 3 minutes.</li> </ul>

**Check again.**

Please check again before calling a repair person.

<b>Case</b>	<b>Check</b>
<b>The air conditioner does not operate. (OPERATION lamp is off)</b>	<ul style="list-style-type: none"> <li>• Hasn't a breaker turned OFF or a fuse blown?</li> <li>• Isn't it a power failure?</li> <li>• Are batteries set in the remote controller?</li> <li>• Is the timer setting correct?</li> </ul>
<b>Cooling (Heating) effect is poor.</b>	<ul style="list-style-type: none"> <li>• Are the air filters clean?</li> <li>• Is there anything to block the air inlet or the outlet of the indoor and the outdoor units?</li> <li>• Is the temperature setting appropriate?</li> <li>• Are the windows and doors closed?</li> <li>• Are the air flow rate and the air direction set appropriately?</li> <li>• Is the unit set to the INTELLIGENT EYE mode?</li> </ul>
<b>Operation stops suddenly. (OPERATION lamp flashes.)</b>	<ul style="list-style-type: none"> <li>• Are the air filters clean?</li> <li>• Is there anything to block the air inlet or the outlet of the indoor and the outdoor units? Clean the air filters or take all obstacles away and turn the breaker OFF. Then turn it ON again and try operating the air conditioner with the remote controller. If the lamp still flashes, call the service shop where you bought the air conditioner.</li> <li>• Are operation modes all the same for indoor units connected to outdoor units in the <b>multi system</b>? If not, set all indoor units to the same operation mode and confirm that the lamps flash. Moreover, when the operation mode is in "AUTO", set all indoor unit operation modes to "COOL" or "HEAT" for a moment and check again that the lamps are normal. If the lamps stop flashing after the above steps, there is no malfunction.</li> </ul>
<b>An abnormal functioning happens during operation.</b>	<ul style="list-style-type: none"> <li>• The air conditioner may malfunction with lightning or radio waves. Turn the breaker OFF, turn it ON again and try operating the air conditioner with the remote controller.</li> </ul>



**Call the service shop immediately.**



**WARNING**

- When an abnormality (such as a burning smell) occurs, stop operation and turn the breaker OFF.  
Continued operation in an abnormal condition may result in troubles, electric shocks or fire.  
Consult the service shop where you bought the air conditioner.
- Do not attempt to repair or modify the air conditioner by yourself.  
Incorrect work may result in electric shocks or fire.  
Consult the service shop where you bought the air conditioner.

If one of the following symptoms takes place, call the service shop immediately.

- **The power cord is abnormally hot or damaged.**
- **An abnormal sound is heard during operation.**
- **The safety breaker, a fuse, or the earth leakage breaker cuts off the operation frequently.**
- **A switch or a button often fails to work properly.**
- **There is a burning smell.**
- **Water leaks from the indoor unit.**



Turn the breaker OFF and call the service shop.

- **After a power failure**  
The air conditioner automatically resumes operation in about 3 minutes. You should just wait for a while.

- **Lightning**  
If lightning may strike the neighbouring area, stop operation and turn the breaker OFF for system protection.

**We recommend periodical maintenance.**

In certain operating conditions, the inside of the air conditioner may get foul after several seasons of use, resulting in poor performance. It is recommended to have periodical maintenance by a specialist aside from regular cleaning by the user. For specialist maintenance, contact the service shop where you bought the air conditioner.  
The maintenance cost must be born by the user.

## 2.2 FFQ 25/35/50/60 B

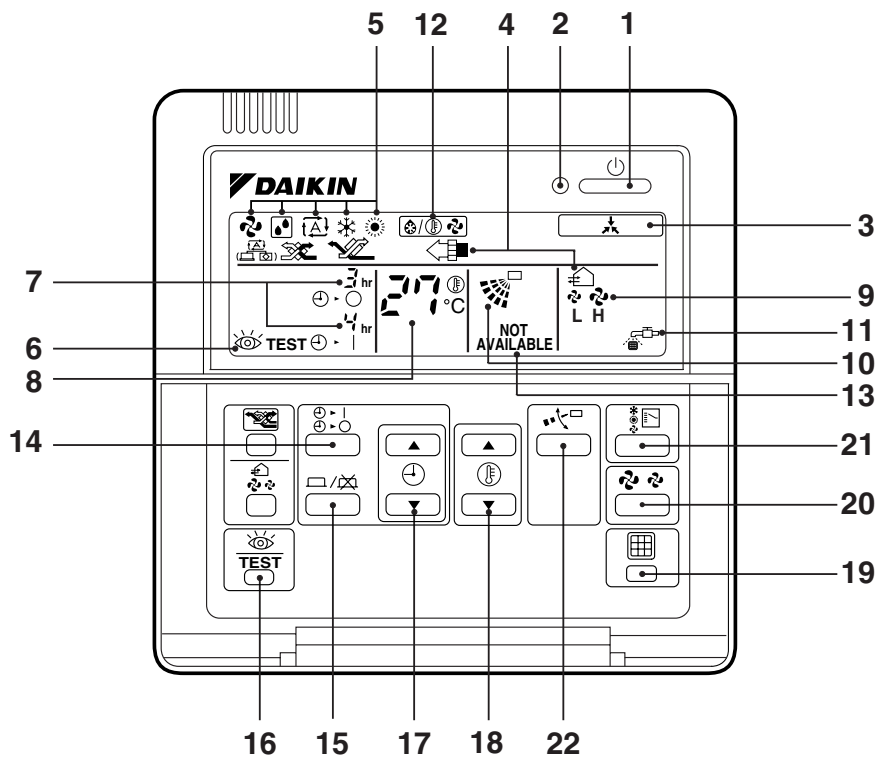

1

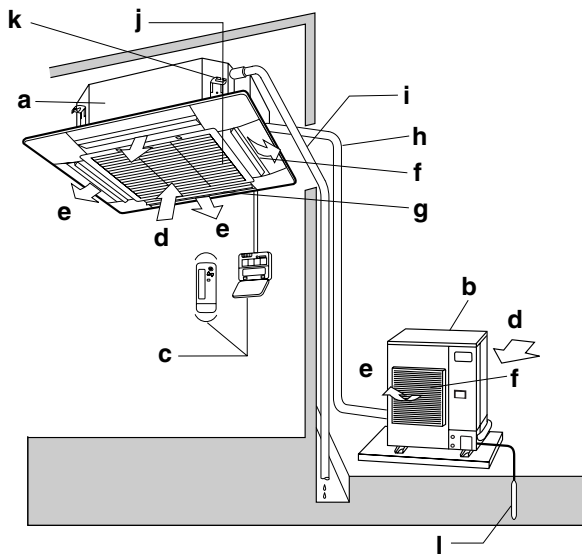

2

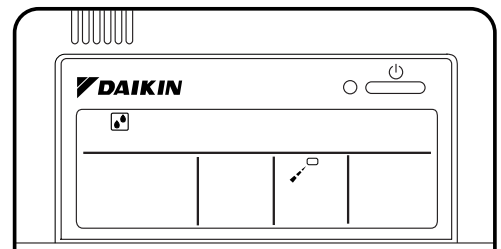

3

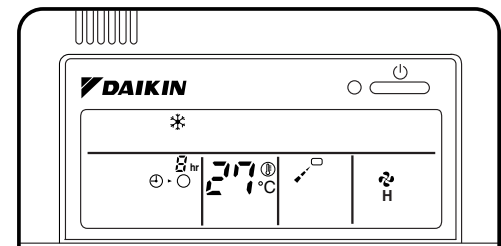

4

# 1. WHAT TO DO BEFORE OPERATION

This operation manual is for the following systems with standard control. Before initiating operation, contact your Daikin dealer for the operation that corresponds to your system.

- Pair system

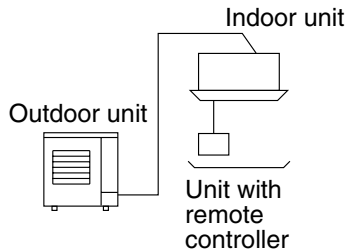

- Multi system

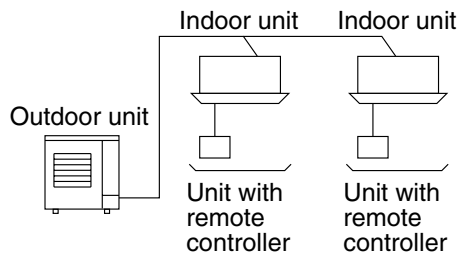

**NOTE**

- If the unit you purchased is controlled by a wireless remote controller, also refer to the wireless remote controller's operation manual.

If your installation has a customized control system, ask your Daikin dealer for operation that corresponds to your system.

- Heat pump type  
This system provides cooling, heating, automatic, program dry, and fan operation modes.
- Cooling only type  
This system provides cooling, program dry, and fan operation modes.

## PRECAUTIONS FOR GROUP CONTROL SYSTEM OR TWO REMOTE CONTROLLER CONTROL SYSTEM

This system provides two other control systems beside individual control (one remote controller controls one indoor unit) system. Confirm the following if your unit is of the following control system type.

- **Group control system**  
One remote controller controls up to 16 indoor units.  
All indoor units are equally set.
- **Two remote controllers control system**  
Two remote controllers control one indoor unit (In case of group control system, one group of indoor units)  
The unit is individually operated.

**NOTE**

- Contact your Daikin dealer in case of changing the combination or setting of group control and two remote controllers control system.

## Names and functions of parts

Refer to figure 2 on page [1]

<b>a</b>	Indoor unit
<b>b</b>	Outdoor unit • The external appearance of the outdoor unit varies depending on its capacity class. The outdoor unit shown in the figure is for reference to indicate features. Contact your Daikin Dealer and verify which outdoor unit you have.
<b>c</b>	Remote controller
<b>d</b>	Inlet air
<b>e</b>	Discharged air
<b>f</b>	Air outlet
<b>g</b>	Air flow flap (at air outlet)
<b>h</b>	Refrigerant piping, connection electric wire
<b>i</b>	Drain pipe
<b>j</b>	Air inlet The built-in air filter removes dust and dirt.
<b>k</b>	Drain pumping out device (built-in) Drains water removed from the room during cooling.
<b>l</b>	Ground wire Wire to ground from the outdoor unit to prevent electrical shocks.

## 2. SAFETY CONSIDERATIONS

We recommend that you read this instruction manual carefully before use to gain full advantage of the function of the air conditioner, and to avoid malfunction due to erroneous handling.

This air conditioner comes under the term “appliances not accessible to the general public”.

- **The precautions described below are WARNING and CAUTION. These are very important precautions concerning safety. Be sure to observe all of them without fail.**

**⚠ WARNING**.. These are the matters with possibilities leading to serious consequences such as death or serious injury due to erroneous handling.

**⚠ CAUTION**... These are the matters with possibilities leading to injury or material damage due to erroneous handling including probabilities leading to serious consequences in some cases.

- **After reading, keep this manual at a place where any user can read at any time. Furthermore, make certain that this operation manual is handed to a new user when he takes over the operation.**

### ⚠ WARNING

**Avoid exposure of your body directly to the cold air for a long time, or avoid excessive exposure of your body to the cold air.**

Otherwise, your physical condition may be deteriorated and/or your health may be ruined.

**When the air conditioner is in abnormal conditions (smell of something burning, etc), unplug the power cord from the outlet, and contact the dealer where you purchased the air conditioner.**

Continued operation under such circumstances may result in a failure, electric shock, and fire.

**Ask your dealer for installation of the air conditioner.**

Incomplete installation performed by yourself may result in a failure, a water leakage, electric shock, and fire.

**Ask your dealer for improvement, repair, and maintenance.**

Incomplete improvement, repair, and maintenance may result in a failure, a water leakage, electric shock, and fire.

**Do not insert your finger, a stick, etc., into the air inlet, outlet, and fan blades.**

A fan in high-speed running may result in injury.

**For refrigerant leakage, consult your dealer.**

When the air conditioner is to be installed in a small room, it is necessary to take proper measures so that the amount of any leaked refrigerant dose not exceed the limiting concentration even when it leaks. If the refrigerant leaks exceeding

the level of limiting concentration, an oxygen deficiency accident may happen.

**For installation of separately sold component parts, ask a specialist.**

Be sure to use the separately sold component parts designated by our company.

Incomplete installation performed by yourself may result in a failure, a water leakage, electric shock, and fire.

**Ask your dealer to move and reinstall the air conditioner.**

Incomplete installation may result in a failure, a water leakage, electric shock, and fire.

**The refrigerant in the air conditioner is safe and normally does not leak. If the refrigerant leaks inside the room, the contact with a fire of a burner, a heater or a cooker may result in a harmful gas.**

Do not use the air conditioner until when a service person confirms to finish repairing the portion where the refrigerant leaks.

### ⚠ CAUTION

**Do not use the air conditioner for other purposes.**

Do not use the air conditioner for a special application such as the storage of foods, animals and plants, precision machines, and art objects as otherwise the deterioration of quality may result.

**Do not remove the air outlet of the outdoor unit.**

The fan may get exposed and result in injury.

**When the air conditioner is used in combination with burners or heaters, perform sufficient ventilation.**

Insufficient ventilation may result in an oxygen deficiency accident.

**Check and make sure that foundation blocks are not damaged after a long use.**

If they are left in a damaged condition, the unit may fall and result in injury.

**Neither place a flammable spray bottle near the air conditioner not perform spraying.**

Doing so may result in a fire.

**To clean the air conditioner, stop operation, and unplug the power cord from the outlet.**

Otherwise, an electric shock and injury may result.

**Do not operate the air conditioner with a wet hand.**

An electric shock may result.

**Do not use any fuse with improper capacity.**

The use of piece of wire and whatnot may result in a failure and fire.

**Do not place a burner or heater at a place directly exposed to the wind from the air conditioner.**

Incomplete combustion of the burner or heater may result.

**Do not allow a child to mount on the outdoor unit or avoid placing any object on it.**

Falling or tumbling may result in injury.

**Do not expose animals and plants directly to the wind from the air conditioner.**

Adverse influence to animals and plants may result.

**Do not wash the air conditioner with water.**

An electric shock may result.

**Do not install the air conditioner at any place where flammable gas may leak out.**

If the gas leaks out and stays around the air conditioner, a fire may break out.

**Be sure to install an earth leakage breaker.**

Unless it is installed, an electric shock may result.

**Be sure the air conditioner is electrically grounded.**

Do not connect the grounding conductor to a gas pipe, water pipe, lightning arrester, and the grounding conductor for a telephone. Imperfect grounding work may result in an electric shock.

**Execute complete drain piping for perfect drainage.**

Incomplete piping may result in a water leakage.

**The appliance is not intended for use by young children or infirm persons without supervision.**

**Young children should be supervised to ensure that they do not play with the appliance.**

### 3. OPERATION RANGE

If the temperature or the humidity is beyond the following conditions, safety devices may work and the air conditioner may not operate, or sometimes, water may drop from the indoor unit.

#### COOLING

OUTDOOR UNIT	INDOOR		OUTDOOR TEMPERATURE
	TEMPERATURE	HUMIDITY	
RS50 · 60 RKS25 · 35 · 50 · 60 RXS25 · 35 · 50 · 60	D B 21 to 32	80% or below	D B -10 to 46 (-5)
	W B 14 to 23		
3MKS50 4MKS58 · 75 · 90 3MXS52 4MXS68 · 80	D B 21 to 32	80% or below	D B -10 to 46
	W B 14 to 23		

#### HEATING

OUTDOOR UNIT	INDOOR TEMPERATURE		OUTDOOR TEMPERATURE	
RXS25 · 35	DB	10 to 30	DB	-14 to 24
			WB	-15 to 20
RXS50 · 60	DB	10 to 30	DB	-14 to 24
			WB	-15 to 18
3MXS52 4MXS68 · 80	DB	10 to 30	DB	-14 to 21
			WB	-15 to 15.5

DB: Dry bulb temperature (°C)

WB: Wet bulb temperature (°C)

The setting temperature range of the remote controller is 16°C to 32°C.

The numerical value in a parenthesis shows the operation range of the model for Australia.

### 4. INSTALLATION SITE

#### Regarding places for installation

- **Is the air conditioner installed at a well-ventilated place where there are no obstacles around?**
- **Do not use the air conditioner in the following places.**
  - a. Filled with much mineral oil such as cutting oil
  - b. Where there is much salt such as a beach area
  - c. Where sulfured gas exists such as a hot-spring resort.
  - d. Where there are considerable voltage fluctuations such as a factory or plant
  - e. Vehicles and vessels
  - f. Where there is much spray of oil and vapor such as a cookery, etc.
  - g. Where there are machines generating electromagnetic waves.
  - h. Filled with acid and/or alkaline steam or vapor
- **Is a snow protection measure taken?**  
For details, consult your dealer.

#### Regarding wiring

- **All wiring must be performed by an authorized electrician.**  
To do wiring, ask your dealer. Never do it by yourself.
- **Make sure that a separate power supply circuit is provided for this air conditioner and that all electrical work is carried out by qualified personnel according to local laws and regulations.**

#### Pay attention to running noises, too

- **Are the following places selected?**
  - a. A place that can sufficiently withstand the weight of the air conditioner with less running noises and vibrations.
  - b. A place where the hot wind discharged from the air outlet of outdoor unit and the running noises.
- **Are you sure that there are no obstacles near the air outlet of the outdoor unit?**  
Such obstacles may result in declined performance and increased running noises.
- **If abnormal noises occur in use, stop the operation of the air conditioner, and then consult your dealer or our service station.**

#### Regarding drainage of drain piping









- **Is the drain piping executed to perform complete drainage?**

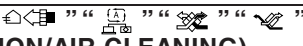
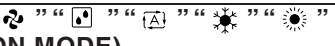

If proper drainage is not carried out from the out-

door drain pipes during air-conditioning operation, chances are that dust and dirt are clogged in the pipe. This may result in a water leakage from the indoor unit. Under such circumstances, stop the operation of the air conditioner, and then consult your dealer or our service station.

## 5. NAME AND FUNCTION OF EACH SWITCH AND DISPLAY ON THE REMOTE CONTROLLER

Refer to figure 1 on page [1]

1	<b>ON/OFF BUTTON</b>
	Press the button and the system will start. Press the button again and the system will stop.
2	<b>OPERATION LAMP (RED)</b>
	The lamp lights up during operation.
3	<b>DISPLAY “” (UNDER CENTRALIZED CONTROL)</b>
	When this display shows, the system is UNDER CENTRALIZED CONTROL.
4	<b>DISPLAY “” (VENTILATION/AIR CLEANING)</b>
	This display shows that the total heat exchange and the air cleaning unit are in operation (These are optional accessories).
5	<b>DISPLAY “” (OPERATION MODE)</b>
	This display shows the current OPERATION MODE. For cooling only type, “  ” (Auto) and “  ” (Heating) are not installed.
6	<b>DISPLAY “ TEST” (INSPECTION/TEST OPERATION)</b>
	When the INSPECTION/TEST OPERATION BUTTON is pressed, the display shows the system mode is in.
7	<b>DISPLAY “” (PROGRAMMED TIME)</b>
	This display shows the PROGRAMMED TIME of the system start or stop.
8	<b>DISPLAY “” (SET TEMPERATURE)</b>
	This display shows the set temperature.
9	<b>DISPLAY “” (FAN SPEED)</b>
	This display shows the set fan speed.
10	<b>DISPLAY “” (AIR FLOW FLAP)</b>
	Refer to “AIR FLOW DIRECTION ADJUST”.

11	<b>DISPLAY “” (TIME TO CLEAN AIR FILTER)</b>
	Refer to “HOW TO CLEAN THE AIR FILTER”.
12	<b>DISPLAY “” (DEFROST)</b>
	Refer to “DEFROST OPERATION”.
13	<b>NON-FUNCTIONING DISPLAY</b>
	If that particular function is not available, pressing the button may display the words “NOT AVAILABLE” for a few seconds. When running multiple units simultaneously The “NOT AVAILABLE” message will only be appear if none of the indoor units is equipped with the function. If even one unit is equipped with the function, the display will not appear.
14	<b>TIMER MODE START/STOP BUTTON</b>
	Refer to “PROGRAM TIMER OPERATION”.
15	<b>TIMER ON/ OFF BUTTON</b>
	Refer to “PROGRAM TIMER OPERATION”
16	<b>INSPECTION/TEST OPERATION BUTTON</b>
	This button is used only by qualified service persons for maintenance purposes.
17	<b>PROGRAMMING TIME BUTTON</b>
	Use this button for programming “START and/or STOP” time.
18	<b>TEMPERATURE SETTING BUTTON</b>
	Use this button for SETTING TEMPERATURE.
19	<b>FILTER SIGN RESET BUTTON</b>
	Refer to “HOW TO CLEAN THE AIR FILTER”.
20	<b>FAN SPEED CONTROL BUTTON</b>
	Press this button to select the fan speed, HIGH or LOW, of your choice.
21	<b>OPERATION MODE SELECTOR BUTTON</b>
	Press this button to select OPERATION MODE.
22	<b>AIR FLOW DIRECTION ADJUST BUTTON</b>
	Refer to “AIR FLOW DIRECTION ADJUST”.
<b>NOTE</b>	
<ul style="list-style-type: none"> <li>For the sake of explanation, all indications are shown on the display in figure 1 contrary to actual running situations.</li> </ul>	

## 6. OPERATION PROCEDURE

Refer to figure 1 on page [1]

- Operating procedure varies with heat pump type and cooling only type. Contact your Daikin dealer to confirm your system type.
- To protect the unit, turn on the main power switch 6 hours before operation.





- If the main power supply is turned off during operation, operation will restart automatically after the power turns back on again.

**COOLING, HEATING, AUTOMATIC, FAN, AND PROGRAM DRY OPERATION**

Operate in the following order.

**1 OPERATION MODE SELECTOR**

Press **OPERATION MODE SELECTOR** button several times and select the **OPERATION MODE** of your choice as follows.

- **COOLING OPERATION** ..... “  ”
- **HEATING OPERATION** ..... “  ”
- **AUTOMATIC OPERATION**..... “  ”
  - In this operation mode, COOL/HEAT changeover is automatically conducted.
- **FAN OPERATION** ..... “  ”
- **DRY OPERATION**..... “  ”
  - The function of this program is to decrease the humidity in your room with the minimum temperature decrease.
  - Micro computer automatically determines TEMPERATURE and FAN SPEED.
  - This system dose not go into operation if the room temperature is below 16 °C.

Refer to figure 3 on page [1]

- For cooling only type, “ COOLING ”, “ FAN ” and “ DRY ” operation are able to select.

**2 ON/OFF**

Press **ON/OFF** button OPERATION lamp lights up or goes off and the system starts or stops OPERATION.

**[EXPLANATION OF HEATING OPERATION]**

**DEFROST OPERATION**

- As the frost on the coil of an outdoor unit increase, heating effect decreases and the system goes into DEFROST OPERATION.
- The indoor unit fan stops and the remote controller display shows “  ”.
- After 6 to 8 minutes (maximum 10 minutes) of DEFROST OPERATION, the system returns to HEATING OPERATION.

**Regarding outside air temperature and heating capacity**

- The heating capacity of the air conditioner declines as the outside air temperature falls. In such a case, use the air conditioner in combination with other heating systems.



- A warm air circulating system is employed, and therefore it takes some time until the entire room is warmed up after the start of operation.
- An indoor fan runs to discharge a gentle wind automatically until the temperature inside the air conditioner reaches a certain level. At this time, the remote controller displays “  ”. Leave it as it stands and wait for a while.
- When the warm air stays under the ceiling and your feet are cold, we recommend that you use a circulator (a fan to circulate the air inside the room). For details, consult your dealer.

**ADJUSTMENT**

For programming TEMPERATURE, FAN SPEED and AIR FLOW DIRECTION, follow the procedure shown below.

**TEMPERATURE SETTING**

Press **TEMPERATURE SETTING** button and program the setting temperature.

-  Each time this button is pressed, setting temperature rises 1 °C.
-  Each time this button is pressed, setting temperature lowers 1 °C.

- The setting is impossible for fan operation.

**NOTE**

- The setting temperature range of the remote controller is 16 °C to 32 °C.

**FAN SPEED CONTROL**

Press **FAN SPEED CONTROL** button. High or Low fan speed can be selected. Micro computer may sometimes control the fan speed in order to protect the unit.

**AIR FLOW DIRECTION ADJUST**

Press the **AIR FLOW DIRECTION ADJUST** button to adjust the air flow angle.

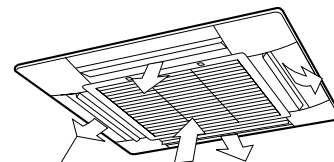

Up and down adjustment

- The movable limit of the flap is changeable. Contact your Daikin dealer for details.

Press the **AIR FLOW DIRECTION ADJUST** button to select the air direction as following.

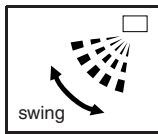

The AIR FLOW FLAP display swings as shown left and the air flow direction continuously varies. (Automatic swing setting)



Press AIR FLOW DIRECTION ADJUST button to select the air direction of your choice.

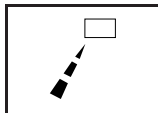

The AIR FLOW FLAP display stops swinging and the air flow direction is fixed (Fixed air flow direction setting).

### MOVEMENT OF THE AIR FLOW FLAP

For the following conditions, micro computer controls the air flow direction so it may be different from the display.

Operation mode	Heating
Operation condition	<ul style="list-style-type: none"> <li>When starting operation</li> <li>When room temperature is higher than the set temperature</li> <li>At defrost operation (Air is blown horizontally to prevent the cool air from being blown directly onto anyone in the room.)</li> </ul>

Operation mode includes automatic operation.

### PROGRAM TIMER OPERATION

Operate in the following order.

- The timer is operated in the following two ways.
- Programming the stop time (⊕ - ○) .... The system stops operating after the set time has elapsed.
- Programming the start time (⊕ - |) .... The system starts operating after the set time has elapsed.
- The timer can be programmed a maximum of 72 hours.
- The start and the stop time can be simultaneously programmed.

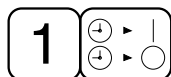

### 1 TIMER MODE START/STOP

Press the **TIMER MODE START/STOP** button several times and select the mode on the display.

The display flashes.

For setting the timer stop .... "⊕ - ○"

For setting the timer start .... "⊕ - |"



### 2 PROGRAMMING TIME

Press the **PROGRAMMING TIME** button and set the time for stopping or starting the system.

When this button is pressed, the time advances by 1 hour.

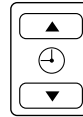

When this button is pressed, the time goes backward by 1 hour.



### 3 TIMER ON/OFF

Press the **TIMER ON/OFF** button.

The timer setting procedure ends.

The display "⊕ - ○ or ⊕ - |" changes from flashing light to a constant light.

Refer to figure 4 on page [1]

#### NOTE

- When setting the timer Off and On at the same time, repeat the above procedure from 1 to 3 once again.

When the timer is programmed to stop the system after 3 hours and start the system after 4 hours, the system will stop after 3 hours and then 1 hour later the system will start.

- After the timer is programmed, the display shows the remaining time.
- Press the TIMER ON/OFF button once again to cancel programming. The display vanishes.

## 7. OPTIMUM OPERATION

Observe the following precautions to ensure the system operates.

- Adjust the room temperature properly for a comfortable environment. Avoid excessive heating or cooling.
- Prevent direct sunlight from entering a room during cooling operation by using curtains or blinds.
- Ventilate the room regularly. Using the unit for long periods of time requires attentive ventilation of the room.
- Do not place items that might be damaged by water under the indoor unit. Water may condensate and drip if the humidity reaches 80% or if the drain exit gets clogged.
- Keep doors and windows closed. If the doors and windows remain open, room air will flow out and cause to decrease the effect of cooling and heating.



- Do not place other heaters directly below the indoor unit. They may deform due to the heat.
- Never place objects near the air inlet and the air outlet of the unit. It may cause deterioration in the effect or stop in the operation.
- Turn off the main power supply switch when it is not used for long periods of time. When the main power switch is turned on, some watts of electricity is being used even if the system is not operating. Turn off the main power supply switch for saving energy. When reoperating, turn on the main power supply switch 6hours before operation for smooth running (Refer to MAINTENANCE).
- When the display shows “” (TIME TO CLEAN AIR FILTER), ask a qualified service person to clean the filters (Refer to MAINTENANCE).

**8. MAINTENANCE  
(FOR SERVICE PERSONNEL)**

**ONLY A QUALIFIED SERVICE PERSON IS ALLOWED TO PERFORM MAINTENANCE**

**IMPORTANT!**

- **BEFORE OBTAINING ACCESS TO TERMINAL DEVICES, ALL POWER SUPPLY CIRCUITS MUST BE INTERRUPTED**
- To clean the air conditioner, be sure to stop operation, and turn the power switch off. Otherwise, an electric shock and injury may result.
- Do not wash the air conditioner with water. Doing so may result in an electric shock.
- Be careful with a scaffold or staging. Caution must be exercised because of work at a high place.

**HOW TO CLEAN THE AIR FILTER**

Clean the air filter when the display shows “” (TIME TO CLEAN AIR FILTER).

It will display that it will operate for a set amount of time.

Increase the frequency of cleaning if the unit is installed in a room where the air is extremely contaminated.

If the dirt becomes impossible to clean, change the air filter (Air filter for exchange is optional)

**1. Open the suction grille.**

Push it downward slowly while pressing horizontally the buttons provided on two spots. (Follow the same procedure for closing).

**Fig. 1**

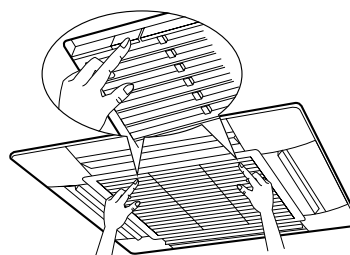

**2. Detach the air filter**

Pull the hook of the air filter out diagonally downward, and remove the filter.

**Fig. 2**

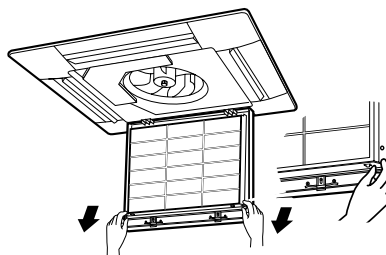

**3. Clean the air filter.**

Use vacuum cleaner **A)** or wash the air filter with water **B)**.

**A) Using a vacuum cleaner**



**B) Washing with water**

When the air filter is very dirty, use soft brush and neutral detergent.



Remove water and dry in the shade.

**NOTE**

- Do not wash the air conditioner with hot water of more than 50° C, as doing so may result in discoloration and/or deformation.
- Do not expose it to fire, as doing so may result in burning.

**4. Fix the air filter**

- (1) Hook the air filter to a protrusion on the suction grille.
- (2) Push the lower part of the air filter onto the protrusion at the lower part of the suction grille, and fix the air filter there.

**Fig. 3**

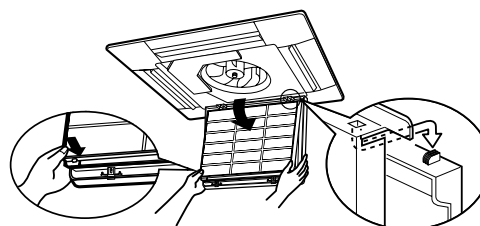

### 5. Shut the suction grille.

Refer to item No.1.

### 6. After turning on the power, press FILTER SIGN RESET button.

The "TIME TO CLEAN AIR FILTER" display vanishes.

## HOW TO CLEAN AIR OUTLET AND OUTSIDE PANELS

- Clean with soft cloth.
- When it is difficult to remove stains, use water or neutral detergent.

### NOTE

- Do not use gasoline, benzene, thinner, polishing powder, liquid insecticide. It may cause discoloring or warping.
- Do not let the indoor unit get wet. It may cause an electric shock or a fire.
- Do not use water or air of 50°C or higher for cleaning air filters and outside panels.

## HOW TO CLEAN THE SUCTION GRILLE

### 1. Open the suction grille.

Push it downward slowly while pressing horizontally the buttons provided on two spots. (Follow the same procedure for closing.)

Fig. 4

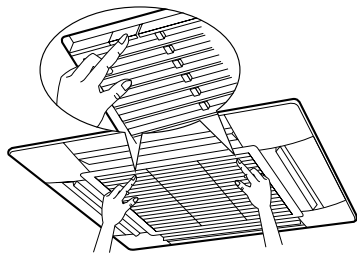

### 2. Detach the suction grille.

Open the suction grille 45 degrees and lift it upward.

Fig. 5

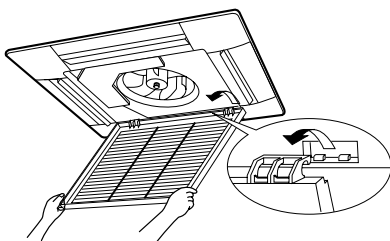

### 3. Detach the air filter.

Refer to "HOW TO CLEAN THE AIR FILTER". (Refer to Fig. 2)

### 4. Clean the suction grille.

Wash with a soft bristle brush and neutral detergent or water, and dry thoroughly.

**When very grimy**



Directly apply the type of detergent used for cleaning ventilation fans or ovens, wait 10 minutes, and then rinse with water.

### 5. Fix the air filter.

Refer to "HOW TO CLEAN THE AIR FILTER". (Refer to Fig. 3)

### 6. Fix the suction grille.

Refer to item No. 2.

### 7. Shut the suction grille.

Refer to item No. 1.

## START UP AFTER A LONG STOP

### Confirm the following

- Check that the air inlet and outlet are not blocked. Remove any obstacle.
- Check if the earth is connected. Might there be a broken wire somewhere? Contact your dealer if there are any problems.

### Clean the air filter and outside panels

- After cleaning the air filter, make sure to attach it.

### Turn on the main power supply switch

- The display on the remote controller will be shown when the power is turned on.
- To protect the unit, turn on the main power switch at least 6 hours before operation.

## WHAT TO DO WHEN STOPPING THE SYSTEM FOR A LONG PERIOD

### Turn on FAN OPERATION for a half day and dry the unit.

- Refer to "6. OPERATION PROCEDURE".

### Cut off the power supply.

- When the main power switch is turned on, some watts of electricity is being used even if the system is not operating. Turn off the main power supply switch for saving energy.
- The display on the remote controller will vanish when the main power switch is turned off.

### Clean the air filter and the exterior.

- Be sure to replace the air filter to its original place after cleaning. Refer to "MAINTENANCE".

## 9. NOT MALFUNCTION OF THE AIR CONDITIONER

The following symptoms do not indicate air conditioner malfunction

### I. THE SYSTEM DOES NOT OPERATE

- **The system does not restart immediately after the ON/OFF button is pressed.** If the OPERATION lamp lights, the system is in normal condition. It does not restart immediately because a safety device operates to prevent overload of the sys-

tem. After 3 minutes, the system will turn on again automatically.

- **The system does not restart immediately when TEMPERATURE SETTING button is returned to the former position after pushing the button.**

If the OPERATION lamp lights, the system is in normal condition.

It does not restart immediately because a safety device operates to prevent overload of the system. After 3 minutes, the system will turn on again automatically.

- **The system does not start when the display shows “” (UNDER CENTRALIZED CONTROL) and it flashes for few seconds after pressing an operation button.**

This is because the system is under centralized control. Flashes on the display indicates that the system cannot be controlled by the remote controller.

- **The system does not start immediately after the power supply is turned on.**  
Wait one minute until the micro computer is prepared for operation.
- **The outdoor unit is stopped**  
This is because the room temperature has reached the set temperature. The indoor unit switches to fan operation.

## II. The display shows “” (UNDER CENTRALIZED CONTROL) and the unit operates in a mode different to what is shown on the remote controller display.

When using a unit in a multi system, the operation condition of that unit is controlled by a micro computer as described below, according to the operation condition of other indoor units connected to the system.

- If the operation mode does not match other indoor units that are already running, the indoor unit will assume the STANDBY state (the fan is stopped and the air flow flap is positioned horizontally).  
If HEATING mode is set together with COOLING, DRY or FAN mode, the above mentioned condition will occur.

### NOTE

- Normally, the operation mode in the room where the unit is first run is given priority, but the following situations are exceptions, so please keep this in mind.
  - a. If the operation mode of the first room is **FAN Mode**, then using **Heating Mode** in any room after this will give priority to heating. In this situation, the air conditioner running in FAN Mode will go on standby.
  - b. With the Priority Room Setting active.  
Contact your Daikin dealer for the operation that corresponds to your system.
- If the total capacity of operating indoor units exceeds the limit, the indoor unit will assume the STANDBY state (FAN and AIR FLOW DIREC-

TION will be left as set). (This only applies to cooling only type.)

- If another indoor unit commences a HEATING operation after this indoor unit is running in COOLING mode, this indoor unit may switch to DRY operation (fan on low, air flow flap set at horizontal).

## III. The fan speed is different from the setting.

- **Pressing the fan speed control button does not change the fan speed.**

When the room temperature reaches the set temperature in heating mode, the power supply from the outdoor unit is stopped and the indoor unit will operate on the low fan setting. (If using the multi system, the fan will alternate between off and low.)

This is to prevent the cool air from being blown directly onto anyone in the room.

## IV. AIR BLOW DIRECTION IS NOT AS SPECIFIED.

- **Actual air blow direction is not as shown on the remote controller.**
- **Automatic swing setting does not work.**  
Refer to “AIR FLOW DIRECTION ADJUST.”

## V. WHITE MIST COMES OUT OF A UNIT

- **When humidity is high during cooling operation (In oily or dusty places)**

If the inside of an indoor unit is extremely contaminated, the temperature distribution inside a room becomes uneven. It is necessary to clean the inside of the indoor unit. Ask your Daikin dealer for details on cleaning the unit. This operation requires a qualified service person.

- **When the system is changed over to HEATING OPERATION after DEFROST OPERATION.**

Moisture generated by DEFROST becomes steam and exists.

## VI. NOISE OF AIR CONDITIONERS

### A ringing sound after the unit is started.

This sound is generated by the temperature regulator working.

It will quiet down after about a minute.

- **A continuous flow “Shuh” sound is heard when the systems is in COOLING or DEFROST OPERATION.**

This is the sound of refrigerant gas flowing through both indoor and outdoor units.

- **A “Shuh” sound which is heard at the start or immediately after the stop of operation or which is heard at the start or immediately after the stop of DEFROST OPERATION.**

This is the noise of refrigerant caused by flow stop and flow change.

- **A continuous flowing sound "Shah" or a trickling sound "Jyuru Jyuru" are heard when the system is in COOLING OPERATION or at a stop.**

The noise is heard when the drain pump is in operation.

- A “Pishi-pishi” squeaking sound is heard when the system is in operation or after the stop of operation.

Expansion and contraction of plastic parts caused by temperature change makes this noise.

#### VII. DUST FROM THE UNITS

- Dust may blow out from the unit after starting operation from long resting time.  
Dust absorbed by the unit blows out.

#### VIII. THE UNITS GIVE OFF ODORS

The unit absorbs the smell of rooms, furniture, cigarettes, etc., and then emits them.

#### IX. THE LIQUID CRYSTAL OF THE REMOTE CONTROLLER SHOW “88”

- It happens immediately after the main power supply switch is turned on.  
This shows that the remote controller is in normal condition.  
This continues temporary.

## 10. TROUBLE SHOOTING

- I. If one of the following malfunctions occurs, take the measures shown below and contact your Daikin dealer.

The system must be repaired by a qualified service person.



### WARNING

When the air conditioner is in abnormal conditions (smell of something burning, etc), unplug the power cord from the outlet, and contact your dealer

Continued operation under such circumstances may result in a failure, electric shock, and fire.

- If a safety device such as a fuse, a breaker, or an earth leakage breaker frequently actuates, or ON/OFF switch does not properly work.  
**Measure:** Turn off the main power switch
- If water leaks from unit.  
**Measure:** Stop the operation.
- If the display “” (INSPECTION), “UNIT No.”, and the OPERATION lamp flash and the “MALFUNCTION CODE” appears.

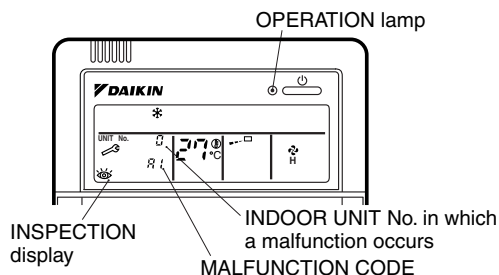

**Measure:** Notify and inform the model name and what the malfunction code indicates to your Daikin dealer.

- II. If the system does not properly operate except for the above mentioned case, and none of the above mentioned malfunctions is evident, investigate the system according to the following procedures.

1. If the system does not operate at all.

- Check if there is a power failure.  
Wait until power is restored. If power failure occurs during operation, the system automatically restarts immediately after the power supply recovers.
- Check if the fuse has blown or breaker has worked.  
Change the fuse or set the breaker.

2. If the system stops operating after operating the system.

- Check if the air inlet or outlet of outdoor or indoor unit is blocked by obstacles.  
Remove the obstacle and make it well-ventilated.
- Check if the air filter is clogged.  
Ask a qualified service person to clean the air filters (Refer to MAINTENANCE).

3. The system operates but it does not sufficiently cool or heat.

- If the air inlet or outlet of the indoor or the outdoor unit is blocked with obstacles.  
Remove the obstacle and make it well-ventilated.
- If the air filter is clogged.  
Ask a qualified service person to clean the air filters (Refer to MAINTENANCE).
- If the set temperature is not proper (Refer to ADJUSTMENT).
- If the FAN SPEED button is set to LOW SPEED (Refer to ADJUSTMENT).
- If the air flow angle is not proper (Refer to AIR FLOW DIRECTION ADJUST).
- If the doors or the windows are open.  
Shut doors or windows to prevent wind from coming in.
- If direct sunlight enters the room (when cooling).  
Use curtains or blinds.
- When there are too many inhabitants in the room (when cooling).  
Cooling effect decreases if heat gain of the room is too large.
- If the heat source of the room is excessive (when cooling).  
Cooling effect decreases if heat gain of the room is too large.



# Part 6

## Service Diagnosis

1. Caution for Diagnosis.....	202
1.1 Troubleshooting with Operation Lamp .....	202
2. Problem Symptoms and Measures .....	204
3. Service Check Function .....	205
4. Code Indication on the Remote Controller .....	208
4.1 Error Codes and Description of Fault .....	208
5. Troubleshooting .....	209
5.1 Indoor Units .....	209
5.2 Outdoor Units .....	210
5.3 Indoor Unit PCB Abnormality .....	211
5.4 Freeze-up Protection Control or High Pressure Control.....	212
5.5 Fan Motor or Related Abnormality .....	214
5.6 Thermistor or Related Abnormality (Indoor Unit).....	217
5.7 Shutter Drive Motor / Shutter Limit Switch Abnormality .....	218
5.8 Signal Transmission Error (between Indoor and Outdoor Units).....	219
5.9 Unspecified Voltage (between Indoor and Outdoor Units) .....	221
5.10 Freeze-up Protection Control .....	222
5.11 Outdoor Unit PCB Abnormality.....	224
5.12 OL Activation (Compressor Overload) .....	225
5.13 Compressor Lock .....	226
5.14 DC Fan Lock .....	228
5.15 Input Over Current Detection .....	229
5.16 Four Way Valve Abnormality .....	231
5.17 Discharge Pipe Temperature Control.....	233
5.18 High Pressure Control in Cooling .....	234
5.19 Compressor Sensor System Abnormality .....	236
5.20 Position Sensor Abnormality .....	238
5.21 CT or Related Abnormality .....	239
5.22 Thermistor or Related Abnormality (Outdoor Unit).....	241
5.23 Electrical Box Temperature Rise.....	243
5.24 Radiation Fin Temperature Rise .....	247
5.25 Output Over Current Detection.....	251
5.26 Insufficient Gas.....	253
5.27 Low-voltage Detection or Over-voltage Detection.....	257
5.28 Signal Transmission Error (on Outdoor Unit PCB).....	258
5.29 Anti-icing Function in Other Rooms / Unspecified Voltage (between Indoor and Outdoor Units).....	259
6. Check.....	260
6.1 How to Check.....	260

# 1. Caution for Diagnosis

## 1.1 Troubleshooting with Operation Lamp

The operation lamp flashes when any of the following errors is detected.

1. When a protection device of the indoor or outdoor unit is activated or when the thermistor malfunctions, disabling equipment operation.

2. When a signal transmission error occurs between the indoor and outdoor units.

In either case, conduct the diagnostic procedure described in the following pages.

### Location of Operation Lamp

In case of  
FTK(X)S 20/25/35 D Series  
FTK(X)S 25/35 E Series

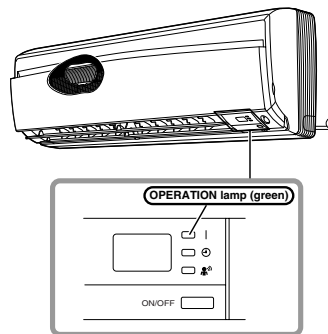

(R4298)

In case of  
FTK(X)S 50/60/71 F Series

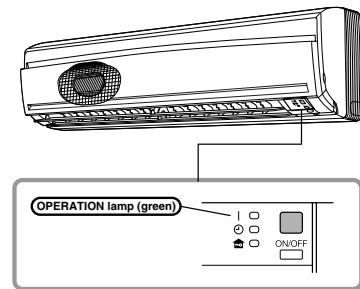

(R6332)

In case of  
FTK(X)S 50/60/71 D Series  
FTKS 50/60/71 B Series

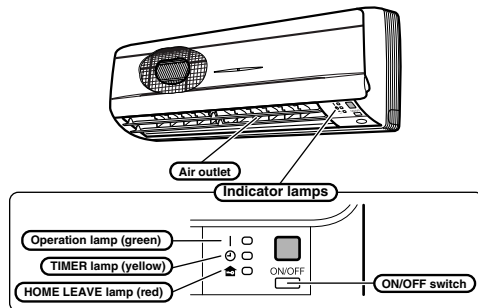

(R2837)

In case of  
FDK(X)S 25/35/50/60 C Series  
FDKS 25/35 E Series  
CDK(X)S 25/35/50/60 C(D) Series  
CDK(X)S 25/35 E Series

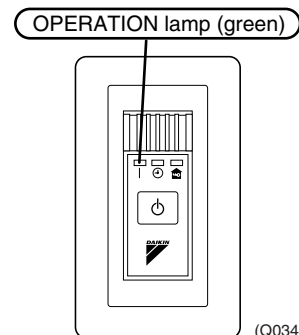

(Q0340)

In case of  
FVK(X)S 25/35/50 B Series

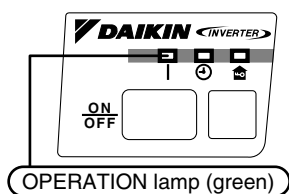

(Q0342)

In case of  
FLK(X)S 25/35/50 B Series

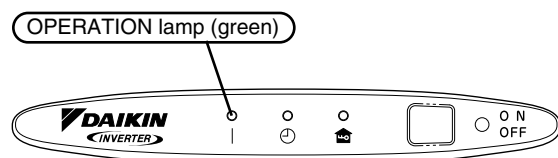

(Q0341)

**Caution:**

Operation stops suddenly. (Operation lamp blinks.)

Cause of above trouble could be "Operation mode conflict".

Check followings;

Are the operation modes all the same for indoor units connected to Multi system outdoor unit?  
If not set all indoor units to the same operation mode and confirm that the operation lamp is not blinking.

Moreover, when the operation mode is in "Auto", set all indoor unit operation mode to "Cool" or "Heat" and check again if the operation lamp is normal.

If the lamp stops blinking after the above steps, there is no malfunction.

★Operation stops and operation lamp blinks only for indoor unit which the different operation mode is set later. (The first set operation mode has priority.)

### Troubleshooting with the LED Indication

#### Outdoor Unit

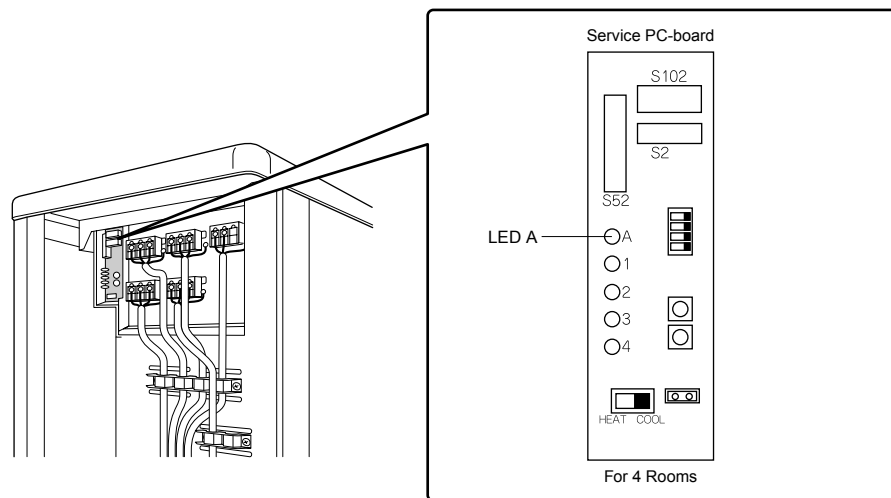

(R6333)

There are green and red LEDs on the PCB. The flashing green LED indicates normal equipment condition, and the OFF condition of the red LED indicates normal equipment condition. (Troubleshooting with the green LED)

The LED A (green) of the outdoor unit indicate microcomputer operation condition.

Even after the error is cancelled and the equipment operates in normal condition, the LED indication remains.



## 2. Problem Symptoms and Measures

Problem Symptom	Check Item	Details of Measure	Page No. to be referred
None of the units operates.	Check the power supply.	Check to make sure that the rated voltage is supplied.	—
	Check the type of the indoor units.	Check to make sure that the indoor unit type is compatible with the outdoor unit.	—
	Check the outdoor air temperature.	Heating operation cannot be used when the outdoor air temperature is 15.5°C or higher (only for heat pump model), and cooling operation cannot be used when the outdoor air temperature is below -10~10 °C (depending on the model).	—
	Diagnosis with indoor unit LED indication	—	209
	Diagnosis with outdoor unit LED indication	—	210
	Check the remote controller addresses.	Check to make sure that address settings for the remote controller and indoor unit are correct.	—
Operation sometimes stops.	Check the power supply.	A power failure of 2 to 10 cycles can stop air conditioner operation. (Operation lamp OFF)	—
	Check the outdoor air temperature.	Heating operation cannot be used when the outdoor air temperature is 15.5°C or higher (only for heat pump model), and cooling operation cannot be used when the outdoor air temperature is below -10~10 °C (depending on the model).	—
	Diagnosis with indoor unit LED indication	—	209
	Diagnosis with outdoor unit LED indication	—	210
Some indoor units do not operate.	Check the type of the indoor units.	Check to make sure that the indoor unit type is compatible with the outdoor unit.	—
	Diagnosis with indoor unit LED indication	—	209
	Diagnosis with outdoor unit LED indication	—	210
Equipment operates but does not cool, or does not heat (only for heat pump model).	Check for wiring and piping errors in the indoor and outdoor units connection wires and pipes.	Conduct the wiring/piping error check described on the product diagnosis nameplate.	—
	Check for thermistor detection errors.	Check to make sure that the main unit's thermistor has not dismantled from the pipe holder.	—
	Check for faulty operation of the electronic expansion valve.	Set the units to cooling operation, and compare the temperatures of the liquid side connection pipes of the connection section among rooms to check the opening and closing operation of the electronic expansion valves of the individual units.	—
	Diagnosis with indoor unit LED indication	—	209
	Diagnosis with outdoor unit LED indication	—	210
	Diagnosis by service port pressure and operating current	Check for insufficient gas.	266
	Large operating noise and vibrations	Check the output voltage of the power transistor.	—
Check the power transistor.		—	—
Check the installation condition.		Check to make sure that the required spaces for installation (specified in the Engineering Data book, etc.) are provided.	—

### 3. Service Check Function

In the **ARC433** series remote controller, the temperature display sections on the main unit indicate corresponding codes.

#### Check Method 1

1. When the timer cancel button is held down for 5 seconds, a "00" indication flashes on the temperature display section.

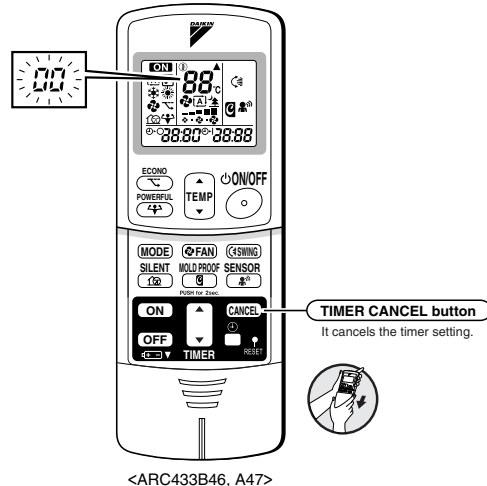

<ARC433B46, A47>

(R7106)

2. Press the timer cancel button repeatedly until a continuous beep is produced.
  - The code indication changes in the sequence shown below, and notifies with a long beep.

No.	Code	No.	Code	No.	Code
1	00	12	07	23	40
2	04	13	48	24	81
3	F3	14	J3	25	P4
4	88	15	R3	26	L3
5	LS	16	R1	27	L4
6	R6	17	04	28	H6
7	85	18	05	29	H7
8	F6	19	H9	30	U2
9	09	20	J6	31	U4
10	U0	21	UR	32	ER
11	87	22	R5	33	R4

#### <In case of ARC433B46, 47>

No.	Code	No.	Code	No.	Code
1	00	12	F6	23	R1
2	04	13	07	24	81
3	LS	14	R3	25	UR
4	88	15	H8	26	U4
5	H6	16	H9	27	P4
6	40	17	09	28	L3
7	R6	18	04	29	L4
8	87	19	05	30	H7
9	U0	20	J3	31	U2
10	F3	21	J6	32	ER
11	R5	22	85	33	R4



#### Note:

1. A short beep and two consecutive beeps indicate non-corresponding codes.
2. To cancel the code display, hold the timer cancel button down for 5 seconds. The code display also cancels itself if the button is not pressed for 1 minute.

## Check Method 2

1. Enter the diagnosis mode.  
Press the 3 buttons (TEMP▲,TEMP▼, MODE) simultaneously.

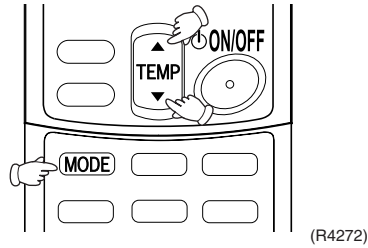

The digit of the number of tens blinks.

★Try again from the start when the digit does not blink.

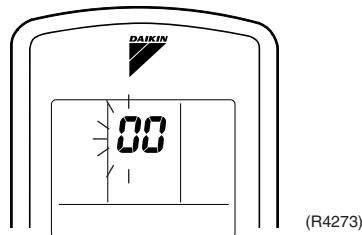

2. Press the TEMP button.  
Press TEMP▲ or TEMP▼ and change the digit until you hear the sound of “beep” or “pi pi”.

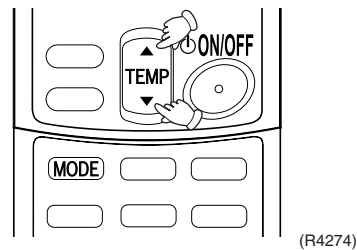

3. Diagnose by the sound.
  - ★“pi” : The number of tens does not accord with the error code.
  - ★“pi pi” : The number of tens accords with the error code.
  - ★“beep” : The both numbers of tens and units accord with the error code. (→ See 7.)

4. Enter the diagnosis mode again.  
Press the MODE button.

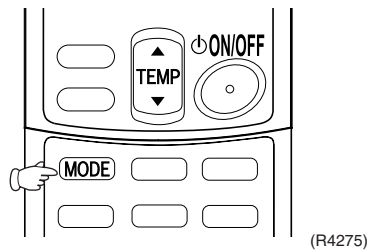

The digit of the number of units blinks.

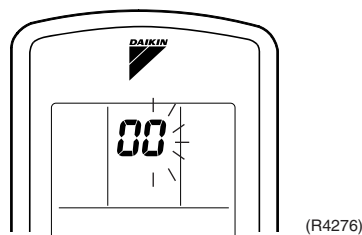

5. Press the TEMP button.  
Press TEMP▲ or TEMP▼ and change the digit until you hear the sound of “beep”.

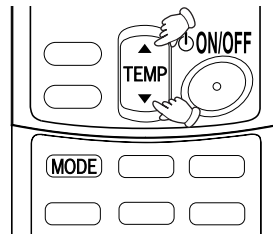

(R4277)

6. Diagnose by the sound.
- ★“pi” : The both numbers of tens and units do not accord with the error code.
  - ★“pi pi” : The number of tens accords with the error code.
  - ★“beep” : The both numbers of tens and units accord with the error code.
7. Determine the error code.  
The digits indicated when you hear the “beep” sound are error code.  
(Error codes and description → Refer to page 208.)
8. Exit from the diagnosis mode.  
Press the MODE button.

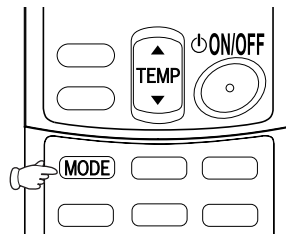

(R4278)

## 4. Code Indication on the Remote Controller

### 4.1 Error Codes and Description of Fault

	Code Indication	Description of Problem
System	00	Normal
	U0	Insufficient gas
	U2	Low-voltage detection or over-voltage detection
	U4	Signal transmission error (between indoor and outdoor units)
	U7	Signal transmission error (on outdoor unit PCB)
	UR	Unspecified voltage (between indoor and outdoor units)
	UH	Anti-icing function in other rooms
Indoor Unit	R1	Indoor unit PCB abnormality
	R5	Freeze-up protection function or high pressure control
	R6	Fan motor or related abnormality
	C4	Heat exchanger temperature thermistor abnormality
	C7	Shutter drive motor / shutter limit switch abnormality
	C9	Room temperature thermistor abnormality
Outdoor Unit	R5	Freeze-up protection control
	E1	Outdoor unit PCB abnormality
	E5	OL activation (compressor overloaded)
	E6	Compressor lock
	E7	DC fan lock
	E8	Input over current detection
	ER	Four way valve abnormality
	F3	Discharge pipe temperature control
	F6	High pressure control in cooling
	H0	Compressor sensor system abnormality
	H6	Position sensor abnormality
	H8	CT or related abnormality
	H9	Outdoor air thermistor or related abnormality
	J3	Discharge pipe thermistor or related abnormality
	J6	Heat exchanger thermistor or related abnormality
	J8	Liquid pipe thermistor or related abnormality
	J9	Gas pipe thermistor or related abnormality
	L3	Electrical box temperature rise
	L4	Radiation fin temperature rise
	L5	Output over current detection
P4	Radiation fin thermistor or related abnormality	

## 5. Troubleshooting

### 5.1 Indoor Units

- : Not used for troubleshooting

\* : Varies depending on the cases.

Indication on the remote controller	Description of the Fault		Details of fault (Refer to the indicated page.)
00	Indoor unit in normal condition (Conduct a diagnosis of the outdoor unit.)		—
P1	Indoor unit PCB abnormality		211
P5	Freeze-up protection control or high pressure control (heat pump model only)		212
P6	Fan motor or related abnormality	AC motor	214
		DC motor	215
C4	Heat exchanger thermistor or related abnormality		217
C7	Shutter drive motor / shutter limit switch abnormality		218
C9	Room temperature thermistor abnormality		217
U4	Signal transmission error (between indoor and outdoor units)		219
UR	Unspecified voltage (between indoor and outdoor units)		221

## 5.2 Outdoor Units

☉: ON, ●: OFF, ◐: Blinks

Green : Flashes when in normal condition

Red : OFF in normal condition

- : Not used for troubleshooting

\* : Varies depending on the cases.

Outdoor Unit LED Indication					Indication on the remote controller	Description of The Fault	Reference Page
Green	Red						
A	1	2	3	4			
◐	●	●	●	●	00	Outdoor unit in normal condition (Conduct a diagnosis of the indoor unit.)	—
					UR	Unspecified voltage (between indoor and outdoor units)	259
					UH	Anti-icing function in other rooms	259
◐	●	●	☉	☉	(U0)	Insufficient gas	253
◐	☉	●	●	☉	U2	Low-voltage detection or over-voltage detection	257
◐	●	☉	☉	☉	U7	Signal transmission error (on outdoor unit PCB)	258
◐	☉	●	☉	☉	R5	Freeze-up protection control	222
◐	☉	☉	☉	●	E1	Outdoor unit PCB abnormality	224
◐	☉	●	☉	●	(E5)	OL activation (compressor overload)	225
◐	●	☉	☉	●	(E6)	Compressor lock	226
◐	☉	☉	☉	☉	E7	DC fan lock	228
◐	●	☉	●	☉	E8	Input over current detection	229
◐	☉	●	●	●	E9	Four way valve abnormality	231
◐	☉	●	☉	●	F3	Discharge pipe temperature control	233
◐	☉	●	☉	☉	F6	High pressure control in cooling	234
◐	☉	☉	●	●	H0	Compressor sensor system abnormality	236
					H8	CT or related abnormality	239
◐	☉	☉	●	●	H6	Position sensor abnormality	238
					H9	Outdoor air thermistor or related abnormality	241
					J3	Discharge pipe thermistor or related abnormality	241
					J5	Heat exchanger thermistor or related abnormality	241
					J8	Liquid pipe thermistor or related abnormality	241
					J9	Gas pipe thermistor or related abnormality	241
◐	☉	☉	●	☉	P4	Radiation fin thermistor or related abnormality	241
					L3	Electrical box temperature rise	243
◐	●	●	●	☉	L4	Radiation fin temperature rise (Protection of driver overheating)	247
◐	●	●	☉	●	L5	Output over current detection	251



**Note:**

- The indications in the parenthesis ( ) in the remote controller display column are displayed only when system-down occurs.
- When a sensor error occurs, check the remote controller display to determine which sensor is malfunctioning.  
If the remote controller does not indicate the error type, conduct the following operation.  
\*Turn the power switch off and back on again. If the same LED indication appears again immediately after the power is turned on, the fault is in the thermistor.  
\*If the above condition does not result, the fault is in the CT.
- The indoor unit error indication may take the precedence in the remote controller display.

## 5.3 Indoor Unit PCB Abnormality

Remote  
Controller  
Display

81

Method of  
Malfunction  
Detection

Evaluation of zero-cross detection of power supply by indoor unit.

Malfunction  
Decision  
Conditions

When there is no zero-cross detection in approximately 10 continuous seconds.

Supposed  
Causes

- Faulty indoor unit PCB
- Faulty connector connection

Troubleshooting

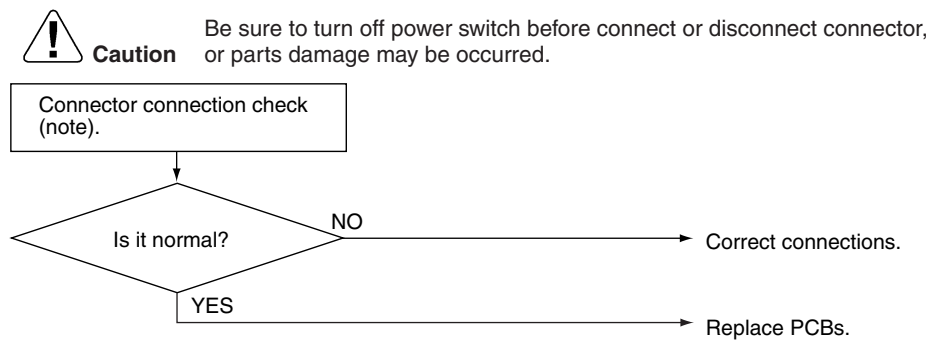

(R1400)



**Note:** Connector Nos. vary depending on models.  
Control connector

Model Type	Connector No.
Wall Mounted Type	Terminal strip~Control PCB
Duct Connected Type	Terminal strip~Control PCB
Floor / Ceiling Suspended Dual Type	S37
Floor Standing Type	Control PCB : S7, S201, S203 Power Supply PCB : S8, S202, S204



## 5.4 Freeze-up Protection Control or High Pressure Control

<p><b>Remote Controller Display</b></p>	<p style="text-align: center; font-size: 2em; color: blue;">85</p>
<p><b>Method of Malfunction Detection</b></p>	<ul style="list-style-type: none"> <li>■ High pressure control (heat pump model only) During heating operations, the temperature detected by the indoor heat exchanger thermistor is used for the high pressure control (stop, outdoor fan stop, etc.)</li> <li>■ The freeze-up protection control (operation halt) is activated during cooling operation according to the temperature detected by the indoor unit heat exchanger thermistor.</li> </ul>
<p><b>Malfunction Decision Conditions</b></p>	<ul style="list-style-type: none"> <li>■ High pressure control During heating operations, the temperature detected by the indoor heat exchanger thermistor is above 65°C</li> <li>■ Freeze-up protection When the indoor unit heat exchanger temperature is below 0°C during cooling operation.</li> </ul>
<p><b>Supposed Causes</b></p>	<ul style="list-style-type: none"> <li>■ Operation halt due to clogged air filter of the indoor unit.</li> <li>■ Operation halt due to dust accumulation on the indoor unit heat exchanger.</li> <li>■ Operation halt due to short-circuit.</li> <li>■ Detection error due to faulty indoor unit heat exchanger thermistor.</li> <li>■ Detection error due to faulty indoor unit PCB.</li> </ul>

Troubleshooting



**Check No.06**  
Refer to P.263



**Caution**

Be sure to turn off power switch before connect or disconnect connector, or parts damage may be occurred.

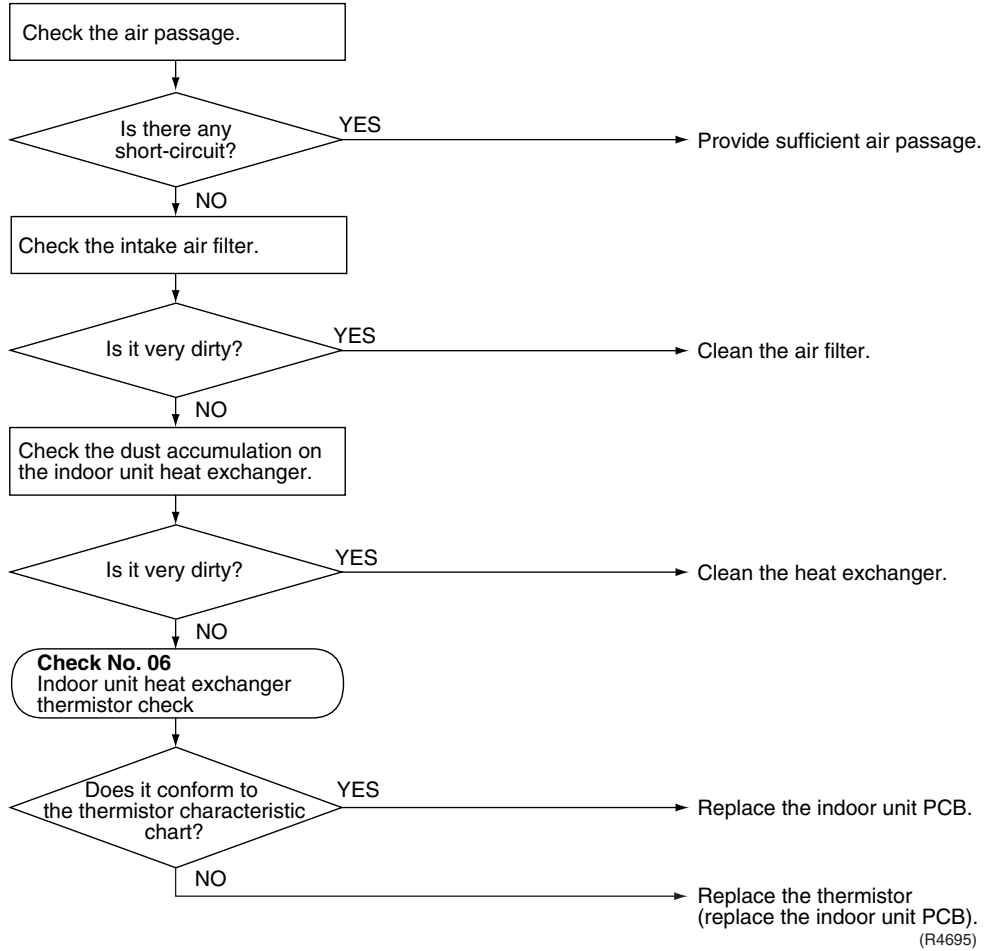

## 5.5 Fan Motor or Related Abnormality

### 5.5.1 AC Motor

Remote  
Controller  
Display



Method of  
Malfunction  
Detection

The rotation speed detected by the Hall IC during fan motor operation is used to determine abnormal fan motor operation.

Malfunction  
Decision  
Conditions

When the detected rotation speed does not reach the demanded rotation speed of the target tap, and is less than 50% of the maximum fan motor rotation speed.

Supposed  
Causes

- Operation halt due to short circuit inside the fan motor winding.
- Operation halt due to breaking of wire inside the fan motor.
- Operation halt due to breaking of the fan motor lead wires.
- Operation halt due to faulty capacitor of the fan motor.
- Detection error due to faulty control PCB.

#### Troubleshooting



Check No.16  
Refer to P.269



**Caution**

Be sure to turn off power switch before connect or disconnect connector, or parts damage may be occurred.

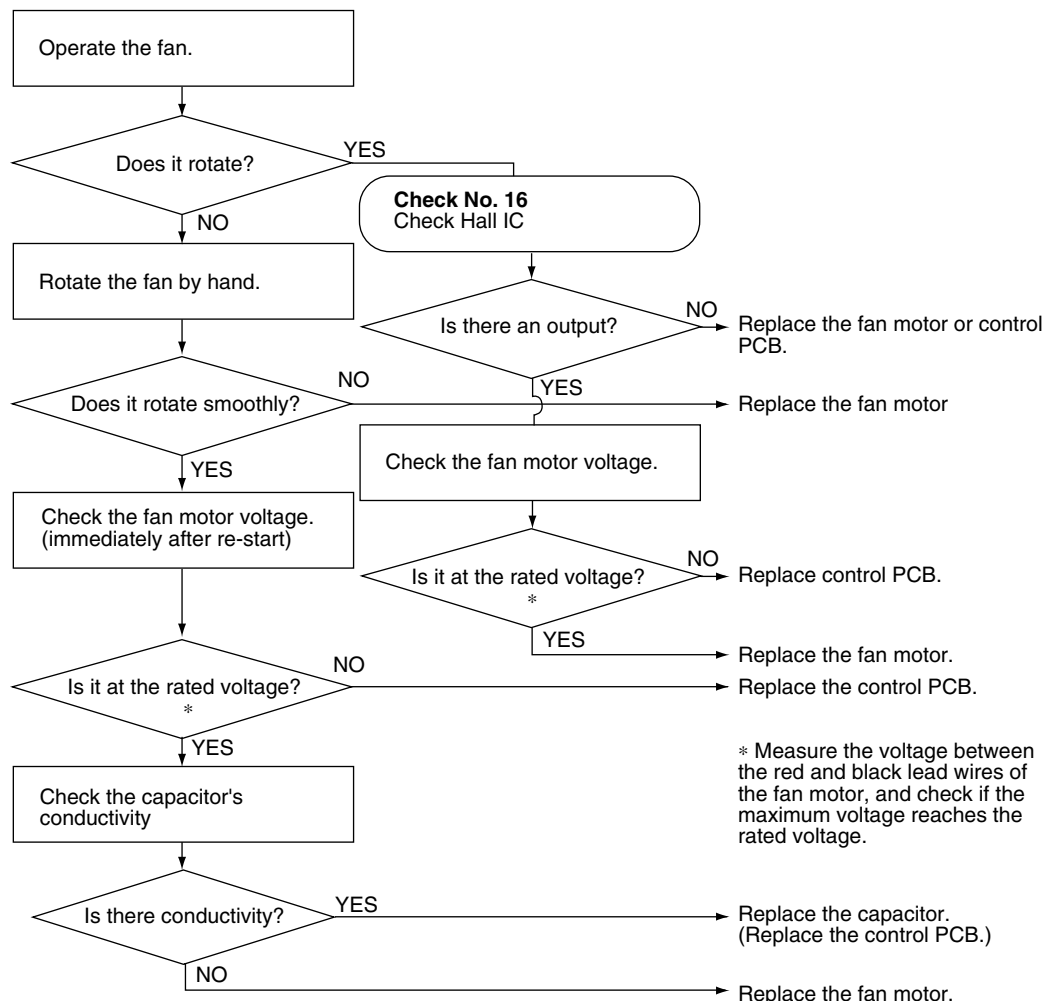

(R3219)

## 5.5.2 DC Motor

### Remote Controller Display



### Method of Malfunction Detection

The rotation speed detected by the [Hall IC](#) during fan motor operation is used to determine abnormal fan motor operation.

### Malfunction Decision Conditions

When the detected rotation speed does not reach the demanded rotation speed of the target tap, and is less than 50% of the maximum fan motor rotation speed.

### Supposed Causes

- Operation halt due to short circuit inside the fan motor winding.
- Operation halt due to breaking of wire inside the fan motor.
- Operation halt due to breaking of the fan motor lead wires.
- Operation halt due to faulty capacitor of the fan motor.
- Detection error due to faulty indoor unit PCB.

Troubleshooting



**Check No.01**  
Refer to P.260



**Check No.02**  
Refer to P.260



**Caution**

Be sure to turn off power switch before connect or disconnect connector, or parts damage may be occurred.

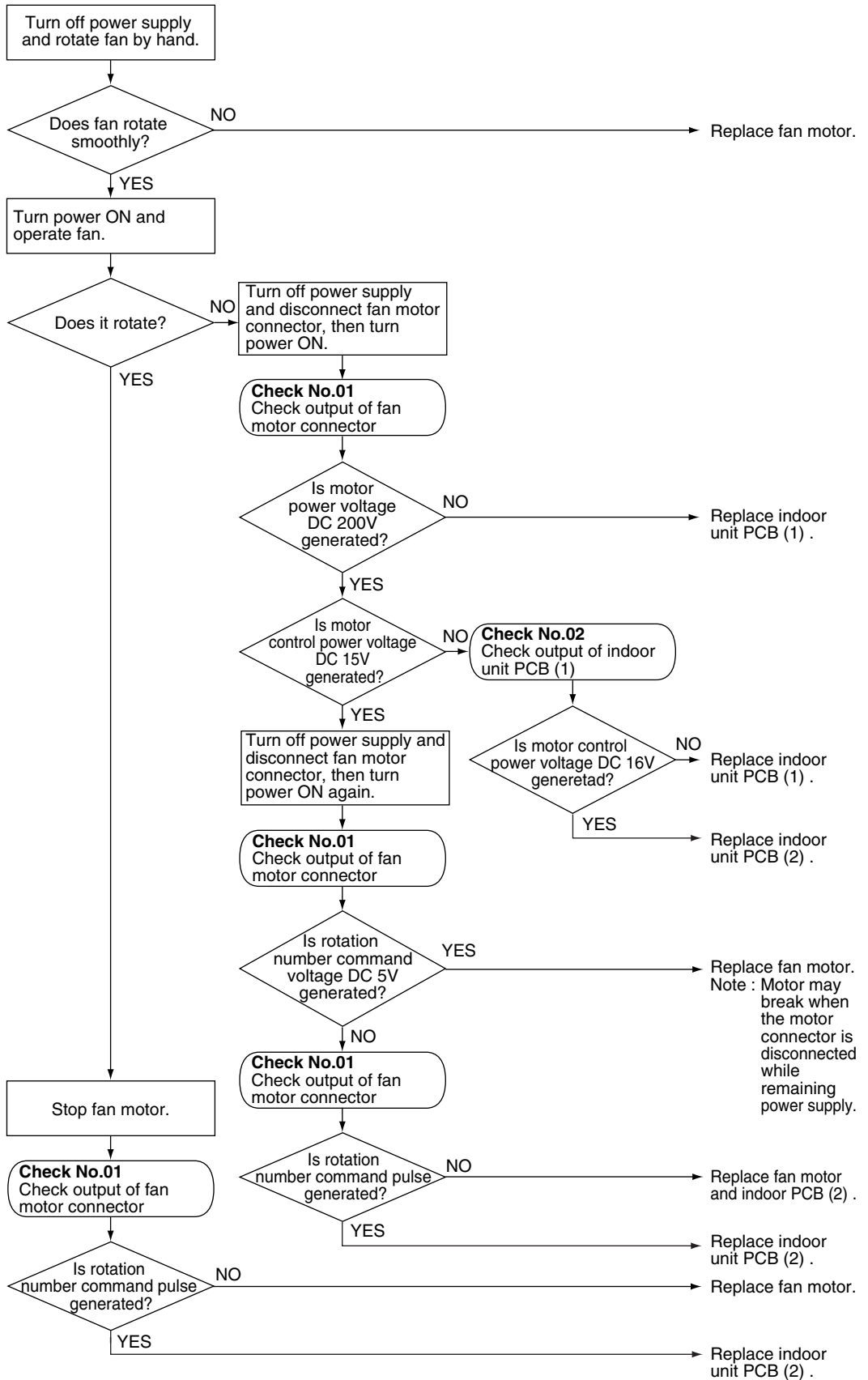

(R1214)

## 5.6 Thermistor or Related Abnormality (Indoor Unit)

Remote  
Controller  
Display

⌘4,⌘9

Method of  
Malfunction  
Detection

The temperatures detected by the thermistors are used to determine thermistor errors.

Malfunction  
Decision  
Conditions

When the thermistor input is more than 4.96 V or less than 0.04 V during compressor operation\*.

\* (reference)

When above about 212°C (less than 120 ohms) or below about -50°C (more than 1,860 kohms).



**Note:** The values vary slightly in some models.

Supposed  
Causes

- Faulty connector connection
- Faulty thermistor
- Faulty PCB

Troubleshooting



Check No.06  
Refer to P.263



**Caution**

Be sure to turn off power switch before connect or disconnect connector, or parts damage may be occurred.

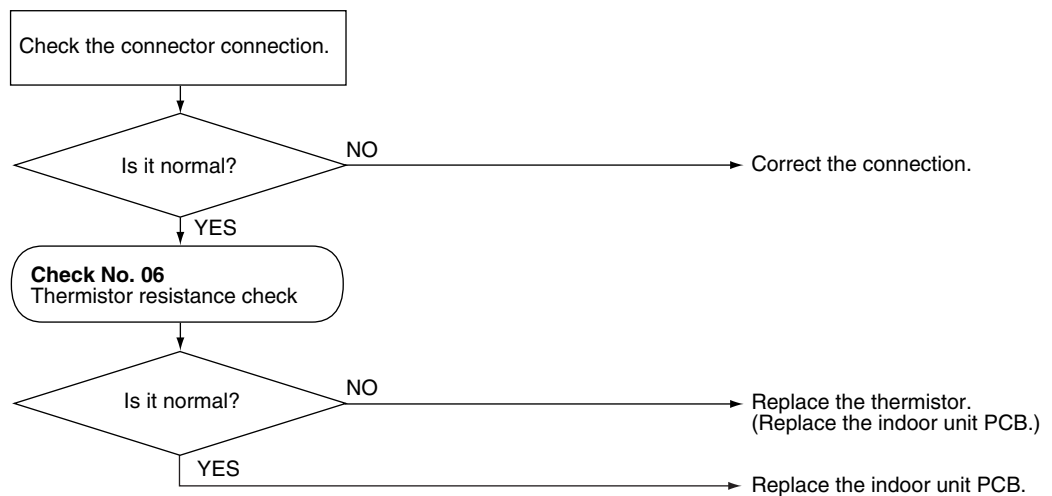

(R4696)

⌘4 : Indoor heat exchanger thermistor

⌘9 : Room temperature thermistor

## 5.7 Shutter Drive Motor / Shutter Limit Switch Abnormality

Remote Controller Display



Method of Malfunction Detection

The shutter open / close performance is detected by the limit switch attached on its structure. In this way, the shutter drive motor and the shutter limit switch are checked for failure.

Malfunction Decision Conditions

When the shutter is open, the limit switch is closed.

Supposed Causes

- Shutter drive motor defective
- Shutter limit switch defective
- Shutter itself deformed (warped)
- Shutter's sealing material too thick
- Detection error by broken relay harness or disconnected connector
- Detection error due to defective PCB (2)
- Foreign substance in blow port

### Troubleshooting



Check No.03  
Refer to P.260



**Caution**

Be sure to turn off power switch before connect or disconnect connector, or parts damage may be occurred.

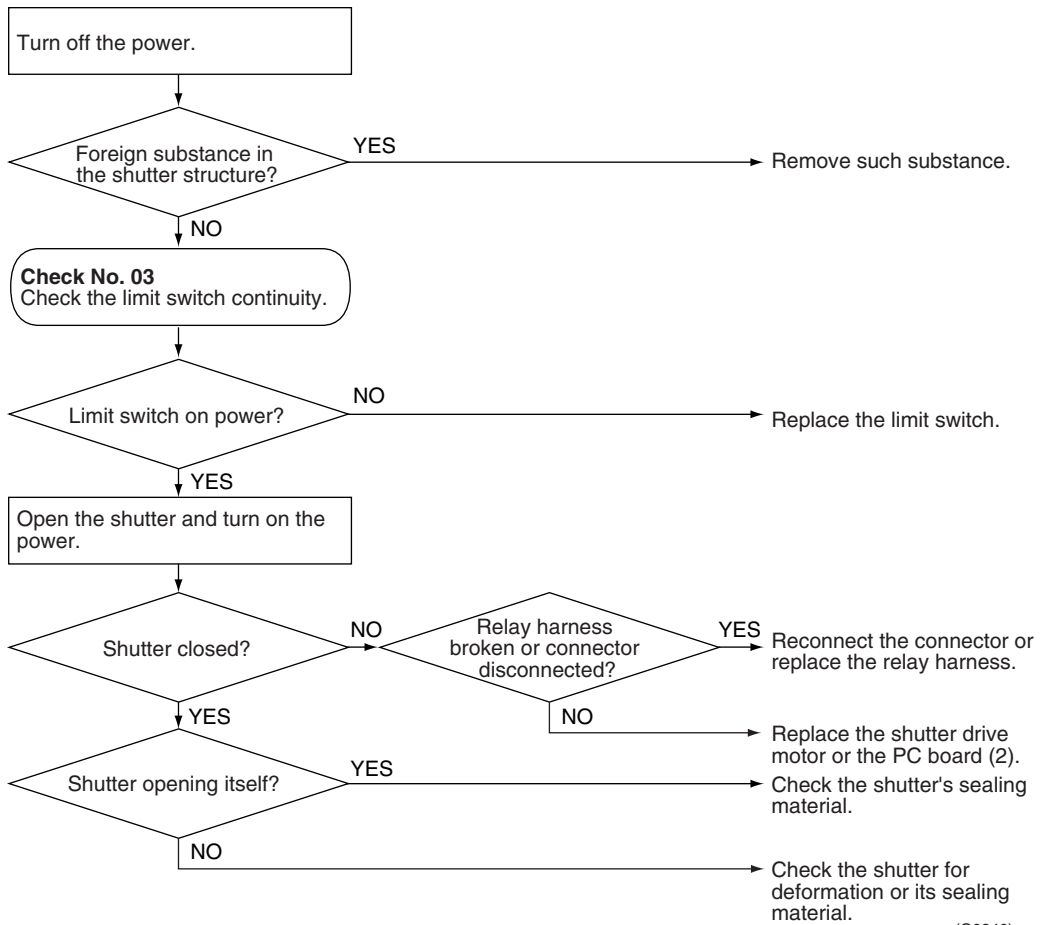

(Q0346)

## 5.8 Signal Transmission Error (between Indoor and Outdoor Units)

Remote  
Controller  
Display

U4

Method of  
Malfunction  
Detection

The data received from the outdoor unit in indoor unit-outdoor unit signal transmission is checked whether it is normal.

Malfunction  
Decision  
Conditions

When the data sent from the outdoor unit cannot be received normally, or when the content of the data is abnormal.

Supposed  
Causes

- Faulty outdoor unit PCB.
- Faulty indoor unit PCB.
- Indoor unit-outdoor unit signal transmission error due to wiring error.
- Indoor unit-outdoor unit signal transmission error due to disturbed power supply waveform.
- Indoor unit-outdoor unit signal transmission error due to breaking of wire in the connection wires between the indoor and outdoor units (wire No. 2).
- Short circuit inside the fan motor winding.



Troubleshooting



**Check No.10**  
Refer to P.266

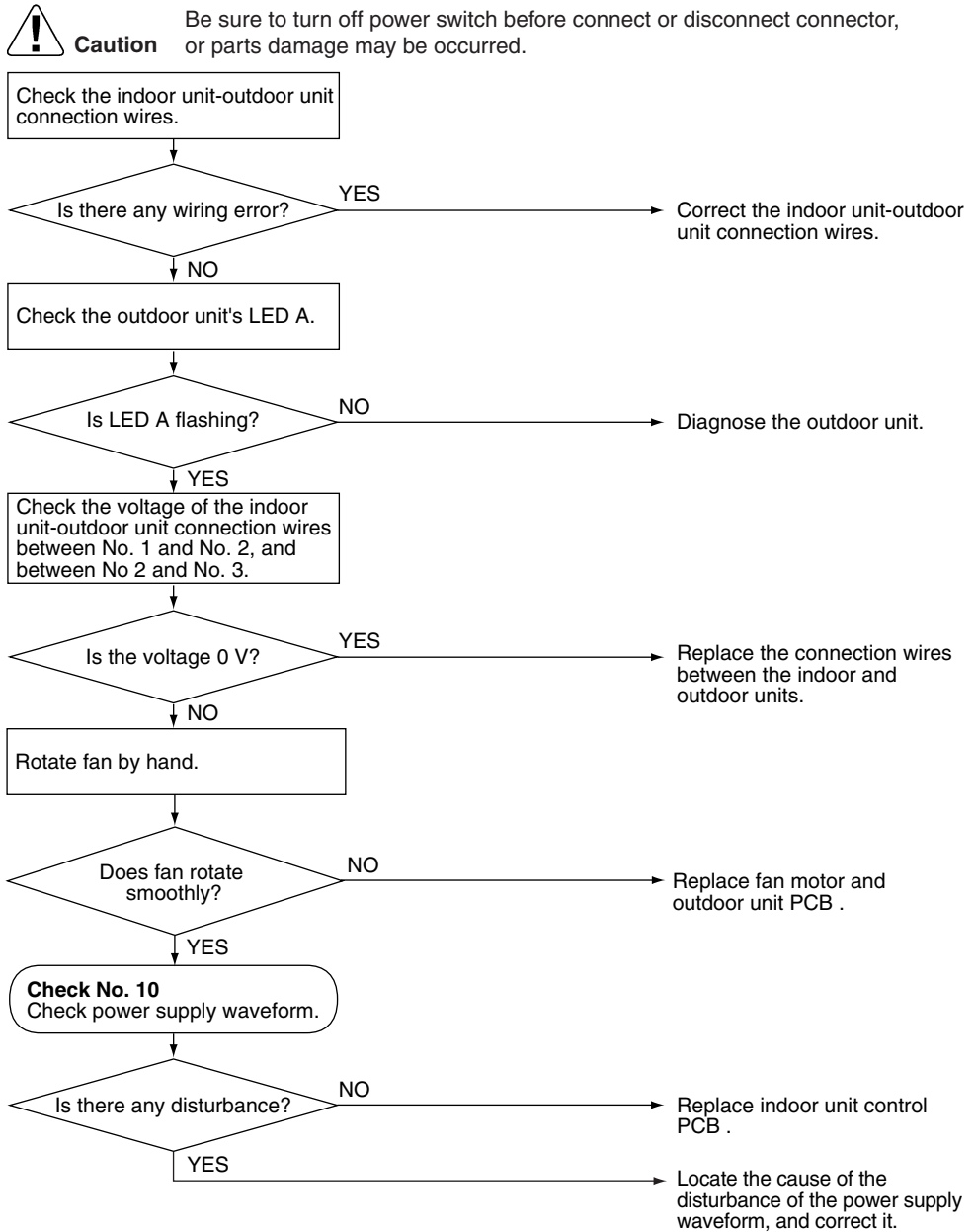

(R6471)

## 5.9 Unspecified Voltage (between Indoor and Outdoor Units)

Remote  
Controller  
Display

UR

Method of  
Malfunction  
Detection

The supply power is detected for its requirements (different from pair type and multi type) by the indoor / outdoor transmission signal.

Malfunction  
Decision  
Conditions

The pair type and multi type are interconnected.

Supposed  
Causes

- Wrong models interconnected
- Wrong indoor unit PCB mounted
- Indoor unit PCB defective
- Wrong outdoor unit PCB mounted or defective

Troubleshooting

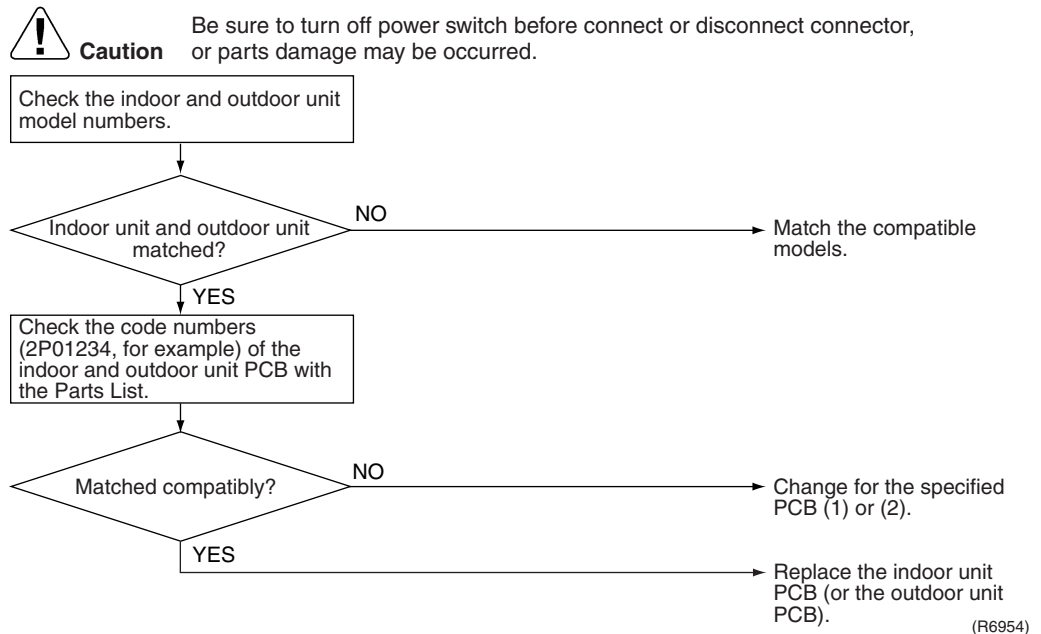

## 5.10 Freeze-up Protection Control

<p><b>Remote Controller Display</b></p>	<p>RS</p>
<p><b>Outdoor Unit LED Display</b></p>	<p>A ● 1 ○ 2 ● 3 ○ 4 ○</p>
<p><b>Method of Malfunction Detection</b></p>	<p>Indoor unit icing, during cooling operation, is detected by checking the temperatures sensed by the indoor unit heat exchanger thermistor and room temperature thermistor that are located in a shut-down room.</p>
<p><b>Malfunction Decision Conditions</b></p>	<p>In the cooling mode, the following conditions (A) and (B) are kept together for 5 minutes.                  (A) Indoor unit heat exchanger temperature <math>\leq -1^{\circ}\text{C}</math>                  (B) Indoor unit heat exchanger temperature <math>\leq</math> Room temperature <math>-10^{\circ}\text{C}</math></p> <p>If the freeze-up protection control is activated 4 times continuously, the system will be shut down.                  (The 4-time counter will reset itself if any of the following errors does not occur for 60 minutes: OL, radiation fin temperature rise, gas shortage, and compressor startup.)</p>
<p><b>Supposed Causes</b></p>	<ul style="list-style-type: none"> <li>■ Wrong wiring or piping</li> <li>■ EV malfunctioning in each room</li> <li>■ Short-circuit</li> <li>■ Indoor unit heat exchanger thermistor defective</li> <li>■ Room temperature thermistor defective</li> </ul>

Troubleshooting



**Check No.04**  
Refer to P.261



**Check No.06**  
Refer to P.263



**Caution**

Be sure to turn off power switch before connect or disconnect connector, or parts damage may be occurred.

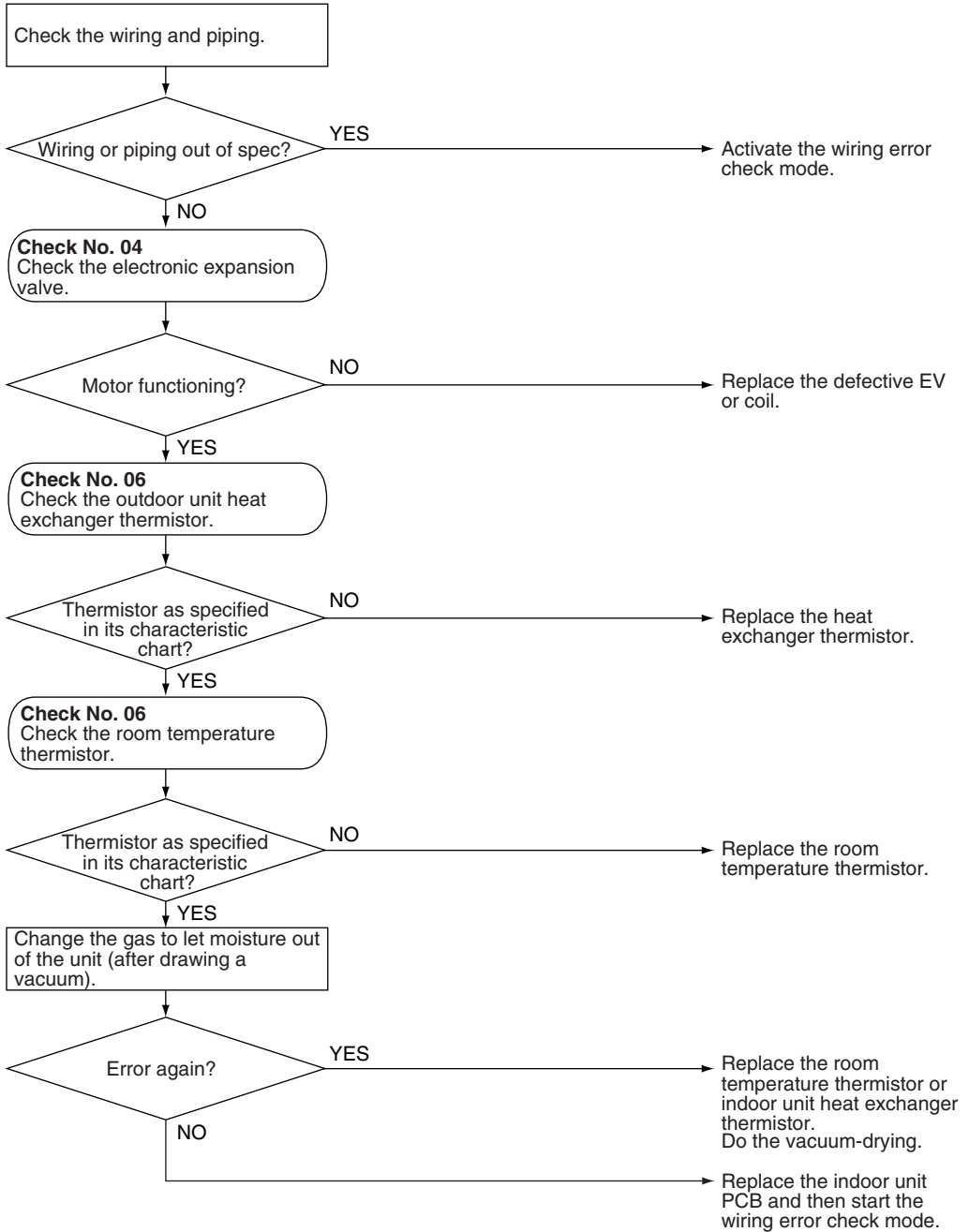

(R4715)

## 5.11 Outdoor Unit PCB Abnormality

Remote  
Controller  
Display



Outdoor Unit LED  
Display

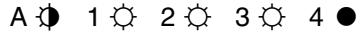

Method of  
Malfunction  
Detection

- Detect within the programme of the microcomputer that the programme is in normal running order.

Malfunction  
Decision  
Conditions

- When the programme of the microcomputer is in abnormal running order.

Supposed  
Causes

- Out of control of microcomputer caused by external factors
  - Noise
  - Momentary fall of voltage
  - Momentary power loss
- Defective outdoor unit PCB

### Troubleshooting



**Caution**

Be sure to turn off power switch before connect or disconnect connector, or parts damage may be occurred.

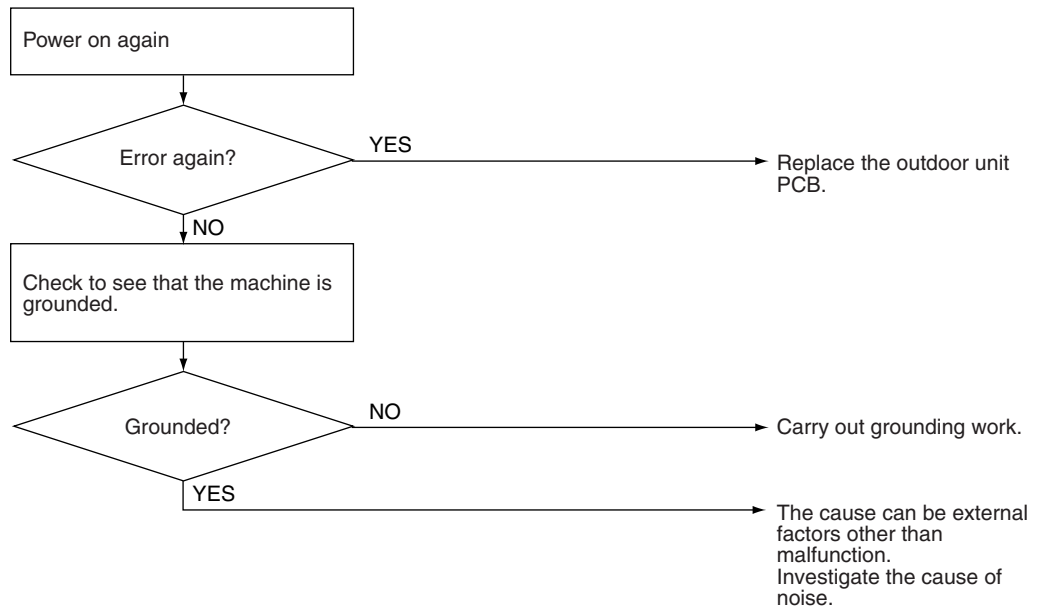

(R5142)

## 5.12 OL Activation (Compressor Overload)

Remote  
Controller  
Display



Outdoor Unit LED  
Display

A ● 1 ● 2 ● 3 ● 4 ●

Method of  
Malfunction  
Detection

A compressor overload is detected through compressor OL.

Malfunction  
Decision  
Conditions

- If the compressor OL is activated twice, the system will be shut down.
- The error counter will reset itself if this or any other error does not occur during the following 60-minute compressor running time (total time).
- \* The operating temperature condition is not specified.

Supposed  
Causes

- Refrigerant shortage
- Four way valve malfunctioning
- Outdoor unit PCB defective
- Water mixed in the local piping
- Electronic expansion valve defective
- Stop valve defective

### Troubleshooting



Check No.04  
Refer to P.261



Check No.05  
Refer to P.262



Check No.06  
Refer to P.263



Check No.11  
Refer to P.266



#### Caution

Be sure to turn off power switch before connect or disconnect connector, or parts damage may be occurred.

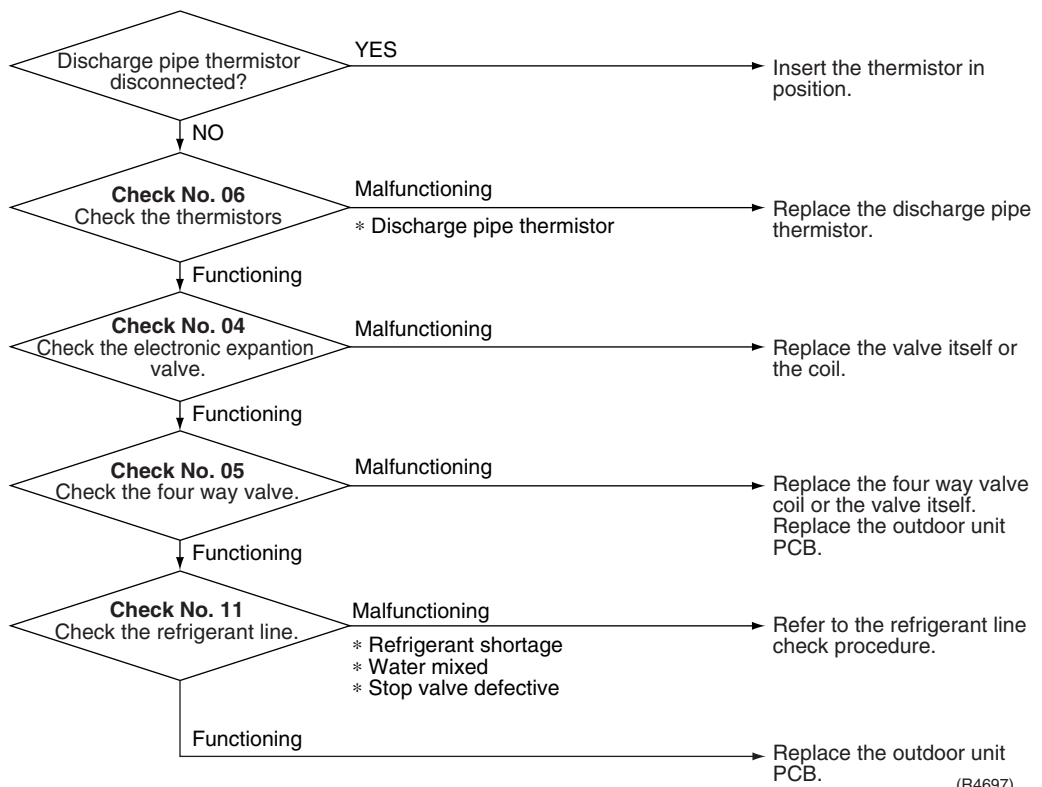

## 5.13 Compressor Lock

### 5.13.1 E Series (68-75 Class), D Series

Remote  
Controller  
Display



Outdoor Unit LED  
Display

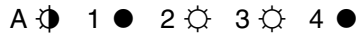

Method of  
Malfunction  
Detection

A compressor lock is detected by checking the compressor running condition through the position detection circuit.

Malfunction  
Decision  
Conditions

- The position detection circuit detects a compressor frequency of below 10 Hz for 20 seconds or a frequency of above 160 Hz.
- 40 seconds after the compressor has started, the position detection circuit detects a compressor frequency of above 180 Hz.
- The system will be shut down if the error occurs 16 times.
- Clearing condition: Continuous run for about 5 minutes (normal)

Supposed  
Causes

- Compressor locked

#### Troubleshooting

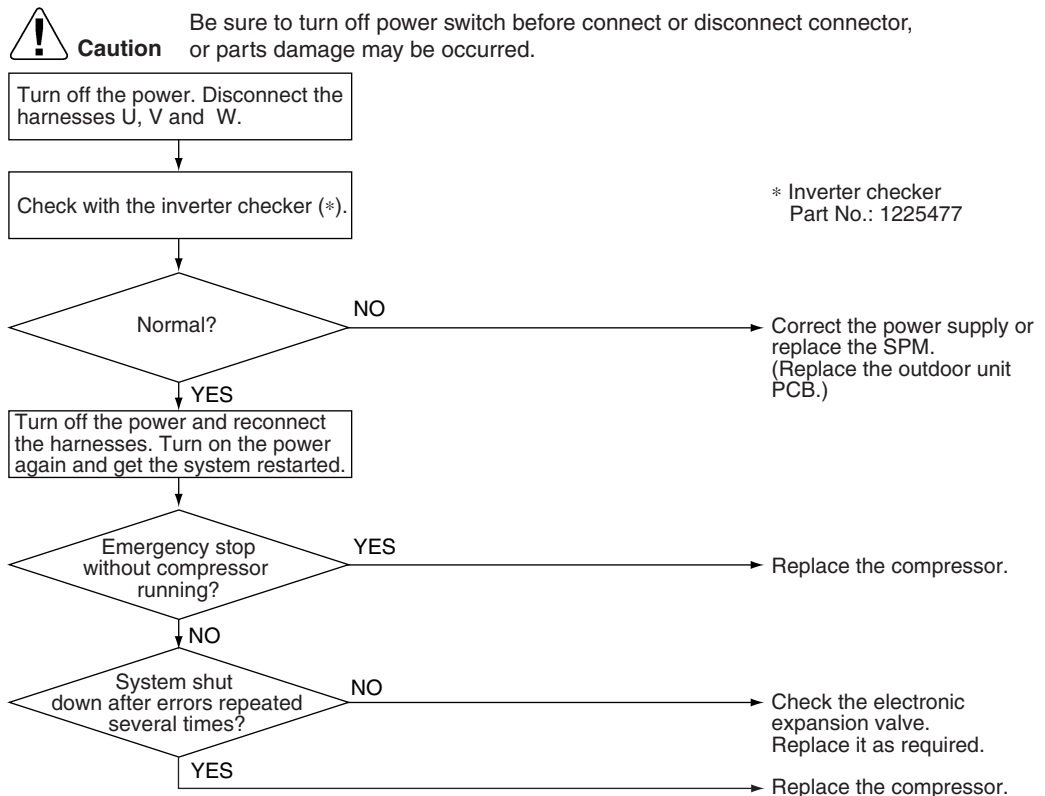

(R2842)

## 5.13.2 E Series (50-58 Class, 80-100 Class)

Remote  
Controller  
Display



Outdoor Unit LED  
Display

A 1 2 3 4

Method of  
Malfunction  
Detection

A compressor lock is detected by checking the compressor running condition through the position detection circuit.

Malfunction  
Decision  
Conditions

- Judging from current waveform generated when high-frequency voltage is applied to the compressor.
- The system will be shut down if the error occurs 16 times.
- Clearing condition: Continuous run for about 5 minutes (normal)

Supposed  
Causes

- Compressor locked

Troubleshooting

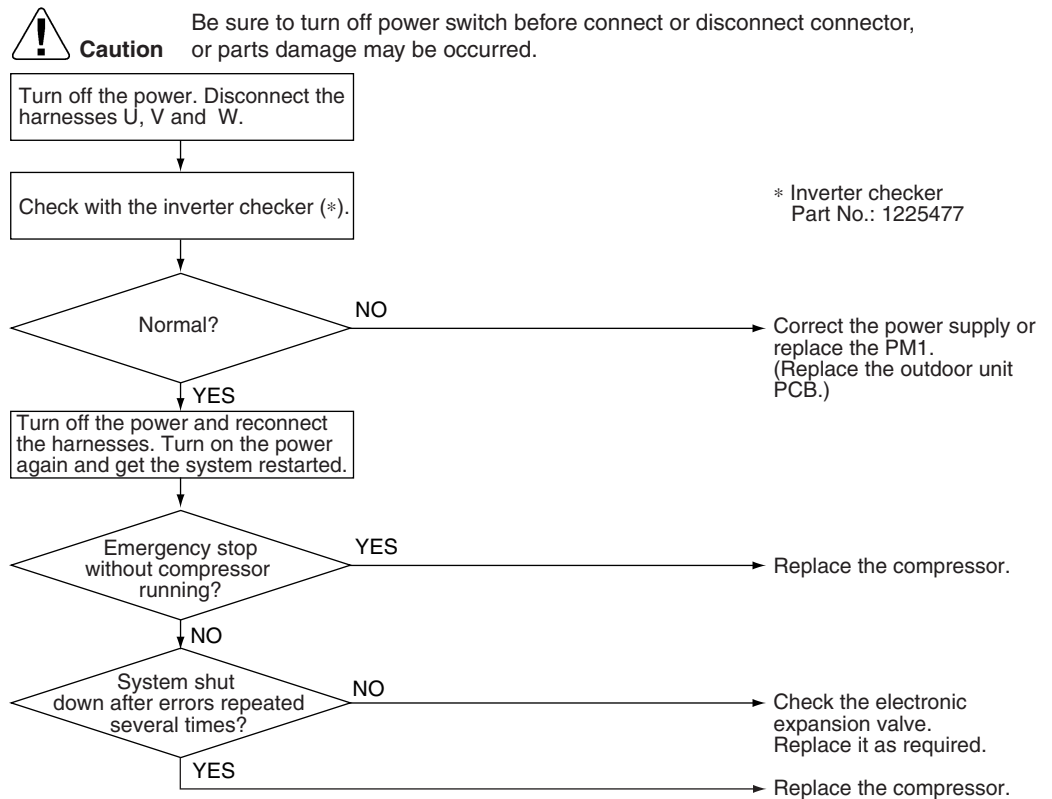

(R5143)



## 5.14 DC Fan Lock

Remote  
Controller  
Display



Outdoor Unit LED  
Display



Method of  
Malfunction  
Detection

A fan motor line error is detected by checking the high-voltage fan motor rpm being detected by the Hall IC.

Malfunction  
Decision  
Conditions

- The fan does not start in 30 seconds even when the fan motor is running.
- The system will be shut down if the error occurs 16 times.
- Clearing condition: Continuous run for about 5 minutes (normal)

Supposed  
Causes

- Fan motor breakdown
- Harness or connector disconnected between fan motor and PCB or in poor contact
- Foreign matters stuck in the fan

### Troubleshooting



Check No.15  
Refer to P.268

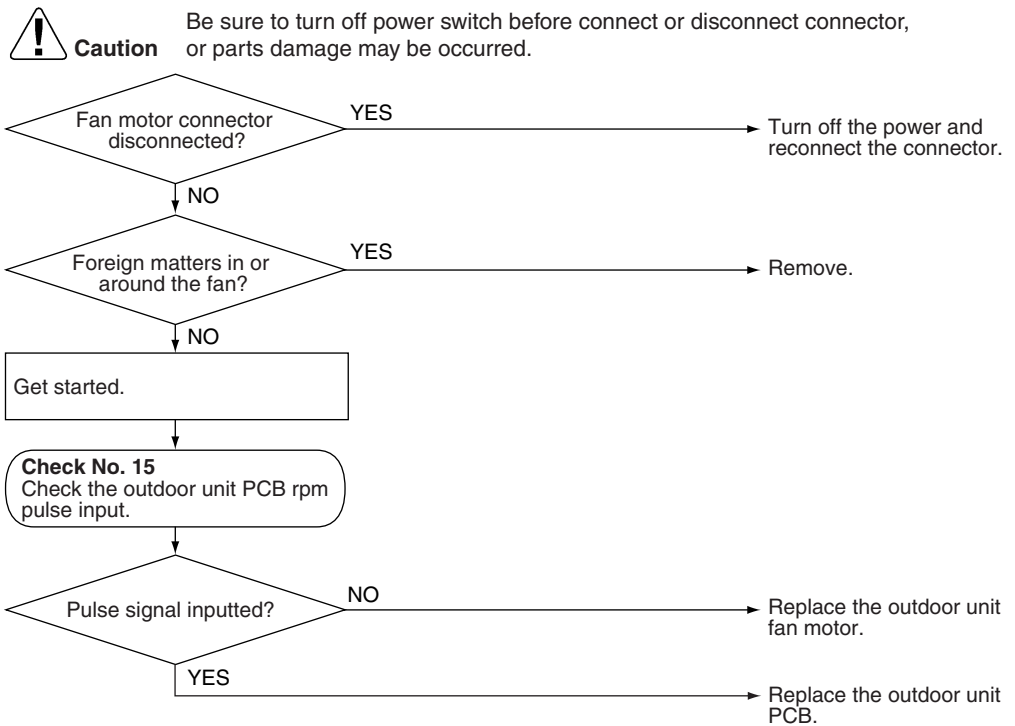

(R2843)

## 5.15 Input Over Current Detection

### Remote Controller Display



### Outdoor Unit LED Display



### Method of Malfunction Detection

Malfunction is detected by checking the input current value.

### Malfunction Decision Conditions

- The input current is a certain value (depending on the model) or over for 2.5 seconds.
- The compressor halts if the error occurs, and restarts automatically after 3 minutes stand-by.

### Supposed Causes

- Over-current due to compressor failure
- Over-current due to defective power transistor
- Over-current due to defective inverter main circuit electrolytic capacitor
- Over-current due to defective outdoor unit PCB
- Error detection due to outdoor unit PCB
- Over-current due to short-circuit

Troubleshooting



**Check No.07**  
Refer to P.264



**Check No.08**  
Refer to P.265



**Check No.14**  
Refer to P.268



**Caution**

Be sure to turn off power switch before connect or disconnect connector, or parts damage may be occurred.

\* An input over-current may result from wrong internal wiring. If the wires have been disconnected and reconnected for part replacement, for example, and the system is interrupted by an input over-current, take the following procedure.

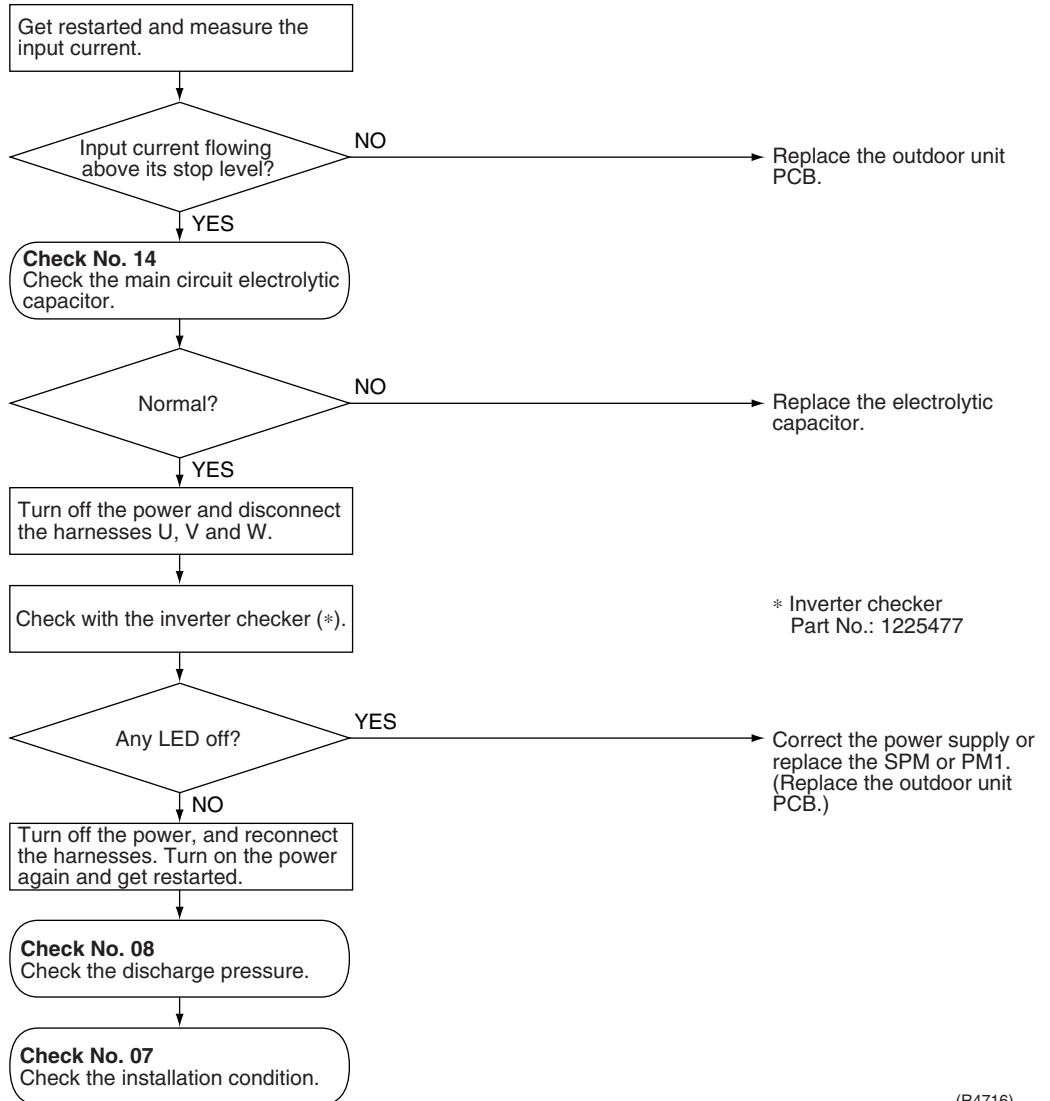





(R4716)

## 5.16 Four Way Valve Abnormality

Remote  
Controller  
Display

EA

Outdoor Unit LED  
Display

A  1  2  3  4 

Method of  
Malfunction  
Detection

The liquid pipe thermistor, the outdoor temperature thermistor and the outdoor unit heat exchanger thermistor are checked to see if they function within their normal ranges in the operating mode.

Malfunction  
Decision  
Conditions

Either of the following conditions occurs 6 minutes after the compressor has started.

- Cooling / dry operation  
(Outdoor unit heat exchanger temperature – Liquid pipe temperature) < -5°C
- Heating operation  
(Liquid pipe temperature – Outdoor unit heat exchanger temperature) < 0°C

Supposed  
Causes

- Connector in poor contact
- Thermistor defective
- Outdoor unit PCB defective
- Four way valve coil or harness defective
- Four way valve defective
- Foreign substance mixed in refrigerant

Troubleshooting



**Check No.05**  
Refer to P.262



**Check No.06**  
Refer to P.263



**Check No.11**  
Refer to P.266



**Caution**

Be sure to turn off power switch before connect or disconnect connector, or parts damage may be occurred.

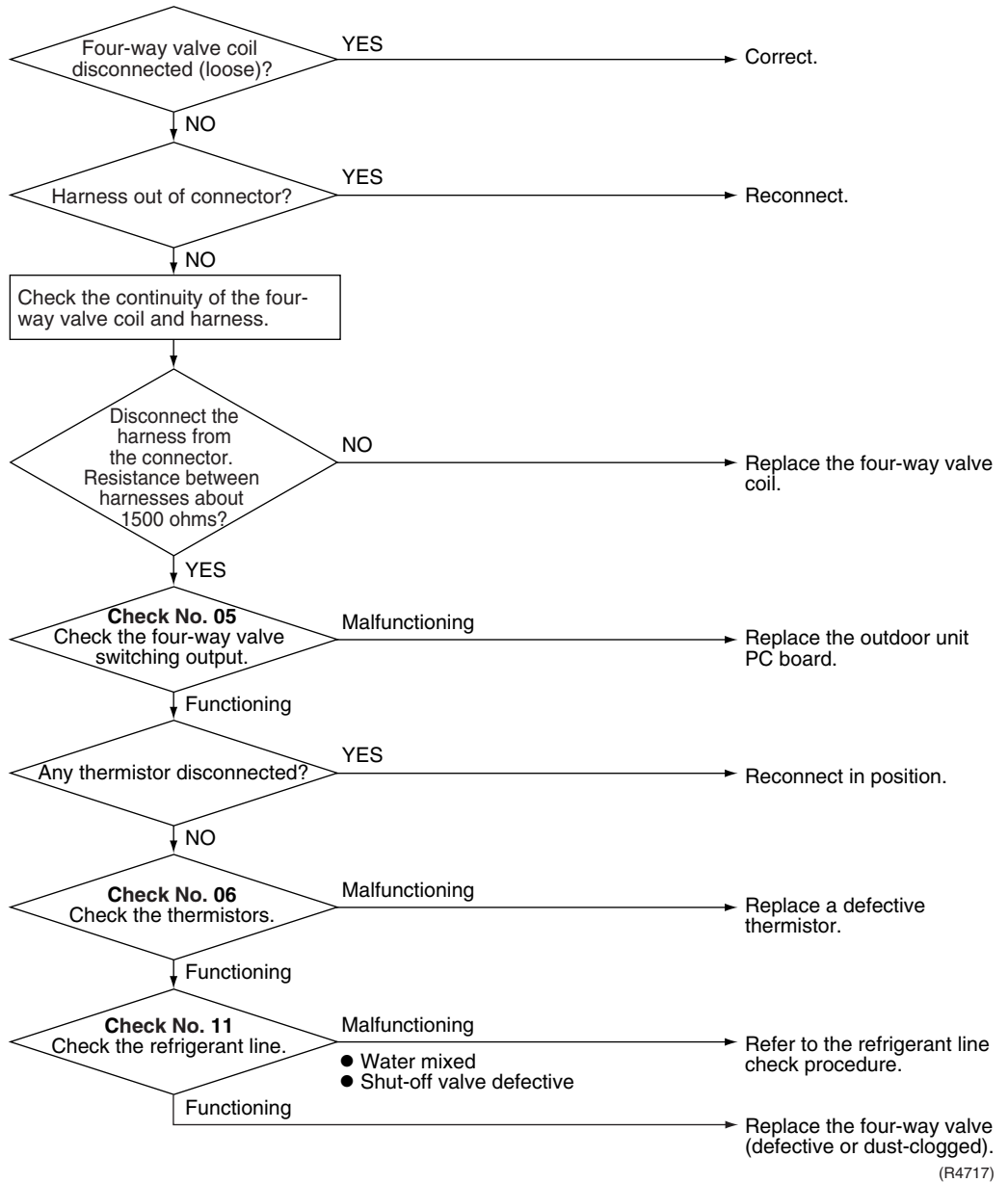

(R4717)

## 5.17 Discharge Pipe Temperature Control

Remote  
Controller  
Display



Outdoor Unit LED  
Display

A ● 1 ○ 2 ● 3 ○ 4 ●

Method of  
Malfunction  
Detection

The discharge pipe temperature control (stop, frequency drooping, etc.) is checked with the temperature being detected by the discharge pipe thermistor.

Malfunction  
Decision  
Conditions

### 2YC45, 2YC63

If the temperature being detected by the discharge pipe thermistor rises above 120°C, the compressor will stop. (The error is cleared when the temperature has dropped below 107°C.)

### 2YC36

If the temperature being detected by the discharge pipe thermistor rises above 110°C, the compressor will stop. (The error is cleared when the temperature has dropped below 95°C.)

### 2YC32

The temperature at which the compressor halts varies according to the frequency.

- (1) 110°C when the frequency is above 45 Hz on ascending or above 40 Hz on descending.
- (2) 102°C when the frequency is between 30 Hz and 45 Hz on ascending or between 40Hz and 25Hz on descending.
- (3) 98°C when the frequency is below 30 Hz on ascending or below 25 Hz on descending.

- If the compressor stops 6 times straight due to abnormal discharge pipe temperature, the system will be shut down.
- The error counter will reset itself if this or any other error does not occur during the following 60-minute compressor running time (total time).

Supposed  
Causes

- Refrigerant shortage
- Four way valve malfunctioning
- Discharge pipe thermistor defective  
(heat exchanger or outdoor temperature thermistor defective)
- Outdoor unit PCB defective
- Water mixed in the local piping
- Electronic expansion valve defective
- Stop valve defective

### Troubleshooting





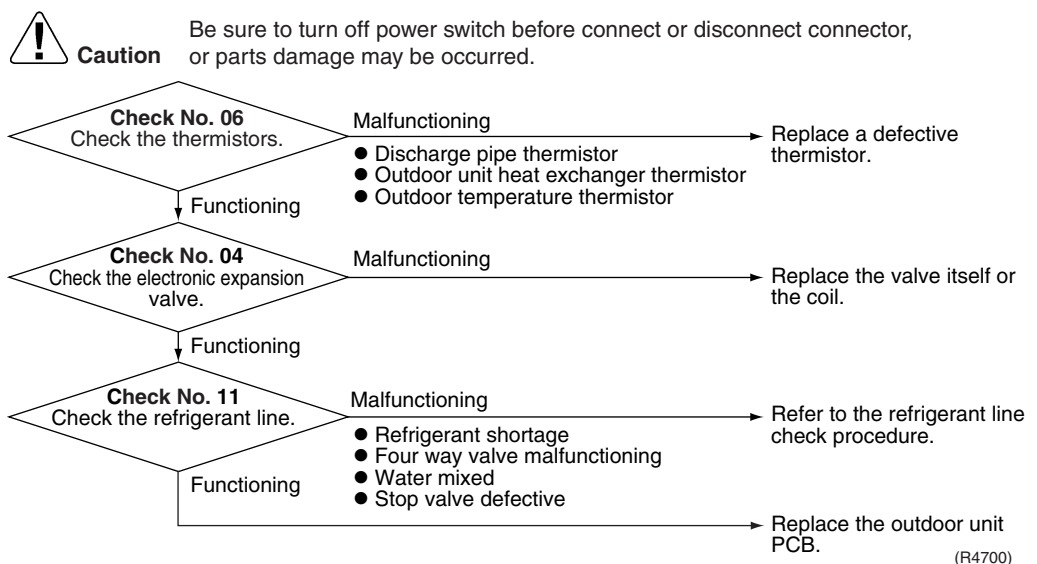

  
**Check No.04**  
Refer to P.261

  
**Check No.06**  
Refer to P.263

  
**Check No.11**  
Refer to P.266



## 5.18 High Pressure Control in Cooling

<p><b>Remote Controller Display</b></p>	
<p><b>Outdoor Unit LED Display</b></p>	<p>A  1  2  3  4 </p>
<p><b>Method of Malfunction Detection</b></p>	<p>High-pressure control (stop, frequency drop, etc.) is activated in the cooling mode if the temperature being sensed by the heat exchanger thermistor exceeds the limit.</p>
<p><b>Malfunction Decision Conditions</b></p>	<ul style="list-style-type: none"> <li>■ Activated when the temperature being sensed by the heat exchanger thermistor rises above 65°C.</li> <li>■ The error is cleared when the temperature drops below 50°C.</li> </ul>
<p><b>Supposed Causes</b></p>	<ul style="list-style-type: none"> <li>■ The installation space is not large enough.</li> <li>■ Faulty outdoor unit fan</li> <li>■ Faulty electronic expansion valve</li> <li>■ Faulty outdoor unit heat exchanger thermistor</li> <li>■ Faulty outdoor unit PCB</li> <li>■ Faulty stop valve</li> <li>■ Dirty heat exchanger</li> </ul>

Troubleshooting

  
**Check No.04**  
 Refer to P.261

  
**Check No.06**  
 Refer to P.263

  
**Check No.07**  
 Refer to P.264

  
**Check No.09**  
 Refer to P.265

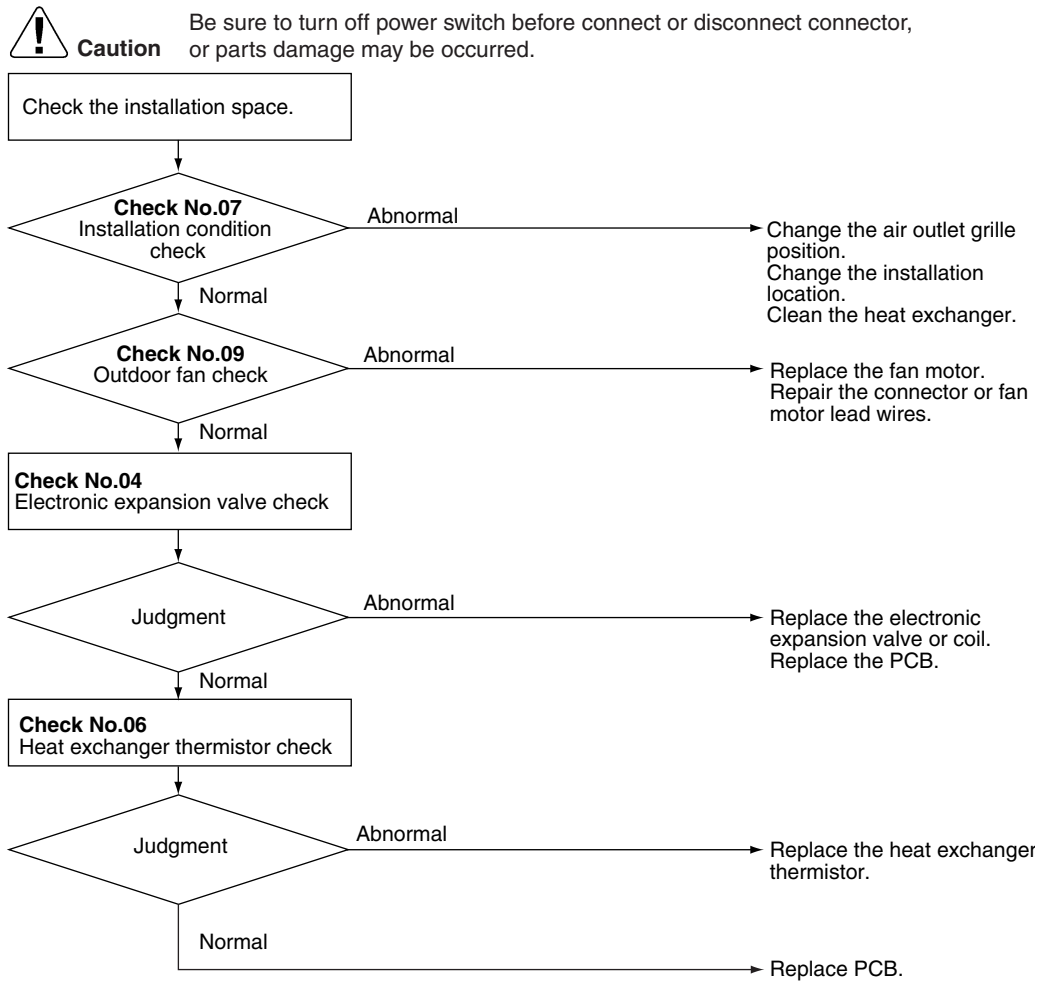

(R4701)







## 5.19 Compressor Sensor System Abnormality

Remote  
Controller  
Display

HO

Outdoor Unit LED  
Display

A  1  2  3  4

Method of  
Malfunction  
Detection

- Fault condition is identified by the supply voltage and the DC voltage which is detected before the compressor startup.
- Fault condition is identified by compressor current which is detected right after the compressor startup.

Malfunction  
Decision  
Conditions

- The detected value of the supply voltage and the DC voltage is obviously low or high.
- The compressor current doesn't run when the compressor is started.

Supposed  
Causes

- Reactor disconnection
- Compressor disconnection
- Outdoor unit PCB defective
- Compressor defective

## Troubleshooting

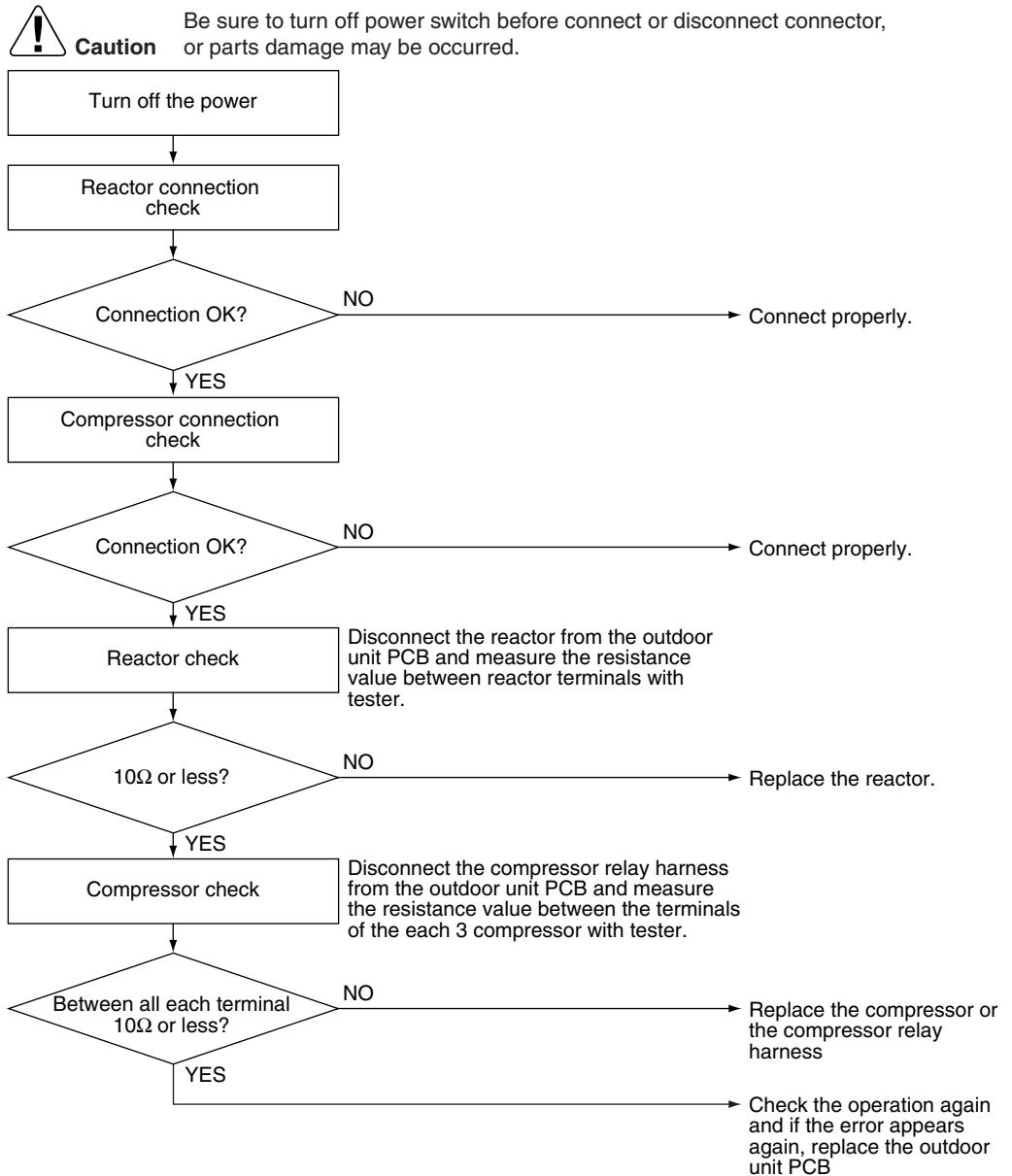

(R5131)

## 5.20 Position Sensor Abnormality

Remote  
Controller  
Display



Outdoor Unit LED  
Display

A 1 2 3 4

Method of  
Malfunction  
Detection

A compressor startup failure is detected by checking the compressor running condition through the position detection circuit.

Malfunction  
Decision  
Conditions

- The compressor fails to start in about 15 seconds after the compressor run command signal is sent.
- Clearing condition: Continuous run for about 5 minutes (normal)
- The system will be shut down if the error occurs 16 times.

Supposed  
Causes

- Compressor relay cable disconnected
- Compressor itself defective
- Outdoor unit PCB defective
- Stop valve closed
- Input voltage out of specification

### Troubleshooting



Check No.13  
Refer to P.267



**Caution**

Be sure to turn off power switch before connect or disconnect connector, or parts damage may be occurred.

Check No. 13  
Check for short-circuit.

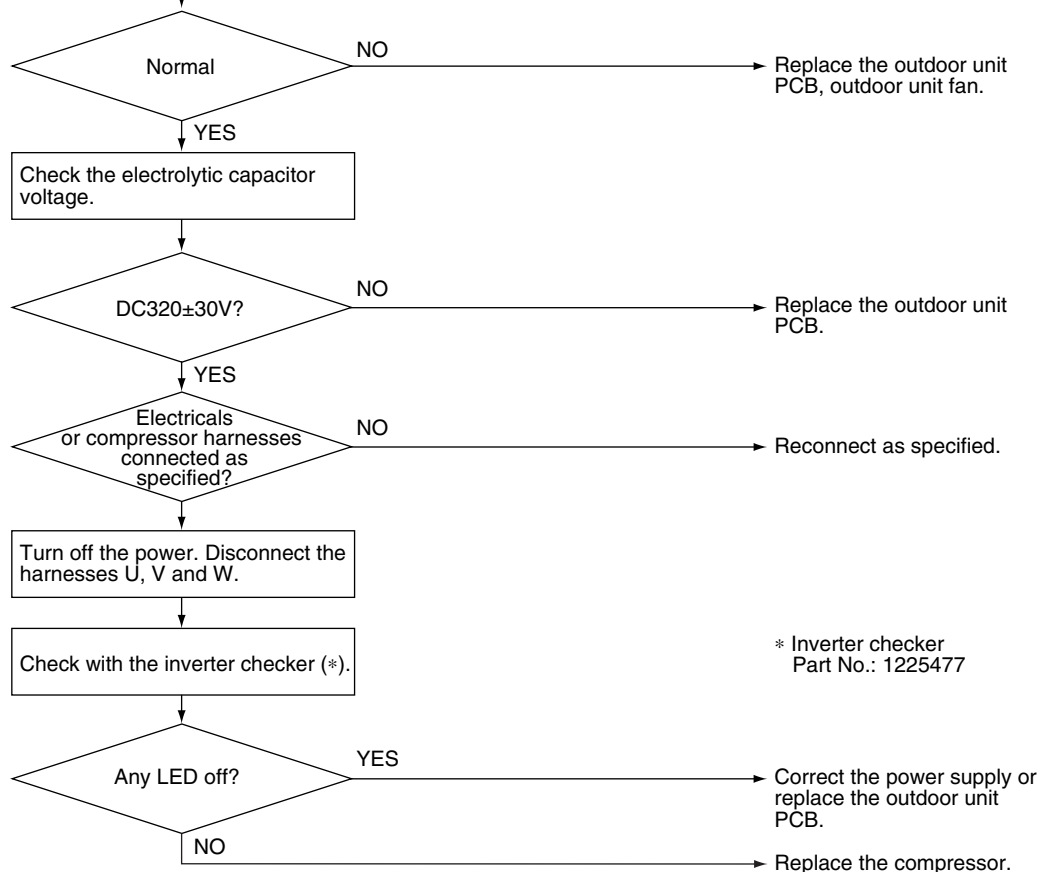

\* Inverter checker  
Part No.: 1225477

(R5145)

## 5.21 CT or Related Abnormality

### Remote Controller Display



### Outdoor Unit LED Display

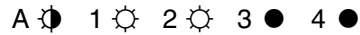

### Method of Malfunction Detection

A CT or related error is detected by checking the compressor running frequency and CT-detected input current.

### Malfunction Decision Conditions

- The compressor running frequency is below  $\Delta$  Hz and the CT input is below 0.1 V. (The input current is also below  $\text{B}$  A.)

	$\Delta$	$\text{B}$
E series 50-58 class	55	0.5
E series 68-75 class	55	1.25
E series 80-100 class	32	1.25
D series	55	1.25

- If this error repeats 4 times, the system will be shut down.
- The error counter will reset itself if this or any other error does not occur during the following 60-minute compressor running time (total time).

### Supposed Causes

- Power transistor defective
- Internal wiring broken or in poor contact
- Reactor defective
- Outdoor unit PCB defective

Troubleshooting



**Check No.12**  
Refer to P.267



**Caution**

Be sure to turn off power switch before connect or disconnect connector, or parts damage may be occurred.

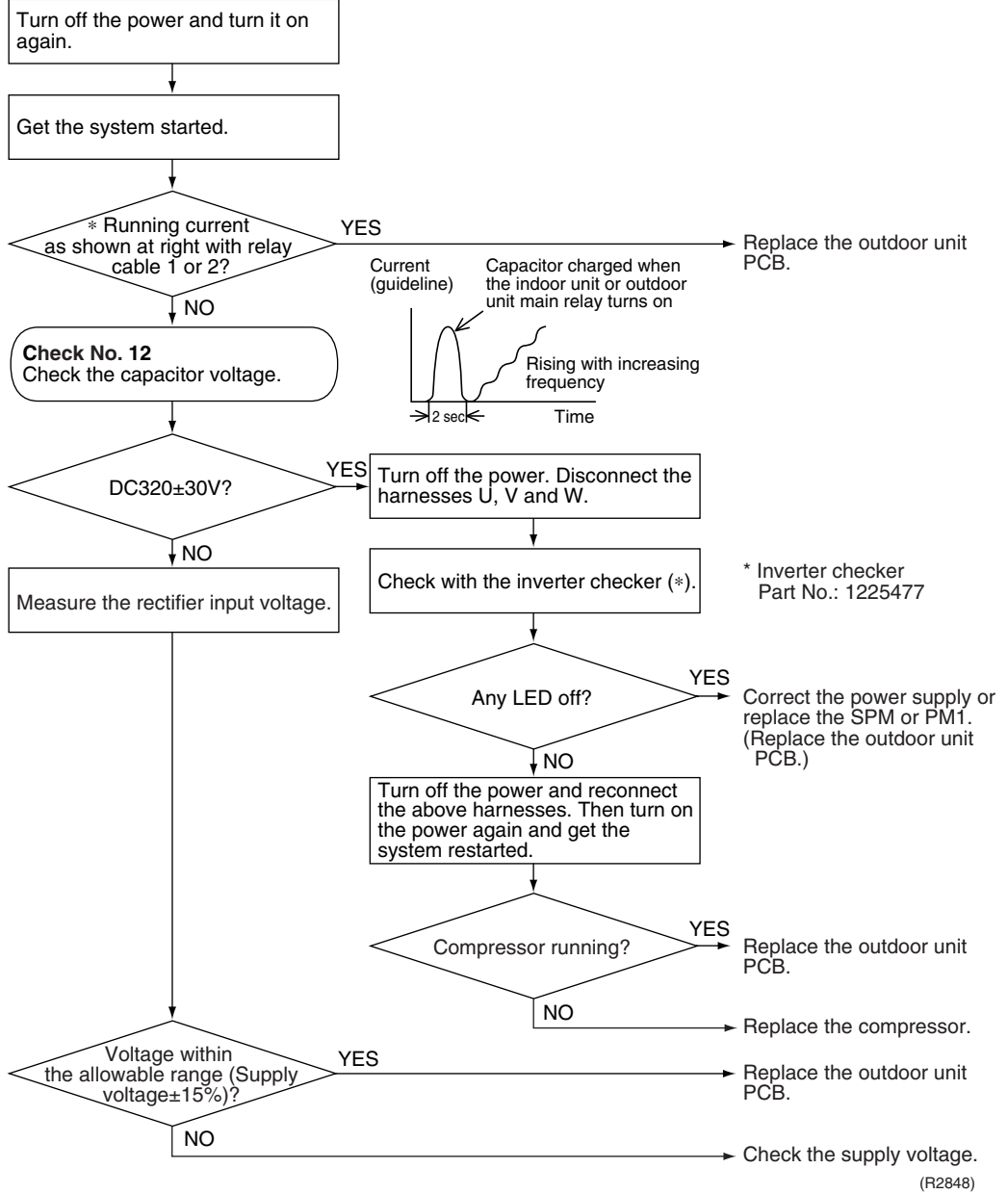





## 5.22 Thermistor or Related Abnormality (Outdoor Unit)

Remote  
Controller  
Display

P4, J3, J6, J8, J9, K9

Outdoor Unit LED  
Display

A  1  2  3  4 

Method of  
Malfunction  
Detection

This type of error is detected by checking the thermistor input voltage to the microcomputer.  
[A thermistor error is detected by checking the temperature being detected by each thermistor.]

Malfunction  
Decision  
Conditions

When the thermistor input is above 4.96 V or below 0.04 V with the power on, the J3 error is judged if the discharge pipe thermistor temperature is smaller than the condenser thermistor temperature, or the system will be shut down if all the units are judged with the J8 error.

Supposed  
Causes

- Connector in poor contact
- Thermistor defective
- Outdoor unit PCB defective
- Indoor unit PCB defective
- Condenser thermistor defective in the case of J3 error (outdoor unit heat exchanger thermistor in the cooling mode, or indoor unit heat exchanger thermistor in the heating mode)

Troubleshooting



**Check No.06**  
Refer to P.263



**Caution**

Be sure to turn off power switch before connect or disconnect connector, or parts damage may be occurred.

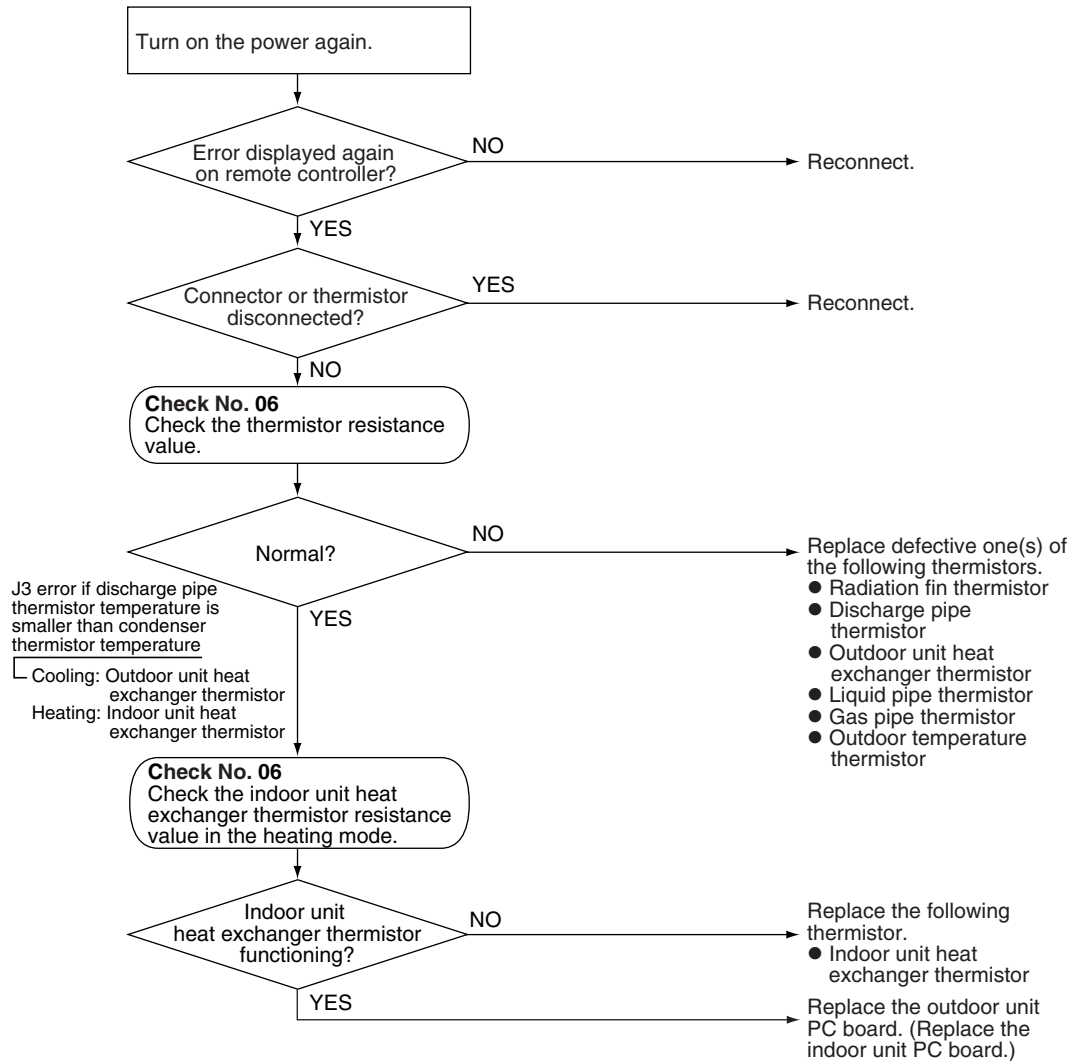

(R4718)

- P4 : Radiation fin thermistor
- J3 : Discharge pipe thermistor
- J5 : Outdoor heat exchanger thermistor
- J8 : Liquid pipe thermistor
- J9 : Gas pipe thermistor
- J13 : Outdoor temperature thermistor

## 5.23 Electrical Box Temperature Rise

### 5.23.1 E Series (68-75 Class), D Series

Remote  
Controller  
Display



Outdoor Unit LED  
Display

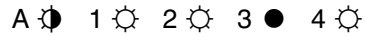

Method of  
Malfunction  
Detection

An electrical box temperature rise is detected by checking the radiation fin thermistor with the compressor off.

Malfunction  
Decision  
Conditions

- With the compressor off, the radiation fin temperature is above 80°C.
- The error is cleared when the temperature drops below 70°C.

Supposed  
Causes

- Fin temperature rise due to defective outdoor unit fan
- Fin temperature rise due to short-circuit
- Fin thermistor defective
- Connector in poor contact
- Outdoor unit PCB defective



Troubleshooting

 **Check No.06**  
Refer to P.263

 **Check No.07**  
Refer to P.264

 **Check No.09**  
Refer to P.265

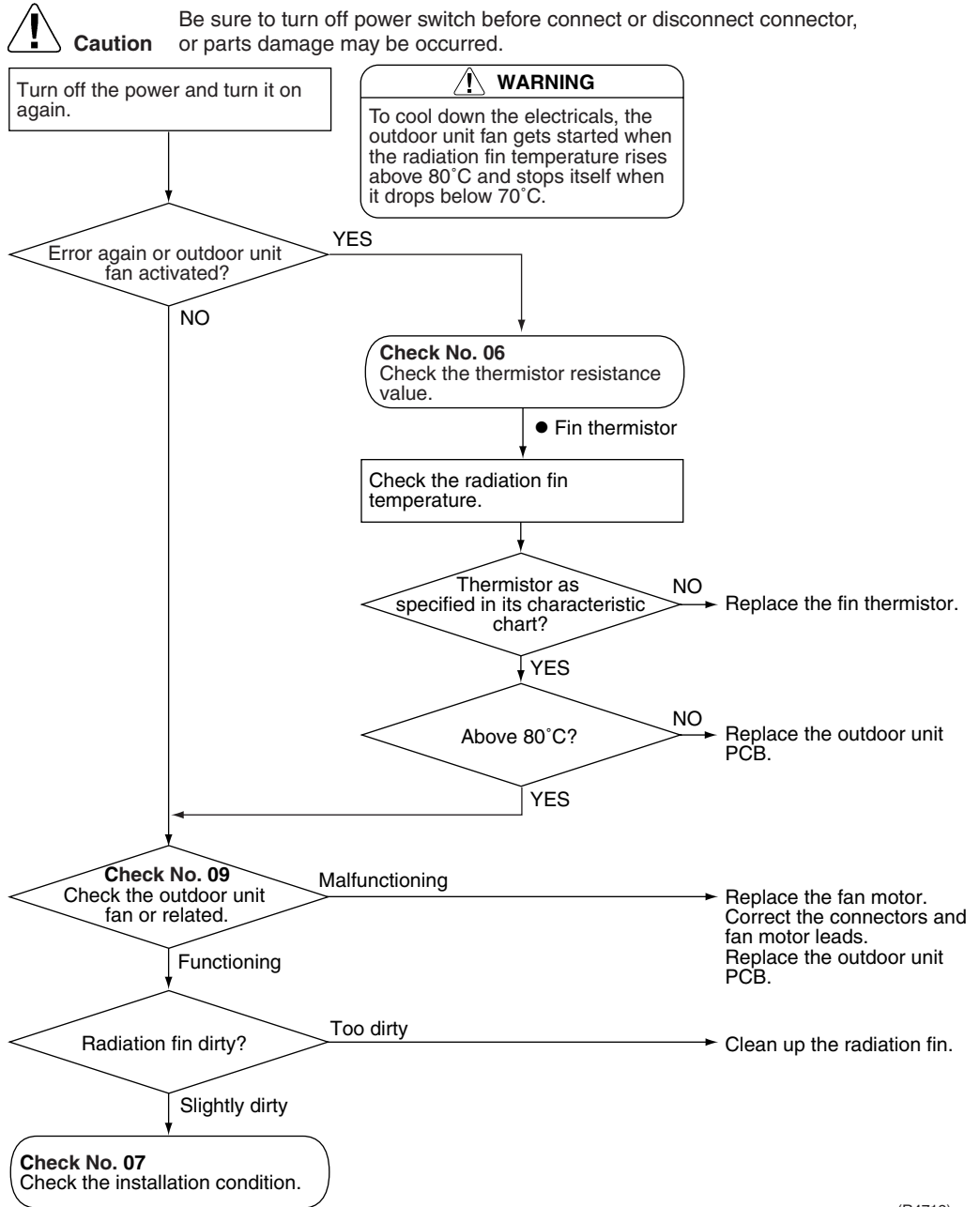

(R4712)

## 5.23.2 E Series (50-58 Class, 80-100 Class)

### Remote Controller Display



### Outdoor Unit LED Display



### Method of Malfunction Detection

An electrical box temperature rise is detected by checking the radiation fin thermistor with the compressor off.

### Malfunction Decision Conditions

- With the compressor off, the radiation fin temperature is above 100°C.
- The error is cleared when the temperature drops below 85°C (52-58 class) or 70°C (80-100 class).

### Supposed Causes

- Fin temperature rise due to defective outdoor unit fan
- Fin temperature rise due to short-circuit
- Fin thermistor defective
- Connector in poor contact
- Outdoor unit PCB defective

Troubleshooting

  
**Check No.07**  
 Refer to P.264

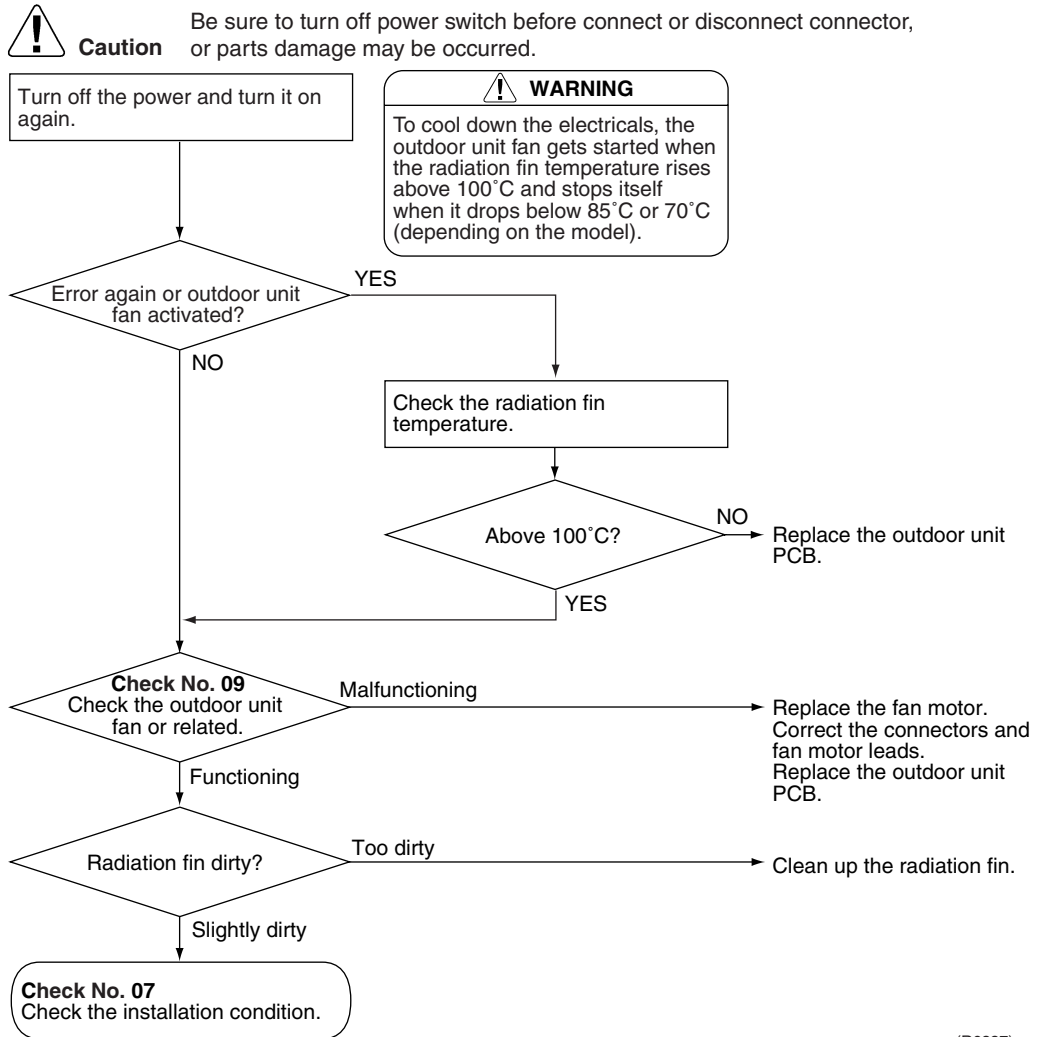

  
**Check No.09**  
 Refer to P.265



(R6337)

## 5.24 Radiation Fin Temperature Rise

### 5.24.1 E Series (68-75 Class), D Series

<b>Remote Controller Display</b>	L4
<b>Outdoor Unit LED Display</b>	A  1 ● 2 ● 3 ● 4 
<b>Method of Malfunction Detection</b>	A radiation fin temperature rise is detected by checking the radiation fin temperature being detected by the fin thermistor with the compressor on.
<b>Malfunction Decision Conditions</b>	<ul style="list-style-type: none"> <li>■ The radiation fin temperature with the compressor on is above 90°C.</li> <li>■ The error is cleared when the temperature drops below 85°C.</li> <li>■ If a radiation fin temperature rise takes place 255 times successively, the system will be shut down.</li> <li>■ The error counter will reset itself if this or any other error does not occur during the following 60-minute compressor running time (total time).</li> </ul>
<b>Supposed Causes</b>	<ul style="list-style-type: none"> <li>■ Fin temperature rise due to defective outdoor unit fan</li> <li>■ Fin temperature rise due to short-circuit</li> <li>■ Fin thermistor defective</li> <li>■ Connector in poor contact</li> <li>■ Outdoor unit PCB defective</li> <li>■ Silicon grease is not applied properly on the heat radiation fin after replacing outdoor unit PCB</li> </ul>

Troubleshooting

 **Check No.06**  
Refer to P.263

 **Check No.07**  
Refer to P.264

 **Check No.09**  
Refer to P.265

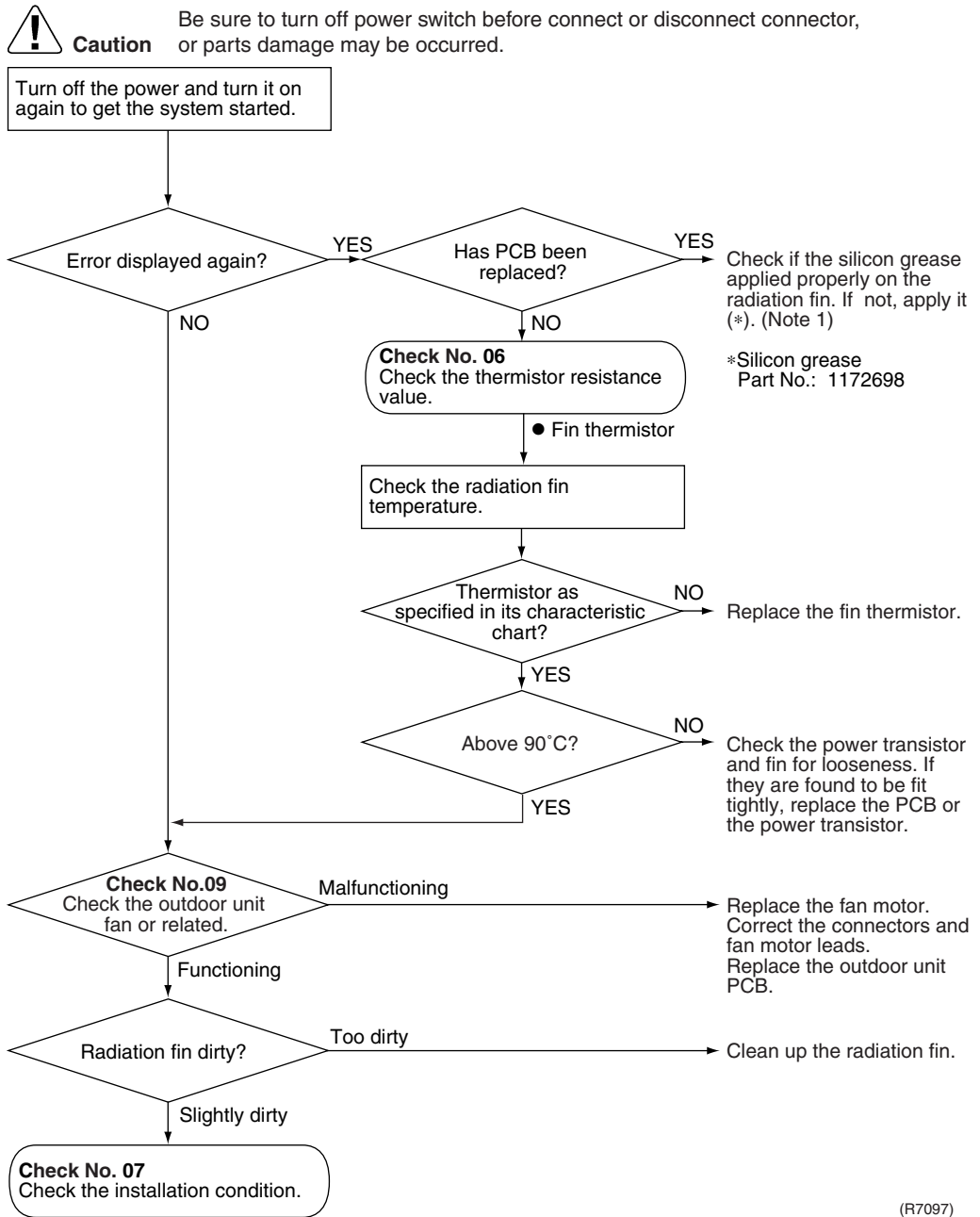

(R7097)

 **Note1:** Refer to “1.3 Application of Silicon grease to a power transistor and a diode bridge” on P358.

## 5.24.2 E Series (50-58 Class, 80-100 Class)

### Remote Controller Display

### Outdoor Unit LED Display

### Method of Malfunction Detection

A radiation fin temperature rise is detected by checking the radiation fin temperature being detected by the fin thermistor with the compressor on.

### Malfunction Decision Conditions

- The radiation fin temperature with the compressor on is above 103°C (52-58 class) or 105°C (80-100 class).
- The error is cleared when the temperature drops below 95°C (52-58 class) or 97 °C (80-100 class).
- If a radiation fin temperature rise takes place 255 times successively, the system will be shut down.
- The error counter will reset itself if this or any other error does not occur during the following 60-minute compressor running time (total time).

### Supposed Causes

- Fin temperature rise due to defective outdoor unit fan
- Fin temperature rise due to short-circuit
- Fin thermistor defective
- Connector in poor contact
- Outdoor unit PCB defective
- Silicon grease is not applied properly on the heat radiation fin after replacing outdoor unit PCB

Troubleshooting



**Check No.07**  
Refer to P.264



**Check No.09**  
Refer to P.265



**Caution**

Be sure to turn off power switch before connect or disconnect connector, or parts damage may be occurred.

Turn off the power and turn it on again to get the system started.

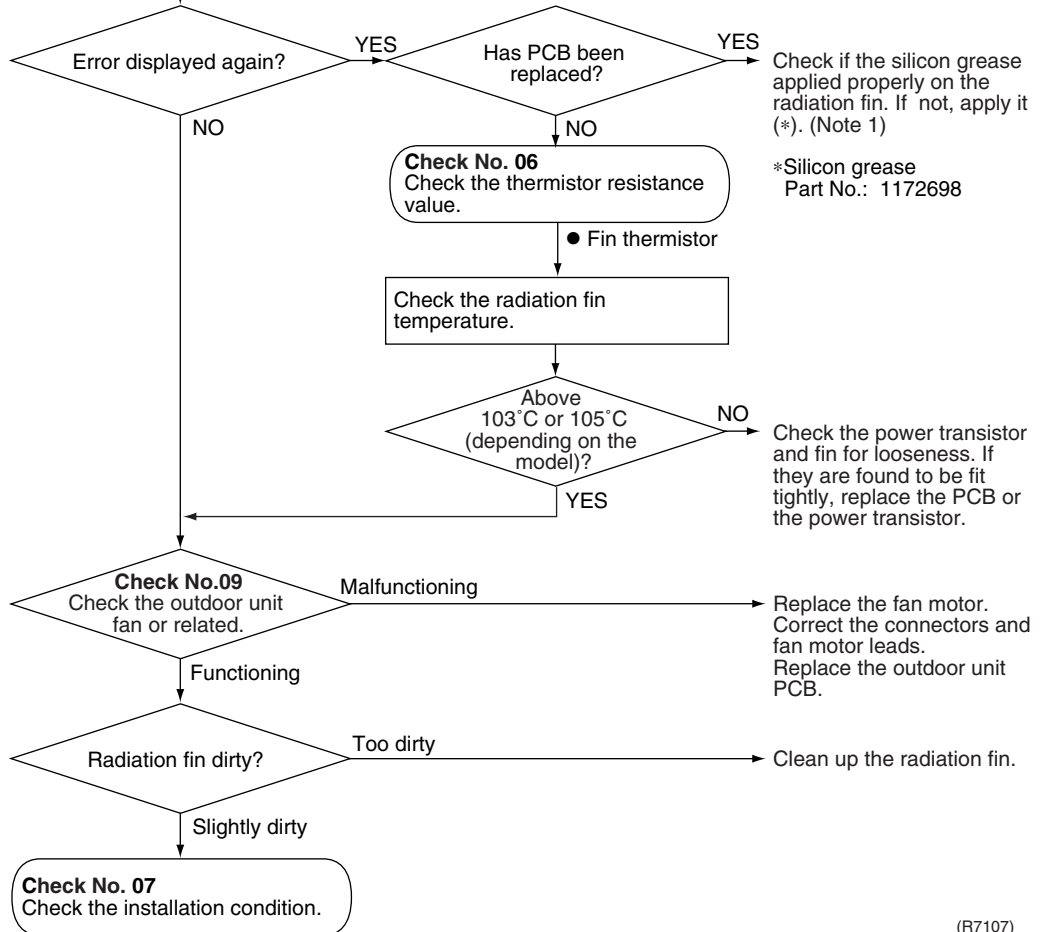

(R7107)







**Note1:** Refer to “1.3 Application of Silicon grease to a power transistor and a diode bridge” on P358.

## 5.25 Output Over Current Detection

Remote  
Controller  
Display

LS

Outdoor Unit LED  
Display

A  1  2  3  4 

Method of  
Malfunction  
Detection

An output over-current is detected by checking the current that flows in the inverter DC section.

Malfunction  
Decision  
Conditions

- A position signal error occurs while the compressor is running.
- A speed error occurs while the compressor is running.
- An output over-current input is fed from the output over-current detection circuit to the microcomputer.
- The system will be shut down if the error occurs 16 times.
- Clearing condition: Continuous run for about 5 minutes (normal)

Supposed  
Causes

- Over-current due to defective power transistor
- Over-current due to wrong internal wiring
- Over-current due to abnormal supply voltage
- Over-current due to defective PCB
- Error detection due to defective PCB
- Over-current due to closed stop valve
- Over-current due to compressor failure
- Over-current due to poor installation condition



Troubleshooting

 **Check No.07**  
Refer to P.264

 **Check No.08**  
Refer to P.265

 **Check No.13**  
Refer to P.267



**Caution** Be sure to turn off power switch before connect or disconnect connector, or parts damage may be occurred.

\* An output over-current may result from wrong internal wiring. If the wires have been disconnected and reconnected for part replacement, for example, and the system is interrupted by an output over-current, take the following procedure.

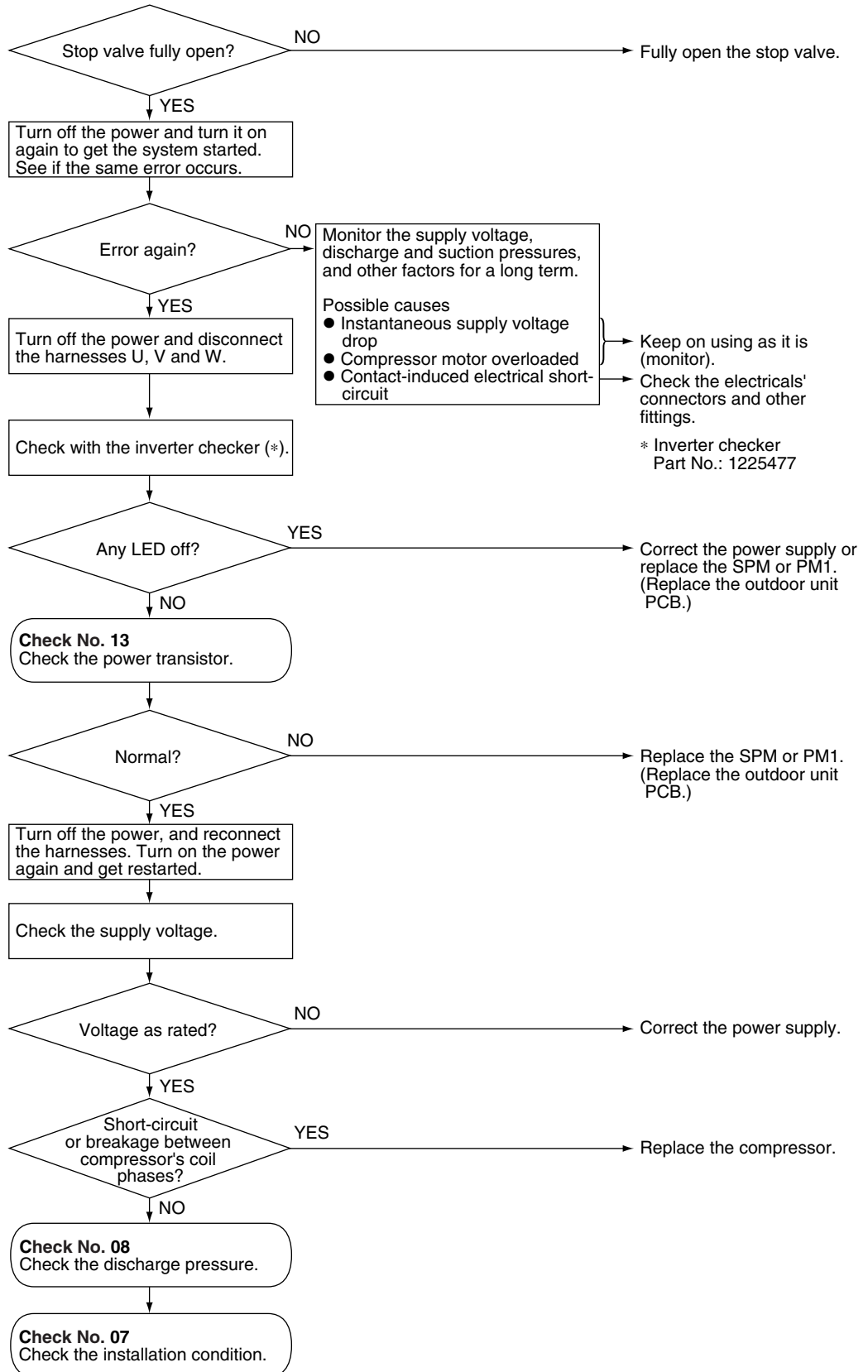

\* Inverter checker  
Part No.: 1225477



(R4705)



**Note:** If the model does not have SPM or PM1, replace the outdoor unit PCB.

## 5.26 Insufficient Gas

### 5.26.1 E Series (68-75 Class), D Series

Remote Controller Display	
Outdoor Unit LED Display	
Method of Malfunction Detection	<p><b>Gas shortage detection I:</b> Gas shortage is detected by checking the input current value and the compressor running frequency. If the gas is short, the input current is smaller than the normal value.</p> <p><b>Gas shortage detection II:</b> Gas shortage is detected by checking the discharge temperature and the opening of the electronic expansion valve. If the gas is short, the discharge temperature tends to rise.</p>
Malfunction Decision Conditions	<p><b>Gas shortage detection I (typical value):</b> The following conditions continue for 7 minutes.</p> <ul style="list-style-type: none"> <li>◆ Input current × input voltage ≤ 1756 / 256 × output frequency +50 (W)</li> <li>◆ Output frequency &gt; 55 (Hz)</li> </ul> <p><b>Gas shortage detection II:</b> The following conditions continue for 80 seconds.</p> <ul style="list-style-type: none"> <li>◆ Target opening of the electronic expansion valve ≥ 450 (pulse)</li> <li>◆ Cooling: discharge temperature &gt; 255 / 256 × target discharge temperature +20 (°C) Heating: discharge temperature &gt; 255 / 256 × target discharge temperature +40 (°C)</li> </ul> <p>If a gas shortage error takes place 4 times straight, the system will be shut down. The error counter will reset itself if this or any other error does not occur during the following 60-minute compressor running time (total time).</p>
Supposed Causes	<ul style="list-style-type: none"> <li>■ Refrigerant shortage (refrigerant leakage)</li> <li>■ Poor compression performance of compressor</li> <li>■ Discharge pipe thermistor disconnected, or indoor unit or outdoor unit heat exchanger thermistor disconnected, room or outside air temperature thermistor disconnected</li> <li>■ Stop valve closed</li> <li>■ Electronic expansion valve defective</li> </ul>

Troubleshooting



**Check No.04**  
Refer to P.261



**Check No.06**  
Refer to P.263



**Caution**

Be sure to turn off power switch before connect or disconnect connector, or parts damage may be occurred.

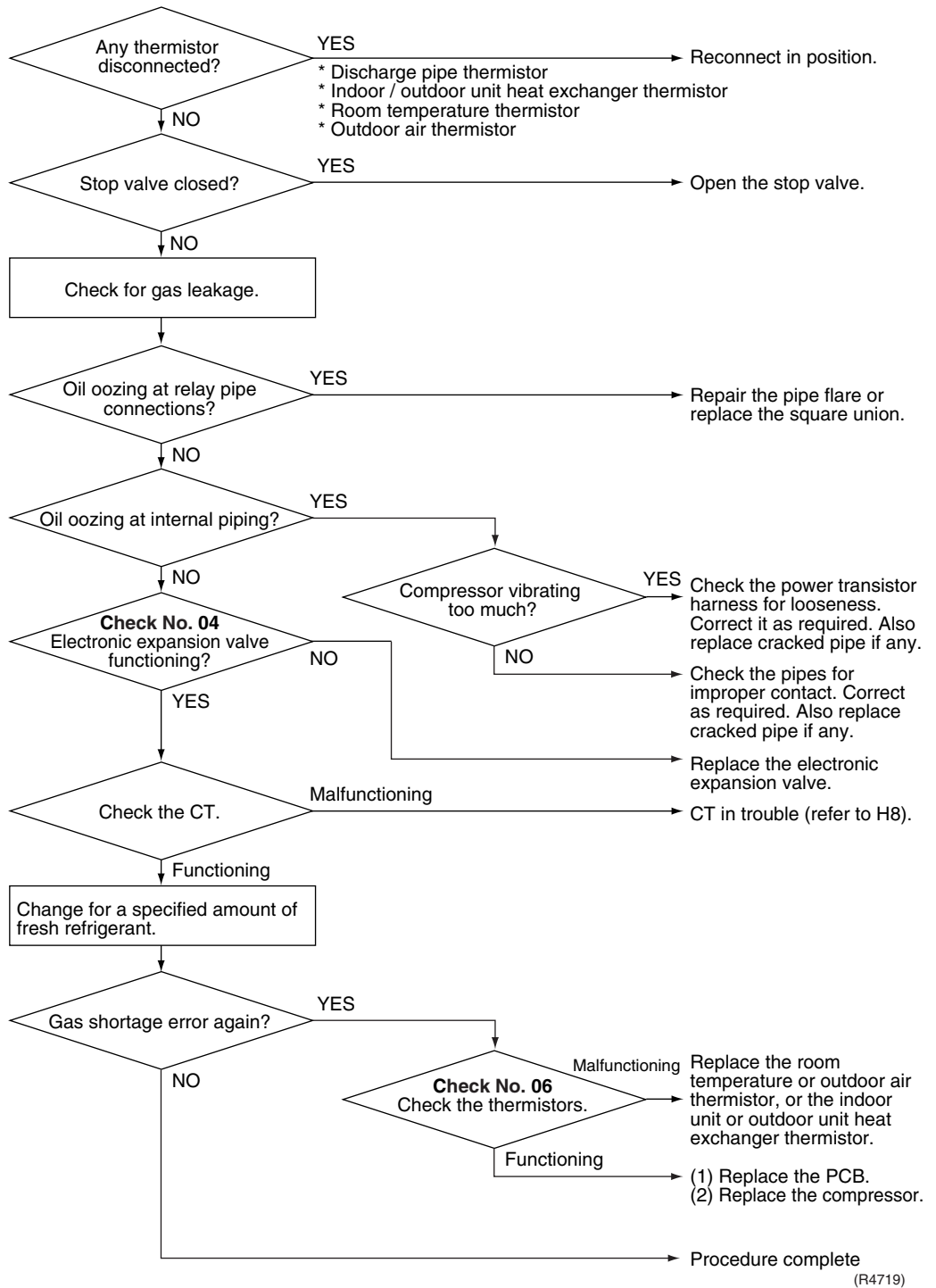

(R4719)

## 5.26.2 E Series (50-58 Class, 80-100 Class)

### Remote Controller Display



### Outdoor Unit LED Display

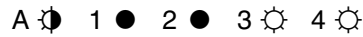

### Method of Malfunction Detection

#### Gas shortage detection I:

Gas shortage is detected by checking the input current value and the compressor running frequency. If the gas is short, the input current is smaller than the normal value.

#### Gas shortage detection II:

Gas shortage is detected by checking the discharge temperature and the opening of the electronic expansion valve. If the gas is short, the discharge temperature tends to rise.

### Malfunction Decision Conditions

#### Gas shortage detection I (typical value):

The following conditions continue for 7 minutes.

- ◆ DC current  $\leq 0.01 \times$  output frequency + 0.3
- ◆ Output frequency > 55 (Hz)

#### Gas shortage detection II:

The following conditions continue for 80 seconds.

- ◆ Target opening of the electronic expansion valve  $\geq 450$  (pulse)
- ◆ Cooling: discharge temperature >  $255 / 256 \times$  target discharge temperature +20 (°C)  
Heating: discharge temperature >  $255 / 256 \times$  target discharge temperature +40 (°C)

If a gas shortage error takes place 4 times straight, the system will be shut down. The error counter will reset itself if this or any other error does not occur during the following 60-minute compressor running time (total time).

### Supposed Causes

- Refrigerant shortage (refrigerant leakage)
- Poor compression performance of compressor
- Discharge pipe thermistor disconnected, or indoor unit or outdoor unit heat exchanger thermistor disconnected, room or outside air temperature thermistor disconnected
- Stop valve closed
- Electronic expansion valve defective

Troubleshooting



**Check No.04**  
Refer to P.261



**Check No.06**  
Refer to P.263



**Caution**

Be sure to turn off power switch before connect or disconnect connector, or parts damage may be occurred.

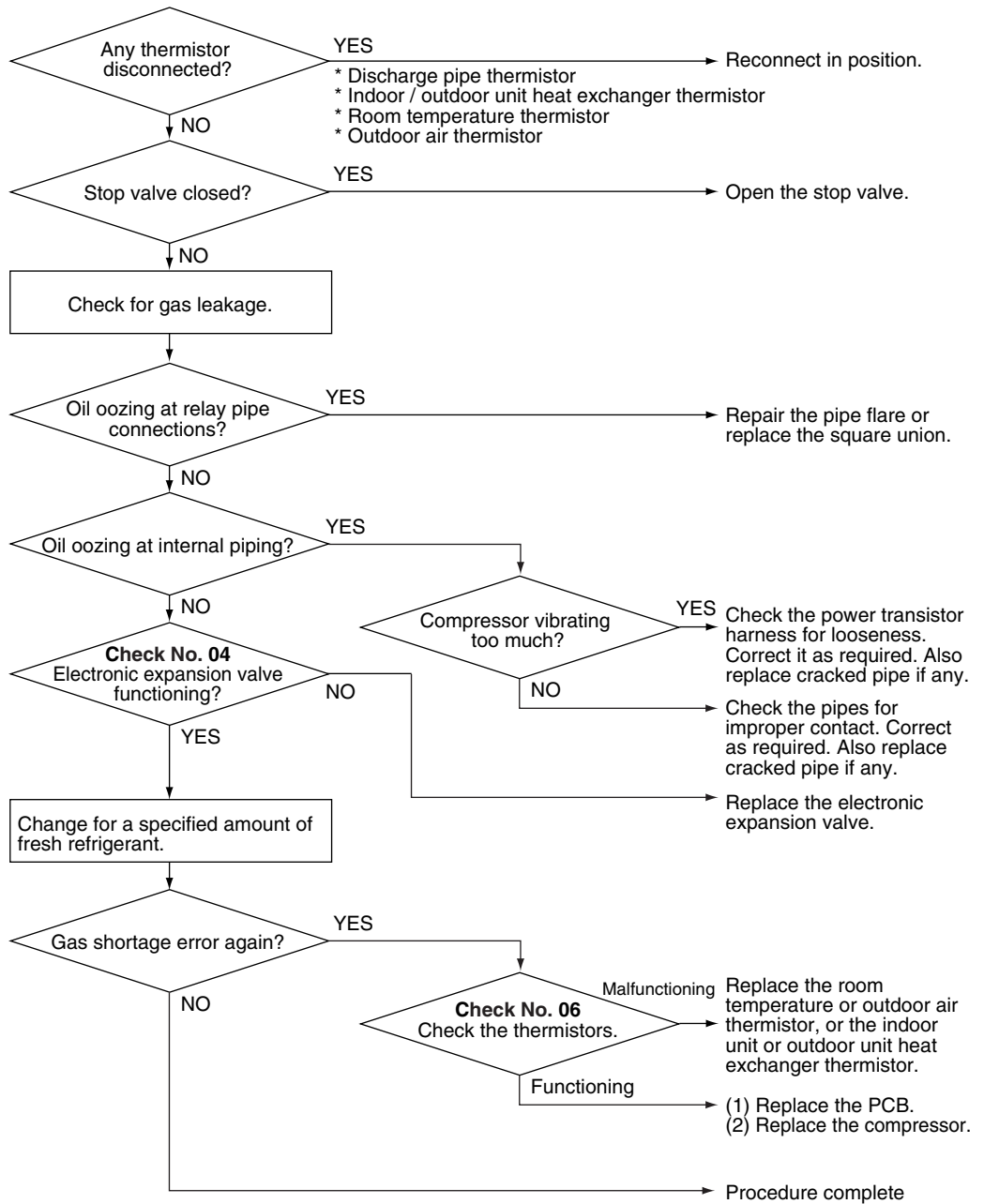

(R5150)

## 5.27 Low-voltage Detection or Over-voltage Detection

Remote  
Controller  
Display

U2

Outdoor Unit LED  
Display

A  1  2  3  4 

Method of  
Malfunction  
Detection

An abnormal voltage rise or drop is detected by checking the detection circuit or DC voltage detection circuit.

Malfunction  
Decision  
Conditions

- An over-voltage signal is fed from the over-voltage detection circuit to the microcomputer, or the voltage being detected by the DC voltage detection circuit is judged to be below 150 V for 0.1 second.
- The system will be shut down if the error occurs 16 times.
- Clearing condition: Continuous run for about 60 minutes (normal)

Supposed  
Causes

- Supply voltage not as specified
- Over-voltage detector or DC voltage detection circuit defective
- PAM control part(s) defective

Troubleshooting

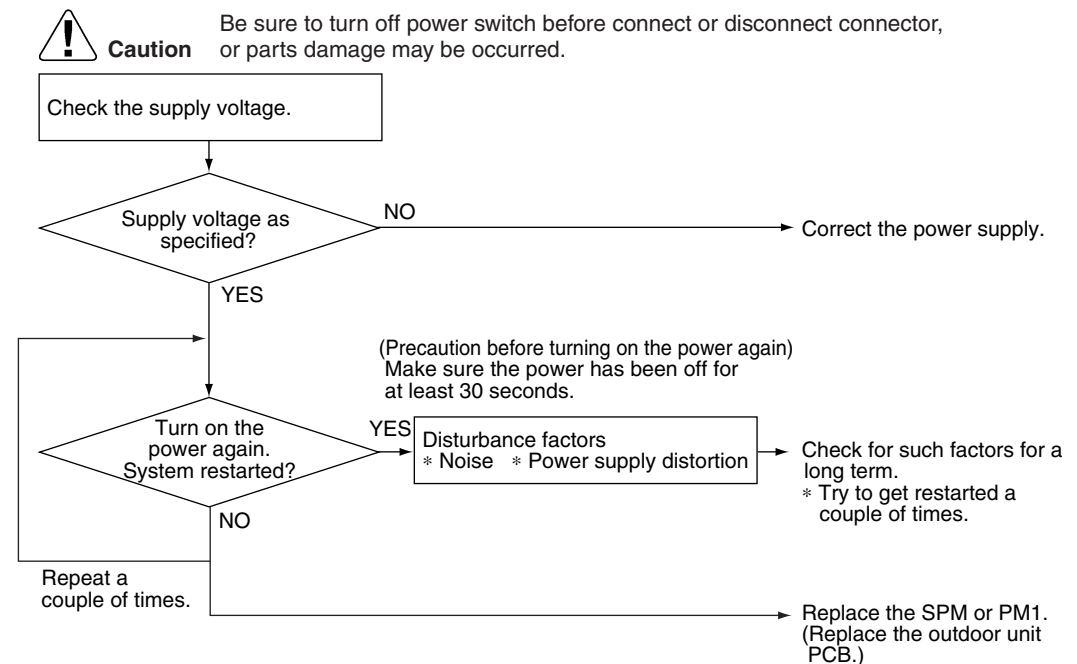

(R2854)

## 5.28 Signal Transmission Error (on Outdoor Unit PCB)

<b>Remote Controller Display</b>	U7
<b>Outdoor Unit LED Display</b>	A 1 ● 2 ☉ 3 ☉ 4 ☉
<b>Method of Malfunction Detection</b>	Communication error between microcomputer mounted on the main PCB and PM1.
<b>Malfunction Decision Conditions</b>	<ul style="list-style-type: none"> <li>■ When the data sent from the PM1 can not be received successively for 9 sec.</li> <li>■ The abnormality is determined if the above fault conditions occurs once</li> <li>■ Fault counter is reset when the data from the PM1 can be successfully received.</li> </ul>
<b>Supposed Causes</b>	<ul style="list-style-type: none"> <li>■ Defective outdoor unit PCB</li> </ul>

### Troubleshooting

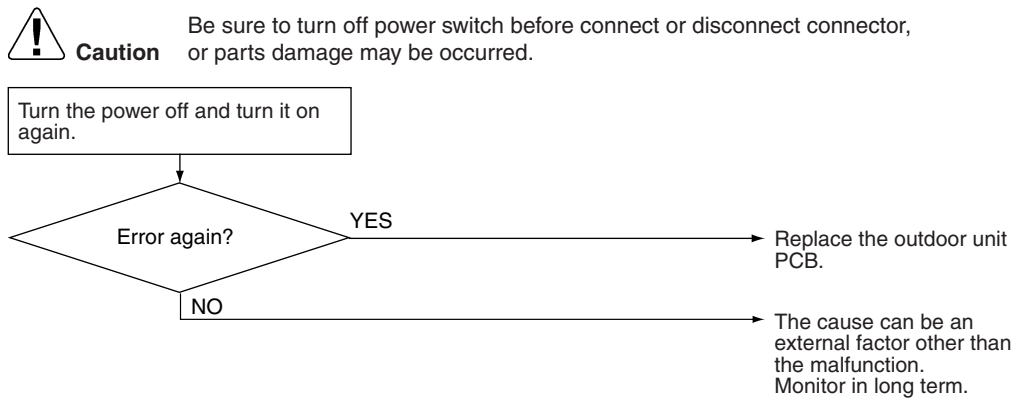

(R5152)

## 5.29 Anti-icing Function in Other Rooms / Unspecified Voltage (between Indoor and Outdoor Units)

Remote  
Controller  
Display

UR, UH

Outdoor Unit LED  
Display

A  1 ● 2 ● 3 ● 4 ●

Method of  
Malfunction  
Detection

A wrong connection is detected by checking the combination of indoor and outdoor units on the microcomputer.

Malfunction  
Decision  
Conditions

- Operation halt due to the anti-icing function in other rooms
- Operation halt due to unspecified internal and/or external voltages
- Operation halt due to mismatching of indoor and outdoor units

Supposed  
Causes

- Operation halt due to the anti-icing function in other rooms
- Wrong connections at the indoor unit
- PCB wrongly connected

### Troubleshooting



**Caution**

Be sure to turn off power switch before connect or disconnect connector, or parts damage may be occurred.

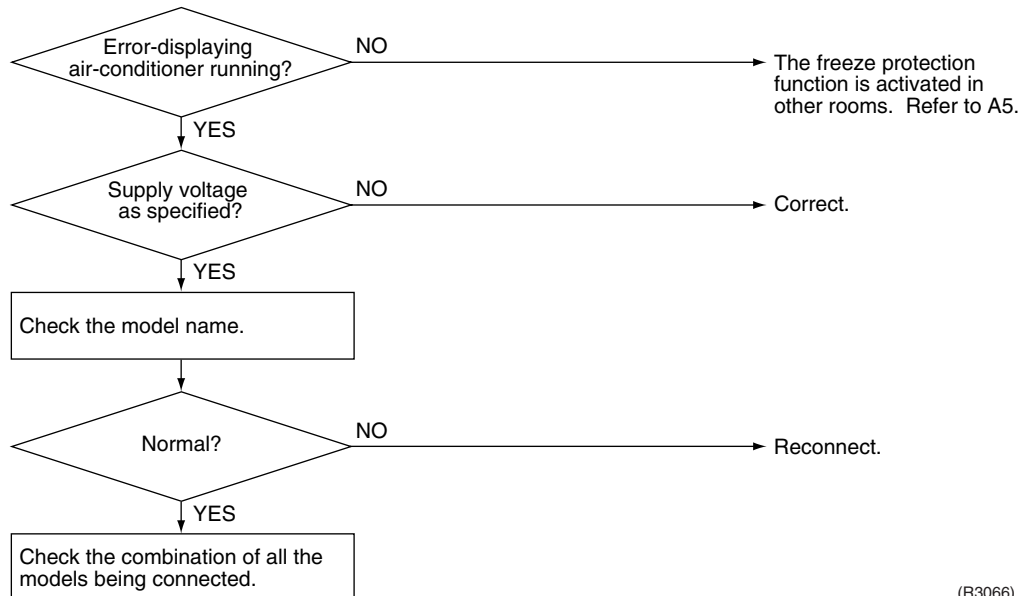

(R3066)



# 6. Check

## 6.1 How to Check

### 6.1.1 Fan Motor Connector Output Check

**Check No.01**

1. Check connector connection.
2. Check motor power supply voltage output (pins 4-7 and 4-8).
3. Check motor control voltage (pins 4-3).
4. Check rotation command voltage output (pins 4-2).
5. Check rotation pulse input (pins 4-1).

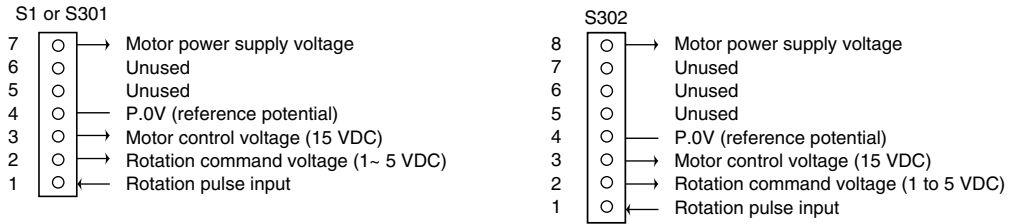

(R4684)

**Check No.02**

1. Check connector connection.
2. Check motor control voltage output (pins 2-1).

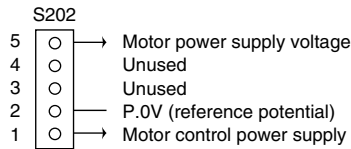

(R1073)

### 6.1.2 Limit Switch Continuity Check

**Check No.03**

Remove the front grille. The limit switch is located at the left side of the drain pan assembly. Check the continuity of the switch connection.

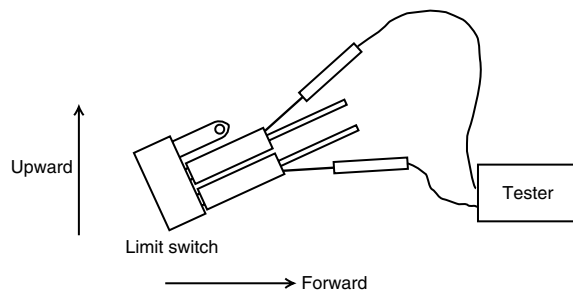

Shutter status	Open	Closed
Continuity	Continuity	No continuity

(Q0363)

- \* The shutter can be opened and closed with hand. Keep the shutter open and closed all the way for each continuity check steps.

## 6.1.3 Electronic Expansion Valve Check

### Check No.04

Conduct the followings to check the electronic expansion valve (EV).

1. Check to see if the EV connector is correctly inserted in the PCB. Compare the EV unit and the connector number.
2. Turn the power off and back on again, and check to see if all the EVs generate latching sound.
3. If any of the EVs does not generate latching noise in the above step 2, disconnect that connector and check the conductivity using a tester.  
Check the conductivity between pins 1, 3 and 6, and between pins 2, 4 and 5. If there is no conductivity between the pins, the EV coil is faulty.
4. If no EV generates latching sound in the above step 2, the outdoor unit PCB is faulty.
5. If the conductivity is confirmed in the above step 2, mount a good coil (which generated latching sound) in the EV unit that did not generate latching sound, and check to see if that EV generates latching sound.  
\*If latching sound is generated, the outdoor unit PCB is faulty.  
\*If latching sound is not generated, the EV unit is faulty.



**Note:** Please note that the latching sound varies depending on the valve type.

Valve Body Condition (Symptom)	Check Method / Measure
<p>(1) Valve body catches at fully opened or half opened position. (Symptom) Cooling:  <ul style="list-style-type: none"> <li>■Water leakage at the no-operation unit</li> <li>■Flow noise of refrigerant in the no-operation unit</li> <li>■Operation halt due to icing protection</li> </ul>           Heating:  <ul style="list-style-type: none"> <li>■The unit does not heat</li> <li>■Refrigerant flow rate vary by unit (Discharge air temperatures are different by room)</li> <li>■Peak cut</li> </ul> </p>	<p>Reset power supply and conduct cooling operation unit by unit.</p> <div style="border: 1px solid black; padding: 5px; margin-bottom: 5px;">Check the liquid pipe temperature of no-operation unit.</div> <div style="text-align: center;"> <p>Is it almost same as the outside air temperature?</p> <p>NO →</p> <p>YES ↓</p> </div> <p>Replace the EVn of the room. (R1431)</p>
<p>(2) Valve body catches at complete close position. (Symptom) Cooling:  <ul style="list-style-type: none"> <li>■The only unit having problem does not cool the room .</li> <li>■When the only faulty unit is in operation, the unit makes pump down. (The low pressure of the unit becomes vacuum)</li> <li>■IT is activated.</li> <li>■Abnormal discharge pipe temperature</li> </ul>           Heating:            Insufficient gas due to liquid refrigerant stagnation inside the faulty indoor unit             (Only for heat pump model)  <ul style="list-style-type: none"> <li>■The unit does not heat the room.</li> <li>■IT is activated.</li> <li>■Abnormal discharge pipe temperature</li> </ul> </p>	<p>Reset power supply and conduct cooling operation unit by unit.</p> <div style="border: 1px solid black; padding: 5px; margin-bottom: 5px;">Check the low pressure</div> <div style="text-align: center;"> <p>Does the pressure become into vacuum zone?</p> <p>NO →</p> <p>YES ↓</p> </div> <p>Replace the EVn of the room (R1432)</p>
<p>(3) Valve does not open fully. (Symptom)  <ul style="list-style-type: none"> <li>■The unit does not cool nor heat (only for heat pump model.)</li> <li>■IT is actuated.</li> <li>■Abnormal discharge pipe temperature</li> </ul> </p>	<p>Check the number of rotation of shaft if it is 5 and half from full open to complete close using manual coil for electronic expansion valve. When the number of rotation of shaft is less than the above value, the valve may catch anywhere of the body.</p>

### 6.1.4 Four Way Valve Performance Check

Check No.05

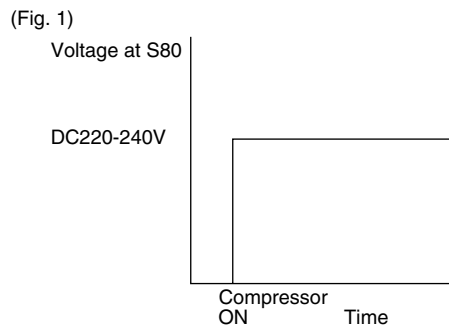
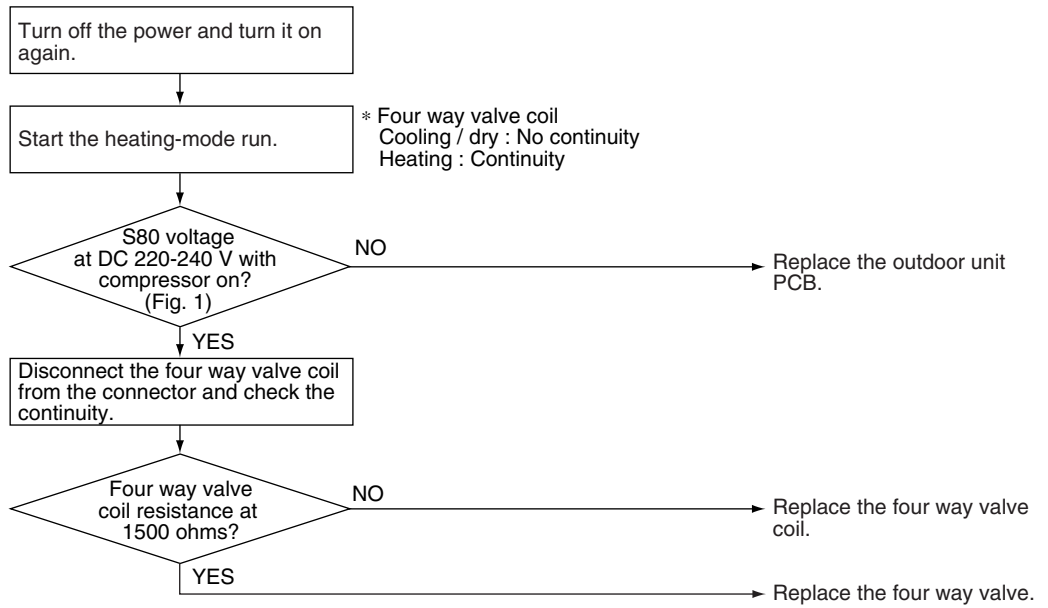

(R2856)

### 6.1.5 Thermistor Resistance Check

**Check No.06**

Remove the connectors of the thermistors on the PCB, and measure the resistance of each thermistor using tester.

The relationship between normal temperature and resistance is shown in the graph and the table below.

Temperature (°C)	Thermistor R25°C=20kΩ B=3950
-20	211.0 (kΩ)
-15	150
-10	116.5
-5	88
0	67.2
5	51.9
10	40
15	31.8
20	25
25	20
30	16
35	13
40	10.6
45	8.7
50	7.2

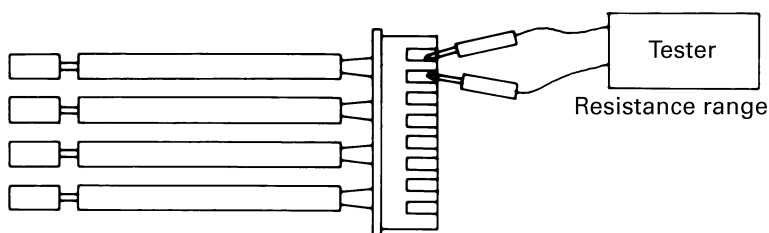

( R25 = 20k Ω 、 B = 3950 )

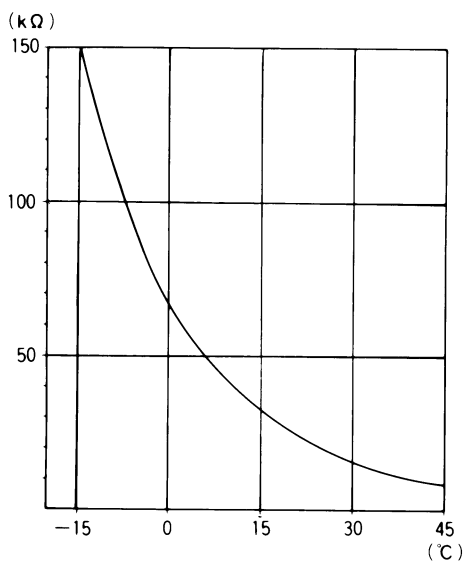

(R1437)

## 6.1.6 Installation Condition Check

### Check No.07

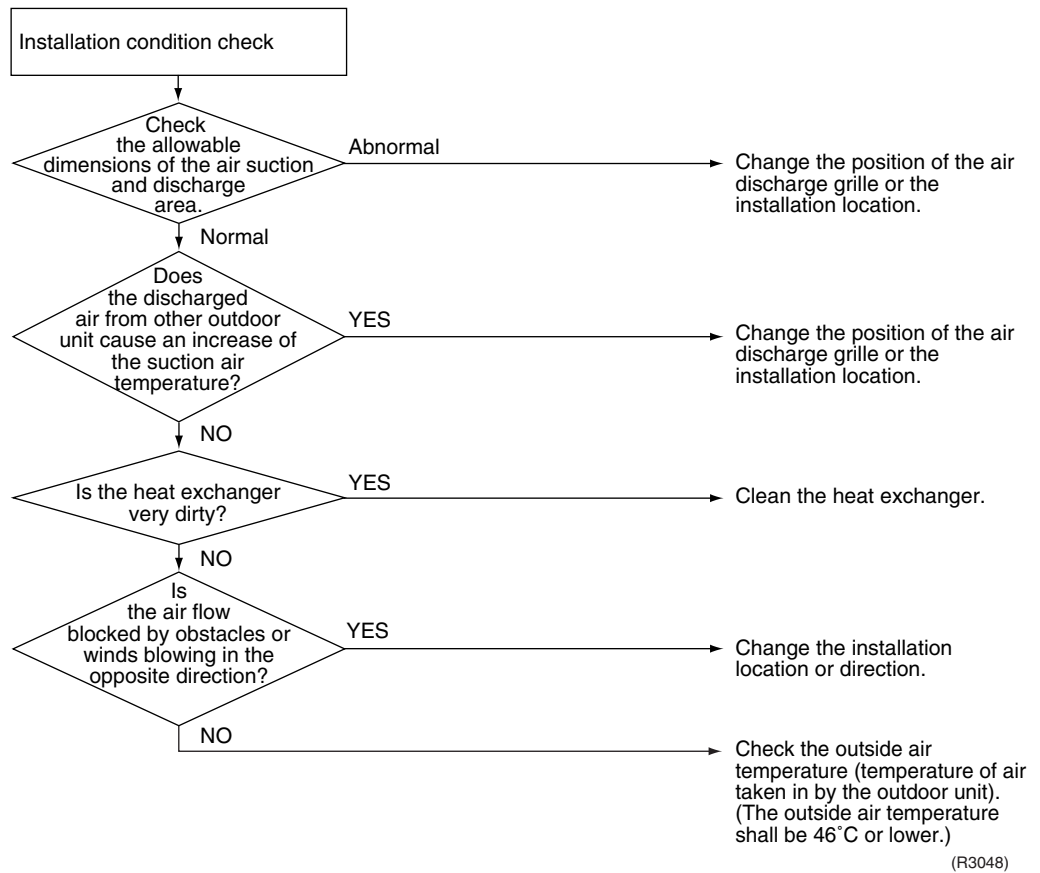

## 6.1.7 Discharge Pressure Check

### Check No.08

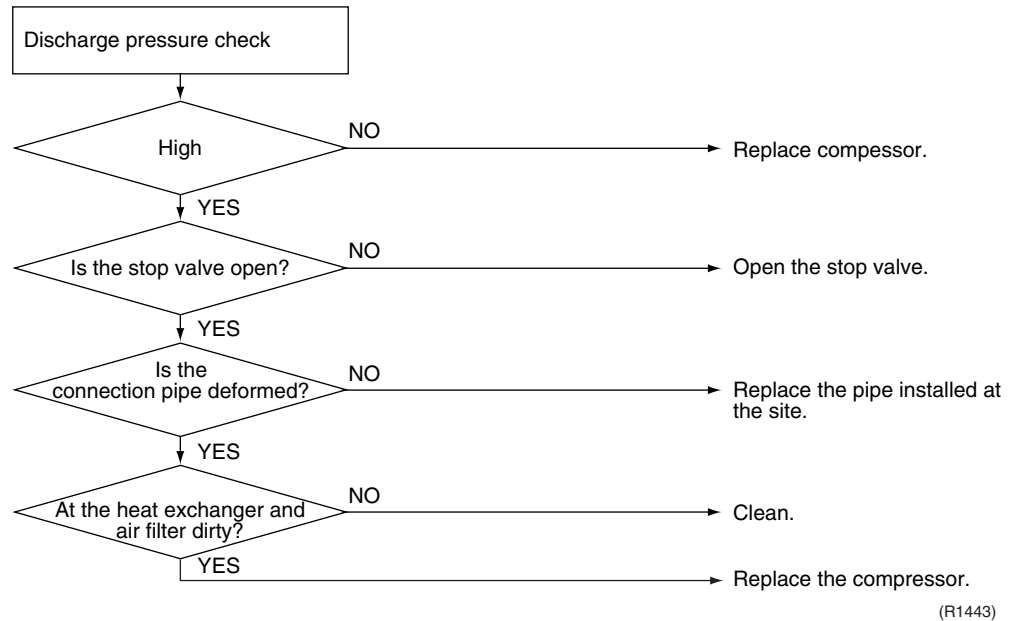

## 6.1.8 Outdoor Unit Fan System Check (With DC Motor)

### Check No.09

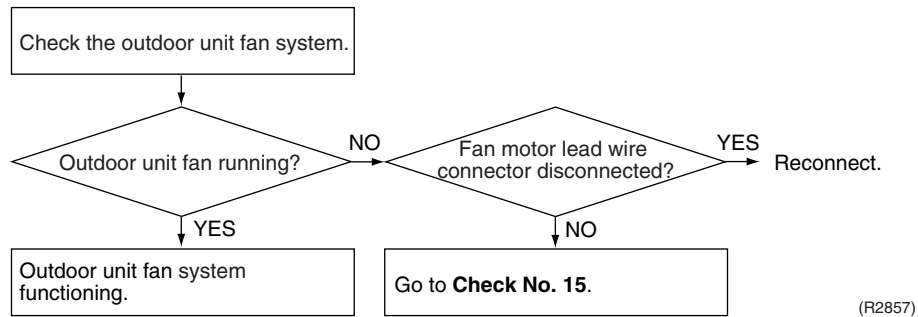

## 6.1.9 Power Supply Waveforms Check

### Check No.10

Measure the power supply waveform between pins 1 and 3 on the terminal board, and check the waveform disturbance.

- Check to see if the power supply waveform is a sine wave (Fig.1).
- Check to see if there is waveform disturbance near the zero cross (sections circled in Fig.2)

[Fig.1]

[Fig.2]

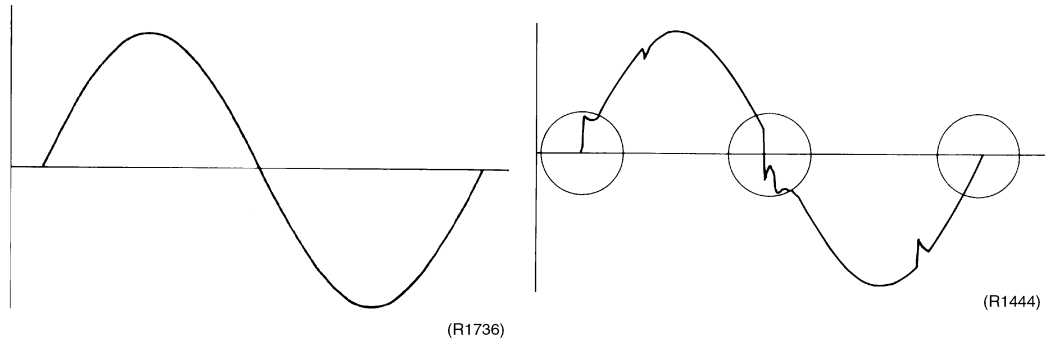

## 6.1.10 Inverter Units Refrigerant System Check

### Check No.11

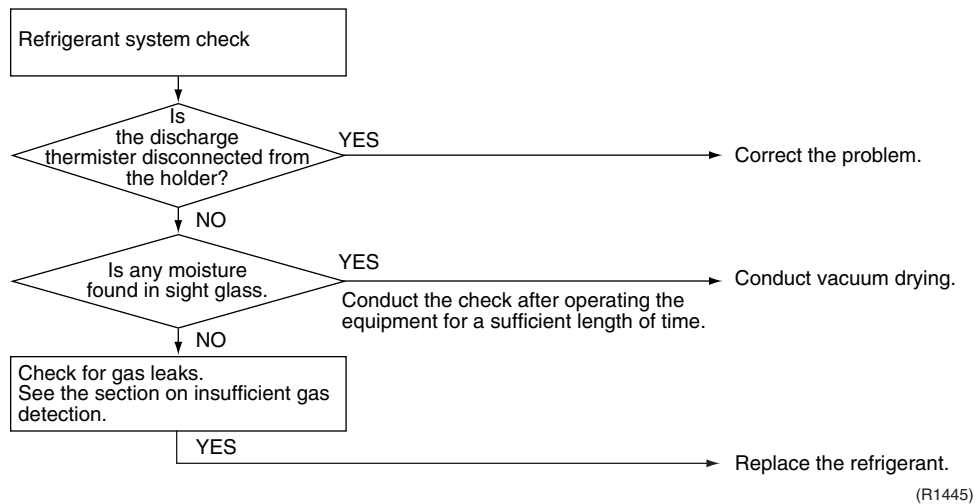

## 6.1.11 Capacitor Voltage Check

### Check No.12

Before this checking, be sure to check the main circuit for short-circuit.

- Checking the capacitor voltage
- With the circuit breaker still on, measure the voltage according to the drawing of the model in question. Be careful never to touch any live parts.

#### E series (68-75 class), D series

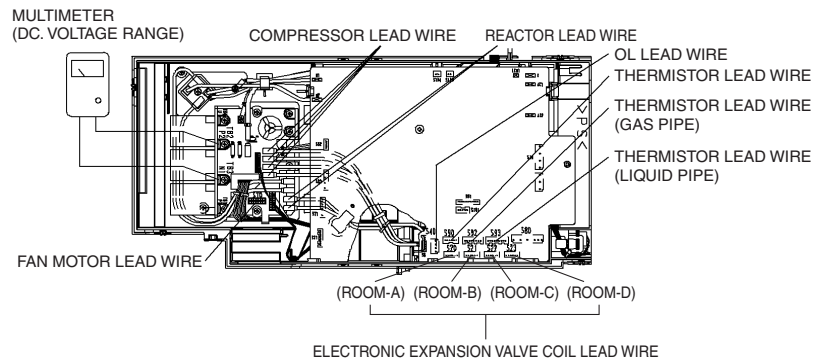

(R6335)

#### E series (50-58 class, 80-100 class)

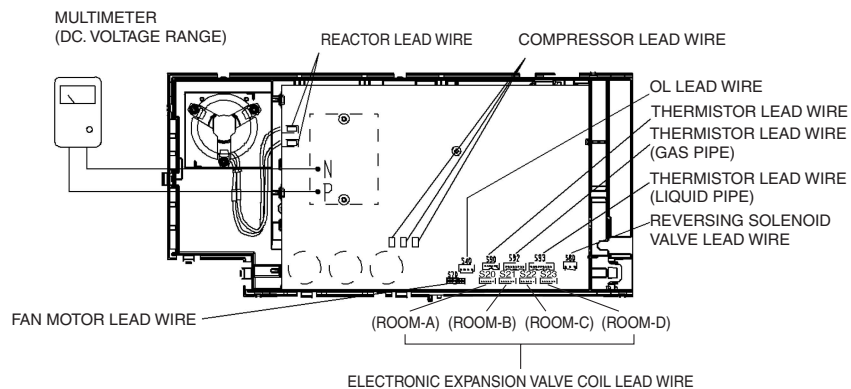

(R6334)

## 6.1.12 Power Transistor Check

### Check No.13

- Checking the power transistor
- Never touch any live parts for at least 10 minutes after turning off the circuit breaker.
- If unavoidably necessary to touch a live part, make sure the power transistor's supply voltage is below 50 V using the tester.
- For the UVW, make measurements at the Faston terminal on the board or the relay connector.

Tester's negative terminal	Power transistor (+)	UVW	Power transistor (-)	UVW
Tester's positive terminal	UVW	Power transistor (+)	UVW	Power transistor (-)
Normal resistance	Several kohms to several Mohms			
Abnormal resistance	0 or $\infty$			



### 6.1.13 Main Circuit Electrolytic Capacitor Check

**Check No.14**

- Checking the main circuit electrolytic capacitor
- Never touch any live parts for at least 10 minutes after turning off the circuit breaker.
- If unavoidably necessary to touch a live part, make sure there is no DC voltage using the tester.
- Check the continuity with the tester. Reverse the pins and make sure there is continuity.

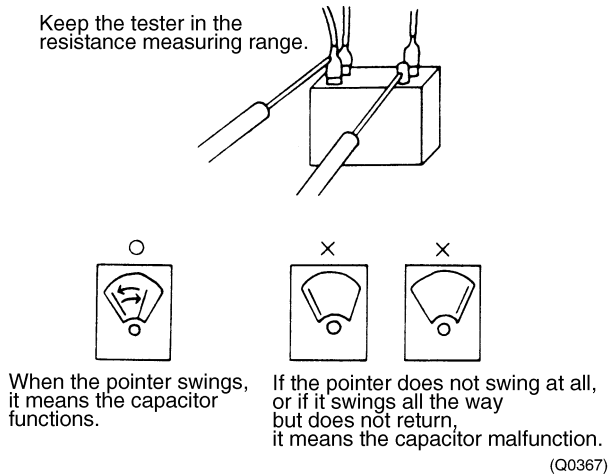

### 6.1.14 Turning Speed Pulse Input on the Outdoor Unit PCB Check

**Check No.15**

<Propeller fan motor>

Make sure the voltage of  $320\pm 30V$  is being applied.

- (1) Stop the operation first and then the power, and disconnect the connector S70.
- (2) Make sure there is about DC 320 V between pins 4 and 7.
- (3) With the system and the power still off, reconnect the connector S70.
- (4) Make a turn of the fan motor with a hand, and make sure the pulse (0-15 V) appears twice at pins 1 and 4.

If the fan motor protection fuse is blown out, the outdoor-unit fan may also be in trouble. Check the fan too.

If the voltage in Step (2) is not applied, it means the PCB is defective. Replace the PCB.

If the pulse in Step (4) is not available, it means the Hall IC is defective. Replace the DC fan motor. If there are both the voltage (2) and the pulse (4), replace the PCB.

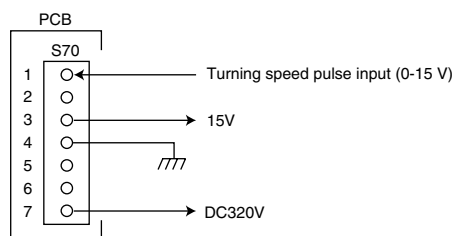

(R5223)

\* Propeller fan motor : S70

## 6.1.15 Hall IC Check

### Check No.16

1. Check the connector connection.
2. With the power ON, operation OFF, and the connector connected, check the following.
  - \*Output voltage of about 5 V between pins 1 and 3.
  - \*Generation of 3 pulses between pins 2 and 3 when the fan motor is operating.

Failure of (1) → faulty PCB → Replace the PCB.

Failure of (2) → faulty Hall IC → Replace the fan motor.

Both (1) and (2) result → Replace the PCB.

The connector has 3 pins, and there are two patterns of lead wire colors.

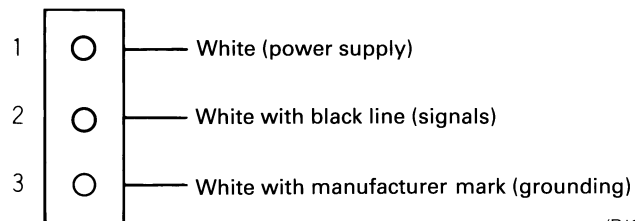
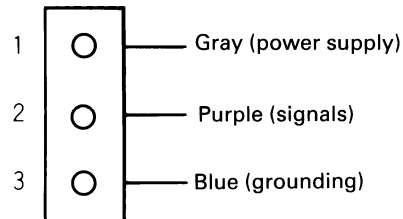

(R1990)



# Part 7

## Removal Procedure

1. Outdoor Unit – E Series (50 / 52 / 58 Class).....	272
1.1 Removal of the Panels and Plates .....	272
1.2 Removal of the Electrical Box .....	277
1.3 Removal of the PCB.....	284
1.4 Removal of the Propeller Fan / Fan Motor .....	290
1.5 Removal of the Sound Blanket.....	292
1.6 Removal of Electronic Expansion Valve Coil, Four Way Valve Coil and Thermistor .....	296
1.7 Removal of the Distributor .....	299
1.8 Removal of the Four Way Valve.....	300
1.9 Removal of the Compressor.....	301
2. Outdoor Unit – E Series (68 / 71 / 75 Class), D Series .....	303
2.1 Removal of the Outer Panels .....	303
2.2 Removal of the Electrical BOX .....	304
2.3 Removal of the PCB.....	308
2.4 Removal of the Fan Motor.....	311
2.5 Removal of the Sound Blanket.....	312
2.6 Removal of the Four Way Valve Coil, Solenoid Valve Coil, Electronic Expansion Valve Coil and Thermistor .....	313
2.7 Removal of the Four Way Valve, Solenoid Valve and Shunt .....	315
2.8 Removal of the Solenoid Valve and Shunt.....	316
2.9 Removal of the Compressor.....	317
3. Outdoor Unit – E Series (80 / 90 / 100 Class).....	318
3.1 Removal of Outer Panels .....	318
3.2 Removal of the Electrical Box .....	334
3.3 Removal of PCB.....	340
3.4 Removal of Fan Motor.....	344
3.5 Removal of Coils / Thermistors .....	345
3.6 Removal of Sound Blanket.....	351
3.7 Removal of Compressor.....	354

# 1. Outdoor Unit – E Series (50 / 52 / 58 Class)

## 1.1 Removal of the Panels and Plates

**Procedure**



**Warning**

Be sure to wait 10 minutes or more after turning off all power supplies before disassembling work.

Step	Procedure	Procedure	Points
1	External appearance.	<p>Top panel</p> <p>handle</p> <p>Discharge grille</p> <p>Stop valve cover</p> <p>Front panel (R5494)</p> <p>Outdoor air thermistor</p> <p>(R5495)</p>	<ul style="list-style-type: none"> <li>Take care not to cut your finger by the fins of the heat exchanger.</li> </ul>
2	Loosen the 4 screws (2 on both sides) of the top panel.	<p>Top panel</p> <p>Discharge grille</p> <p>Front panel (R5496)</p>	

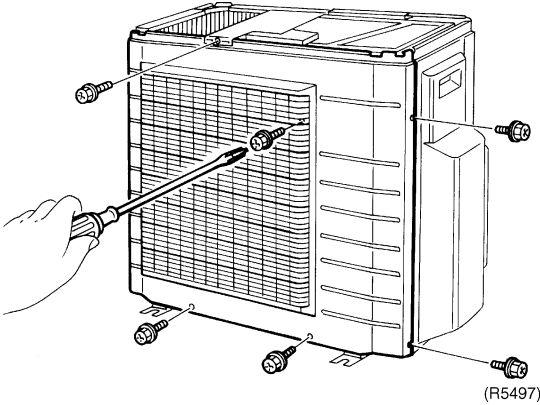
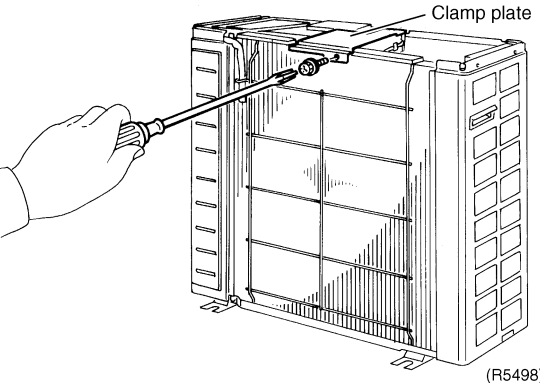
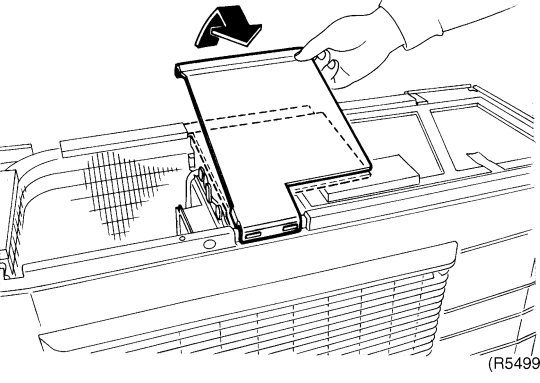
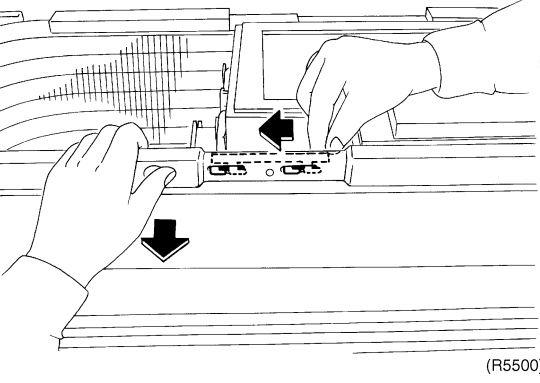
Step	Procedure	Points
3	Loosen the 6 screws of the front panel.	
	 <p>(R5497)</p>	
4	Loosen the 2 screws (each one in front and back) of the clamp plate.	
	 <p>(R5498)</p>	
5	Slide the clamp plate to the left to undo the hooks and remove the plate.	
	 <p>(R5499)</p>	
6	Undo the upper 2 hooks to remove the front panel.	
	 <p>(R5500)</p>	<p>■ Align the position of hole of the upper hook to pull the front panel out.</p>

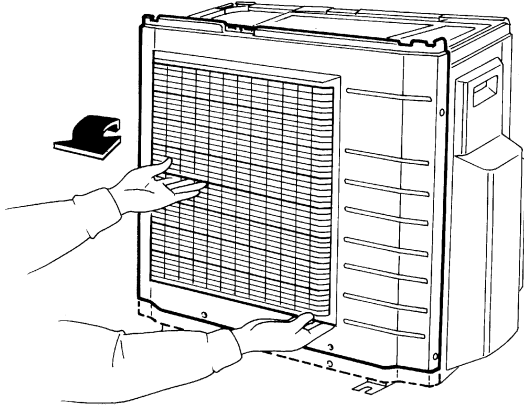
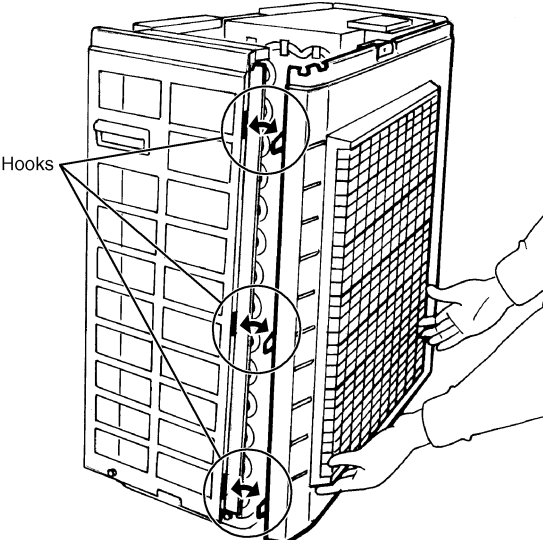
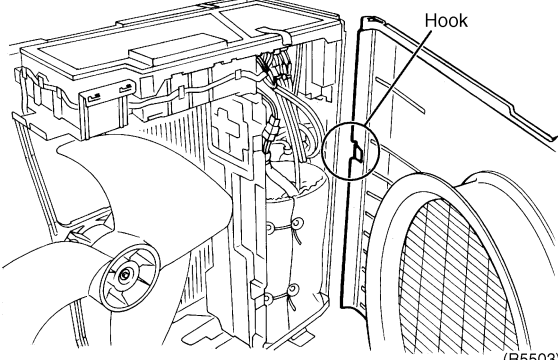
Step	Procedure	Points
7	Lift the front panel up to remove the left side hooks and open the panel.	
	 <p>(R5501)</p>	
8	The front panel has the 3 hooks on the left.	
	 <p>(R5502)</p>	
9	The front panel has the hook on the right.	
	 <p>(R5503)</p>	

Step	Procedure	Points
10	Loosen the 4 screws of the <b>discharge grille</b> .	
11	Loosen the 2 screws of the <b>stop valve cover</b> . And then slide the cover downward to remove.	

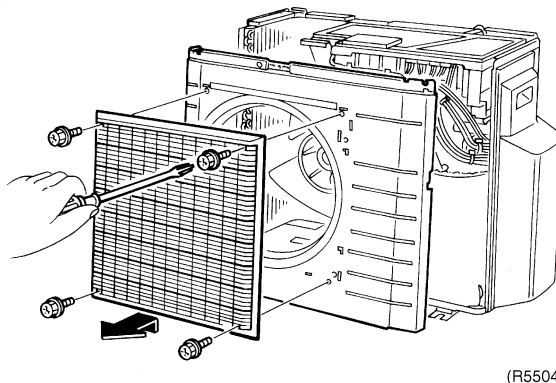

(R5504)

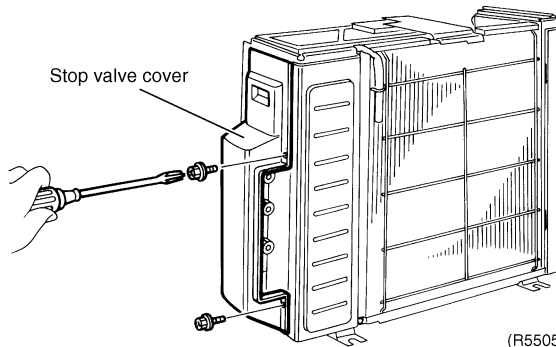

(R5505)

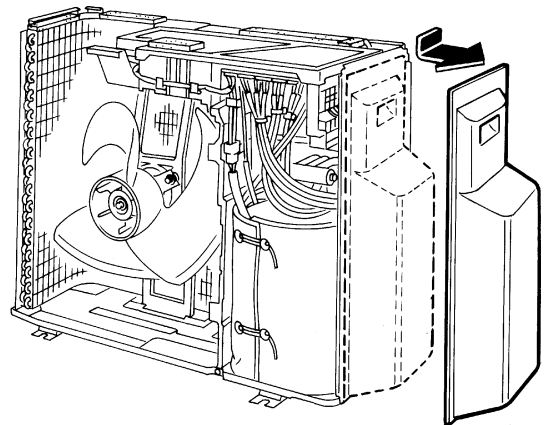

(R5506)

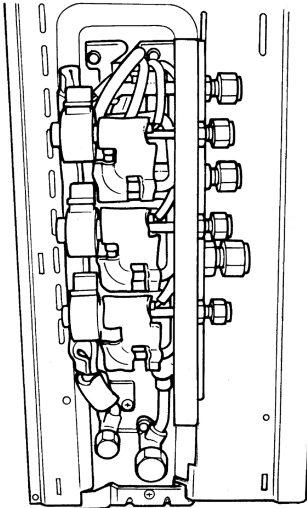
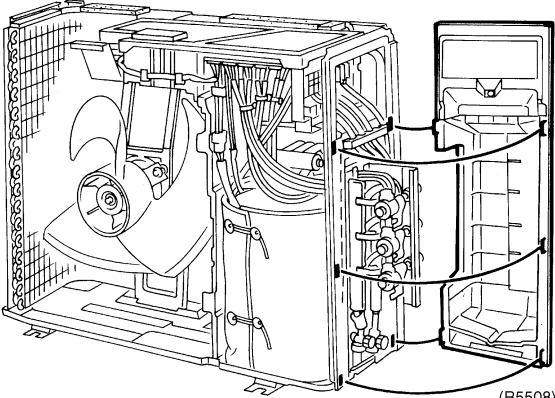

Step	Procedure	Points
	 <p style="text-align: center;">(R5507)</p>  <p style="text-align: center;">(R5508)</p>	<ul style="list-style-type: none"> <li>■ When assembling, make sure to catch the 5 hooks.</li> </ul>

## 1.2 Removal of the Electrical Box

**Procedure**



**Warning**

Be sure to wait 10 minutes or more after turning off all power supplies before disassembling work.

Step	Procedure	Points
1. Disconnect the connecting wires	<p>1 Inside structure.</p>	<p>★ Illustrations are for 3 room model.</p>
2. Disconnect the connecting wires.		<ul style="list-style-type: none"> <li>■ Connecting wires of the A, B, C, D port                     <ul style="list-style-type: none"> <li>(1) - Black Power supply</li> <li>(2) - White Power supply</li> <li>(3) - Red Transmission</li> </ul> </li> <li>■ Power Supply wires                     <ul style="list-style-type: none"> <li>(L) - Black</li> <li>(N) - White</li> </ul> </li> <li>■ Fasten the wires on the terminal board with screws.</li> </ul>

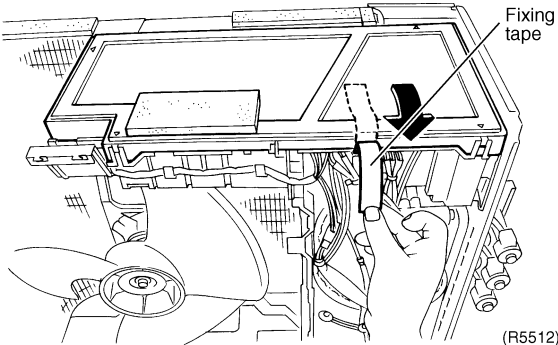
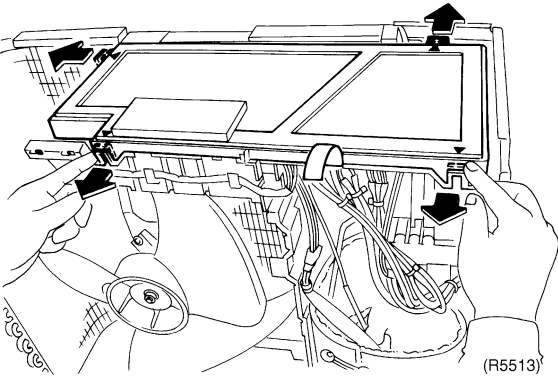
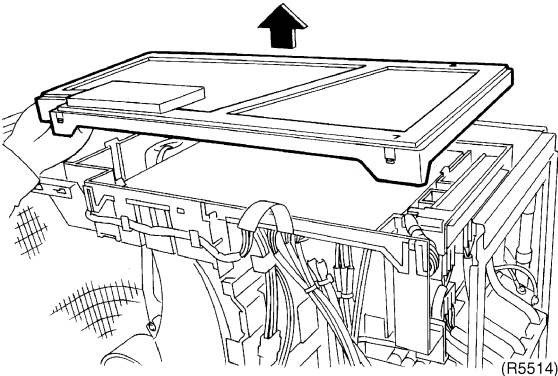
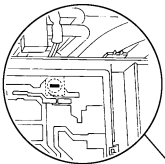
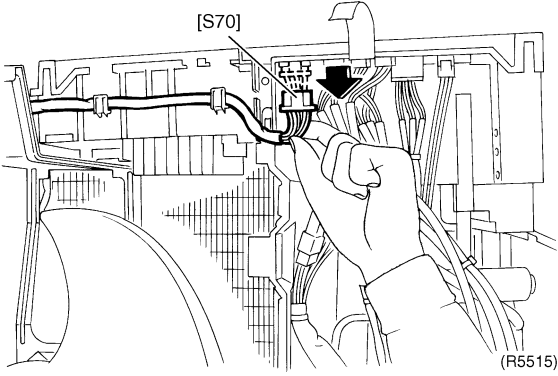
Step	Procedure	Points
2.	Disconnect the each harnesses	
1	<p>Detach the fixing tape for the electrical box (cover).</p>  <p>(R5512)</p>	
2	<p>Undo the 4 hooks at the ▲ mark of the drip proof cover.</p>  <p>(R5513)</p>	
3	<p>Lift the cover up to remove.</p>  <p>(R5514)</p>	 <p>(R5516)</p>
4	<p>Disconnect the connector for fan motor [S70] from the PCB.</p>  <p>(R5515)</p>	<p>■ Check the LED through the slit.</p>

Step	Procedure	Points
5	The figure shows the arrangement of the wire harness for fan motor.	
6	Disconnect the connectors for electronic expansion valve coil. [S20] - White [S21] - Red [S22] - Blue [S23] - Yellow	■ The number of the connectors are different according to the number of the connected indoor units.
7	Undo the wire clip.	

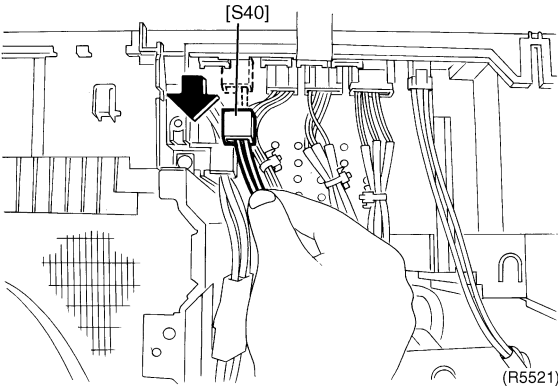
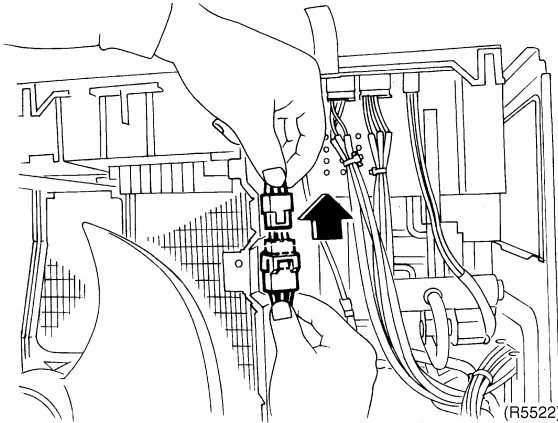
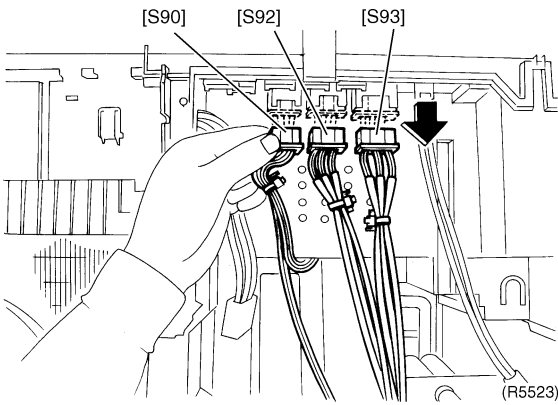
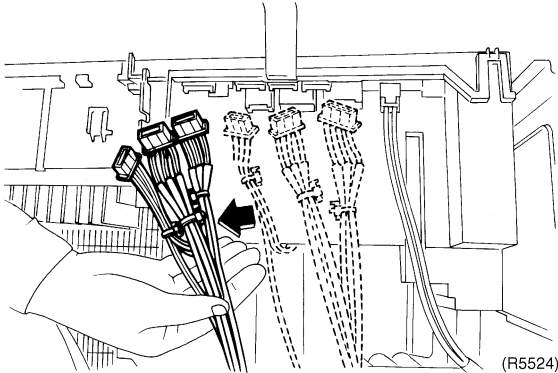
Step	Procedure	Points
8	Disconnect the connector for overload protector [S40].	
		
9	Disconnect the connector for relay harness of compressor.	
		
10	Disconnect the each connector. [S90] : Outdoor air, heat exchanger, discharge pipe thermistor [S92] : Gas pipe thermistor [S93] : Liquid pipe thermistor	
		
		

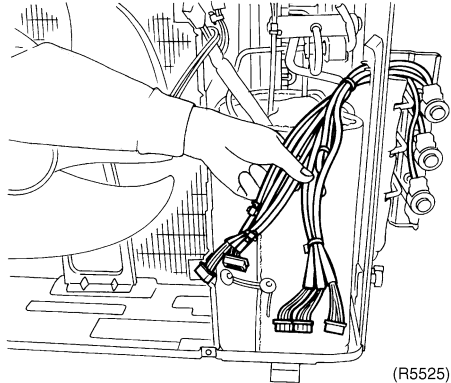
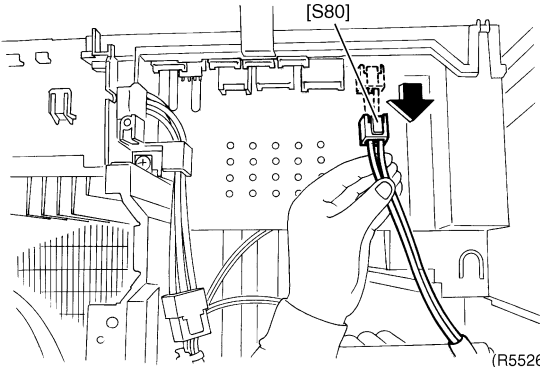
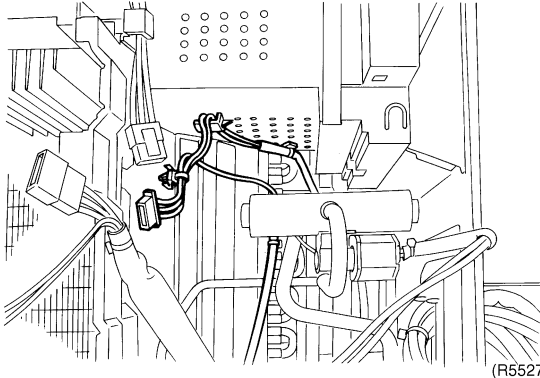
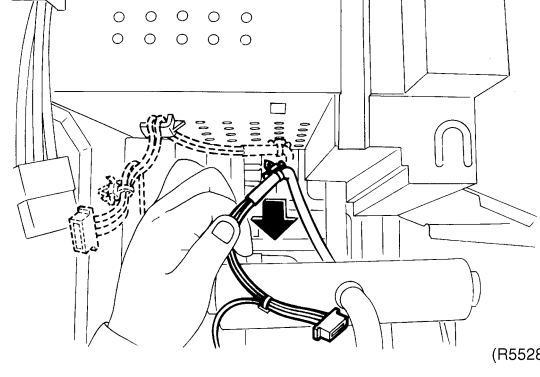
Step		Procedure	Points
11	Disconnect the connector for four way valve [S80].	 <p>(R5525)</p>  <p>(R5526)</p>	
12	The figure shows the arrangement of the wire harness under the electrical box.	 <p>(R5527)</p>	
13	Undo the wire clip for the thermistor lead wire.	 <p>(R5528)</p>	

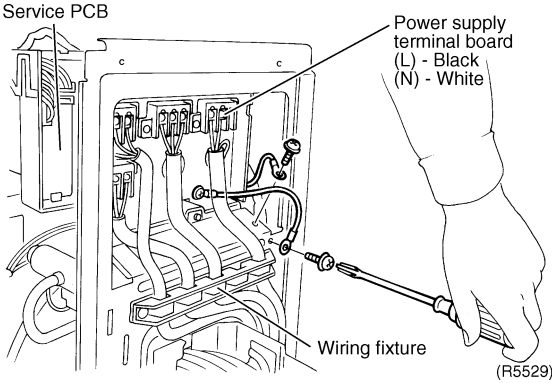
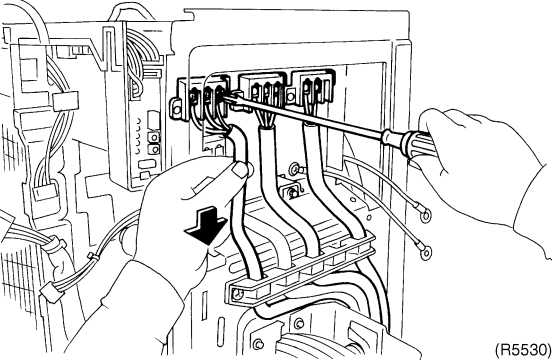
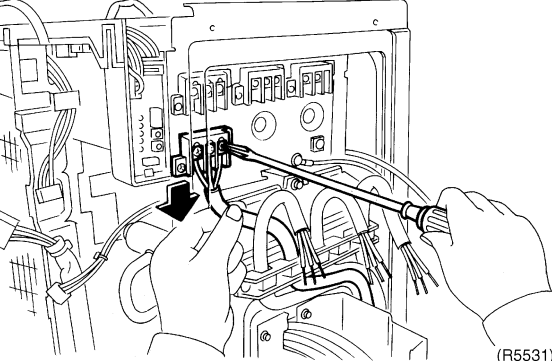
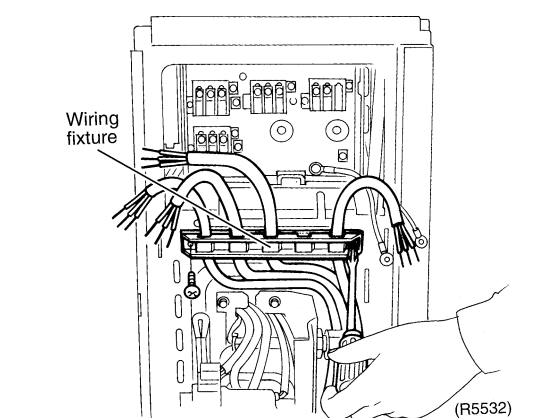
Step	Procedure	Points
<p>3. Remove the electrical box</p> <p>1 Loosen the 2 screws of the earth terminal.</p>	 <p>Service PCB</p> <p>Power supply terminal board (L) - Black (N) - White</p> <p>Wiring fixture</p> <p>(R5529)</p>	
<p>4. Disconnect the power supply connecting wires</p> <p>1 Loosen the screws on the terminal board and disconnect the wires of A, B, C, and D port.</p>	 <p>(R5530)</p>  <p>(R5531)</p>  <p>Wiring fixture</p> <p>(R5532)</p>	

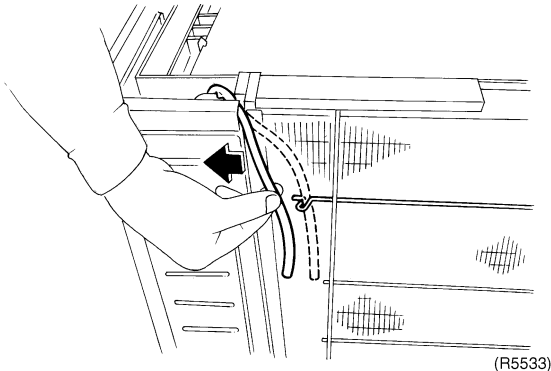
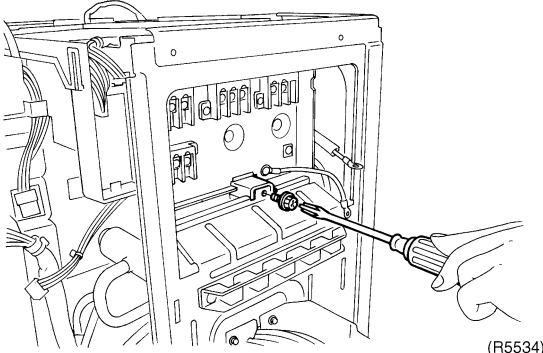
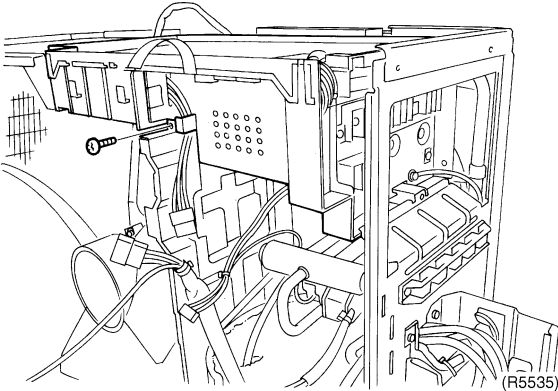
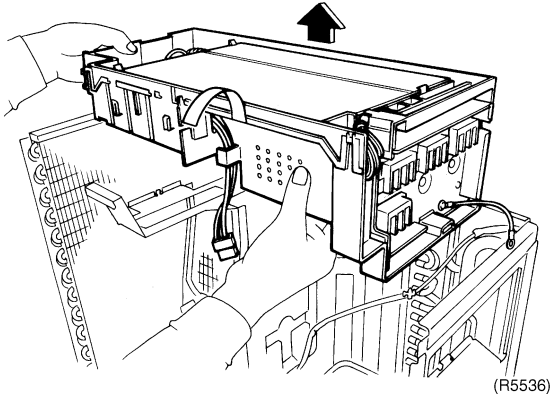
Step	Procedure	Points
2	Detach the outdoor air thermistor.	
	 <p>(R5533)</p>	
3	Loosen the screw on the right side of the electrical box.	
	 <p>(R5534)</p>	
4	Loosen the screw in front of the electrical box.	
	 <p>(R5535)</p>	
5	Lift up the electrical box to remove.	
	 <p>(R5536)</p>	



## 1.3 Removal of the PCB

**Procedure**



**Warning** Be sure to wait 10 minutes or more after turning off all power supplies before disassembling work.

Step	Procedure	Points
1.	Remove the <b>service PCB</b>	
1	External appearance of the service PCB and the terminal board.	
2	Loosen the one screw of the terminal board and open it.	
3	Disconnect the connector [S52] and [S102] from the service PCB.	

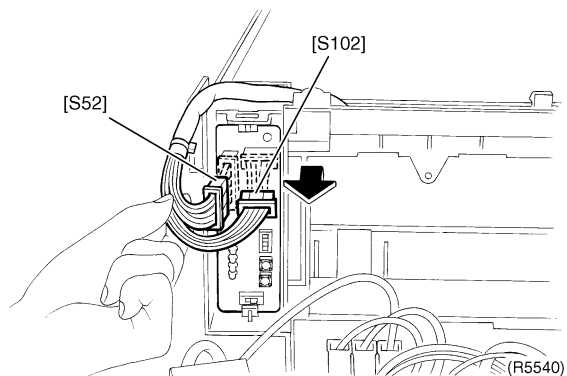
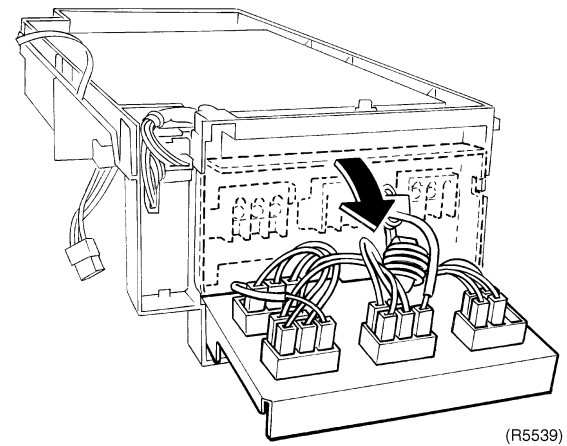
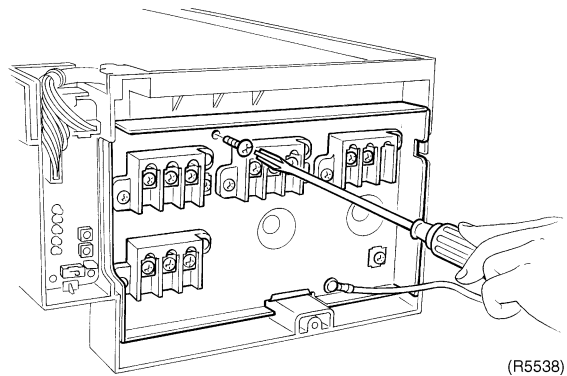
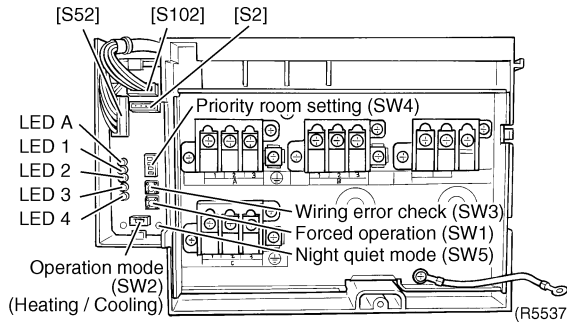

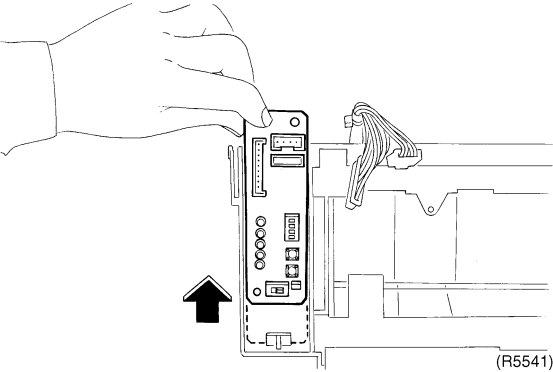
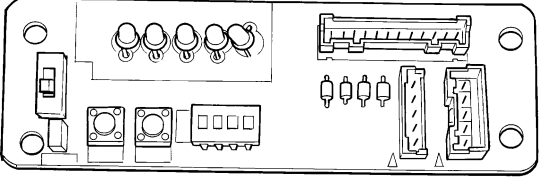
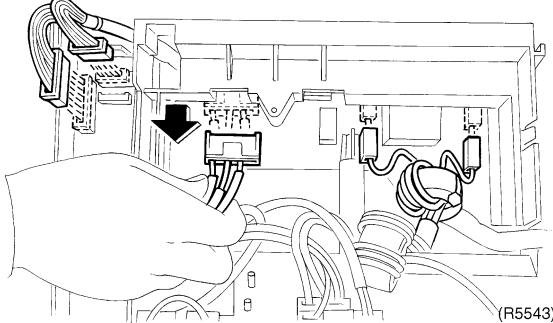
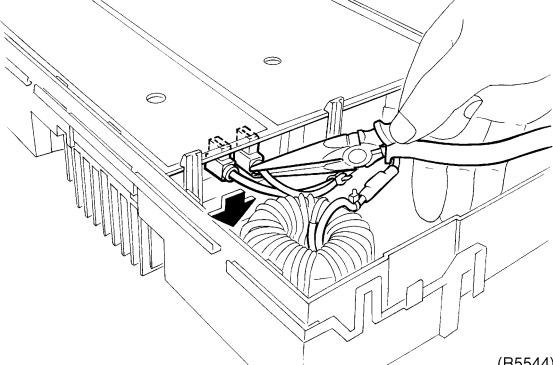
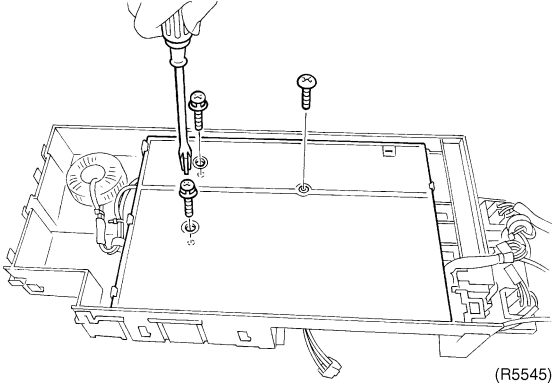
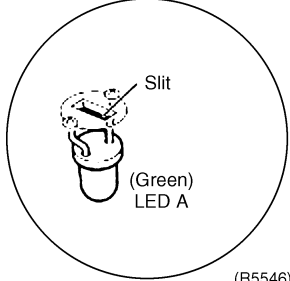
Step	Procedure	Points
4	<p>Widen the upper hook and pull the service PCB upward to remove.</p>  	
2. Remove the <b>control PCB</b>		
1	<p>Disconnect the each connectors on the terminal board.</p> 	
2	<p>Disconnect the 2 connectors for reactor.</p> 	
3	<p>Loosen the 3 screws of the PCB.</p> 	 <p>(R5546)</p> <ul style="list-style-type: none"> <li>■ The PCB is down side up for improvement of quality.</li> <li>■ Service monitor (LED A).</li> <li>■ Check the LED through the slit.</li> </ul>

Step	Procedure	Points
4	Undo the 3 hooks on the reactor side and slide the control PCB.	
5	Undo the relay harness for compressor from the hook.	
6	Lift up the control PCB to remove.	<ul style="list-style-type: none"> <li>■ In working, be careful not to break the control PCB with the excessive force because the PCB and the radiation fin are adhered to one another.</li> <li>■ When assembling, make sure to use the silicon material.</li> <li>■ Silicon material Part No.: 1172698</li> </ul>
7	Each wire harness.	

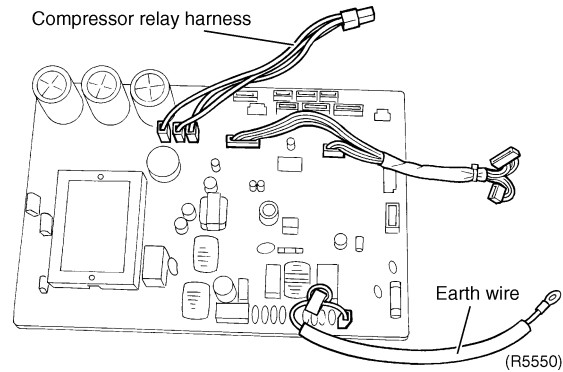
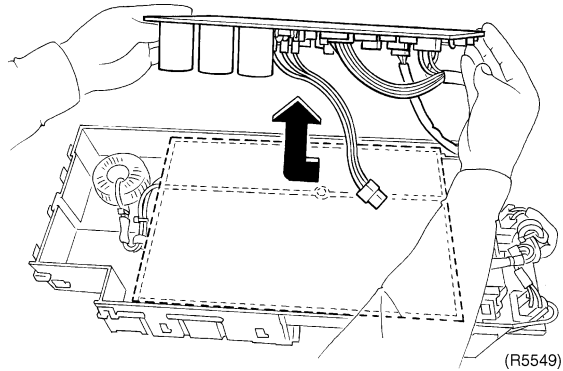
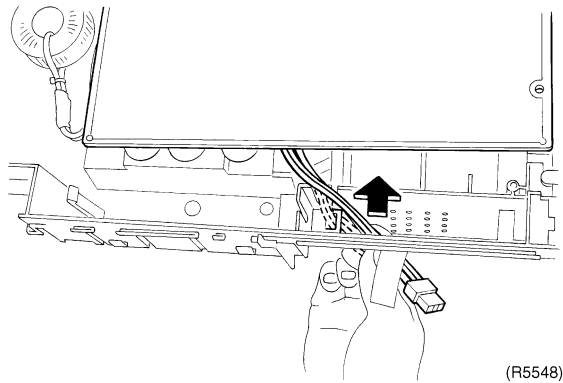
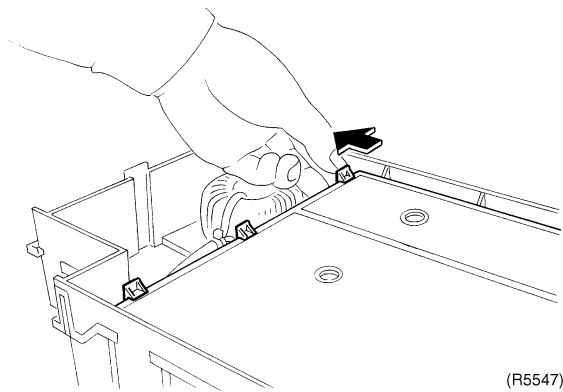

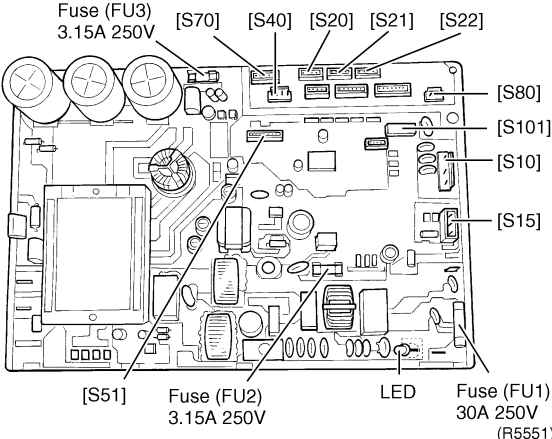
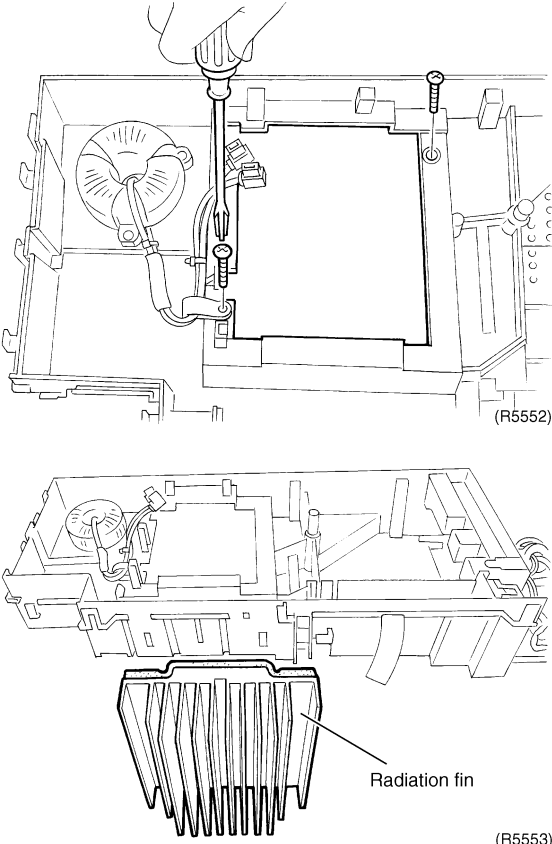
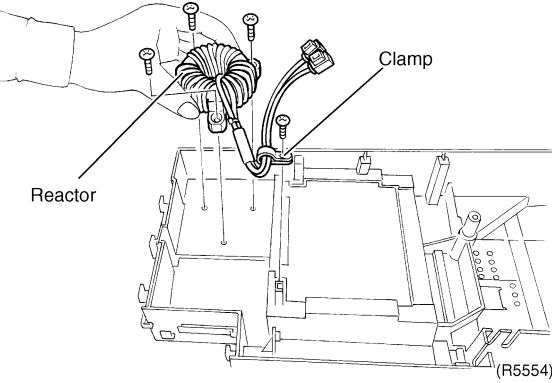
Step		Procedure	Points
8	Names of parts on the control PCB.		
9	Loosen the 2 screws of the radiation fin.		
10	Loosen the 3 screws of the reactor and the one screw of the clamp.		

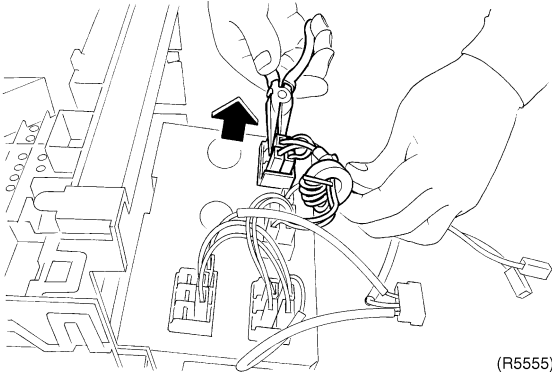
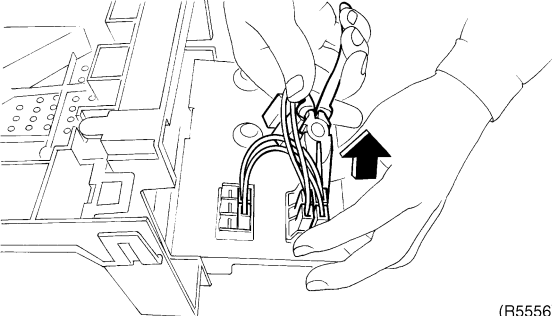
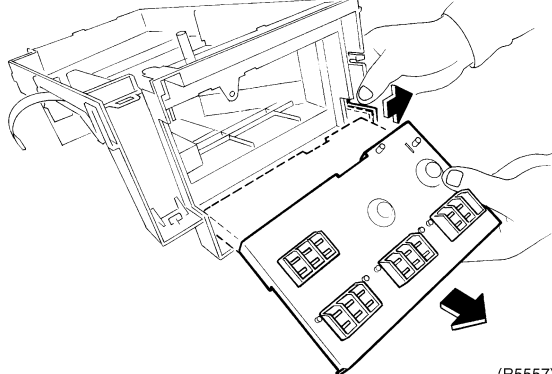
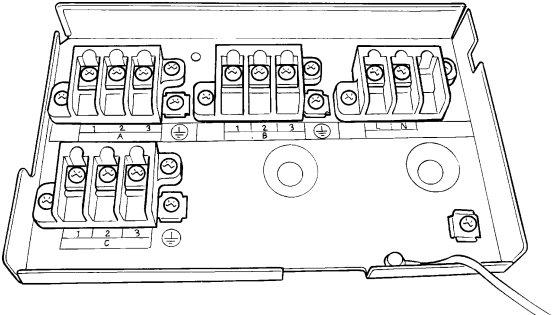
Step	Procedure	Points
<p>3. Disconnect the wire harnesses</p>	 <p>(R5555)</p>  <p>(R5556)</p>	
<p>4. Remove the terminal board</p>	<p>1 Open the electrical box and remove the terminal board.</p>  <p>(R5557)</p>  <p>(R5558)</p>	

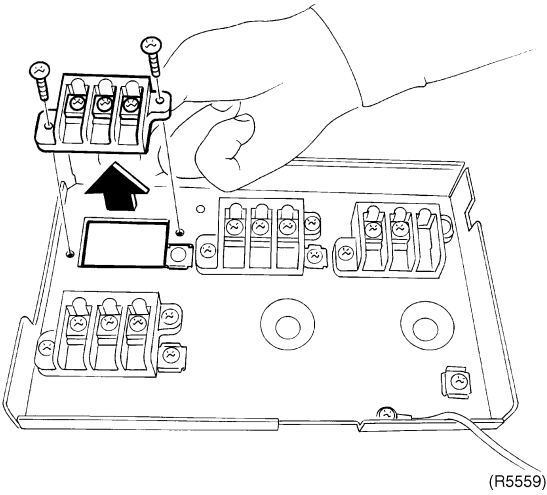
Step	Procedure	Points
	 <p>(R5559)</p>	

## 1.4 Removal of the Propeller Fan / Fan Motor

**Procedure**



**Warning** Be sure to wait 10 minutes or more after turning off all power supplies before disassembling work.

Step	Procedure	Procedure	Points
1	Remove the fan motor fixing plate.	<p>(R5560)</p>	<ul style="list-style-type: none"> <li>■ Remove the outer panels and plates.</li> <li>■ Remove the electrical box.</li> </ul>
2	Take out the fan motor fixing plate toward yourself.	<p>(R5561)</p>	<p>(R5564)</p> <ul style="list-style-type: none"> <li>■ When assembling, fit the lower hooks.</li> </ul>
3	Loosen the washer fitted nut to remove the propeller fan.	<p>(R5562)</p> <p>(R5563)</p>	<p>(R5565)</p> <ul style="list-style-type: none"> <li>■ When assembling, align ▼ mark of the propeller fan with D-cut section of the motor shaft.</li> <li>■ When assembling, make sure ● mark of the fan motor goes up.</li> </ul>

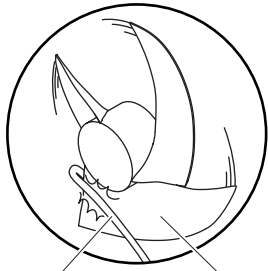
Step	Procedure	Points
4	Undo the 2 fixing hooks of the lead wire. Loosen the 4 screws of the fan motor.	 <p>Lead wire      Propeller fan (R3249)</p>
5	Detach the 4 screws and 4 rubber vibration isolators.	<ul style="list-style-type: none"> <li>■ When assembling, put the lead wire through the back of the motor. (so as not to be entangled with the propeller fan)</li> </ul>

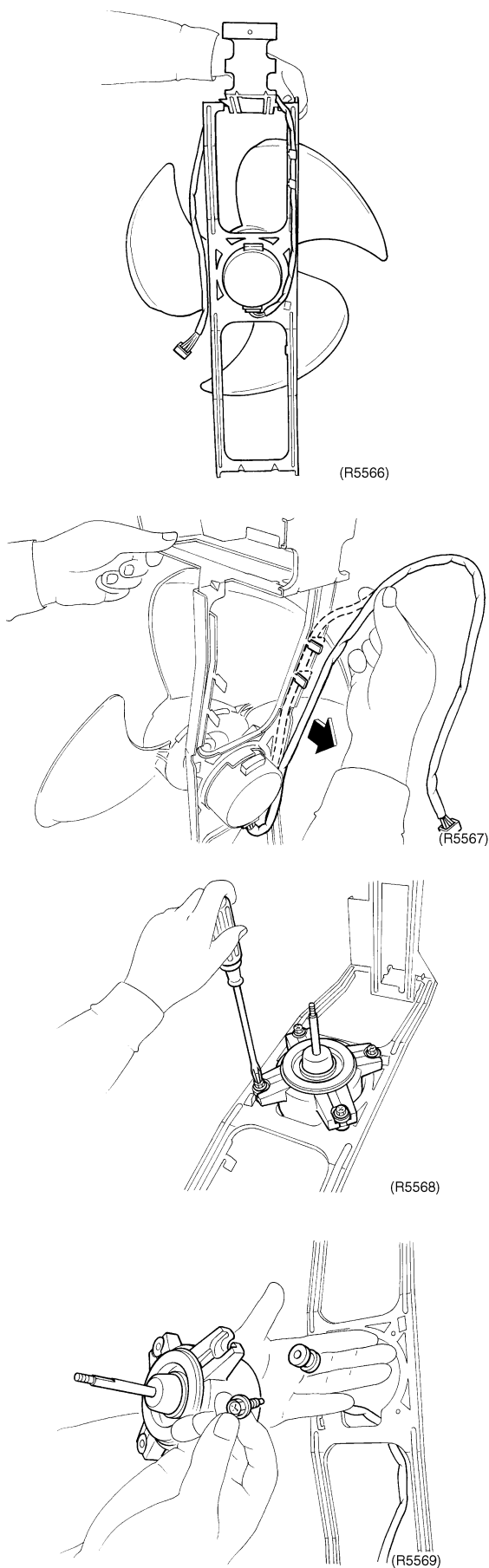



# 1.5 Removal of the Sound Blanket

**Procedure**



**Warning**

Be sure to wait 10 minutes or more after turning off all power supplies before disassembling work.

Step	Procedure	Points
1. Remove the right side panel	<p>(R5570)</p>	<ul style="list-style-type: none"> <li>■ Remove the outer panels and plates.</li> <li>■ Remove the electrical box.</li> </ul>
1 Loosen the 3 screws on the right of the right side panel.		
2 Loosen the 2 screws on the back.	<p>(R5571)</p>	
2 Loosen the 2 screws on the back.		
3 Remove the packing. There is a hook on the back.	<p>Packing</p> <p>(R5572)</p>	
3 Remove the packing. There is a hook on the back.		

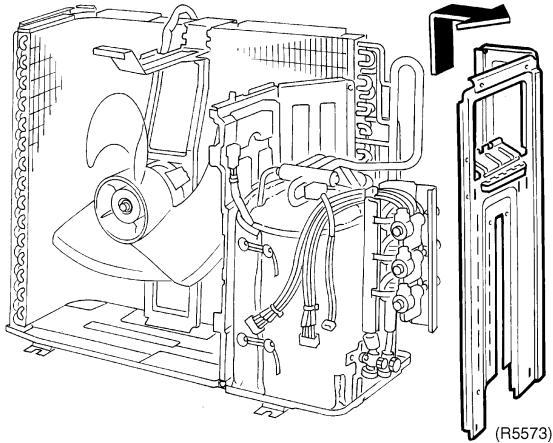
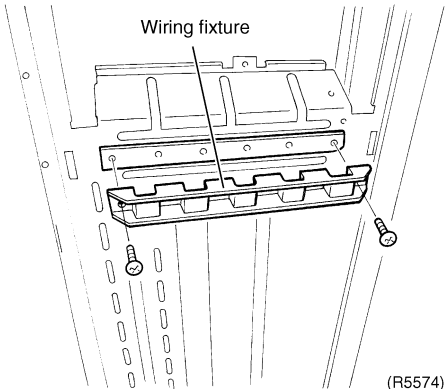
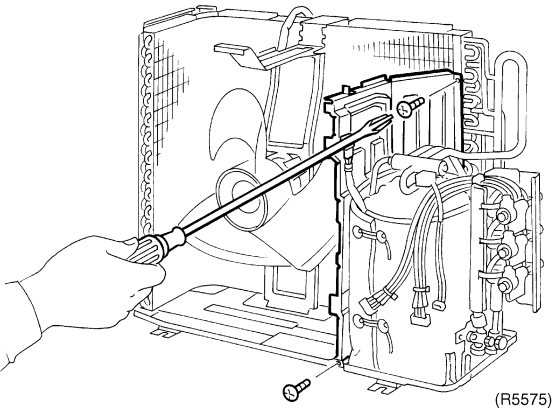
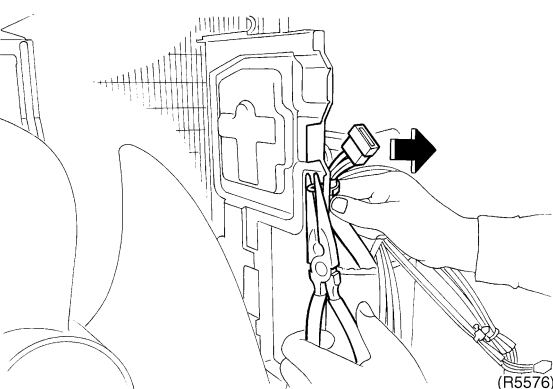
Step	Procedure	Points
4	<p>Pull up the right side panel.</p>  <p>(R5573)</p>	
5	<p>Loosen the 2 screws of the wiring fixture.</p>  <p>(R5574)</p>	
<b>2. Remove the partition plate</b>		
1	<p>Loosen the 2 screws to remove the partition plate.</p>  <p>(R5575)</p>	
2	<p>Detach the clamp of the relay harness for the compressor.</p>  <p>(R5576)</p>	

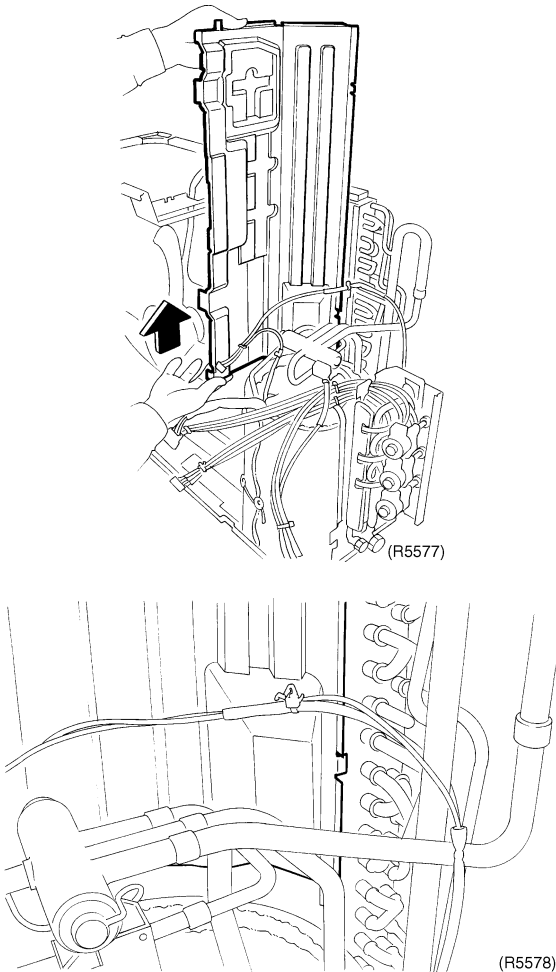
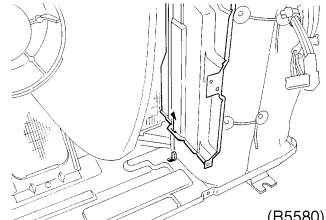
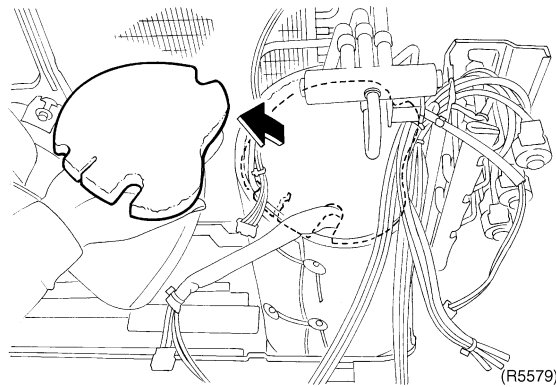
Step		Procedure	Points
3	Pull up the partition plate.	 <p>(R5577)</p> <p>(R5578)</p>	 <p>(R5580)</p> <ul style="list-style-type: none"> <li>■ When assembling, make sure to catch the lower hook of the partition plate.</li> </ul>
3.	Remove the sound blanket	 <p>(R5579)</p> <p>(R5581)</p>	<ul style="list-style-type: none"> <li>■ Since the piping ports on the sound blanket are torn easily, remove the blanket carefully.</li> </ul>

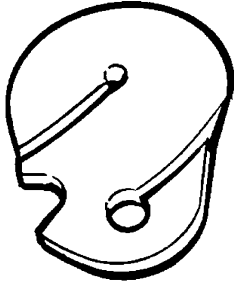
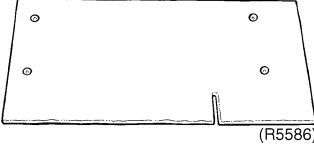
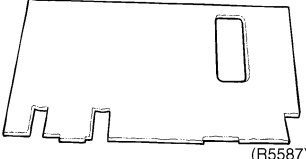
Step	Procedure	Points
2	Remove the sound blanket (top-lower).	 <p data-bbox="1370 551 1433 571">(R5585)</p>
3	Undo the fixing strings, open the sound blanket (body) and pull it out.	 <p data-bbox="1370 842 1433 862">(R5586)</p>
4	Open the sound blanket (inner) and pull it out.	 <p data-bbox="1370 1290 1433 1310">(R5587)</p>

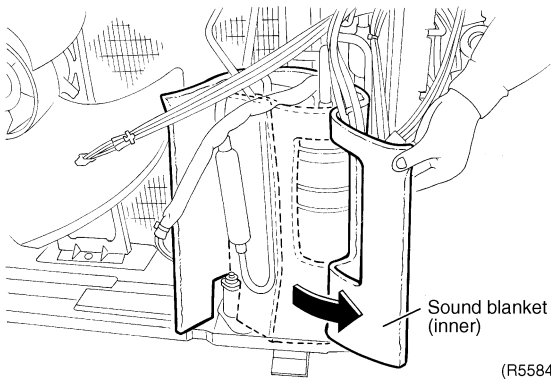
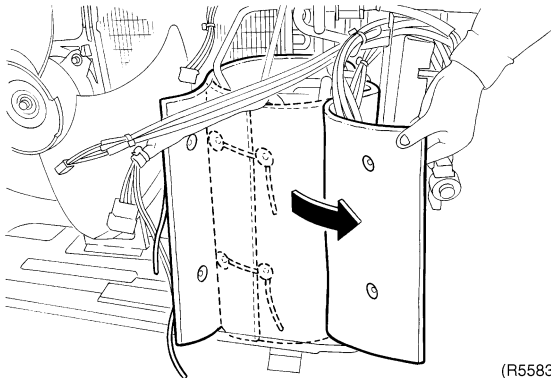
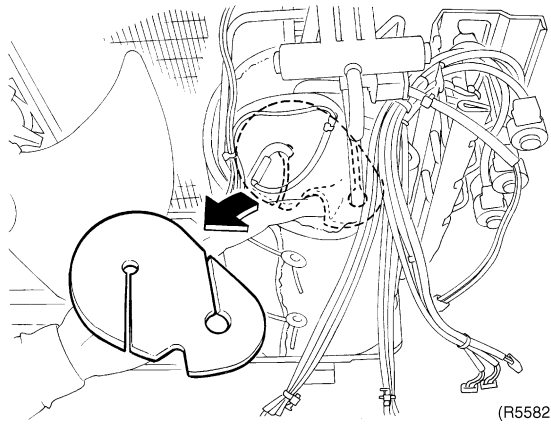

## 1.6 Removal of Electronic Expansion Valve Coil, Four Way Valve Coil and Thermistor

**Procedure**



**Warning**

Be sure to wait 10 minutes or more after turning off all power supplies before disassembling work.

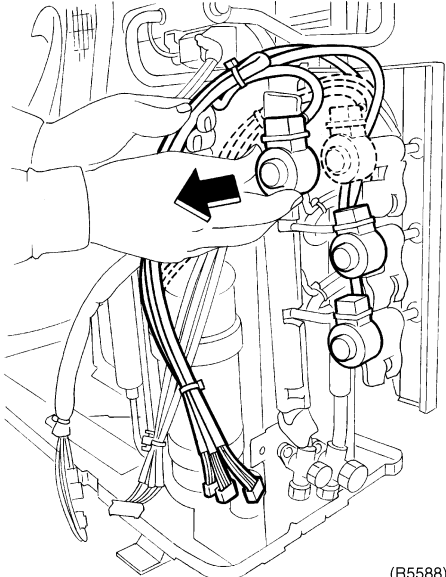
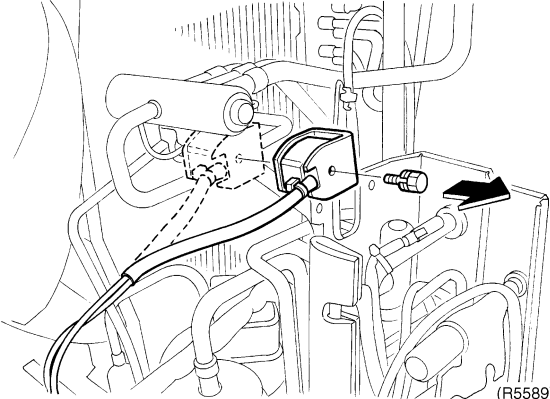
Step	Procedure	Points
1. Remove the electronic expansion valve coil	 <p>(R5588)</p>	
1 Remove the each electronic expansion valve coil.		
2. Remove the four way valve coil	 <p>(R5589)</p>	
1 Loosen the screw to remove the four way valve coil.		

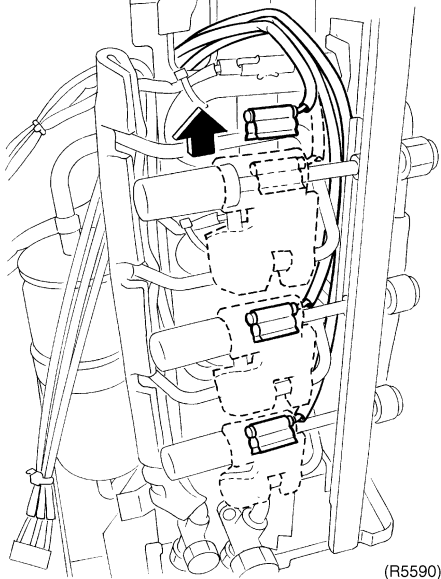
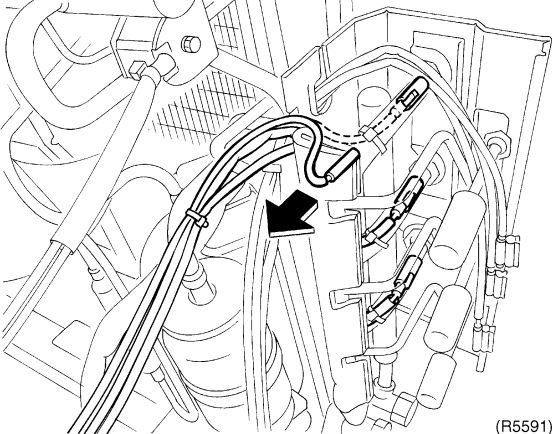
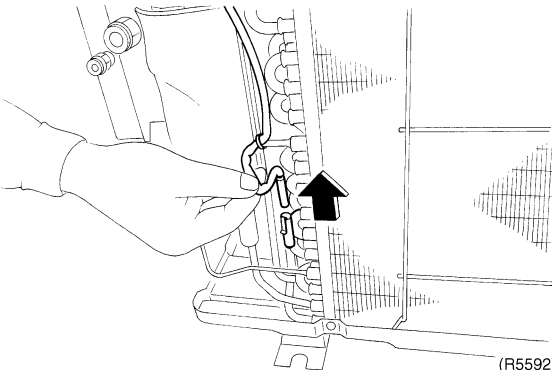
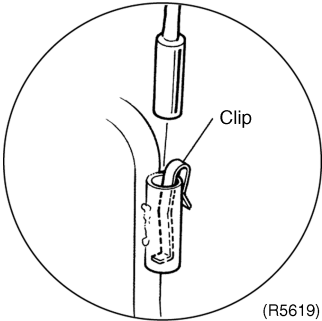
Step	Procedure	Points
<p>3. Remove the liquid/gas pipe thermistor</p> <p>1 Open the putty and remove the liquid pipe thermistor.                      [S90] : Outdoor air thermistor                      Heat exchanger thermistor                      Discharge pipe thermistor                      [S92] : Gas pipe thermistor                      Room A (Black)                      Room B (Gray)                      Room C (Brown)                      Room D (Red)                      [S93] : Liquid pipe thermistor                      Room A (Black)                      Room B (Gray)                      Room C (Yellow)                      Room D (Blue)</p> <p>2 Open the putty and remove the gas pipe thermistor.</p>	 <p>(R5590)</p>  <p>(R5591)</p>	<ul style="list-style-type: none"> <li>■ Meet the edge of the thermistor and clip.</li> <li>■ The number of ports is different according to the models.</li> </ul>
<p>4. Remove the heat exchanger thermistor</p> <p>1 Remove the heat exchanger thermistor.</p>	 <p>(R5592)</p>	 <p>(R5619)</p>

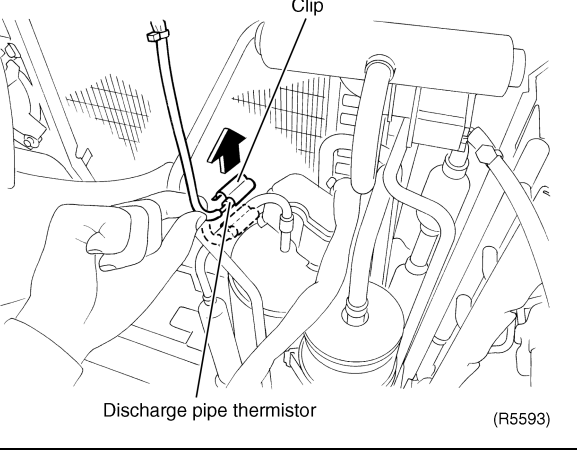
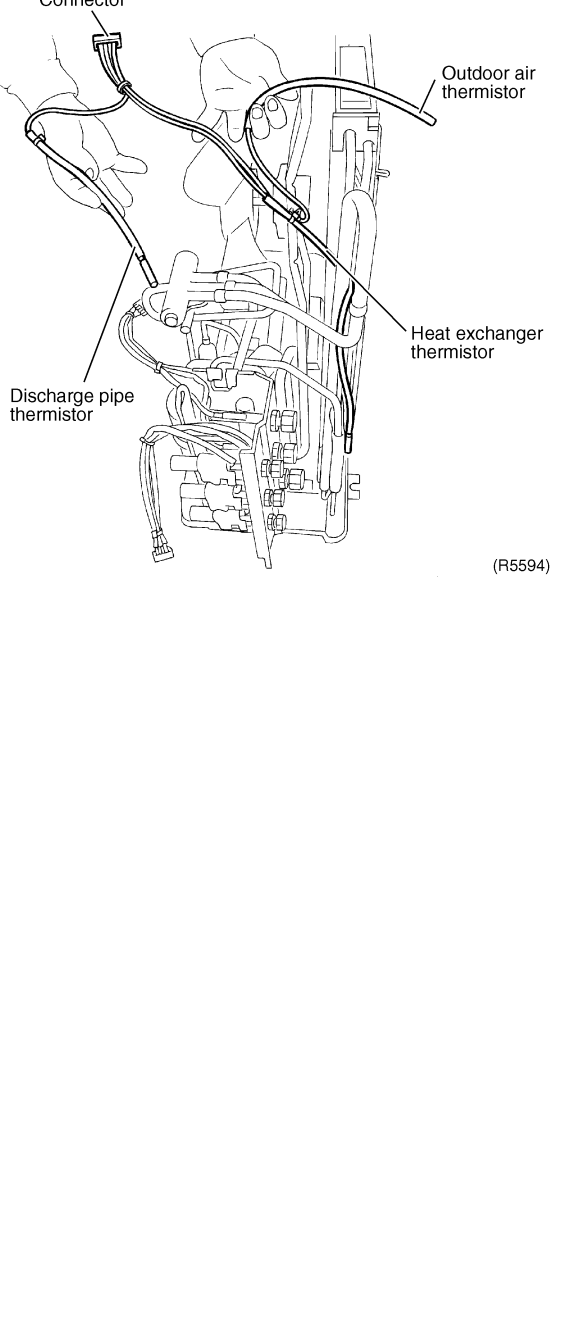



Step	Procedure	Points
<p>5. Remove the discharge pipe thermistor</p>	<p>1 Undo the clip and remove the discharge pipe thermistor.</p> 	<ul style="list-style-type: none"> <li>■ Meet the edge of the thermistor and clip.</li> <li>■ Be careful not to loose the clip for the discharge pipe thermistor.</li> </ul>
<p>6. Remove the assembly of thermistor.</p>	<p>1 The figure shows the arrangement of the assembly of thermistor.</p> 	

## 1.7 Removal of the Distributor

**Procedure**

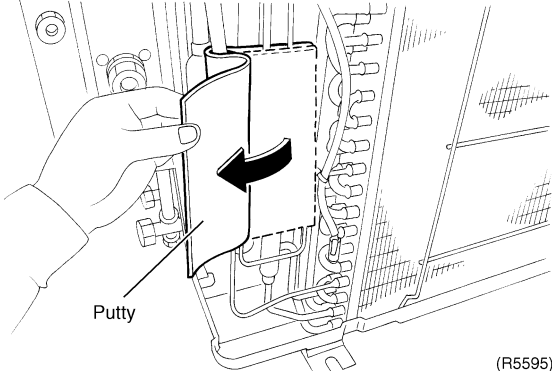
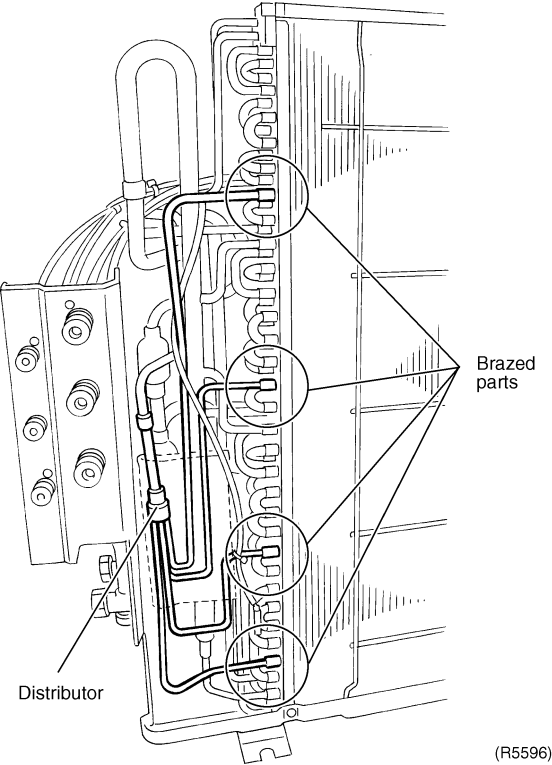

**Warning** Be sure to wait 10 minutes or more after turning off all power supplies before disassembling work.

Step	Procedure	Procedure	Points
1	Remove the putty.	 <p>(R5595)</p>  <p>(R5596)</p>	<p> <b>Warning</b> Ventilate when refrigerant leaks during the work. (If refrigerant contacts fire, it will cause to arise toxic gas.)</p> <p> <b>Caution</b> Be careful not to get yourself burnt with the pipes and other parts that are heated by the gas welding rod.</p> <p> <b>Caution</b> From the viewpoint of global environment protection, do not discharge the refrigerant gas in the atmosphere. Make sure to recover the refrigerant gas with the recovery system.</p>



# 1.8 Removal of the Four Way Valve

**Procedure**

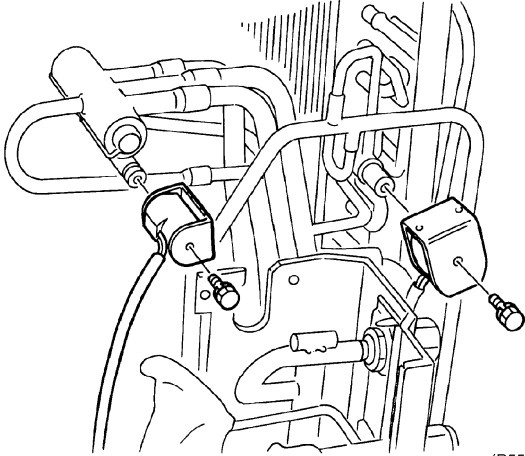
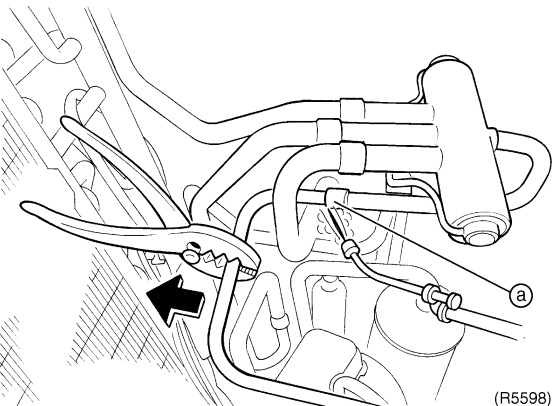
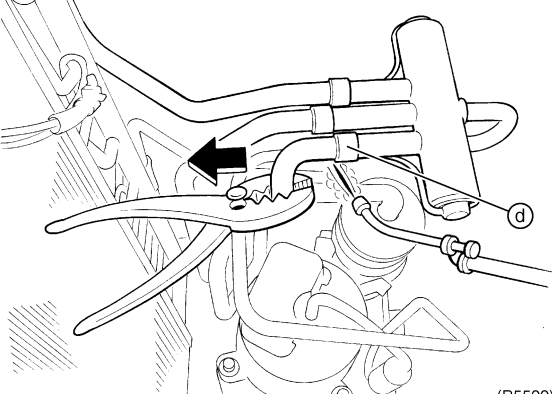
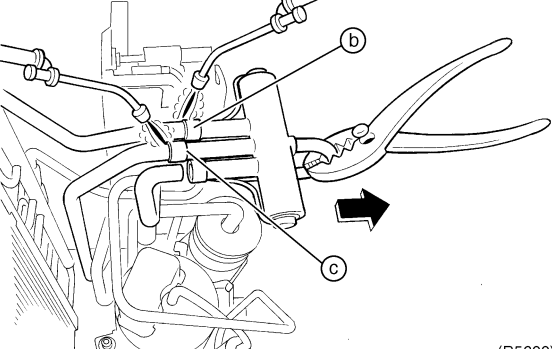

**Warning** Be sure to wait 10 minutes or more after turning off all power supplies before disassembling work.

Step	Procedure	Points
<p>■ Be sure to apply nitrogen replacement when heating up the brazed part.</p>	 <p style="text-align: right;">(R5597)</p>	<p><b>Cautions for restoration</b></p> <ol style="list-style-type: none"> <li>1. Restore the piping by non-oxidation brazing. In case of you cannot use the nitrogen gas, restore as quickly as possible.</li> <li>2. It is required to prevent the carbonization of the oil inside the four way valve and the deterioration of the gaskets affected by heat. For the sake of this, wrap the four way valve with wet cloth and provide water so that the cloth will not be dried and avoid excessive heating. (Keep below 120°C)</li> </ol>
<p>1 Loosen the one screw to remove the four way valve coil.</p> <p>2 Heat up the 4 brazed part of the four way valve. First, disconnect the part "a".</p> <p>■ Provide a protective sheet or a steel plate so that the brazing flame cannot influence peripheries.</p>	 <p style="text-align: right;">(R5598)</p>	<p>■ Be careful so as not to break the pipes by pressing it excessively by pliers when withdrawing it.</p> <p><b>In case of the difficulty with gas brazing machine</b></p> <ol style="list-style-type: none"> <li>1. Disconnect the brazed part where is easy to disconnect and restore.</li> <li>2. Cut pipes on the main unit by a miniature copper tube cutter in order to make it easy to disconnect.</li> </ol>
<p>3 Disconnect the part "d".</p>	 <p style="text-align: right;">(R5599)</p>	<p><b>i</b> Note: Do not use a metal saw for cutting pipes by all means because the sawdust come into the circuit.</p>
<p>4 Disconnect the part "b" and "c".</p>	 <p style="text-align: right;">(R5600)</p>	



## 1.9 Removal of the Compressor

### Procedure

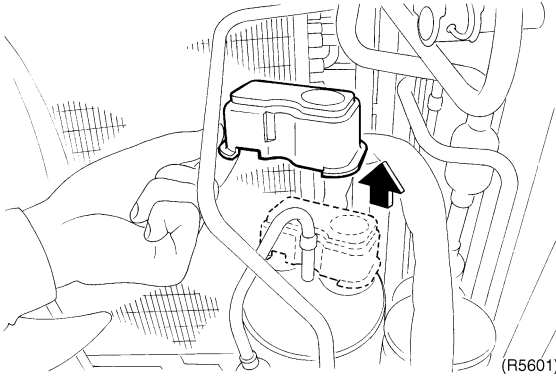
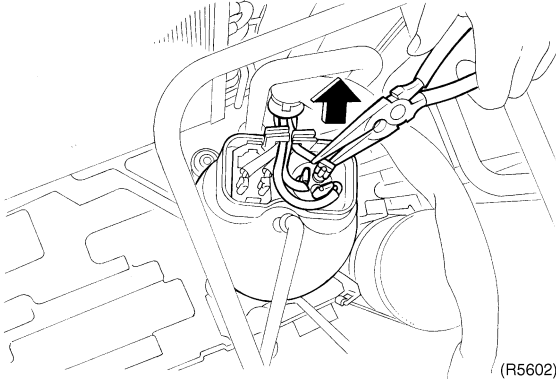
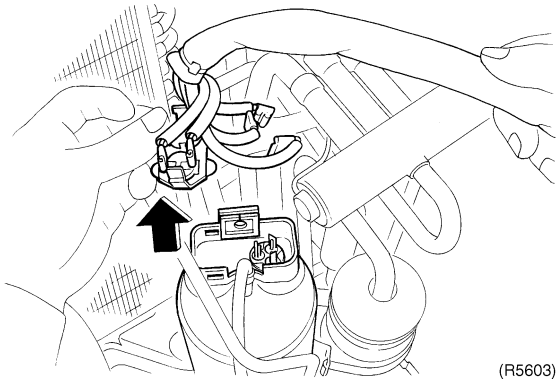
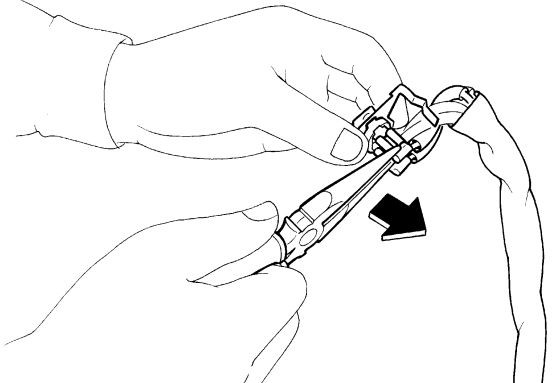

**Warning** Be sure to wait 10 minutes or more after turning off all power supplies before disassembling work.

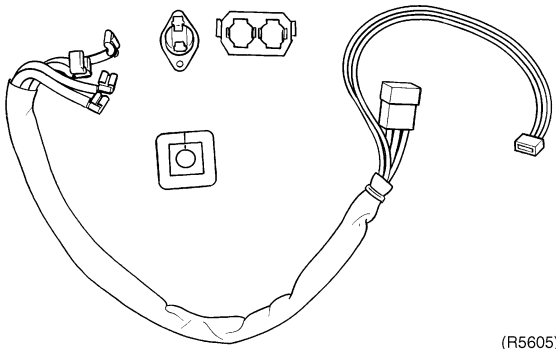
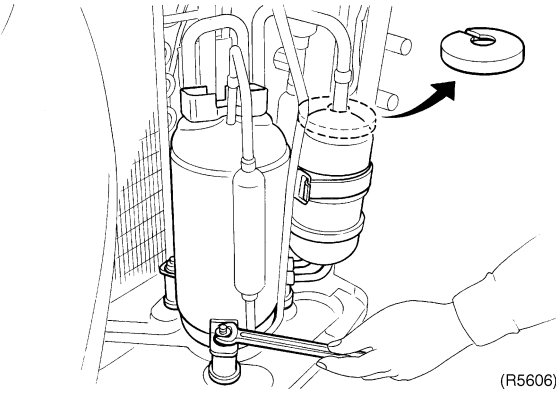
Step	Procedure	Points
1. Remove the terminal cover		Make a note.
1	Remove the terminal cover.	<ul style="list-style-type: none"> <li>■ Be careful not to burn the compressor terminals or the name plate.</li> </ul>
2	Disconnect the flag-shaped terminals.	<p><b>Warning</b> Since it may happen that refrigeration oil in the compressor will catch fire, prepare wet cloth so as to extinguish fire immediately.</p>
3	Detach the compressor lead wire.	<p><b>Warning</b> Ventilate when refrigerant leaks during the work. (If refrigerant contacts fire, it will cause to arise toxic gas.)</p>
4	Detach the overload protector.	<p><b>Caution</b> Be careful not to get yourself burnt with the pipes and other parts that are heated by the gas welding rod.</p>
	 <p>(R5601)</p>  <p>(R5602)</p>  <p>(R5603)</p>  <p>(R5604)</p>	

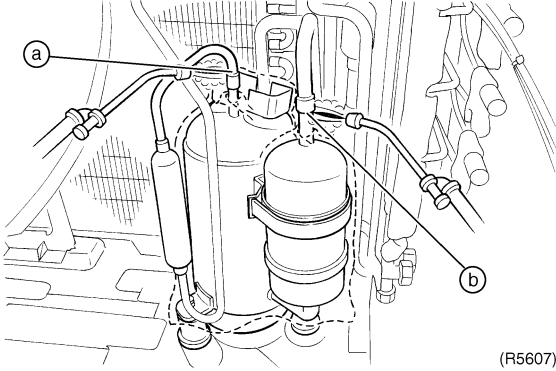
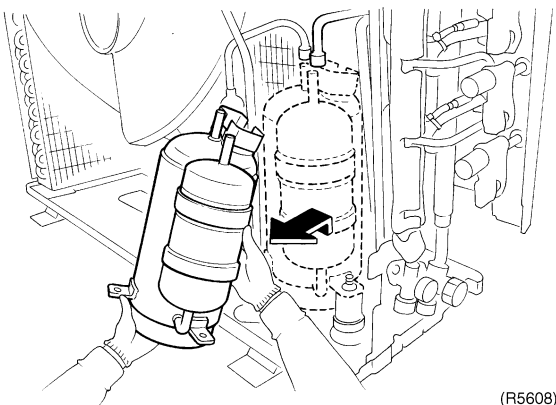
Step	Procedure	Points
<p>5 Remove the 2 sheets of putty.</p> <p>6 There is one nut fixing the compressor. Remove the nut with an open-end spanner.</p>	 <p>(R5605)</p>  <p>(R5606)</p>	<p><b>Warning</b>   Ventilate when refrigerant leaks during the work.                  (If refrigerant contacts fire, it will cause to arise toxic gas.)</p>
<p>■ Before working, make sure that the refrigerant is empty in the circuit.</p>		
<p>■ Be sure to apply nitrogen replacement when heating up the brazed part.</p>		
<p>7 Heat up the brazed part of the discharge side and disconnect (part "a").</p> <p>8 Heat up the brazed part of the suction side and disconnect (part "b").</p>	 <p>(R5607)</p>	
<p>9 Lift the compressor up to remove.</p>	 <p>(R5608)</p>	

## 2. Outdoor Unit – E Series (68 / 71 / 75 Class), D Series

### 2.1 Removal of the Outer Panels

**Procedure**



**Warning**

Be sure to wait 10 minutes or more after turning off all power supplies before disassembling work.

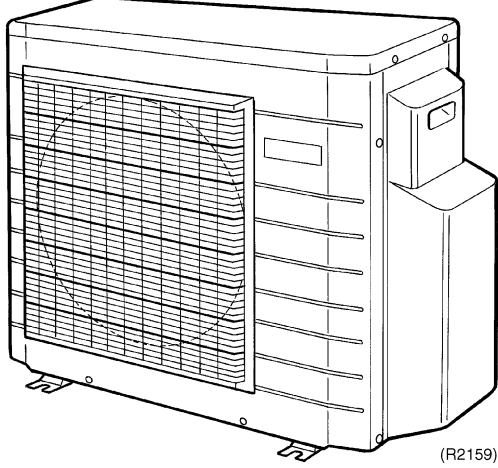
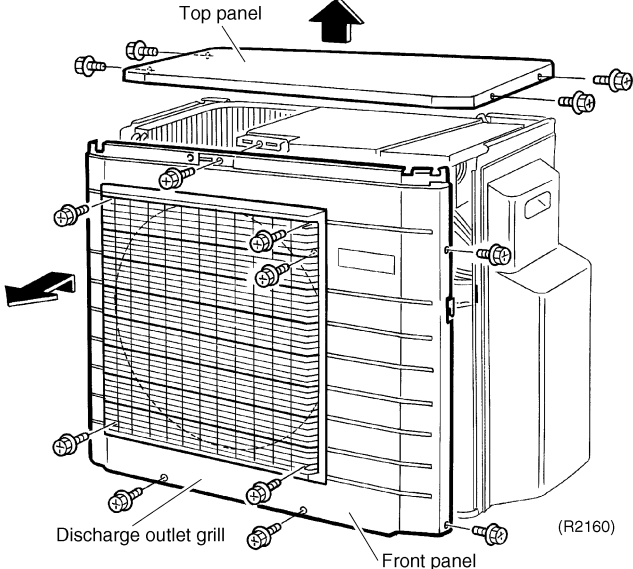
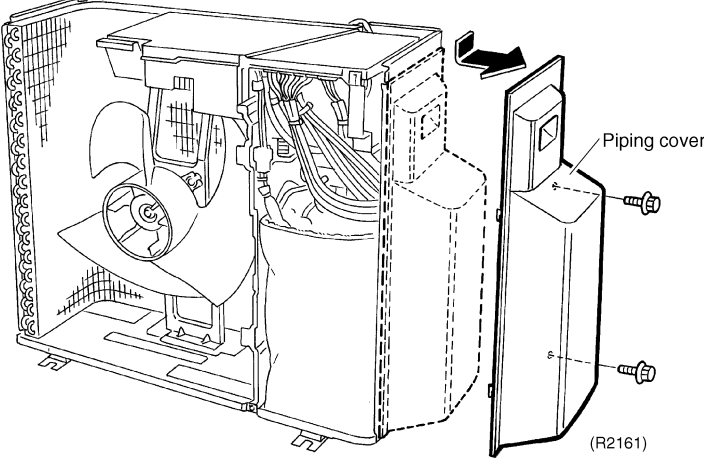
Step	Procedure	Procedure	Points
1	External appearance.	 <p>(R2159)</p>	
2	Remove 4 screws of the top panel and 6 screws of the front panel.	 <p>(R2160)</p>	
3	Remove 4 screws of the discharge outlet grill.		
4	Remove 2 screws of the piping cover.	 <p>(R2161)</p>	

## 2.2 Removal of the Electrical BOX

**Procedure**



**Warning**

Be sure to wait 10 minutes or more after turning off all power supplies before disassembling work.

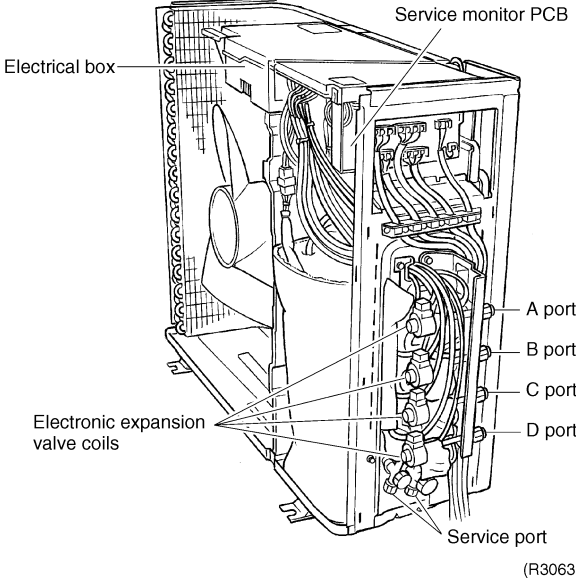
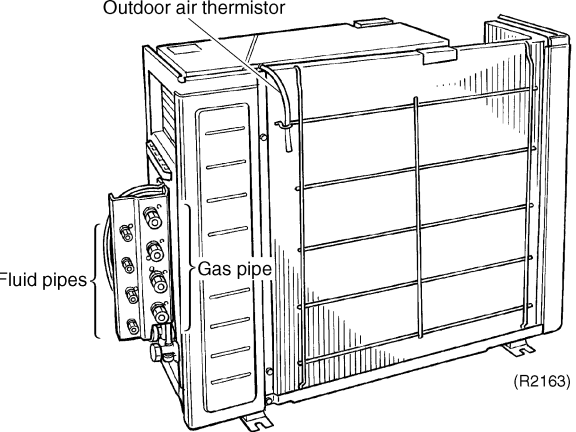
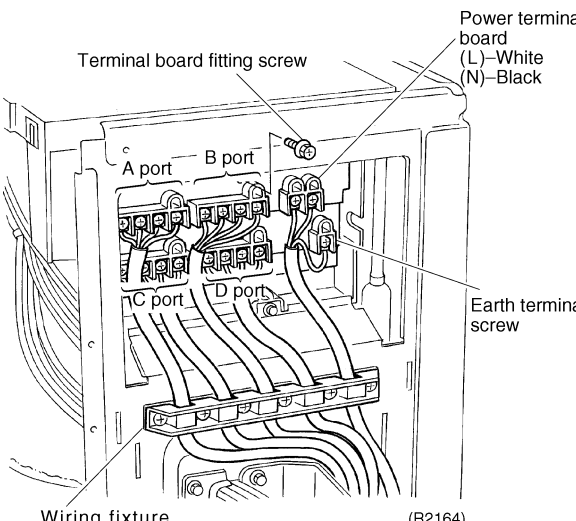
Step	Procedure	Points
1.	Removing the tie wires	
1	<p>The figure shows the tie pipe connections.</p>  	<ul style="list-style-type: none"> <li>■ Remove the piping in the backward direction.</li> </ul>
2	<p>Remove the terminal board fitting screw.</p> 	<ul style="list-style-type: none"> <li>■ Match the colours of the tie wires to A, B, C and D ports as follows.                             <ul style="list-style-type: none"> <li>(1) - Black Power</li> <li>(2) - White Power</li> <li>(3) - Red Transmission</li> </ul> </li> <li>■ Wires are fixed to the terminal board with screws.</li> <li>■ Terminal board is made of integral moulded resin.</li> </ul>

Step	Procedure	Points															
3	Pull out the terminal board to open.	<ul style="list-style-type: none"> <li>■ Glass tube fuse and varistor cannot be replaced individually because lead-free soldering is provided.</li> </ul>															
2. Remove each wire harness		<table border="1"> <thead> <tr> <th>Connector</th> <th>Electronic expansion valve No.</th> <th>Harness length</th> </tr> </thead> <tbody> <tr> <td>S20 (White)</td> <td>EVA</td> <td>630</td> </tr> <tr> <td>S21 (Red)</td> <td>EVB</td> <td>730</td> </tr> <tr> <td>S22 (Blue)</td> <td>EVC</td> <td>825</td> </tr> <tr> <td>S23 (Yellow)</td> <td>EVD</td> <td>940</td> </tr> </tbody> </table>	Connector	Electronic expansion valve No.	Harness length	S20 (White)	EVA	630	S21 (Red)	EVB	730	S22 (Blue)	EVC	825	S23 (Yellow)	EVD	940
Connector	Electronic expansion valve No.	Harness length															
S20 (White)	EVA	630															
S21 (Red)	EVB	730															
S22 (Blue)	EVC	825															
S23 (Yellow)	EVD	940															
1	Disconnect 4 connectors of the electronic expansion valve lead wires.	<ul style="list-style-type: none"> <li>■ When reconnecting, make sure to match the wire to the correct connector.</li> </ul>															
2	Remove the four way valve connector S80.	<p>S40: Overload relay                      S90: Thermistor                      (Outdoor air, heat exchanger, discharge pipe)                      S92: Gas pipe thermistor                      S93: Liquid pipe thermistor</p>															
3	Disconnect the thermistor connector and the overload relay connector.																

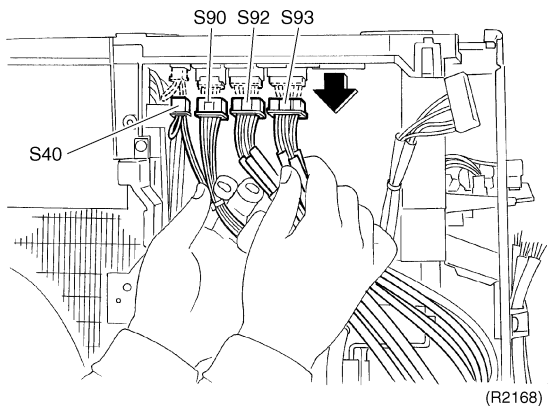
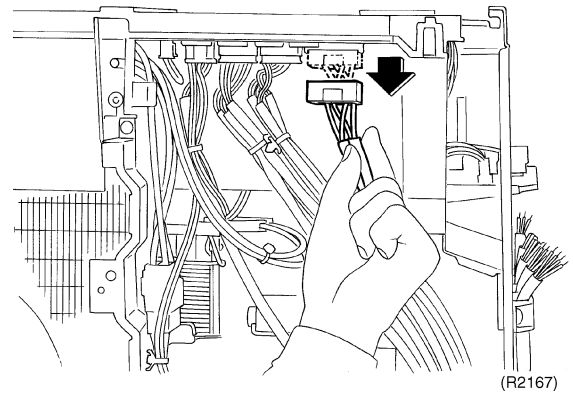
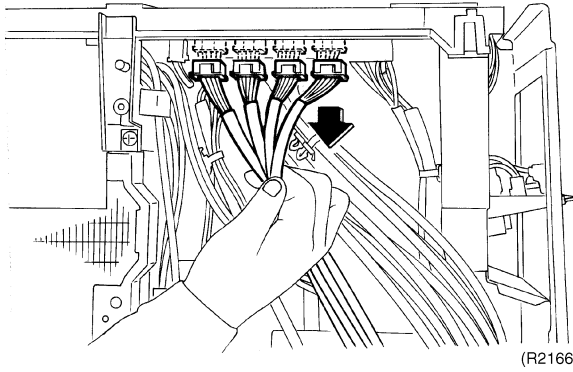
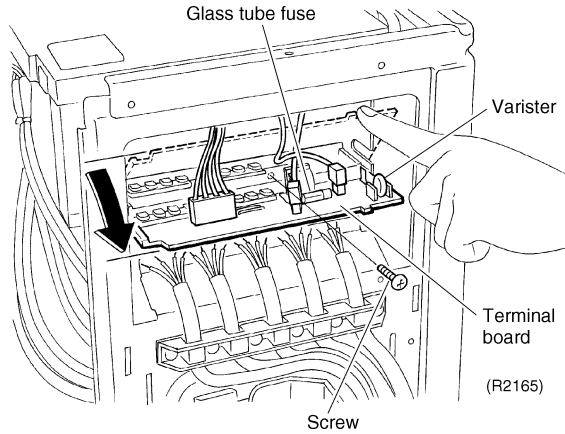

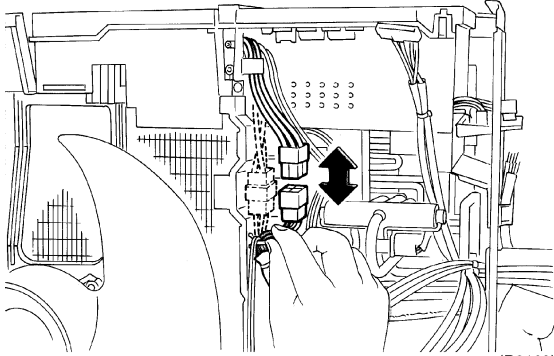
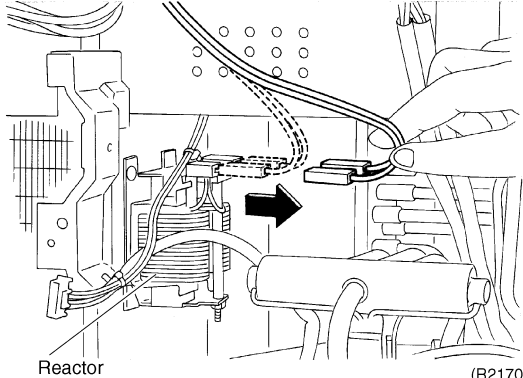
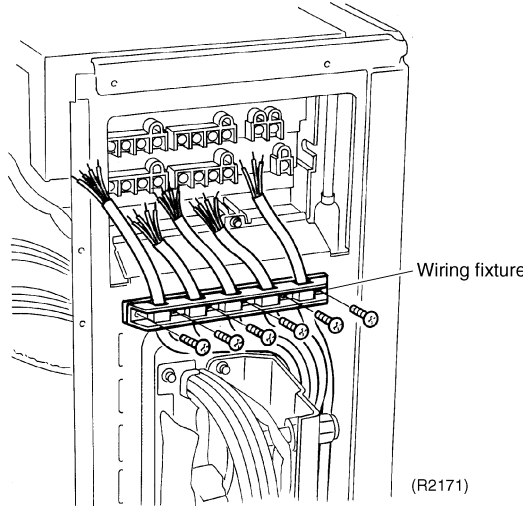
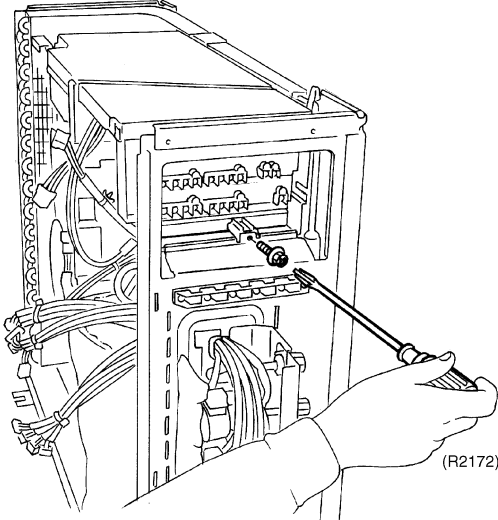
Step	Procedure	Points
4	<p>Disconnect the compressor relay connector.</p>  <p>(R2169)</p>	
5	<p>Remove the reactor lead wire.</p>  <p>Reactor</p> <p>(R2170)</p>	
3. Removing the wiring fixture	<p>1 Remove 6 screws of the wiring fixture.</p>  <p>Wiring fixture</p> <p>(R2171)</p>	
4. Removing the electrical box.	<p>1 Remove one screw of the electrical box.</p>  <p>(R2172)</p>	

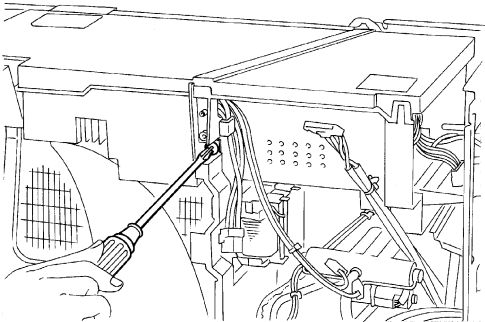
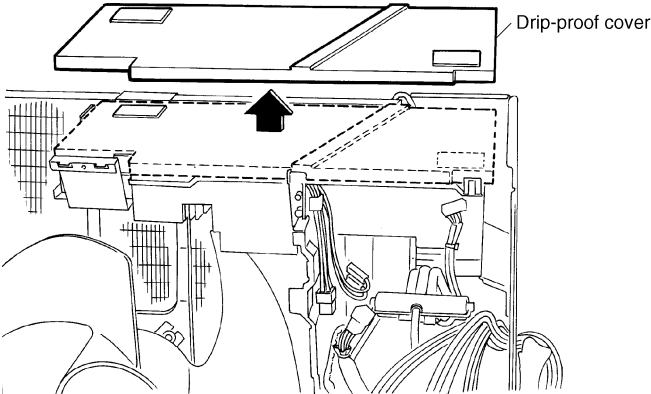
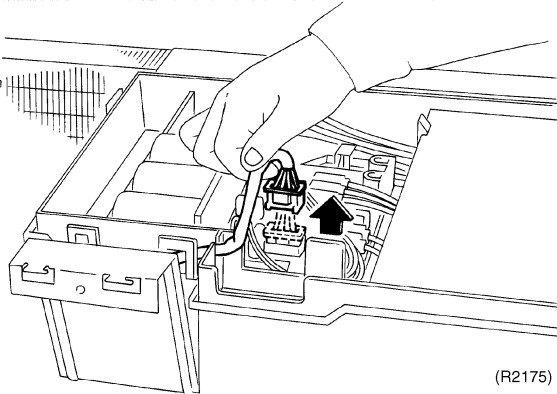
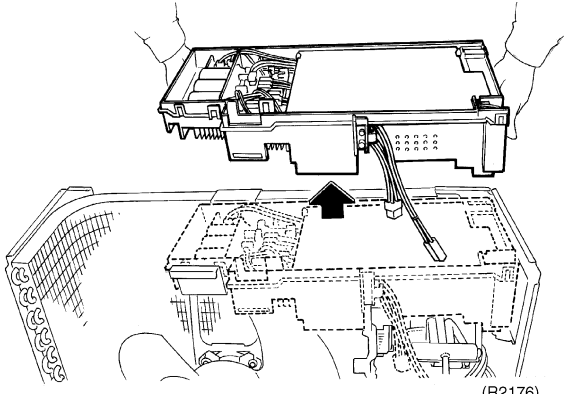
Step	Procedure	Procedure	Points
2	Remove the screw of the electrical box.	 <p>(R2173)</p>	
3	Remove the drip-proof cover.	 <p>Drip-proof cover</p> <p>(R2174)</p>	
4	Disconnect the fan motor lead wire.	 <p>(R2175)</p>	
5	Lift up the electrical box and dismount it.	 <p>(R2176)</p>	



## 2.3 Removal of the PCB

**Procedure**



**Warning**

Be sure to wait 10 minutes or more after turning off all power supplies before disassembling work.

Step	Procedure	Points
<p>1. Removing the controller PCB</p>	<p>(R2177)</p>	
<p>1 Remove the screw of the PCB, and release 2 tabs.</p>	<p>(R2178)</p>	
<p>2 Release the tabs of the terminal board, and open the terminal board.</p>	<p>(R2179)</p>	
<p>3 Disconnect each connector on the back of the terminal board.</p>	<p>(R2180)</p>	<p>■ Release the tab to remove the service monitor PCB.</p>
<p>4 Disconnect the <b>service monitor PCB</b> connector.</p>		

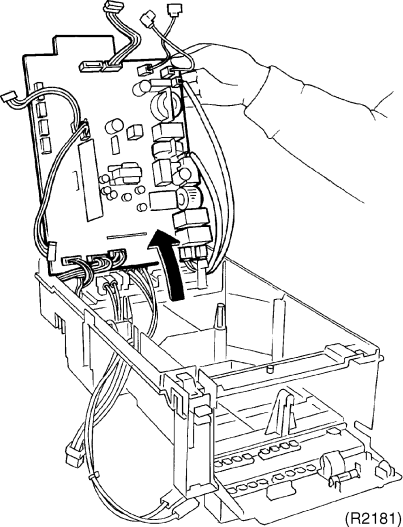
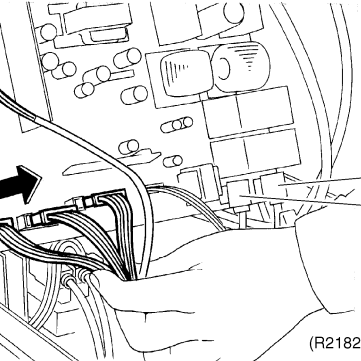
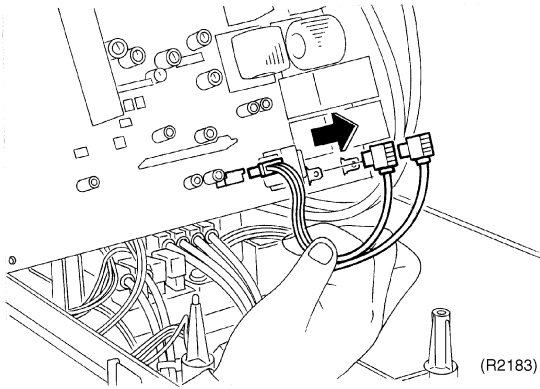
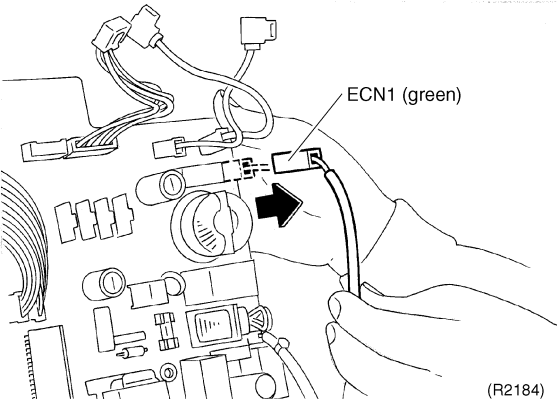
Step	Procedure	Procedure	Points
5	Lift up the control PCB.	 <p>(R2181)</p>	
6	Disconnect each wire harness connector linked to the control PCB. S31 (Pin 9): To CN14 S32 (Pin 5): To CN11 S33 (Pin 10): To S34 S71 (Pin 8): To S72	 <p>(R2182)</p>  <p>(R2183)</p>  <p>(R2184)</p>	

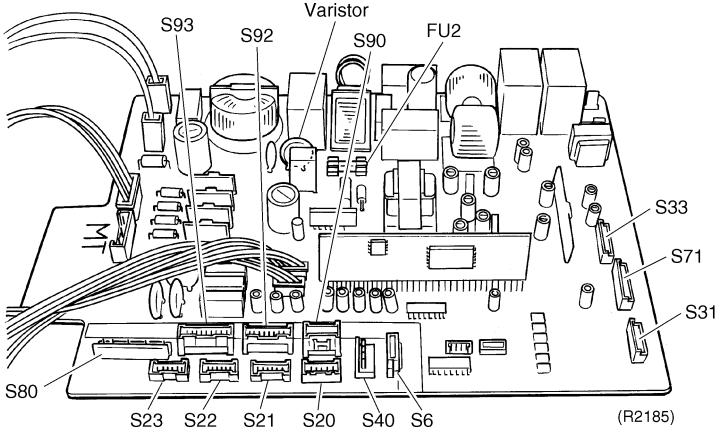
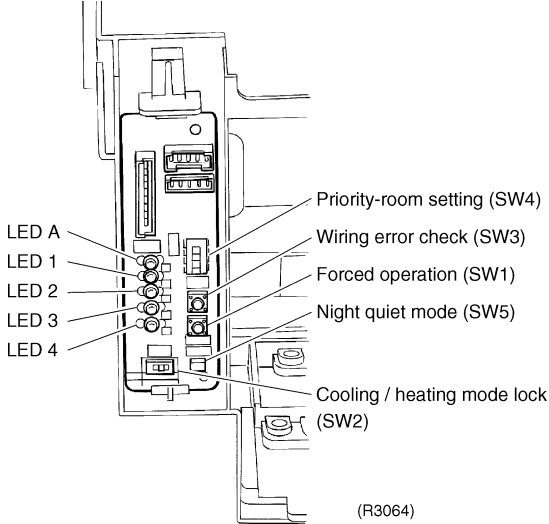
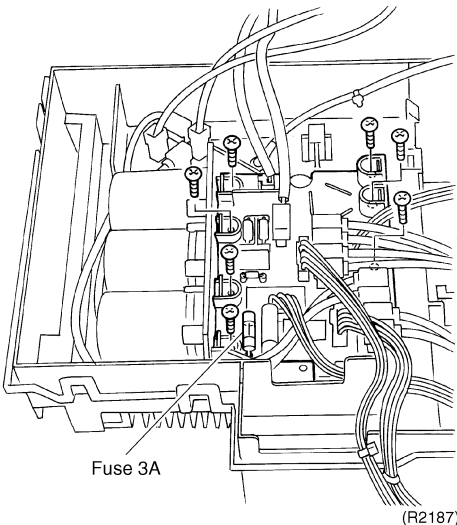
Step	Procedure	Points
7	<p>The figure shows the control PCB.</p> 	<p>■ Glass tube fuse 3A</p>
<p>2. Removing the <b>service monitor PCB</b></p>		
1	<p>The figure shows the service monitor PCB.</p> 	
<p>3. Removing the <b>inverter PCB</b>.</p>		
1	<p>Remove the 7 screws of the inverter PCB.</p> 	

## 2.4 Removal of the Fan Motor

**Procedure**



**Warning** Be sure to wait 10 minutes or more after turning off all power supplies before disassembling work.

Step	Procedure	Points
<ul style="list-style-type: none"> <li>■ Remove the fan motor lead wire connector.</li> </ul>		
<p>1 Remove the propeller fan by removing the washer-fitted nut.</p>	<p style="text-align: center;">Washer-fitted nut</p> <p style="text-align: right;">(R2188)</p>	<ul style="list-style-type: none"> <li>■ For reassembling, align mark of propeller fan with D-cut section of motor shaft.</li> <li>■ Mount the propeller fan while positioning ● mark to the top.</li> </ul>
<p>2 Remove the fan motor. Remove the screw of the fan motor mount.</p>	<p style="text-align: right;">(R2189)</p>	<ul style="list-style-type: none"> <li>■ When reassembling, fix the lead wire to avoid contact with the propeller fan.</li> </ul>
<p>3 Disconnect the lead wire by releasing the 2 clamps fixing the wire. Remove 4 screws of the fan motor.</p>	<p>(Backside)</p> <p style="text-align: right;">(R2190)</p>	

## 2.5 Removal of the Sound Blanket

**Procedure**



**Warning**

Be sure to wait 10 minutes or more after turning off all power supplies before disassembling work.

Step	Procedure	Procedure	Points
1	Remove 5 screws of the right side panel.		
2	Remove 2 screws of the partition board, and remove the board.		
3	Remove the sound blanket (top, outer and inner).		<p>■ Carefully remove the sound blanket, which is easily torn in the piping section.</p>

## 2.6 Removal of the Four Way Valve Coil, Solenoid Valve Coil, Electronic Expansion Valve Coil and Thermistor

**Procedure**



**Warning**

Be sure to wait 10 minutes or more after turning off all power supplies before disassembling work.

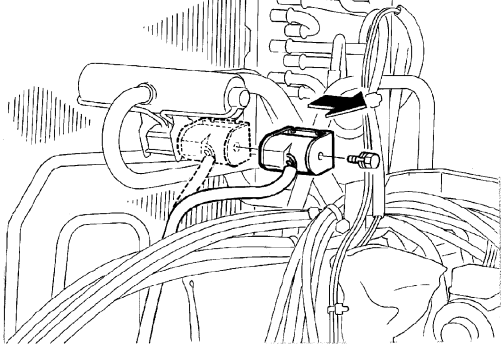
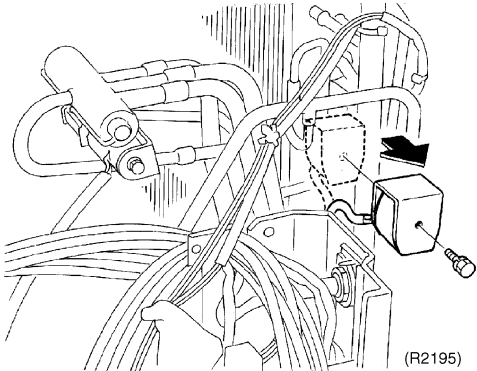
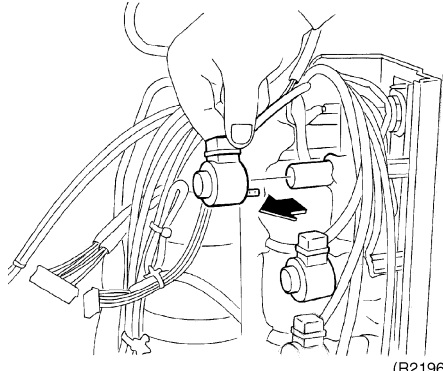
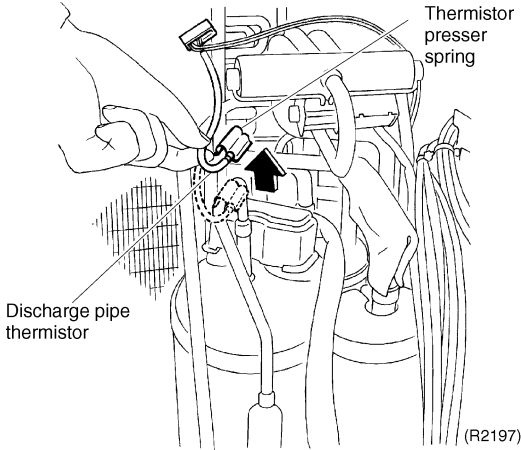
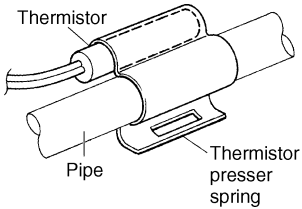
Step	Procedure	Procedure	Points
1	Remove the screw of the four way valve coil.	 <p style="text-align: right;">(R2194)</p>	
2	Remove the screw of the solenoid valve coil.	 <p style="text-align: right;">(R2195)</p>	
3	Remove the electronic expansion valve coil for each room.	 <p style="text-align: right;">(R2196)</p>	
4	Release the thermistor presser spring, and remove the discharge pipe thermistor.	 <p style="text-align: right;">(R2197)</p>	<ul style="list-style-type: none"> <li>■ Place the thermistor so that its end comes up to the end of the presser spring.</li> <li>■ Be careful not to lose the presser spring for the discharge pipe thermistor.</li> </ul> 

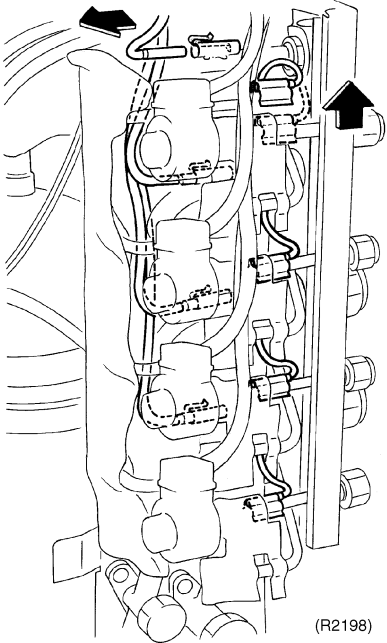
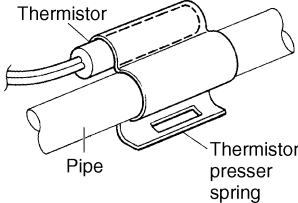
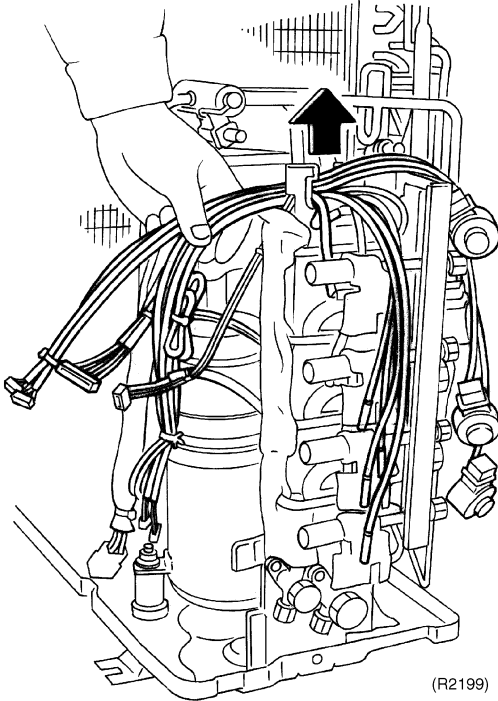
Step	Procedure	Points	
5	Take off the putty, and remove each thermistor.	 <p>(R2198)</p>	<ul style="list-style-type: none"> <li>■ Place the thermistor so that its end comes up to the end of the presser spring.</li> <li>■ Be careful not to lose the presser spring for the discharge pipe thermistor.</li> </ul>  <p>Thermistor Pipe Thermistor presser spring</p>
6	Remove the wire harness.	 <p>(R2199)</p>	<p><b>S90:</b></p> <ul style="list-style-type: none"> <li>■ Outdoor air thermistor (Blue)</li> <li>■ Heat exchanger thermistor (Gray)</li> <li>■ Discharge pipe thermistor (Black)</li> </ul> <p><b>S92: Gas pipe thermistor</b></p> <ul style="list-style-type: none"> <li>■ Room A (Black)</li> <li>■ Room B (Gray)</li> <li>■ Room C (Brown)</li> <li>■ Room D (Red)</li> </ul> <p><b>S93: Liquid pipe thermistor</b></p> <ul style="list-style-type: none"> <li>■ Room A (Black)</li> <li>■ Room B (Gray)</li> <li>■ Room C (Yellow)</li> <li>■ Room D (Blue)</li> </ul>

## 2.7 Removal of the Four Way Valve, Solenoid Valve and Shunt

### Procedure



### Warning

Be sure to wait 10 minutes or more after turning off all power supplies before disassembling work.

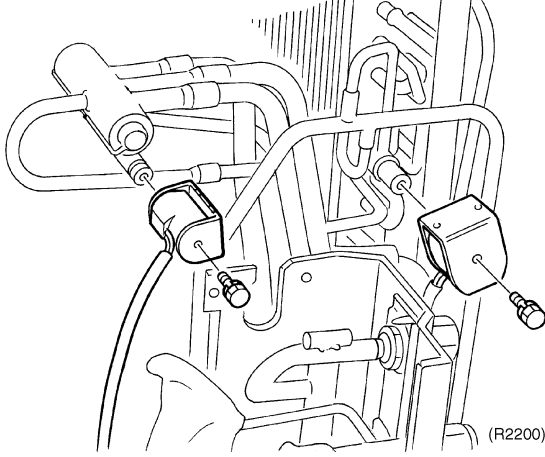
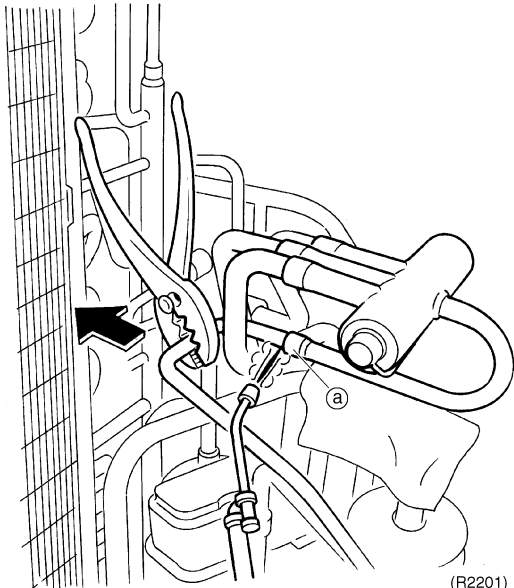
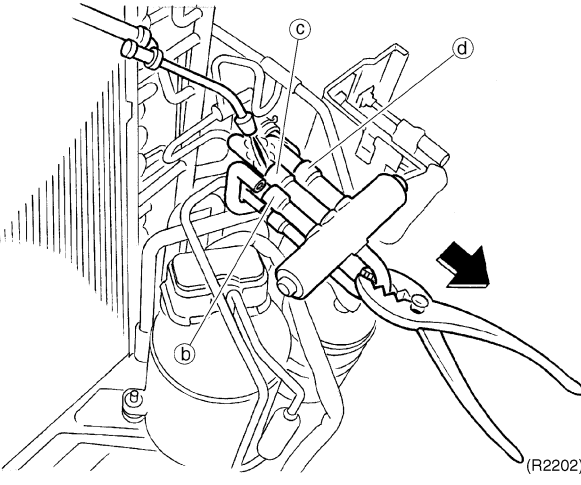
Step	Procedure	Procedure	Points	
1	Remove one screw of the four way valve coil.	 <p style="text-align: right;">(R2200)</p>	<p><b>Reassembling precautions</b></p> <ol style="list-style-type: none"> <li>1. Use non-oxidizing brazing method. If nitrogen gas is not available, braze the parts speedily.</li> <li>2. Avoid deterioration of the gaskets due to carbonization of oil inside the four way valve or thermal influence. For this purpose, wrap the four way valve with wet cloth. Splash water over the cloth against becoming too hot (keep it below 120°C).</li> </ol>	
2	Remove one screw of the solenoid valve coil.			
<p>■ Before taking this procedure, make sure there is no refrigerant gas left in the refrigerant pipes.</p>		 <p style="text-align: right;">(R2201)</p>	<p>■ In pulling the pipes, be careful not to over-tighten them with pliers. The pipes may get deformed.</p> <p>If the gas welding machine fails to remove the four way valve, take the steps below.</p> <ol style="list-style-type: none"> <li>1. Disconnect the brazed pipe sections that are readily easy to separate and join together later.</li> <li>2. With a small copper tube cutter, cut off the internal pipes to easily take out the four way valve.</li> </ol>	
3	Place welding protective sheet or iron plate around the four way valve to prevent the flames of a gas welding rod from affecting the valve.			
4	Heat the 4 brazed points of the four way valve. Disconnect the point (a) first.	 <p style="text-align: right;">(R2202)</p>	<p><b>Note:</b> Never use a hack saw. The sawdust may come into the circuit.</p>	
5	Disconnect the points (b) and (c).			
6	Disconnect the point (d).			



## 2.8 Removal of the Solenoid Valve and Shunt

**Procedure**



**Warning**

Be sure to wait 10 minutes or more after turning off all power supplies before disassembling work.

Step	Procedure	Points
<p>■ Before taking this procedure, make sure there is no refrigerant gas left in the refrigerant pipes.</p>		<p><b>Caution</b> Be careful not to get yourself burnt with the pipes and other parts that are heated by the gas welding rod.</p>
<p>1 Disconnect the 2 brazed points (a) and (b) in this order.</p>		<p><b>Warning</b> If refrigerant gas leaks during the job, ventilate the room. (Bear in mind that if the refrigerant gas is exposed to open flames, noxious gas may be generated.)</p>
<p>2 Remove the putty of the shunt.</p>		
<p>3 Disconnect the 5 brazed points of the shunt.</p>		<p><b>Reassembling precautions</b> Wrap the solenoid valve body with wet cloth. Splash water over the cloth before it is dried to prevent the valve from being overheated.</p>

## 2.9 Removal of the Compressor

### Procedure



### Warning

Be sure to wait 10 minutes or more after turning off all power supplies before disassembling work.

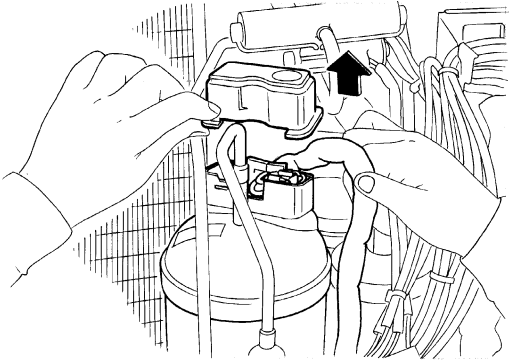
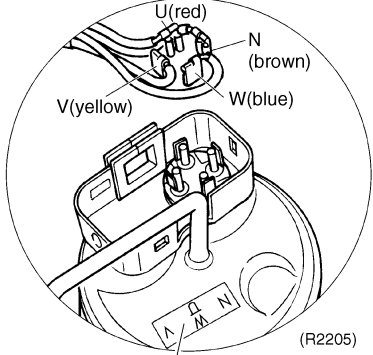
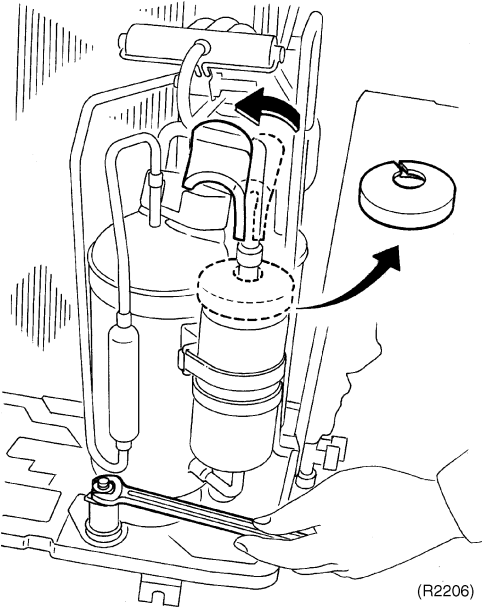
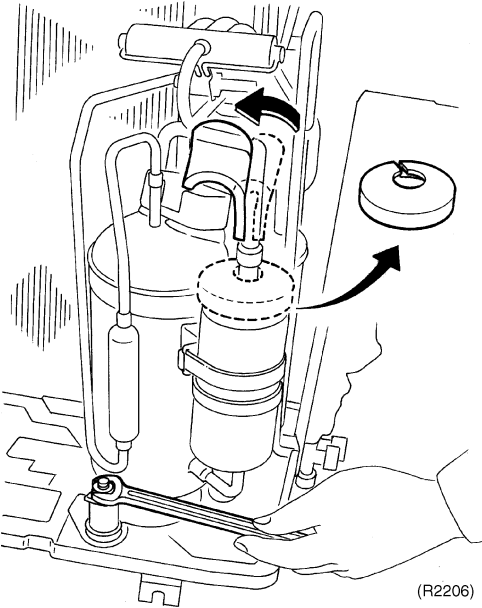
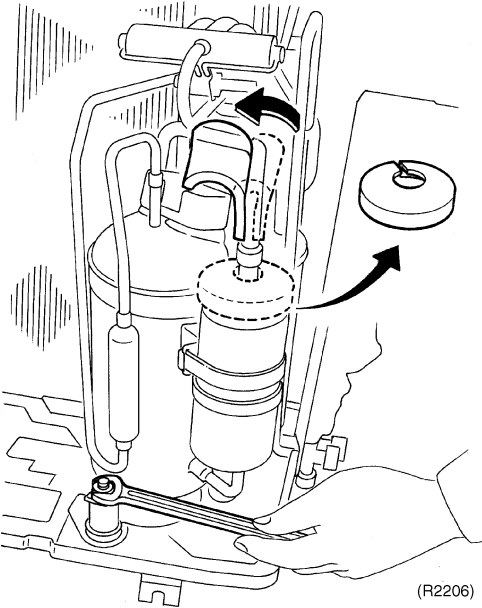
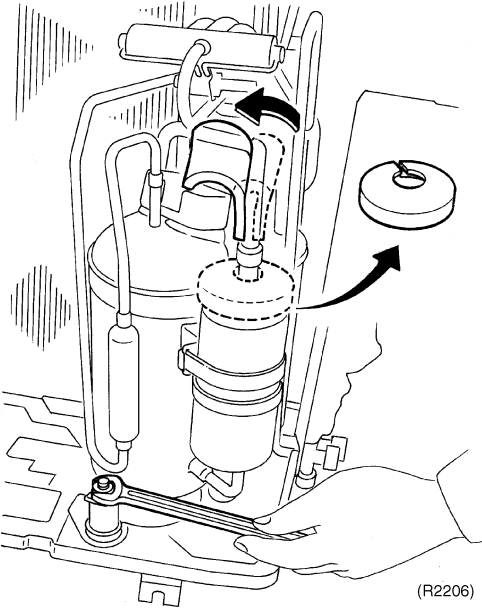
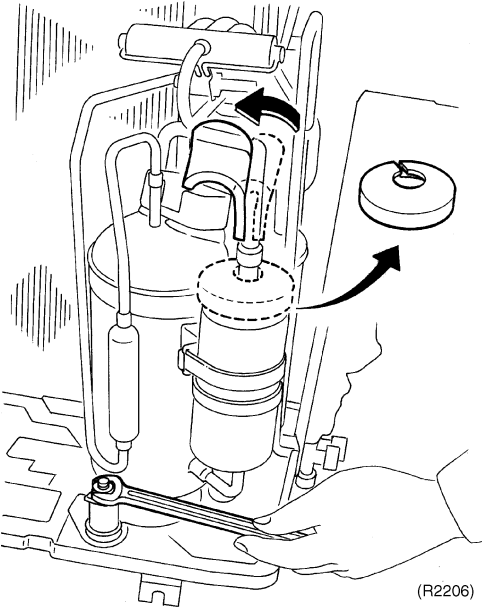
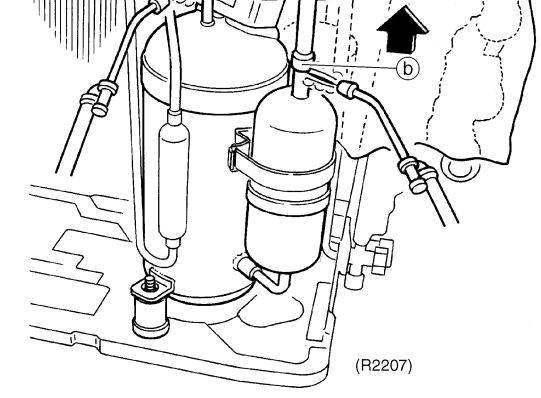
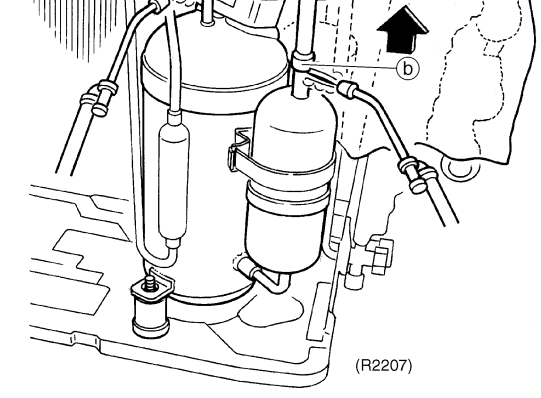
Step	Procedure	Procedure	Points
1	Remove the terminal cover.		 <p>Terminal nameplate (R2205)</p>
2	Disconnect the compressor lead wire.		<p>As precaution, keep the contents in memorandum.</p> <ul style="list-style-type: none"> <li>Be careful to avoid burning the compressor terminals or the nameplate.</li> </ul>
3	Remove the 2 sheets of putty.		<p>As precaution, keep the contents in memorandum.</p> <ul style="list-style-type: none"> <li>Be careful to avoid burning the compressor terminals or the nameplate.</li> </ul>
4	There is one nut fixing the compressor. Remove the nut with an open-end spanner.		<p>As precaution, keep the contents in memorandum.</p> <ul style="list-style-type: none"> <li>Be careful to avoid burning the compressor terminals or the nameplate.</li> </ul>
■	Make sure there is no refrigerant gas left inside the refrigerant pipes before starting the job.		<p>As precaution, keep the contents in memorandum.</p> <ul style="list-style-type: none"> <li>Be careful to avoid burning the compressor terminals or the nameplate.</li> </ul>
■	When heating up the brazed parts, make sure to carry out the N2 replacement.		<p>As precaution, keep the contents in memorandum.</p> <ul style="list-style-type: none"> <li>Be careful to avoid burning the compressor terminals or the nameplate.</li> </ul>
1	Disconnect the brazed part (a) at discharge side of the compressor.		<p><b>Warning</b> The compressor's refrigerating machine oil may catch fire. Have wet cloth at hand for quickly putting out the fire.</p> <p><b>Warning</b> If refrigerant gas leaks during the job, ventilate the room. (Bear in mind that if the refrigerant gas is exposed to open flames, noxious gas may be generated.)</p> <p><b>Caution</b> Be careful not to get yourself burnt with the pipes and other parts that are heated by the gas welding rod.</p>
2	Disconnect the brazed part (b) at suction side of the compressor.		<p><b>Warning</b> The compressor's refrigerating machine oil may catch fire. Have wet cloth at hand for quickly putting out the fire.</p> <p><b>Warning</b> If refrigerant gas leaks during the job, ventilate the room. (Bear in mind that if the refrigerant gas is exposed to open flames, noxious gas may be generated.)</p> <p><b>Caution</b> Be careful not to get yourself burnt with the pipes and other parts that are heated by the gas welding rod.</p>

# 3. Outdoor Unit – E Series (80 / 90 / 100 Class)

## 3.1 Removal of Outer Panels

**Procedure**



**Warning** Be sure to wait 10 minutes or more after turning off all power supplies before disassembling work.

Step	Procedure	Points
<p>External appearance from front side.</p>	<p style="text-align: right;">(R6368)</p>	<ul style="list-style-type: none"> <li>■ The illustrations can be different depending on the models.</li> </ul>
<p>1. Removing the suction grille.</p>	<p style="text-align: center;">Rear side</p> <p style="text-align: center;">Hooks</p> <p style="text-align: right;">(R6369)</p> <p style="text-align: center;">Suction grille</p> <p style="text-align: right;">(R6370)</p>	<ul style="list-style-type: none"> <li>■ The hooks are secured in the clearances of the heat exchanger fins.</li> </ul>

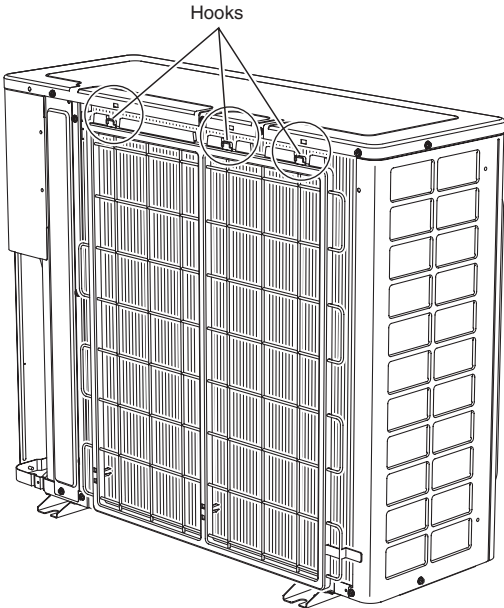
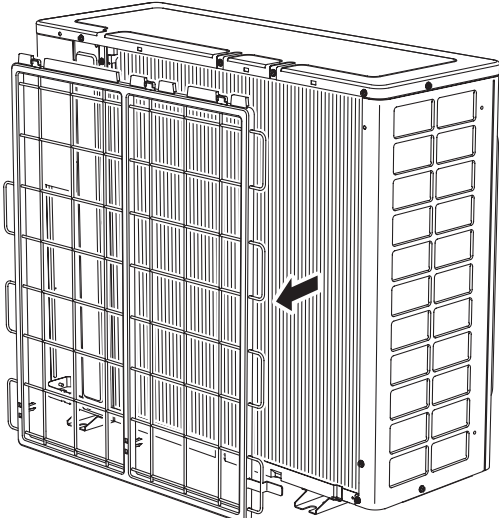
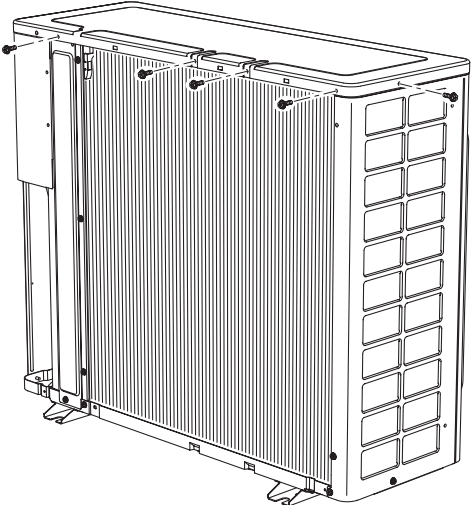
Step	Procedure	Procedure	Points
2	Next, slide the grille downward to undo the 3 top hooks.	 <p>(R6371)</p>	
3	Remove the suction grille.	 <p>(R6372)</p>	
2. Removing the top panel.			
1	Remove the 4 screws on the back and one screw on the left side panel.	 <p>(R6373)</p>	

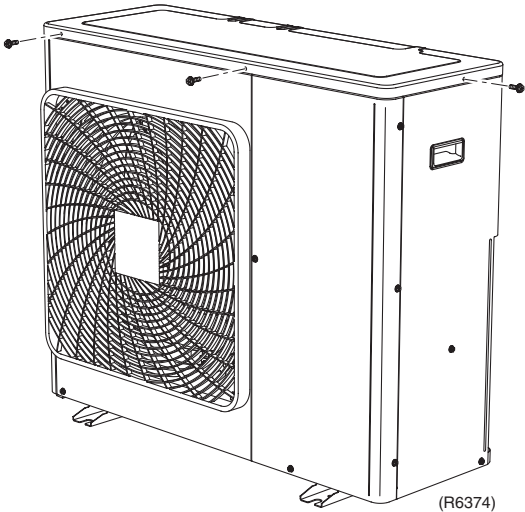
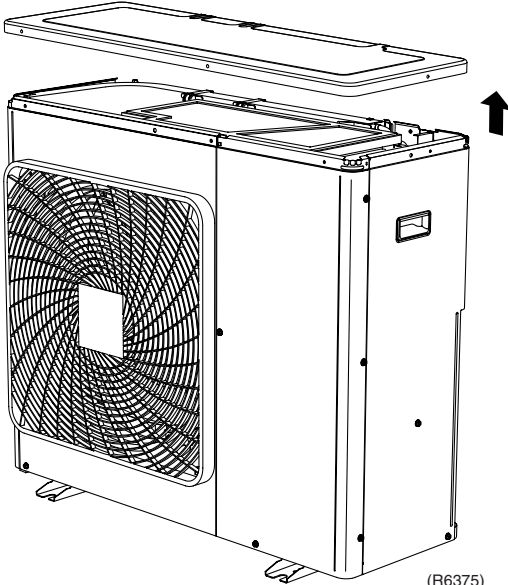
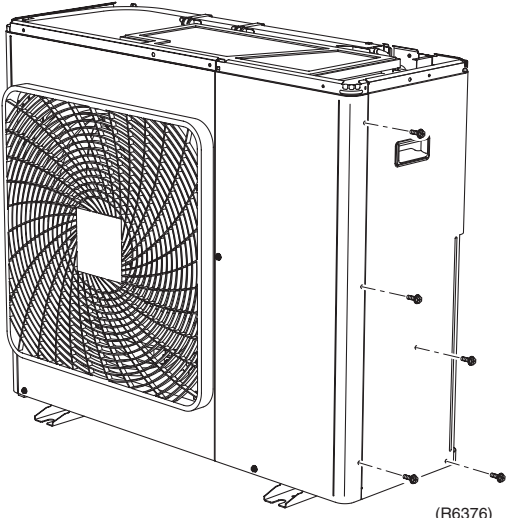
Step	Procedure	Points
2	<p>Remove the 2 screws on the front and one screw on the right side panel.</p>  <p>(R6374)</p>	
3	<p>Lift the top panel and remove it.</p>  <p>(R6375)</p>	
3. Removing the right side panel.	<p>1 Remove the 5 screws.</p>  <p>(R6376)</p>	

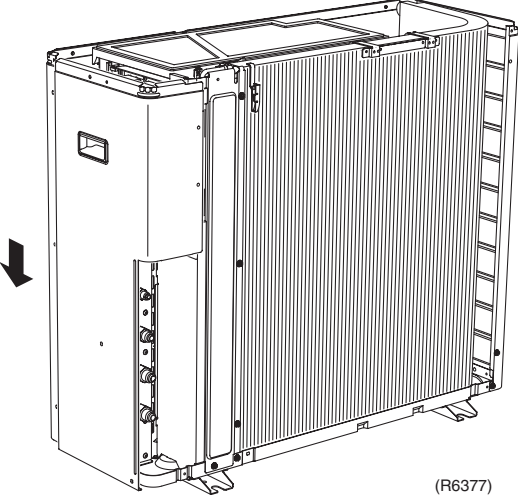
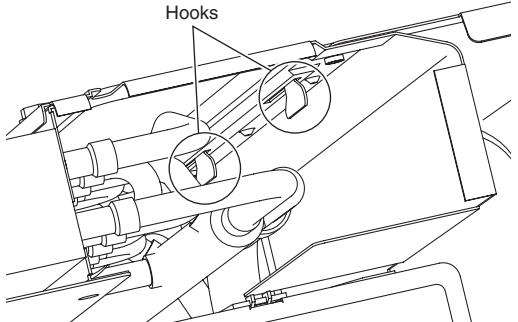
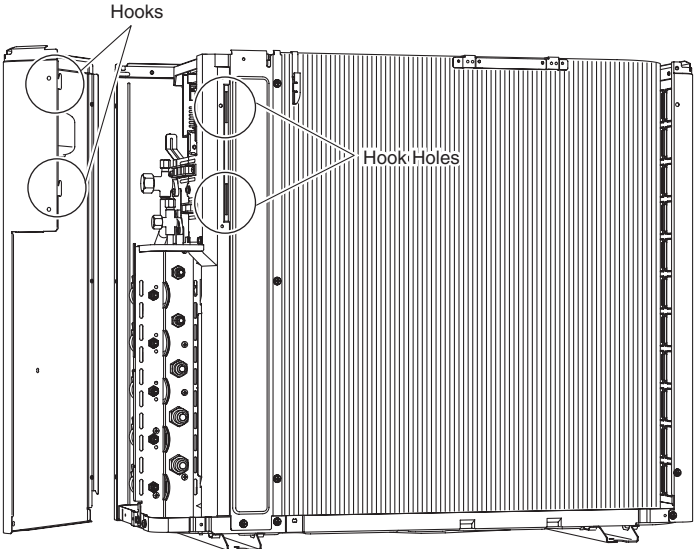
Step	Procedure	Points
<p>2</p> <p>Slide the panel downward to undo 2 hooks on the back side.</p>	 <p>(R6377)</p>  <p>Hooks</p> <p>(R6378)</p>  <p>Hooks</p> <p>Hook Holes</p> <p>(R6379)</p>	

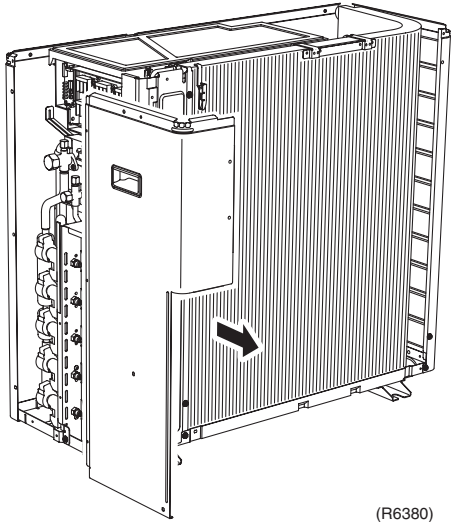
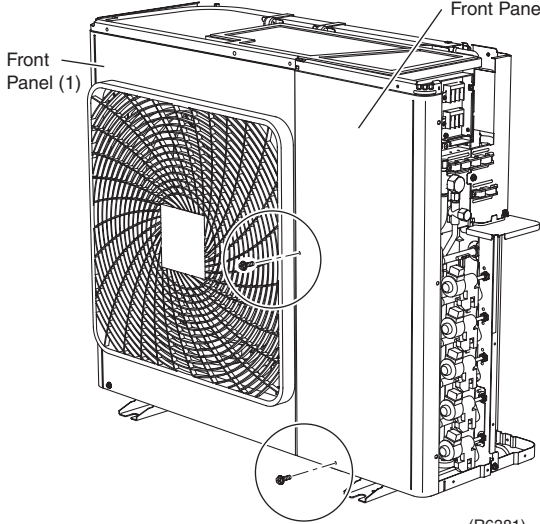
Step	Procedure	Points
3	<p>Remove the right side panel.</p>  <p>(R6380)</p>	
4.	<p>Removing the front panel (2)</p> <p>1 Remove the 2 screws.</p>  <p>(R6381)</p>	

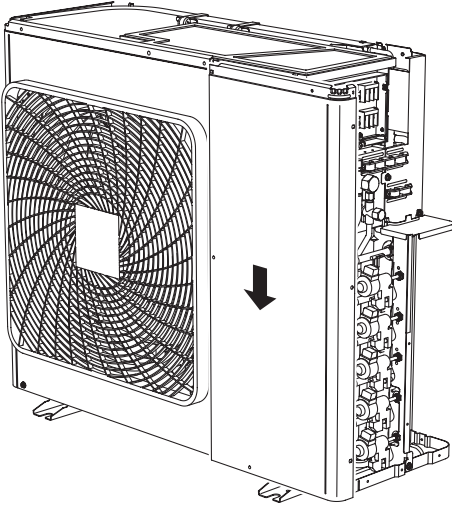
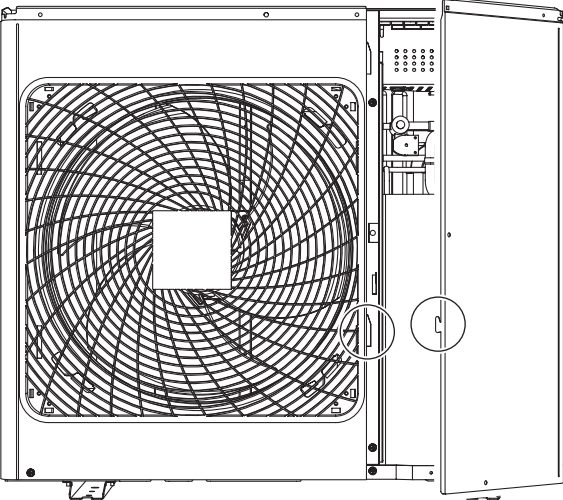
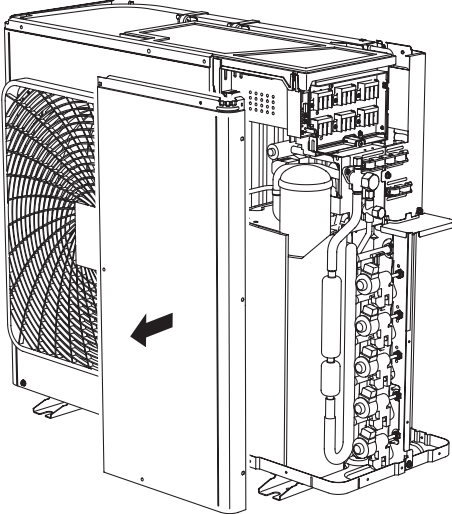
Step		Procedure	Points
2	Slide the panel downward to undo the hook.	 <p>(R6382)</p>  <p>(R6383)</p>	
3	Remove the front panel (2).	 <p>(R6384)</p>	

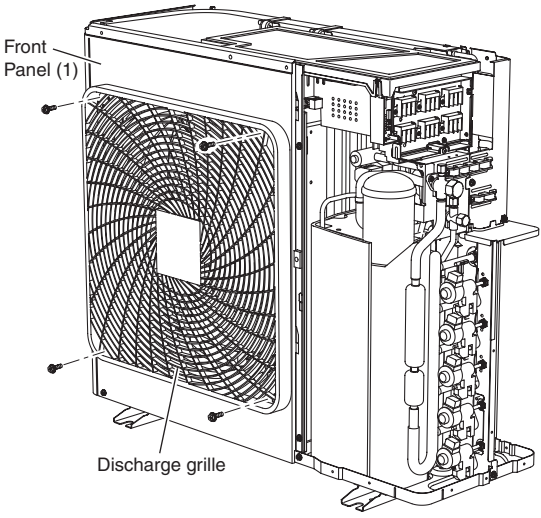
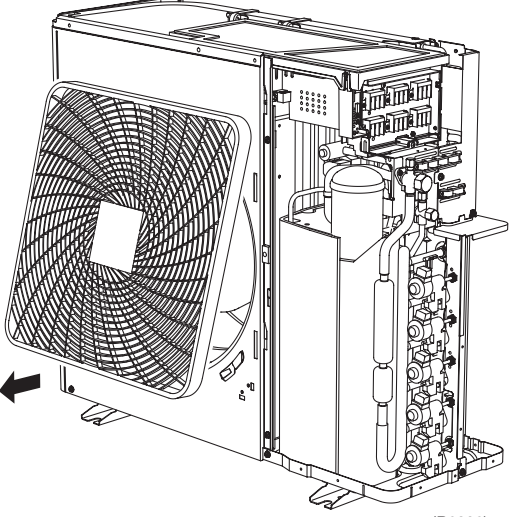

Step	Procedure	Points
5. Removing the front panel (1)		Remove the discharge grille and propeller fan first to remove the front panel (1).
1	<p>Remove the 4 screws on the discharge grille.</p>  <p>(R6385)</p>	
2	<p>Pull the bottom of the discharge grille toward yourself.</p>  <p>(R6386)</p>	

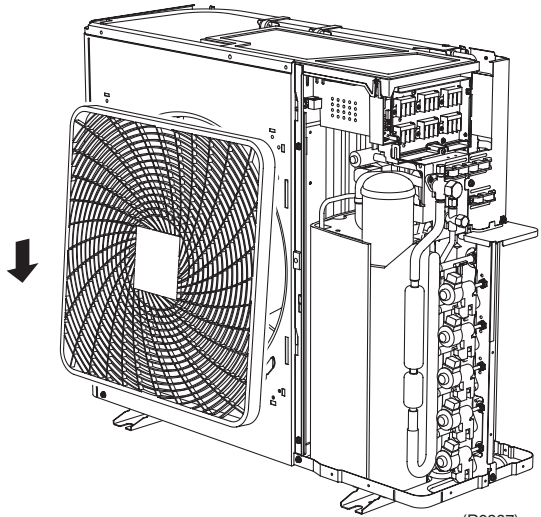
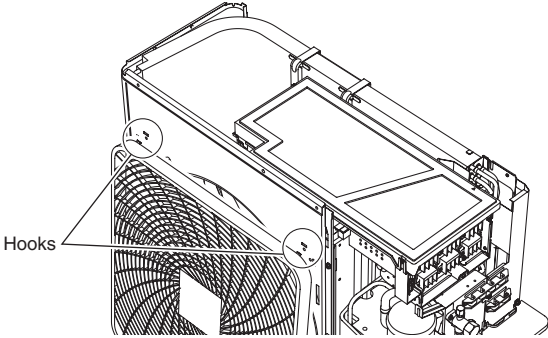
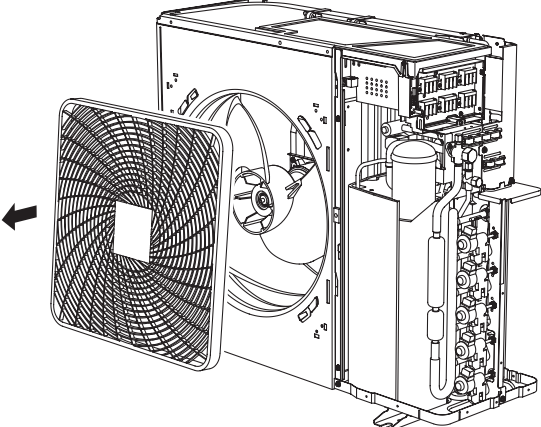
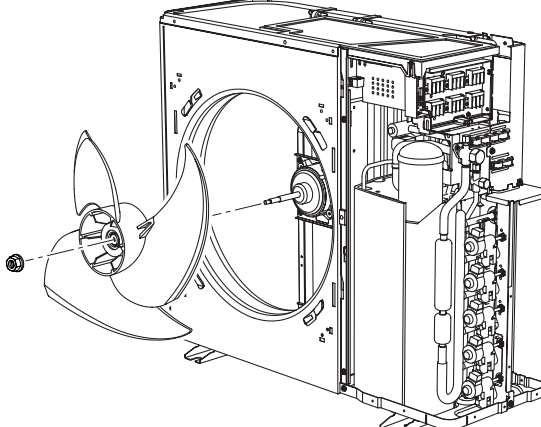
Step	Procedure	Procedure	Points
3	Next, slide the grille downward to undo the 2 hooks at the top.	 <p>(R6387)</p>  <p>Hooks</p> <p>(R6388)</p>	
4	Remove the discharge grille.	 <p>(R6389)</p>	
5	Remove the propeller fan fixing nut.	 <p>(R6390)</p>	Fan fixing nut : M8

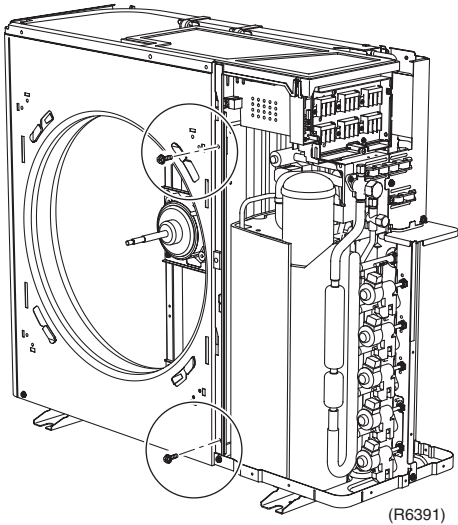
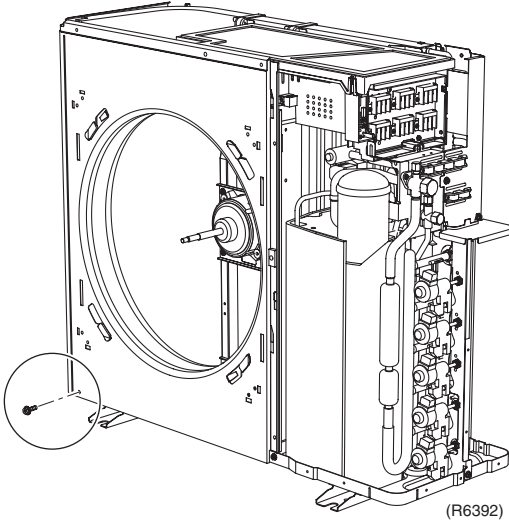
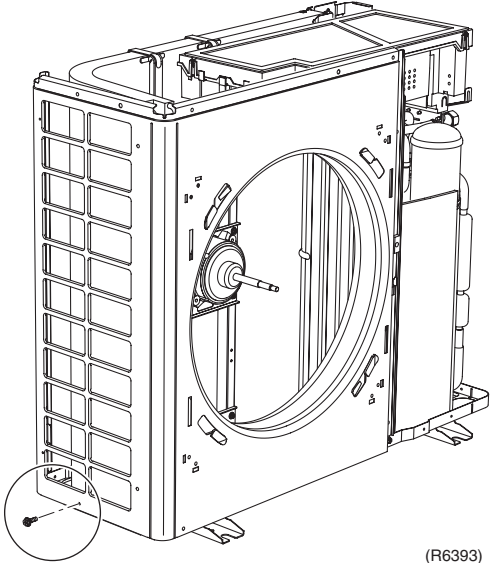
Step	Procedure	Points
6	Remove the 2 fixing screws on the partition plate.	
	 <p>(R6391)</p>	
7	Remove the screw at bottom left of the front.	
	 <p>(R6392)</p>	
8	Remove the screw at bottom of the left side.	
	 <p>(R6393)</p>	

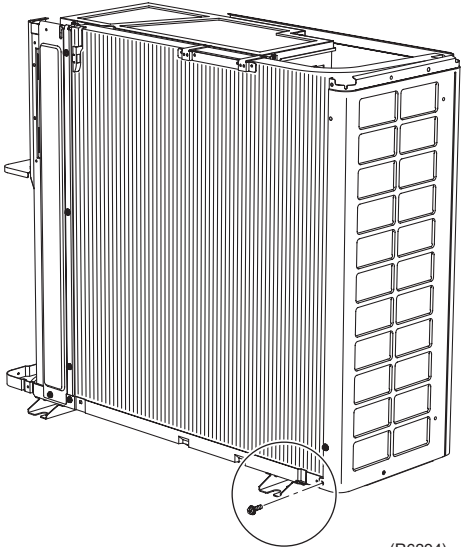
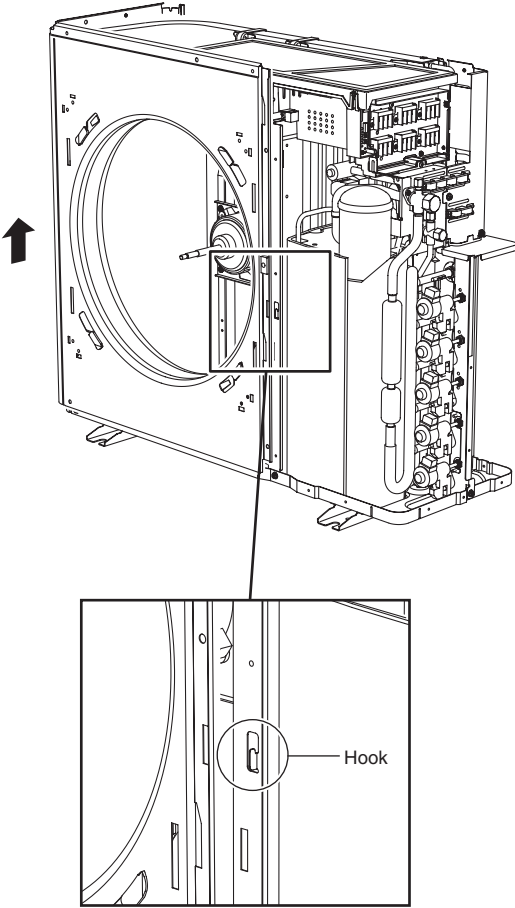
Step		Procedure	Points
9	Remove the screw at bottom of the back side.	 <p>(R6394)</p>	
10	The front panel (1) is provided with a hook on its front. Lift the front panel off position to remove it.	 <p>(R6395)</p>	

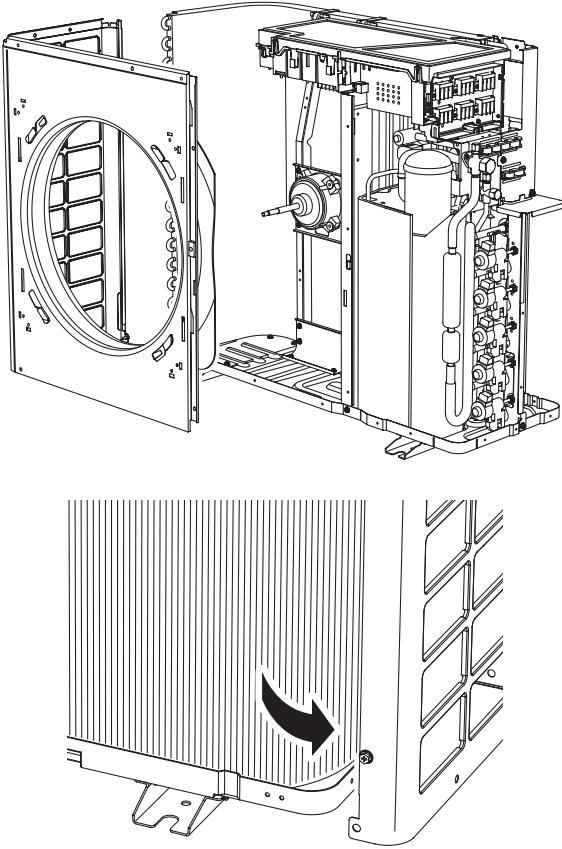
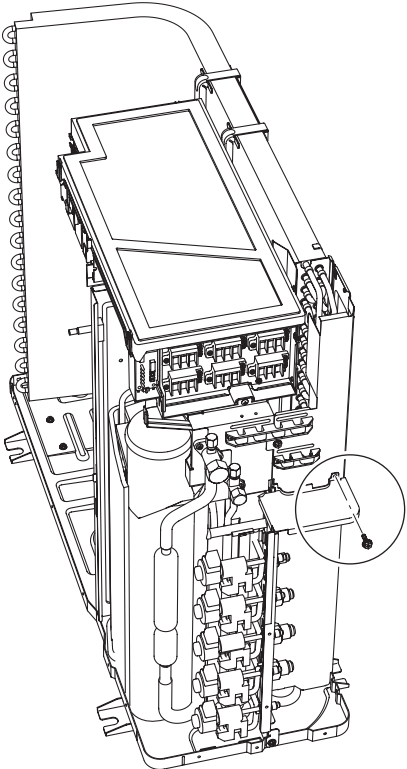
Step	Procedure	Points
11	<p data-bbox="199 215 464 277">Remove the front panel (1).</p>  <p data-bbox="1002 1095 1062 1115">(R6396)</p>	<ul style="list-style-type: none"> <li data-bbox="1093 745 1418 837">■ The back is a little complicated in shape. Be sure to detach carefully.</li> </ul>
6.	<p data-bbox="132 1140 453 1171">Removing the rear panel</p> <p data-bbox="153 1178 443 1272">1 Remove the fixing screw on the partition plate.</p>  <p data-bbox="940 1946 1000 1966">(R6397)</p>	

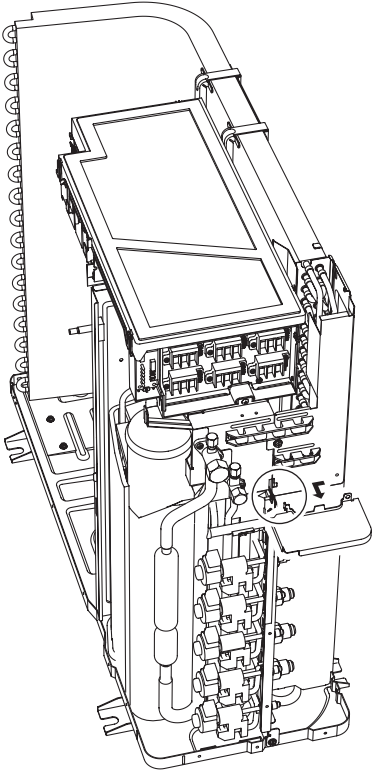
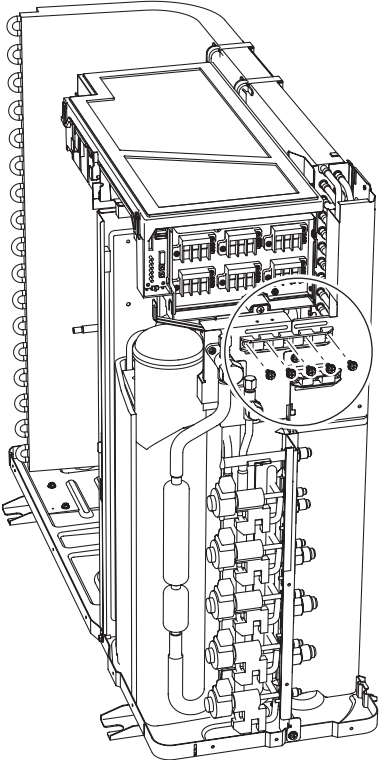
Step	Procedure	Points
2	<p>Slide the panel leftward to undo the hook, and remove the partition plate.</p>  <p>(R6398)</p>	
3	<p>Remove the 5 screws.</p>  <p>(R6399)</p>	

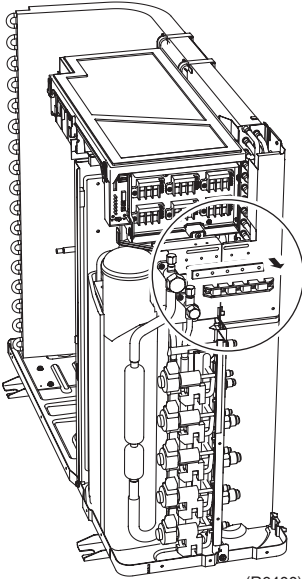
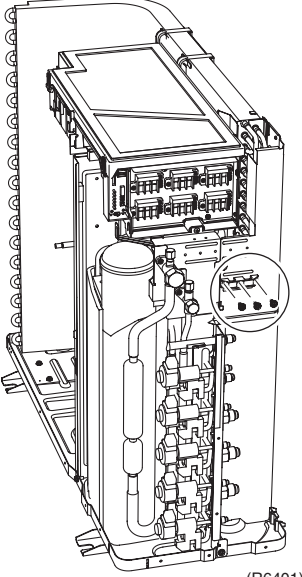
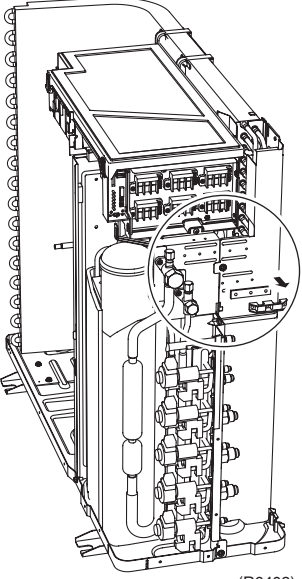
Step	Procedure	Points
4	Remove the wire fixing plate (upper).  <p>(R6400)</p>	
5	Remove the 3 screws.  <p>(R6401)</p>	
6	Remove the wire fixing plate (lower).  <p>(R6402)</p>	

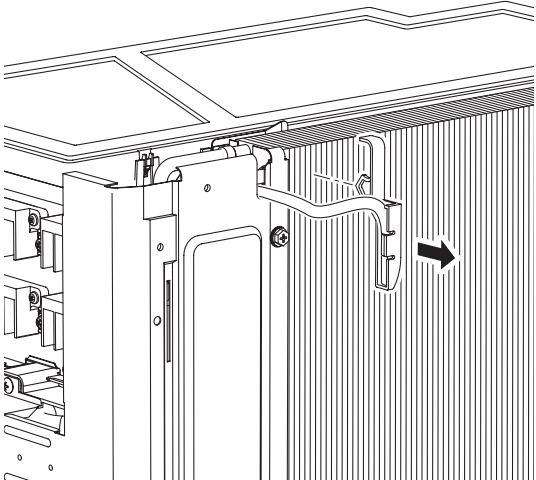
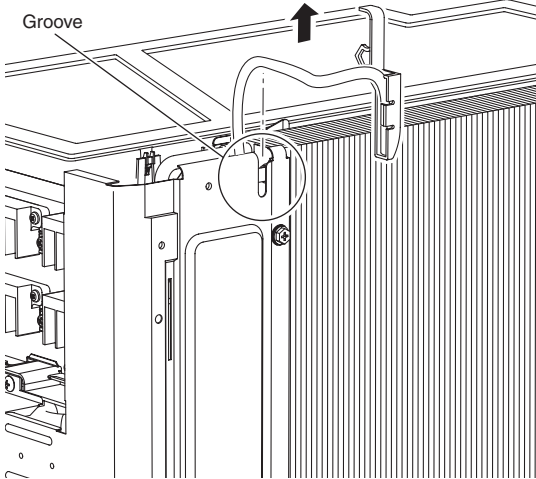
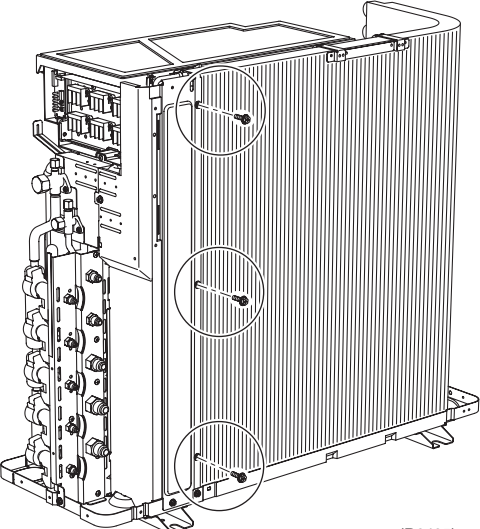
Step	Procedure	Points
7	<p data-bbox="199 215 454 275">Undo the holder of the thermistor.</p>  <p data-bbox="991 752 1050 772">(R6403)</p>  <p data-bbox="991 1323 1050 1344">(R6404)</p>	<ul style="list-style-type: none"> <li data-bbox="1093 215 1457 309">■ The holder is secured in the clearances of the heat exchanger fins.</li> </ul>
8	<p data-bbox="199 1357 454 1451">Remove the 3 fixing screws on the partition plate.</p>  <p data-bbox="943 1917 1002 1937">(R6405)</p>	

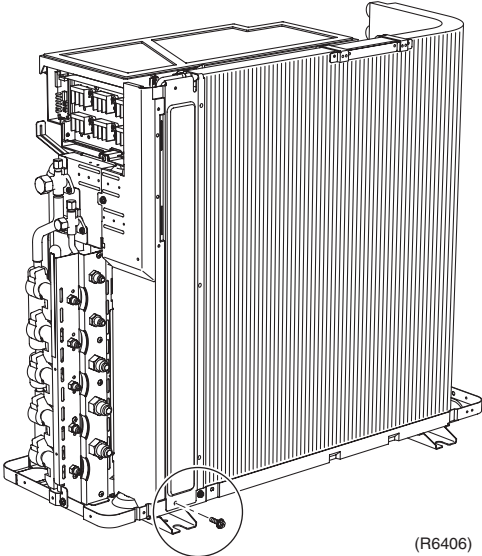
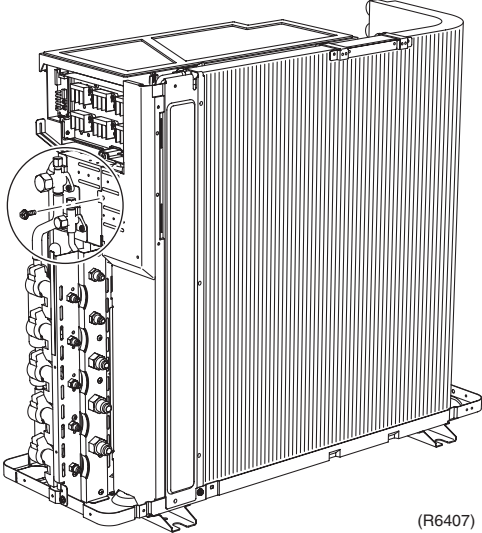
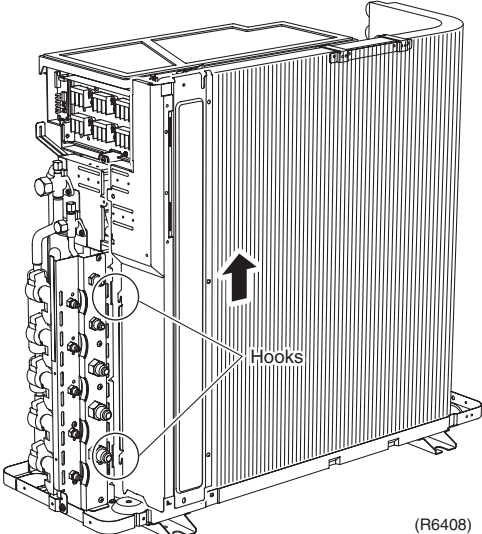

Step	Procedure	Procedure	Points
9	Remove the fixing screw from the bottom frame.	 <p>(R6406)</p>	
10	Remove the fixing screw from the shut-off valve mounting plate.	 <p>(R6407)</p>	
11	Lift the panel upward to undo the 2 hooks and remove it.	 <p>(R6408)</p>	

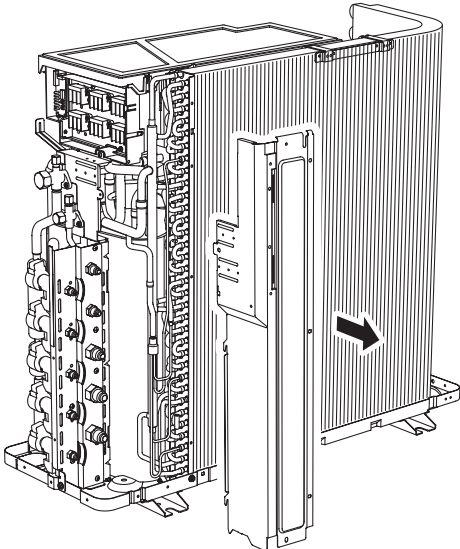
Step	Procedure	Points
12	<p data-bbox="201 215 469 241">Remove the rear panel.</p>  <p data-bbox="951 819 1011 837">(R6409)</p>	

## 3.2 Removal of the Electrical Box

**Procedure**

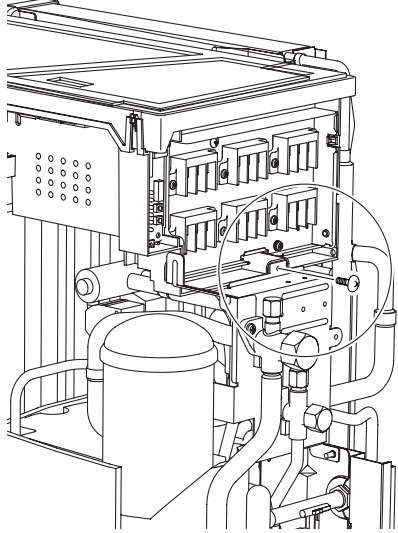
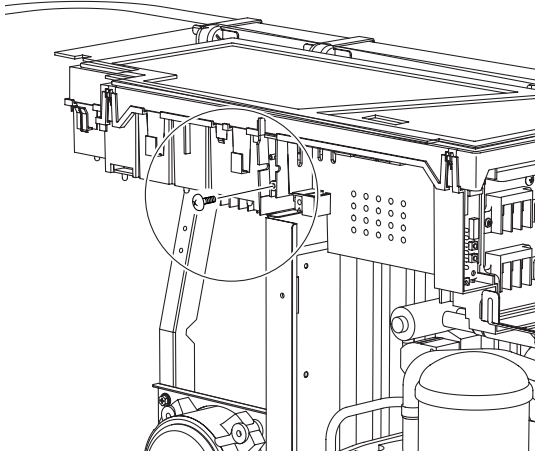
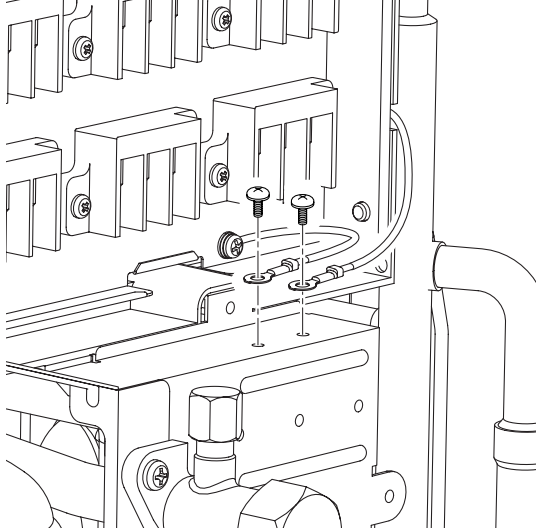

**Warning** Be sure to wait 10 minutes or more after turning off all power supplies before disassembling work.

Step	Procedure	Procedure	Points
1	Remove the fixing screw from the shut-off valve mounting plate.	 <p style="text-align: right;">(R6410)</p>	
2	Remove the fixing screw on the partition plate.	 <p style="text-align: right;">(R6411)</p>	
3	Remove the 2 screws to detach the earth wires.	 <p style="text-align: right;">(R6412)</p>	

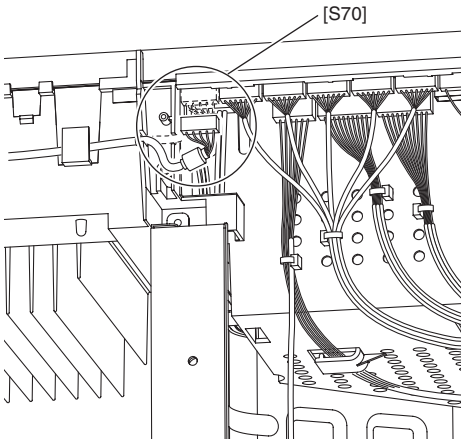
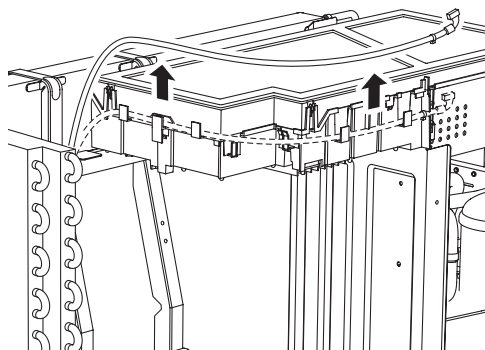
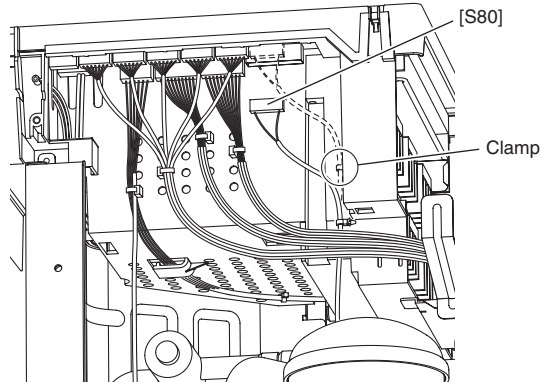
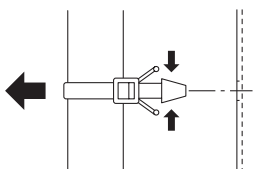
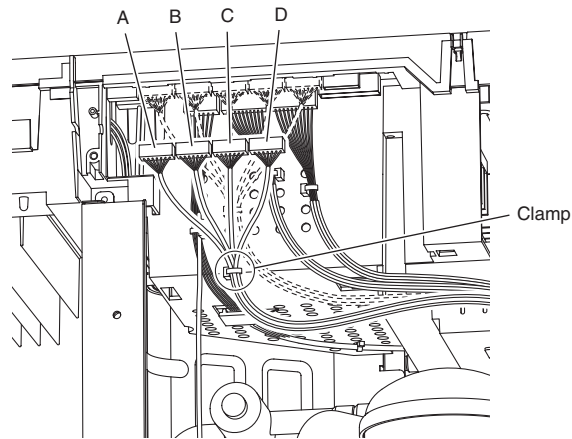
Step	Procedure	Procedure	Points
4	Disconnect the fan motor connector <b>S70</b> .	 <p>(R6413)</p>	
5	Release the fan motor wire harness.	 <p>(R6414)</p>	
6	Disconnect the motorized valve connector <b>S80</b> .	 <p>(R6415)</p>	<ul style="list-style-type: none"> <li>■ Detach the clamp.</li> <li>■ Just pull the push-mount type out of position.</li> </ul> 
7	Disconnect the 4 motorized valve connectors (for Rooms A, B, C and D).	 <p>(R6416)</p>	<ul style="list-style-type: none"> <li>■ A : Connector <b>S20</b>(white),</li> <li>■ B : Connector <b>S21</b>(red),</li> <li>■ C : Connector <b>S22</b>(blue),</li> <li>■ D : Connector <b>S23</b>(yellow).</li> </ul>

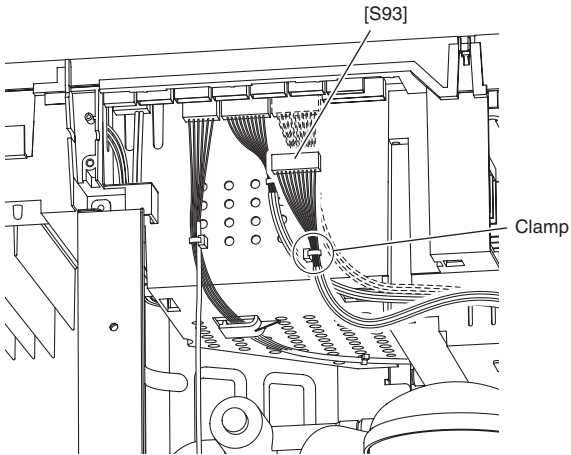
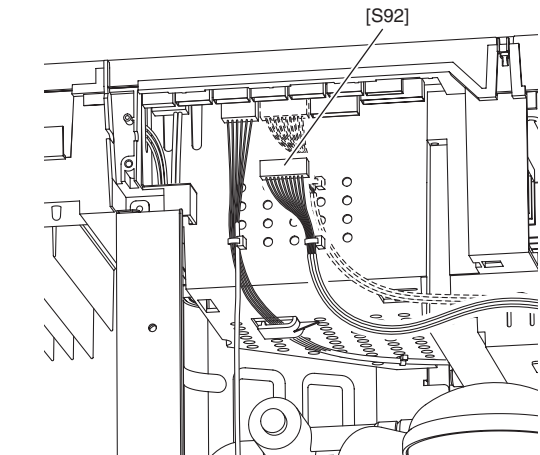
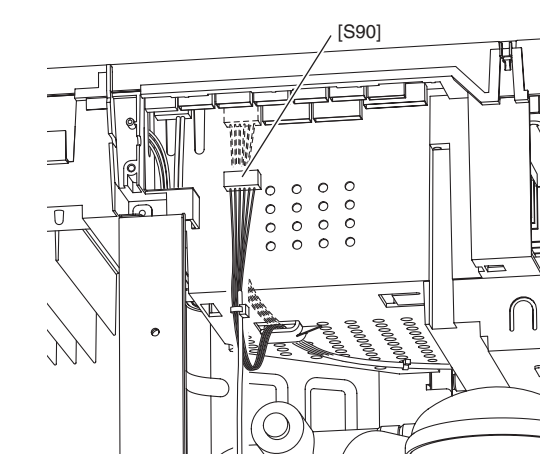
Step	Procedure	Procedure	Points
8	Disconnect the liquid pipe thermistor connector <b>S93</b> .	 <p>(R6417)</p>	
9	Disconnect the gas pipe thermistor connector <b>S92</b> .	 <p>(R6418)</p>	
10	Disconnect the discharge pipe thermistor connector <b>S90</b> .	 <p>(R6419)</p>	

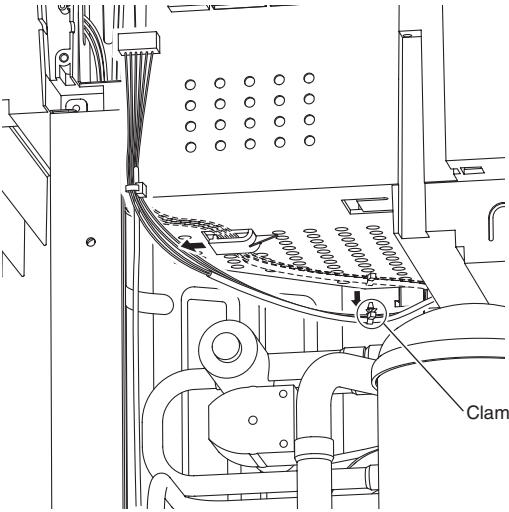
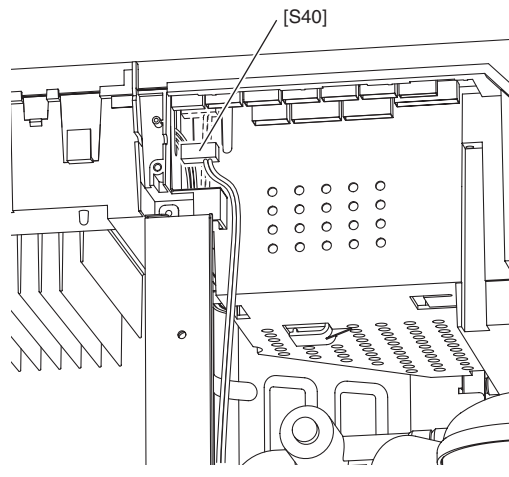
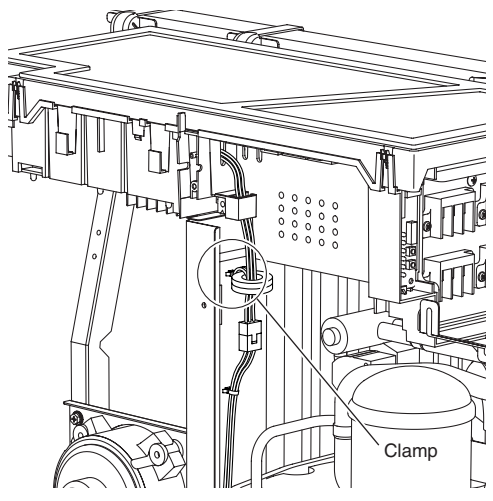
Step	Procedure	Procedure	Points
11	The wire harness is hooked on the bottom of the electrical box. Unhook it and remove the clamp.	 <p>(R6420)</p>	
12	Disconnect the OL connector S40.	 <p>(R6421)</p>	
13	Remove the OL wire harness and the compressor wire harness together from the partition.	 <p>(R6422)</p>	

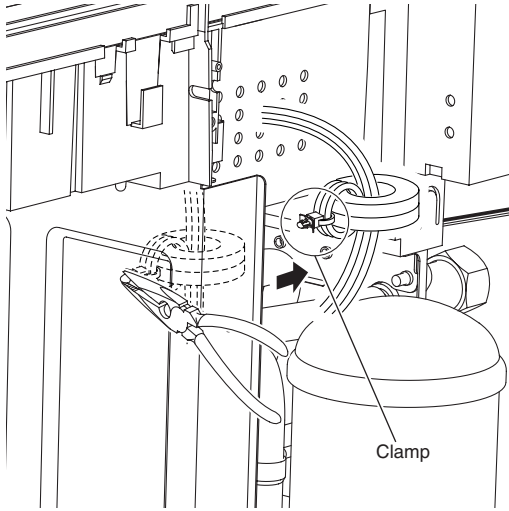
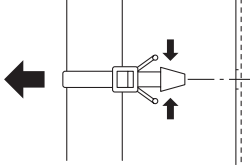
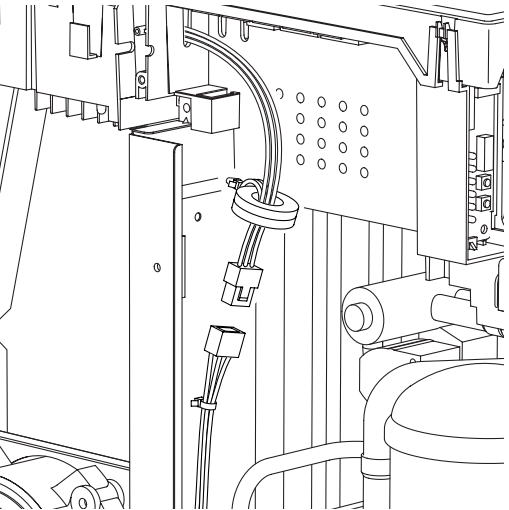
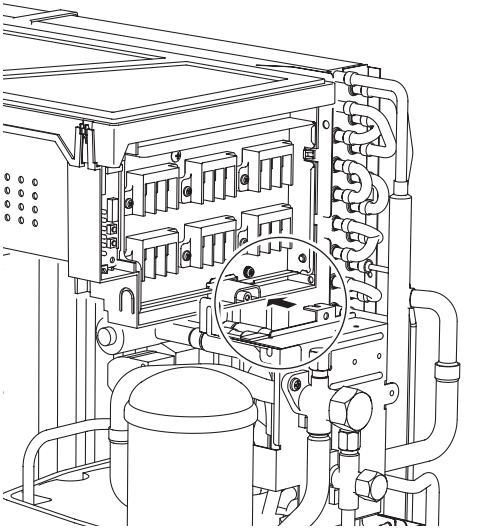
Step	Procedure	Procedure	Points
14	Use long-nose pliers or the like to pull out the clamp.	 <p style="text-align: right;">(R6423)</p>	<ul style="list-style-type: none"> <li>■ Detach the clamp.</li> <li>■ Just pull the push-mount type out of position.</li> </ul> 
15	Disconnect the relay connector of the compressor.	 <p style="text-align: right;">(R6469)</p>	
16	First, slide the box leftward to undo the hook on the right side of the box.	 <p style="text-align: right;">(R6424)</p>	

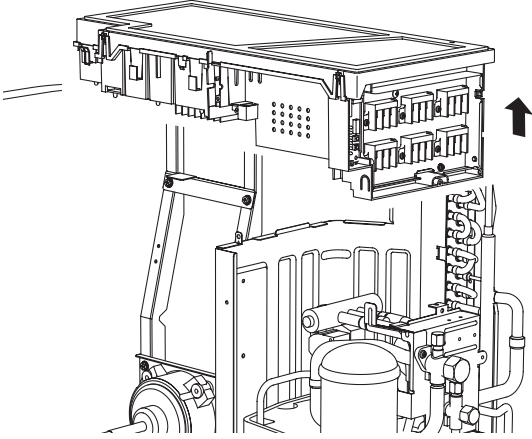
Step	Procedure	Points
17	<p data-bbox="201 215 469 275">Lift up the electrical box to remove it.</p>  <p data-bbox="970 685 1038 707">(R6425)</p>	



### 3.3 Removal of PCB

**Procedure**



**Warning** Be sure to wait 10 minutes or more after turning off all power supplies before disassembling work.

Step	Procedure	Points
<p>1. Removing the <b>Control PCB</b></p>		
<p>1 Open the cover of the electrical box.</p>	<p>(R6426)</p>	<p>■ Undo the 4 hooks. The hooks are marked with ▼.</p>
<p>2 Remove the 3 screws.</p>	<p>(R6427)</p>	<p>(R6428)</p>
<p>3 Undo the 4 hooks.</p>	<p>(R6429)</p>	
<p>4 Lift up your side of the control PCB.</p>	<p>(R6430)</p>	

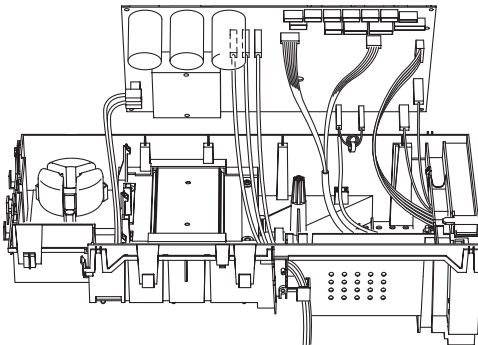
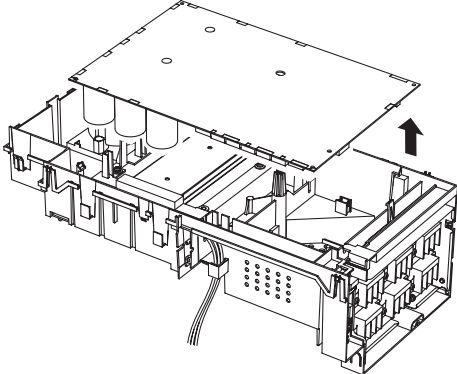
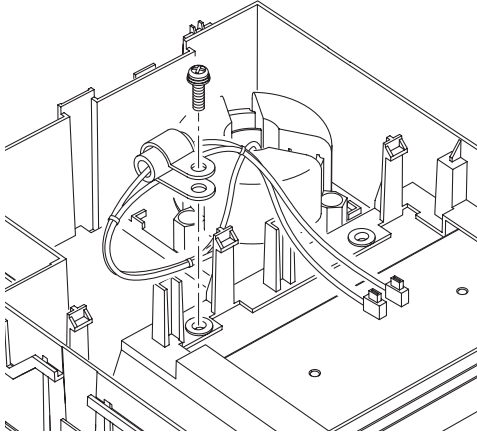
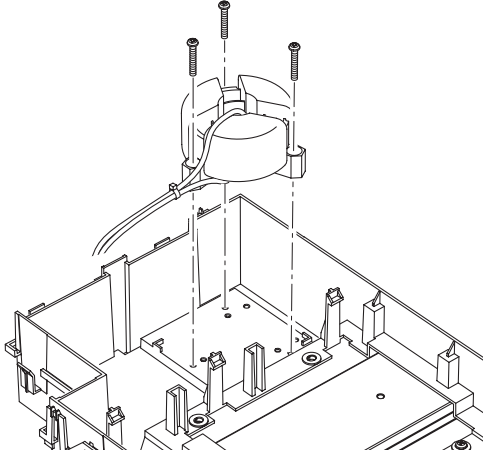
Step	Procedure	Points
5	Disconnect the connectors one by one starting from your side.	<ul style="list-style-type: none"> <li>● Connectors <b>S33 &amp; S71</b>: For inverter PCB</li> <li>● Connectors <b>S31 &amp; S32</b>: For SPM PCB</li> <li>● Connectors <b>S51 &amp; S101</b>: For display PCB</li> <li>● Connector <b>S10</b>: For relay PCB</li> <li>● Connectors <b>H1/H2</b>: For DB (diode bridge), power wire harnesses <b>AC1</b> (red) and <b>AC2</b> (black)</li> </ul>
6	Remove the control PCB.	
 <p style="text-align: right;">(R6431)</p>		
 <p style="text-align: right;">(R6432)</p>		
<b>2. Removing the reactor</b>		
1	Remove the screw.	
 <p style="text-align: right;">(R6433)</p>		
2	Remove the 3 screws and lift the reactor upward to remove it.	
 <p style="text-align: right;">(R6434)</p>		

Step	Procedure	Points
3.	Removing the display PCB.	
1	Disconnect the control PCB connectors S52, S102	
2	Slightly lift the top hooks to detach.	
3	Undo the bottom hook to remove the display PCB.	

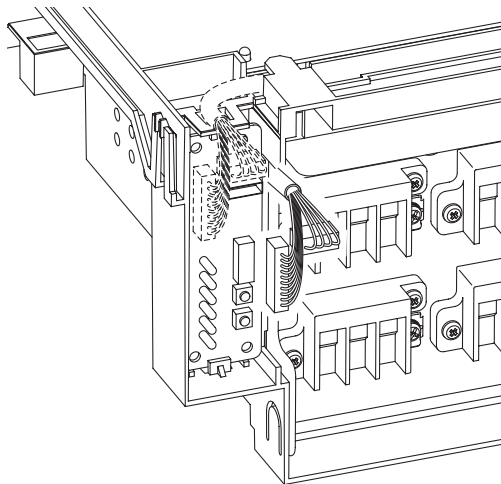

(R6435)

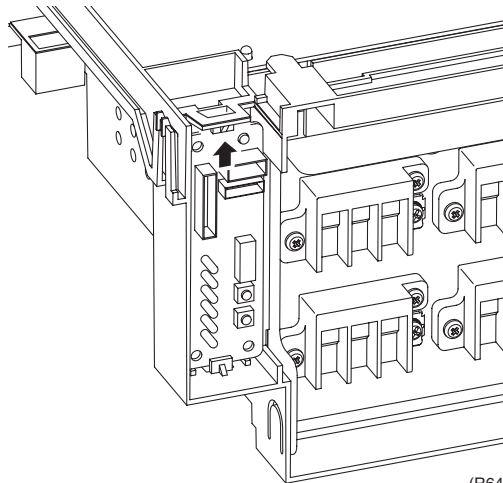

(R6436)

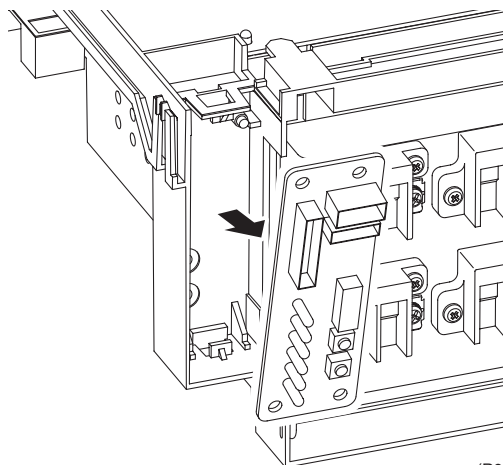

(R6437)

Step	Procedure	Points
4.	Removing the servicing cover off the terminal block assembly.	
1	Remove the screw.	
2	Lift the hook to detach.	
3	Open the cover toward yourself.	

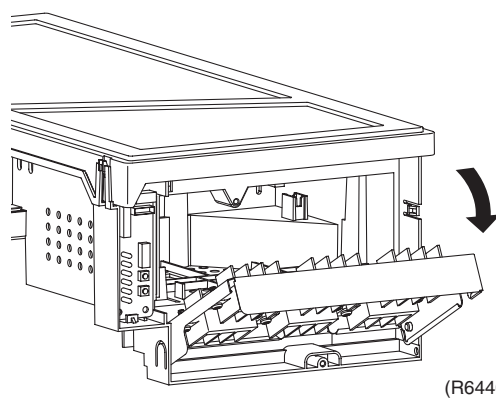
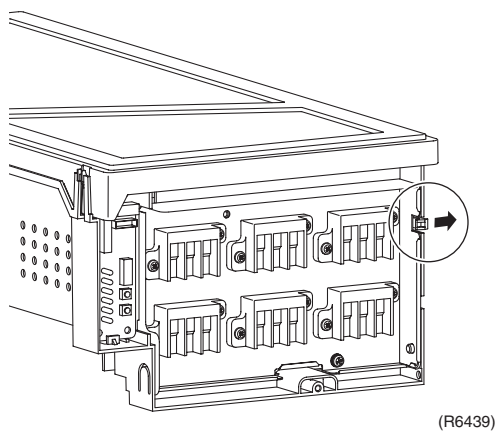
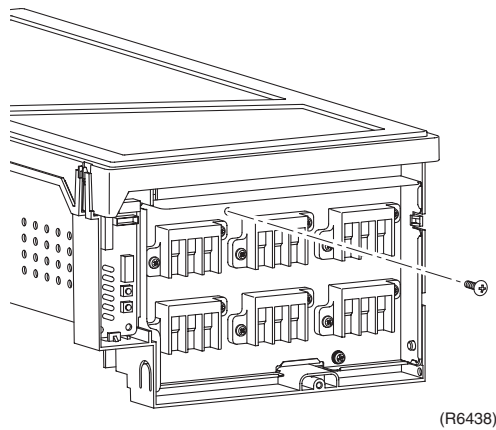

### 3.4 Removal of Fan Motor

**Procedure**



**Warning** Be sure to wait 10 minutes or more after turning off all power supplies before disassembling work.

Step	Procedure	Points
1	Remove the 2 screws at the bottom first.	<p>Be sure to remove the bottom screws first. If the top screws are removed first, the fan motor, the center of gravity of which is toward the front, may tilt down or fall, getting you injured.</p>
2	Next, remove the 2 top screws.	
3	Remove the fan motor.	<p>When reassembling, be sure to place the wire harness lower.</p>

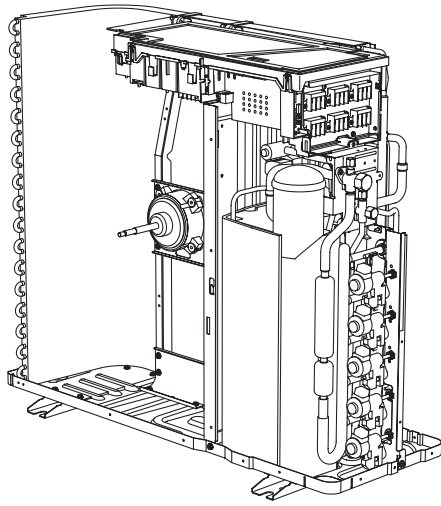

(R6441)

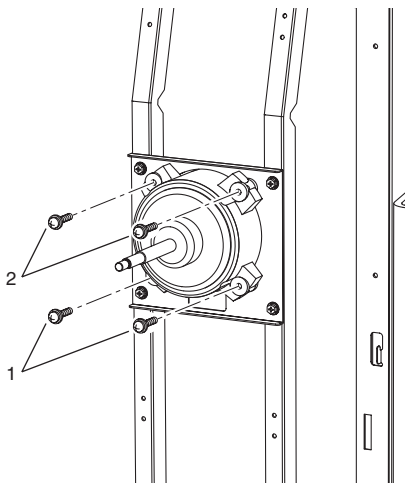

(R6442)

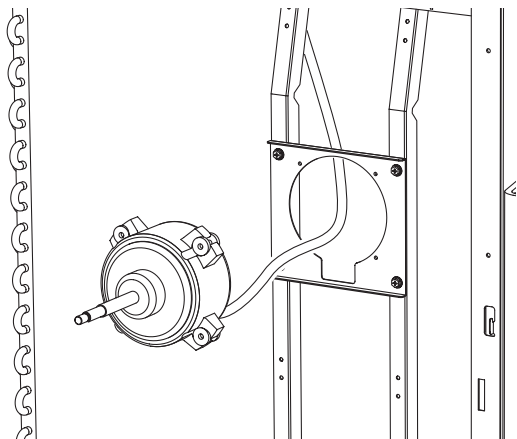

(R6443)

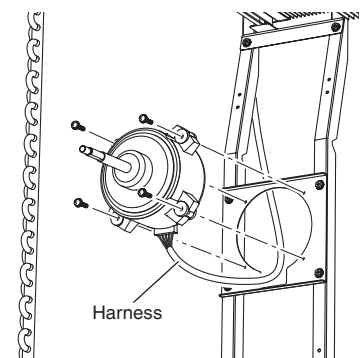

(R6444)

## 3.5 Removal of Coils / Thermistors

### Procedure

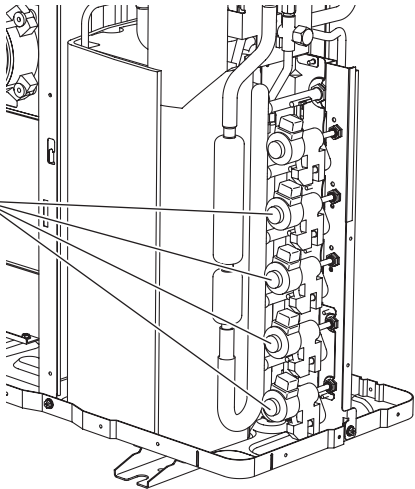
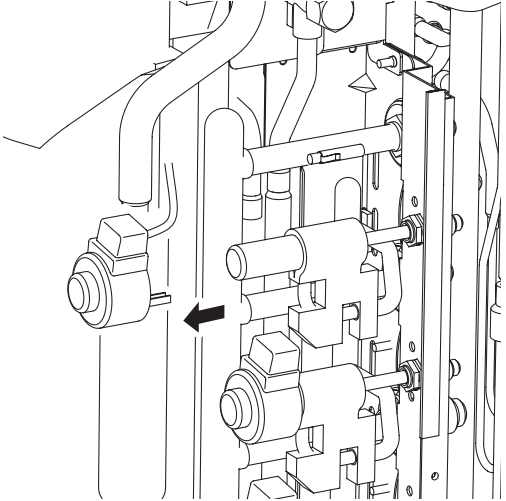

**Warning** Be sure to wait 10 minutes or more after turning off all power supplies before disassembling work.

Step	Procedure	Points
1. Removing the motorized valve coil	 <p>(R6955)</p>  <p>(R6446)</p>	<ul style="list-style-type: none"> <li>■ The number of motorized valve coils is different depending on the models.</li> </ul>

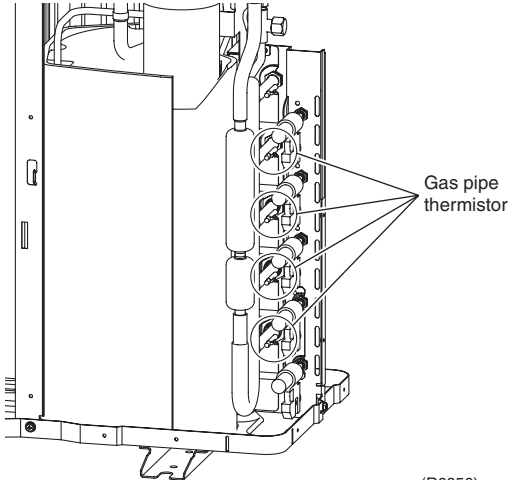
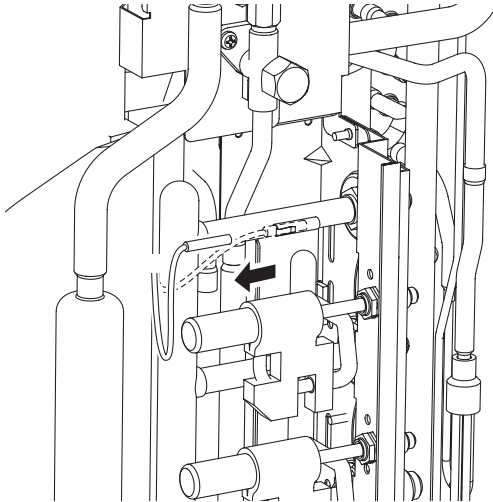
Step	Procedure	Points
2	<p data-bbox="201 215 472 241">Pull out the thermistors.</p>  <p data-bbox="948 712 1007 734">(R6956)</p>  <p data-bbox="948 1294 1007 1317">(R6448)</p>	

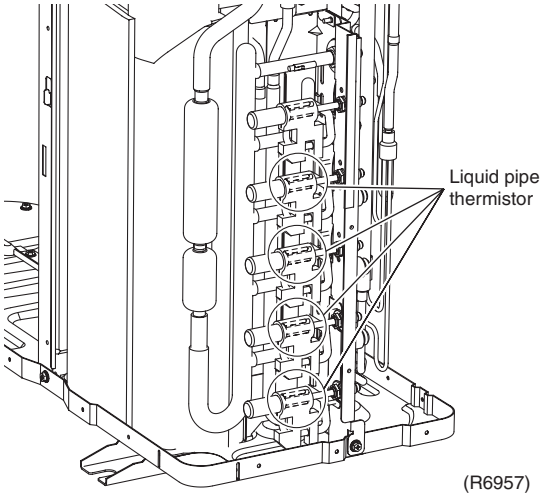
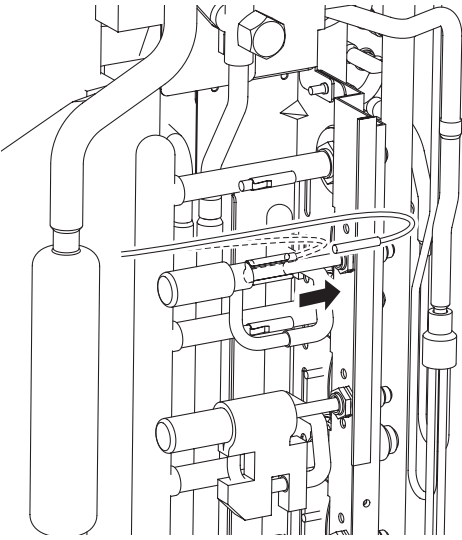
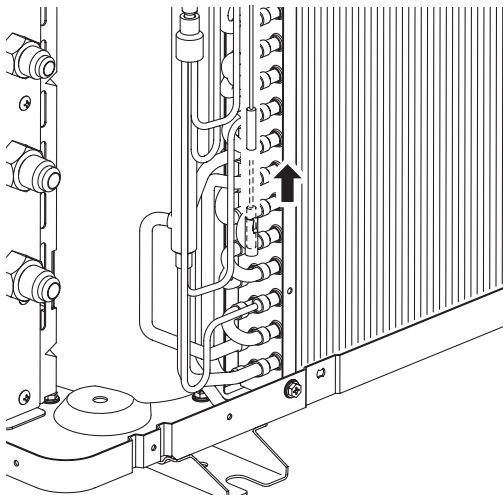
Step	Procedure	Points
3	<p>Peel the putty from the liquid pipe thermistor, and pull out the thermistor.</p>  <p style="text-align: right;">Liquid pipe thermistor</p> <p style="text-align: right;">(R6957)</p>  <p style="text-align: right;">(R6450)</p>	
2. Removal of Thermistors		
1	<p>Pull out the heat exchanger thermistor.</p>  <p style="text-align: right;">(R6451)</p>	

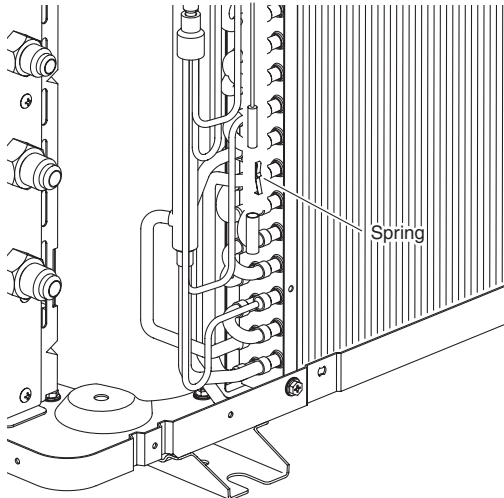
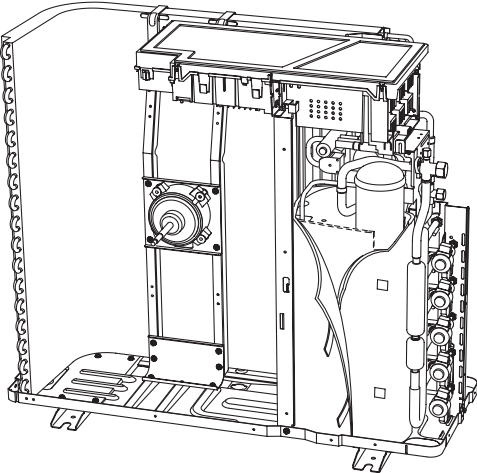
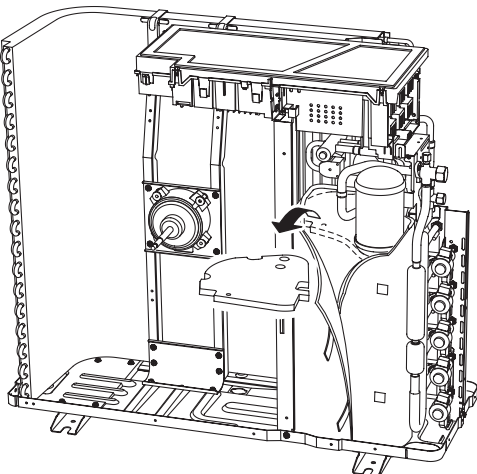

Step	Procedure	Procedure	Points
2	Remove the spring from the heat exchanger thermistor.	 <p style="text-align: right;">(R6452)</p>	<ul style="list-style-type: none"> <li>■ Be careful no to lose the spring.</li> </ul>
3	Slightly open the sound blanket.	 <p style="text-align: right;">(R6453)</p>	
4	Remove the sound blanket (top upper).	 <p style="text-align: right;">(R6454)</p>	

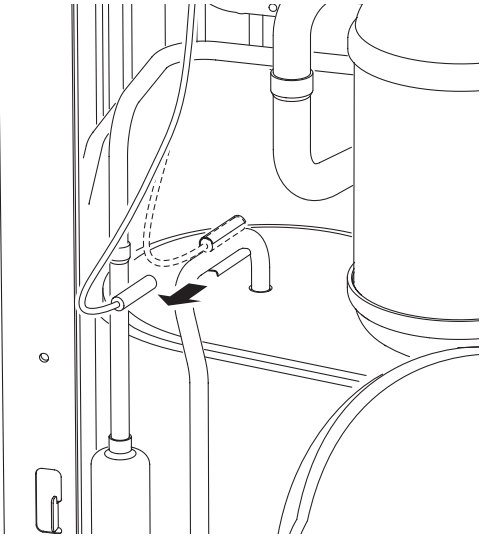
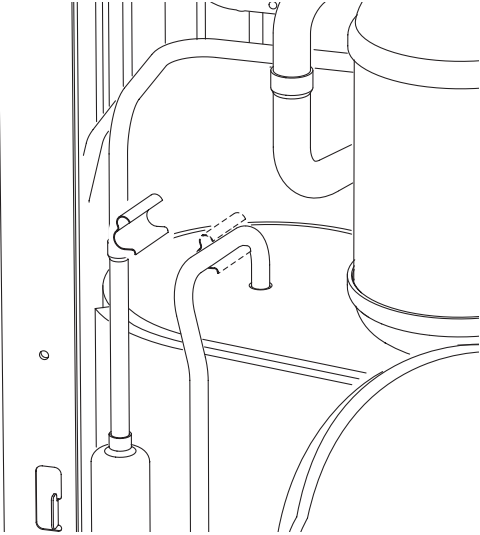
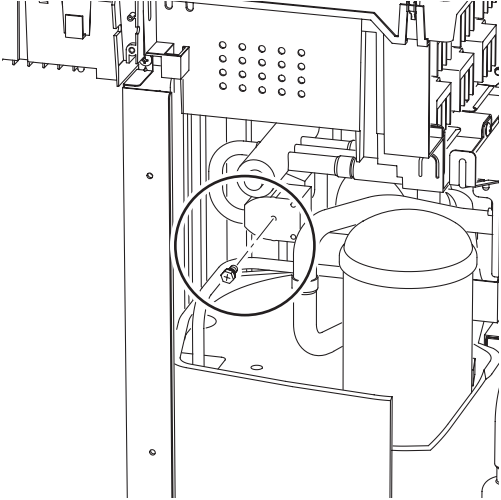
Step	Procedure	Procedure	Points
5	Remove the discharge pipe thermistor.	 <p>(R6455)</p>	
6	Remove the fixture.	 <p>(R6456)</p>	
3.	Removing the Four way valve coil and motorized valve coil	 <p>(R6457)</p>	
1	Remove the screw.		

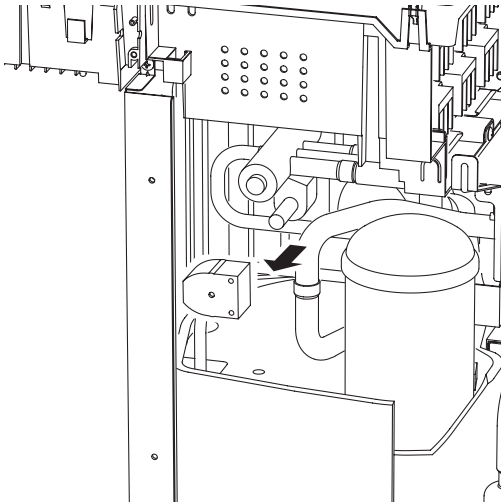
Step	Procedure	Procedure	Points
2	Remove the Four way valve coil.	 <p>(R6458)</p>	

### 3.6 Removal of Sound Blanket

**Procedure**



**Warning** Be sure to wait 10 minutes or more after turning off all power supplies before disassembling work.

Step	Procedure	Points
1	Undo the 2 Velcro tapes off the sound blanket, and open the sound blanket (outer sleeve).	
2	Remove the sound blanket (top upper).	<ul style="list-style-type: none"> <li>■ The sound blanket is fragile. Carefully pass the discharge pipe through it.</li> </ul>
3	Remove the screw from the partition plate and open the plate slightly to the left for easy work.	

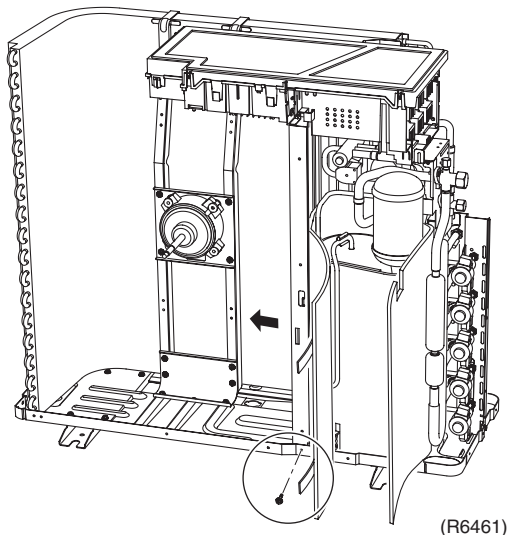
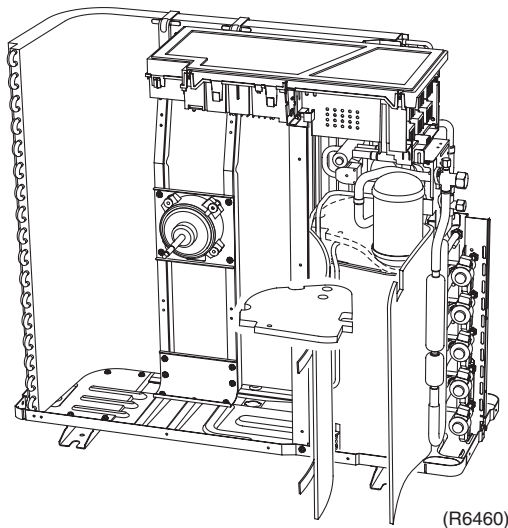
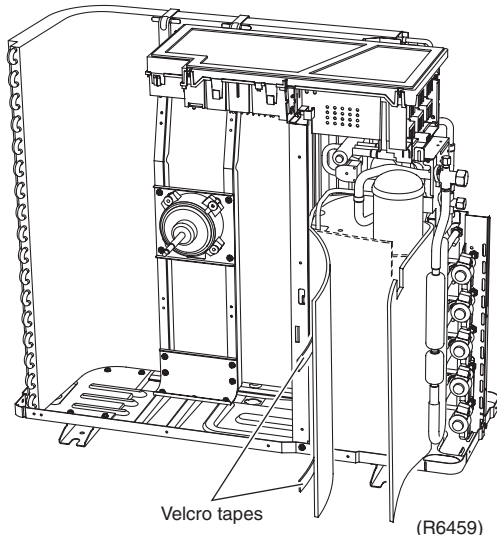

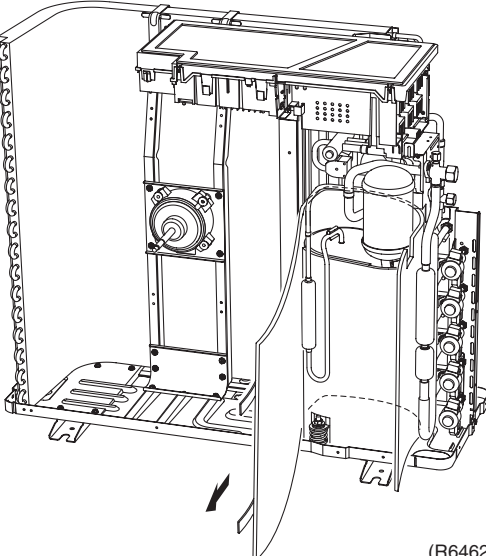
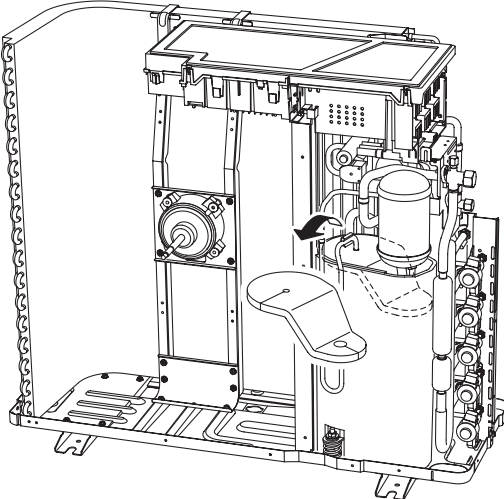
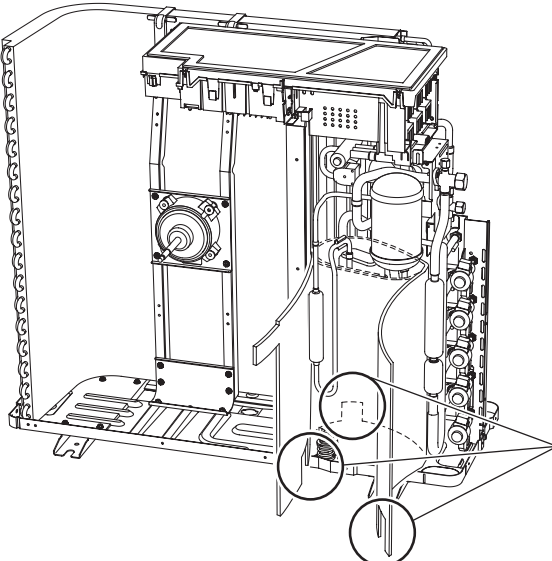
Step	Procedure	Procedure	Points
4	Remove the sound blanket (outer sleeve).	 <p style="text-align: right;">(R6462)</p>	<ul style="list-style-type: none"> <li>■ The sound blanket is fragile. Be careful of the notches of the compressor mount (3 locations).</li> </ul>
5	Remove the sound blanket (top lower).	 <p style="text-align: right;">(R6463)</p>	<ul style="list-style-type: none"> <li>■ The sound blanket is fragile. Carefully pass the discharge pipe through it.</li> </ul>
6	Open the sound blanket (inner sleeve) and remove part of the muffler.	 <p style="text-align: right;">(R6464)</p>	<ul style="list-style-type: none"> <li>■ The sound blanket is fragile. Be careful of the notches of the compressor mount (3 locations).</li> </ul>

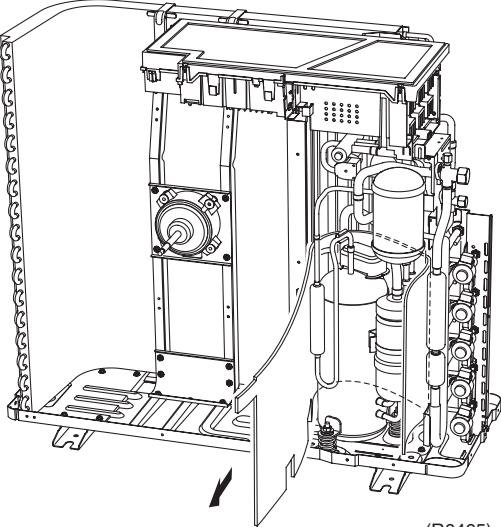
Step	Procedure	Procedure	Points
7	Remove the sound blanket (outer sleeve).	 <p>(R6465)</p>	

### 3.7 Removal of Compressor

**Procedure**

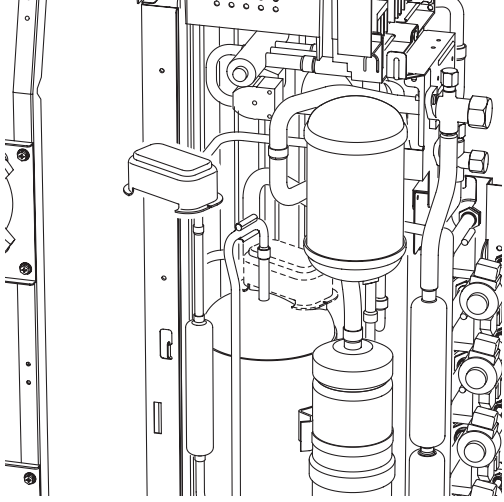
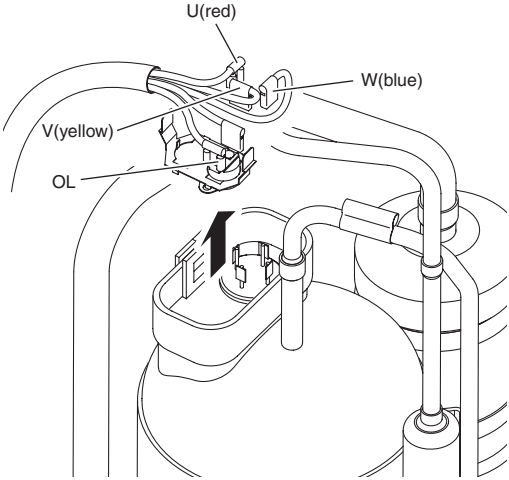
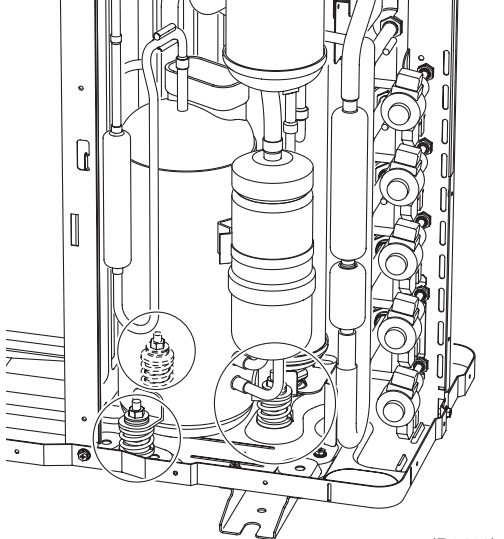

**Warning** Be sure to wait 10 minutes or more after turning off all power supplies before disassembling work.

Step	Procedure	Procedure	Points
1	Remove the terminal cover.	 <p style="text-align: right;">(R6466)</p>	
2	Pull out the 3 leads using long-nose pliers.	 <p style="text-align: right;">(R6467)</p>	<p>■ U:red, V:yellow, W:blue</p>
3	Remove the OL.		
4	Remove the 3 screws.	 <p style="text-align: right;">(R6468)</p>	

# Part 8 Others

1. Others .....	356
1.1 Test Run from the Remote Controller .....	356
1.2 Jumper Settings .....	357
1.3 Application of Silicon Grease to a Power Transistor and a Diode Bridge.....	358



# 1. Others

## 1.1 Test Run from the Remote Controller

### For Heat pump

In cooling mode, select the lowest programmable temperature; in heating mode, select the highest programmable temperature.

- Trial operation may be disabled in either mode depending on the room temperature.
- After trial operation is complete, set the temperature to a normal level.  
(26°C to 28°C in cooling mode, 20°C to 24°C in heating mode)
- For protection, the system disables restart operation for 3 minutes after it is turned off.

### For Cooling Only

Select the lowest programmable temperature.

- Trial operation in cooling mode may be disabled depending on the room temperature.  
Use the remote control for trial operation as described below.
- After trial operation is complete, set the temperature to a normal level (26°C to 28°C).
- For protection, the machine disables restart operation for 3 minutes after it is turned off.

### Trial Operation and Testing

1. Measure the supply voltage and make sure that it falls in the specified range.
  2. Trial operation should be carried out in either cooling or heating mode.
  3. Carry out the test operation in accordance with the Operation Manual to ensure that all functions and parts, such as louver movement, are working properly.
- The air conditioner requires a small amount of power in its standby mode. If the system is not to be used for some time after installation, shut off the circuit breaker to eliminate unnecessary power consumption.
  - If the circuit breaker trips to shut off the power to the air conditioner, the system will restore the original operation mode when the circuit breaker is opened again.

### Trial operation from Remote Controller

- (1) Press ON/OFF button to turn on the system.
- (2) Simultaneously press center of TEMP button and MODE buttons.
- (3) Press MODE button twice.  
(“T” will appear on the display to indicate that Trial Operation mode is selected.)
- (4) Trial run mode terminates in approx. 30 minutes and switches into normal mode. To quit a trial operation, press ON/OFF button.

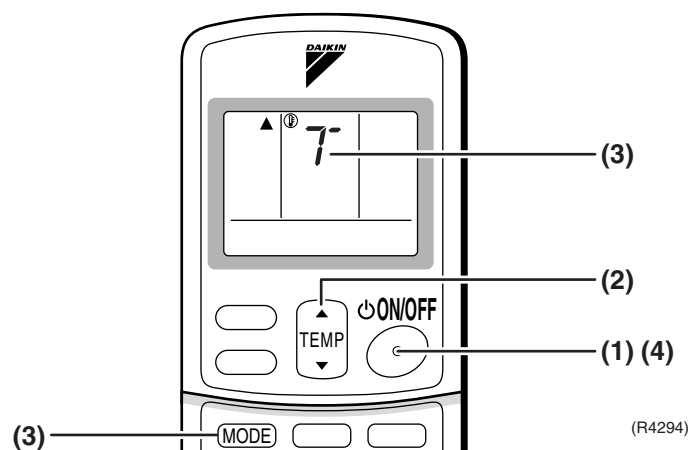

## 1.2 Jumper Settings

### 1.2.1 When Two Units are Installed in One Room

When two indoor units are installed in one room, the two wireless remote controllers can be set for different addresses.

#### How to set the different addresses

- Control PCB of the indoor unit
  - (1) Remove the electrical box.
  - (2) Cut the address jumper **JA** on the control PCB.
  
- Wireless remote controller
  - (1) Slide the front cover and take it off.
  - (2) Cut the address jumper **J4**.

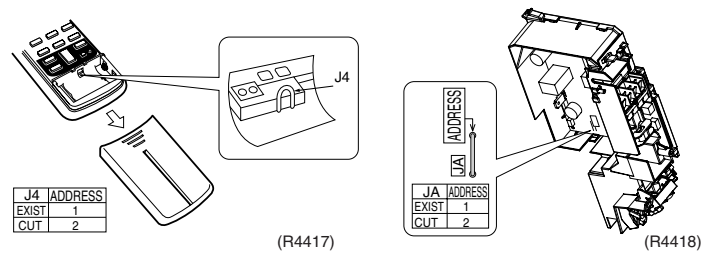

### 1.2.2 Jumper Setting

Jumper (On indoor PCB)	Function	When connected (factory set)	When cut
<b>JC</b>	Power failure recovery function	Auto start	Unit does not resume operation after recovering from a power failure. Timer ON-OFF settings are cleared.
<b>JB</b>	Fan speed setting when compressor is OFF on thermostat. (effective only at cooling operation)	Fan speed setting ; Remote controller setting	Fan rpm is set to "0" <Fan stop>

# 1.3 Application of Silicon Grease to a Power Transistor and a Diode Bridge

**Applicable Models**

All outdoor units using inverter type compressor for room air conditioner.

When the printed circuit board of an outdoor unit is replaced, it is required that silicon grease (\*1) is certainly applied to the heat radiation part (the contact point to the heat radiation fin) of the power transistor and diode bridge.

\*1: Parts number of the silicon grease – 1172698 (Drawing number 3FB03758-1)

**Details**

The silicon grease is an essential article for encouraging the heat radiation of the power transistor and the diode bridge. Applying the paste should be implemented in accordance with the following instruction.

Remark: There is the possibility of failure with smoke in case of bad heat radiation.

- To completely wipe off the old silicon grease on a heat radiation fin.
- To evenly apply the silicon grease to the whole.
- Do not have any foreign object such as solder or paper waste between the power transistor, the diode bridge and the heat radiation fin.
- To firmly tighten the screws of the power transistor and the diode bridge, and to surely contact to the heat radiation fin without any gap.

**<Example>**

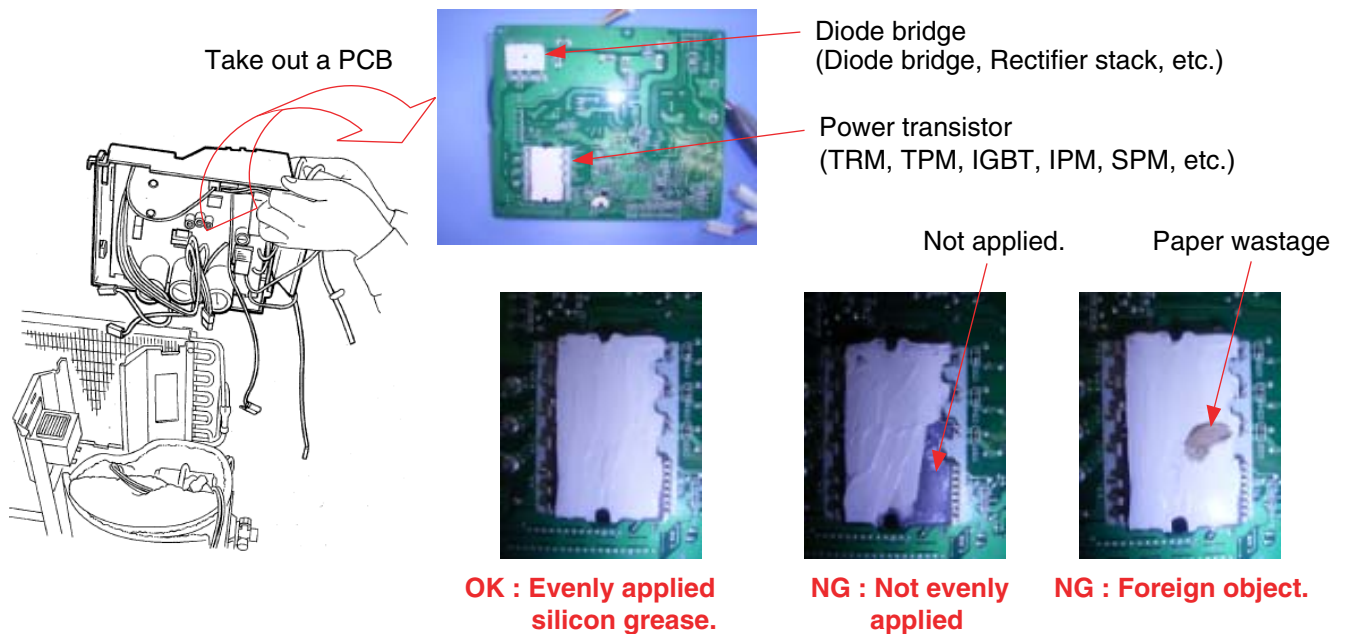

Take out a PCB

Diode bridge (Diode bridge, Rectifier stack, etc.)

Power transistor (TRM, TPM, IGBT, IPM, SPM, etc.)

Not applied.

Paper wastage

**OK : Evenly applied silicon grease.**

**NG : Not evenly applied**

**NG : Foreign object.**

(R7100)

# Part 9

# Appendix

1. Piping Diagrams.....	360
1.1 Indoor Units.....	360
1.2 Outdoor Units.....	364
2. Wiring Diagrams.....	370
2.1 Indoor Units.....	370
2.2 Outdoor Units.....	376

# 1. Piping Diagrams

## 1.1 Indoor Units

### 1.1.1 Wall Mounted Type

FTKS25/35EVMA, FTKS25/35DVM  
FTKS20DVMA, FTKS20/25/35DVM

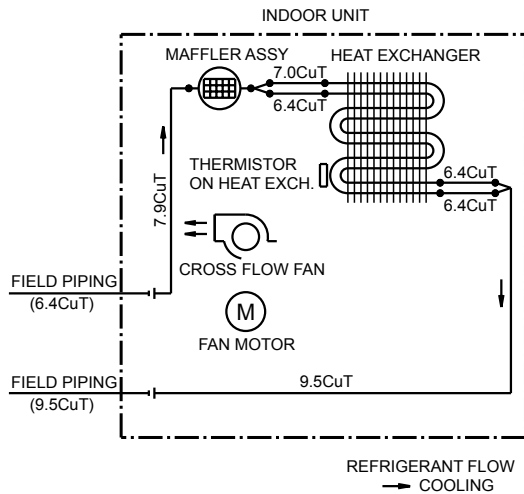

4D050757A

FTXS50/60FVMA, FTK(X)S50/60DVM  
FTK(X)S50/60FVLT, FTKS50/60BVM

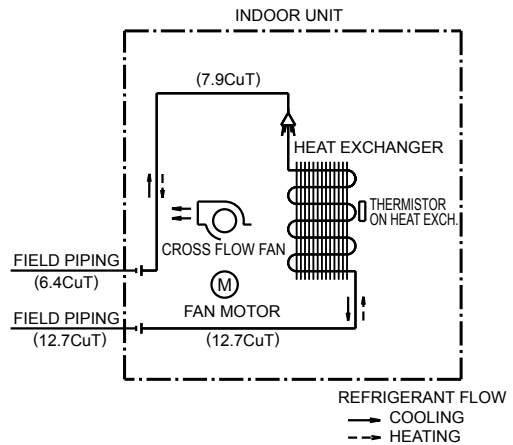

4D040081Q

FTKS71FVM, FTKS71FVMA, FTKS71FVLT  
FTKS71DVM, FTKS71BVM

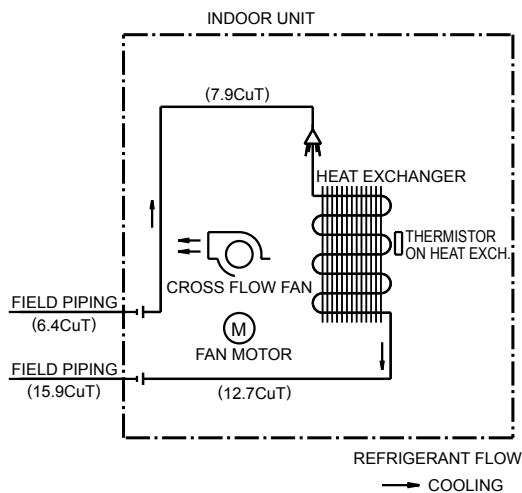

4D050919E

FTKS50FVM, FTKS60FVM  
FTKS50FVMA, FTKS60FVMA

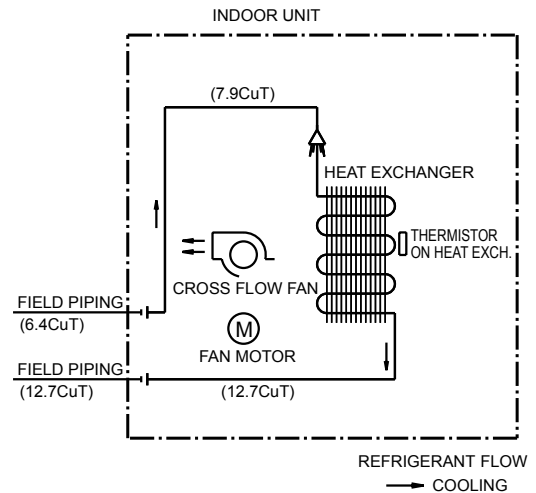

4D054932A

**FTXS25/35EVMA, FTXS20DVMA  
FTXS20/25/35DVMT**

**FTXS71FVMA, FTXS71DVMT, FTXS71FVLT**

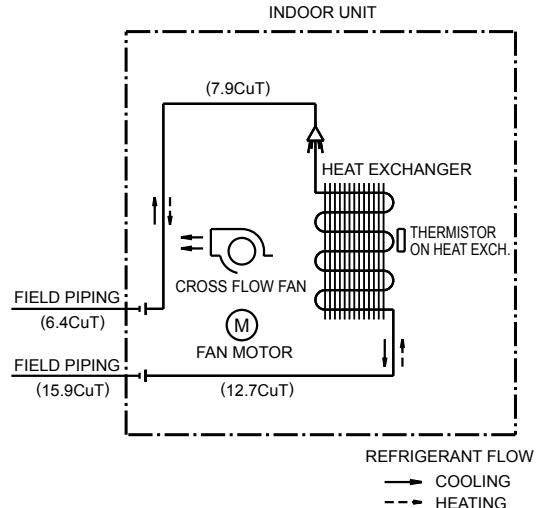
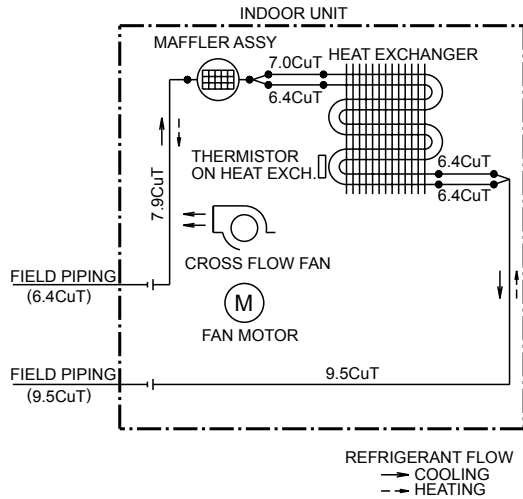

4D047912F

4D040082P

**1.1.2 Duct Connected Type**

**FDKS25/35CAVMB, FDKS50/60CVMB, FDKS25/35EAVMB, CDKS25/35/50/60CVMA  
CDK(X)S25/35/50/60DVMT, CDK(X)S25/35EAVMT(A), FDXS25/35/50/60CVMA**

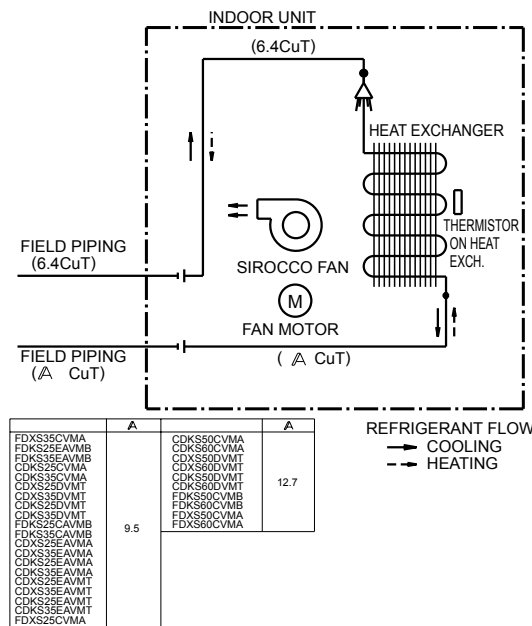

C : 4D045449J

### 1.1.3 Floor / Ceiling Suspended Dual Type

FLXS25BVMA, FLXS35BVMA

FLXS50BVMA, FLXS60BVMA

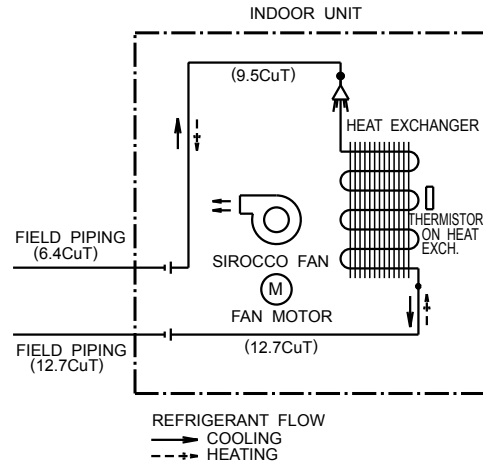
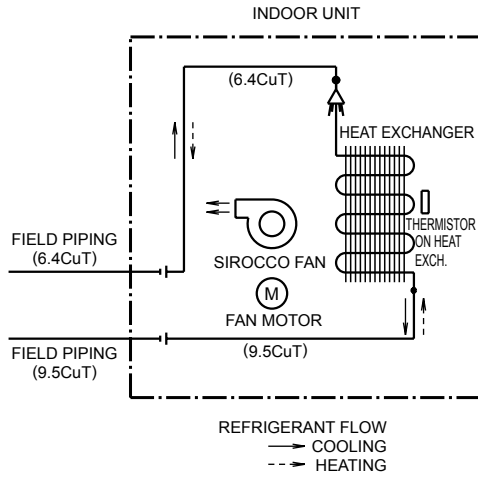

4D048722A

4D048724A

### 1.1.4 Floor Standing Type

FVXS35BVMA

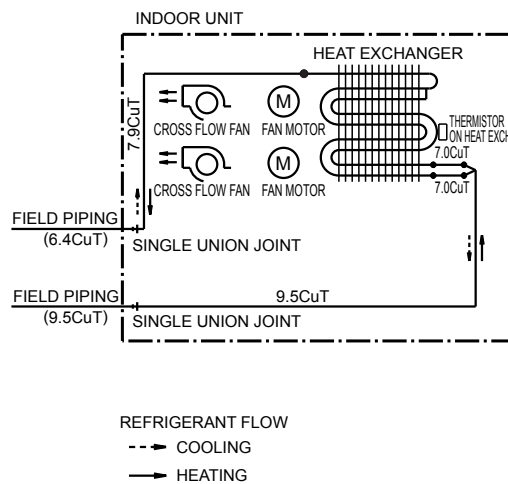

4D034714C

FVXS50BVMA

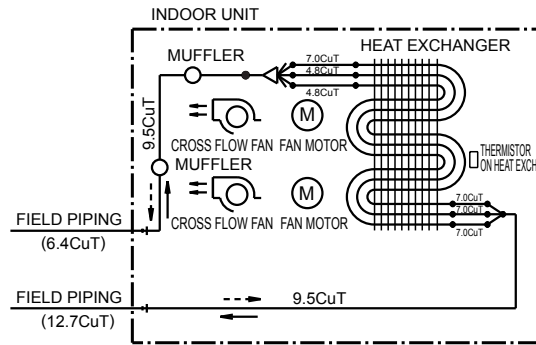

REFRIGERANT FLOW  
 —> COOLING  
 - - -> HEATING

4D020911D

### 1.1.5 Ceiling Mounted Cassette Type

FFQ25B8V1B, FFQ35B8V1B, FFQ50B8V1B, FFQ60B8V1B

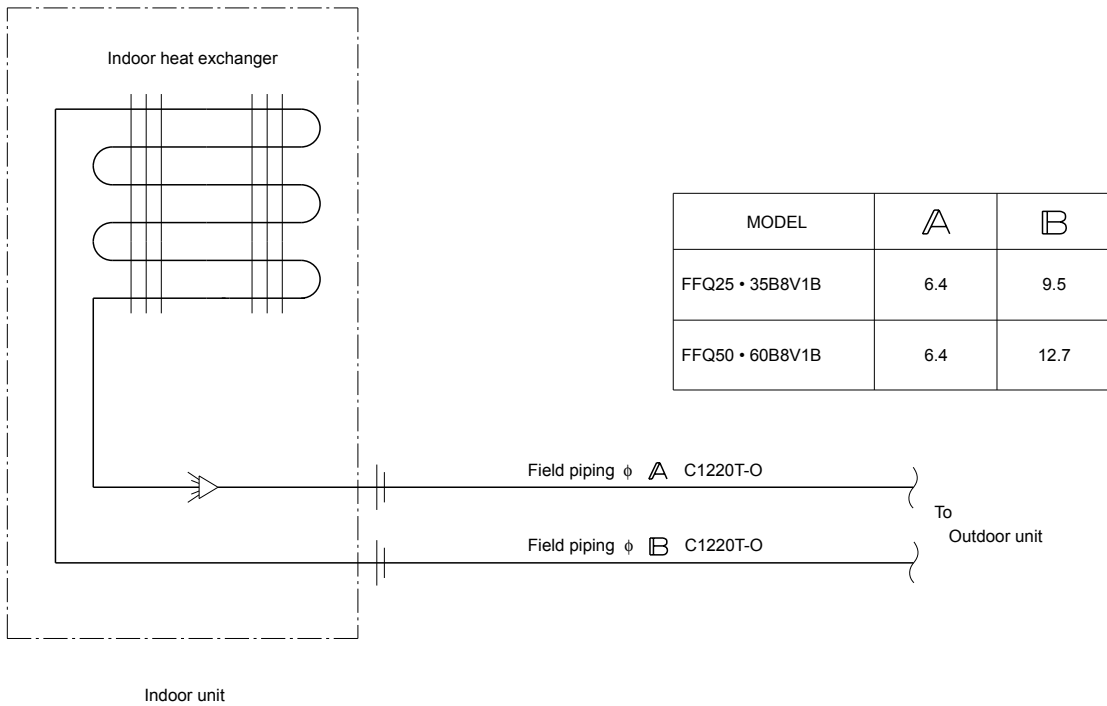

C : 4D039335



# 1.2 Outdoor Units

## 1.2.1 Cooling Only

### 3MKS58EVMA

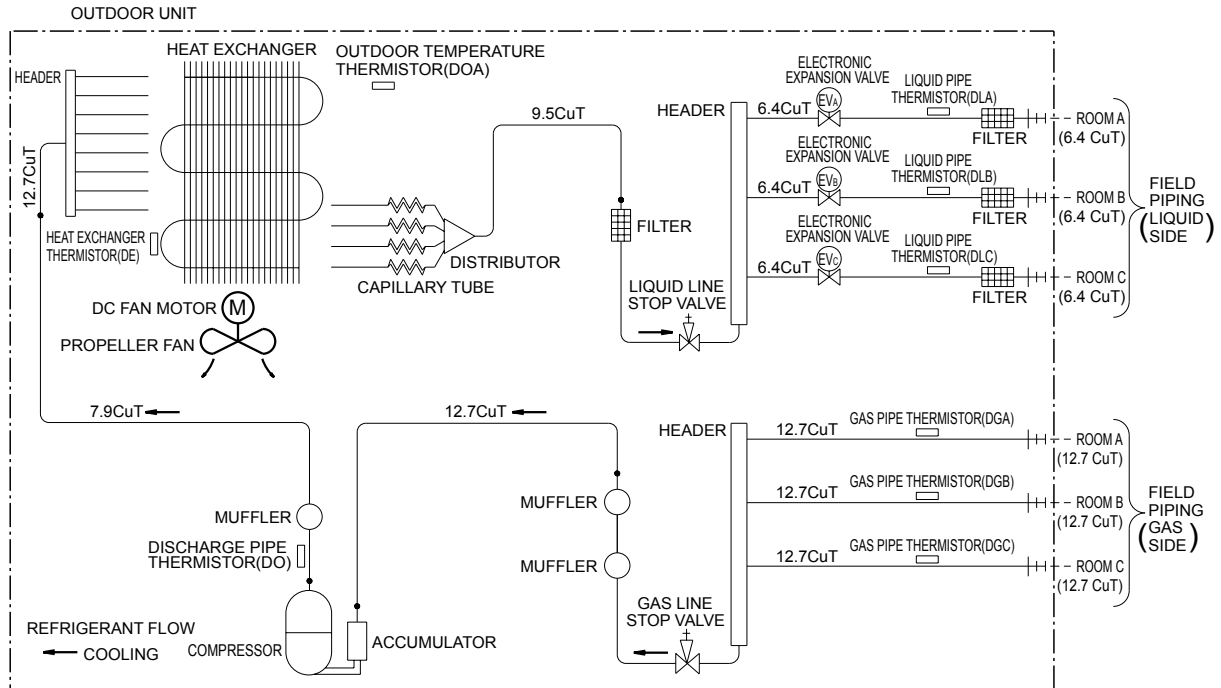

3D054637

### 3MKS75EVMA, 3MKS71ESG

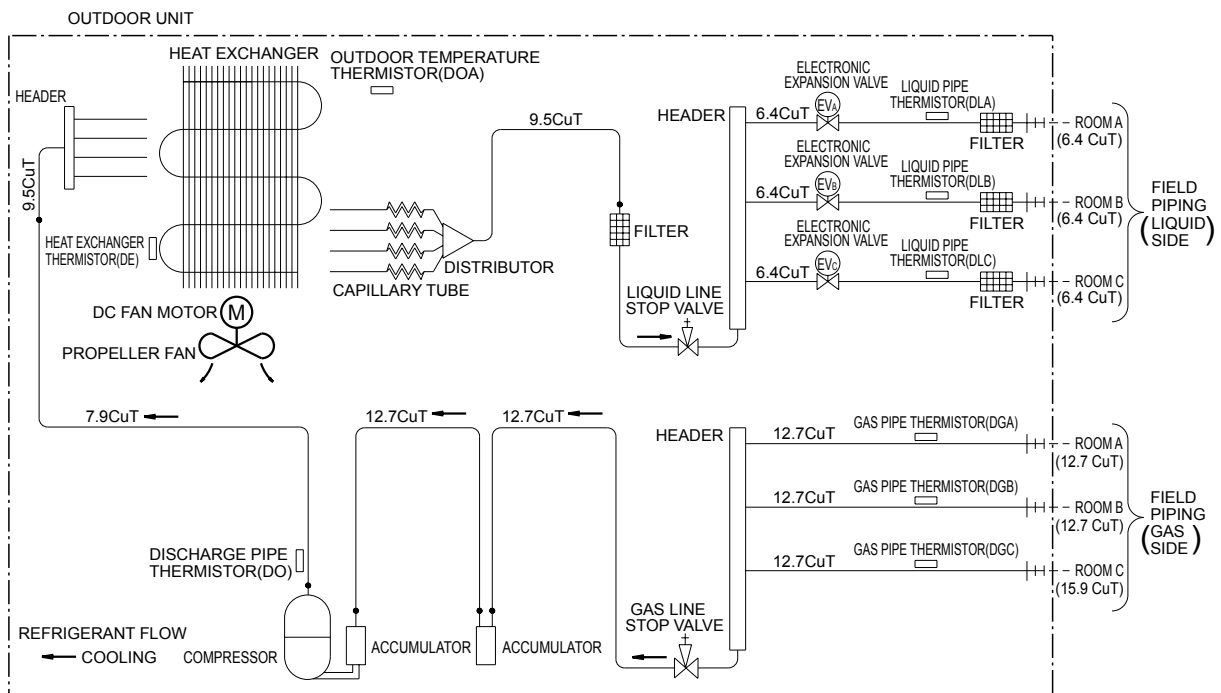

3D054638



3MKS50DVM

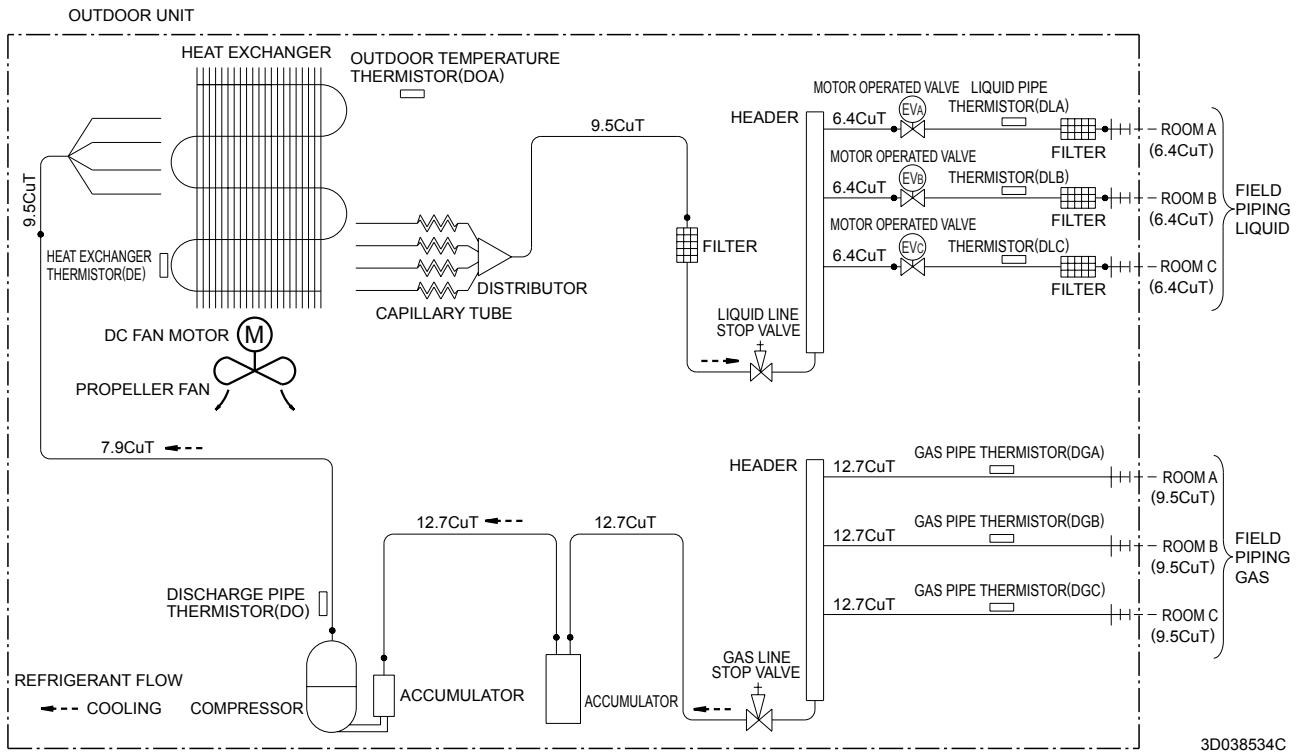

4MKS71DVM

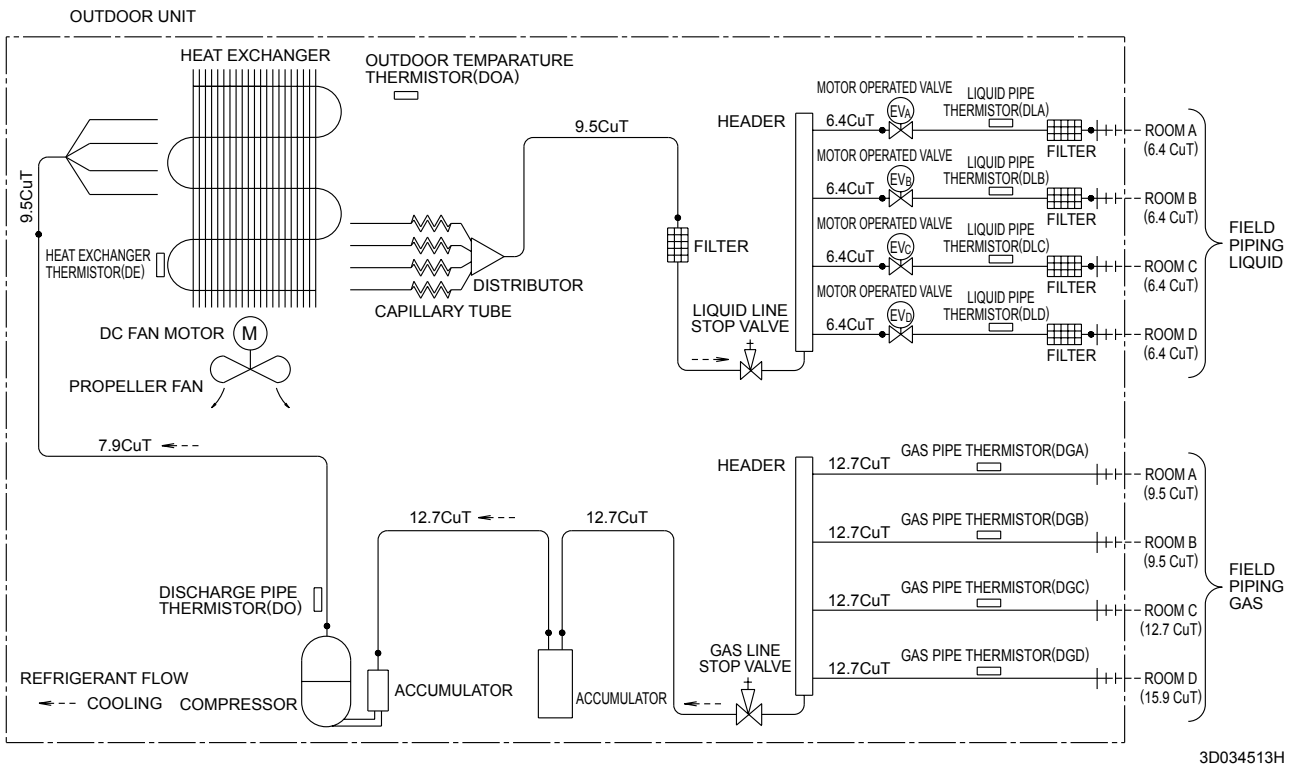

3MKS50ESG

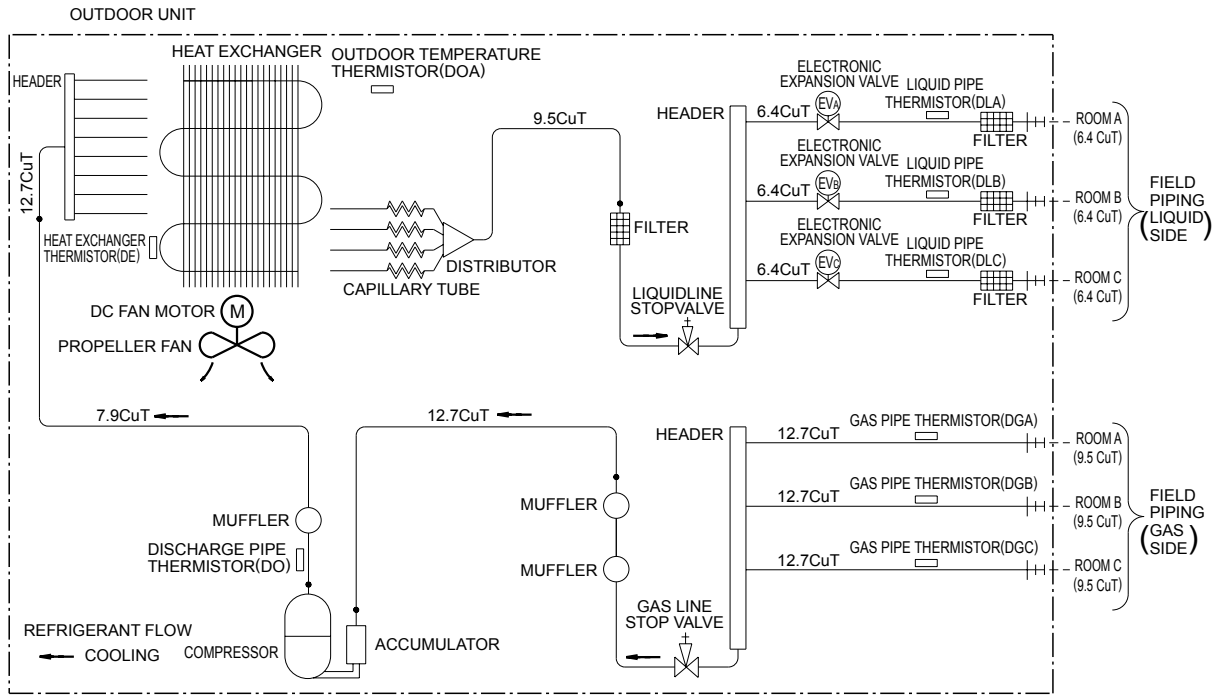

3D052056C

## 1.2.2 Heat Pump

### 3MXS52EVMA

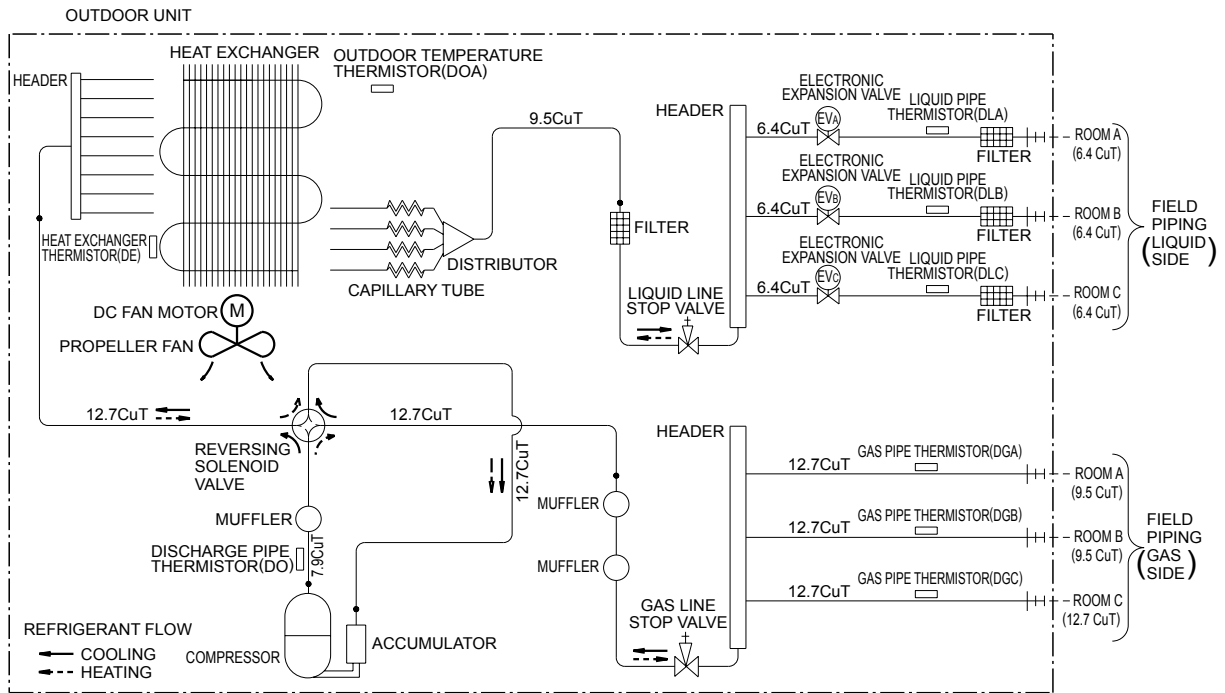

3D052055C

### 3MXS68EVMA

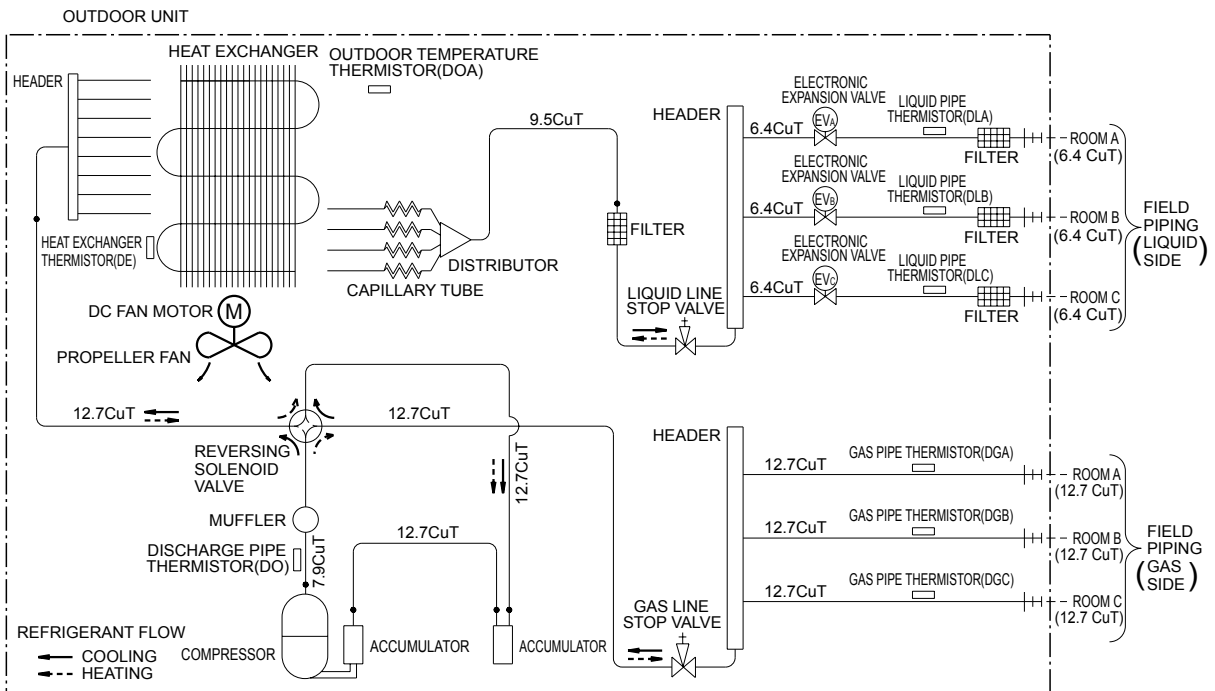

3D054639

4MXS80EVMA, 4MXS100EVL

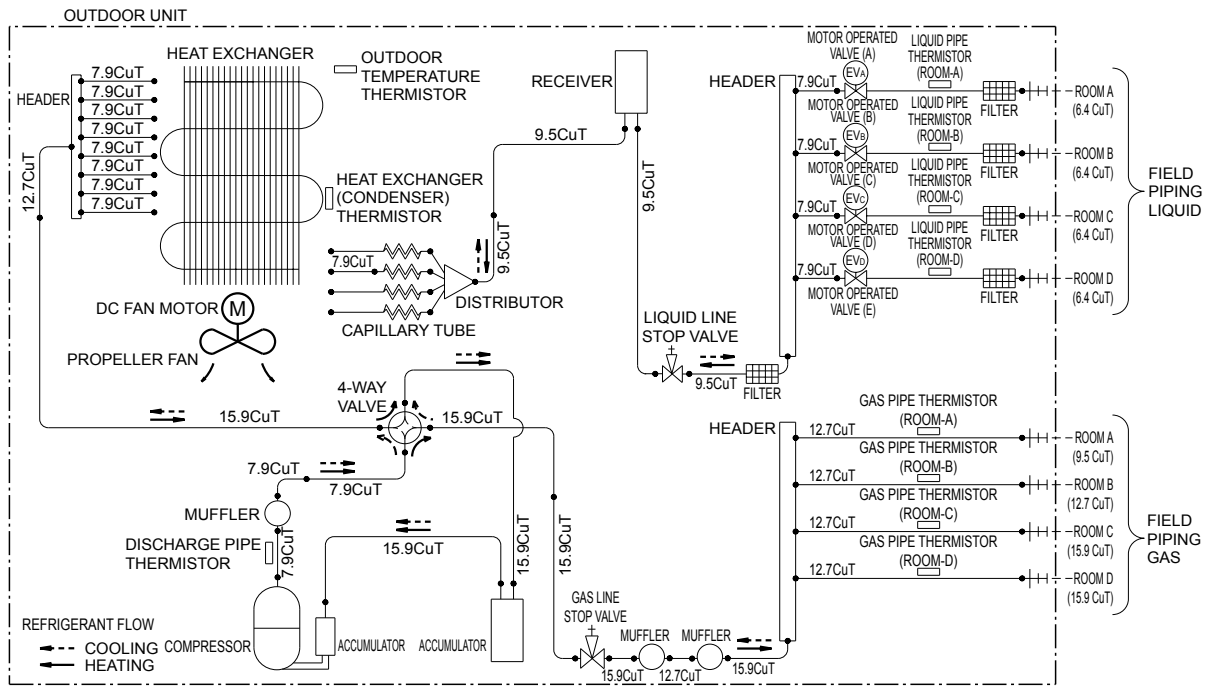

3D051937B

3MXS90EVL

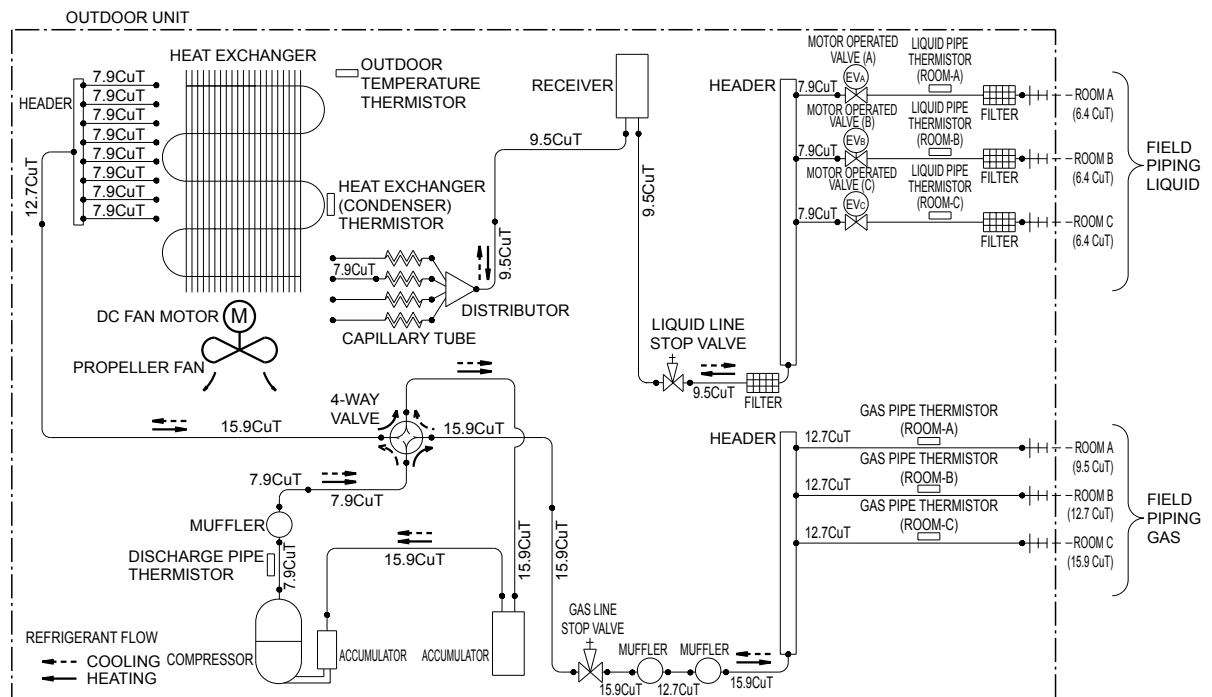

3D051939A

## 2. Wiring Diagrams

### 2.1 Indoor Units

#### 2.1.1 Wall Mounted Type

FTK(X)S25/35EVMA, FTKS25/35DVM, FTK(X)S20DVMA

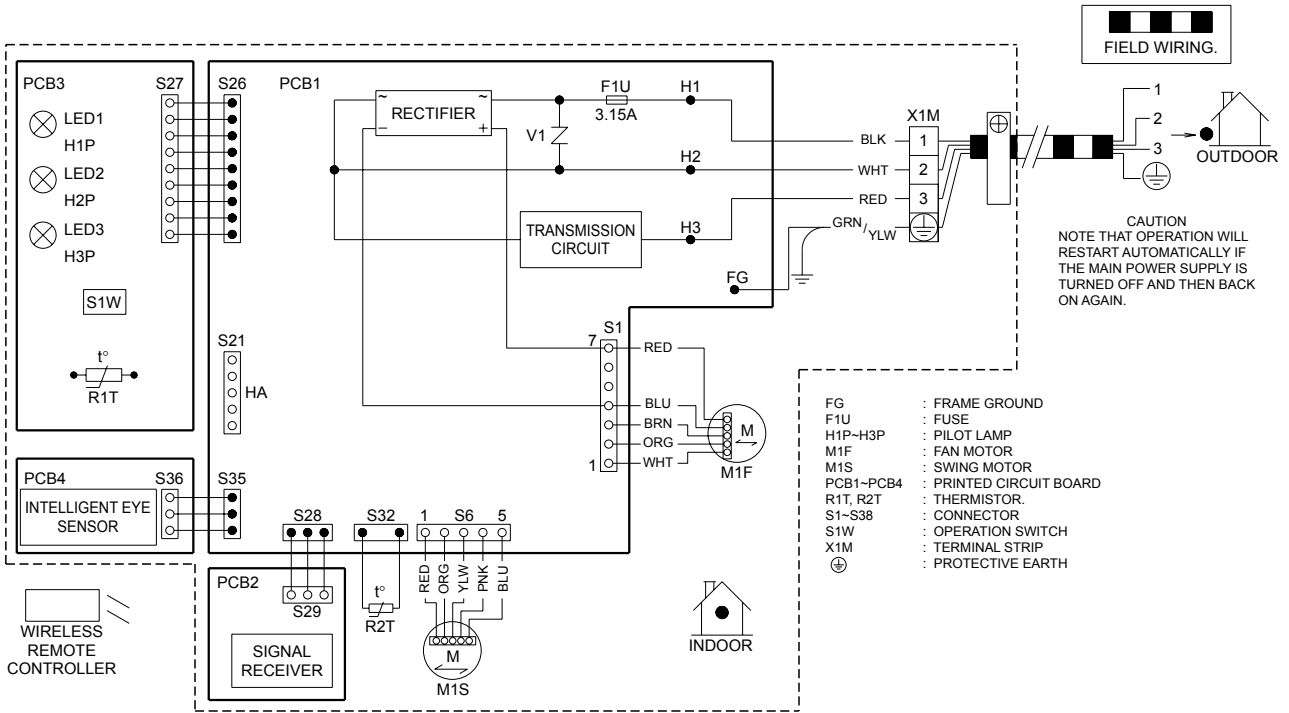

3D046453B

FTKS50BVMB, FTK(X)S50DVMT

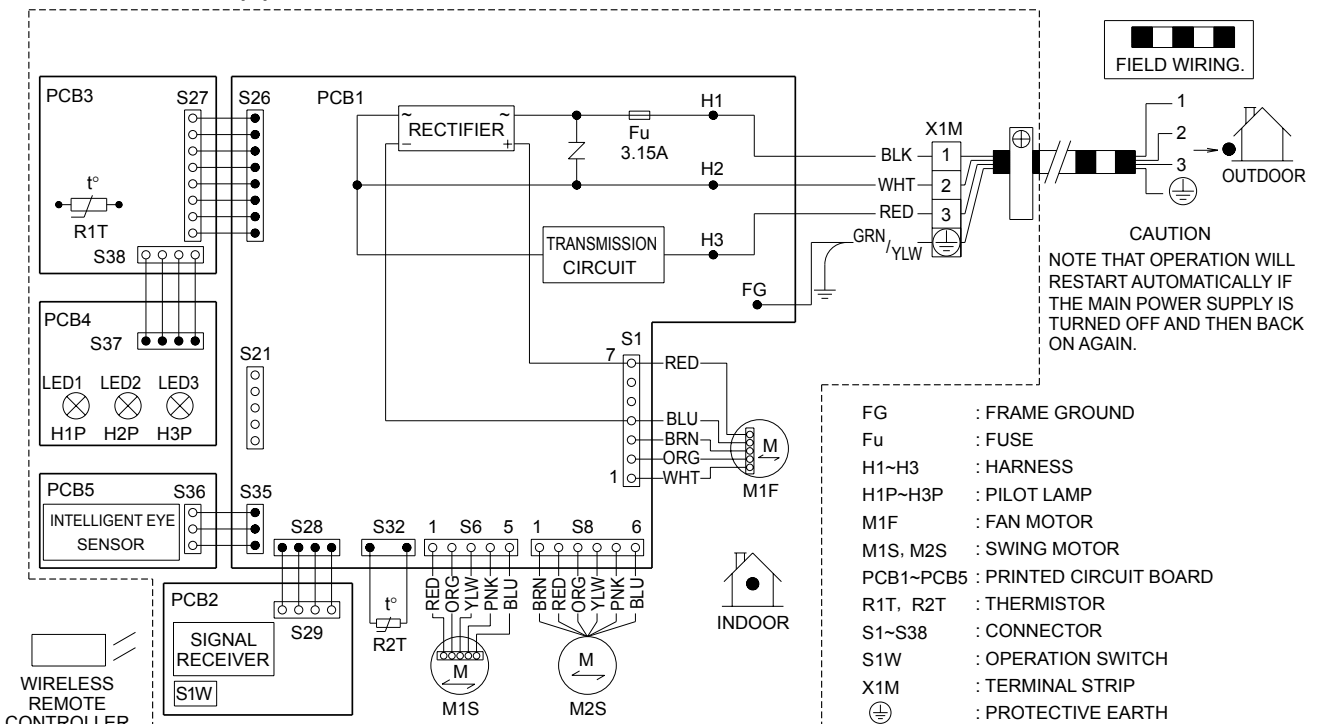

3D038065G

FTKS50/60/71FVM, FTK(X)S50/60/71FVMA, FTK(X)S60/71DVMT, FTKS60/71BVMB

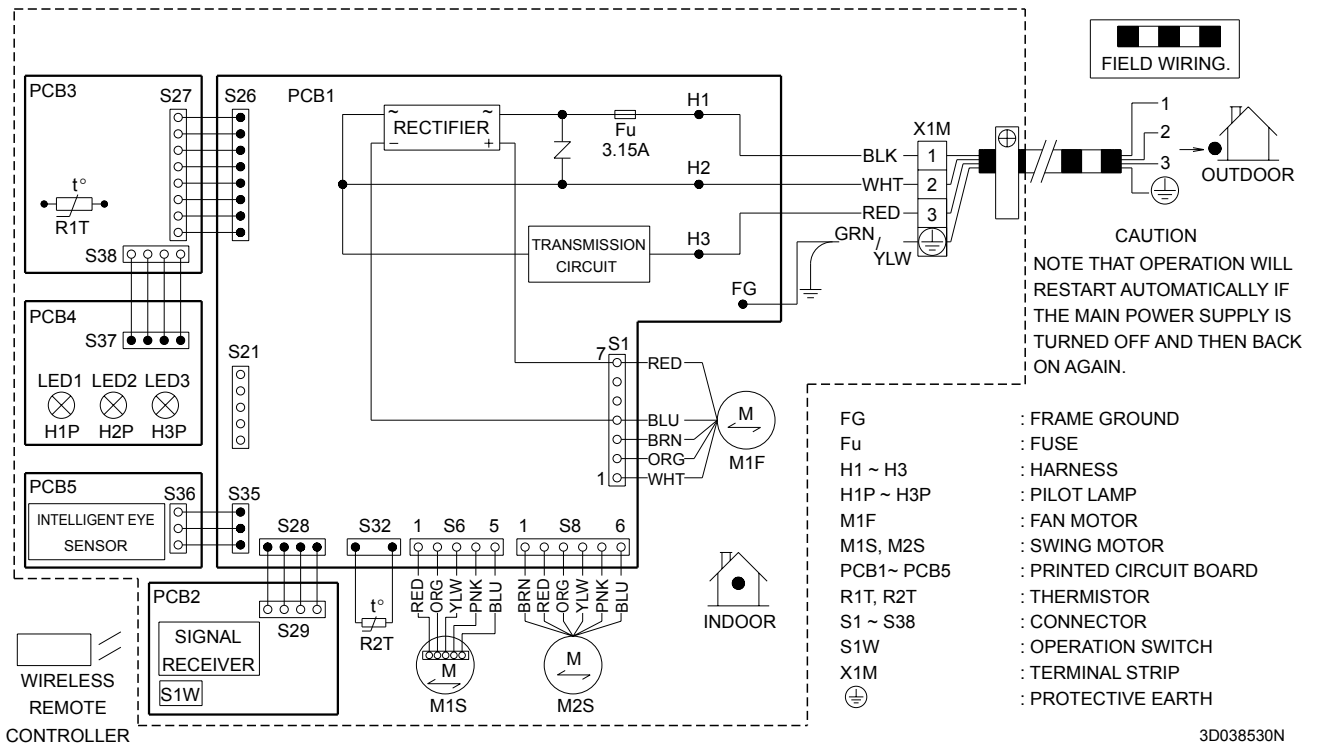

FTK(X)S20/25/35DVMT

線路圖

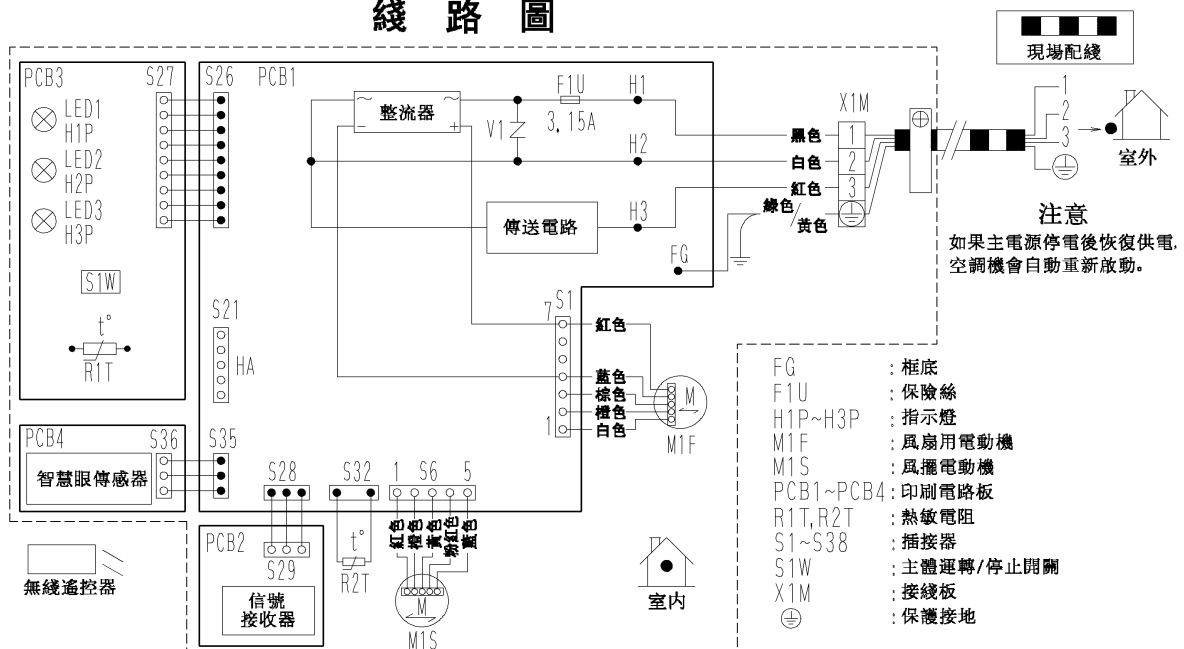



FTK(X)S50/60/71FVLT

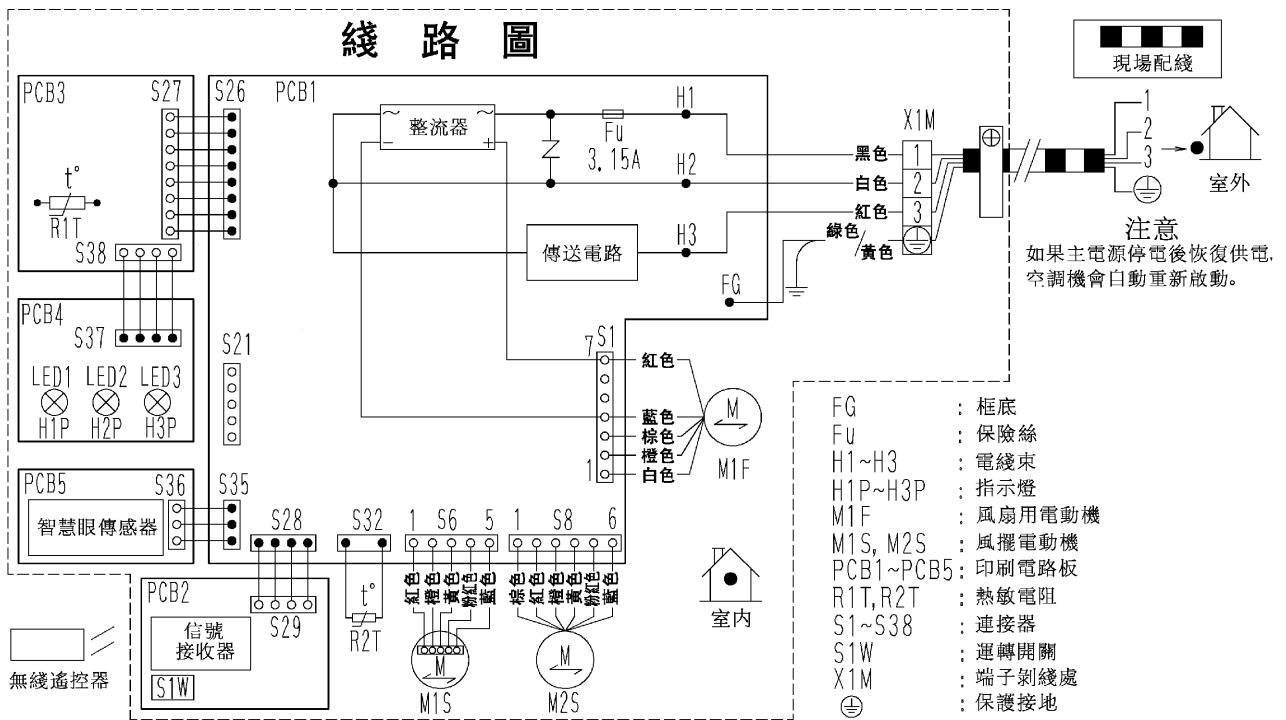

3D051729

### 2.1.2 Duct Connected Type

FDKS25/35CAVMB, FDKS50/60CVMB, FDKS25/35EAVMB, CDKS25/35/50/60CVMA, CDKS25/35EAVMA, FDXS25/35/50/60CVMA, CDXS25/35EAVMA

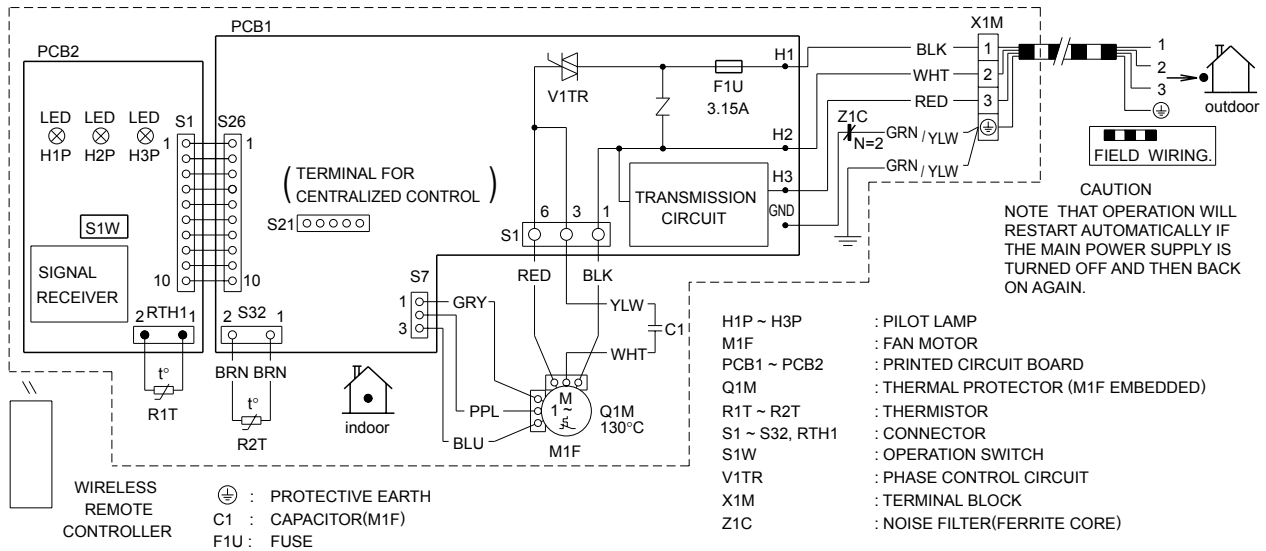

3D045012K

### CDK(X)S25/35/50/60DVMT, CDK(X)S25/35EAVMT

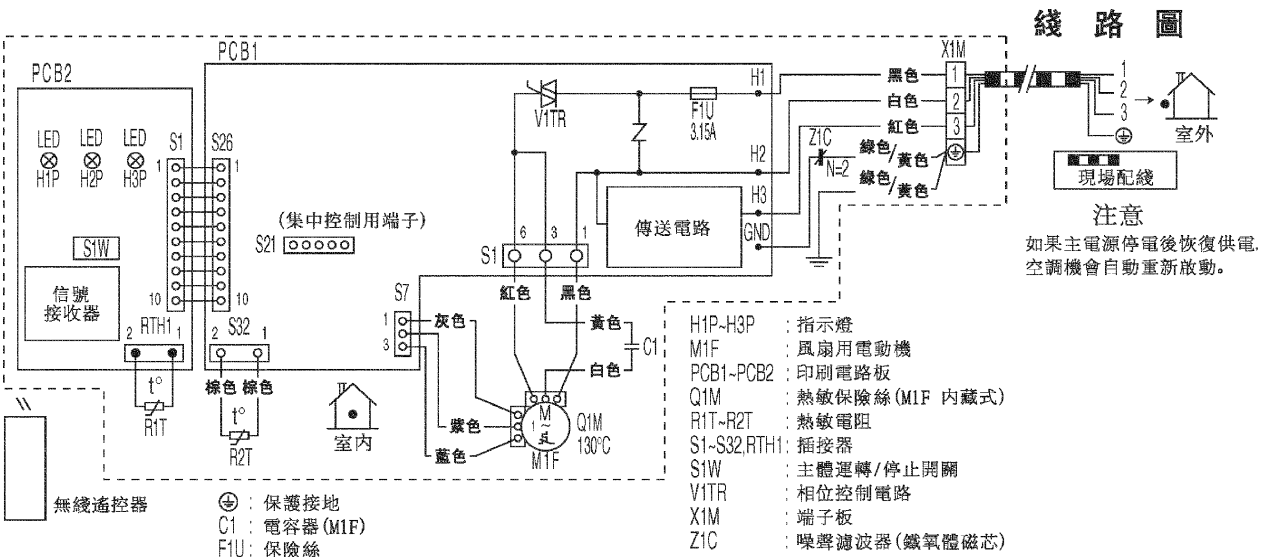

3D049284A

### 2.1.3 Floor / Ceiling Suspended Dual Type

FLXS25BVMA, FLXS35BVMA, FLXS50BVMA, FLXS60BVMA

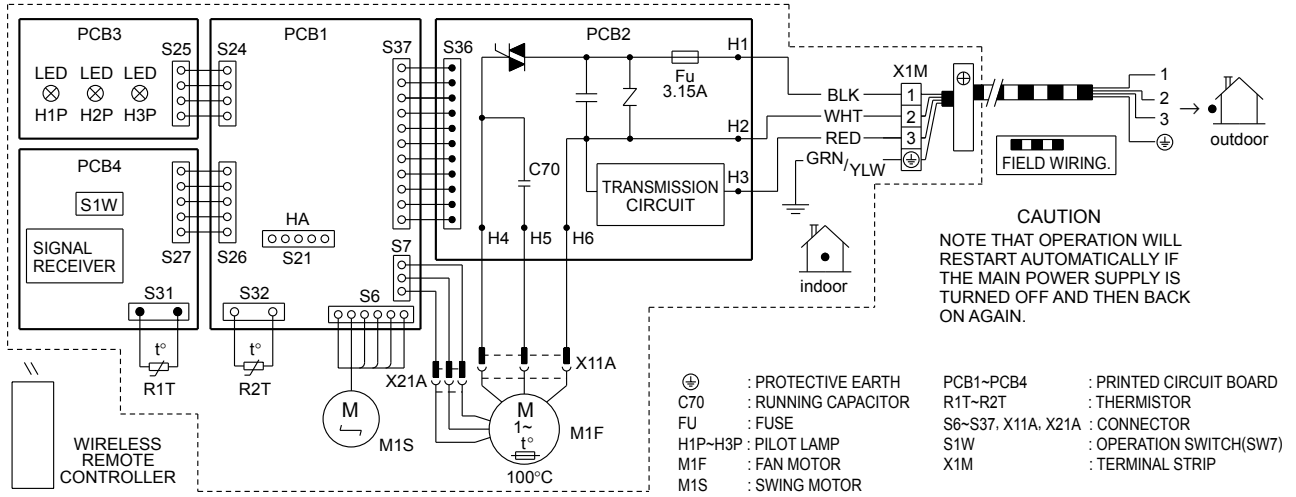

### 2.1.4 Floor Standing Type

FVXS35BVMA, FVXS50BVMA

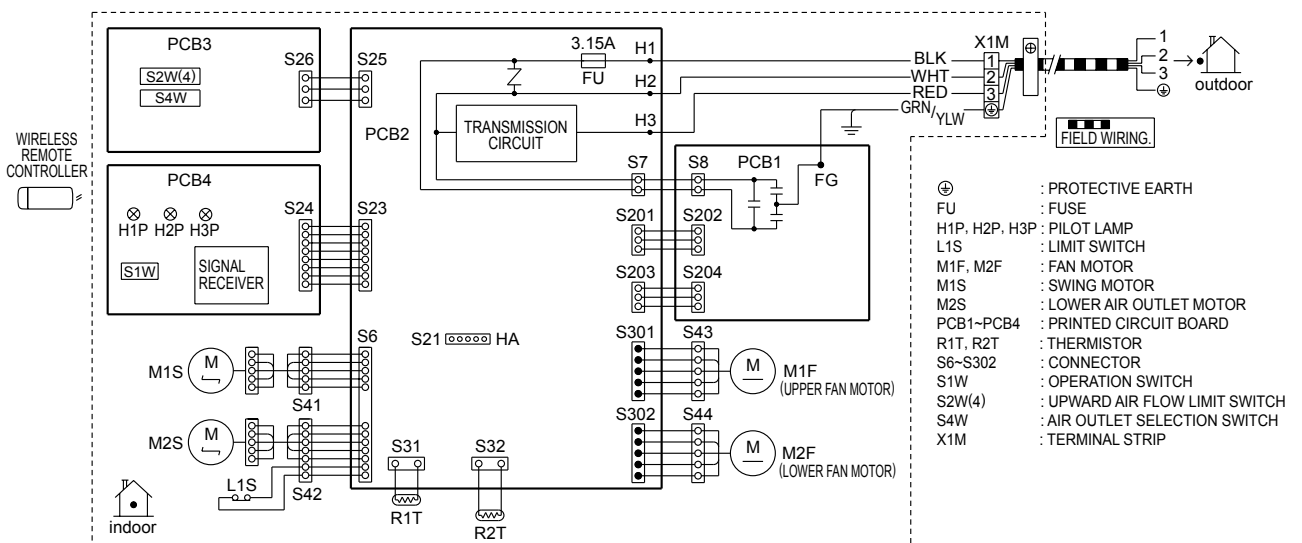

## 2.1.5 Ceiling Mounted Cassette Type

FFQ25B8V1B, FFQ35B8V1B, FFQ50B8V1B, FFQ60B8V1B

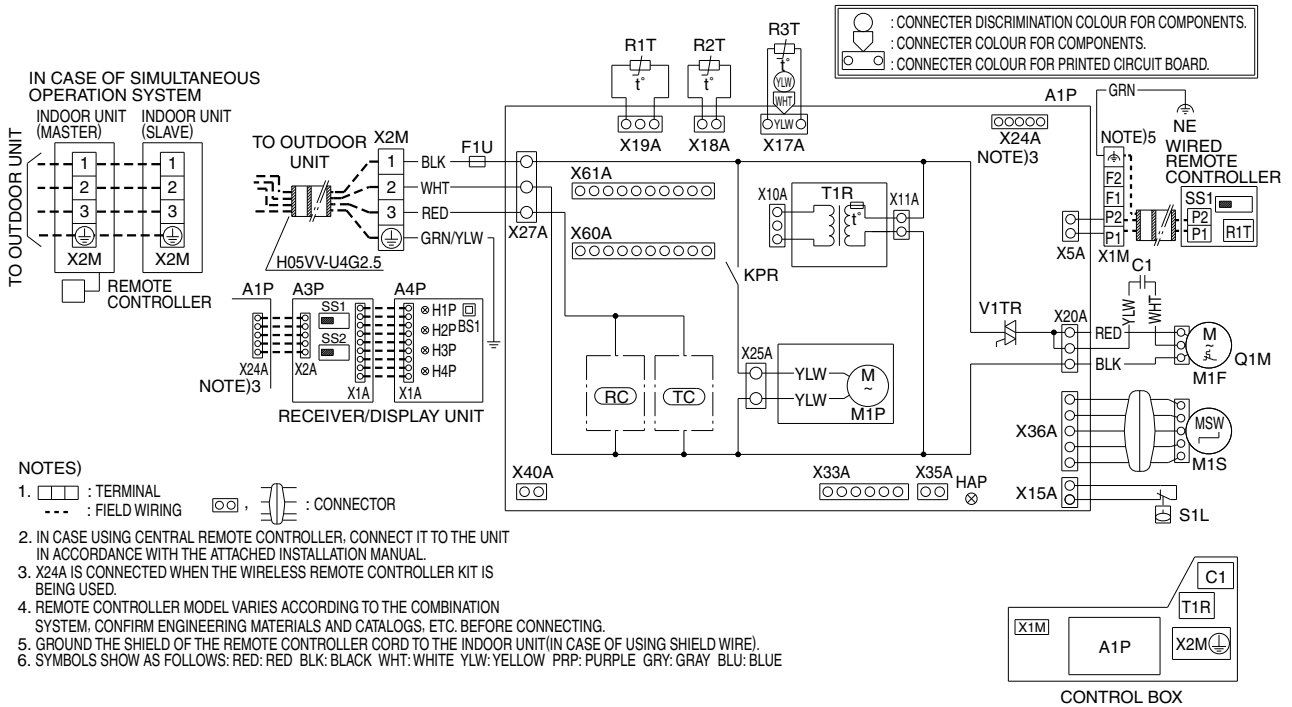

A1P	PRINTED CIRCUIT BOARD	BS1	PUSH BUTTON(ON/OFF)
C1	CAPACITOR(M1F)	H1P	LIGHT EMITTING DIODE (ON-RED)
F1U	FUSE(F5A 250V)	H2P	LIGHT EMITTING DIODE (TIMER-GREEN)
HAP	LIGHT EMITTING DIODE (SERVICE MONITOR GREEN)	H3P	LIGHT EMITTING DIODE (FILTER SIGN-RED)
KPR	MAGNETIC RELAY(M1P)	H4P	LIGHT EMITTING DIODE (DEFROST-ORANGE)
M1F	MOTOR(INDOOR FAN)	SS1	SELECTOR SWITCH (MAIN/SUB)
M1P	MOTOR(DRAIN PUMP)	SS2	SELECTOR SWITCH (WIRELESS ADDRESS SET)
M1S	MOTOR(SWING FLAP)	CONNECTOR FOR OPTIONAL PARTS	
Q1M	THERMO SWITCH(M1F EMBEDDED)	X33A	CONNECTOR (ADAPTOR FOR WIRING)
R1T	THERMISTOR(AIR)	X35A	CONNECTOR (GROUP CONTROL ADAPTOR)
R2T	THERMISTOR(COIL-1)	X40A	CONNECTOR (ON/OFF INPUT FROM OUTSIDE)
R3T	THERMISTOR(COIL-2)	X60A	CONNECTOR (INTERFACE ADAPTOR FOR SKYAIR SERIES)
S1L	FLOAT SWITCH	X61A	
T1R	TRANSFORMER(220-240V/22V)		
V1TR	PHASE CONTROL CIRCUIT		
X1M	TERMINAL STRIP		
X2M	TERMINAL STRIP		
(RC)	SIGNAL RECEIVER CIRCUIT		
(TC)	SIGNAL TRANSMISSION CIRCUIT		
WIRED REMOTE CONTROLLER			
R1T	THERMISTOR(AIR)		
SS1	SELECTOR SWITCH(MAIN/SUB)		
WIRELESS REMOTE CONTROLLER (RECEIVER/DISPLAY UNIT)			
A3P	PRINTED CIRCUIT BOARD		
A4P	PRINTED CIRCUIT BOARD		

3D038357B

## 2.2 Outdoor Units

### 2.2.1 Cooling only

#### 3MKS58EVMA, 3MKS50ESG

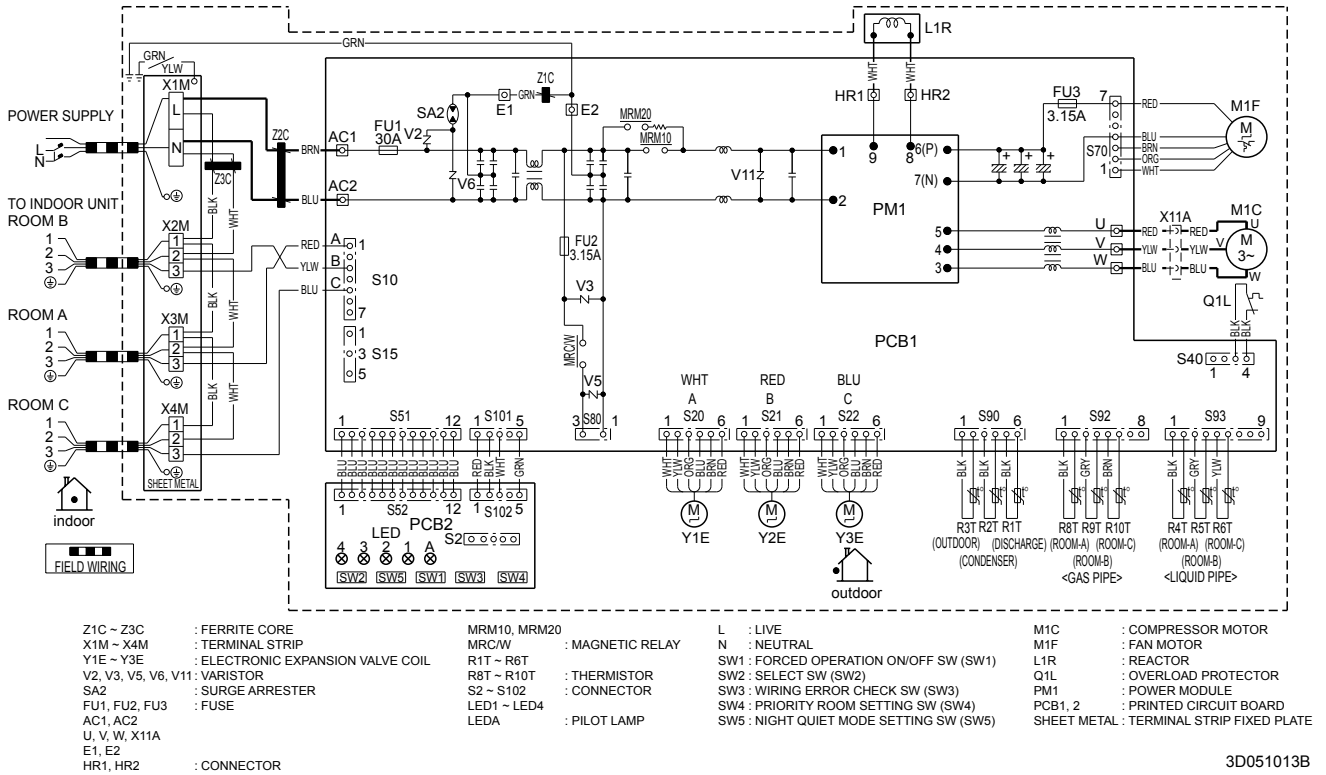

3D051013B

#### 3MKS75EVMA, 3MKS71ESG

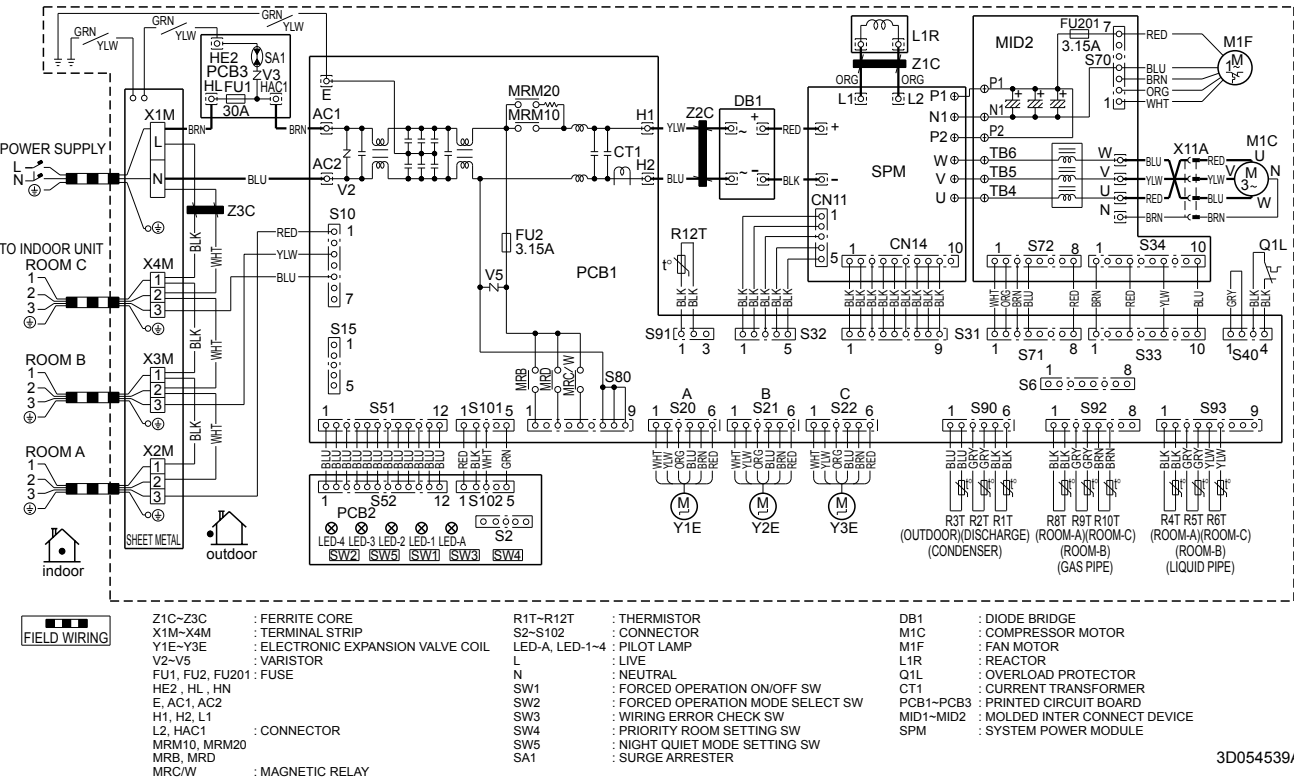

3D054539A

4MKS90EVMA, 4MKS100EVL, 4MKS80ESG

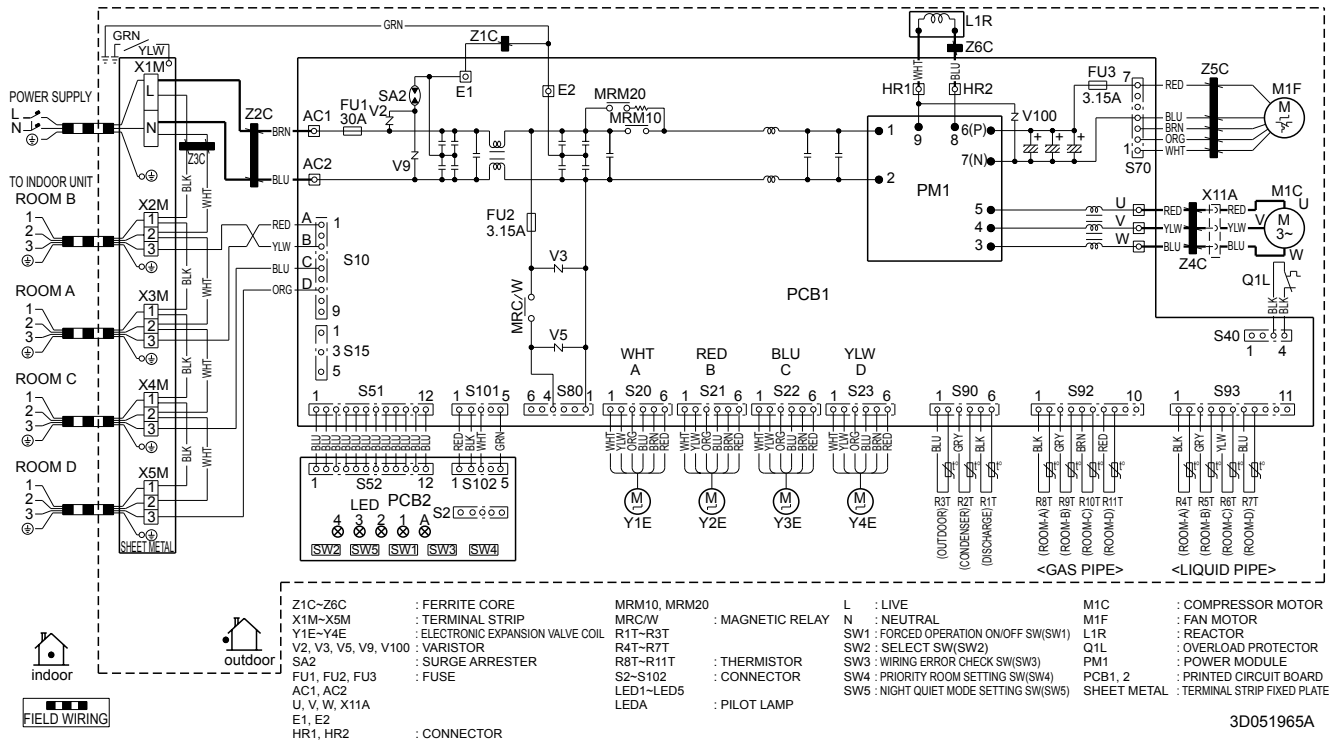

3MKS90EVL

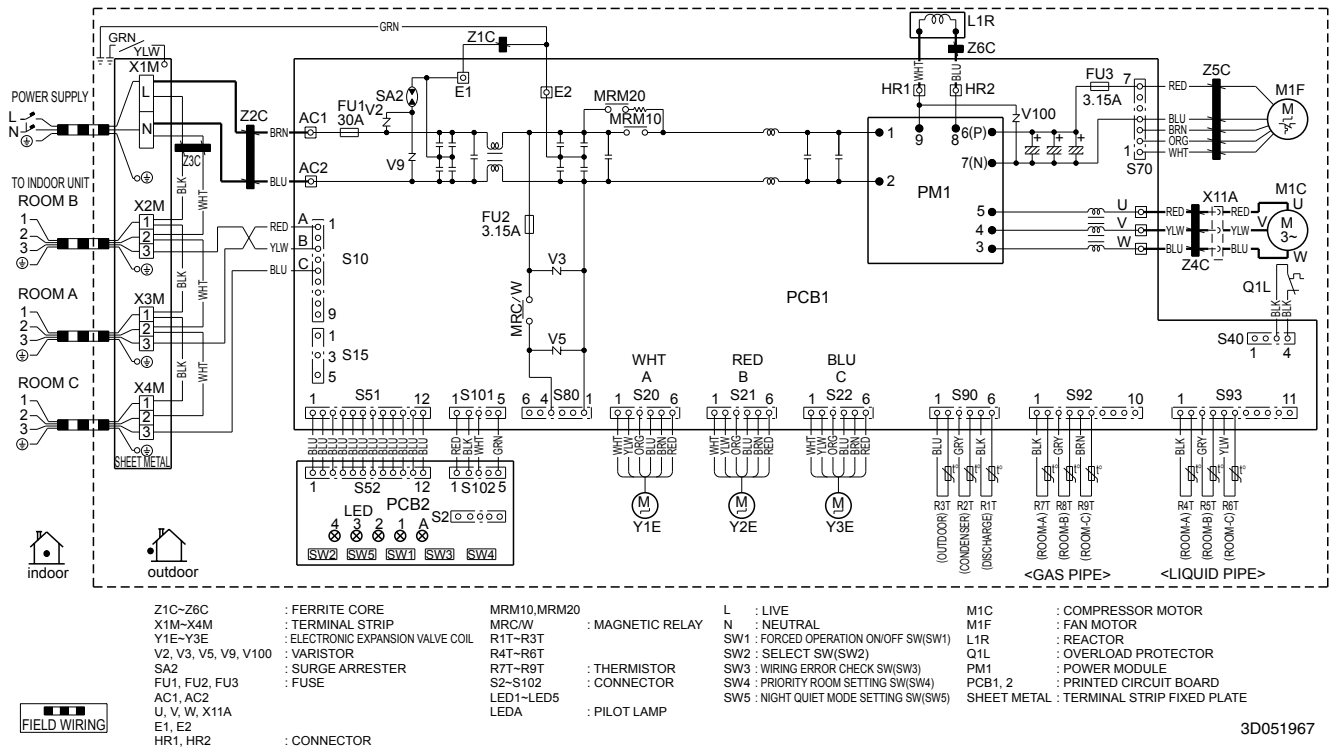

3MKS50DVM

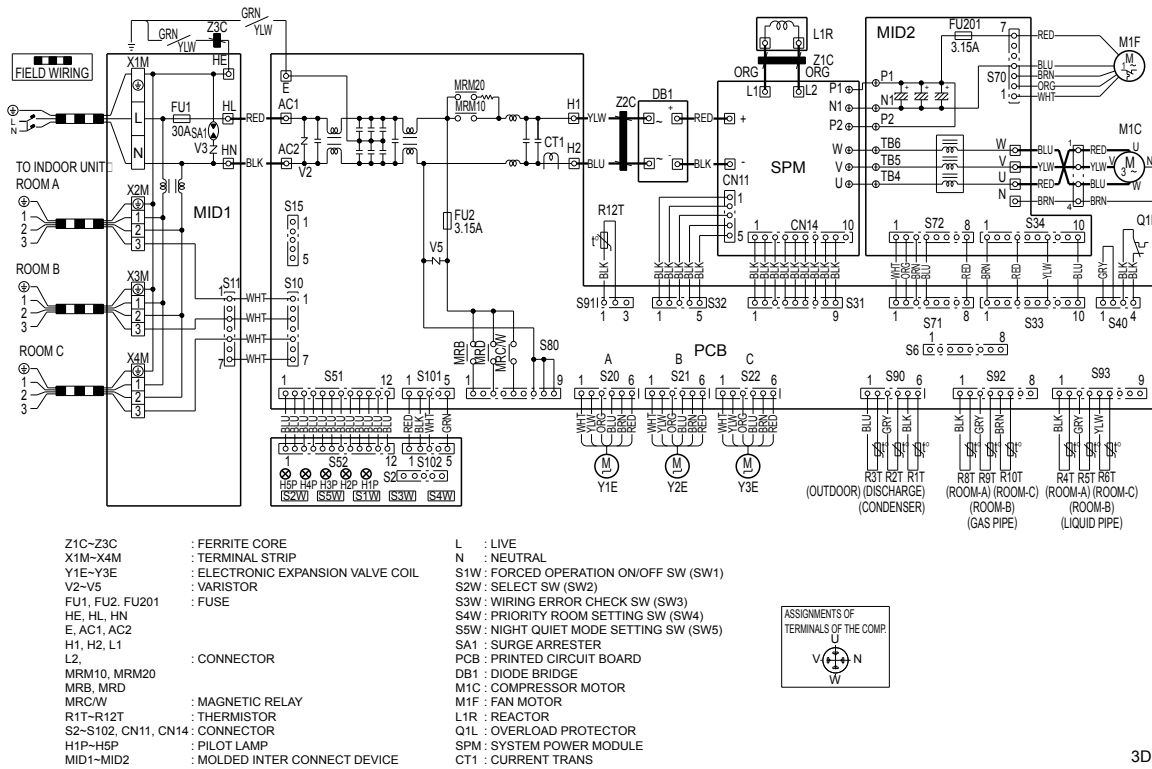

4MKS71DVM

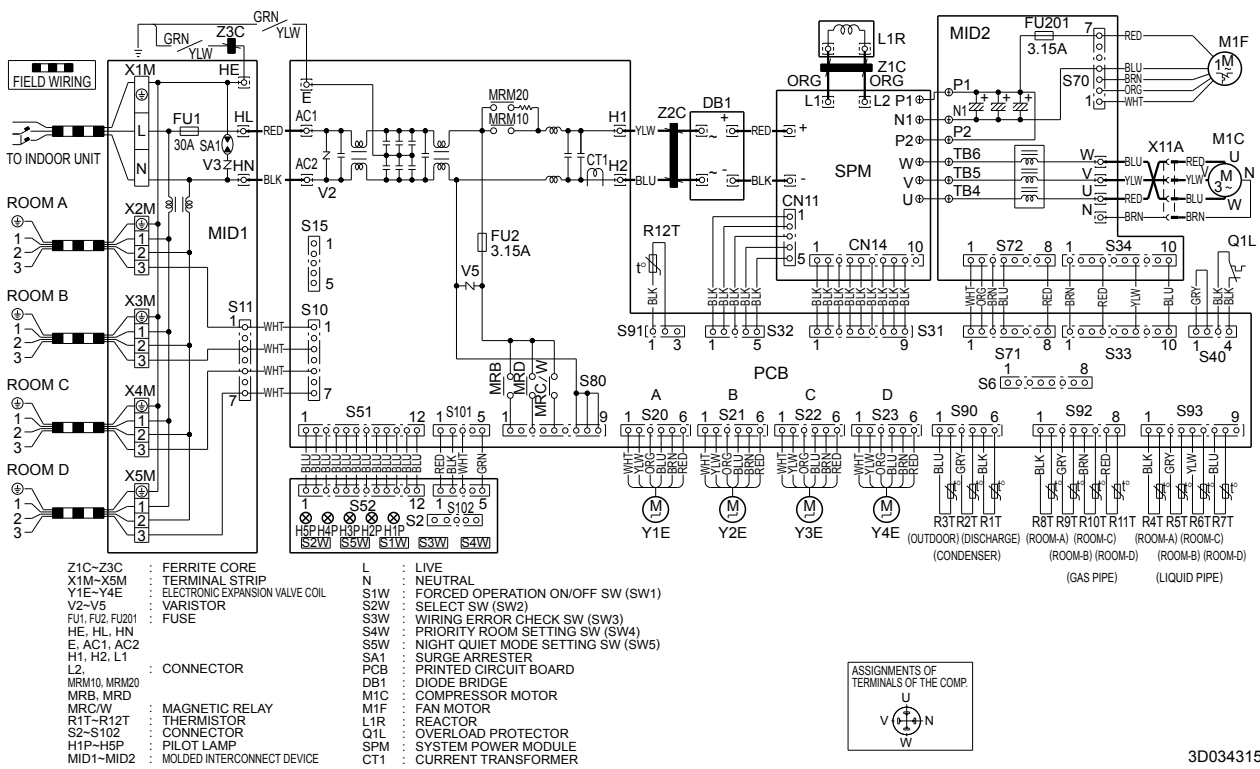

## 2.2.2 Heat Pump

### 3MXS52EVMA

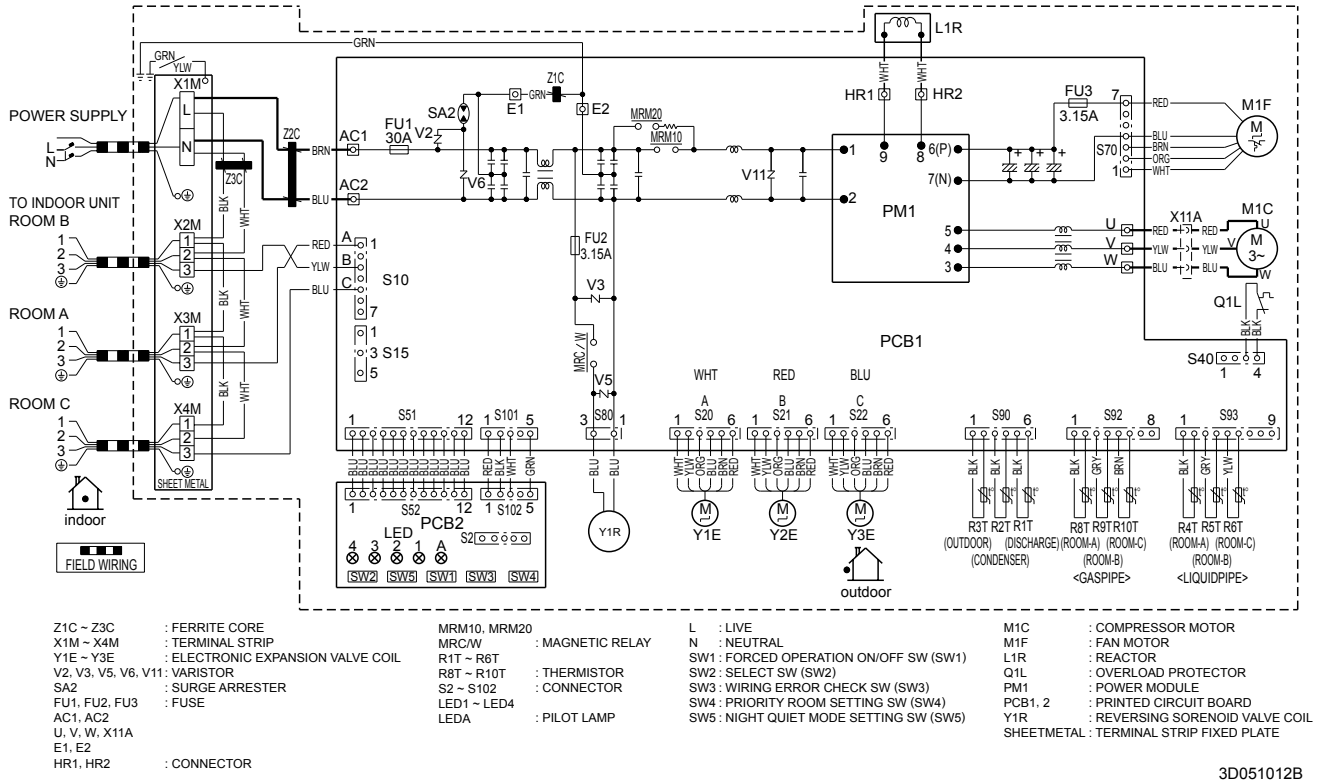

3D051012B

### 3MXS68EVMA

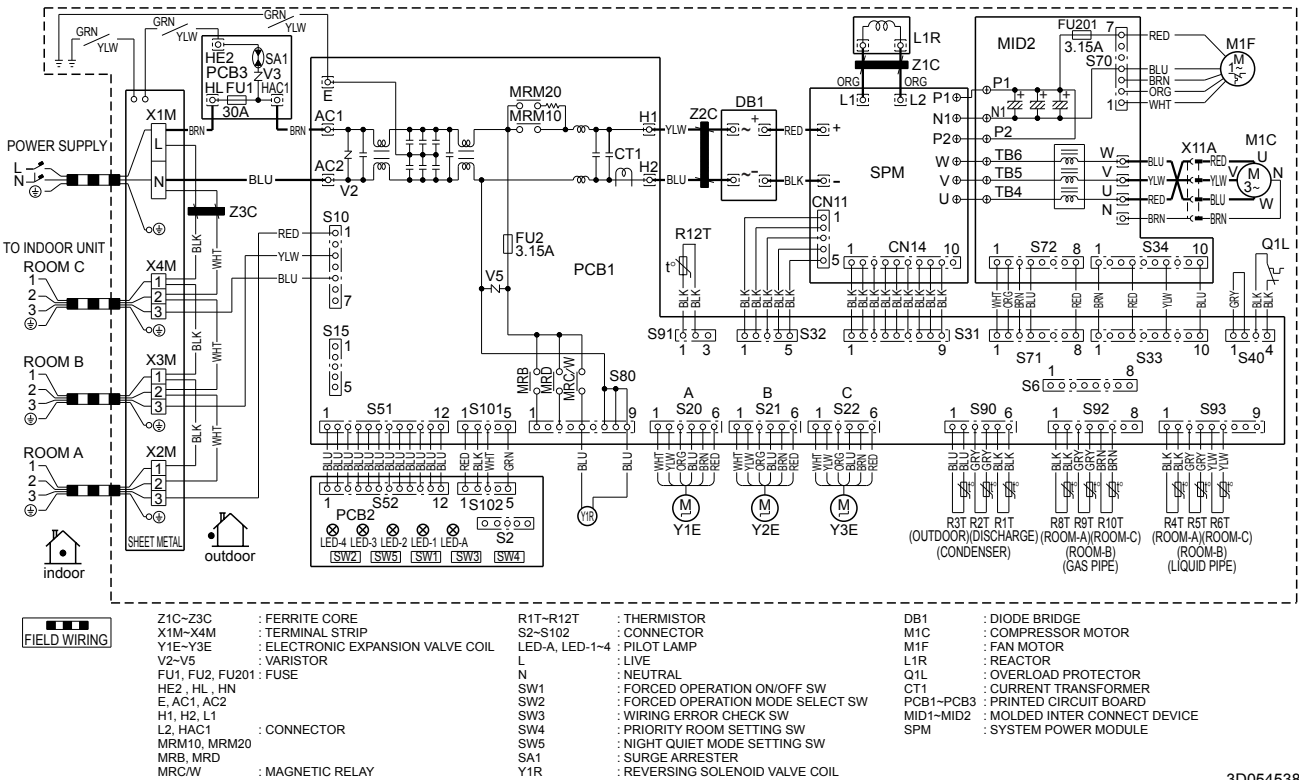

3D054538



4MXS80EVMA, 4MXS100EVL

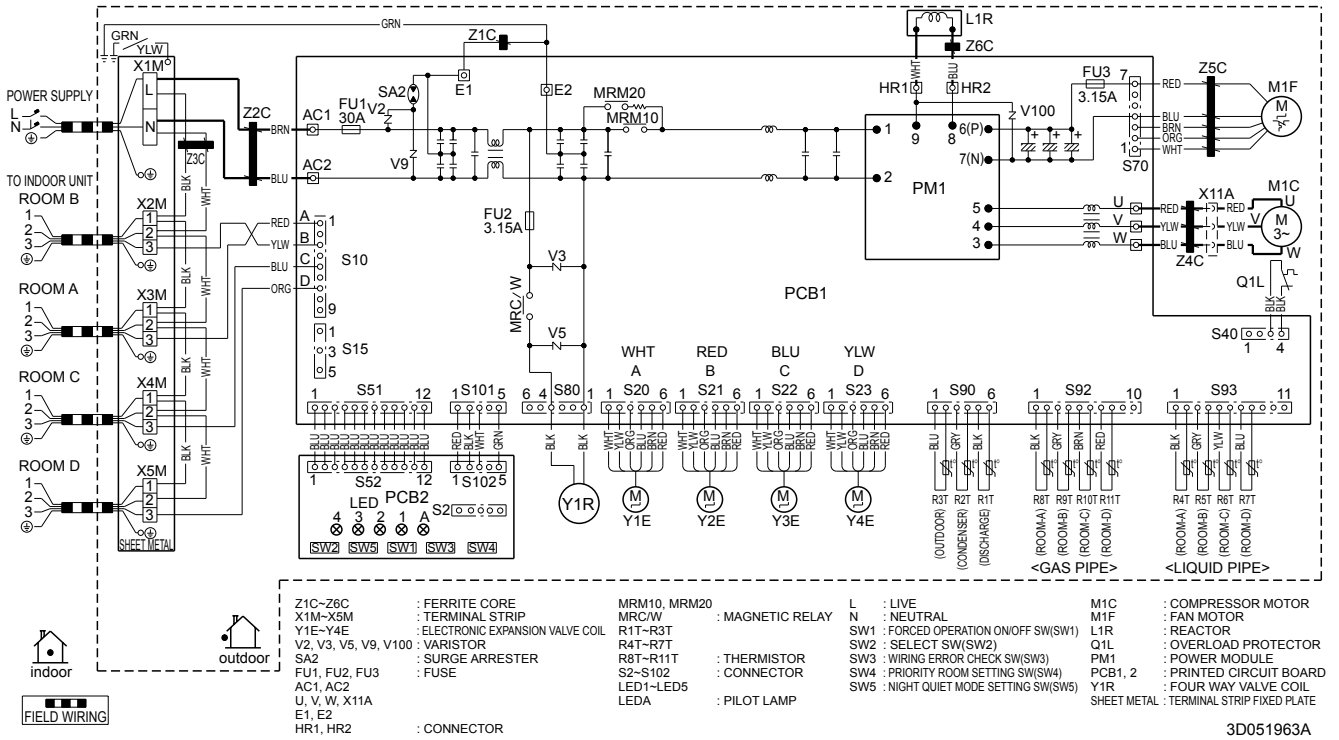

3MXS90EVL

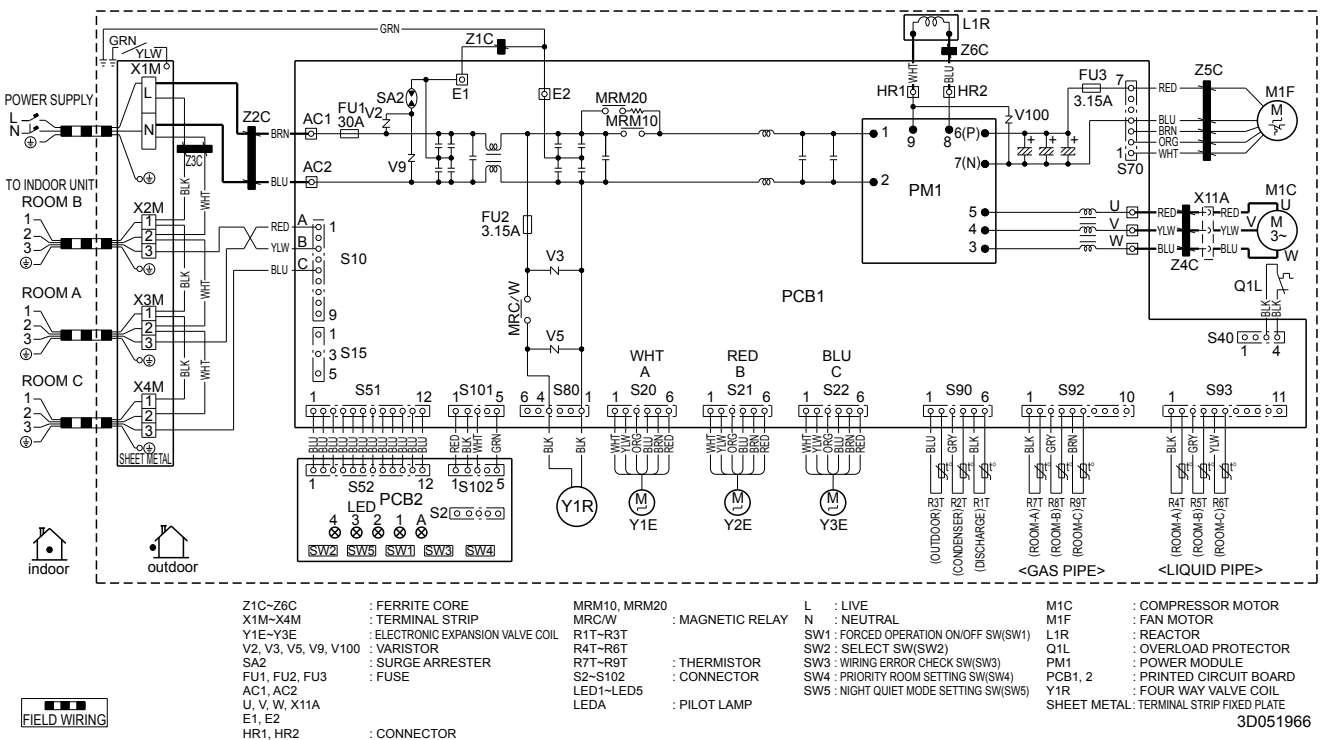

# Index

## Numerics

3-minute stand-by ..... 103

## A

A1 ..... 211  
 A5 ..... 212, 222  
 A6 ..... 214, 215  
 AC1 ..... 67, 70, 73, 341  
 AC2 ..... 67, 70, 73, 341  
 address setting jumper ..... 52, 54, 56, 58, 61  
 adjusting the air flow direction ..... 147  
 air purifying filter ..... 93  
 air purifying filter with photocatalytic deodorizing  
 function ..... 93  
 anti-icing function in other rooms ..... 259  
 ARC433 ..... 205  
 AUTO · DRY · COOL · HEAT · FAN operation ..... 145  
 automatic air flow control ..... 81  
 automatic operation ..... 83  
 auto-restart ..... 52, 58, 61  
 auto-restart function ..... 93  
 auto-swing ..... 80

## B

BS1 ..... 64  
 buzzer PCB ..... 55

## C

C4 ..... 217  
 C7 ..... 218  
 C9 ..... 217  
 capacitor voltage check ..... 267  
 care and cleaning ..... 169  
 centralized control ..... 52, 54, 56, 58, 61  
 check No.01 ..... 260  
 check No.02 ..... 260  
 check No.03 ..... 260  
 check No.04 ..... 261  
 check No.05 ..... 262  
 check No.06 ..... 263  
 check No.07 ..... 264  
 check No.08 ..... 265  
 check No.09 ..... 265  
 check No.10 ..... 266  
 check No.11 ..... 266  
 check No.12 ..... 267  
 check No.13 ..... 267  
 check No.14 ..... 268  
 check No.15 ..... 268  
 check No.16 ..... 269  
 CN11 ..... 71, 74  
 CN14 ..... 71, 74  
 coils ..... 345  
 compressor ..... 301, 317, 354  
 compressor lock ..... 226

compressor overload ..... 225  
 compressor protection function ..... 103  
 compressor sensor system abnormality ..... 236  
 connection pipe condensation preventing function  
 ..... 116  
 connectors ..... 52, 54, 56, 58, 61, 64, 67, 70, 73  
 control PCB ..... 285, 309, 340  
 control PCB (A1P) ..... 65  
 control PCB (indoor unit) ..... 53, 55, 56, 59, 63  
 control PCB (outdoor unit D series) ..... 74  
 control PCB (outdoor unit E series  
 68-75 class models) ..... 71  
 cooling / heating mode lock ..... 117  
 CT or related abnormality ..... 239

## D

DC fan lock ..... 228  
 defrost control ..... 107  
 diagnosis mode ..... 206  
 diode bridge ..... 358  
 discharge grille ..... 275, 324  
 discharge pipe ..... 111  
 discharge pipe temperature control ..... 104, 233  
 discharge pipe thermistor ..... 95, 97, 111, 314, 349  
 discharge pressure check ..... 265  
 display PCB ..... 53, 55, 57, 60, 63, 342  
 display PCB (A4P) ..... 66  
 distributor ..... 299

## E

E ..... 70, 73  
 E1 ..... 224  
 E5 ..... 225  
 E6 ..... 226, 227  
 E7 ..... 228  
 E8 ..... 229  
 EA ..... 231  
 econo mode ..... 86  
 econo operation ..... 157  
 econo-mode-proof setting ..... 117  
 electrical box ..... 277, 304, 334  
 electrical box temperature rise ..... 243  
 electronic expansion valve check ..... 261  
 electronic expansion valve coil ..... 296, 313  
 electronic expansion valve control ..... 108  
 error codes  
 A1 ..... 211  
 A5 ..... 212, 222  
 A6 ..... 214, 215  
 C4 ..... 217  
 C7 ..... 218  
 C9 ..... 217  
 E1 ..... 224  
 E5 ..... 225  
 E6 ..... 226, 227

E7 .....	228
E8 .....	229
EA .....	231
F3 .....	233
F6 .....	234
H0 .....	236
H6 .....	238
H8 .....	239
H9 .....	241
J3 .....	241
J6 .....	241
J8 .....	241
J9 .....	241
L3 .....	243, 245
L4 .....	247, 249
L5 .....	251
P4 .....	241
U0 .....	253, 255
U2 .....	257
U4 .....	219
U7 .....	258
UA .....	221, 259
UH .....	259
error codes and description of fault.....	208
<b>F</b>	
F3 .....	233
F6 .....	234
fan control .....	106
fan motor .....	290, 311, 344
fan motor connector output check.....	260
fan motor or related abnormality	
AC motor .....	214
DC motor .....	215
fan speed control.....	81
fan speed setting.....	52, 54, 56, 58, 61
filter	
air purifying filter with photocatalytic deodorizing	
function .....	93
air-purifying filter .....	93
mold proof air filter (prefilter).....	93
photocatalytic deodorizing filter .....	92
titanium apatite photocatalytic air-purifying filter	
.....	92
filter PCB .....	71
forced operation mode .....	113
forced operation ON/OFF switch.....	52, 56, 58, 61, 67
four way valve .....	300, 315
four way valve abnormality.....	231
four way valve coil.....	296, 313, 349
four way valve operation compensation.....	103
four way valve performance check.....	262
four way valve switching .....	103
freeze-up protection control .....	105, 222
freeze-up protection control or	
high pressure control .....	212
frequency control.....	100
frequency principle .....	78
front panel .....	273, 322, 324
FU .....	61
FU1 .....	52, 54, 56, 58, 67, 70, 73
FU2 .....	67, 70, 73
FU201 .....	70, 73
FU3 .....	67
functions .....	2
fuse .....	52, 54, 56, 58, 61, 67, 70, 73
<b>G</b>	
gas pipe isothermal control during cooling.....	110
gas pipe thermistor.....	95, 97, 305, 314
<b>H</b>	
H0.....	236
H1.....	70, 73, 341
H2.....	70, 73, 341
H6.....	238
H8.....	239
H9.....	241
HA .....	52, 54
HAC1.....	70
Hall IC .....	81, 214, 215
Hall IC check .....	269
HAP .....	64
HE .....	73
HE2 .....	70
heat exchanger thermistor .....	314, 347
heating peak-cut control .....	105
high pressure control in cooling .....	234
HL.....	70, 73
HN .....	73
HOME LEAVE operation .....	90, 159
hot start function.....	92
HR1 .....	67
HR2 .....	67
<b>I</b>	
indoor heat exchanger thermistor .....	96, 98
indoor unit PCB abnormality .....	211
input current control .....	104
input over current detection.....	229
installation condition check .....	264
instruction .....	121
insufficient gas .....	253
insufficient gas control.....	112
INTELLIGENT EYE .....	88
INTELLIGENT EYE operation.....	161
INTELLIGENT EYE sensor PCB.....	53, 55
inverter PCB.....	310
inverter PCB (MID2).....	72, 75
inverter POWERFUL operation.....	91
inverter units refrigerant system check.....	266
<b>J</b>	
J3 .....	241
J4 .....	357
J6 .....	241
J8 .....	241
J9 .....	241
JA .....	52, 54, 56, 58, 61, 357
JB .....	52, 54, 56, 58, 61, 357
JC .....	52, 54, 56, 58, 61, 357
jumper setting.....	357

<b>L</b>	
L1 .....	71, 74
L2 .....	71, 74
L3 .....	243, 245
L4 .....	247, 249
L5 .....	251
LED A .....	52, 54, 56, 58, 61, 67, 70, 73
LED1 .....	52, 54, 56, 58, 64, 67, 70, 73
LED11 .....	61
LED12 .....	61
LED14 .....	61
LED2 .....	52, 54, 56, 58, 64, 67, 70, 73
LED3 .....	52, 54, 56, 58, 64, 67, 70, 73
LED4 .....	64, 67, 70, 73
limit switch continuity check .....	260
liquid compression protection function 2 .....	106
liquid pipe thermistor .....	96, 305, 314, 347
low Hz high pressure limit .....	108
low-voltage detection .....	257
<b>M</b>	
main circuit electrolytic capacitor check .....	268
main PCB (outdoor unit E series 50-58 class models) .....	68
main PCB (outdoor unit E series 80-100 class models) .....	68
main structural parts .....	94
MID1 .....	74
MID2 .....	72, 75
mode hierarchy .....	99
mold proof air filter (prefilter) .....	93
mold proof operation .....	87, 158
motorized valve coil .....	345
multi system .....	167
<b>N</b>	
N .....	70, 73
names of parts .....	124
night set mode .....	85
<b>O</b>	
oil recovery function .....	111
OL activation .....	225
ON/OFF button on indoor unit .....	92
opening limit .....	110
operation lamp .....	202
outdoor air thermistor .....	283, 314
outdoor heat exchanger thermistor .....	95, 97
outdoor unit fan system check (with DC motor) .....	265
outdoor unit PCB abnormality .....	224
OUTDOOR UNIT QUIET operation .....	156
outer panels .....	303, 318
output over current detection .....	251
over current .....	112
overload .....	112
overload protector .....	70, 73
overload relay .....	305
over-voltage detection .....	257
<b>P</b>	
P4 .....	241
PCB .....	308, 340
photocatalytic deodorizing filter .....	92
PI control .....	101
pipng diagrams .....	360
position sensor abnormality .....	238
power failure recovery function .....	52, 54, 56, 58, 61
power supply PCB .....	59
power supply PCB (35 class) .....	62
power supply PCB (50 class) .....	62
power supply waveforms check .....	266
power transistor .....	358
power transistor check .....	267
power-airflow dual flaps .....	80
POWERFUL operation .....	155
POWERFUL operation mode .....	116
preheating operation .....	103
preparation before operation .....	142
pressure equalization control .....	110
preventing indoor freezing .....	113
printed circuit board (PCB)	
buzzer PCB .....	55
control PCB .....	285, 309
control PCB (A1P) .....	65
control PCB (indoor unit) .....	53, 55, 56, 59, 63
control PCB (outdoor unit D series) .....	74
control PCB (outdoor unit E series 68-75 class models) .....	71
display PCB .....	53, 55, 57, 60, 63
display PCB (A4P) .....	66
filter PCB .....	71
INTELLIGENT EYE sensor PCB .....	53, 55
inverter PCB .....	310
inverter PCB (MID2) .....	72, 75
main PCB (outdoor unit E series 50-58 class models) .....	68
main PCB (outdoor unit E series 80-100 class models) .....	68
MID1 .....	74
power supply PCB .....	59
power supply PCB (35 class) .....	62
power supply PCB (50 class) .....	62
service monitor PCB .....	69, 71, 308, 310
service PCB .....	284
signal receiver PCB .....	53, 55, 60, 63
signal receiver PCB (A3P) .....	66
SPM .....	72, 75
priority room setting .....	116
problem symptoms and measures .....	204
programme dry function .....	82
propeller fan .....	290
<b>R</b>	
radiation fin temperature rise .....	247
reactor .....	341
remote controller .....	205
removal procedure	
coils .....	345
compressor .....	301, 317, 354
distributor .....	299
electrical box .....	277, 304, 334
electronic expansion valve coil .....	296, 313

fan motor .....	290, 311, 344
four way valve.....	300, 315
four way valve coil .....	296, 313
outer panels.....	303, 318
panels and plates .....	272
PCB .....	284, 308, 340
printed circuit board (PCB) .....	284
propeller fan.....	290
shunt.....	315, 316
solenoid valve.....	315, 316
solenoid valve coil .....	313
sound blanket .....	292, 312, 351
thermistor.....	296, 313
thermistors.....	345
right side panel.....	292
RTH1.....	52, 54, 56

**S**

S1.....	52, 54, 56
S10.....	67, 70, 73, 341
S101.....	67, 70, 73, 341
S102.....	67, 70, 73, 284, 342
S11.....	73
S15.....	67
S20.....	67, 70, 73, 279, 305, 335
S201.....	61
S202.....	61
S203.....	61
S204.....	61
S21.....	52, 54, 56, 58, 61, 67, 70, 73, 279, 305, 335
S22.....	67, 70, 73, 279, 305, 335
S23.....	61, 67, 73, 279, 305, 335
S24.....	58, 61
S25.....	58, 61
S26.....	52, 54, 56, 58, 61
S27.....	52, 54, 58
S28.....	52, 54
S29.....	52, 54
S301.....	61
S302.....	61
S31.....	58, 61, 70, 73, 309, 341
S32.....	52, 54, 56, 58, 61, 70, 73, 309, 341
S33.....	70, 73, 309, 341
S34.....	70, 73
S35.....	52, 54
S36.....	52, 54, 58
S37.....	54, 58
S38.....	54
S40.....	67, 70, 73, 280, 305, 337
S51.....	67, 70, 73, 341
S52.....	67, 70, 73, 284, 342
S6.....	52, 54, 58, 61
S7.....	56, 58, 61
S70.....	67, 70, 73, 278, 335
S71.....	70, 73, 309, 341
S72.....	70, 73
S8.....	54, 61
S80.....	67, 70, 73, 281, 305, 335
S90.....	67, 70, 73, 280, 297, 305, 314, 336
S91.....	70, 73
S92.....	67, 70, 73, 280, 297, 305, 314, 336

S93.....	67, 70, 73, 280, 297, 305, 314, 336
SC control .....	110
self-diagnosis digital display.....	93
sensor malfunction detection .....	112
service check function.....	205
service monitor PCB .....	69, 71, 308, 310
service PCB .....	284
shunt .....	315, 316
shutter drive motor / shutter limit switch abnormality .....	218
side panel.....	320
signal receiver PCB.....	53, 55, 60, 63
signal receiver PCB (A3P) .....	66
signal receiving sign.....	92
signal transmission error (between indoor and outdoor units) .....	219
signal transmission error (on outdoor unit PCB) ..	258
silicon grease .....	358
solenoid valve .....	315, 316
solenoid valve coil .....	313
sound blanket.....	292, 312, 351
specifications.....	18
SPM .....	72, 75
SS2 .....	64
stop valve cover .....	275
suction grille .....	318
SW1 .....	52, 54, 56, 58, 61, 67
SW2 .....	58, 61
SW3 .....	67
SW4 .....	61, 67
SW5 .....	67

**T**

target discharge pipe temperature control .....	111
terminal board .....	288
test run from the remote controller .....	356
thermistor .....	305, 313
discharge pipe thermistor .....	95, 97, 111, 297, 314
function .....	95
gas pipe thermistor .....	95, 97, 297, 305, 314
heat exchanger thermistor .....	297, 314
indoor heat exchanger thermistor .....	96, 98
liquid pipe thermistor.....	96, 297, 305, 314
outdoor air thermistor.....	283, 297, 314
outdoor heat exchanger thermistor.....	95, 97
thermistor or related abnormality (indoor unit) .....	217
thermistor or related abnormality (outdoor unit) ..	241
thermistor resistance check .....	263
thermostat control .....	84
TIMER operation .....	165
titanium apatite photocatalytic air-purifying filter ....	92
top panel .....	272, 319
troubleshooting.....	186
indoor units .....	209
outdoor units .....	210
troubleshooting with the LED indication .....	203
troubleshooting with the operation lamp .....	202
turning speed pulse input on the outdoor unit PCB check.....	268

**U**

U.....	70, 73
U0.....	253, 255
U2.....	257
U4.....	219
U7.....	258
UA.....	221, 259
UH.....	259
unspecified voltage (between indoor and outdoor units).....	221, 259

**V**

V.....	70, 73
V1.....	52, 54, 56, 58, 61
V100.....	67
V11.....	67
V2.....	67, 70, 73
V3.....	67, 70, 73
V5.....	67, 70, 73
V6.....	67
V9.....	67
varistor.....	52, 54, 56, 58, 61, 67, 70, 73
voltage detection function.....	116

**W**

W.....	70, 73
wide-angle louvers.....	80
wiring diagrams.....	370
wiring-error check.....	114

**X**

X10A.....	64
X11A.....	64
X15A.....	64
X17A.....	64
X18A.....	64
X19A.....	64
X1A.....	64
X20A.....	64
X24A.....	64
X25A.....	64
X27A.....	64
X2A.....	64
X33A.....	64
X35A.....	64
X36A.....	64
X40A.....	64
X5A.....	64
X60A.....	64
X61A.....	64



# Drawings & Flow Charts

## Numerics

3-D airflow .....80

## A

anti-icing function in other rooms .....259

ARC433 .....205

automatic air flow control .....81

automatic operation .....83

auto-swing .....80

## B

buzzer PCB .....55

## C

capacitor voltage check .....267

compressor lock .....226

compressor overload .....225

compressor protection function .....103

compressor sensor system abnormality .....236

control PCB (A1P) .....65

control PCB (indoor unit) .....53, 55, 56, 59, 63

control PCB (outdoor unit D series) .....74

control PCB (outdoor unit E series 68-75 class models) .....71

cooling / heating mode lock .....117

CT or related abnormality .....239

## D

DC fan lock .....228

defrost control .....107

diagnosis mode .....206

diode bridge .....358

discharge pipe temperature control .....104, 233

discharge pressure check .....265

display PCB .....53, 55, 57, 60, 63

display PCB (A4P) .....66

## E

econo mode .....86

electrical box temperature rise .....243

electronic expansion valve check .....261

electronic expansion valve control .....108

## F

fan motor connector output check .....260

fan motor or related abnormality

AC motor .....214

DC motor .....215

fan speed steps .....81

four way valve abnormality .....231

four way valve performance check .....262

freeze-up protection control .....105, 222

freeze-up protection control or

high pressure control .....212

frequency control .....100

frequency principle .....78

function of thermistor .....95

cooling only model .....97

heat pump model .....95

## H

Hall IC check .....269

heating peak-cut control .....105

high pressure control in cooling .....234

HOME LEAVE operation .....90

## I

indoor unit PCB abnormality .....211

input current control .....104

input over current detection .....229

installation condition check .....264

insufficient gas .....253

insufficient gas control .....112

INTELLIGENT EYE .....88

INTELLIGENT EYE sensor PCB .....53, 55

inverter features .....79

inverter PCB (MID2) .....72, 75

inverter POWERFUL operation .....91

inverter units refrigerant system check .....266

## J

jumper settings .....357

## L

limit switch continuity check .....260

location of operation lamp .....202

low Hz high pressure limit .....108

low-voltage detection .....257

## M

main circuit electrolytic capacitor check .....268

main PCB (outdoor unit E series 50-58 class models)

.....68

main PCB (outdoor unit E series 80-100 class models)

.....68

main structural parts .....94

MID1 .....74

MID2 .....72, 75

mode hierarchy .....99

## N

night set mode .....85

## O

OL activation .....225

ON/OFF button on indoor unit .....92

outdoor unit fan system check (with DC motor) ..265

outdoor unit PCB abnormality .....224

output over current detection .....251



<b>P</b>	
piping diagrams	
3MKS50DVM .....	366
3MKS50ESG .....	367
3MKS58EVMA .....	364
3MKS71ESG .....	364
3MKS75EVMA .....	364
3MKS90EVLTL .....	365
3MXS52EVMA .....	368
3MXS68EVMA .....	368
3MXS90EVLTL .....	369
4MKS100EVLTL .....	365
4MKS71DVM .....	366
4MKS80ESG .....	365
4MKS90EVMA .....	365
4MXS100EVLTL .....	369
4MXS80EVMA .....	369
CDK(X)S25/35/50/60DVMT .....	361
CDK(X)S25/35EAVMT(A) .....	361
CDKS25/35/50/60CVMA .....	361
FDKS25/35CAVMB .....	361
FDKS25/35EAVMB .....	361
FDKS50/60CVMB .....	361
FDXS25/35/50/60CVMA .....	361
FFQ25B8V1B .....	363
FFQ35B8V1B .....	363
FFQ50B8V1B .....	363
FFQ60B8V1B .....	363
FLXS25BVMA .....	362
FLXS35BVMA .....	362
FLXS50BVMA .....	362
FLXS60BVMA .....	362
FTK(X)S50/60DVMT .....	360
FTK(X)S50/60FVLT .....	360
FTKS20/25/35DVMT .....	360
FTKS20DVMA .....	360
FTKS25/35DVM .....	360
FTKS25/35EVMA .....	360
FTKS50/60BVMB .....	360
FTKS50FVM .....	360
FTKS50FVMA .....	360
FTKS60FVM .....	360
FTKS60FVMA .....	360
FTKS71BVMB .....	360
FTKS71DVMT .....	360
FTKS71FVLT .....	360
FTKS71FVM .....	360
FTKS71FVMA .....	360
FTXS20/25/35DVMT .....	361
FTXS20DVMA .....	361
FTXS25/35EVMA .....	361
FTXS50/60FVMA .....	360
FTXS71DVMT .....	361
FTXS71FVLT .....	361
FTXS71FVMA .....	361
FVXS35BVMA .....	362
FVXS50BVMA .....	363
position sensor abnormality .....	238
power supply PCB .....	59
power supply PCB (35 class) .....	62
power supply PCB (50 class) .....	62
power supply waveforms check .....	266
power transistor .....	358
power transistor check .....	267
priority room setting .....	116
programme dry function .....	82
<b>R</b>	
radiation fin temperature rise .....	247
remote controller .....	205
<b>S</b>	
service monitor PCB .....	69, 71
shutter drive motor / shutter limit switch abnormality .....	218
signal receiver PCB .....	53, 55, 60, 63
signal receiver PCB (A3P) .....	66
signal transmission error (between indoor and outdoor units) .....	219
signal transmission error (on outdoor unit PCB) .....	258
silicon grease .....	358
SPM .....	72, 75
<b>T</b>	
target discharge pipe temperature control .....	111
thermistor .....	
function .....	95
thermistor or related abnormality (indoor unit) .....	217
thermistor or related abnormality (outdoor unit) .....	241
thermistor resistance check .....	263
thermostat control .....	84
trial operation from remote controller .....	356
troubleshooting with the LED indication .....	203
turning speed pulse input on the outdoor unit PCB check .....	268
<b>U</b>	
unspecified voltage (between indoor and outdoor units) .....	221, 259
<b>W</b>	
wiring diagrams	
3MKS50DVM .....	378
3MKS50ESG .....	376
3MKS58EVMA .....	376
3MKS71ESG .....	376
3MKS75EVMA .....	376
3MKS90EVLTL .....	377
3MXS52EVMA .....	379
3MXS68EVMA .....	379
3MXS90EVLTL .....	380
4MKS100EVLTL .....	377
4MKS71DVM .....	378
4MKS80ESG .....	377
4MKS90EVMA .....	377
4MXS100EVLTL .....	380
4MXS80EVMA .....	380
CDK(X)S25/35/50/60DVMT .....	373
CDK(X)S25/35EAVMT .....	373
CDKS25/35/50/60CVMA .....	373
CDKS25/35EAVMA .....	373

CDXS25/35EAVMA .....	373
FDKS25/35CAVMB .....	373
FDKS25/35EAVMB .....	373
FDKS50/60CVMB .....	373
FDXS25/35/50/60CVMA .....	373
FFQ25B8V1B .....	375
FFQ35B8V1B .....	375
FFQ50B8V1B .....	375
FFQ60B8V1B .....	375
FLXS25BVMA .....	374
FLXS35BVMA .....	374
FLXS50BVMA .....	374
FLXS60BVMA .....	374
FTK(X)S20/25/35DVMT .....	371
FTK(X)S20DVMA .....	370
FTK(X)S25/35EVMA .....	370
FTK(X)S50/60/71FVLT .....	372
FTK(X)S50/60/71FVMA .....	371
FTK(X)S50DVMT .....	370
FTK(X)S60/71DVMT .....	371
FTKS25/35DVM .....	370
FTKS50/60/71FVM .....	371
FTKS50BVMB .....	370
FTKS60/71BVMB .....	371
FVXS35BVMA .....	374
FVXS50BVMA .....	374
wiring-error check .....	114

**Warning**



- Daikin Industries, Ltd.'s products are manufactured for export to numerous countries throughout the world. Daikin Industries, Ltd. does not have control over which products are exported to and used in a particular country. Prior to purchase, please therefore confirm with your local authorised importer, distributor and/or retailer whether this product conforms to the applicable standards, and is suitable for use, in the region where the product will be used. This statement does not purport to exclude, restrict or modify the application of any local legislation.
- Ask a qualified installer or contractor to install this product. Do not try to install the product yourself. Improper installation can result in water or refrigerant leakage, electrical shock, fire or explosion.
- Use only those parts and accessories supplied or specified by Daikin. Ask a qualified installer or contractor to install those parts and accessories. Use of unauthorised parts and accessories or improper installation of parts and accessories can result in water or refrigerant leakage, electrical shock, fire or explosion.
- Read the User's Manual carefully before using this product. The User's Manual provides important safety instructions and warnings. Be sure to follow these instructions and warnings.

If you have any enquiries, please contact your local importer, distributor and/or retailer.

### Cautions on product corrosion

1. Air conditioners should not be installed in areas where corrosive gases, such as acid gas or alkaline gas, are produced.
2. If the outdoor unit is to be installed close to the sea shore, direct exposure to the sea breeze should be avoided. If you need to install the outdoor unit close to the sea shore, contact your local distributor.



JMI-0107



JQA-1452

#### About ISO 9001

ISO 9001 is a plant certification system defined by the International Organization for Standardization (ISO) relating to quality assurance. ISO 9001 certification covers quality assurance aspects related to the "design, development, manufacture, installation, and supplementary service" of products manufactured at the plant.



EC99J2044

#### About ISO 14001

ISO 14001 is the standard defined by the International Organization for Standardization (ISO) relating to environmental management systems. Our group has been acknowledged by an internationally accredited compliance organisation as having an appropriate programme of environmental protection procedures and activities to meet the requirements of ISO 14001.

### Dealer

#### **DAIKIN INDUSTRIES, LTD.**

Head Office:  
Umeda Center Bldg., 2-4-12, Nakazaki-Nishi,  
Kita-ku, Osaka, 530-8323 Japan

Tokyo Office:  
JR Shinagawa East Bldg., 2-18-1, Konan,  
Minato-ku, Tokyo, 108-0075 Japan

[http://www.daikin.com/global\\_ac/](http://www.daikin.com/global_ac/)

©All rights reserved