

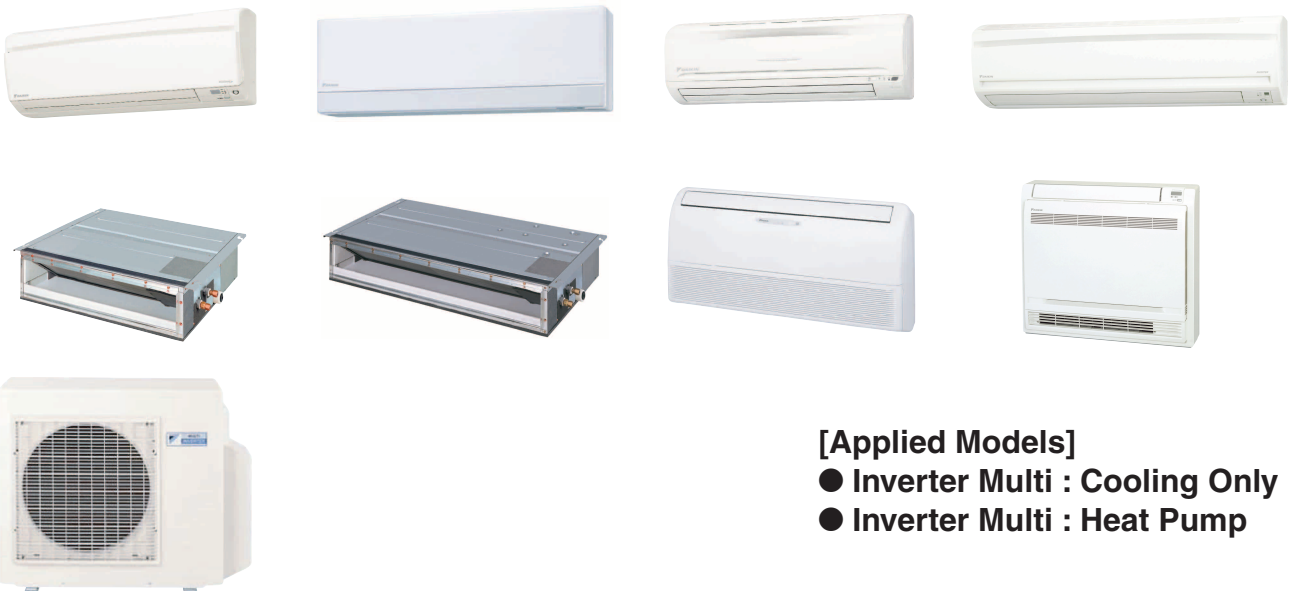

SiBE12 - 727

Service Manual

SUPER MULTI NX E-Series



- [Applied Models]
- Inverter Multi : Cooling Only
 - Inverter Multi : Heat Pump

SUPER MULTI NX E-Series

●Cooling Only

Indoor Unit

FTKS20D3VMW
FTKS20D3VML
FTKS25D3VMW
FTKS25D3VML
FTKS35D3VMW
FTKS35D3VML
FTKS50D2V1W
FTKS50D2V1L

FTKS20CAVMB
FTKS25CAVMB
FTKS35CAVMB
FTKS50FV1B

FDKS25CAVMB
FDKS35CAVMB
FDKS50CVMB
FDKS25EAVMB
FDKS35EAVMB

FLKS25BAVMB
FLKS35BAVMB
FLKS50BAVMB
FVXS25FV1B
FVXS35FV1B
FVXS50FV1B
FHQ35BVV1B
FHQ50BVV1B

Outdoor Unit

3MKS50E3V1B

4MKS58E3V1B

●Heat Pump

Indoor Unit

FTXG25EV1BW
FTXG25EV1BS
FTXG35EV1BW
FTXG35EV1BS
CTXG50EV1BW
CTXG50EV1BS
FTXS20D3VMW
FTXS20D3VML
FTXS25D3VMW
FTXS25D3VML

FTXS35D3VMW
FTXS35D3VML
FTXS50D2V1W
FTXS50D2V1L
FTXS20CAVMB
FTXS25CAVMB
FTXS35CAVMB
FTXS50FV1B

FDXS25CAVMB
FDXS35CAVMB
FDXS50CVMB
FDXS25EAVMB
FDXS35EAVMB

FLXS25BAVMB
FLXS35BAVMB
FLXS50BAVMB
FVXS25FV1B
FVXS35FV1B
FVXS50FV1B
FHQ35BVV1B
FHQ50BVV1B

Outdoor Unit

3MXS52E3V1B

1. Introduction	V
1.1 Safety Cautions	v
1.2 Used Icons	ix

Part 1 List of Functions 1

1. List of Functions	2
1.1 Cooling Only Models	2
1.2 Heat Pump Models	7

Part 2 Specifications 13

1. Specifications	14
1.1 Indoor Units - Cooling Only	14
1.2 Outdoor Units - Cooling Only	22
1.3 Indoor Units - Heat Pump	23
1.4 Outdoor Units - Heat Pump	33

Part 3 Printed Circuit Board Connector Wiring Diagram 35

1. Printed Circuit Board Connector Wiring Diagram	36
1.1 Wall Mounted Type	36
1.2 Duct Connected Type	45
1.3 Floor / Ceiling Suspended Dual Type	47
1.4 Floor Standing Type	50
1.5 Ceiling Suspended Type	52
1.6 Outdoor Units	54

Part 4 Function and Control..... 57

1. Main Functions	58
1.1 Frequency Principle	58
1.2 Power-Airflow Dual Flaps, Wide Angle Louvers and Auto-Swing	60
1.3 Operation Starting Control	62
1.4 Fan Speed Control for Indoor Units	63
1.5 Programme Dry Function	64
1.6 Automatic Operation	65
1.7 Thermostat Control	66
1.8 Night Set Mode	67
1.9 ECONO Mode	68
1.10 INTELLIGENT EYE (Wall Mounted Type only)	69
1.11 HOME LEAVE Operation	71
1.12 Inverter POWERFUL Operation	72
1.13 Other Functions	73
2. Function of Main Structural Parts	75
2.1 Main Structural Parts	75
2.2 Function of Thermistor	76
3. Control Specification	80
3.1 Mode Hierarchy	80
3.2 Frequency Control	81
3.3 Controls at Mode Changing / Start-up	84
3.4 Discharge Pipe Temperature Control	86
3.5 Input Current Control	86

3.6	Freeze-up Protection Control	87
3.7	Heating Peak-cut Control	87
3.8	Fan Control.....	88
3.9	Liquid Compression Protection Function 2.....	88
3.10	Defrost Control	89
3.11	Electronic Expansion Valve Control	90
3.12	Malfunctions	94
3.13	Forced Operation Mode	95
3.14	Wiring-Error Check.....	96
3.15	Additional Function.....	98

Part 5 Operation Manual..... 101

1.	System Configuration.....	102
1.1	Operation Instructions	102
2.	Instruction.....	103
2.1	FTK(X)S, FTXG, CTXG, FDK(X)S, FLK(X)S Series	103
2.2	FVXS Series.....	179
2.3	FHQ Series.....	210

Part 6 Service Diagnosis..... 223

1.	Caution for Diagnosis.....	224
1.1	Troubleshooting with Operation Lamp	224
2.	Problem Symptoms and Measures	226
3.	Service Check Function	227
3.1	Check Method 1	227
3.2	Check Method 2	229
4.	Code Indication on the Remote Controller	231
4.1	Error Codes and Description of Fault	231
5.	Troubleshooting	232
5.1	Indoor Units	232
5.2	Outdoor Units	233
5.3	Indoor Unit PCB Abnormality	234
5.4	Freeze-up Protection Control or High Pressure Control.....	235
5.5	Fan Motor or Related Abnormality	237
5.6	Thermistor or Related Abnormality (Indoor Unit).....	240
5.7	Front Panel Open / Close Fault.....	241
5.8	Signal Transmission Error (between Indoor and Outdoor Unit)	242
5.9	Unspecified Voltage (between Indoor and Outdoor Units)	243
5.10	Freeze-up Protection Control	244
5.11	Outdoor Unit PCB Abnormality.....	246
5.12	OL Activation (Compressor Overload)	247
5.13	Compressor Lock	248
5.14	DC Fan Lock	249
5.15	Input Over Current Detection	250
5.16	Discharge Pipe Temperature Control.....	252
5.17	High Pressure Control in Cooling	253
5.18	Compressor Sensor System Abnormality	255
5.19	Position Sensor Abnormality	257
5.20	CT or Related Abnormality	258
5.21	Thermistor or Related Abnormality (Outdoor Unit).....	260

5.22 Electrical Box Temperature Rise	262
5.23 Radiation Fin Temperature Rise	264
5.24 Output Over Current Detection.....	266
5.25 Insufficient Gas.....	268
5.26 Low-voltage Detection or Over-voltage Detection	270
5.27 Signal Transmission Error (on Outdoor Unit PCB).....	271
5.28 Anti-icing Function in Other Rooms / Unspecified Voltage (between Indoor and Outdoor Units)	272
6. Check	273
6.1 How to Check.....	273

Part 7 Removal Procedure 283

1. Outdoor Unit.....	284
1.1 Removal of the Panels and Plates	284
1.2 Removal of the Electrical Box	289
1.3 Removal of the PCB.....	296
1.4 Removal of the Propeller Fan / Fan Motor	302
1.5 Removal of the Sound Blanket.....	304
1.6 Removal of Electronic Expansion Valve Coil, Four Way Valve Coil and Thermistor	308
1.7 Removal of the Distributor.....	311
1.8 Removal of the Four Way Valve.....	312
1.9 Removal of the Compressor.....	313

Part 8 Others 315

1. Others	316
1.1 Test Run from the Remote Controller	316
1.2 Jumper Settings	317
1.3 Application of Silicon Grease to a Power Transistor and a Diode Bridge.....	319

Part 9 Appendix..... 321

1. Piping Diagrams.....	322
1.1 Indoor Units	322
1.2 Outdoor Units	328
2. Wiring Diagrams.....	330
2.1 Indoor Units	330
2.2 Outdoor Units	335





Index i

Drawings & Flow Charts v







1. Introduction



1.1 Safety Cautions









Cautions and Warnings

- Be sure to read the following safety cautions before conducting repair work.
- The caution items are classified into “ **Warning**” and “ **Caution**”. The “ **Warning**” items are especially important since they can lead to death or serious injury if they are not followed closely. The “ **Caution**” items can also lead to serious accidents under some conditions if they are not followed. Therefore, be sure to observe all the safety caution items described below.
- About the pictograms
 - △ This symbol indicates the item for which caution must be exercised.
The pictogram shows the item to which attention must be paid.
 - This symbol indicates the prohibited action.
The prohibited item or action is shown in the illustration or near the symbol.
 - This symbol indicates the action that must be taken, or the instruction.
The instruction is shown in the illustration or near the symbol.
- After the repair work is complete, be sure to conduct a test operation to ensure that the equipment operates normally, and explain the cautions for operating the product to the customer.











1.1.1 Cautions Regarding Safety of Workers





 Warning	
<p>Be sure to disconnect the power cable plug from the plug socket before disassembling the equipment for repair. Working on the equipment that is connected to the power supply may cause an electrical shock. If it is necessary to supply power to the equipment to conduct the repair or inspecting the circuits, do not touch any electrically charged sections of the equipment.</p>	
<p>If the refrigerant gas is discharged during the repair work, do not touch the discharged refrigerant gas. The refrigerant gas may cause frostbite.</p>	
<p>When disconnecting the suction or discharge pipe of the compressor at the welded section, evacuate the refrigerant gas completely at a well-ventilated place first. If there is a gas remaining inside the compressor, the refrigerant gas or refrigerating machine oil discharges when the pipe is disconnected, and it may cause injury.</p>	
<p>If the refrigerant gas leaks during the repair work, ventilate the area. The refrigerant gas may generate toxic gases when it contacts flames.</p>	
<p>The step-up capacitor supplies high-voltage electricity to the electrical components of the outdoor unit. Be sure to discharge the capacitor completely before conducting repair work. A charged capacitor may cause an electrical shock.</p>	
<p>Do not start or stop the air conditioner operation by plugging or unplugging the power cable plug. Plugging or unplugging the power cable plug to operate the equipment may cause an electrical shock or fire.</p>	







 Warning	
Be sure to wear a safety helmet, gloves, and a safety belt when working at a high place (more than 2m). Insufficient safety measures may cause a fall accident.	
In case of R410A refrigerant models, be sure to use pipes, flare nuts and tools for the exclusive use of the R410A refrigerant. The use of materials for R22 refrigerant models may cause a serious accident such as a damage of refrigerant cycle as well as an equipment failure.	





 Caution	
Do not repair the electrical components with wet hands. Working on the equipment with wet hands may cause an electrical shock.	
Do not clean the air conditioner by splashing water. Washing the unit with water may cause an electrical shock.	
Be sure to provide the grounding when repairing the equipment in a humid or wet place, to avoid electrical shocks.	
Be sure to turn off the power switch and unplug the power cable when cleaning the equipment. The internal fan rotates at a high speed, and cause injury.	
Be sure to conduct repair work with appropriate tools. The use of inappropriate tools may cause injury.	
Be sure to check that the refrigerating cycle section has cooled down enough before conducting repair work. Working on the unit when the refrigerating cycle section is hot may cause burns.	
Use the welder in a well-ventilated place. Using the welder in an enclosed room may cause oxygen deficiency.	

1.1.2 Cautions Regarding Safety of Users

 Warning	
<p>Be sure to use parts listed in the service parts list of the applicable model and appropriate tools to conduct repair work. Never attempt to modify the equipment. The use of inappropriate parts or tools may cause an electrical shock, excessive heat generation or fire.</p>	
<p>If the power cable and lead wires have scratches or deteriorated, be sure to replace them. Damaged cable and wires may cause an electrical shock, excessive heat generation or fire.</p>	
<p>Do not use a joined power cable or extension cable, or share the same power outlet with other electrical appliances, since it may cause an electrical shock, excessive heat generation or fire.</p>	
<p>Be sure to use an exclusive power circuit for the equipment, and follow the local technical standards related to the electrical equipment, the internal wiring regulations, and the instruction manual for installation when conducting electrical work. Insufficient power circuit capacity and improper electrical work may cause an electrical shock or fire.</p>	
<p>Be sure to use the specified cable for wiring between the indoor and outdoor units. Make the connections securely and route the cable properly so that there is no force pulling the cable at the connection terminals. Improper connections may cause excessive heat generation or fire.</p>	
<p>When wiring between the indoor and outdoor units, make sure that the terminal cover does not lift off or dismount because of the cable. If the cover is not mounted properly, the terminal connection section may cause an electrical shock, excessive heat generation or fire.</p>	
<p>Do not damage or modify the power cable. Damaged or modified power cable may cause an electrical shock or fire. Placing heavy items on the power cable, and heating or pulling the power cable may damage the cable.</p>	
<p>Do not mix air or gas other than the specified refrigerant (R410A / R22) in the refrigerant system. If air enters the refrigerating system, an excessively high pressure results, causing equipment damage and injury.</p>	
<p>If the refrigerant gas leaks, be sure to locate the leaking point and repair it before charging the refrigerant. After charging refrigerant, make sure that there is no refrigerant leak. If the leaking point cannot be located and the repair work must be stopped, be sure to perform pump-down and close the service valve, to prevent the refrigerant gas from leaking into the room. The refrigerant gas itself is harmless, but it may generate toxic gases when it contacts flames, such as fan and other heaters, stoves and ranges.</p>	
<p>When relocating the equipment, make sure that the new installation site has sufficient strength to withstand the weight of the equipment. If the installation site does not have sufficient strength and if the installation work is not conducted securely, the equipment may fall and cause injury.</p>	





 Warning	
Check to make sure that the power cable plug is not dirty or loose, then insert the plug into a power outlet securely. If the plug has dust or loose connection, it may cause an electrical shock or fire.	
Be sure to install the product correctly by using the provided standard installation frame. Incorrect use of the installation frame and improper installation may cause the equipment to fall, resulting in injury.	For unitary type only 
Be sure to install the product securely in the installation frame mounted on the window frame. If the unit is not securely mounted, it may fall and cause injury.	For unitary type only 
When replacing the coin battery in the remote controller, be sure to disposed of the old battery to prevent children from swallowing it. If a child swallows the coin battery, see a doctor immediately.	

 Caution	
Installation of a leakage breaker is necessary in some cases depending on the conditions of the installation site, to prevent electrical shocks.	
Do not install the equipment in a place where there is a possibility of combustible gas leaks. If the combustible gas leaks and remains around the unit, it may cause a fire.	
Check to see if the parts and wires are mounted and connected properly, and if the connections at the soldered or crimped terminals are secure. Improper installation and connections may cause excessive heat generation, fire or an electrical shock.	
If the installation platform or frame has corroded, replace it. Corroded installation platform or frame may cause the unit to fall, resulting in injury.	
Check the grounding, and repair it if the equipment is not properly grounded. Improper grounding may cause an electrical shock.	

 Caution	
Be sure to measure the insulation resistance after the repair, and make sure that the resistance is 1 MΩ or higher. Faulty insulation may cause an electrical shock.	
Be sure to check the drainage of the indoor unit after the repair. Faulty drainage may cause the water to enter the room and wet the furniture and floor.	
Do not tilt the unit when removing it. The water inside the unit may spill and wet the furniture and floor.	
Be sure to install the packing and seal on the installation frame properly. If the packing and seal are not installed properly, water may enter the room and wet the furniture and floor.	For unitary type only 

1.2 Used Icons

Icons are used to attract the attention of the reader to specific information. The meaning of each icon is described in the table below:

Icon	Type of Information	Description
 Note:	Note	A “note” provides information that is not indispensable, but may nevertheless be valuable to the reader, such as tips and tricks.
 Caution	Caution	A “caution” is used when there is danger that the reader, through incorrect manipulation, may damage equipment, lose data, get an unexpected result or has to restart (part of) a procedure.
 Warning	Warning	A “warning” is used when there is danger of personal injury.
	Reference	A “reference” guides the reader to other places in this binder or in this manual, where he/she will find additional information on a specific topic.

Part 1

List of Functions

1. List of Functions	2
1.1 Cooling Only Models	2
1.2 Heat Pump Models.....	7

1. List of Functions

1.1 Cooling Only Models

Category	Functions			Category	Functions			
		FTKS20-35D3VMW(L)	FTKS50D2V1W(L)			FTKS20-35D3VMW(L)	FTKS50D2V1W(L)	
Basic Function	Inverter (with Inverter Power Control)	○	○	Health & Clean	Air Purifying Filter	—	—	
	Operation Limit for Cooling (°CDB)	—	—		Photocatalytic Deodorizing Filter	—	—	
	Operation Limit for Heating (°CWB)	—	—		Air Purifying Filter with Photocatalytic Deodorizing Function	—	—	
Compressor	PAM Control	—	—		Titanium Apatite Photocatalytic Air-Purifying Filter	○	○	
	Oval Scroll Compressor	—	—		Longlife Filter (Option)	—	—	
	Swing Compressor	—	—		Mold Proof Air Filter	○	○	
	Rotary Compressor	—	—		Wipe-clean Flat Panel	○	○	
Comfortable Airflow	Reluctance DC Motor	—	—		Washable Grille	—	—	
	Power-Airflow Flap	—	—		Filter Cleaning Indicator	—	—	
	Power-Airflow Dual Flaps	○	○		Mold Proof Operation	—	—	
	Power-Airflow Diffuser	—	—	Heating Dry Operation	—	—		
	Wide-Angle Louvers	○	○	Good-Sleep Cooling Operation	—	—		
	Vertical Auto-Swing (Up and Down)	○	○	Timer	Weekly Timer	—	—	
	Horizontal Auto-Swing (Right and Left)	—	—		24-Hour On/Off Timer	○	○	
	3-D Airflow	—	—		72-Hour On/Off Timer	—	—	
	Comfort Control	Comfort Airflow Mode	○	○	Night Set Mode	○	○	
3-Step Airflow (H/P Only)		—	—	Worry Free "Reliability & Durability"	Auto-Restart (after Power Failure)	○	○	
Auto Fan Speed		○	○		Self-Diagnosis (Digital, LED) Display	○	○	
Indoor Unit Quiet Operation		○	○		Wiring Error Check	—	—	
Night Quiet Mode (Automatic)		—	—		Anticorrosion Treatment of Outdoor Heat Exchanger	—	—	
Outdoor Unit Quiet Operation (Manual)		—	—	Flexibility	Multi-Split / Split Type Compatible Indoor Unit	○	○	
Intelligent Eye		○	○		Flexible Voltage Correspondence	○	—	
Quick Warming Function		—	—		High Ceiling Application	—	—	
Hot-Start Function	—	—	Chargeless		—	—		
Operation	Automatic Defrosting	—	—	Either Side Drain (Right or Left)	○	○		
	Automatic Operation	—	—	Power Selection	—	—		
	Programme Dry Function	○	○	Remote Control	5-Rooms Centralized Controller (Option)	○	○	
Fan Only	○	○	Remote Control Adaptor (Normal Open-Pulse Contact) (Option)		○	○		
Lifestyle Convenience	New Powerful Operation (Non-Inverter)	—	—		Remote Control Adaptor (Normal Open Contact) (Option)	○	○	
	Inverter Powerful Operation	○	○		DIII-NET Compatible (Adaptor) (Option)	○	○	
	Priority-Room Setting	—	—		Remote Controller	Wireless	○	○
	Cooling / Heating Mode Lock	—	—			Wired	—	—
	Home Leave Operation	—	—					
	ECONO Mode	○	○					
	Indoor Unit On/Off Switch	○	○					
	Signal Reception Indicator	○	○					
Temperature Display	—	—						
Another Room Operation	—	—						

Note: ○ : Holding Functions

— : No Functions

Category	Functions	FTKS20-35CAVMB	FTKS50FV1B	Category	Functions	FTKS20-35CAVMB	FTKS50FV1B	
Basic Function	Inverter (with Inverter Power Control)	○	○	Health & Clean	Air Purifying Filter	—	—	
	Operation Limit for Cooling (°CDB)	—	—		Photocatalytic Deodorizing Filter	—	—	
	Operation Limit for Heating (°CWB)	—	—		Air Purifying Filter with Photocatalytic Deodorizing Function	○	—	
	PAM Control	—	—		Titanium Apatite Photocatalytic Air-Purifying Filter	—	○	
Compressor	Oval Scroll Compressor	—	—	Longlife Filter (Option)	—	—		
	Swing Compressor	—	—	Mold Proof Air Filter	○	○		
	Rotary Compressor	—	—	Wipe-clean Flat Panel	○	○		
	Reluctance DC Motor	—	—	Washable Grille	—	—		
Comfortable Airflow	Power-Airflow Flap	—	—	Filter Cleaning Indicator	—	—		
	Power-Airflow Dual Flaps	○	○	Mold Proof Operation	—	—		
	Power-Airflow Diffuser	—	—	Heating Dry Operation	—	—		
	Wide-Angle Louvers	○	○	Good-Sleep Cooling Operation	—	—		
	Vertical Auto-Swing (Up and Down)	○	○	Timer	Weekly Timer	—	—	
	Horizontal Auto-Swing (Right and Left)	—	○		24-Hour On/Off Timer	○	○	
	3-D Airflow	—	○		72-Hour On/Off Timer	—	—	
	Comfort Airflow Mode	—	—		Night Set Mode	○	○	
Comfort Control	3-Step Airflow (H/P Only)	—	—	Worry Free "Reliability & Durability"	Auto-Restart (after Power Failure)	○	○	
	Auto Fan Speed	○	○		Self-Diagnosis (Digital, LED) Display	○	○	
	Indoor Unit Quiet Operation	○	○		Wiring Error Check	—	—	
	Night Quiet Mode (Automatic)	—	—		Anticorrosion Treatment of Outdoor Heat Exchanger	—	—	
	Outdoor Unit Quiet Operation (Manual)	—	—	Flexibility	Multi-Split / Split Type Compatible Indoor Unit	○	○	
	Intelligent Eye	○	○		Flexible Voltage Correspondence	○	—	
	Quick Warming Function	—	—		High Ceiling Application	—	—	
	Hot-Start Function	—	—		Chargeless	—	—	
Operation	Automatic Defrosting	—	—	Either side Drain (Right or Left)	○	○		
	Automatic Operation	—	—	Power Selection	—	—		
	Programme Dry Function	○	○	Remote Control	5-Rooms Centralized Controller (Option)	○	○	
Fan Only	○	○	Remote Control Adaptor (Normal Open-Pulse Contact) (Option)		○	○		
Lifestyle Convenience	New Powerful Operation (Non-Inverter)	—	—		Remote Control Adaptor (Normal Open Contact) (Option)	○	○	
	Inverter Powerful Operation	○	○		DIII-NET Compatible (Adaptor) (Option)	○	○	
	Priority-Room Setting	—	—		Remote Controller	Wireless	○	○
	Cooling / Heating Mode Lock	—	—			Wired	—	—
	Home Leave Operation	○	○		Another Room Operation	—	—	
	ECONO Mode	—	—					
	Indoor Unit On/Off Switch	○	○					
	Signal Reception Indicator	○	○					
Temperature Display	—	—						

Note: ○ : Holding Functions
— : No Functions

Category	Functions				Category	Functions			
		FDKS25/35CAVMB	FDKS50CVMB	FDKS25/35EAVMB			FDKS25/35CAVMB	FDKS50CVMB	FDKS25/35EAVMB
Basic Function	Inverter (with Inverter Power Control)	○	○	○	Health & Clean	Air Purifying Filter	—	—	—
	Operation Limit for Cooling (°CDB)	—	—	—		Photocatalytic Deodorizing Filter	—	—	—
	Operation Limit for Heating (°CWB)	—	—	—		Air Purifying Filter with Photocatalytic Deodorizing Function	—	—	—
	PAM Control	—	—	—		Titanium Apatite Photocatalytic Air-Purifying Filter	—	—	—
Compressor	Oval Scroll Compressor	—	—	—	Longlife Filter (Option)	—	—	—	
	Swing Compressor	—	—	—	Mold Proof Air Filter	○	○	○	
	Rotary Compressor	—	—	—	Wipe-clean Flat Panel	—	—	—	
	Reluctance DC Motor	—	—	—	Washable Grille	—	—	—	
Comfortable Airflow	Power-Airflow Flap	—	—	—	Filter Cleaning Indicator	—	—	—	
	Power-Airflow Dual Flaps	—	—	—	Mold Proof Operation	—	—	—	
	Power-Airflow Diffuser	—	—	—	Heating Dry Operation	—	—	—	
	Wide-Angle Louvers	—	—	—	Good-Sleep Cooling Operation	—	—	—	
	Vertical Auto-Swing (Up and Down)	—	—	—	Timer	Weekly Timer	—	—	—
	Horizontal Auto-Swing (Right and Left)	—	—	—		24-Hour On/Off Timer	○	○	○
	3-D Airflow	—	—	—		72-Hour On/Off Timer	—	—	—
	Comfort Airflow Mode	—	—	—		Night Set Mode	○	○	○
Comfort Control	3-Step Airflow (H/P Only)	—	—	—	Worry Free "Reliability & Durability"	Auto-Restart (after Power Failure)	○	○	○
	Auto Fan Speed	○	○	○		Self-Diagnosis (Digital, LED) Display	○	○	○
	Indoor Unit Quiet Operation	○	○	○		Wiring-Error Check	—	—	—
	Night Quiet Mode (Automatic)	—	—	—		Anticorrosion Treatment of Outdoor Heat Exchanger	—	—	—
	Outdoor Unit Quiet Operation (Manual)	—	—	—	Flexibility	Multi-Split / Split Type Compatible Indoor Unit	○	○	○
	Intelligent Eye	—	—	—		Flexible Voltage Correspondence	○	○	○
	Quick Warming Function	—	—	—		High Ceiling Application	—	—	—
	Hot-Start Function	—	—	—		Chargeless	—	—	—
Operation	Automatic Defrosting	—	—	—	Either Side Drain (Right or Left)	—	—	—	
	Automatic Operation	—	—	—	Power-Selection	—	—	—	
	Programme Dry Function	○	○	○	Remote Control	5-Rooms Centralized Controller (Option)	○	○	○
	Fan Only	○	○	○		Remote Control Adaptor (Normal Open-Pulse Contact) (Option)	○	○	○
				Remote Control Adaptor (Normal Open Contact) (Option)		○	○	○	
Lifestyle Convenience	New Powerful Operation (Non-Inverter)	—	—	—	Remote Controller	DIII-NET Compatible (Adaptor) (Option)	○	○	○
	Inverter Powerful Operation	○	○	○		Wireless	○	○	○
	Priority-Room Setting	—	—	—		Wired	—	—	—
	Cooling / Heating Mode Lock	—	—	—					
	Home Leave Operation	○	○	○					
	ECONO Mode	—	—	—					
	Indoor Unit On/Off Switch	○	○	○					
	Signal Reception Indicator	○	○	○					
Temperature Display	—	—	—						
Another Room Operation	—	—	—						

Note: ○ : Holding Functions
 — : No Functions

Category	Functions	FLKS25-50BAVMB	FYXS25-50FV1B	FHQ35-50BVV1B	Category	Functions	FLKS25-50BAVMB	FYXS25-50FV1B	FHQ35-50BVV1B
Basic Function	Inverter (with Inverter Power Control)	○	○	○	Health & Clean	Air Purifying Filter	○	—	—
	Operation Limit for Cooling (°CDB)	—	—	—		Photocatalytic Deodorizing Filter	○	—	—
	Operation Limit for Heating (°CWB)	—	—	—		Air Purifying Filter with Photocatalytic Deodorizing Function	—	—	—
	PAM Control	—	—	—		Titanium Apatite Photocatalytic Air-Purifying Filter	—	○	—
Compressor	Oval Scroll Compressor	—	—	—	Longlife Filter (Option)	—	—	○	
	Swing Compressor	—	—	—	Mold Proof Air Filter	○	○	○	
	Rotary Compressor	—	—	—	Wipe-clean Flat Panel	—	○	—	
	Reluctance DC Motor	—	—	—	Washable Grille	—	—	○	
Comfortable Airflow	Power-Airflow Flap	—	—	—	Filter Cleaning Indicator	—	—	○	
	Power-Airflow Dual Flaps	—	—	—	Mold Proof Operation	—	—	—	
	Power-Airflow Diffuser	—	—	—	Heating Dry Operation	—	—	—	
	Wide-Angle Louvers	—	○	—	Good-Sleep Cooling Operation	—	—	—	
	Vertical Auto-Swing (Up and Down)	○	○	○	Timer	Weekly Timer	—	○	—
	Horizontal Auto-Swing (Right and Left)	—	—	—		24-Hour On/Off Timer	○	○	—
	3-D Airflow	—	—	—		72-Hour On/Off Timer	—	—	○
	Comfort Airflow Mode	—	—	—		Night Set Mode	○	○	—
Comfort Control	3-Step Airflow (H/P Only)	—	—	—	Worry Free "Reliability & Durability"	Auto-Restart (after Power Failure)	○	○	○
	Auto Fan Speed	○	○	—		Self-Diagnosis (Digital, LED) Display	○	○	○
	Indoor Unit Quiet Operation	○	○	—		Wiring-Error Check	—	—	—
	Night Quiet Mode (Automatic)	—	—	—		Anticorrosion Treatment of Outdoor Heat Exchanger	—	—	—
	Outdoor Unit Quiet Operation (Manual)	—	—	—	Flexibility	Multi-Split / Split Type Compatible Indoor Unit	○	○	○
	Intelligent Eye	—	—	—		Flexible Voltage Correspondence	○	—	—
	Quick Warming Function	—	—	—		High Ceiling Application	—	—	○
	Hot-Start Function	—	—	—		Chargeless	—	—	—
Operation	Automatic Defrosting	—	—	—	Either Side Drain (Right or Left)	—	—	—	
	Automatic Operation	—	—	—	Power-Selection	—	—	—	
	Programme Dry Function	○	○	○	Remote Control	5-Rooms Centralized Controller (Option)	○	○	—
Fan Only	○	○	○	Remote Control Adaptor (Normal Open-Pulse Contact) (Option)		○	○	—	
Lifestyle Convenience	New Powerful Operation (Non-Inverter)	—	—	—		Remote Control Adaptor (Normal Open Contact) (Option)	○	○	—
	Inverter Powerful Operation	○	○	—	DIII-NET Compatible (Adaptor) (Option)	○	○	○	
	Priority-Room Setting	—	—	—	Remote Controller	Wireless	○	○	○
	Cooling / Heating Mode Lock	—	—	—		Wired	—	—	○
	Home Leave Operation	○	—	—					
	ECONO Mode	—	○	—					
	Indoor Unit On/Off Switch	○	○	—					
	Signal Reception Indicator	○	○	—					
	Temperature Display	—	—	—					
	Another Room Operation	—	—	—					

Note: ○ : Holding Functions
— : No Functions

Category	Functions	3MKS50E3V1B 4MKS58E3V1B	Category	Functions	3MKS50E3V1B 4MKS58E3V1B	
Basic Function	Inverter (with Inverter Power Control)	○	Health & Clean	Air Purifying Filter	—	
	Operation Limit for Cooling (°CDB)	-10 46		Photocatalytic Deodorizing Filter	—	
	Operation Limit for Heating (°CWB)	—		Air Purifying Filter with Photocatalytic Deodorizing Function	—	
	PAM Control	○		Titanium Apatite Photocatalytic Air-Purifying Filter	—	
Compressor	Oval Scroll Compressor	—		Longlife Filter (Option)	—	
	Swing Compressor	○		Mold Proof Air Filter	—	
	Rotary Compressor	—		Wipe-clean Flat Panel	—	
	Reluctance DC Motor	○		Washable Grille	—	
Comfortable Airflow	Power-Airflow Flap	—		Filter Cleaning Indicator	—	
	Power-Airflow Dual Flaps	—		Mold Proof Operation	—	
	Power-Airflow Diffuser	—		Heating Dry Operation	—	
	Wide-Angle Louvers	—		Good-Sleep Cooling Operation	—	
	Vertical Auto-Swing (Up and Down)	—		Timer	Weekly Timer	—
	Horizontal Auto-Swing (Right and Left)	—			24-Hour On/Off Timer	—
	3-D Airflow	—			72-Hour On/Off Timer	—
	Comfort Airflow Mode	—			Night Set Mode	—
Comfort Control	3-Step Airflow (H/P Only)	—	Worry Free "Reliability & Durability"	Auto-Restart (after Power Failure)	—	
	Auto Fan Speed	—		Self-Diagnosis (Digital, LED) Display	○	
	Indoor Unit Quiet Operation	—		Wiring-Error Check	○	
	Night Quiet Mode (Automatic)	○		Anticorrosion Treatment of Outdoor Heat Exchanger	○	
	Outdoor Unit Quiet Operation (Manual)	○		Flexibility	Multi-Split / Split Type Compatible Indoor Unit	—
	Intelligent Eye	—			Flexible Voltage Correspondence	—
	Quick Warming Function	—			High Ceiling Application	—
	Hot-Start Function	—			Chargeless	○
Operation	Automatic Defrosting	—		Either Side Drain (Right or Left)	—	
	Automatic Operation	—		Power-Selection	—	
	Programme Dry Function	—		Remote Control	5-Rooms Centralized Controller (Option)	—
Fan Only	—	Remote Control Adaptor (Normal Open-Pulse Contact) (Option)	—			
Lifestyle Convenience	New Powerful Operation (Non-Inverter)	—	Remote Controller		Remote Control Adaptor (Normal Open Contact) (Option)	—
	Inverter Powerful Operation	—		DIII-NET Compatible (Adaptor) (Option)	—	
	Priority-Room Setting	○		Wireless	—	
	Cooling / Heating Mode Lock	—	Wired	—		
	Home Leave Operation	—				
	ECONO Mode	—				
	Indoor Unit On/Off Switch	—				
	Signal Reception Indicator	—				
	Temperature Display	—				
Another Room Operation	—					

Note: ○ : Holding Functions
— : No Functions

1.2 Heat Pump Models

Category	Functions	FTXG25/35EV1BW(S)		Category	Functions	FTXG25/35EV1BW(S)		
		FTXG25/35EV1BW(S)	CTXG50EV1BW(S)			FTXG25/35EV1BW(S)	CTXG50EV1BW(S)	
Basic Function	Inverter (with Inverter Power Control)	○	○	Health & Clean	Air Purifying Filter	—	—	
	Operation Limit for Cooling (°CDB)	—	—		Photocatalytic Deodorizing Filter	—	—	
	Operation Limit for Heating (°CWB)	—	—		Air Purifying Filter with Photocatalytic Deodorizing Function	—	—	
	PAM Control	—	—		Titanium Apatite Photocatalytic Air-Purifying Filter	○	○	
Compressor	Oval Scroll Compressor	—	—	Timer	Longlife Filter (Option)	—	—	
	Swing Compressor	—	—		Mold Proof Air Filter	○	○	
	Rotary Compressor	—	—		Wipe-clean Flat Panel	○	○	
	Reluctance DC Motor	—	—		Washable Grille	—	—	
Comfortable Airflow	Power-Airflow Flap	○	○	Worry Free "Reliability & Durability"	Filter Cleaning Indicator	—	—	
	Power-Airflow Dual Flaps	—	—		Mold Proof Operation	—	—	
	Power-Airflow Diffuser	—	—		Heating Dry Operation	—	—	
	Wide-Angle Louvers	○	○		Good-Sleep Cooling Operation	—	—	
	Vertical Auto-Swing (Up and Down)	○	○		Flexibility	Weekly Timer	—	—
	Horizontal Auto-Swing (Right and Left)	○	○			24-Hour On/Off Timer	○	○
	3-D Airflow	○	○			72-Hour On/Off Timer	—	—
	Comfort Airflow Mode	○	○			Night Set Mode	○	○
Comfort Control	3-Step Airflow (H/P Only)	—	—	Remote Control	Auto-Restart (after Power Failure)	○	○	
	Auto Fan Speed	○	○		Self-Diagnosis (Digital, LED) Display	○	○	
	Indoor Unit Quiet Operation	○	○		Wiring Error Check	—	—	
	Night Quiet Mode (Automatic)	—	—		Anticorrosion Treatment of Outdoor Heat Exchanger	—	—	
	Outdoor Unit Quiet Operation (Manual)	—	—		Remote Controller	Multi-Split / Split Type Compatible Indoor Unit	○	—
	Intelligent Eye	○	○			Flexible Voltage Correspondence	—	—
	Quick Warming Function	—	—			High Ceiling Application	—	—
Operation	Hot-Start Function	○	○	Remote Controller	Chargeless	—	—	
	Automatic Defrosting	—	—		Either Side Drain (Right or Left)	○	○	
	Automatic Operation	○	○		Power Selection	—	—	
Lifestyle Convenience	Programme Dry Function	○	○	Remote Controller	5-Rooms Centralized Controller (Option)	○	○	
	Fan Only	○	○		Remote Control Adaptor (Normal Open-Pulse Contact) (Option)	○	○	
	New Powerful Operation (Non-Inverter)	—	—		Remote Control Adaptor (Normal Open Contact) (Option)	○	○	
	Inverter Powerful Operation	○	○		DIII-NET Compatible (Adaptor) (Option)	○	○	
	Priority-Room Setting	—	—		Remote Controller	Wireless	○	○
	Cooling / Heating Mode Lock	—	—			Wired	—	—
	Home Leave Operation	—	—					
	ECONO Mode	—	—					
	Indoor Unit On/Off Switch	○	○					
	Signal Reception Indicator	○	○					
Temperature Display	—	—						
Another Room Operation	—	—						

Note: ○ : Holding Functions
— : No Functions

Category	Functions				Category	Functions				
		FTXS20-35D3VMW(L)	FTXS50D2V1W(L)	FTXS20-35CAVMB			FTXS20-35D3VMW(L)	FTXS50D2V1W(L)	FTXS20-35CAVMB	
Basic Function	Inverter (with Inverter Power Control)	○	○	○	Health & Clean	Air Purifying Filter	—	—	—	
	Operation Limit for Cooling (°CDB)	—	—	—		Photocatalytic Deodorizing Filter	—	—	—	
	Operation Limit for Heating (°CWB)	—	—	—		Air Purifying Filter with Photocatalytic Deodorizing Function	—	—	○	
PAM Control	—	—	—	Titanium Apatite Photocatalytic Air-Purifying Filter		○	○	—		
Compressor	Oval Scroll Compressor	—	—	—		Longlife Filter (Option)	—	—	—	
	Swing Compressor	—	—	—		Mold Proof Air Filter	○	○	○	
	Rotary Compressor	—	—	—		Wipe-clean Flat Panel	○	○	○	
	Reluctance DC Motor	—	—	—		Washable Grille	—	—	—	
Comfortable Airflow	Power-Airflow Flap	—	—	—		Timer	Filter Cleaning Indicator	—	—	—
	Power-Airflow Dual Flaps	○	○	○			Mold Proof Operation	—	—	—
	Power-Airflow Diffuser	—	—	—	Heating Dry Operation		—	—	—	
	Wide-Angle Louvers	○	○	○	Good-Sleep Cooling Operation		—	—	—	
	Vertical Auto-Swing (Up and Down)	○	○	○	Weekly Timer		—	—	—	
	Horizontal Auto-Swing (Right and Left)	—	—	—	24-Hour On/Off Timer		○	○	○	
	3-D Airflow	—	—	—	72-Hour On/Off Timer		—	—	—	
	Comfort Airflow Mode	○	○	—	Night Set Mode		○	○	○	
3-Step Airflow (H/P Only)	—	—	—	Worry Free "Reliability & Durability"	Auto-Restart (after Power Failure)		○	○	○	
Comfort Control	Auto Fan Speed	○	○		○		Self-Diagnosis (Digital, LED) Display	○	○	○
	Indoor Unit Quiet Operation	○	○		○	Wiring Error Check	—	—	—	
	Night Quiet Mode (Automatic)	—	—		—	Anticorrosion Treatment of Outdoor Heat Exchanger	—	—	—	
	Outdoor Unit Quiet Operation (Manual)	—	—		—	Flexibility	Multi-Split / Split Type Compatible Indoor Unit	○	○	○
	Intelligent Eye	○	○		○		Flexible Voltage Correspondence	○	—	○
	Quick Warming Function	—	—		—		High Ceiling Application	—	—	—
	Hot-Start Function	○	○		○		Chargeless	—	—	—
	Automatic Defrosting	—	—	—	Either side Drain (Right or Left)		○	○	○	
Operation	Automatic Operation	○	○	○	Power Selection		—	—	—	
	Programme Dry Function	○	○	○	Remote Control		5-Rooms Centralized Controller (Option)	○	○	○
	Fan Only	○	○	○			Remote Control Adaptor (Normal Open-Pulse Contact) (Option)	○	○	○
Lifestyle Convenience	New Powerful Operation (Non-Inverter)	—	—	—		Remote Control Adaptor (Normal Open Contact) (Option)	○	○	○	
	Inverter Powerful Operation	○	○	○		DIII-NET Compatible (Adaptor) (Option)	○	○	○	
	Priority-Room Setting	—	—	—		Remote Controller	Wireless	○	○	○
	Cooling / Heating Mode Lock	—	—	—			Wired	—	—	—
	Home Leave Operation	—	—	○						
	ECONO Mode	○	○	—						
	Indoor Unit On/Off Switch	○	○	○						
	Signal Reception Indicator	○	○	○						
Temperature Display	—	—	—							
Another Room Operation	—	—	—							

Note: ○ : Holding Functions
 — : No Functions

Category	Functions	FTXS50FV1B	Category	Functions	FTXS50FV1B	
Basic Function	Inverter (with Inverter Power Control)	○	Health & Clean	Air Purifying Filter	—	
	Operation Limit for Cooling (°CDB)	—		Photocatalytic Deodorizing Filter	—	
	Operation Limit for Heating (°CWB)	—		Air Purifying Filter with Photocatalytic Deodorizing Function	—	
	PAM Control	—		Titanium Apatite Photocatalytic Air-Purifying Filter	○	
Compressor	Oval Scroll Compressor	—		Longlife Filter (Option)	—	
	Swing Compressor	—		Mold Proof Air Filter	○	
	Rotary Compressor	—		Wipe-clean Flat Panel	○	
	Reluctance DC Motor	—		Washable Grille	—	
Comfortable Airflow	Power-Airflow Flap	—		Filter Cleaning Indicator	—	
	Power-Airflow Dual Flaps	○		Mold Proof Operation	—	
	Power-Airflow Diffuser	—		Heating Dry Operation	—	
	Wide-Angle Louvers	○		Good-Sleep Cooling Operation	—	
	Vertical Auto-Swing (Up and Down)	○		Timer	Weekly Timer	—
	Horizontal Auto-Swing (Right and Left)	○			24-Hour On/Off Timer	○
	3-D Airflow	○	72-Hour On/Off Timer		—	
	Comfort Airflow Mode	—	Night Set Mode		○	
Comfort Control	3-Step Airflow (H/P Only)	—	Worry Free "Reliability & Durability"	Auto-Restart (after Power Failure)	○	
	Auto Fan Speed	○		Self-Diagnosis (Digital, LED) Display	○	
	Indoor Unit Quiet Operation	○		Wiring-Error Check	—	
	Night Quiet Mode (Automatic)	—	Flexibility	Anticorrosion Treatment of Outdoor Heat Exchanger	—	
	Outdoor Unit Quiet Operation (Manual)	—		Multi-Split / Split Type Compatible Indoor Unit	○	
	Intelligent Eye	○		Flexible Voltage Correspondence	—	
	Quick Warming Function	—		High Ceiling Application	—	
	Hot-Start Function	○		Chargeless	—	
Automatic Defrosting	—	Either Side Drain (Right or Left)	○			
Operation	Automatic Operation	○	Power-Selection	—		
	Programme Dry Function	○	Remote Control	5-Rooms Centralized Controller (Option)	○	
	Fan Only	○		Remote Control Adaptor (Normal Open-Pulse Contact) (Option)	○	
Lifestyle Convenience	New Powerful Operation (Non-Inverter)	—		Remote Control Adaptor (Normal Open Contact) (Option)	○	
	Inverter Powerful Operation	○	DIII-NET Compatible (Adaptor) (Option)	○		
	Priority-Room Setting	—	Remote Controller	Wireless	○	
	Cooling / Heating Mode Lock	—		Wired	—	
	Home Leave Operation	○				
	ECONO Mode	—				
	Indoor Unit On/Off Switch	○				
	Signal Reception Indicator	○				
Temperature Display	—					
Another Room Operation	—					

Note: ○ : Holding Functions

— : No Functions

Category	Functions				Category	Functions			
		FDXS25/35CAVMB	FDXS50CVMB	FDXS25/35EAVMB			FDXS25/35CAVMB	FDXS50CVMB	FDXS25/35EAVMB
Basic Function	Inverter (with Inverter Power Control)	○	○	○	Health & Clean	Air Purifying Filter	—	—	—
	Operation Limit for Cooling (°CDB)	—	—	—		Photocatalytic Deodorizing Filter	—	—	—
	Operation Limit for Heating (°CWB)	—	—	—		Air Purifying Filter with Photocatalytic Deodorizing Function	—	—	—
	PAM Control	—	—	—		Titanium Apatite Photocatalytic Air-Purifying Filter	—	—	—
Compressor	Oval Scroll Compressor	—	—	—	Longlife Filter (Option)	—	—	—	
	Swing Compressor	—	—	—	Mold Proof Air Filter	○	○	○	
	Rotary Compressor	—	—	—	Wipe-clean Flat Panel	—	—	—	
	Reluctance DC Motor	—	—	—	Washable Grille	—	—	—	
Comfortable Airflow	Power-Airflow Flap	—	—	—	Filter Cleaning Indicator	—	—	—	
	Power-Airflow Dual Flaps	—	—	—	Mold Proof Operation	—	—	—	
	Power-Airflow Diffuser	—	—	—	Heating Dry Operation	—	—	—	
	Wide-Angle Louvers	—	—	—	Good-Sleep Cooling Operation	—	—	—	
	Vertical Auto-Swing (Up and Down)	—	—	—	Timer	Weekly Timer	—	—	—
	Horizontal Auto-Swing (Right and Left)	—	—	—		24-Hour On/Off Timer	○	○	○
	3-D Airflow	—	—	—		72-Hour On/Off Timer	—	—	—
	3-Step Airflow (H/P Only)	—	—	—		Night Set Mode	○	○	○
Comfort Control	Auto Fan Speed	○	○	○	Worry Free "Reliability & Durability"	Auto-Restart (after Power Failure)	○	○	○
	Indoor Unit Quiet Operation	○	○	○		Self-Diagnosis (Digital, LED) Display	○	○	○
	Night Quiet Mode (Automatic)	—	—	—		Wiring-Error Check	—	—	—
	Outdoor Unit Quiet Operation (Manual)	—	—	—		Anticorrosion Treatment of Outdoor Heat Exchanger	—	—	—
	Intelligent Eye	—	—	—	Flexibility	Multi-Split / Split Type Compatible Indoor Unit	○	○	○
	Quick Warming Function	—	—	—		Flexible Voltage Correspondence	○	○	○
	Hot-Start Function	○	○	○		High Ceiling Application	—	—	—
	Automatic Defrosting	—	—	—		Chargeless	—	—	—
Operation	Automatic Operation	○	○	○	Remote Control	Either Side Drain (Right or Left)	—	—	—
	Programme Dry Function	○	○	○		Power-Selection	—	—	—
	Fan Only	○	○	○		5-Rooms Centralized Controller (Option)	○	○	○
Lifestyle Convenience	New Powerful Operation (Non-Inverter)	—	—	—	Remote Control	Remote Control Adaptor (Normal Open-Pulse Contact) (Option)	○	○	○
	Inverter Powerful Operation	○	○	○		Remote Control Adaptor (Normal Open Contact) (Option)	○	○	○
	Priority-Room Setting	—	—	—		DIII-NET Compatible (Adaptor) (Option)	○	○	○
	Cooling / Heating Mode Lock	—	—	—	Remote Controller	Wireless	○	○	○
	Home Leave Operation	○	○	○		Wired	—	—	—
	ECONO Mode	—	—	—					
	Indoor Unit On/Off Switch	○	○	○					
	Signal Reception Indicator	○	○	○					
	Temperature Display	—	—	—					
Another Room Operation	—	—	—						

Note: ○ : Holding Functions
 — : No Functions

Category	Functions	FLXS25-50BAVMB	FYXS25-50FV1B	FHQ35-50BVV1B	Category	Functions	FLXS25-50BAVMB	FYXS25-50FV1B	FHQ35-50BVV1B
Basic Function	Inverter (with Inverter Power Control)	○	○	○	Health & Clean	Air Purifying Filter	○	—	—
	Operation Limit for Cooling (°CDB)	—	—	—		Photocatalytic Deodorizing Filter	○	—	—
	Operation Limit for Heating (°CWB)	—	—	—		Air Purifying Filter with Photocatalytic Deodorizing Function	—	—	—
	PAM Control	—	—	—		Titanium Apatite Photocatalytic Air-Purifying Filter	—	○	—
Compressor	Oval Scroll Compressor	—	—	—	Longlife Filter (Option)	—	—	○	
	Swing Compressor	—	—	—	Mold Proof Air Filter	○	○	○	
	Rotary Compressor	—	—	—	Wipe-clean Flat Panel	—	○	—	
	Reluctance DC Motor	—	—	—	Washable Grille	—	—	○	
Comfortable Airflow	Power-Airflow Flap	—	—	—	Filter Cleaning Indicator	—	—	○	
	Power-Airflow Dual Flaps	—	—	—	Mold Proof Operation	—	—	—	
	Power-Airflow Diffuser	—	—	—	Heating Dry Operation	—	—	—	
	Wide-Angle Louvers	—	○	—	Good-Sleep Cooling Operation	—	—	—	
	Vertical Auto-Swing (Up and Down)	○	○	○	Timer	Weekly Timer	—	○	—
	Horizontal Auto-Swing (Right and Left)	—	—	—		24-Hour On/Off Timer	○	○	—
	3-D Airflow	—	—	—		72-Hour On/Off Timer	—	—	○
	Comfort Airflow Mode	—	—	—		Night Set Mode	○	○	—
Comfort Control	3-Step Airflow (H/P Only)	—	—	—	Worry Free "Reliability & Durability"	Auto-Restart (after Power Failure)	○	○	○
	Auto Fan Speed	○	○	—		Self-Diagnosis (Digital, LED) Display	○	○	○
	Indoor Unit Quiet Operation	○	○	—		Wiring-Error Check	—	—	—
	Night Quiet Mode (Automatic)	—	—	—		Anticorrosion Treatment of Outdoor Heat Exchanger	—	—	—
	Outdoor Unit Quiet Operation (Manual)	—	—	—	Flexibility	Multi-Split / Split Type Compatible Indoor Unit	○	○	○
	Intelligent Eye	—	—	—		Flexible Voltage Correspondence	○	—	—
	Quick Warming Function	—	—	—		High Ceiling Application	—	—	○
	Hot-Start Function	○	○	○		Chargeless	—	—	—
Operation	Automatic Defrosting	—	—	—	Either Side Drain (Right or Left)	—	—	—	
	Automatic Operation	○	○	○	Power-Selection	—	—	—	
	Programme Dry Function	○	○	○	Remote Control	5-Rooms Centralized Controller (Option)	○	○	—
	Fan Only	○	○	○		Remote Control Adaptor (Normal Open-Pulse Contact) (Option)	○	○	—
Lifestyle Convenience	New Powerful Operation (Non-Inverter)	—	—	—		Remote Control Adaptor (Normal Open Contact) (Option)	○	○	—
	Inverter Powerful Operation	○	○	—	DIII-NET Compatible (Adaptor) (Option)	○	○	○	
	Priority-Room Setting	—	—	—	Remote Controller	Wireless	○	○	○
	Cooling / Heating Mode Lock	—	—	—		Wired	—	—	○
	Home Leave Operation	○	—	—					
	ECONO Mode	—	○	—					
	Indoor Unit On/Off Switch	○	○	—					
	Signal Reception Indicator	○	○	—					
	Temperature Display	—	—	—					
	Another Room Operation	—	—	—					

Note: ○ : Holding Functions
— : No Functions

Category	Functions	3MXS52E3V1B	Category	Functions	3MXS52E3V1B
Basic Function	Inverter (with Inverter Power Control)	○	Health & Clean	Air Purifying Filter	—
	Operation Limit for Cooling (°CDB)	-10 ~ 46		Photocatalytic Deodorizing Filter	—
	Operation Limit for Heating (°CWB)	-15 ~ 15.5		Air Purifying Filter with Photocatalytic Deodorizing Function	—
	PAM Control	○		Titanium Apatite Photocatalytic Air-Purifying Filter	—
Compressor	Oval Scroll Compressor	—		Longlife Filter (Option)	—
	Swing Compressor	○		Mold Proof Air Filter	—
	Rotary Compressor	—		Wipe-clean Flat Panel	—
	Reluctance DC Motor	○		Washable Grille	—
Comfortable Airflow	Power-Airflow Flap	—		Filter Cleaning Indicator	—
	Power-Airflow Dual Flaps	—		Mold Proof Operation	—
	Power-Airflow Diffuser	—	Heating Dry Operation	—	
	Wide-Angle Louvers	—	Good-Sleep Cooling Operation	—	
	Vertical Auto-Swing (Up and Down)	—	Timer	Weekly Timer	—
	Horizontal Auto-Swing (Right and Left)	—		24-Hour On/Off Timer	—
	3-D Airflow	—		72-Hour On/Off Timer	—
	Comfort Airflow Mode	—		Night Set Mode	—
Comfort Control	3-Step Airflow (H/P Only)	—	Worry Free "Reliability & Durability"	Auto-Restart (after Power Failure)	—
	Auto Fan Speed	—		Self-Diagnosis (Digital, LED) Display	○
	Indoor Unit Quiet Operation	—		Wiring-Error Check	○
	Night Quiet Mode (Automatic)	○	Flexibility	Anticorrosion Treatment of Outdoor Heat Exchanger	○
	Outdoor Unit Quiet Operation (Manual)	○		Multi-Split / Split Type Compatible Indoor Unit	—
	Intelligent Eye	—		Flexible Voltage Correspondence	—
	Quick Warming Function	○		High Ceiling Application	—
	Hot-Start Function	—		Chargeless	30m
Automatic Defrosting	○	Either Side Drain (Right or Left)	—		
Operation	Automatic Operation	—	Power-Selection	—	
	Programme Dry Function	—	Remote Control	5-Rooms Centralized Controller (Option)	—
	Fan Only	—		Remote Control Adaptor (Normal Open-Pulse Contact) (Option)	—
Lifestyle Convenience	New Powerful Operation (Non-Inverter)	—		Remote Control Adaptor (Normal Open Contact) (Option)	—
	Inverter Powerful Operation	—	DIII-NET Compatible (Adaptor) (Option)	—	
	Priority-Room Setting	○	Remote Controller	Wireless	—
	Cooling / Heating Mode Lock	○		Wired	—
	Home Leave Operation	—			
	ECONO Mode	—			
	Indoor Unit On/Off Switch	—			
	Signal Reception Indicator	—			
	Temperature Display	—			
Another Room Operation	—				

Note: ○ : Holding Functions
— : No Functions

Part 2

Specifications

1. Specifications	14
1.1 Indoor Units - Cooling Only	14
1.2 Outdoor Units - Cooling Only	22
1.3 Indoor Units - Heat Pump.....	23
1.4 Outdoor Units - Heat Pump.....	33

1. Specifications

1.1 Indoor Units - Cooling Only

Wall Mounted Type

50Hz 230V

Model			FTKS20D3VMW	FTKS20D3VML
Rated Capacity			2.0kW Class	2.0kW Class
Front Panel Color			White	Silver Line
Air Flow Rates	m ³ /min (cfm)	H	8.7 (307)	8.7 (307)
		M	6.7 (237)	6.7 (237)
		L	4.7 (166)	4.7 (166)
		SL	3.9 (138)	3.9 (138)
Fan	Type	Cross Flow Fan		Cross Flow Fan
	Motor Output	W	40	40
	Speed	Steps	5 Steps, Quiet, Auto	5 Steps, Quiet, Auto
Air Direction Control			Right, Left, Horizontal, Downward	Right, Left, Horizontal, Downward
Air Filter			Removable-Washable-Mildew Proof	Removable-Washable-Mildew Proof
Running Current (Rated)		A	0.16	0.16
Power Consumption (Rated)		W	35	35
Power Factor		%	95.1	95.1
Temperature Control			Microcomputer Control	Microcomputer Control
Dimensions (HxWxD)		mm	283x800x195	283x800x195
Packaged Dimensions (HxWxD)		mm	265x855x340	265x855x340
Weight		kg	9	9
Gross Weight		kg	12	12
Operation Sound	H/L/SL	dBA	38/25/22	38/25/22
Sound Power	H	dBA	56	56
Heat Insulation			Both Liquid and Gas Pipes	Both Liquid and Gas Pipes
Piping Connection	Liquid	mm	φ 6.4	φ 6.4
	Gas	mm	φ 9.5	φ 9.5
	Drain	mm	φ18.0	φ18.0
Drawing No.			3D051079	3D051080

Model			FTKS25D3VMW	FTKS25D3VML
Rated Capacity			2.5kW Class	2.5kW Class
Front Panel Color			White	Silver Line
Air Flow Rates	m ³ /min (cfm)	H	8.7 (307)	8.7 (307)
		M	6.7 (237)	6.7 (237)
		L	4.7 (166)	4.7 (166)
		SL	3.9 (138)	3.9 (138)
Fan	Type	Cross Flow Fan		Cross Flow Fan
	Motor Output	W	40	40
	Speed	Steps	5 Steps, Quiet, Auto	5 Steps, Quiet, Auto
Air Direction Control			Right, Left, Horizontal, Downward	Right, Left, Horizontal, Downward
Air Filter			Removable-Washable-Mildew Proof	Removable-Washable-Mildew Proof
Running Current (Rated)		A	0.16	0.16
Power Consumption (Rated)		W	35	35
Power Factor		%	95.1	95.1
Temperature Control			Microcomputer Control	Microcomputer Control
Dimensions (HxWxD)		mm	283x800x195	283x800x195
Packaged Dimensions (HxWxD)		mm	265x855x340	265x855x340
Weight		kg	9	9
Gross Weight		kg	12	12
Operation Sound	H/L/SL	dBA	38/25/22	38/25/22
Sound Power	H	dBA	56	56
Heat Insulation			Both Liquid and Gas Pipes	Both Liquid and Gas Pipes
Piping Connection	Liquid	mm	φ 6.4	φ 6.4
	Gas	mm	φ 9.5	φ 9.5
	Drain	mm	φ18.0	φ18.0
Drawing No.			3D051081	3D051082

Conversion Formulae

kcal/h=kW×860
 Btu/h=kW×3414
 cfm=m³/min×35.3

50Hz 230V

Model			FTKS35D3VMW	FTKS35D3VML
Rated Capacity			3.5kW Class	3.5kW Class
Front Panel Color			White	Silver Line
Air Flow Rates	m ³ /min (cfm)	H	8.9 (314)	8.9 (314)
		M	6.9 (244)	6.9 (244)
		L	4.8 (169)	4.8 (169)
		SL	4.0 (141)	4.0 (141)
Fan	Type	Cross Flow Fan		Cross Flow Fan
	Motor Output	W	40	40
	Speed	Steps	5 Steps, Quiet, Auto	5 Steps, Quiet, Auto
Air Direction Control			Right, Left, Horizontal, Downward	Right, Left, Horizontal, Downward
Air Filter			Removable-Washable-Mildew Proof	Removable-Washable-Mildew Proof
Running Current (Rated)		A	0.18	0.18
Power Consumption (Rated)		W	40	40
Power Factor		%	96.6	96.6
Temperature Control			Microcomputer Control	Microcomputer Control
Dimensions (HxWxD)		mm	283x800x195	283x800x195
Packaged Dimensions (HxWxD)		mm	265x855x340	265x855x340
Weight		kg	9	9
Gross Weight		kg	12	12
Operation Sound	H/L/SL	dBA	39/26/23	39/26/23
Sound Power	H	dBA	57	57
Heat Insulation			Both Liquid and Gas Pipes	Both Liquid and Gas Pipes
Piping Connection	Liquid	mm	φ 6.4	φ 6.4
	Gas	mm	φ 9.5	φ 9.5
	Drain	mm	φ18.0	φ18.0
Drawing No.			3D051083	3D051084

Model			FTKS50D2V1W	FTKS50D2V1L
Rated Capacity			5.0kW Class	5.0kW Class
Front Panel Color			White	Silver Line
Air Flow Rates	m ³ /min (cfm)	H	11.4 (402)	11.4 (402)
		M	9.3 (328)	9.3 (328)
		L	7.1 (251)	7.1 (251)
		SL	6.2 (219)	6.2 (219)
Fan	Type	Cross Flow Fan		Cross Flow Fan
	Motor Output	W	40	40
	Speed	Steps	5 Steps, Quiet, Auto	5 Steps, Quiet, Auto
Air Direction Control			Right, Left, Horizontal, Downward	Right, Left, Horizontal, Downward
Air Filter			Removable-Washable-Mildew Proof	Removable-Washable-Mildew Proof
Running Current (Rated)		A	0.21	0.21
Power Consumption (Rated)		W	48	48
Power Factor		%	99.4	99.4
Temperature Control			Microcomputer Control	Microcomputer Control
Dimensions (HxWxD)		mm	283x800x195	283x800x195
Packaged Dimensions (HxWxD)		mm	265x855x340	265x855x340
Weight		kg	9	9
Gross Weight		kg	12	12
Operation Sound	H/M/L/SL	dBA	46/41/35/32	46/41/35/32
Sound Power	H	dBA	62	62
Heat Insulation			Both Liquid and Gas Pipes	Both Liquid and Gas Pipes
Piping Connection	Liquid	mm	φ 6.4	φ 6.4
	Gas	mm	φ12.7	φ12.7
	Drain	mm	φ18.0	φ18.0
Drawing No.			3D051812	3D051813

Conversion Formulae

kcal/h=kWx860
Btu/h=kWx3414
cfm=m³/minx35.3

50Hz 230V

Model			FTKS20CAVMB	FTKS25CAVMB
Rated Capacity			2.0kW Class	2.5kW Class
Front Panel Color			White	White
Air Flow Rates	m ³ /min (cfm)	H	7.7 (272)	7.7 (272)
		M	5.9 (208)	5.9 (208)
		L	4.2 (148)	4.2 (148)
		SL	3.6 (127)	3.6 (127)
Fan	Type	Cross Flow Fan		Cross Flow Fan
	Motor Output	W	18	18
	Speed	Steps	5 Steps, Quiet, Auto	5 Steps, Quiet, Auto
Air Direction Control			Right, Left, Horizontal, Downward	Right, Left, Horizontal, Downward
Air Filter			Removable-Washable-Mildew Proof	Removable-Washable-Mildew Proof
Running Current (Rated)		A	0.18	0.18
Power Consumption (Rated)		W	40	40
Power Factor		%	96.6	96.6
Temperature Control			Microcomputer Control	Microcomputer Control
Dimensions (HxWxD)		mm	273x784x195	273x784x195
Packaged Dimensions (HxWxD)		mm	258x834x325	258x834x325
Weight		kg	7.5	7.5
Gross Weight		kg	11	11
Operation Sound	H/M/L/SL	dBA	38/32/25/22	38/32/25/22
Sound Power	H	dBA	56	56
Heat Insulation			Both Liquid and Gas Pipes	Both Liquid and Gas Pipes
Piping Connection	Liquid	mm	φ 6.4	φ 6.4
	Gas	mm	φ 9.5	φ 9.5
	Drain	mm	φ18.0	φ18.0
Drawing No.			3D050947	3D050949

Model			FTKS35CAVMB	FTKS50FV1B
Rated Capacity			3.5kW Class	5.0kW Class
Front Panel Color			White	White
Air Flow Rates	m ³ /min (cfm)	H	7.7 (272)	14.7 (519)
		M	6.0 (212)	12.4 (438)
		L	4.4 (155)	10.3 (364)
		SL	3.8 (134)	9.5 (335)
Fan	Type	Cross Flow Fan		Cross Flow Fan
	Motor Output	W	18	43
	Speed	Steps	5 Steps, Quiet, Auto	5 Steps, Quiet, Auto
Air Direction Control			Right, Left, Horizontal, Downward	Right, Left, Horizontal, Downward
Air Filter			Removable-Washable-Mildew Proof	Removable-Washable-Mildew Proof
Running Current (Rated)		A	0.18	0.15
Power Consumption (Rated)		W	40	34
Power Factor		%	96.6	98.6
Temperature Control			Microcomputer Control	Microcomputer Control
Dimensions (HxWxD)		mm	273x784x195	290x1,050x238
Packaged Dimensions (HxWxD)		mm	258x834x325	337x1,147x366
Weight		kg	7.5	12
Gross Weight		kg	11	17
Operation Sound	H/M/L/SL	dBA	39/33/26/23	43/39/34/31
Sound Power	H	dBA	57	59
Heat Insulation			Both Liquid and Gas Pipes	Both Liquid and Gas Pipes
Piping Connection	Liquid	mm	φ 6.4	φ 6.4
	Gas	mm	φ 9.5	φ12.7
	Drain	mm	φ18.0	φ18.0
Drawing No.			3D050951	3D056016

Conversion Formulae
kcal/h=kWx860
Btu/h=kWx3414
cfm=m ³ /minx35.3

Duct Connected Type

50Hz 230V

Model			FDKS25CAVMB	FDKS35CAVMB
Rated Capacity			2.5kW Class	3.5kW Class
Front Panel Color			—	—
Air Flow Rates	m ³ /min (cfm)	H	9.5 (335)	10.0 (353)
		M	8.8 (311)	9.3 (328)
		L	8.0 (282)	8.5 (300)
		SL	6.7 (237)	7.0 (247)
Fan	Type	Sirocco Fan		Sirocco Fan
	Motor Output	W	62	62
	Speed	Steps	5 Steps, Quiet, Auto	5 Steps, Quiet, Auto
Air Filter			Removable-Washable-Mildew Proof	Removable-Washable-Mildew Proof
Running Current (Rated)		A	0.47	0.47
Power Consumption (Rated)		W	100	100
Power Factor		%	92.5	92.5
Temperature Control			Microcomputer Control	Microcomputer Control
Dimensions (HxWxD)		mm	200x900x620	200x900x620
Packaged Dimensions (HxWxD)		mm	266x1,106x751	266x1,106x751
Weight		kg	25	25
Gross Weight		kg	31	31
Operation Sound	H/M/L/SL	dBA	35/33/31/29	35/33/31/29
External Static Pressure		Pa	40	40
Moisture Removal		L/h	1.2	1.9
Heat Insulation			Both Liquid and Gas Pipes	Both Liquid and Gas Pipes
Piping Connection	Liquid	mm	φ 6.4	φ 6.4
	Gas	mm	φ 9.5	φ 9.5
	Drain	mm	VP20 (O.D. φ26 / I.D. φ20)	VP20 (O.D. φ26 / I.D. φ20)
Drawing No.			3D048947C	3D048948C

Model			FDKS50CVMB	
Rated Capacity			5.0kW Class	
Front Panel Color			—	
Air Flow Rates	m ³ /min (cfm)	H	12.0 (424)	
		M	11.0 (388)	
		L	10.0 (353)	
		SL	8.4 (297)	
Fan	Type	Sirocco Fan		
	Motor Output	W	130	
	Speed	Steps	5 Steps, Quiet, Auto	
Air Filter			Removable-Washable-Mildew Proof	
Running Current (Rated)		A	0.64	
Power Consumption (Rated)		W	140	
Power Factor		%	95.1	
Temperature Control			Microcomputer Control	
Dimensions (HxWxD)		mm	200x900x620	
Packaged Dimensions (HxWxD)		mm	266x1,106x751	
Weight		kg	27	
Gross Weight		kg	34	
Operation Sound	H/M/L/SL	dBA	37/35/33/31	
External Static Pressure		Pa	40	
Moisture Removal		L/h	2.9	
Heat Insulation			Both Liquid and Gas Pipes	
Piping Connection	Liquid	mm	φ 6.4	
	Gas	mm	φ 12.7	
	Drain	mm	VP20 (O.D. φ26 / I.D. φ20)	
Drawing No.			3D052134A	

- Note:**
- The operating sound is based on the rear side suction inlet and the external static pressure 40 Pa. Operating sound for under side suction inlet: [operating sound for rear side suction inlet]+5 dB. However, when installation to which the external static pressure becomes low is carried out, 5 dB or more may go up.

Conversion Formulae

kcal/h=kW×860
Btu/h=kW×3414
cfm=m³/min×35.3

50Hz 230V

Model			FDKS25EAVMB	FDKS35EAVMB
Rated Capacity			2.5kW Class	3.5kW Class
Front Panel Color			—	—
Air Flow Rates	m ³ /min (cfm)	H	8.7 (307)	8.7 (307)
		M	8.0 (282)	8.0 (282)
		L	7.3 (258)	7.3 (258)
		SL	6.2 (219)	6.2 (219)
Fan	Type		Sirocco Fan	Sirocco Fan
	Motor Output	W	62	62
	Speed	Steps	5 Steps, Quiet, Auto	5 Steps, Quiet, Auto
Air Filter			Removable-Washable-Mildew Proof	Removable-Washable-Mildew Proof
Running Current (Rated)		A	0.48	0.48
Power Consumption (Rated)		W	71	71
Power Factor		%	64.3	64.3
Temperature Control			Microcomputer Control	Microcomputer Control
Dimensions (HxWxD)		mm	200x700x620	200x700x620
Packaged Dimensions (HxWxD)		mm	274x906x751	274x906x751
Weight		kg	21	21
Gross Weight		kg	29	29
Operation Sound	H/M/L/SL	dBA	35/33/31/29	35/33/31/29
External Static Pressure		Pa	30	30
Moisture Removal		L/h	1.2	1.9
Heat Insulation			Both Liquid and Gas Pipes	Both Liquid and Gas Pipes
Piping Connection	Liquid	mm	φ 6.4	φ 6.4
	Gas	mm	φ 9.5	φ 9.5
	Drain	mm	VP20 (O.D.φ 26 / I.D.φ 20)	VP20 (O.D.φ 26 / I.D.φ 20)
Drawing No.			3D051882A	3D051884A

Note: 1. The operating sound is based on the rear side suction inlet and the external static pressure 30 Pa. Operating sound for under side suction inlet: [operating sound for rear side suction inlet]+6 dB. However, when installation to which the external static pressure becomes low is carried out, 6 dB or more may go up.

Conversion Formulae
kcal/h=kW×860
Btu/h=kW×3414
cfm=m ³ /min×35.3

Floor / Ceiling Suspended Dual Type

50Hz 230V

Model			FLKS25BAVMB	FLKS35BAVMB
Rated Capacity			2.5kW Class	3.5kW Class
Front Panel Color			Almond White	Almond White
Air Flow Rates	m ³ /min (cfm)	H	7.6 (268)	8.6 (304)
		M	6.8 (240)	7.6 (268)
		L	6.0 (212)	6.6 (233)
		SL	5.2 (184)	5.6 (198)
Fan	Type	Sirocco Fan		Sirocco Fan
	Motor Output	W	34	34
	Speed	Steps	5 Steps, Quiet, Auto	5 Steps, Quiet, Auto
Air Direction Control			Right, Left, Horizontal, Downward	Right, Left, Horizontal, Downward
Air Filter			Removable-Washable-Mildew Proof	Removable-Washable-Mildew Proof
Running Current (Rated)		A	0.34	0.36
Power Consumption (Rated)		W	74	78
Power Factor		%	94.6	94.2
Temperature Control			Microcomputer Control	Microcomputer Control
Dimensions (HxWxD)		mm	490x1,050x200	490x1,050x200
Packaged Dimensions (HxWxD)		mm	566x1,100x280	566x1,100x280
Weight		kg	16	16
Gross Weight		kg	22	22
Operation Sound	H/M/L/SL	dBA	37/34/31/28	38/35/32/29
Sound Power	H	dBA	53	54
Heat Insulation			Both Liquid and Gas Pipes	Both Liquid and Gas Pipes
Piping Connection	Liquid	mm	φ 6.4	φ 6.4
	Gas	mm	φ 9.5	φ 9.5
	Drain	mm	φ18.0	φ18.0
Drawing No.			3D050862	3D050864

Model			FLKS50BAVMB	
Rated Capacity			5.0W Class	
Front Panel Color			Almond White	
Air Flow Rates	m ³ /min (cfm)	H	11.4 (402)	
		M	10.0 (353)	
		L	8.5 (300)	
		SL	7.5 (265)	
Fan	Type	Sirocco Fan		
	Motor Output	W	34	
	Speed	Steps	5 Steps, Quiet, Auto	
Air Direction Control			Right, Left, Horizontal, Downward	
Air Filter			Removable-Washable-Mildew Proof	
Running Current (Rated)		A	0.45	
Power Consumption (Rated)		W	96	
Power Factor		%	92.8	
Temperature Control			Microcomputer Control	
Dimensions (HxWxD)		mm	490x1,050x200	
Packaged Dimensions (HxWxD)		mm	280x1,100x566	
Weight		kg	17	
Gross Weight		kg	24	
Operation Sound	H/M/L/SL	dBA	47/43/39/36	
Sound Power	H	dBA	63	
Heat Insulation			Both Liquid and Gas Pipes	
Piping Connection	Liquid	mm	φ 6.4	
	Gas	mm	φ12.7	
	Drain	mm	φ18.0	
Drawing No.			3D050896	

Conversion Formulae

kcal/h=kW×860
 Btu/h=kW×3414
 cfm=m³/min×35.3

Floor Standing Type

50Hz 230V

Model			FVXS25FV1B	FVXS35FV1B
Rated Capacity			2.5kW Class	3.5kW Class
Front Panel Color			White	White
Air Flow Rates	m ³ /min (cfm)	H	8.2 (290)	8.5 (300)
		M	6.5 (229)	6.7 (237)
		L	4.8 (169)	4.9 (174)
		SL	4.1 (146)	4.5 (158)
Fan	Type	Turbo Fan		Turbo Fan
	Motor Output	W	48	48
	Speed	Steps	5 Steps, Quiet, Auto	5 Steps, Quiet, Auto
Air Direction Control			Right, Left, Horizontal, Downward	Right, Left, Horizontal, Downward
Air Filter			Removable-Washable-Mildew Proof	Removable-Washable-Mildew Proof
Running Current (Rated)		A	0.13	0.13
Power Consumption (Rated)		W	15	15
Power Factor		%	50.2	50.2
Temperature Control			Microcomputer Control	Microcomputer Control
Dimensions (HxWxD)		mm	600x700x210	600x700x210
Packaged Dimensions (HxWxD)		mm	696x786x286	696x786x286
Weight		kg	14	14
Gross Weight		kg	18	18
Operation Sound	H/M/L/SL	dBA	38/32/26/23	39/33/27/24
Sound Power	H	dBA	54	55
Heat Insulation			Both Liquid and Gas Pipes	Both Liquid and Gas Pipes
Piping Connection	Liquid	mm	φ 6.4	φ 6.4
	Gas	mm	φ 9.5	φ 9.5
	Drain	mm	φ 20	φ 20
Drawing No.			3D056295	3D056296

Model			FVXS50FV1B
Rated Capacity			5.0kW Class
Front Panel Color			White
Air Flow Rates	m ³ /min (cfm)	H	10.7 (378)
		M	9.2 (326)
		L	7.8 (274)
		SL	6.6 (233)
Fan	Type	Turbo Fan	
	Motor Output	W	48
	Speed	Steps	5 Steps, Quiet, Auto
Air Direction Control			Right, Left, Horizontal, Downward
Air Filter			Removable-Washable-Mildew Proof
Running Current (Rated)		A	0.17
Power Consumption (Rated)		W	27
Power Factor		%	69.1
Temperature Control			Microcomputer Control
Dimensions (HxWxD)		mm	600x700x210
Packaged Dimensions (HxWxD)		mm	696x786x286
Weight		kg	14
Gross Weight		kg	18
Operation Sound	H/M/L/SL	dBA	44/40/36/32
Sound Power	H	dBA	56
Heat Insulation			Both Liquid and Gas Pipes
Piping Connection	Liquid	mm	φ 6.4
	Gas	mm	φ 12.7
	Drain	mm	φ 20.0
Drawing No.			3D056297

Conversion Formulae
kcal/h=kWx860
Btu/h=kWx3414
cfm=m ³ /minx35.3

Ceiling Suspended Type

50Hz 230V

Model			FHQ35BVV1B	FHQ50BVV1B
Rated Capacity			3.5kW Class	5.0kW Class
Decoration Panel	Color		White	White
	Dimensions (HxWxD)		—	—
Air Flow Rates	m ³ /min (cfm)	H	13.0 (458)	13.0 (458)
		M	—	—
		L	10.0 (353)	10.0 (353)
		SL	—	—
Fan	Type		Sirocco Fan	Sirocco Fan
	Motor Output	W	62	62
	Speed	Steps	2 Steps	2 Steps
Air Direction Control			Right, Left, Horizontal, Downward	Right, Left, Horizontal, Downward
Air Filter			Removable-Washable-Mildew Proof	Removable-Washable-Mildew Proof
Temperature Control			Microcomputer Control	Microcomputer Control
Dimensions (HxWxD)		mm	195x960x680	195x960x680
Packaged Dimensions (HxWxD)		mm	279x1,046x818	279x1,046x818
Weight		kg	24	25
Gross Weight		kg	31	32
Operation Sound	H/L	dBA	37/32	38/33
Sound Power	H/L	dBA	53/48	54/49
Heat Insulation			Both Liquid and Gas Pipes	Both Liquid and Gas Pipes
Piping Connection	Liquid	mm	φ 6.4 (Flare)	φ 6.4 (Flare)
	Gas	mm	φ 9.5 (Flare)	φ 12.7 (Flare)
	Drain	mm	VP20 (O.D.φ 26 / I.D.φ 20)	VP20 (O.D.φ 26 / I.D.φ 20)
Drawing No.			3D037992E	3D037992E

Conversion Formulae

kcal/h=kWx860
 Btu/h=kWx3414
 cfm=m³/minx35.3

1.2 Outdoor Units - Cooling Only

50Hz 230V

Model		3MKS50E3V1B		4MKS58E3V1B	
Cooling Capacity	kW	—		—	
Power Consumption	W	—		—	
Running Current	A	—		—	
Casing Color		Ivory White		Ivory White	
Compressor	Type	Hermetically Sealed Swing Type		Hermetically Sealed Swing Type	
	Model	2YC36BXD		2YC36BXD	
	Motor Output	W	1,100	1,100	
Refrigerant Oil	Model	FVC50K		FVC50K	
	Charge	L	0.65	0.65	
Refrigerant	Type	R-410A		R-410A	
	Charge	kg	2.0	2.0	
Air Flow Rates	m ³ /min	H	45	45	
		L	45	45	
	cfm	H	1,589	1,589	
		L	1,589	1,589	
Fan	Type	Propeller		Propeller	
	Motor Output	W	53	53	
	Running Current	A	H: 0.33 / L: 0.33	H: 0.33 / L: 0.33	
	Power Consumption	W	H: 43 / L: 43	H: 43 / L: 43	
Starting Current	A	5.3		6.7	
Dimensions (HxWxD)	mm	735x936x300		735x936x300	
Packaged Dimensions (HxWxD)	mm	797x992x390		797x992x390	
Weight	kg	49		49	
Gross Weight	kg	56		56	
Operation Sound	dBA	46		46	
Sound Power	dBA	59		59	
Piping Connection	Liquid	mm	φ 6.4x3	φ 6.4x4	
	Gas	mm	φ 9.5x3	φ 9.5x2, φ 12.7x2	
	Drain	mm	φ 18.0	φ 18.0	
Heat Insulation		Both Liquid and Gas Pipes		Both Liquid and Gas Pipes	
No. of Wiring Connection		3 for Power Supply, 4 for Interunit Wiring		3 for Power Supply, 4 for Interunit Wiring	
Max. Interunit Piping Length	m	50 (for Total of Each Room)		50 (for Total of Each Room)	
	m	25 (for One Room)		25 (for One Room)	
Amount of Additional Charge	g/m	Chargeless		Chargeless	
Max. Installation Height Difference	m	15 (between Indoor Unit and Outdoor Unit)		15 (between Indoor Unit and Outdoor Unit)	
	m	15 (between Indoor Units)		15 (between Indoor Units)	
Drawing No.		3D052268#1		3D052267#1	

Note: The data are based on the conditions shown in the table below.

Cooling	Piping Length
Indoor ; 27°CDB/19°CWB Outdoor ; 35°CDB	7.5m

Conversion Formulae
kcal/h=kWx860 Btu/h=kWx3414 cfm=m ³ /minx35.3

1.3 Indoor Units - Heat Pump

Wall Mounted Type

50Hz 230V

Model			FTXG25EV1BW		FTXG25EV1BS	
			Cooling	Heating	Cooling	Heating
Rated Capacity			2.5kW Class		2.5kW Class	
Front Panel Color			Mat Crystal White		Mat Crystal Silver	
Air Flow Rates	m ³ /min (cfm)	H	7.7 (271)	9.0 (317)	7.7 (271)	9.0 (317)
		M	6.1 (215)	7.9 (278)	6.1 (215)	7.9 (278)
		L	4.7 (165)	6.7 (236)	4.7 (165)	6.7 (236)
		SL	3.8 (134)	5.4 (190)	3.8 (134)	5.4 (190)
Fan	Type	Cross Flow Fan		Cross Flow Fan		
	Motor Output	W	40		40	
	Speed	Steps	5 Steps, Quiet, Auto		5 Steps, Quiet, Auto	
Air Direction Control			Right, Left, Horizontal, Downward		Right, Left, Horizontal, Downward	
Air Filter			Removable-Washable-Mildew Proof		Removable-Washable-Mildew Proof	
Running Current (Rated)		A	0.15-0.14-0.13	0.15-0.14-0.13	0.15-0.14-0.13	0.15-0.14-0.13
Power Consumption (Rated)		W	30-30-30	30-30-30	30-30-30	30-30-30
Power Factor		%	90.9-93.2-96.2	90.9-93.2-96.2	90.9-93.2-96.2	90.9-93.2-96.2
Temperature Control			Microcomputer Control		Microcomputer Control	
Dimensions (HxWxD)		mm	275x840x150		275x840x150	
Packaged Dimensions (HxWxD)		mm	222x894x345		222x894x345	
Weight		kg	9		9	
Gross Weight		kg	13		13	
Operation Sound	H/M/L/SL	dBA	38/32/25/22	38/33/28/25	38/32/25/22	38/33/28/25
Sound Power	H	dBA	56	56	56	56
Heat Insulation			Both Liquid and Gas Pipes		Both Liquid and Gas Pipes	
Piping Connection	Liquid	mm	φ 6.4		φ 6.4	
	Gas	mm	φ 9.5		φ 9.5	
	Drain	mm	φ18.0		φ18.0	
Drawing No.			3D051101		3D051102	

Model			FTXG35EV1BW		FTXG35EV1BS	
			Cooling	Heating	Cooling	Heating
Rated Capacity			3.5kW Class		5.0kW Class	
Front Panel Color			Mat Crystal White		Mat Crystal Silver	
Air Flow Rates	m ³ /min (cfm)	H	8.1 (285)	9.6 (338)	8.1 (285)	9.6 (338)
		M	6.5 (229)	8.2 (289)	6.5 (229)	8.2 (289)
		L	4.9 (173)	6.7 (236)	4.9 (173)	6.7 (236)
		SL	4.1 (144)	5.9 (208)	4.1 (144)	5.9 (208)
Fan	Type	Cross Flow Fan		Cross Flow Fan		
	Motor Output	W	40		40	
	Speed	Steps	5 Steps, Quiet, Auto		5 Steps, Quiet, Auto	
Air Direction Control			Right, Left, Horizontal, Downward		Right, Left, Horizontal, Downward	
Air Filter			Removable-Washable-Mildew Proof		Removable-Washable-Mildew Proof	
Running Current (Rated)		A	0.15-0.14-0.13	0.15-0.14-0.13	0.15-0.14-0.13	0.15-0.14-0.13
Power Consumption (Rated)		W	30-30-30	30-30-30	30-30-30	30-30-30
Power Factor		%	90.9-93.2-96.2	90.9-93.2-96.2	90.9-93.2-96.2	90.9-93.2-96.2
Temperature Control			Microcomputer Control		Microcomputer Control	
Dimensions (HxWxD)		mm	275x840x150		275x840x150	
Packaged Dimensions (HxWxD)		mm	222x894x345		222x894x345	
Weight		kg	9		9	
Gross Weight		kg	13		13	
Operation Sound	H/M/L/SL	dBA	39/33/26/23	39/34/29/26	39/33/26/23	39/34/29/26
Sound Power	H	dBA	57	57	57	57
Heat Insulation			Both Liquid and Gas Pipes		Both Liquid and Gas Pipes	
Piping Connection	Liquid	mm	φ 6.4		φ 6.4	
	Gas	mm	φ 9.5		φ12.7	
	Drain	mm	φ18.0		φ18.0	
Drawing No.			3D051103		3D051104	

Conversion Formulae
kcal/h=kWx860
Btu/h=kWx3414
cfm=m ³ /minx35.3

50Hz 230V

Model			CTXG50EV1BW				CTXG50EV1BS			
			Cooling		Heating		Cooling		Heating	
Rated Capacity			5.0kW Class				5.0kW Class			
Front Panel Color			Mat Crystal White				Mat Crystal Silver			
Air Flow Rates	m ³ /min (cfm)	H	11.3 (398)	12.6 (444)	11.3 (398)	12.6 (444)				
		M	9.1 (320)	10.6 (373)	9.1 (320)	10.6 (373)				
		L	7.1 (250)	8.7 (306)	7.1 (250)	8.7 (306)				
		SL	6.7 (236)	7.7 (271)	6.7 (236)	7.7 (271)				
Fan	Type	Cross Flow Fan				Cross Flow Fan				
	Motor Output	W	40				40			
	Speed	Steps	5 Steps, Quiet, Auto				5 Steps, Quiet, Auto			
Air Direction Control			Right, Left, Horizontal, Downward				Right, Left, Horizontal, Downward			
Air Filter			Removable-Washable-Mildew Proof				Removable-Washable-Mildew Proof			
Running Current (Rated)		A	0.15-0.14-0.13	0.15-0.14-0.13	0.15-0.14-0.13	0.15-0.14-0.13				
Power Consumption (Rated)		W	30	30	30	30				
Power Factor		%	90.9-93.2-96.2	90.9-93.2-96.2	90.9-93.2-96.2	90.9-93.2-96.2				
Temperature Control			Microcomputer Control				Microcomputer Control			
Dimensions (HxWxD)		mm	275x840x150				275x840x150			
Packaged Dimensions (HxWxD)		mm	222x894x345				222x894x345			
Weight		kg	9				9			
Gross Weight		kg	13				13			
Operation Sound	H/M/L/SL	dBA	47/41/35/32	47/41/35/32	47/41/35/32	47/41/35/32				
Sound Power	H	dBA	64	64	64	64				
Heat Insulation			Both Liquid and Gas Pipes				Both Liquid and Gas Pipes			
Piping Connection	Liquid	mm	φ 6.4				φ 6.4			
	Gas	mm	φ 12.7				φ 12.7			
	Drain	mm	φ18.0				φ18.0			
Drawing No.			3D051105				3D051106			

Model			FTXS20D3VMW				FTXS20D3VML			
			Cooling		Heating		Cooling		Heating	
Rated Capacity			2.0kW Class				2.0kW Class			
Front Panel Color			White				Silver Line			
Air Flow Rates	m ³ /min (cfm)	H	8.7 (307)	9.4 (332)	8.7 (307)	9.4 (332)				
		M	6.7 (237)	7.6 (268)	6.7 (237)	7.6 (268)				
		L	4.7 (166)	5.8 (205)	4.7 (166)	5.8 (205)				
		SL	3.9 (138)	5.0 (177)	3.9 (138)	5.0 (177)				
Fan	Type	Cross Flow Fan				Cross Flow Fan				
	Motor Output	W	40				40			
	Speed	Steps	5 Steps, Quiet, Auto				5 Steps, Quiet, Auto			
Air Direction Control			Right, Left, Horizontal, Downward				Right, Left, Horizontal, Downward			
Air Filter			Removable-Washable-Mildew Proof				Removable-Washable-Mildew Proof			
Running Current (Rated)		A	0.16	0.16	0.16	0.16				
Power Consumption (Rated)		W	35	35	35	35				
Power Factor		%	95.1	95.1	95.1	95.1				
Temperature Control			Microcomputer Control				Microcomputer Control			
Dimensions (HxWxD)		mm	283x800x195				283x800x195			
Packaged Dimensions (HxWxD)		mm	265x855x340				265x855x340			
Weight		kg	9				9			
Gross Weight		kg	12				12			
Operation Sound	H/L/SL	dBA	38/25/22	38/28/25	38/25/22	38/28/25				
Sound Power	H	dBA	56	56	56	56				
Heat Insulation			Both Liquid and Gas Pipes				Both Liquid and Gas Pipes			
Piping Connection	Liquid	mm	φ 6.4				φ 6.4			
	Gas	mm	φ 9.5				φ 9.5			
	Drain	mm	φ18.0				φ18.0			
Drawing No.			3D051085				3D051086			

Conversion Formulae
kcal/h=kWx860
Btu/h=kWx3414
cfm=m ³ /minx35.3

50Hz 230V

Model			FTXS25D3VMW		FTXS25D3VML	
			Cooling	Heating	Cooling	Heating
Rated Capacity			2.5kW Class		2.5kW Class	
Front Panel Color			White		Silver Line	
Air Flow Rates	m ³ /min (cfm)	H	8.7 (307)	9.4 (332)	8.7 (307)	9.4 (332)
		M	6.7 (237)	7.6 (268)	6.7 (237)	7.6 (268)
		L	4.7 (166)	5.8 (205)	4.7 (166)	5.8 (205)
		SL	3.9 (138)	5.0 (177)	3.9 (138)	5.0 (177)
Fan	Type	Cross Flow Fan				
	Motor Output	W	40		40	
	Speed	Steps	5 Steps, Quiet, Auto		5 Steps, Quiet, Auto	
Air Direction Control			Right, Left, Horizontal, Downward		Right, Left, Horizontal, Downward	
Air Filter			Removable-Washable-Mildew Proof		Removable-Washable-Mildew Proof	
Running Current (Rated)		A	0.16	0.16	0.16	0.16
Power Consumption (Rated)		W	35	35	35	35
Power Factor		%	95.1	95.1	95.1	95.1
Temperature Control			Microcomputer Control		Microcomputer Control	
Dimensions (HxWxD)		mm	283x800x195		283x800x195	
Packaged Dimensions (HxWxD)		mm	265x855x340		265x855x340	
Weight		kg	9		9	
Gross Weight		kg	12		12	
Operation Sound	H/L/SL	dBA	38/25/22	38/28/25	38/25/22	38/28/25
Sound Power	H	dBA	56	56	56	56
Heat Insulation			Both Liquid and Gas Pipes		Both Liquid and Gas Pipes	
Piping Connection	Liquid	mm	φ 6.4		φ 6.4	
	Gas	mm	φ 9.5		φ 9.5	
	Drain	mm	φ18.0		φ18.0	
Drawing No.			3D051087		3D051088	

Model			FTXS35D3VMW		FTXS35D3VML	
			Cooling	Heating	Cooling	Heating
Rated Capacity			3.5kW Class		3.5kW Class	
Front Panel Color			White		Silver Line	
Air Flow Rates	m ³ /min (cfm)	H	8.9 (314)	9.7 (342)	8.9 (314)	9.7 (342)
		M	6.9 (244)	7.9 (279)	6.9 (244)	7.9 (279)
		L	4.8 (169)	6.0 (212)	4.8 (169)	6.0 (212)
		SL	4.0 (141)	5.2 (184)	4.0 (141)	5.2 (184)
Fan	Type	Cross Flow Fan				
	Motor Output	W	40		40	
	Speed	Steps	5 Steps, Quiet, Auto		5 Steps, Quiet, Auto	
Air Direction Control			Right, Left, Horizontal, Downward		Right, Left, Horizontal, Downward	
Air Filter			Removable-Washable-Mildew Proof		Removable-Washable-Mildew Proof	
Running Current (Rated)		A	0.18	0.18	0.18	0.18
Power Consumption (Rated)		W	40	40	40	40
Power Factor		%	96.6	96.6	96.6	96.6
Temperature Control			Microcomputer Control		Microcomputer Control	
Dimensions (HxWxD)		mm	283x800x195		283x800x195	
Packaged Dimensions (HxWxD)		mm	265x855x340		265x855x340	
Weight		kg	9		9	
Gross Weight		kg	12		12	
Operation Sound	H/L/SL	dBA	39/26/23	39/29/26	39/26/23	39/29/26
Sound Power	H	dBA	57	57	57	57
Heat Insulation			Both Liquid and Gas Pipes		Both Liquid and Gas Pipes	
Piping Connection	Liquid	mm	φ 6.4		φ 6.4	
	Gas	mm	φ 9.5		φ 9.5	
	Drain	mm	φ18.0		φ18.0	
Drawing No.			3D051089		3D051090	

Conversion Formulae
kcal/h=kWx860
Btu/h=kWx3414
cfm=m ³ /minx35.3

50Hz 230V

Model			FTXS50D2V1W				FTXS50D2V1L			
			Cooling		Heating		Cooling		Heating	
Rated Capacity			5.0kW Class				5.0kW Class			
Front Panel Color			White				White			
Air Flow Rates	m ³ /min (cfm)	H	11.4 (402)		11.4 (402)		11.4 (402)		11.4 (402)	
		M	9.3 (328)		9.4 (332)		9.3 (328)		9.4 (332)	
		L	7.1 (251)		7.4 (261)		7.1 (251)		7.4 (261)	
		SL	6.2 (219)		6.3 (222)		6.2 (219)		6.3 (222)	
Fan	Type	Cross Flow Fan				Cross Flow Fan				
	Motor Output	W	40				40			
	Speed	Steps	5 Steps, Quiet, Auto				5 Steps, Quiet, Auto			
Air Direction Control			Right, Left, Horizontal, Downward				Right, Left, Horizontal, Downward			
Air Filter			Removable-Washable-Mildew Proof				Removable-Washable-Mildew Proof			
Running Current (Rated)		A	0.21		0.21		0.21		0.21	
Power Consumption (Rated)		W	48		48		48		48	
Power Factor		%	99.4		99.4		99.4		99.4	
Temperature Control			Microcomputer Control				Microcomputer Control			
Dimensions (HxWxD)		mm	283x800x195				283x800x195			
Packaged Dimensions (HxWxD)		mm	265x855x340				265x855x340			
Weight		kg	9				9			
Gross Weight		kg	12				12			
Operation Sound	H/M/L/SL	dBA	46/41/35/32		46/40/34/31		46/41/35/32		46/40/34/31	
Sound Power	H	dBA	62		62		62		62	
Heat Insulation			Both Liquid and Gas Pipes				Both Liquid and Gas Pipes			
Piping Connection	Liquid	mm	φ 6.4				φ 6.4			
	Gas	mm	φ 12.7				φ 15.9			
	Drain	mm	φ 18.0				φ 18.0			
Drawing No.			3D051814				3D051815			

Model			FTXS20CAVMB				FTXS25CAVMB			
			Cooling		Heating		Cooling		Heating	
Rated Capacity			2.5kW Class				2.5kW Class			
Front Panel Color			White				White			
Air Flow Rates	m ³ /min (cfm)	H	7.7 (272)		7.8 (275)		7.7 (272)		7.8 (275)	
		M	5.9 (208)		6.5 (230)		5.9 (208)		6.5 (230)	
		L	4.2 (148)		5.3 (187)		4.2 (148)		5.3 (187)	
		SL	3.6 (127)		4.6 (162)		3.6 (127)		4.6 (162)	
Fan	Type	Cross Flow Fan				Cross Flow Fan				
	Motor Output	W	18				18			
	Speed	Steps	5 Steps, Quiet, Auto				5 Steps, Quiet, Auto			
Air Direction Control			Right, Left, Horizontal, Downward				Right, Left, Horizontal, Downward			
Air Filter			Removable-Washable-Mildew Proof				Removable-Washable-Mildew Proof			
Running Current (Rated)		A	0.18		0.18		0.18		0.18	
Power Consumption (Rated)		W	40		40		40		40	
Power Factor		%	96.6		96.6		96.6		96.6	
Temperature Control			Microcomputer Control				Microcomputer Control			
Dimensions (HxWxD)		mm	273x784x195				273x784x195			
Packaged Dimensions (HxWxD)		mm	258x834x325				258x834x325			
Weight		kg	7.5				7.5			
Gross Weight		kg	11				11			
Operation Sound	H/M/L/SL	dBA	38/32/25/22		38/33/28/25		38/32/25/22		38/33/28/25	
Sound Power	H	dBA	56		56		56		56	
Heat Insulation			Both Liquid and Gas Pipes				Both Liquid and Gas Pipes			
Piping Connection	Liquid	mm	φ 6.4				φ 6.4			
	Gas	mm	φ 9.5				φ 9.5			
	Drain	mm	φ 18.0				φ 18.0			
Drawing No.			3D050941				3D050943			

Conversion Formulae
kcal/h=kWx860
Btu/h=kWx3414
cfm=m ³ /minx35.3

50Hz 230V

Model			FTXS35CAVMB			
			Cooling		Heating	
Rated Capacity			3.5kW Class			
Front Panel Color			White			
Air Flow Rates	m³/min (cfm)	H	7.7 (272)		8.1 (286)	
		M	6.0 (212)		6.7 (237)	
		L	4.4 (155)		5.3 (187)	
		SL	3.8 (134)		4.6 (162)	
Fan	Type	Cross Flow Fan				
	Motor Output	W	18			
	Speed	Steps	5 Steps, Quiet, Auto			
Air Direction Control			Right, Left, Horizontal, Downward			
Air Filter			Removable-Washable-Mildew Proof			
Running Current (Rated)		A	0.18		0.18	
Power Consumption (Rated)		W	40		40	
Power Factor		%	96.6		96.6	
Temperature Control			Microcomputer Control			
Dimensions (HxWxD)		mm	273x784x195			
Packaged Dimensions (HxWxD)		mm	258x834x325			
Weight		kg	7.5			
Gross Weight		kg	11			
Operation Sound	H/M/L/SL	dBA	39/33/26/23		39/34/29/26	
Sound Power	H	dBA	57		57	
Heat Insulation			Both Liquid and Gas Pipes			
Piping Connection	Liquid	mm	φ 6.4			
	Gas	mm	φ 9.5			
	Drain	mm	φ18.0			
Drawing No.			3D050945			

Model			FTXS50FV1B			
			Cooling		Heating	
Rated Capacity			5.0kW Class			
Front Panel Color			White			
Air Flow Rates	m³/min (cfm)	H	14.7 (519)		16.1 (569)	
		M	12.4 (438)		13.9 (491)	
		L	10.3 (364)		11.5 (406)	
		SL	9.5 (335)		10.2 (360)	
Fan	Type	Cross Flow Fan				
	Motor Output	W	43			
	Speed	Steps	5 Steps, Quiet, Auto			
Air Direction Control			Right, Left, Horizontal, Downward			
Air Filter			Removable-Washable-Mildew Proof			
Running Current (Rated)		A	0.15		0.16	
Power Consumption (Rated)		W	34		36	
Power Factor		%	98.6		97.8	
Temperature Control			Microcomputer Control			
Dimensions (HxWxD)		mm	290x1,050x238			
Packaged Dimensions (HxWxD)		mm	337x1,147x366			
Weight		kg	12			
Gross Weight		kg	17			
Operation Sound	H/M/L/SL	dBA	43/39/34/31		42/38/33/30	
Sound Power	H	dBA	59		58	
Heat Insulation			Both Liquid and Gas Pipes			
Piping Connection	Liquid	mm	φ 6.4			
	Gas	mm	φ12.7			
	Drain	mm	φ18.0			
Drawing No.			3D056019			

Conversion Formulae
kcal/h=KWx860
Btu/h=KWx3414
cfm=m³/minx35.3

Duct Connected Type

50Hz 230V

Model			FDXS25CAVMB		FDXS35CAVMB	
			Cooling	Heating	Cooling	Heating
Rated Capacity			2.5kW Class		3.5kW Class	
Front Panel Color			—		—	
Air Flow Rates	m ³ /min (cfm)	H	9.5 (335)	9.5 (335)	10.0 (353)	10.0 (353)
		M	8.8 (311)	8.8 (311)	9.3 (328)	9.3 (328)
		L	8.0 (282)	8.0 (282)	8.5 (300)	8.5 (300)
		SL	6.7 (237)	6.7 (237)	7.0 (247)	7.0 (247)
Fan	Type	Sirocco Fan		Sirocco Fan		
	Motor Output	W	62		62	
	Speed	Steps	5 Steps, Quiet, Auto		5 Steps, Quiet, Auto	
Air Filter			Removable-Washable-Mildew Proof		Removable-Washable-Mildew Proof	
Running Current (Rated)		A	0.47	0.47	0.47	0.47
Power Consumption (Rated)		W	100	100	100	100
Power Factor		%	92.5	92.5	92.5	92.5
Temperature Control			Microcomputer Control		Microcomputer Control	
Dimensions (HxWxD)		mm	200x900x620		200x900x620	
Packaged Dimensions (HxWxD)		mm	266x1,106x751		266x1,106x751	
Weight		kg	25		25	
Gross Weight		kg	31		31	
Operation Sound	H/M/L/SL	dBA	35/33/31/29	35/33/31/29	35/33/31/29	35/33/31/29
External Static Pressure		Pa	40		40	
Heat Insulation			Both Liquid and Gas Pipes		Both Liquid and Gas Pipes	
Piping Connection	Liquid	mm	φ 6.4		φ 6.4	
	Gas	mm	φ 9.5		φ 9.5	
	Drain	mm	VP20 (O.D. φ 26 / I.D. φ 20)		VP20 (O.D. φ 26 / I.D. φ 20)	
Drawing No.			3D048945C		3D048946C	

Model			FDXS50CVMB	
			Cooling	Heating
Rated Capacity			5.0kW Class	
Front Panel Color			—	
Air Flow Rates	m ³ /min (cfm)	H	12.0 (424)	12.0 (424)
		M	11.0 (388)	11.0 (388)
		L	10.0 (353)	10.0 (353)
		SL	8.4 (297)	8.4 (297)
Fan	Type	Sirocco Fan		
	Motor Output	W	130	
	Speed	Steps	5 Steps, Quiet, Auto	
Air Filter			Removable-Washable-Mildew Proof	
Running Current (Rated)		A	0.64	0.64
Power Consumption (Rated)		W	140	140
Power Factor		%	95.1	95.1
Temperature Control			Microcomputer Control	
Dimensions (HxWxD)		mm	200x900x620	
Packaged Dimensions (HxWxD)		mm	266x1,106x751	
Weight		kg	27	
Gross Weight		kg	34	
Operation Sound	H/M/L/SL	dBA	37/35/33/31	37/35/33/31
External Static Pressure		Pa	40	
Heat Insulation			Both Liquid and Gas Pipes	
Piping Connection	Liquid	mm	φ 6.4	
	Gas	mm	φ 12.7	
	Drain	mm	VP20 (O.D. φ 26 / I.D. φ 20)	
Drawing No.			3D052132	

Note: 1. The operating sound is based on the rear side suction inlet and the external static pressure 40 Pa. Operating sound for under side suction inlet : [operating sound for rear side suction inlet] +5 dB. However, when installation to which the external static pressure becomes low is carried out, 5 dB or more may go up.

Conversion Formulae
kcal/h=kWx860
Btu/h=kWx3414
cfm=m ³ /minx35.3

50Hz 230V

Model			FDXS25EAVMB		FDXS35EAVMB	
			Cooling	Heating	Cooling	Heating
Rated Capacity			2.5kW Class		3.5kW Class	
Front Panel Color			—		—	
Air Flow Rates	m ³ /min (cfm)	H	8.7 (307)	8.7 (307)	8.7 (307)	8.7 (307)
		M	8.0 (282)	8.0 (282)	8.0 (282)	8.0 (282)
		L	7.3 (258)	7.3 (258)	7.3 (258)	7.3 (258)
		SL	6.2 (219)	6.2 (219)	6.2 (219)	6.2 (219)
Fan	Type	Sirocco Fan		Sirocco Fan		
	Motor Output	W	62		62	
	Speed	Steps	5 Steps, Quiet, Auto		5 Steps, Quiet, Auto	
Air Filter			Removable-Washable-Mildew Proof		Removable-Washable-Mildew Proof	
Running Current (Rated)		A	0.48	0.48	0.48	0.48
Power Consumption (Rated)		W	71	71	71	71
Power Factor		%	64.3	64.3	64.3	64.3
Temperature Control			Microcomputer Control		Microcomputer Control	
Dimensions (HxWxD)		mm	200x700x620		200x700x620	
Packaged Dimensions (HxWxD)		mm	274x906x751		274x906x751	
Weight		kg	21		21	
Gross Weight		kg	29		29	
Operation Sound	H/M/L/SL	dBA	35/33/31/29	35/33/31/29	35/33/31/29	35/33/31/29
External Static Pressure		Pa	30		30	
Heat Insulation			Both Liquid and Gas Pipes		Both Liquid and Gas Pipes	
Piping Connection	Liquid	mm	φ 6.4		φ 6.4	
	Gas	mm	φ 9.5		φ 9.5	
	Drain	mm	VP20 (O.D. φ 26 / I.D. φ 20)		VP20 (O.D. φ 26 / I.D. φ 20)	
Drawing No.			3D051881A		3D051883A	

Note: 1. The operating sound is based on the rear side suction inlet and the external static pressure 30 Pa. Operating sound for under side suction inlet : [operating sound for rear side suction inlet] +6 dB. However, when installation to which the external static pressure becomes low is carried out, 6 dB or more may go up.

Conversion Formulae
kcal/h=kWx860
Btu/h=kWx3414
cfm=m ³ /minx35.3

Floor / Ceiling Suspended Dual Type

50Hz 230V

Model			FLXS25BAVMB		FLXS35BAVMB	
			Cooling	Heating	Cooling	Heating
Rated Capacity			2.5kW Class		3.5kW Class	
Front Panel Color			Almond White			
Air Flow Rates	m ³ /min (cfm)	H	7.6 (268)	9.2 (325)	8.6 (304)	9.8 (346)
		M	6.8 (240)	8.3 (293)	7.6 (268)	8.9 (314)
		L	6.0 (212)	7.4 (261)	6.6 (233)	8.0 (282)
		SL	5.2 (184)	6.6 (233)	5.6 (198)	7.2 (254)
Fan	Type	Sirocco Fan				
	Motor Output	W	34			
	Speed	Steps	5 Steps, Quiet, Auto			
Air Direction Control			Right, Left, Horizontal, Downward		Right, Left, Horizontal, Downward	
Air Filter			Removable-Washable-Mildew Proof			
Running Current (Rated)	A	0.32	0.34	0.36	0.36	
Power Consumption (Rated)	W	70	74	78	78	
Power Factor	%	95.1	94.6	94.2	94.2	
Temperature Control			Microcomputer Control			
Dimensions (HxWxD)	mm	490x1,050x200			490x1,050x200	
Packaged Dimensions (HxWxD)	mm	566x1,100x280			566x1,100x280	
Weight	kg	16				
Gross Weight	kg	22				
Operation Sound	H/M/L/SL	dBA	37/34/31/28	37/34/31/29	38/35/32/29	39/36/33/30
Sound Power	H	dBA	53	—	54	—
Heat Insulation			Both Liquid and Gas Pipes			
Piping Connection	Liquid	mm	φ 6.4			
	Gas	mm	φ 9.5			
	Drain	mm	φ18.0			
Drawing No.			3D050866		3D050868	

Model			FLXS50BAVMB		
			Cooling	Heating	
Rated Capacity			5.0kW Class		
Front Panel Color			Almond White		
Air Flow Rates	m ³ /min (cfm)	H	11.4 (402)	12.1 (427)	
		M	10.0 (353)	9.8 (346)	
		L	8.5 (300)	7.5 (265)	
		SL	7.5 (265)	6.8 (240)	
Fan	Type	Sirocco Fan			
	Motor Output	W	34		
	Speed	Steps	5 Steps, Quiet, Auto		
Air Direction Control			Right, Left, Horizontal, Downward		
Air Filter			Removable-Washable-Mildew Proof		
Running Current (Rated)	A	0.45	0.45	0.45	
Power Consumption (Rated)	W	96	96	96	
Power Factor	%	92.8	92.8	92.8	
Temperature Control			Microcomputer Control		
Dimensions (HxWxD)	mm	490x1,050x200			
Packaged Dimensions (HxWxD)	mm	280x1,100x566			
Weight	kg	17			
Gross Weight	kg	24			
Operation Sound	H/M/L/SL	dBA	47/43/39/36	46/41/35/33	
Sound Power	H	dBA	63	32	
Heat Insulation			Both Liquid and Gas Pipes		
Piping Connection	Liquid	mm	φ 6.4		
	Gas	mm	φ12.7		
	Drain	mm	φ18.0		
Drawing No.			3D050897		

Conversion Formulae
kcal/h=kWx860
Btu/h=kWx3414
cfm=m ³ /minx35.3

Floor Standing Type

50Hz 230V

Model			FVXS25FV1B		FVXS35FV1B	
			Cooling	Heating	Cooling	Heating
Rated Capacity			2.5kW Class		3.5kW Class	
Front Panel Color			White		White	
Air Flow Rates	m ³ /min (cfm)	H	8.2 (290)	8.8 (311)	8.5 (300)	9.4 (332)
		M	6.5 (229)	6.9 (244)	6.7 (237)	7.3 (258)
		L	4.8 (169)	5.0 (178)	4.9 (174)	5.2 (184)
		SL	4.1 (146)	4.4 (155)	4.5 (158)	4.7 (168)
Fan	Type	Turbo Fan		Turbo Fan		
	Motor Output	W	48		48	
	Speed	Steps	5 Steps, Quiet, Auto		5 Steps, Quiet, Auto	
Air Direction Control			Right, Left, Horizontal, Downward		Right, Left, Horizontal, Downward	
Air Filter			Removable-Washable-Mildew Proof		Removable-Washable-Mildew Proof	
Running Current (Rated)	A	0.13	0.14	0.13	0.14	
Power Consumption (Rated)	W	15	17	15	17	
Power Factor	%	50.2	52.8	50.2	52.8	
Temperature Control			Microcomputer Control		Microcomputer Control	
Dimensions (HxWxD)	mm	600x700x210		600x700x210		
Packaged Dimensions (HxWxD)	mm	696x786x286		696x786x286		
Weight	kg	14		14		
Gross Weight	kg	18		18		
Operation Sound	H/M/L/SL	dBA	38/32/26/23	38/32/26/23	39/33/27/24	39/33/27/24
Sound Power	H	dBA	54	54	55	55
Heat Insulation			Both Liquid and Gas Pipes		Both Liquid and Gas Pipes	
Piping Connection	Liquid	mm	φ 6.4		φ 6.4	
	Gas	mm	φ 9.5		φ 9.5	
	Drain	mm	φ 20.0		φ 20.0	
Drawing No.			3D056274		3D056275	

Model			FVXS50FV1B	
			Cooling	Heating
Rated Capacity			5.0kW Class	
Front Panel Color			White	
Air Flow Rates	m ³ /min (cfm)	H	10.7 (378)	11.8 (417)
		M	9.2 (326)	10.1 (358)
		L	7.8 (274)	8.5 (300)
		SL	6.6 (233)	7.1 (250)
Fan	Type	Turbo Fan		
	Motor Output	W	48	
	Speed	Steps	5 Steps, Quiet, Auto	
Air Direction Control			Right, Left, Horizontal, Downward	
Air Filter			Removable-Washable-Mildew Proof	
Running Current (Rated)	A	0.17	0.19	
Power Consumption (Rated)	W	27	34	
Power Factor	%	69.1	77.8	
Temperature Control			Microcomputer Control	
Dimensions (HxWxD)	mm	600x700x210		
Packaged Dimensions (HxWxD)	mm	696x786x286		
Weight	kg	14		
Gross Weight	kg	18		
Operation Sound	H/M/L/SL	dBA	44/40/36/32	45/40/36/32
Sound Power	H	dBA	56	57
Heat Insulation			Both Liquid and Gas Pipes	
Piping Connection	Liquid	mm	φ 6.4	
	Gas	mm	φ 12.7	
	Drain	mm	φ 20.0	
Drawing No.			3D056276	

Conversion Formulae kcal/h=kWx860 Btu/h=kWx3414 cfm=m ³ /minx35.3

Ceiling Suspended Type

50Hz 230V

Model			FHQ35BVV1B		FHQ50BVV1B		
			Cooling	Heating	Cooling	Heating	
Rated Capacity			3.5kW Class		5.0kW Class		
Decoration Panel	Color	White				White	
	Dimensions (HxWxD)	—				—	
Air Flow Rates	m ³ /min (cfm)	H	13.0 (458)	13.0 (458)	13.0 (458)	13.0 (458)	
		M	—		—		
		L	10.0 (353)	10.0 (353)	10.0 (353)	10.0 (353)	
		SL	—		—		
Fan	Type	Sirocco Fan				Sirocco Fan	
	Motor Output	W	62		62		
	Speed	Steps	2 Steps		2 Steps		
Air Direction Control			Right, Left, Horizontal, Downward		Right, Left, Horizontal, Downward		
Air Filter			Removable-Washable-Mildew Proof		Removable-Washable-Mildew Proof		
Temperature Control			Microcomputer Control		Microcomputer Control		
Dimensions (HxWxD)		mm	195x960x680		195x960x680		
Packaged Dimensions (HxWxD)		mm	279x1,046x818		279x1,046x818		
Weight		kg	24		25		
Gross Weight		kg	31		32		
Operation Sound	H/L	dBA	37/32		38/33		
Sound Power	H/L	dBA	53/48		54/49		
Heat Insulation			Both Liquid and Gas Pipes		Both Liquid and Gas Pipes		
Piping Connection	Liquid	mm	φ 6.4 (Flare)		φ 6.4 (Flare)		
	Gas	mm	φ 9.5 (Flare)		φ 12.7 (Flare)		
	Drain	mm	VP20 (O.D.φ 26 / I.D.φ 20)		VP20 (O.D.φ 26 / I.D.φ 20)		
Drawing No.			3D037992E		3D037992E		

Conversion Formulae
kcal/h=kWx860
Btu/h=kWx3414
cfm=m ³ /minx35.3

1.4 Outdoor Units - Heat Pump

50Hz 230V

Model			3MXS52E3V1B	
			Cooling	Heating
Cooling Capacity	kW	—		
Power Consumption	W	—		
Running Current	A	—		
Casing Color	Ivory White			
Compressor	Type	Hermetically Sealed Swing Type		
	Model	2YC36BXD		
Refrigerant Oil	Motor Output	W	1,100	
	Model	FVC50K		
Refrigerant	Charge	L	0.65	
	Type	R-410A		
Air Flow Rates	m ³ /min	H	45	45
		L	45	41
	cfm	H	1,589	1,589
		L	1,589	1,448
Fan	Type	Propeller		
	Motor Output	W	53	
	Running Current	A	H: 0.33 / L: 0.29	
	Power Consumption	W	H: 43 / L: 34	
Starting Current	A	6.2		
Dimensions (HxWxD)	mm	735x936x300		
Packaged Dimensions (HxWxD)	mm	797x992x390		
Weight	kg	49		
Gross Weight	kg	56		
Operation Sound	dBA	46	47	
Sound Power	dBA	59	60	
Piping Connection	Liquid	mm	φ 6.4x3	
	Gas	mm	φ 9.5x2, φ12.7x1	
	Drain	mm	φ18.0	
Heat Insulation	Both Liquid and Gas Pipes			
No. of Wiring Connection	3 for Power Supply, 4 for Interunit Wiring			
Max. Interunit Piping Length	m	50 (for Total of Each Room)		
	m	25 (for One Room)		
Amount of Additional Charge	g/m	20 (30m or more)		
Max. Installation Height Difference	m	15 (between Indoor Unit and Outdoor Unit)		
	m	7.5 (between Indoor Units)		
Drawing No.	3D052265#1			

Note: The data are based on the conditions shown in the table below.

Cooling	Heating	Piping Length
Indoor : 27°CDB/19°CWB Outdoor : 35°CDB	Indoor : 20°CDB Outdoor : 7°CDB/6°CWB	7.5m

Conversion Formulae
kcal/h=kWx860 Btu/h=kWx3414 cfm=m ³ /minx35.3

Part 3

Printed Circuit Board

Connector Wiring Diagram

- 1. Printed Circuit Board Connector Wiring Diagram.....36
 - 1.1 Wall Mounted Type36
 - 1.2 Duct Connected Type.....45
 - 1.3 Floor / Ceiling Suspended Dual Type.....47
 - 1.4 Floor Standing Type50
 - 1.5 Ceiling Suspended Type52
 - 1.6 Outdoor Units54

1. Printed Circuit Board Connector Wiring Diagram

1.1 Wall Mounted Type

1.1.1 FTK(X)S20~50D

Connectors

PCB(1) (Control PCB)

- 1) **S1** Connector for DC fan motor
- 2) **S6** Connector for swing motor (horizontal blades)
- 3) **S21** Connector for [centralized control \(HA\)](#)
- 4) **S26** Connector for display PCB
- 5) **S28** Connector for signal receiver PCB
- 6) **S32** Connector for heat exchanger thermistor
- 7) **S35** Connector for INTELLIGENT EYE sensor PCB

PCB(2) (Signal Receiver PCB)

- 1) **S29** Connector for control PCB

PCB(3) (Display PCB)

- 1) **S27** Connector for control PCB

PCB(4) (INTELLIGENT EYE sensor PCB)

- 1) **S36** Connector for control PCB



Note:

Other designations

PCB(1) (Control PCB)

- 1) **V1** [Varistor](#)
 - 2) **JA** [Address setting jumper](#)
 - JB** [Fan speed setting](#) when compressor is OFF on thermostat
 - JC** [Power failure recovery function \(auto-restart\)](#)
- * Refer to page 317 for detail.
- 3) **LED A** LED for service monitor (green)
 - 4) **FU1** [Fuse \(3.15A\)](#)

PCB(3) (Display PCB)

- 1) **SW1 (S1W)** [Forced operation ON / OFF switch](#)
- 2) **LED1** LED for operation (green)
- 3) **LED2** LED for timer (yellow)
- 4) **LED3** LED for INTELLIGENT EYE (green)
- 5) **RTH1 (R1T)** Room temperature thermistor

PCB Detail

PCB(1): Control PCB

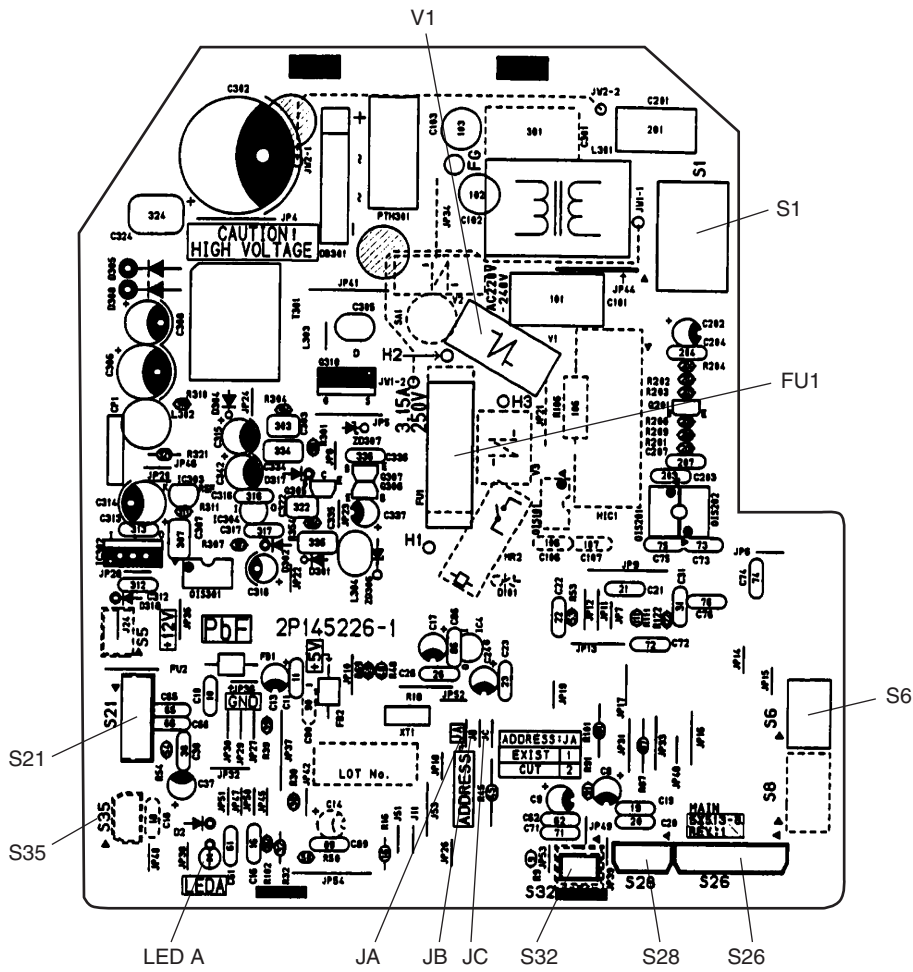

(R4288)

PCB(2): Signal Receiver PCB

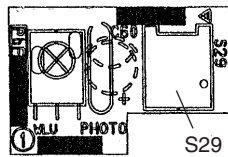

(R5183)

PCB(3): Display PCB

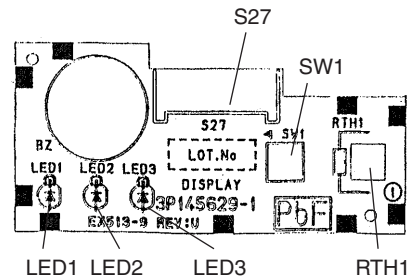

(R4290)

PCB(4): INTELLIGENT EYE sensor PCB

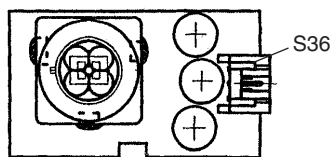

(R4291)

1.1.2 FTK(X)S20~35C

Connectors

PCB(1) (Control PCB)

PCB(2) (Signal Receiver PCB)

- | | |
|--------|--|
| 1) S1 | Connector for fan motor |
| 2) S6 | Connector for swing motor (Horizontal Flap) |
| 3) S7 | Connector for fan motor |
| 4) S21 | Connector for centralized control to 5 rooms |
| 5) S26 | Connector for signal receiver PCB |
| 6) S27 | Connector for control PCB |
| 7) S32 | Connector for heat exchanger thermistor |
| 8) S35 | Connector for INTELLIGENT EYE Sensor PCB |

PCB(3) (INTELLIGENT EYE sensor PCB)

- | | |
|--------|---------------------------|
| 1) S36 | Connector for control PCB |
|--------|---------------------------|



Note:

Other designations

PCB(1) (Control PCB)

PCB(2) (Signal Receiver PCB)

- | | |
|----------|--|
| 1) V1 | Varistor |
| 2) JA | Address setting jumper |
| JB | Fan speed setting when compressor is OFF on thermostat |
| JC | Power failure recovery function |
| | * Refer to page 317 for more detail. |
| 3) SW7 | Forced operation ON/OFF switch |
| 4) LED1 | LED for operation (green) |
| 5) LED2 | LED for timer (yellow) |
| 6) LED3 | LED for HOME LEAVE operation (red) |
| 7) LED A | LED for service monitor (green) |
| 8) FU1 | Fuse (3.15A) |
| 9) RTH1 | Room temperature thermistor |

PCB

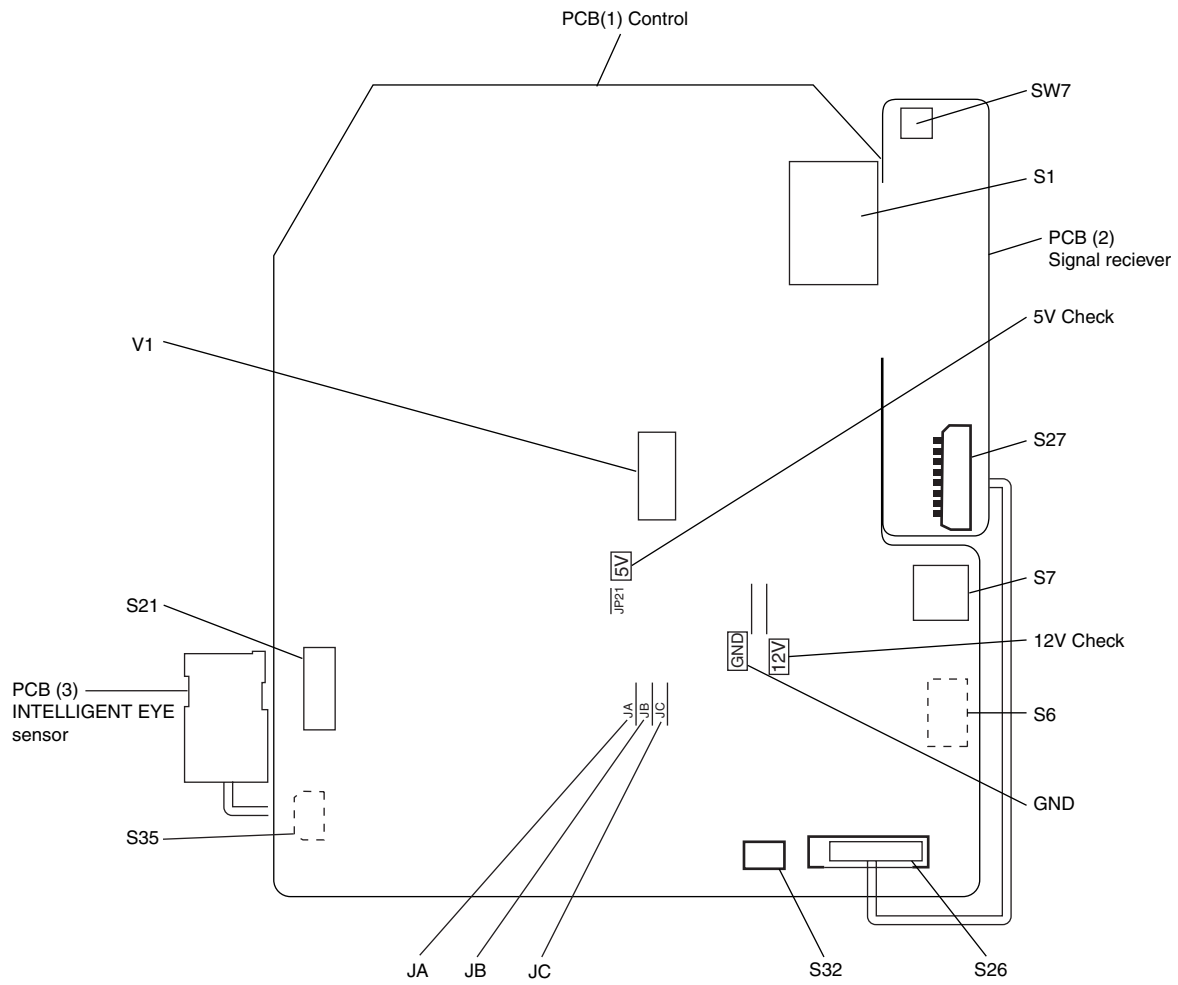

(R2413)

PCB Detail

PCB(1): Control PCB
 PCB(2): Signal Receiver PCB

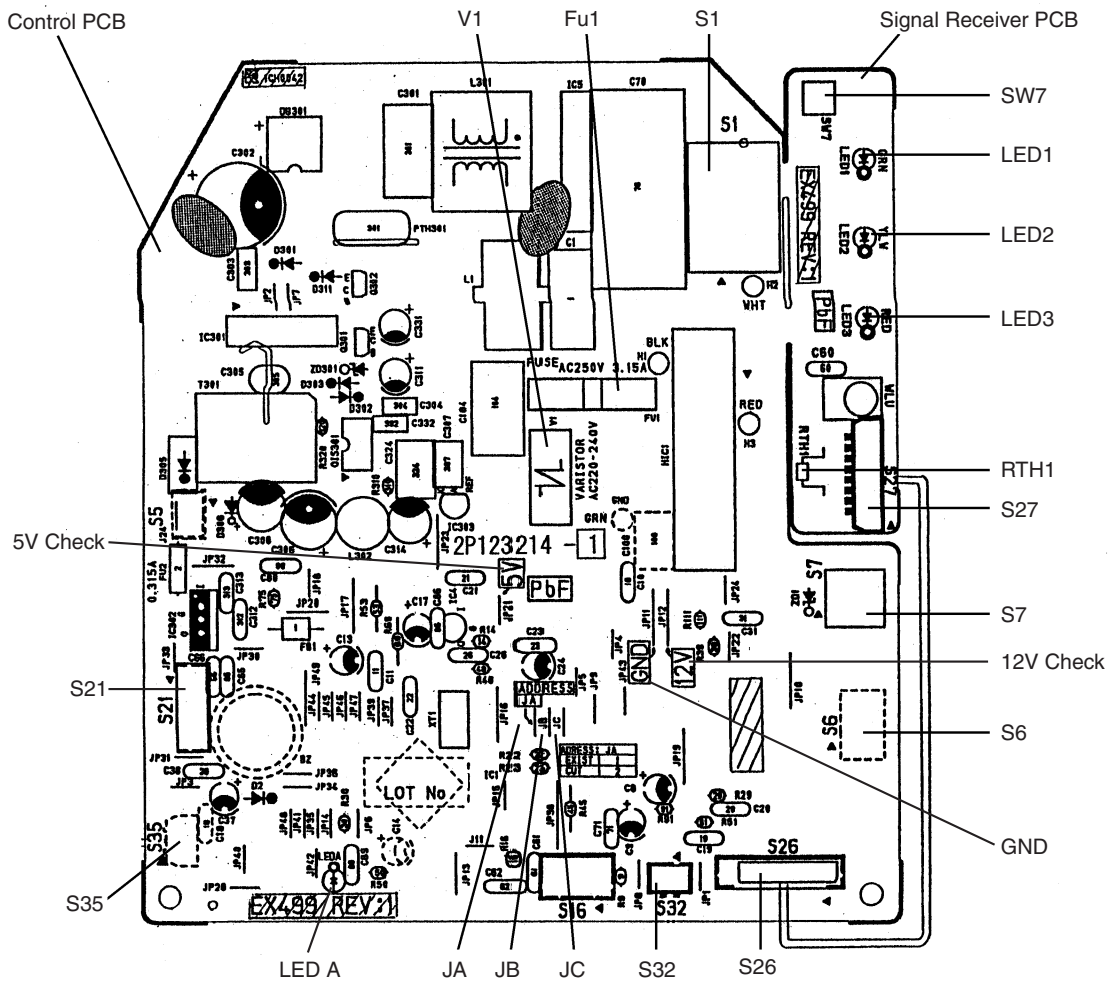

(R4987)

PCB(3): INTELLIGENT EYE sensor PCB

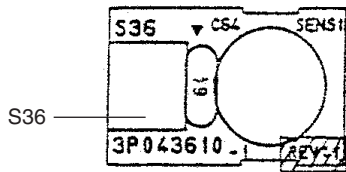

(R4988)

1.1.3 FTK(X)S50F

Connectors

PCB(1) (Control PCB)

- 1) [S1](#) Connector for DC fan motor
- 2) [S6](#) Connector for swing motor (horizontal blades)
- 3) [S8](#) Connector for swing motor (vertical blades)
- 4) [S21](#) Connector for [centralized control \(HA\)](#)
- 5) [S26](#) Connector for buzzer PCB
- 6) [S28](#) Connector for signal receiver PCB
- 7) [S32](#) Connector for heat exchanger thermistor
- 8) [S35](#) Connector for Intelligent Eye sensor PCB

PCB(2) (Signal Receiver PCB)

- 1) [S29](#) Connector for control PCB

PCB(3) (Buzzer PCB)

- 1) [S27](#) Connector for control PCB
- 2) [S38](#) Connector for display PCB

PCB(4) (Display PCB)

- 1) [S37](#) Connector for buzzer PCB

PCB(5) (INTELLIGENT EYE sensor PCB)

- 1) [S36](#) Connector for control PCB



Note:

Other designations

PCB(1) (Control PCB)

- 1) [V1](#) [Varistor](#)
- 2) [JA](#) [Address setting jumper](#)
- [JB](#) [Fan speed setting](#) when compressor is OFF on thermostat
- [JC](#) [Power failure recovery function](#)
- * Refer to page 317 for detail.
- 3) [LED A](#) LED A for service monitor (green)
- 4) [FU1](#) [Fuse \(3.15A\)](#)

PCB(2) (Signal Receiver PCB)

- 1) [SW1 \(S1W\)](#) [Forced operation ON/OFF switch](#)

PCB(3) (Buzzer PCB)

- 1) [RTH1 \(R1T\)](#) Room temperature thermistor

PCB(4) (Display PCB)

- 4) [LED1](#) LED for operation (green)
- 5) [LED2](#) LED for timer (yellow)
- 6) [LED3](#) LED for HOME LEAVE operation (red)

PCB Detail

PCB(1): Control PCB (indoor unit)

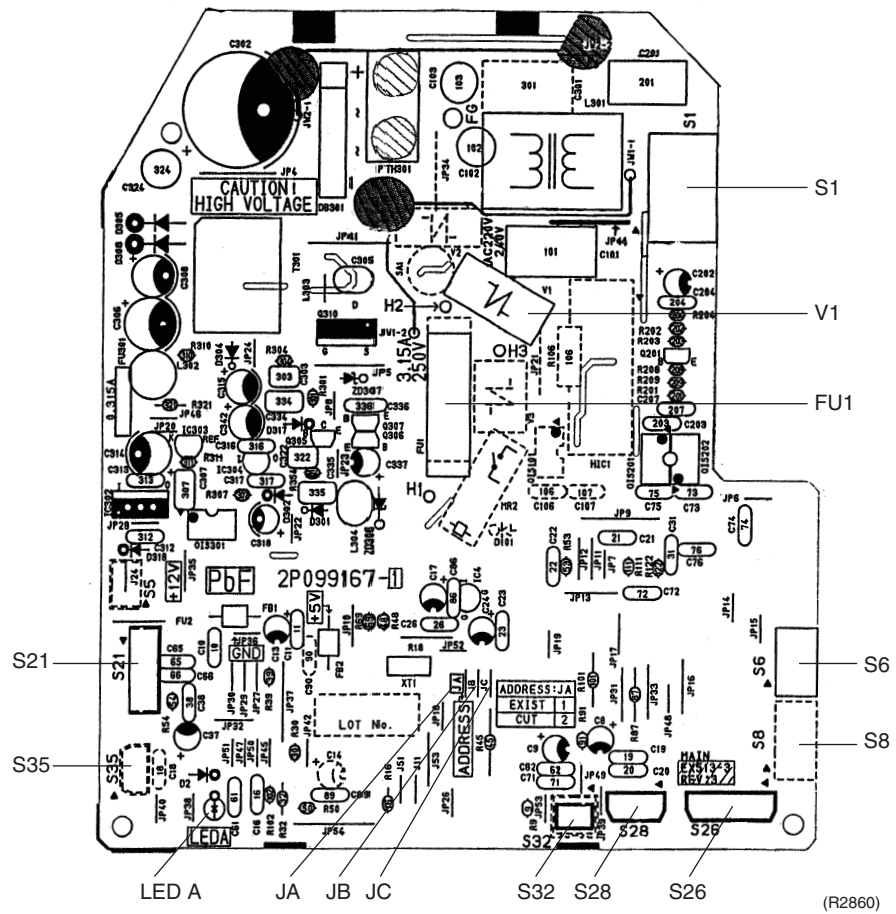

PCB(2): Signal Receiver PCB

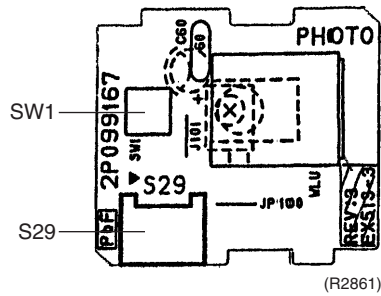

PCB(3): Buzzer PCB

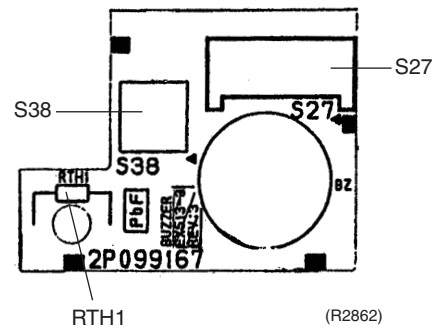

PCB(4): Display PCB

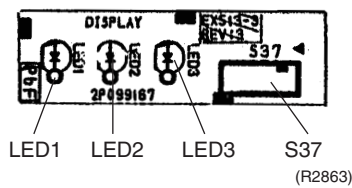

PCB(5): INTELLIGENT EYE sensor PCB

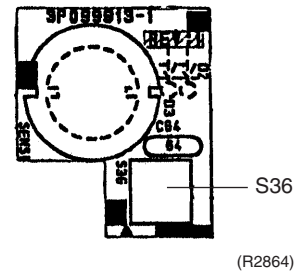

1.1.4 FTXG25~35E, CTXG50E

Connectors

PCB(1) (Control PCB)

- 1) **S1** Connector for fan motor
- 2) **S21** Connector for [centralized control \(HA\)](#)
- 3) **S32** Connector for heat exchanger thermistor
- 4) **S36** Connector for INTELLIGENT EYE sensor PCB and control PCB
- 5) **S41** Connector for swing motor
- 6) **S46** Connector for signal receiver PCB
- 7) **S49** Connector for reduction motor (front panel mechanism)
- 8) **S51** Connector for front panel limit switch

PCB(2) (Signal Receiver PCB)

- 1) **S47** Connector for control PCB

PCB(3) (INTELLIGENT EYE sensor PCB)

- 1) **S36** Connector for control PCB



Note:

Other designations

PCB(1) (Control PCB)

- 1) **V1** [Varistor](#)
- 2) **JA** [Address setting jumper](#)
- JB** [Fan speed setting](#) when compressor is OFF on thermostat
- JC** [Power failure recovery function \(auto-restart\)](#)
- * Refer to page 317 for detail.
- 3) **FU1** [Fuse](#) (3.15A)
- 4) **LED A** LED for service monitor (green)

PCB(2) (Signal Receiver PCB)

- 1) **SW1** [Forced operation ON / OFF switch](#)
- 2) **LED2** LED for INTELLIGENT EYE (green)
- 3) **LED3** LED for timer (yellow)
- 4) **LED4** LED for operation (green)
- 5) **RTH1** Room temperature thermistor

PCB Detail

PCB(1): Control PCB (indoor unit)

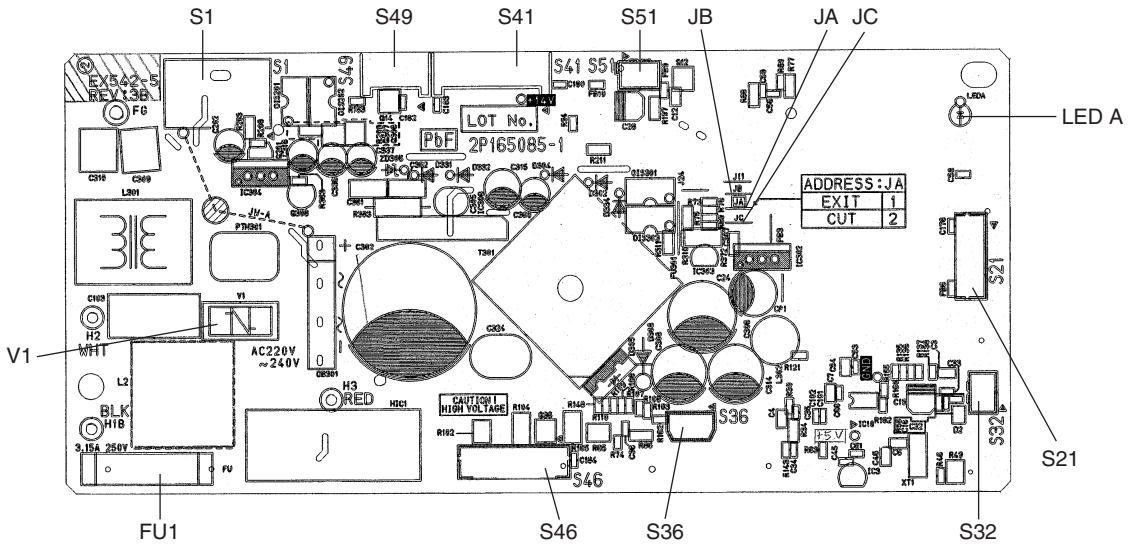

(R4991)

PCB(2): Signal Receiver PCB

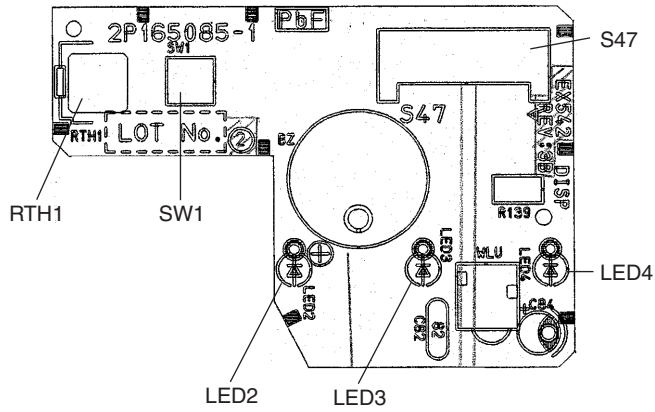

(R4992)

PCB(3): INTELLIGENT EYE sensor PCB

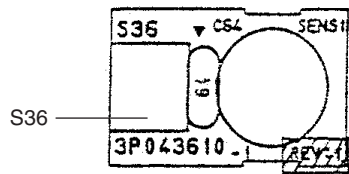

(R4988)

1.2 Duct Connected Type

Connectors

PCB(1) (Control PCB)

- 1) **S1** Connector for AC fan motor
- 2) **S7** Connector for AC fan motor
- 3) **S21** Connector for centralized control to 5 rooms
- 4) **S26** Connector for display PCB
- 5) **S32** Connector for heat exchanger thermistor

PCB(2) (Display PCB)

- 1) **S1** Connector for control PCB



Note: Other designations

PCB(1) (Control PCB)

- 1) **V1** Varistor
 - 2) **JA** Address setting jumper
 - JB** Fan speed setting when compressor is OFF on thermostat
 - JC** Power failure recovery function
- * Refer to page 317 for more detail.
- 3) **LED A** LED for service monitor (green)
 - 4) **FU1** Fuse (3.15A)

PCB(2) (Display PCB)

- 1) **SW1 (S1W)** Forced operation ON/OFF switch
- 2) **LED1** LED for operation (green)
- 3) **LED2** LED for timer (yellow)
- 4) **LED3** LED for HOME LEAVE operation (red)
- 5) **RTH1 (R1T)** Room temperature thermistor

PCB Detail

PCB (1): Control PCB

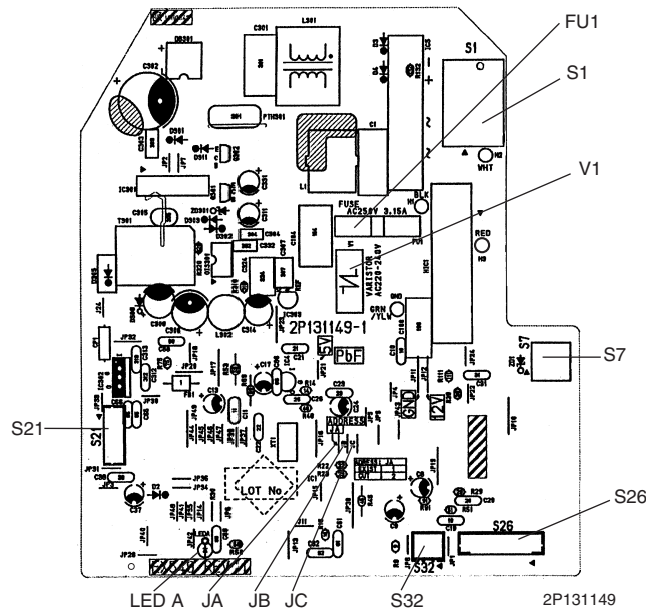

PCB Detail

PCB (2): Display PCB

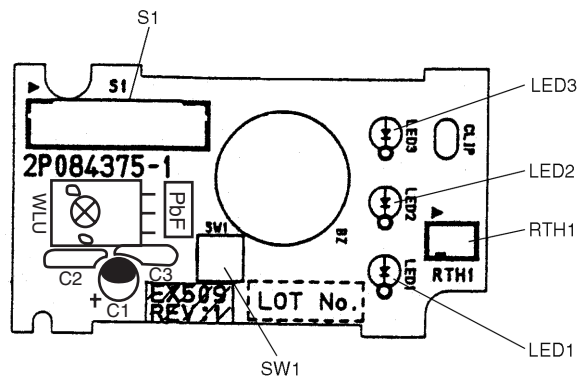

2P084375

1.3 Floor / Ceiling Suspended Dual Type

Connectors

PCB(1) (Control PCB)

- 1) [S6](#) Connector for swing motor (horizontal swing)
- 2) [S7](#) Connector for AC fan motor
- 3) [S21](#) Connector for [centralized control](#)
- 4) [S24](#) Connector for display PCB
- 5) [S26](#) Connector for signal receiver PCB
- 6) [S32](#) Connector for heat exchanger thermistor
- 7) [S37](#) Connector for power supply PCB

PCB(2) (Power Supply PCB)

- 1) [S36](#) Connector for control PCB

PCB(3) (Display PCB)

- 1) [S25](#) Connector for control PCB

PCB(4) (Signal Receiver PCB)

- 1) [S27](#) Connector for control PCB
- 2) [S31](#) Connector for room temperature thermistor



Note:

Other designations

PCB(1) (Control PCB)

- 1) [JA](#) [Address setting jumper](#)
- [JB](#) [Fan speed setting](#) when compressor is OFF on thermostat
- [JC](#) [Power failure recovery function](#)
* Refer to page 317 for detail.
- 2) [SW2](#) Select switch ceiling or floor
- 3) [LED A](#) LED for service monitor (green)

PCB(2) (Power Supply PCB)

- 1) [V1](#) [Varistor](#)
- 1) [FU1](#) [Fuse \(3.15A\)](#)

PCB(3) (Display PCB)

- 1) [LED1](#) LED for operation (green)
- 2) [LED2](#) LED for timer (yellow)
- 3) [LED3](#) LED for HOME LEAVE operation (red)

PCB(4) (Signal Receiver PCB)

- 1) [SW1 \(S1W\)](#) [Forced operation ON/OFF switch](#)

PCB Detail

PCB (1): Control PCB

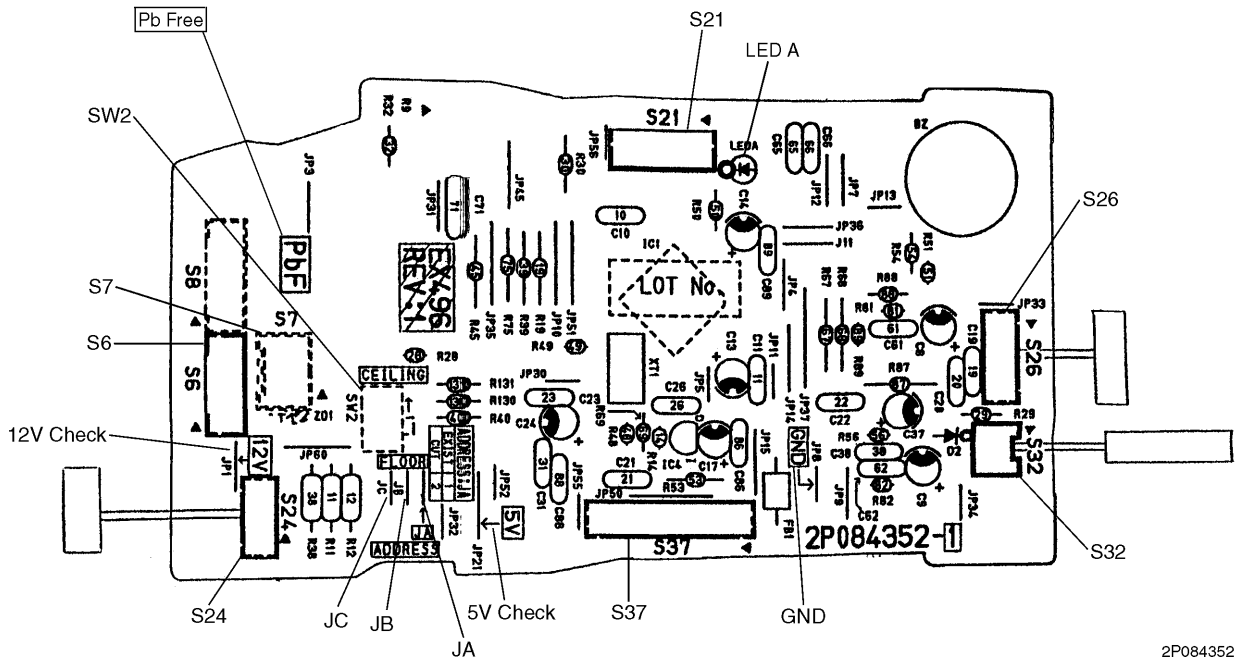

2P084352

PCB Detail

PCB (2): Power Supply PCB

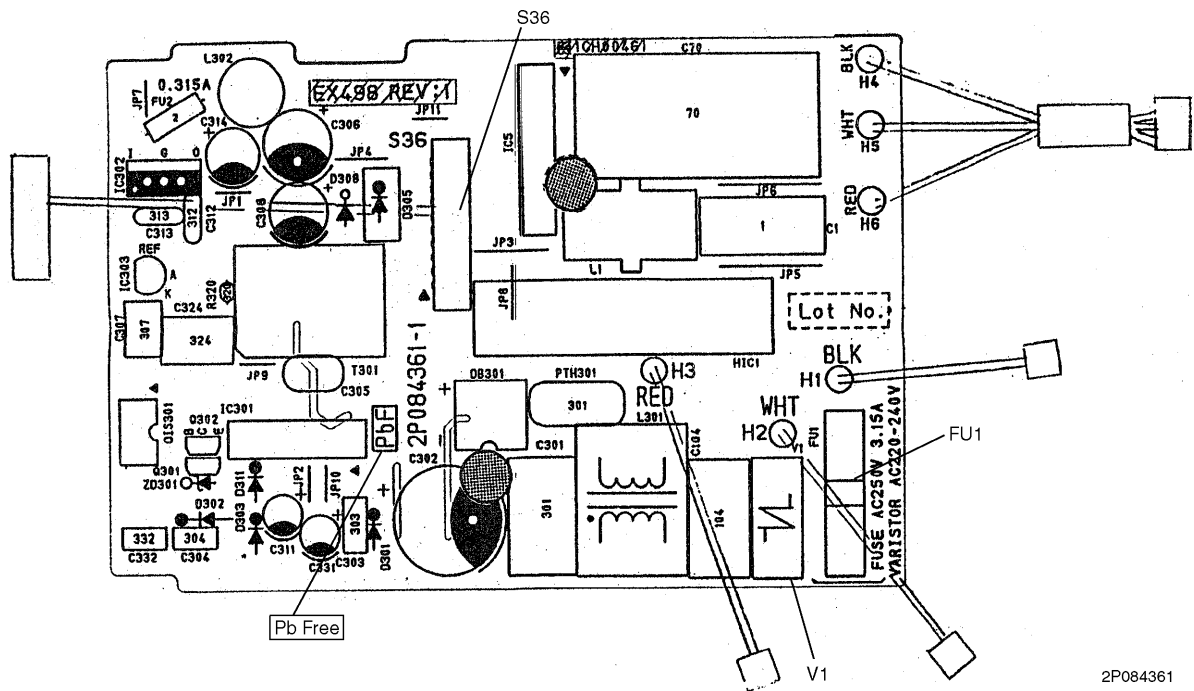

2P084361

PCB (3): Display PCB

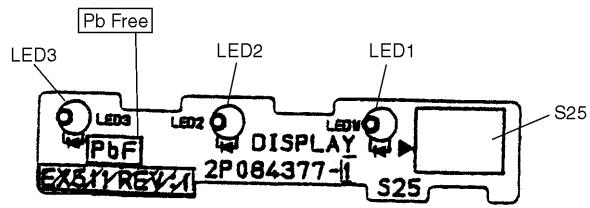

2P084377

PCB (4): Signal Receiver PCB

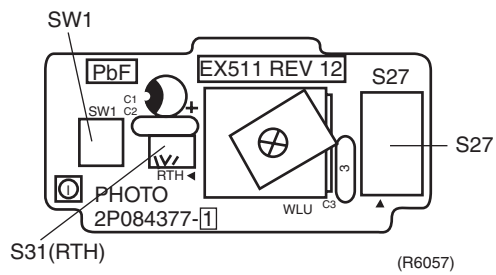

1.4 Floor Standing Type

Connectors

PCB(1) (Sensor PCB)

- 1) **S49** Connector for control PCB

PCB(2) (Control PCB)

- 1) **S1** Connector for fan motor
 2) **S21** Connector for centralized control
 3) **S26** Connector for service PCB
 4) **S41** Connector for lower air outlet motor
 5) **S42** Connector for swing motor
 6) **S46** Connector for display PCB
 7) **S48** Connector for sensor PCB

PCB(3) (Service PCB)

- 1) **S27** Connector for control PCB

PCB(4) (Display PCB)

- 1) **S47** Connector for control PCB



Note:

Other Designations

PCB(2) (Control PCB)

- 1) **V1** Varistor
 2) **JA** Address setting jumper
JB Fan speed setting when compressor is OFF on thermostat
JC Power failure recovery function
 * Refer to page 317 for detail.
 3) **FU1** Fuse (3.15A)
 4) **LED A** LED for service monitor (green)

PCB(3) (Service PCB)

- 1) **SW2** Changing upward air flow limit switch
 2) **SW4** Discharge changeover switch

PCB(4) (Display PCB)

- 1) **SW1 (S1W)** Forced operation ON/OFF switch
 2) **LED1** LED for operation (green)
 3) **LED2** LED for timer (yellow)

PCB Detail

PCB(1): Sensor PCB

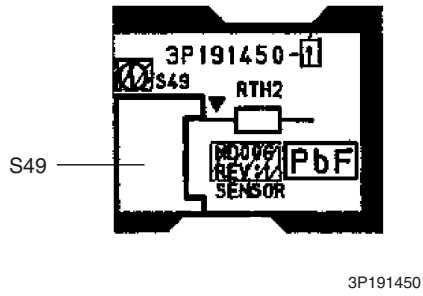

PCB(2): Control PCB

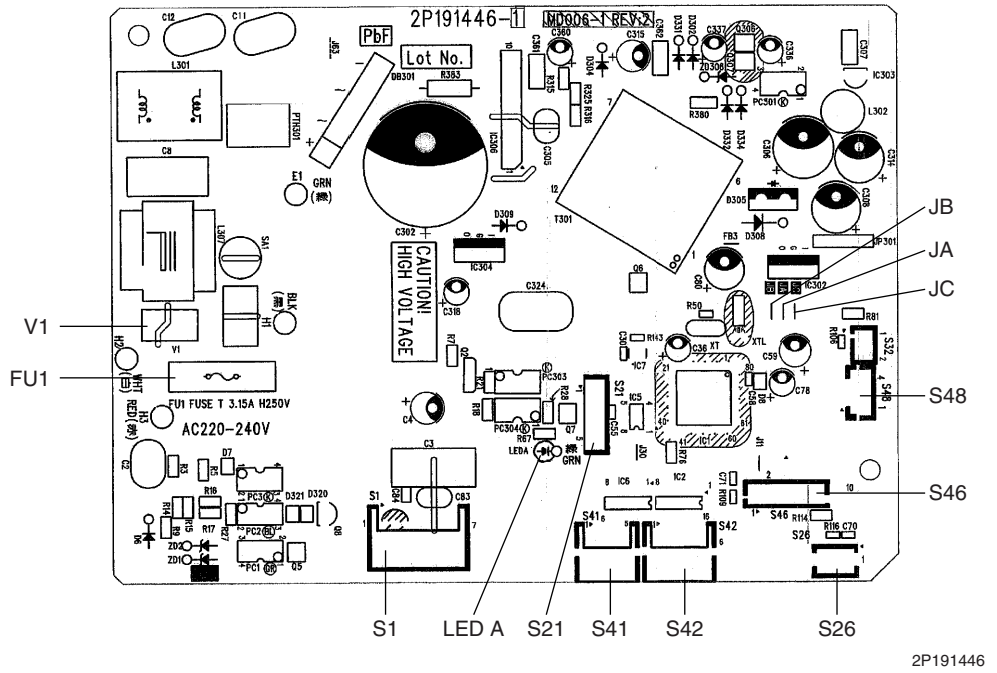

PCB(3): Service PCB

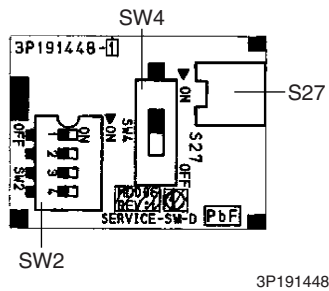

PCB(3): Display PCB

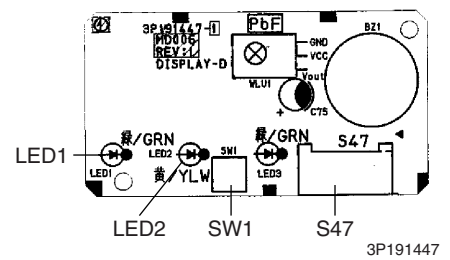

1.5 Ceiling Suspended Type

Connectors

- | | | |
|-----|------------|--|
| 1) | X5A | Connector for Terminal Strip (for Wired Remote Controller) |
| 2) | X14A | Connector for Limit Switch (for Swing Flap) |
| 3) | X15A | Connector for Drain Pump (Optional Accessory) |
| 4) | X17A | Connector for Heat Exchanger Thermistor (2) |
| 5) | X18A | Connector for Heat Exchanger Thermistor (1) |
| 6) | X19A | Connector for Room Temperature Thermistor |
| 7) | X20A, X26A | Connector for Fan Motor |
| 8) | X24A | Connector for Wireless Remote Controller Receiver Unit |
| 9) | X25A | Connector for Drain Pump Motor (Optional Accessory) |
| 10) | X27A | Connector for Terminal Strip (for Inter Unit Wiring) |
| 11) | X29A | Connector for Swing Motor |
| 12) | X33A | Connector for Wiring Adaptor PCB (Optional Accessory) |
| 13) | X35A | Connector for Group Control Adaptor (Optional Accessory) |
| 14) | X40A | Connector for ON/OFF Input from Outside (for Optional Accessory) |
| 15) | X60A, X61A | Connector for Interface Adaptor (Optional Accessory) |



Note: Other Designation

- | | | |
|----|-----|---------------------|
| 1) | HAP | Service Monitor LED |
|----|-----|---------------------|

PCB Detail

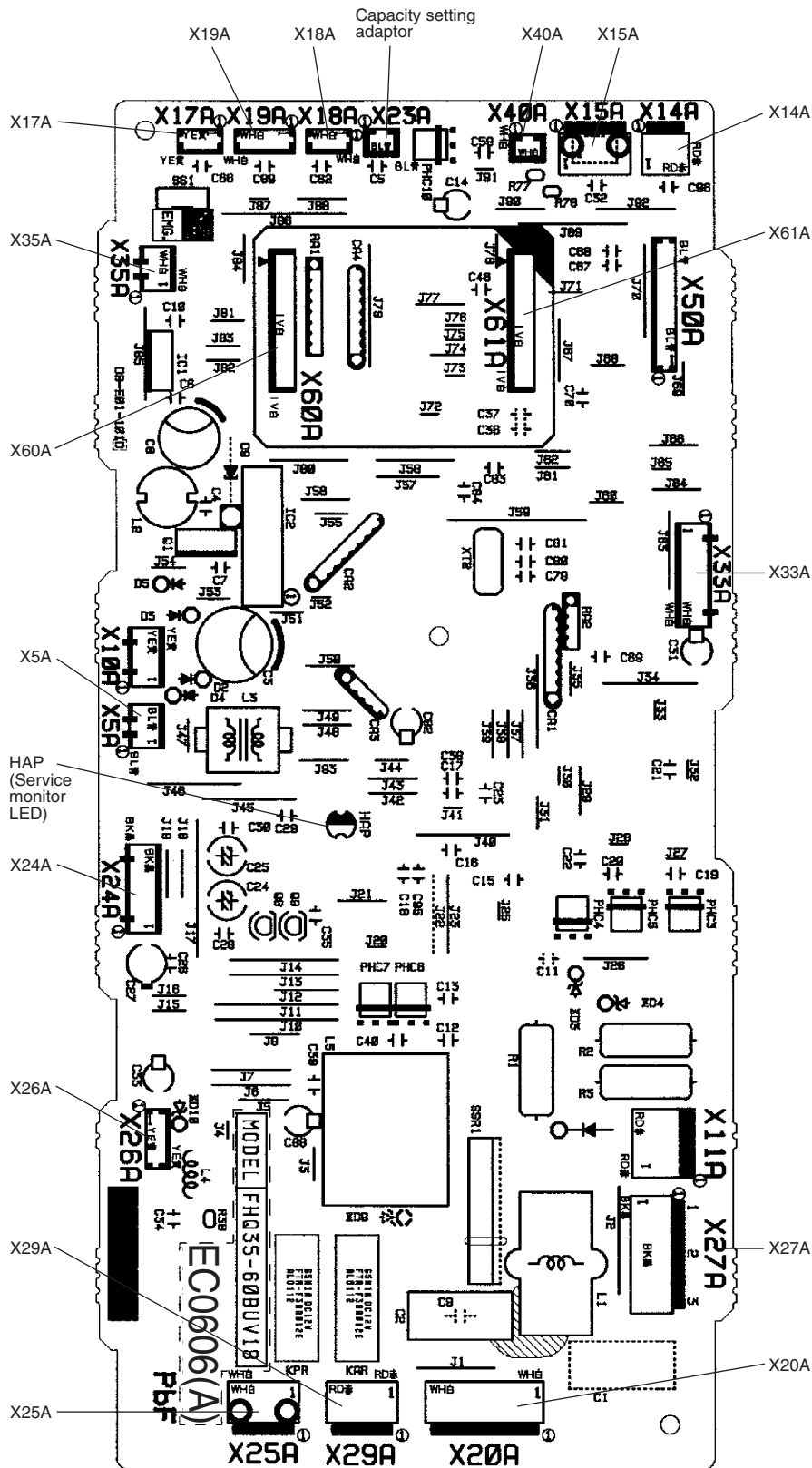

2P095007

1.6 Outdoor Units

Connectors

PCB(1)(Main PCB)

- | | |
|--------------|--|
| 1) S10 | Connector for terminal strip (indoor-outdoor transmission) |
| 2) S15 | Connector for COOL / HEAT mode lock |
| 3) S20 | Connector for electronic expansion valve coil A port (white) |
| 4) S21 | Connector for electronic expansion valve coil B port (red) |
| 5) S22 | Connector for electronic expansion valve coil C port (blue) |
| 6) S23 | Connector for electronic expansion valve coil D port (yellow) |
| 7) S40 | Connector for overload protector |
| 8) S51, S101 | Connector for service monitor PCB |
| 9) S70 | Connector for fan motor |
| 10) S80 | Connector for four way valve coil |
| 11) S90 | Connector for thermistors
(outdoor air, heat exchanger, and discharge pipe) |
| 12) S92 | Connector for gas pipe thermistor |
| 13) S93 | Connector for liquid pipe thermistor |
| 14) AC1, AC2 | Connector for terminal strip (power supply) |
| 15) HR1, HR2 | Connector for reactor |

PCB(2)(Service Monitor PCB)

- | | |
|--------------|---------------------------|
| 1) S52, S102 | Connector for control PCB |
|--------------|---------------------------|



Note:

Other Designations

PCB(1)(Main PCB)

- | | |
|---------------------------|--------------|
| 1) FU1 | Fuse (30A) |
| 2) FU2, FU3 | Fuse (3.15A) |
| 3) V2, V3, V5
V9, V100 | Varistor |

PCB(2)(Service Monitor PCB)

- | | |
|----------------|---------------------------------|
| 1) LED A | Service monitor LED (green) |
| 2) LED1 - LED4 | Service monitor LED (red) |
| 3) SW1 | Forced operation ON/OFF switch |
| 4) SW2 | Operation mode switch |
| 5) SW3 | Wiring error check switch |
| 6) SW4 | Priority room setting switch |
| 7) SW5 | Night quiet mode setting switch |

PCB Detail

PCB(1): Main PCB

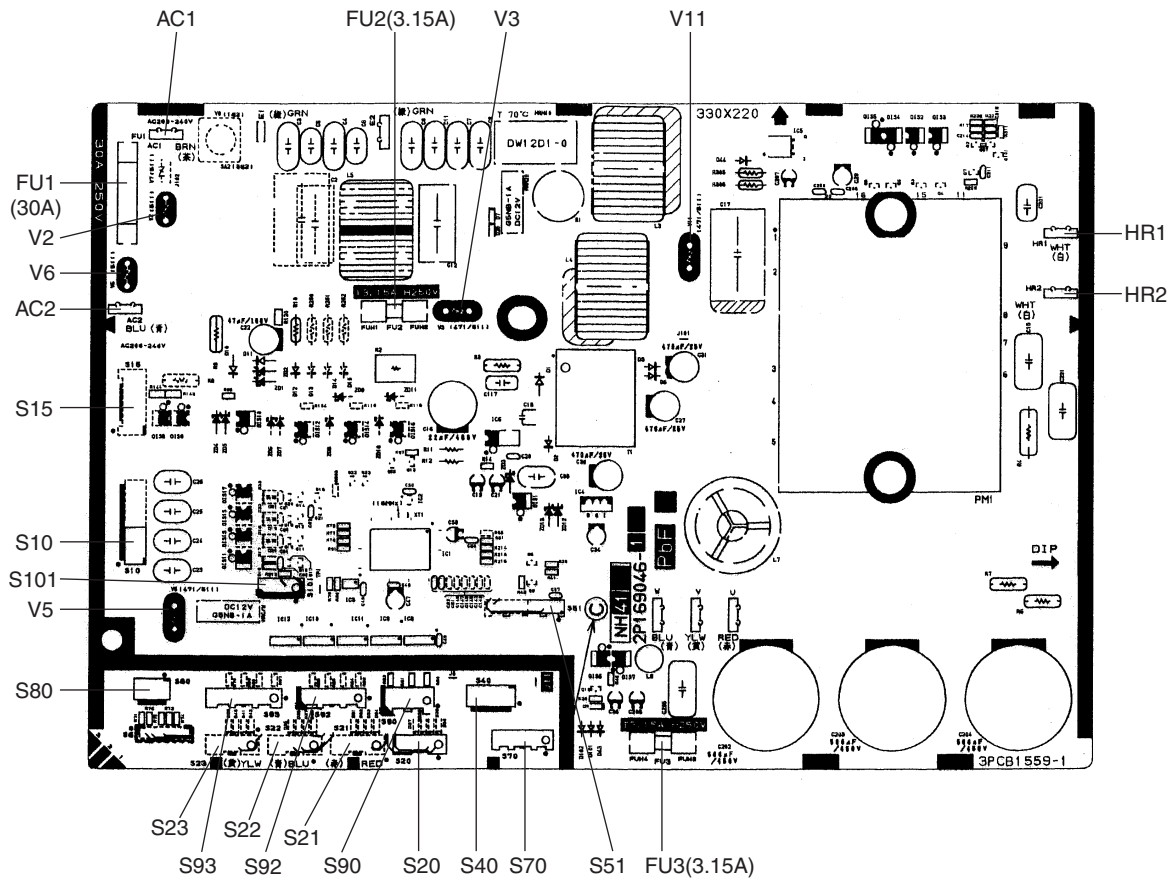

(R6041)

PCB(2): Service Monitor PCB

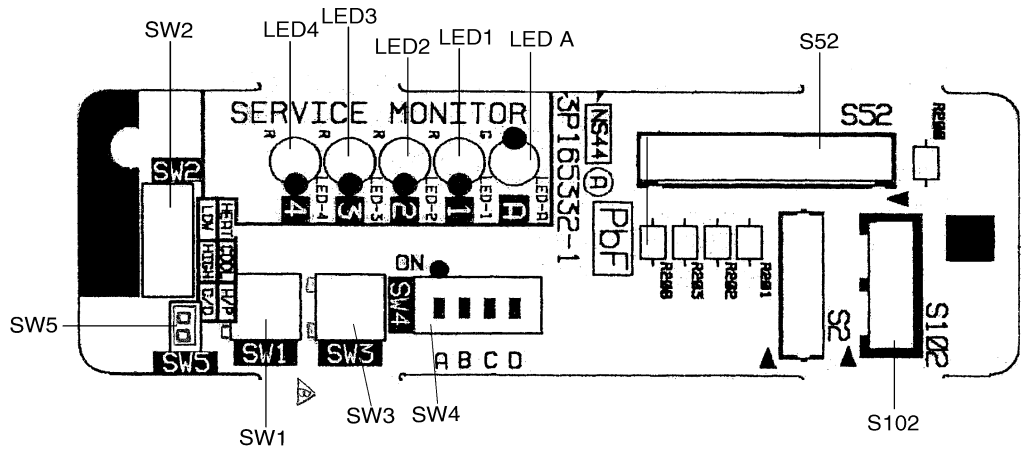

3P165332

Part 4

Function and Control

1. Main Functions.....	58
1.1 Frequency Principle.....	58
1.2 Power-Airflow Dual Flaps, Wide Angle Louvers and Auto-Swing	60
1.3 Operation Starting Control.....	62
1.4 Fan Speed Control for Indoor Units.....	63
1.5 Programme Dry Function	64
1.6 Automatic Operation.....	65
1.7 Thermostat Control.....	66
1.8 Night Set Mode.....	67
1.9 ECONO Mode	68
1.10 INTELLIGENT EYE (Wall Mounted Type only)	69
1.11 HOME LEAVE Operation	71
1.12 Inverter POWERFUL Operation	72
1.13 Other Functions.....	73
2. Function of Main Structural Parts.....	75
2.1 Main Structural Parts.....	75
2.2 Function of Thermistor	76
3. Control Specification	80
3.1 Mode Hierarchy.....	80
3.2 Frequency Control.....	81
3.3 Controls at Mode Changing / Start-up.....	84
3.4 Discharge Pipe Temperature Control.....	86
3.5 Input Current Control.....	86
3.6 Freeze-up Protection Control	87
3.7 Heating Peak-cut Control	87
3.8 Fan Control.....	88
3.9 Liquid Compression Protection Function 2.....	88
3.10 Defrost Control	89
3.11 Electronic Expansion Valve Control	90
3.12 Malfunctions	94
3.13 Forced Operation Mode	95
3.14 Wiring-Error Check.....	96
3.15 Additional Function.....	98

1. Main Functions

i Note: See the list of functions for the functions applicable to different models.

1.1 Frequency Principle

Main Control Parameters

The compressor is frequency-controlled during normal operation. The target frequency is set by the following 2 parameters coming from the operating indoor unit:

- The load condition of the operating indoor unit
- The difference between the room temperature and the set temperature

Additional Control Parameters

The target frequency is adapted by additional parameters in the following cases:

- Frequency restrictions
- Initial settings
- Forced cooling / heating operation

Inverter Principle

To regulate the capacity, a frequency control is needed. The inverter makes it possible to vary the rotation speed of the compressor. The following table explains the conversion principle:

Phase	Description
1	The supplied AC power source is converted into the DC power source for the present.
2	The DC power source is reconverted into the three phase AC power source with variable frequency. <ul style="list-style-type: none"> ■ When the frequency increases, the rotation speed of the compressor increases resulting in an increased refrigerant circulation. This leads to a higher amount of the heat exchange per unit. ■ When the frequency decreases, the rotation speed of the compressor decreases resulting in a decreased refrigerant circulation. This leads to a lower amount of the heat exchange per unit.

Drawing of Inverter

The following drawing shows a schematic view of the inverter principle:

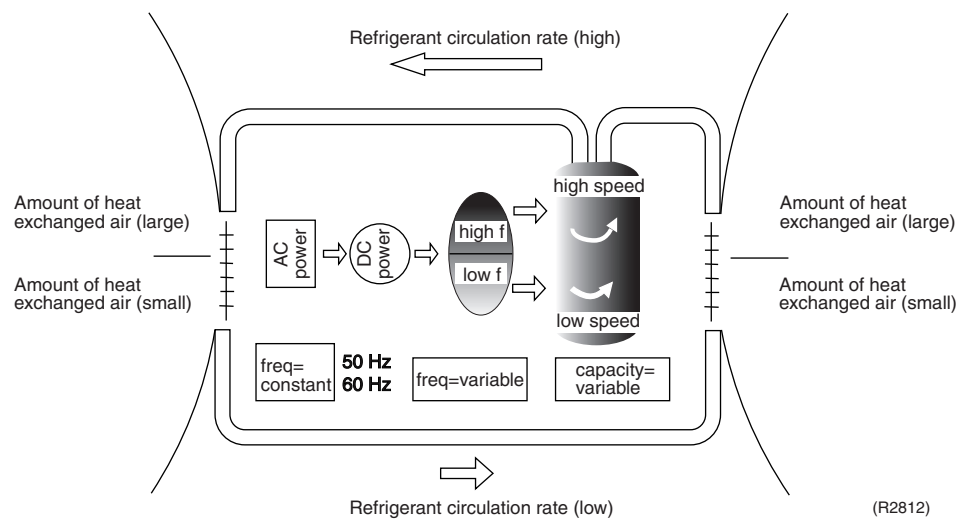

Inverter Features

The inverter provides the following features:

- The regulating capacity can be changed according to the changes in the outdoor air temperature and cooling / heating load.
- Quick heating and quick cooling
The compressor rotational speed is increased when starting the heating (or cooling). This enables a quick set temperature.

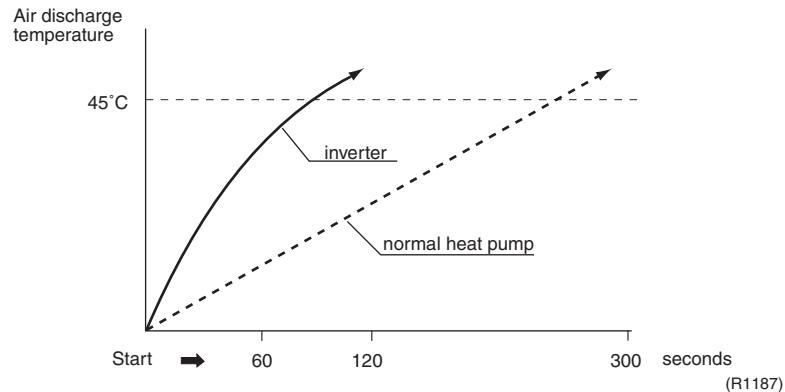

- Even during extreme cold weather, the high capacity is achieved. It is maintained even when the outdoor air temperature is 2°C.
- Comfortable air conditioning
A detailed adjustment is integrated to ensure a fixed room temperature. It is possible to air condition with a small room temperature variation.
- Energy saving heating and cooling
Once the set temperature is reached, the energy saving operation enables to maintain the room temperature at low power.

Frequency Limits

The following table shows the functions that define the minimum and maximum frequency:

Frequency limits	Limited during the activation of following functions
Low	<ul style="list-style-type: none"> ■ Four way valve operation compensation. Refer to page 84.
High	<ul style="list-style-type: none"> ■ Input current control. Refer to page 86. ■ Compressor protection function. Refer to page 85. ■ Heating Peak-cut control. Refer to page 87. ■ Freeze-up protection. Refer to page 87. ■ Defrost control. Refer to page 89.

Forced Cooling / Heating Operation

For more information, refer to "Forced operation mode" on page 95.

1.2 Power-Airflow Dual Flaps, Wide Angle Louvers and Auto-Swing

Power-airflow Dual Flaps

The large flaps send a large volume of air downwards to the floor. The flap provides an optimum control area in cooling, heating and dry mode.

Heating Mode

During heating mode, the large flap enables direct warm air straight downwards. The flap presses the warm air above the floor to reach the entire room.

Cooling Mode

During cooling mode, the flap retracts into the indoor unit. Then, cool air can be blown far and pervaded all over the room.





Wide-Angle Louvers

The louvers, made of elastic synthetic resin, provide a wide range of airflow that guarantees a comfortable air distribution.

Auto-Swing

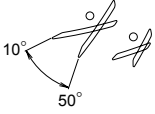
In case of FTK(X)S20-50D

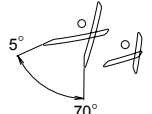
The following table explains the auto swing process for heating, cooling, dry and fan :

Vertical Swing (up and down)			Horizontal Swing (right and left: manual)
Cooling / Dry	Heating	Fan	
 <p>(R4281)</p>	 <p>(R4282)</p>	 <p>(R4283)</p>	 <p>(R4284)</p>

3-D Airflow

FTXG25-35E, CTXG50E, FTK(X)S50F

- Alternative repetition of vertical and horizontal swing motions enables uniform air-conditioning of the entire room. This function is effective for starting the air conditioner.
- When the horizontal swing and vertical swing are both set to auto mode, the airflow become 3-D airflow and the horizontal swing and vertical swing motions are alternated. The order of swing motion is such that it turns counterclockwise, starting from the right upper point as viewed to the front side of the indoor unit.

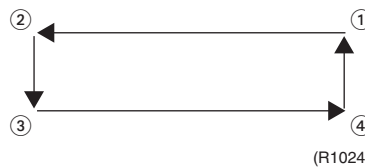



COMFORT AIRFLOW Mode

FTXG25-35E, CTXG50E

The vertical swing flap is controlled not to blow the air directly on the person in the room.

- The airflow rate is set to AUTOMATIC.
- The airflow rate has the upper limit (M tap) in heating mode.
- The latest command has the priority between POWERFUL and COMFORT AIRFLOW.

Heating	Cooling, Dry
 <p>(R3297)</p>	 <p>(R3298)</p>

FTK(X)S20-50D

The vertical swing flap is controlled not to blow the air directly on the person in the room.

- The airflow rate is controlled automatically within the following steps.

Cooling: L tap – MH tap (same as AUTOMATIC)

Heating: ML tap – M tap

- The latest command has the priority between POWERFUL and COMFORT AIRFLOW.

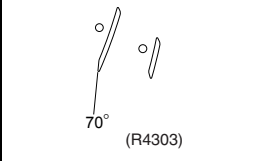
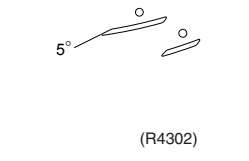
Heating	Cooling
 <p>70° (R4303)</p>	 <p>5° (R4302)</p>

1.3 Operation Starting Control

FTXG25-35E, CTXG50E

The system carries out the following control at the beginning to conduct every functional parts properly.

1. Opening the front panel fully
2. Output of the ΔD signal after the front panel starts moving
3. Opening the flap fully after the front panel opens fully
4. Making the fan rotate when the flap passes over the fan-banned area

Control Flow

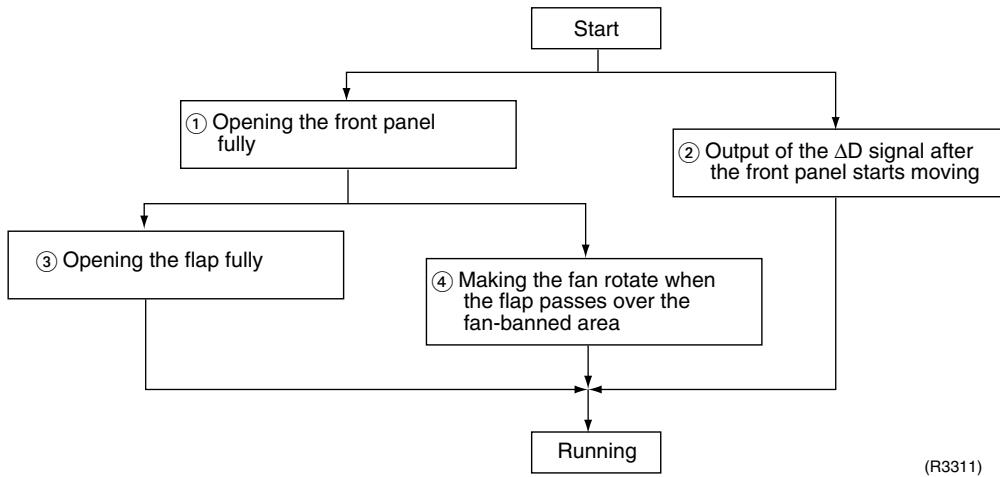

Timing Chart

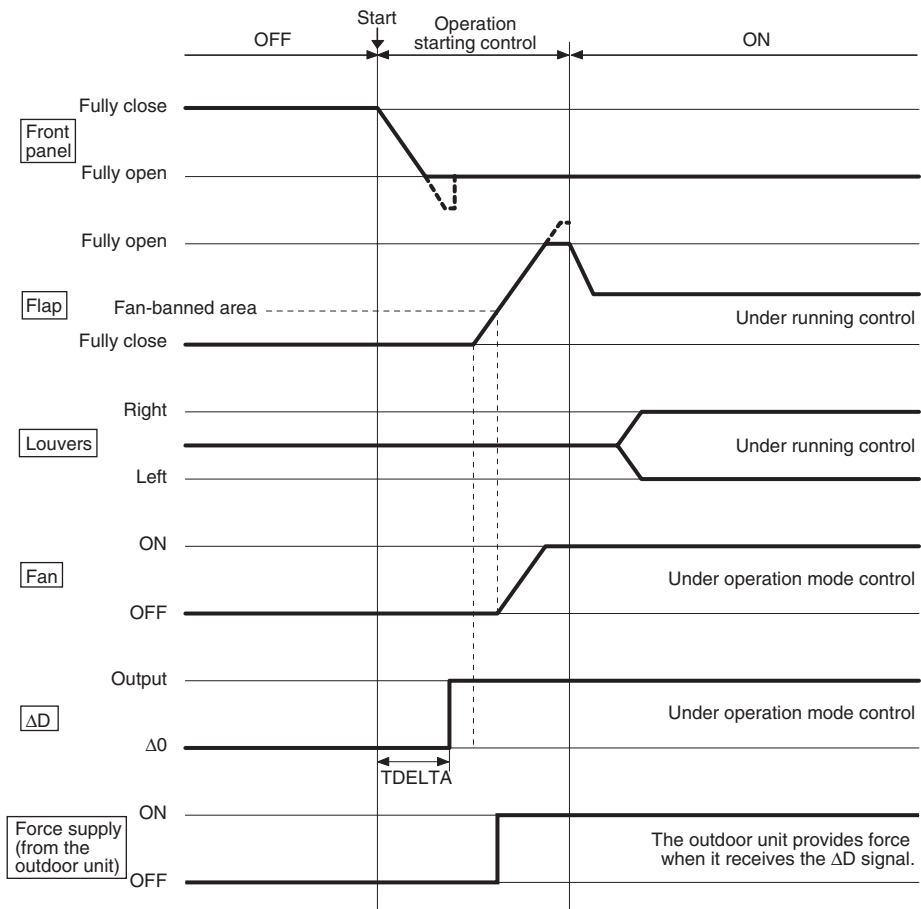

1.4 Fan Speed Control for Indoor Units

Control Mode

The airflow rate can be automatically controlled depending on the difference between the set temperature and the room temperature. This is done through phase control and Hall IC control.



For more information about Hall IC, refer to the troubleshooting for fan motor on page 237.

Phase Steps

Phase control and fan speed control contains 9 steps: LLL, LL, SL, L, ML, M, MH, H and HH. In automatic operation, the step "SL" is not available.

Step	FTXG25/35E CTXG50E FVXS25-50F		FTK(X)S50E		FTK(X)S20-50D FTK(X)S20-35CA FDK(X)S25-35EA FDK(X)S25-35CA FDK(X)S50C FLK(X)S25-50BA							
	Cooling	Heating	Cooling	Heating	Cooling	Heating						
LLL												
LL												
L												
ML												
M												
MH												
H												
HH (Powerful)							H+70 (FTXG25/35E) H+50 (CTXG50E) H+40 (FVXS25-50F)	H+50 (FTXG25/35E, CTXG50E) H+40 (FVXS25-50F)	H+90	H+90	H+50	H+50

= Within this range the airflow rate is automatically controlled when the FAN setting button is set to automatic.



Note:

1. Fan stops during defrost operation.
2. In time of thermostat OFF, the fan rotates at the following speed.
Cooling : The fan keeps rotating at the set tap.
Heating : The fan stops.

Automatic Air Flow Control for Heating

On heating mode, the indoor fan speed will be regulated according to the indoor heat exchanger temperature and the difference between the room temperature and the required set point.

Automatic Air Flow Control for Cooling

The following drawing explains the principle of fan speed control for cooling:

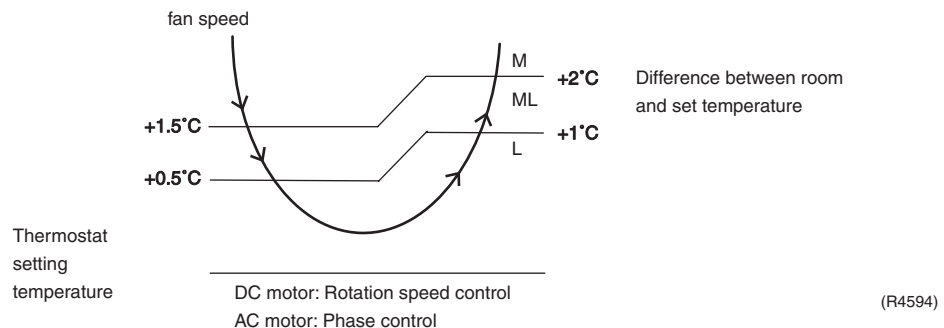

1.5 Programme Dry Function

Programme dry function removes humidity while preventing the room temperature from lowering.

Since the microcomputer controls both the temperature and air flow volume, the temperature adjustment and fan adjustment buttons are inoperable in this mode.

In Case of Inverter Units

The microcomputer automatically sets the temperature and fan settings. The difference between the room temperature at startup and the temperature set by the microcomputer is divided into two zones. Then, the unit operates in the dry mode with an appropriate capacity for each zone to maintain the temperature and humidity at a comfortable level.

Room temperature at startup	Set temperature X	Thermostat OFF point Y	Thermostat ON point Z
24°C or more	Room temperature at startup	$X - 2.5^{\circ}\text{C}$	$X - 0.5^{\circ}\text{C}$ or $Y + 0.5^{\circ}\text{C}$ (zone B) continues for 10 min.
23.5°C ⋮ 18°C		$X - 2.0^{\circ}\text{C}$	$X - 0.5^{\circ}\text{C}$ or $Y + 0.5^{\circ}\text{C}$ (zone B) continues for 10 min.
17.5°C ⋮	18°C	$X - 2.0^{\circ}\text{C}$	$X - 0.5^{\circ}\text{C} = 17.5^{\circ}\text{C}$ or $Y + 0.5^{\circ}\text{C}$ (zone B) continues for 10 min.

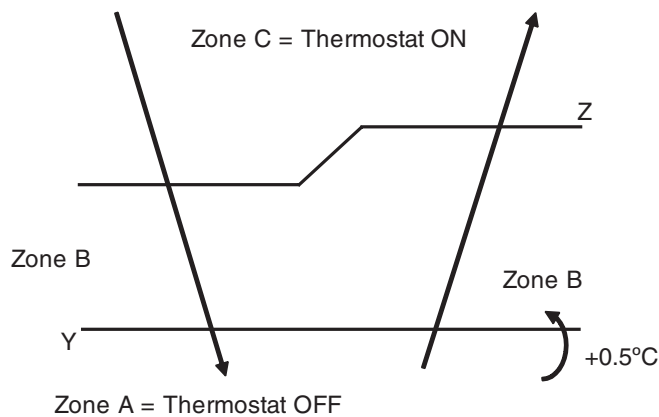

(R6841)

1.6 Automatic Operation

Automatic Cooling / Heating Function (Heat Pump Only)

When the AUTO mode is selected with the remote controller, the microcomputer automatically determines the operation mode from cooling and heating according to the room temperature and setting temperature at the time of the operation startup, and automatically operates in that mode.

The unit automatically switches the operation mode to cooling or heating to maintain the room temperature at the main unit setting temperature.

Detailed Explanation of the Function

1. Remote controller setting temperature is set as automatic cooling / heating setting temperature (18 to 30°C).
2. Main unit setting temperature equals remote controller setting temperature.
3. Operation ON / OFF point and mode switching point are as follows.
 - ① Heating → Cooling switching point:
Room temperature \geq Main unit setting temperature +2.5 deg.
 - ② Cooling → Heating switching point:
Room temperature $<$ Main unit setting temperature -2.5 deg.
 - ③ Thermostat ON / OFF point is the same as the ON / OFF point of cooling or heating operation.
4. During initial operation
 Room temperature \geq Remote controller setting temperature: Cooling operation
 Room temperature $<$ Remote controller setting temperature: Heating operation

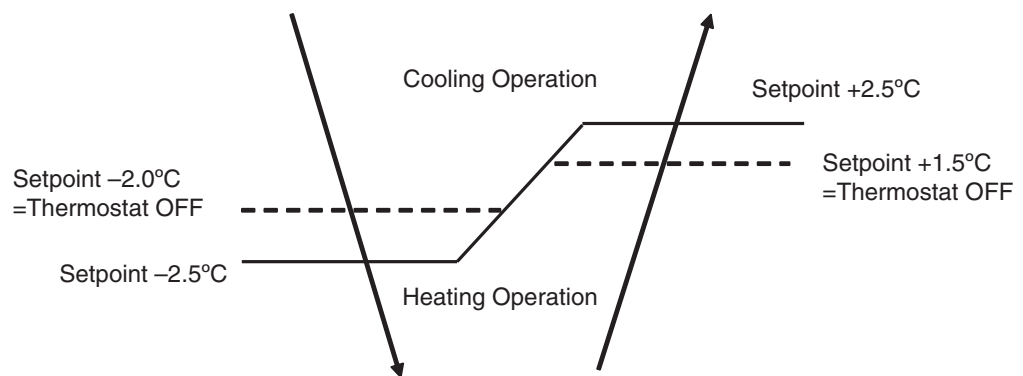

(R6842)

Ex: When the set point is 25°C

Cooling Operation → 23°C: Thermostat OFF → 22°C: Switch to Heating Operation

5. Heating Operation → 26.5°C: Thermostat OFF → 27.5°C: Switch to Cooling Operation

1.7 Thermostat Control

Thermostat control is based on the difference between the room temperature and the setpoint.

Thermostat OFF Condition

- ◆ The temperature difference is in the zone A.

Thermostat ON Condition

- ◆ The temperature difference is above the zone C after being in the zone A.
- ◆ The system resumes from defrost control in any zones except A.
- ◆ The operation turns on in any zones except A.
- ◆ The monitoring time has passed while the temperature difference is in the zone B.
(Cooling / Dry : 10 minutes, Heating : 10 seconds)

Cooling / Dry

- ◆ Wall Mounted Type
- ◆ Floor standing Type

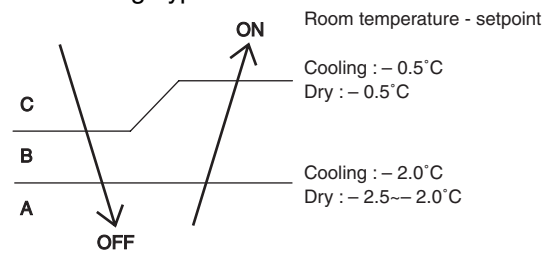

(R4668)

- ◆ Floor/Ceiling suspended Type
- ◆ Duct Connected Type

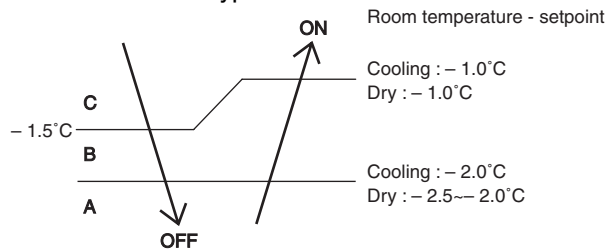

(R6032)

Heating

- ◆ Wall Mounted Type
- ◆ Floor standing Type

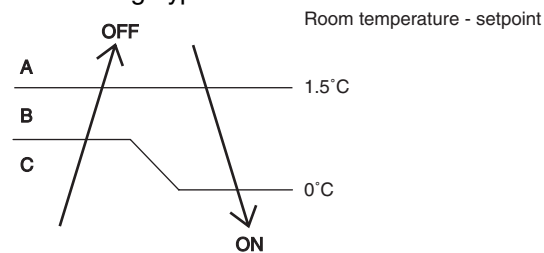

(R4669)

- ◆ Floor/Ceiling suspended Type
- ◆ Duct Connected Type

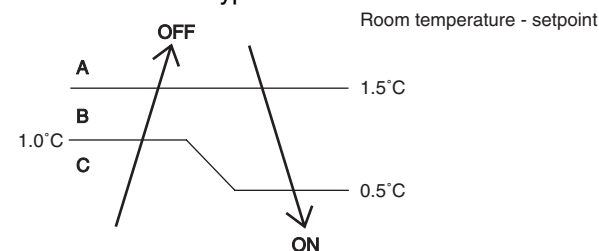

(R6033)

1.8 Night Set Mode

When the OFF timer is set, the Night Set circuit automatically activates. The Night Set circuit maintains the airflow setting made by users.

The Night Set Circuit

The Night Set circuit continues heating or cooling the room at the set temperature for the first one hour, then automatically raises the temperature setting slightly in the case of cooling, or lowers it slightly in the case of heating, for economical operations. This prevents excessive heating in winter and excessive cooling in summer to ensure comfortable sleeping conditions, and also conserves electricity.

Cooling Operation

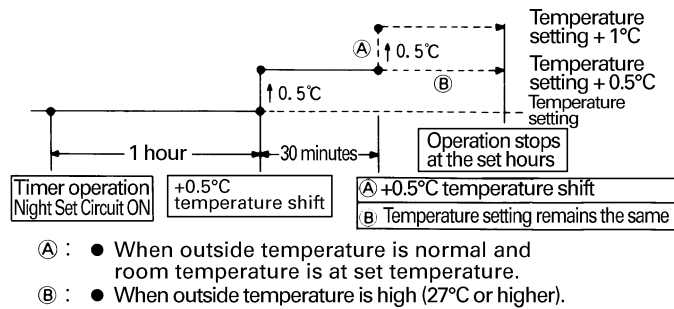

(R1361)

In case of FTXG25-35E, CTXG50E, FTK(X)S20-50D, FVXS25-50F the temperature rises once.

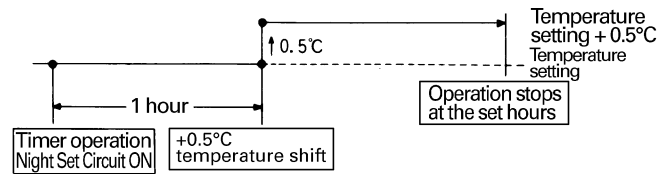

(R4421)

Heating Operation

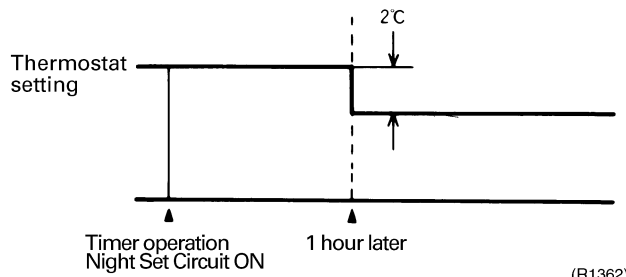

(R1362)

1.9 ECONO Mode

Outline

FTK(X)S20-50D, FVXS25-50F

The "ECONO mode" reduces the maximum operating current and power consumption by approx. 30% during start up etc..

This mode is particularly convenient for energy-saving-oriented users. It is also a major bonus for those whose breaker capacities do not allow the use of multiple electrical devices and air conditioners.

It is easily activated from the wireless remote controller by pushing the ECONO button.

- When this function is ON, the maximum capacity is also down. (Approx. 20%)
- This function can only be set when the unit is running. Pressing the operation stop button causes the settings to be canceled.
- This function and POWERFUL operation cannot be used at the same time. The latest command has the priority.

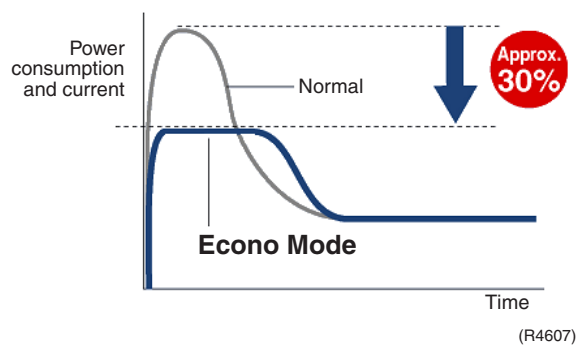

Details

- ECONO mode can be activated while the unit is running. The remote controller can send the ECONO command when the unit is in COOL, HEAT, DRY, or AUTO operation.
- When the ECONO command is valid, the upper limit of frequency is restricted.

1.10 INTELLIGENT EYE (Wall Mounted Type Only)

This is the function that detects existence of humans in the room by a human motion sensor (INTELLIGENT EYE) and reduces the capacity when there is no human in the room in order to save electricity.

Processing

1. Detection method by INTELLIGENT EYE

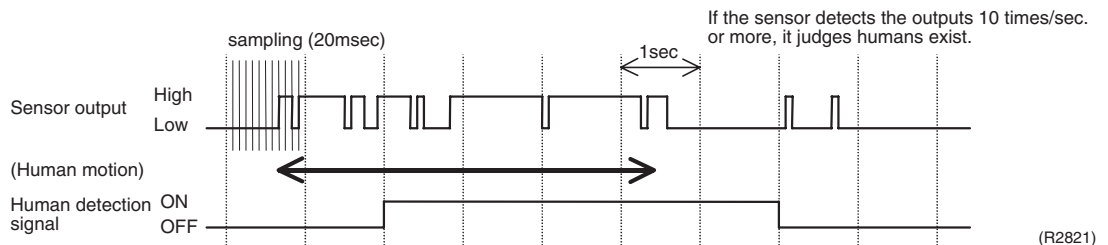

- This sensor detects human motion by receiving infrared rays and displays the pulse wave output.
- A microcomputer in an indoor unit carries out a sampling every 20 msec. and if it detects 10 cycles of the wave in one second in total (corresponding to $20\text{msec.} \times 10 = 100\text{msec.}$), it judges human is in the room as the motion signal is ON.

2. The motions (for example: in cooling)

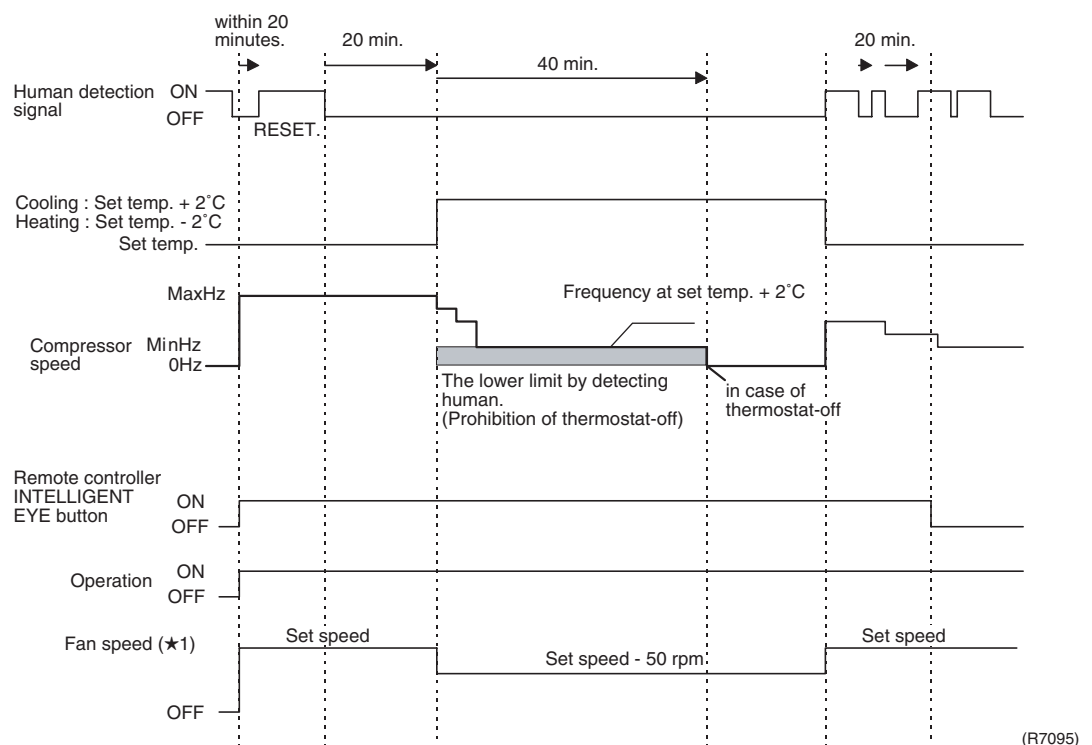

- When a microcomputer doesn't have a signal from the sensor in 20 minutes, it judges that nobody is in the room and operates the unit in temperature shifted 2°C from the set temperature. (Cooling / Dry : 2°C higher, Heating : 2°C lower and Auto : according to the operation mode at that time.)
- ★1 In case of Fan mode, the fan speed reduces by 50 rpm.

- Since the set temperature is shifted by 2°C higher for 40 minutes, compressor speed becomes low and can realize energy saving operation. But as thermostat is prone to be off by the fact that the set temperature has been shifted, the thermostat-off action is prohibited in 40 minutes so as to prevent this phenomena.
After this 40 minutes, the prohibition of the thermostat-off is cancelled and it can realize the conditions to conduct thermostat-off depending on the room temperature. In or after this 40 minutes, if the sensor detects human motion detection signal, it let the set temperature and the fan speed return to the original set point, keeping a normal operation.

Others

- The dry operation can't command the setting temperature with a remote controller, but internally the set temperature is shifted by 1°C.

1.11 HOME LEAVE Operation

Outline

In order to respond to the customer's need for immediate heating and cooling of the room after returning home or for house care, a measure to switch the temperature and air volume from that for normal time over to outing time by one touch is provided. (This function responds also to the need for keeping up with weak cooling or heating.)

This time, we seek for simplicity of operation by providing the special temperature and air volume control for outing to be set by the exclusive button.

The SkyAir indoor models also have the function.

Detail of the Control

1. Start of Function

The function starts when the [HOME LEAVE] button is pressed in cooling mode or heating mode (including stopping and powerful operation). If this button is pressed while the operation is stopped, the function becomes effective when the operation is started. If this button is pressed in powerful operation, the powerful operation is reset and this function becomes effective.

- The [HOME LEAVE] button is ineffective in dry mode and fan mode.

2. Details of Function

A mark representing [HOME LEAVE] is indicated on the liquid crystal display of the remote controller. The indoor unit is operated according to the set temperature and air volume for HOME LEAVE which were pre-set in the memory of the remote controller.

The LED (Red) of indoor unit representing [HOME LEAVE] lights up. (It goes out when the operation is stopped.)

3. End of Function

The function ends when the [HOME LEAVE] button is pressed again during [HOME LEAVE] operation or when the powerful operation button is pressed.

Scene <cooling>



Scene <Heating>

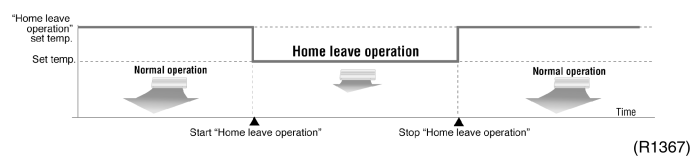
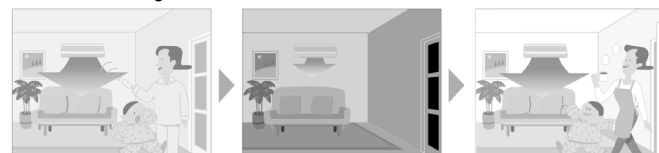

Others

The set temperature and set air volume are memorized in the remote controller. When the remote controller is reset due to replacement of battery, it is necessary to set the temperature and air volume again for [HOME LEAVE].

1.12 Inverter POWERFUL Operation

Outline

In order to exploit the cooling and heating capacity to full extent, operate the air conditioner by increasing the indoor fan rotating speed and the compressor frequency.

Details of the Control

When POWERFUL button is pushed in each operation mode, the fan speed / setting temperature will be converted to the following states in a period of 20 minutes.

In case of FTK(X)S20-50D

Operation mode	Fan speed	Target set temperature
COOL	H tap + 50 rpm	18°C
DRY	Dry rotating speed + 50 rpm	Normally targeted temperature in dry operation; Approx. -2°C
HEAT	H tap + 50 rpm	30°C
FAN	H tap + 50 rpm	—
AUTO	Same as cooling / heating in POWERFUL operation	The target is kept unchanged

Ex.) : POWERFUL operation in cooling mode.

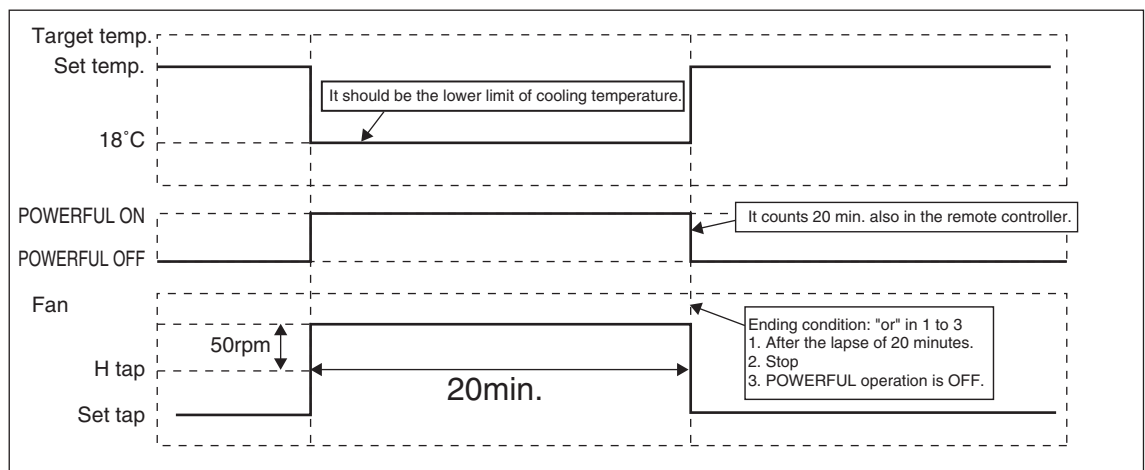

(R7096)



Refer to "Fan Speed control" on page 63 for detail.

1.13 Other Functions

1.13.1 Hot Start Function

Heat Pump Only

In order to prevent the cold air blast that normally comes when heating is started, the temperature of the heat exchanger of the indoor unit is detected, and either the air flow is stopped or is made very weak thereby carrying out comfortable heating of the room.

*The cold air blast is also prevented using a similar control when the defrosting operation is started or when the thermostat gets turned ON.

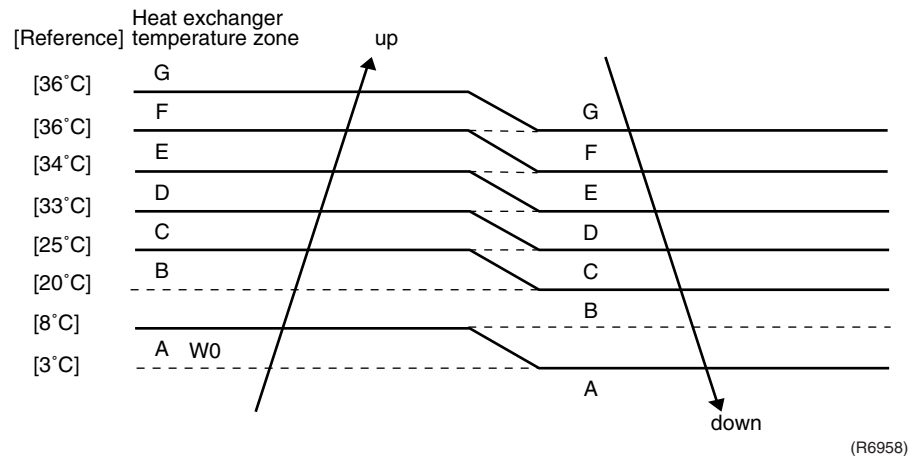

1.13.2 Signal Receiving Sign

When the indoor unit receives a signal from the remote controller, the unit emits a signal receiving sound.

1.13.3 ON/OFF Button on Indoor Unit

An ON/OFF button is provided on the front panel of the unit. Use this button when the remote controller is missing or if its battery has run out.

Every press of the button switches from ON to OFF or from OFF to ON.

In case of FTK(X)S20-50D

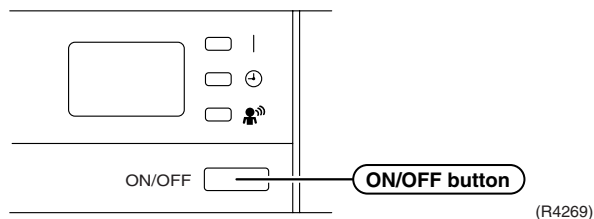

- Push this button once to start operation. Push once again to stop it.
- This button is useful when the remote controller is missing.
- The operation mode refers to the following table.

	Mode	Temperature setting	Air flow rate
Cooling Only	COOL	22°C	AUTO
Heat Pump	AUTO	25°C	AUTO

- In the case of multi system operation, there are times when the unit does not activate with this button.

<Forced operation mode>

Forced operation mode will be set by pressing the ON/OFF button for between 5 to 9 sec. while the unit is not operating.



Note: When the ON/OFF button is pressed for 10 sec. or more, the operation will be stopped. See page 95 for the detail of "Forced Operation Mode".

1.13.4 Titanium Apatite Photocatalytic Air-Purifying Filter

For FTK(X)S20-50D, FTK(X)S50F, FVXS25-50F, FTXG25/35E, CTXG50E

This filter combines the Air Purifying Filter and Titanium Apatite Photocatalytic Deodorizing Filter in a single highly effective unit. The filter traps microscopic particles, decompose odours and even deactivates bacteria and viruses. It lasts for three years without replacement if washed about once every six months.

1.13.5 Photocatalytic Deodorizing Filter

For FLK(X)S25-50B

Photocatalytic Deodorizing Filter demonstrates powerful oxidation characteristics when subjected to harmless ultraviolet light. Photocatalytic deodorizing power is recovered simply by exposing the filter to the sun for 6 hours once every 6 months.

1.13.6 Air-Purifying Filter

For FLK(X)S25-50B

A double structure made up of a bacteriostatic filter and an Air-Purifying Filter traps dust, mildew, mites, tobacco smoke, and allergy-causing pollen. Replace the Air-Purifying Filter once every 3 months.

1.13.7 Air Purifying Filter with Photocatalytic Deodorizing Function

For FTK(X)S20-35C

This filter incorporates the benefits the Air Purifying Filter and Photocatalytic Deodorizing Filter in a single unit. Combining the two filters in this way increases the active surface area of the new filter. This larger surface area allows the filter to effectively trap microscopic particles, decompose odours and deactivate bacteria and viruses even for the high volume of air required to air-condition large living rooms. The filter can be used for approximately 3 years if periodic maintenance is performed.

1.13.8 Mold Proof Air Filter (Prefilter)

For all indoor units

The filter net is treated with mold resisting agent TBZ (harmless, colorless, and odorless). Due to this treatment, the amount of mold growth is much smaller than that of normal filters.

1.13.9 Self-Diagnosis Digital Display

The microcomputer continuously monitors main operating conditions of the indoor unit, outdoor unit and the entire system. When an abnormality occur, the LCD remote controller displays error code. These indications allow prompt maintenance operations.

1.13.10 Auto-restart Function

Even if a power failure (including one for just a moment) occurs during the operation, the operation restarts in the condition before power failure automatically when power is restored. (Note) It takes 3 minutes to restart the operation because the 3-minute stand-by function is activated.

1.13.11 WEEKLY TIMER Operation

Up to 4 timer settings can be saved for each day of the week (up to 28 settings in total). Those 3 items of "ON / OFF", "temperature" and "time" can be set.



Refer to "WEEKLY TIMER Operation" on page 196 for detail.

2. Function of Main Structural Parts

2.1 Main Structural Parts

Heat Pump Model

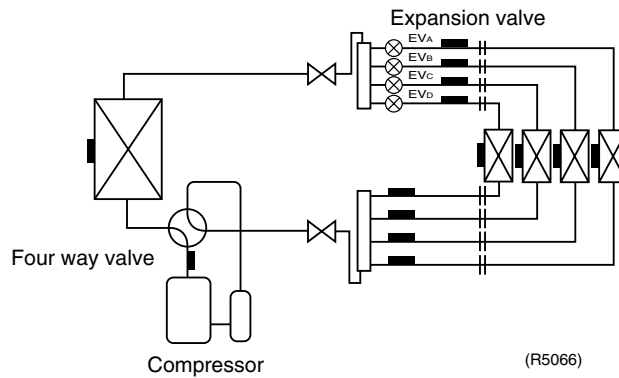

Cooling Only Model

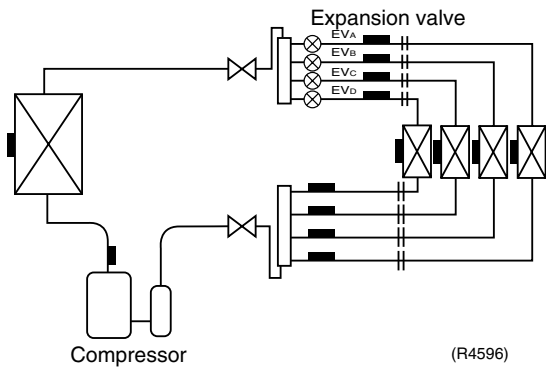

i Note: Expansion Valve : In Case of 2 port model.....EVA-B, 3 port model.....EVA-C, 4 port model.....EVA-D

2.2 Function of Thermistor

2.2.1 Heat Pump Model

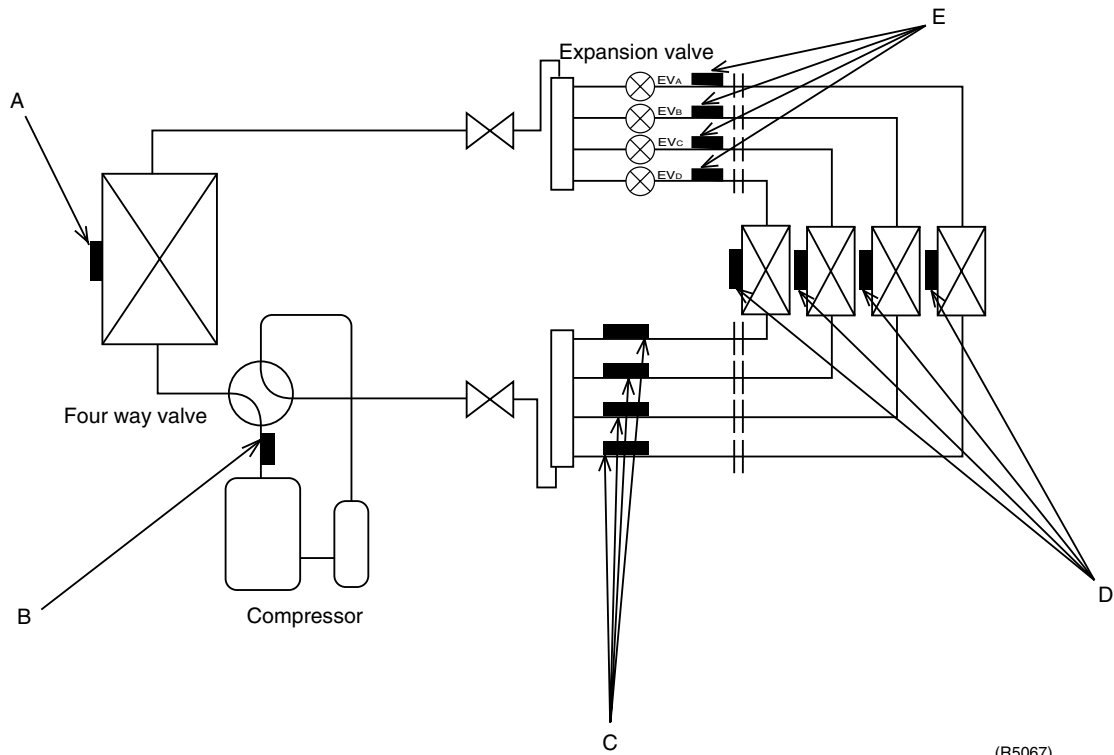

A Outdoor Heat Exchanger Thermistor

1. The outdoor heat exchanger thermistor is used for controlling target discharge temperature. The system sets a target discharge temperature according to the outdoor and indoor heat exchanger temperature, and controls the electronic expansion valve opening so that the target discharge temperature can be obtained.
2. The outdoor heat exchanger thermistor is used for detecting disconnection of the discharge thermistor when cooling. When the discharge pipe temperature becomes lower than the outdoor heat exchanger temperature, the discharge pipe thermistor is judged as disconnected.

B Discharge Pipe Thermistor

1. The discharge pipe thermistor is used for controlling temperature of the discharge pipe. If the temperature of discharge pipe (used in place of the inner temperature of the compressor) rises abnormally, the operating frequency drops or the operation halts.
2. The discharge pipe thermistor is used for detecting disconnection of the discharge thermistor.

C Gas Pipe Thermistor

1. In cooling, the gas pipe thermistors are used for gas pipe isothermal control. The system controls electronic expansion valve opening so that gas pipe temperature in each room becomes equal.

D Indoor Heat Exchanger Thermistor

1. The indoor heat exchanger thermistors are used for controlling target discharge temperature.
The system sets a target discharge pipe temperature according to the outdoor and indoor heat exchanger temperature, and controls the electronic expansion valve opening so that the target discharge temperature can be obtained.
2. The indoor heat exchanger thermistors are used for preventing freezing.
During the cooling operation, if the temperature drops abnormally, the operating frequency becomes lower, then the operation halts.
3. The indoor heat exchanger thermistors are used for anti-icing control.
During the cooling operation, if the heat exchanger temperature in the room where operation is halted becomes -1°C , or if the room temperature - heat exchanger temperature in the room where operation is halted becomes $\geq 10^{\circ}\text{C}$, it is assumed as icing.
4. During heating: the indoor heat exchanger thermistors are used for detecting disconnection of the discharge pipe thermistor.
When the discharge pipe temperature becomes lower than the indoor heat exchanger temperature, the discharge pipe thermistor is judged as disconnected.
The indoor heat exchanger thermistors are also used for preventing abnormal high pressure.
5. The indoor heat exchanger thermistors are used for detecting incorrect wiring.
During checking incorrect wiring, refrigerant is passed in order from the port A to detect a heat exchanger temperature, and then wiring and piping will be checked.
6. The indoor heat exchanger thermistors are used for sub-cooling control.
The actual sub-cooling is calculated from the liquid pipe temperature and the heat exchanger temperature. The system controls the electronic expansion valve opening to reach the target sub-cooling.
7. The indoor heat exchanger thermistors are used for heating isothermal control of heat exchanger.
When heating: if the difference in temperature of each room is greater than 8°C , the electronic expansion valve of the room in which the temperature is higher is opened.

E Liquid Pipe Thermistor

1. In heating, the liquid pipe thermistors are used for sub-cooling control.
The system calculates the actual sub-cooling with the liquid pipe temperature and the maximum heat exchanger temperature among all rooms, and controls the opening of the electronic expansion valve to reach the target sub-cooling.

2.2.2 Cooling Only Model

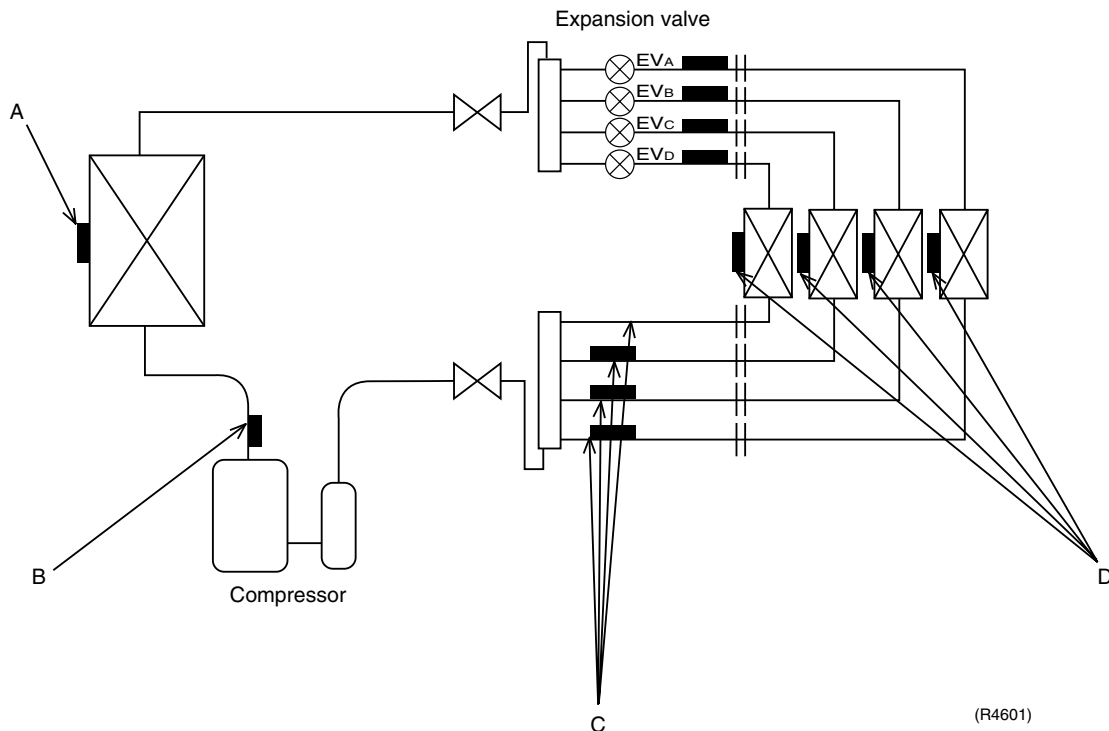

A Outdoor Heat Exchanger Thermistor

1. The outdoor heat exchanger thermistor is used for controlling target discharge temperature. The system sets a target discharge temperature according to the outdoor and indoor heat exchanger temperature, and controls the electronic expansion valve opening so that the target discharge temperature can be obtained.
2. The outdoor heat exchanger thermistor is used for detecting disconnection of the discharge thermistor when cooling. When the discharge pipe temperature becomes lower than the outdoor heat exchanger temperature, the discharge pipe thermistor is judged as disconnected.

B Discharge Pipe Thermistor

1. The discharge pipe thermistor is used for controlling temperature of the discharge pipe. If the temperature of discharge pipe (used in place of the inner temperature of the compressor) rises abnormally, the operating frequency drops or the operation halts.
2. The discharge pipe thermistor is used for detecting disconnection of the discharge thermistor.

C Gas Pipe Thermistor

1. In cooling, the gas pipe thermistors are used for gas pipe isothermal control. The system controls electronic expansion valve opening so that gas pipe temperature in each room becomes equal.

D Indoor Heat Exchanger Thermistor

1. The indoor heat exchanger thermistors are used for controlling target discharge temperature.
The system sets a target discharge pipe temperature according to the outdoor and indoor heat exchanger temperature, and controls the electronic expansion valve opening so that the target discharge temperature can be obtained.
2. The indoor heat exchanger thermistors are used for preventing freezing.
During the cooling operation, if the temperature drops abnormally, the operating frequency becomes lower, then the operation halts.
3. The indoor heat exchanger thermistors are used for anti-icing control.
During the cooling operation, if the heat exchanger temperature in the room where operation is halted becomes -1°C , or if the room temperature - heat exchanger temperature in the room where operation is halted becomes $\geq 10^{\circ}\text{C}$, it is assumed as icing.
4. The indoor heat exchanger thermistors are used for detecting incorrect wiring.
During checking incorrect wiring, refrigerant is passed in order from the port A to detect a heat exchanger temperature, and then wiring and piping will be checked.

3. Control Specification

3.1 Mode Hierarchy

Outline

There are two modes; the mode selected in user's place (normal air conditioning mode) and forced operation mode for installation and providing service.

Detail

1. For heat pump model

There are following modes; stop, cooling (includes drying), heating (include defrosting)

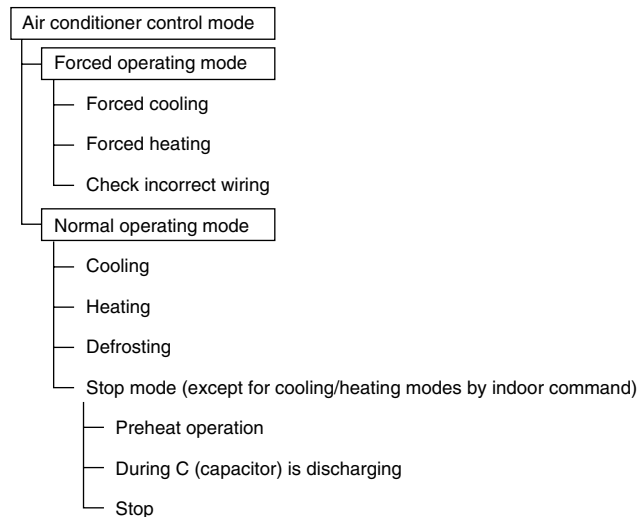

(R1373)

2. For cooling only model

There are following models; stop and cooling (including drying).

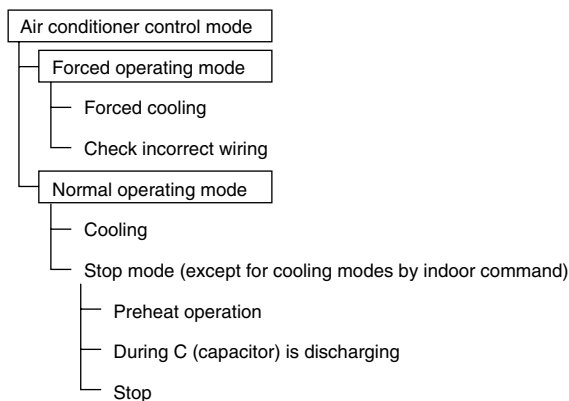

(R1374)



Note:

Unless specified otherwise, an indoor dry operation command must be regarded as cooling operation. An indoor fan operation command cannot be made in a multiple indoor unit. (A forced fan command to the indoor unit from the outdoor unit must be made during forced operation.)

Determine Operating Mode

Judge the operating mode command set by each room in accordance with the instructing procedure, and determine the operating mode of the system.

The following procedure will be taken as the modes conflict with each other.

*1. The system will follow the mode determined first. (First-push, first-set)

*2. For the rooms set with different mode, select stand-by mode. (Operation lamp flashes)

3.2 Frequency Control

Outline

Frequency that corresponds to each room's capacity will be determined according to the difference in the temperature of each room and the temperature that is set by the remote controller.

The function is explained as follows.

1. How to determine frequency.
2. Frequency command from an indoor unit. (The difference between a room temperature and the temperature set by the remote controller.)
3. Frequency command from an indoor unit. (The ranked capacity of the operating room).
4. Frequency initial setting.
5. PI control.

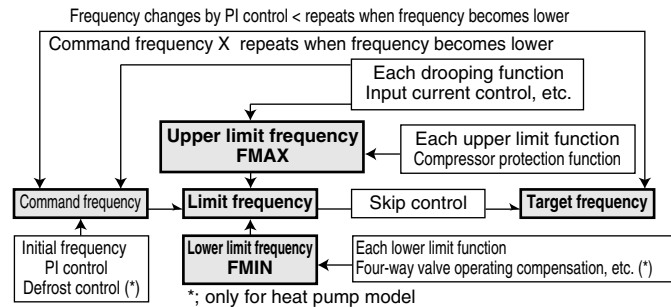

(R1375)

Detail

How to Determine Frequency

The compressor's frequency will finally be determined by taking the following steps.

For Heat Pump Model

1. Determine command frequency

- ◆ Command frequency will be determined in the following order of priority.
 - 1.1 Limiting frequency by drooping function
 - ◆ Input current, discharge pipes, low Hz high pressure limit, peak cutting, freeze-up protection, dew prevention, fin thermistor temperature.
 - 1.2 Limiting defrost control time
 - 1.3 Forced cooling / heating
 - 1.4 Indoor frequency command

2. Determine upper limit frequency

- ◆ Set a minimum value as an upper limit frequency among the frequency upper limits of the following functions:
Compressor protection, input current, discharge pipes, Low Hz high pressure, peak cutting, freeze-up protection, defrost.

3. Determine lower limit frequency

- ◆ Set a maximum value as an lower limit frequency among the frequency lower limits of the following functions:
Four way valve operating compensation, draft prevention, pressure difference upkeep.

4. Determine prohibited frequency

- ◆ There is a certain prohibited frequency such as a power supply frequency.

For Cooling Only Model

1. Determine command frequency

- ◆ Command frequency will be determined in the following order of priority.
 - 1.1 Limiting frequency by drooping function
 - ◆ Input current, discharge pipes, freeze-up protection, dew prevention, fin thermistor temperature.
 - 1.2 Indoor frequency command

2. Determine upper limit frequency

- ◆ Set a minimum value as an upper limit frequency among the frequency upper limits of the following functions:
Compressor protection, input current, discharge pipes, freeze-up protection, dew prevention, fin thermistor temperature.

3. Determine lower limit frequency

- ◆ Set a maximum value as an lower limit frequency among the frequency lower limits of the following functions:
Pressure difference upkeep.

4. Determine prohibited frequency

- ◆ There is a certain prohibited frequency such as a power supply frequency.

Indoor Frequency Command (ΔD signal)

The difference between a room temperature and the temperature set by the remote controller will be taken as the " ΔD signal" and is used for frequency command.

Temperature difference	ΔD signal	Temperature difference	ΔD signal	Temperature difference	ΔD signal	Temperature difference	ΔD signal
0	*Th OFF	2.0	4	4.0	8	6.0	C
0.5	1	2.5	5	4.5	9	6.5	D
1.0	2	3.0	6	5.0	A	7.0	E
1.5	3	3.5	7	5.5	B	7.5	F

*Th OFF = Thermostat OFF

Indoor Unit Capacity (S value)

The capacity of the indoor unit is a "S" value and is used for frequency command.

Capacity	S value	Capacity	S value
2.5 kW	25	5.0 kW	50
3.5 kW	35		

Frequency Initial Setting**<Outline>**

When starting the compressor, or when conditions are varied due to the change of the operating room, the frequency must be initialized according to the total of a maximum ΔD value of each room and a total value of Q (ΣQ) of the operating room (the room in which the thermostat is set to ON).
Q value: Indoor unit output determined from indoor unit volume, air flow rate and other factors.

PI Control (Determine Frequency Up / Down by ΔD Signal)**1. P control**

Calculate a total of the ΔD value in each sampling time (20 seconds), and adjust the frequency according to its difference from the frequency previously calculated.

2. I control

If the operating frequency is not change more than a certain fixed time, adjust the frequency up and down according to the $\Sigma \Delta D$ value, obtaining the fixed $\Sigma \Delta D$ value.

When the $\Sigma \Delta D$ value is small...lower the frequency.

When the $\Sigma \Delta D$ value is large...increase the frequency.

3. Limit of frequency variation width

When the difference between input current and input current drooping value is less than 1.5 A, the frequency increase width must be limited.

4. Frequency management when other controls are functioning

- ◆ When each frequency is drooping;
Frequency management is carried out only when the frequency droops.
- ◆ For limiting lower limit
Frequency management is carried out only when the frequency rises.

5. Upper and lower limit of frequency by PI control

The frequency upper and lower limits are set depending on the total of S values of a room. When low noise commands come from the indoor unit more than one room or when outdoor unit low noise or quiet commands come from all the rooms, the upper limit frequency must be lowered than the usual setting.

3.3 Controls at Mode Changing / Start-up

3.3.1 Preheating Operation

Outline Operate the inverter in the open phase operation with the conditions including the preheating command from the indoor, the outdoor air temperature and discharge pipe temperature. The power consumption of preheating operation is 35W. (The total power consumption depends on the number of the indoor units.)

Detail

Preheating ON Condition

- ◆ When outdoor air temperature is below 10.5°C and discharge pipe temperature is below 10.5°C, inverter in open phase operation starts.

OFF Condition

- ◆ When outdoor air temperature is higher than 12°C or discharge pipe temperature is higher than 12°C, inverter in open phase operation stops.

3.3.2 Four Way Valve Switching

Outline

Heat Pump Only

During the heating operation current must be conducted and during cooling and defrosting current must not be conducted. In order to eliminate the switching sound (as the four way valve coil switches from ON to OFF) when the heating is stopped, the delay switch of the four way valve must be carried out after the operation stopped.

Detail

The OFF delay of four way valve
Energize the coil for 150 sec after unit operation is stopped.

3.3.3 Four Way Valve Operation Compensation

Outline

Heat Pump Only

At the beginning of the operation as the four way valve is switched, acquire the differential pressure required for activating the four way valve by having output the operating frequency, which is more than a certain fixed frequency, for a certain fixed time. The lower limit frequency is restricted to 48Hz for 70 seconds on both cooling and heating, except under the condition of heating overload (outdoor temperature ≥ 15 degree).

Detail

Starting Conditions

1. When starting compressor for heating.
2. When the operating mode changes from the previous time.
3. When starting compressor for rushing defrosting or resetting.
4. When starting compressor for the first time after the reset with the power is ON.

Set the lower limit frequency to 48 (model by model) Hz for 70 seconds with any conditions 1 through 4 above.

3.3.4 3-Minute Stand-by

Prohibit to turn ON the compressor for 3 minutes after turning it off. (Except when defrosting. (Only for Heat Pump Model).)

3.3.5 Compressor Protection Function

When turning the compressor from OFF to ON, the upper limit of frequency must be set as follows. (The function must not be used when defrosting (only for heat pump model).)

	2YC36
FCG 3	85
FCG 2	70
FCG 1	55

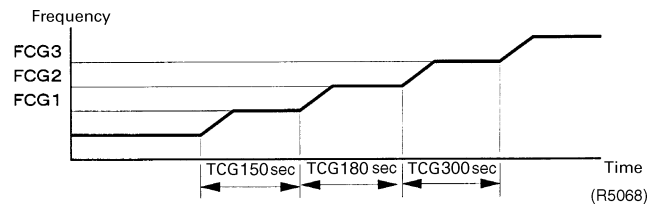

3.4 Discharge Pipe Temperature Control

Outline

The discharge pipe temperature is used as the compressor's internal temperature. If the discharge pipe temperature rises above a certain level, the operating frequency upper limit is set to keep this temperature from going up further.

Detail

Zones (typical value)

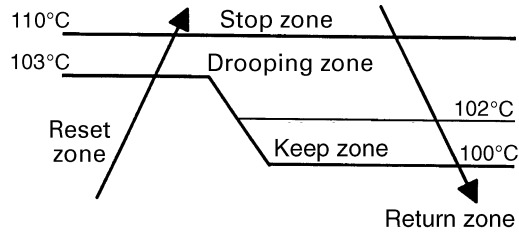

(R5069)

Management within the Zone

Zone	Control contents
Stop zone	When the temperature reaches the stop zone, stop the compressor and correct abnormality.
Drooping zone	Start the timer, and the frequency will be drooping.
Keep zone	Keep the frequency upper limit.
Return / Reset zone	Cancel the frequency upper limit.

3.5 Input Current Control

Outline

Detect an input current by the CT during the compressor is running, and set the frequency upper limit from such input current. In case of heat pump model, this control is the upper limit control function of the frequency which takes priority of the lower limit of four way valve activating compensation.

Detail

The frequency control will be made within the following zones.

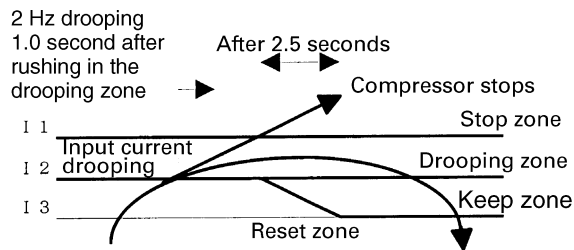

(R4598)

When a “stop current” continues for 2.5 seconds after rushing on the stop zone, the compressor operation stops.
 If a “drooping current” is continues for 1.0 second after rushing on the drooping zone, the frequency will be 2 Hz drooping.
 Repeating the above drooping continues until the current rushes on the drooping zone without change.
 In the keep zone, the frequency limit will remain.
 In the return / reset zone, the frequency limit will be cancelled.

Limitation of current drooping and stop value according to the outdoor air temperature

1. In case the operation mode is cooling
 - ◆ The current droops when outdoor air temperature becomes higher than a certain level (model by model).
2. In case the operation mode is heating (only for heat pump model)
 - ◆ The current droops when outdoor air temperature becomes higher than a certain level (model by model).

3.6 Freeze-up Protection Control

Outline During cooling operation, the signals being sent from the indoor unit allow the operating frequency limitation and then prevent freezing of the indoor heat exchanger.

Detail

Conditions for Start Controlling

Judge the controlling start with the indoor heat exchanger temperature after 2 sec from operation start and after 30 sec from changing number of operation room.

Control in Each Zone

The zone is determined by the commands from indoor units.

In drooping zone, the frequency decreases 2Hz/2 seconds.

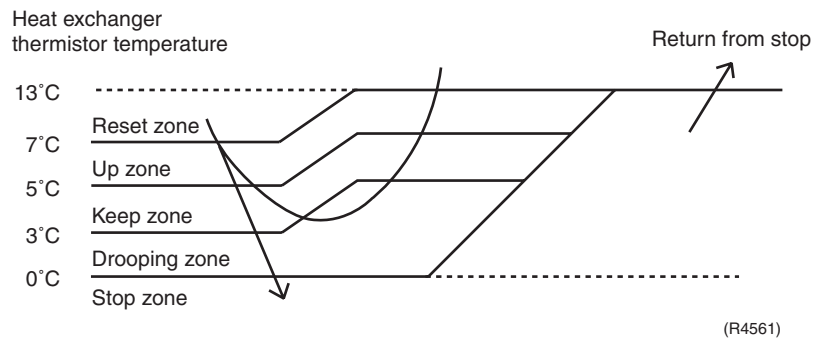

3.7 Heating Peak-cut Control

Outline

Heat Pump Only

During heating operation, the signals being sent from the indoor unit allow the operating frequency limitation and prevent abnormal high pressure. (The signal from the indoor unit must be divided as follows.)

Detail

Conditions for Start Controlling

Judge the controlling start with the indoor heat exchanger temperature after 2 min from operation start and after A sec from changing number of operation room.

	A
When increase	30
When decrease	2

Control in Each Zone

The maximum value of heat exchange intermediate temperature of each indoor unit controls the following (excluding stopped rooms).

In drooping zone, the frequency decreases 6Hz/40 seconds.

In up zone, the frequency increases 2Hz/60 seconds.

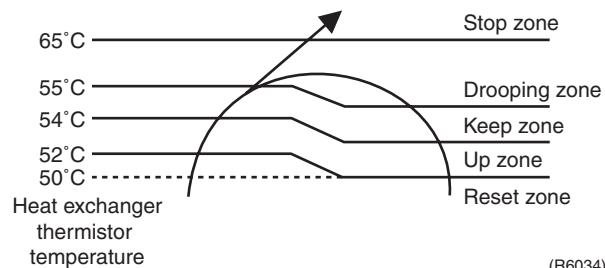

3.8 Fan Control

Outline

Fan control is carried out with following functions.

1. Fan ON control for electric component cooling fan
 2. Fan control when defrosting
 3. Fan OFF delay when stopped
 4. ON/OFF control when cooling operation
 5. Fan control when the number of heating rooms decreases
 6. Fan control when forced operation
 7. Fan control in indoor / outdoor quiet operation
 8. Fan control for pressure difference upkeep
-

Detail

Fan OFF Control when Stopped

- ◆ Fan OFF delay for 60 seconds must be made when the compressor is stopped.

Fan control when the number of heating room decreases (Only for Heat Pump Model)

When the outdoor air temperature is more than 10°C, the fan must be turned OFF for 30 seconds.

Tap Control

On cooling, the fan tap changes L ↔ M when the outdoor air temperature is 8°C, and M ↔ H at 37°C.

On heating, the fan tap changes L ↔ M when the outdoor air temperature is 12°C, and M ↔ H at 4°C.

For SkyAir models, the fan starts when the outdoor air temperature is more than 37°C on cooling, or less than -4°C on heating, or when 60 seconds have elapsed.

Tap Control in Indoor Unit Quiet Operation

1. When Cooling Operation
When the outdoor air temperature is less than 37°C, the fan tap must be set to L.
2. When Heating Operation
When the outdoor air temperature is more than 4°C, the fan tap must be turned to L (only for heat pump model).

3.9 Liquid Compression Protection Function 2

Outline

In order to obtain the dependability of the compressor, the compressor must be stopped according to the conditions of the temperature of the outdoor air and outdoor heat exchanger.

Detail

Heat Pump Model

- ◆ Operation stops depending on the outdoor air temperature.

Compressor operation turns OFF under the conditions that the system is in cooling operation and outdoor air temperature is below -10°C.

Cooling Only Model

- ◆ Operation stops depending on the outdoor air temperature.

Compressor operation turns OFF under the condition that outdoor air temperature is below -10°C.

3.10 Defrost Control

Outline

Heat Pump Only

Defrosting is carried out by the cooling cycle (reverse cycle). The defrosting time or outdoor heat exchanger temperature must be more than its fixed value when finishing.

Detail

Conditions for Starting Defrost

Under the conditions that the system is in heating operation, 6 minutes after the compressor is started and more than 38 minutes of accumulated time pass since the start of the operation or ending the defrosting.

When the outdoor air temperature and the outdoor heat exchanger temperature meet the following condition for 60 seconds, the defrost control starts.

$$A < -(19/256) \times B + (45/64) \times C$$

A: outdoor heat exchanger temperature

B: output frequency

C: outdoor air temperature

Conditions for Canceling Defrost

The target heat exchanger temperature as the canceling condition is selected in the range of $4^{\circ}\text{C} \leq T_e \leq 12^{\circ}\text{C}$ according to the air temperature as the following formula.

$$\text{The target heat exchanger temperature} = -(45/64) \times (\text{ambient temperature}) + 14$$

The defrost operation surely operates in 120 seconds after the start. (A→B)

After then the defrost operation stops at the following conditions.

1. When the heat exchanger temperature reaches the target heat exchanger temperature. (B→C)
2. When 650 seconds have passed after the start even if the heat exchanger temperature does not reaches the target heat exchanger temperature. (C)

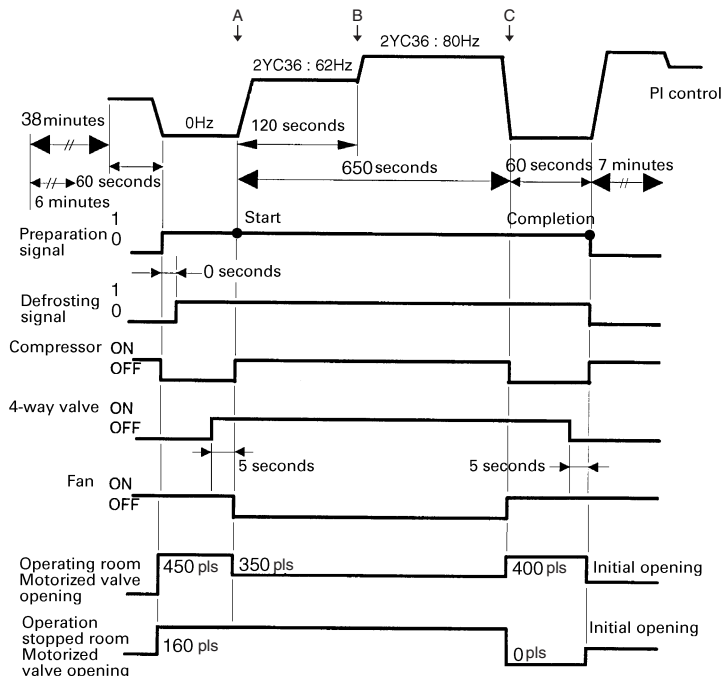

(R7127)

3.11 Electronic Expansion Valve Control

Outline

The following items are included in the electronic expansion valve control.

Electronic expansion valve is fully closed

1. Electronic expansion valve is fully closed when turning on the power.
2. Pressure equalizing control

Room Distribution Control

1. Gas pipe isothermal control (distribution control in cooling)
2. SC control (only for heat pump model, distribution control in heating)

Open Control

1. Electronic expansion valve control when starting operation
2. Control when frequency changed
3. Control for defrosting (only for heat pump model)
4. Oil recover control
5. Control when a discharge pipe temperature is abnormally high
6. Control when the discharge pipe thermistor is disconnected
7. Control for indoor unit freeze-up protection

Feedback Control

1. Discharge pipe temperature control

Distribution control for each room

1. Liquid pipe temperature control (with all ports connected and all rooms being air-conditioned)
2. Liquid pipe temperature control for stopped rooms
3. Dew prevention function for indoor rotor

Detail

The followings are the examples of control which function in each mode by the electronic expansion valve control.

Operation pattern		Gas pipe isothermal control	SC control (only for heat pump model)	Control when frequency changed	Control for abnormally high discharge pipe temperature	Oil recovery control	Indoor freeze-up protection control	Liquid pipe temperature control	Liquid pipe temperature control for stopped rooms	Dew prevention control for indoor rotor
When power is turned ON	Fully closed when power is turned ON	×	×	×	×	×	×	×	×	×
Cooling, 1 room operation	Open control when starting	×	×	×	○	○	○	×	×	×
	(Control of target discharge pipe temperature)	×	×	○	○	○	○	×	×	○
Cooling, 2 rooms operation to Cooling, 4 rooms operation	Control when the operating room is changed	×	×	×	○	○	○	×	×	○
	(Control of target discharge pipe temperature)	○	×	○	○	○	○	×	×	○
Stop	Pressure equalizing control	×	×	×	×	×	×	×	×	×
Heating, 1 room operation (only for heat pump model)	Open control when starting	×	×	×	○	×	×	×	×	×
	(Control of target discharge pipe temperature)	×	○ All rooms ×	○	○	×	×	○ All rooms ○	○ All rooms ×	×
Heating, 2 rooms operation to Heating, 4 rooms operation (only for heat pump model)	Control when the operating room is changed	×	×	×	○	×	×	×	×	×
	(Control of target discharge pipe temperature)	×	○ All rooms ×	○	○	×	×	○ All rooms ○	○ All rooms ×	×
	(Defrost control FD=1) (only for heat pump model)	×	×	×	×	×	×	×	×	×
Stop	Pressure equalizing control	×	×	×	×	×	×	×	×	×
Heating operation (only for heat pump model)	Open control when starting	×	×	×	○	×	×	×	×	×
	Control of discharge pipe thermistor disconnection	×	○ All rooms ×	×	×	×	×	○ All rooms ○	○ All rooms ×	×
Stop	Pressure equalizing control	×	×	×	×	×	×	×	×	×

(R3056)

3.11.1 Fully Closing with Power ON

Initialize the electronic expansion valve when turning on the power, set the opening position and develop pressure equalizing.

The electronic expansion valves are closed further with 720 pulse, and then opened with 150 pulse.

3.11.2 Pressure Equalization Control

When the compressor is stopped, open and close the electronic expansion valve and develop pressure equalization.

3.11.3 Opening Limit

Outline Limit a maximum and minimum opening of the electronic expansion valve in the operating room.

Detail

- ◆ A maximum electronic expansion valve opening in the operating room: 450 pulses
 - ◆ A minimum electronic expansion valve opening in the operating room: 75 pulses
- The electronic expansion valve is fully closed in the room where cooling is stopped and is opened with fixed opening during defrosting.

3.11.4 Gas Pipe Isothermal Control During Cooling

When the units are operating in multiple rooms, detect the gas piping temperature and correct the electronic expansion valve opening so that the temperature of the gas pipe in each room becomes identical.

- ◆ When the gas pipe temperature > the average gas pipe temperature,
 - open the electronic expansion valve in that room
- ◆ When the gas pipe temperature < the average gas pipe temperature,
 - close the electronic expansion valve in that room

The temperatures are monitored every 40 seconds.

3.11.5 SC Control

Outline

Heat Pump Only

Detect the temperature of liquid pipe and heat exchanger of the rooms and compensate the electronic expansion valve opening so that the SC of each room becomes the target SC.

- ◆ When the actual SC is > target SC, open the electronic expansion valve of the room.
 - ◆ When the actual SC is < target SC, close the electronic expansion valve of the room.
-

Detail

Start Functioning Conditions

After finishing the open control (660 seconds after the beginning of the operation), control all the electronic expansion valve in the operating room.

Determine Electronic Expansion Valve Opening

Adjust the electronic expansion valve so that the temperature difference between the maximum heat exchanger temperature of connected room and the temperature of liquid pipe thermistor becomes constant.

3.11.6 Starting Operation Control / Changing Operation Room

Control the electronic expansion valve opening when the system is starting or the operating room is changed, and prevent the system to be super heated or moistened.

3.11.7 Disconnection of the Discharge Pipe Thermistor

Outline

Detect a disconnected discharge pipe thermistor by comparing the discharge pipe temperature with the condensation temperature. If any is disconnected, open the electronic expansion valve according to the outdoor air temperature and the operating frequency and operate for a specified time, and then stop.

After 3 minutes of waiting, restart the unit and check if any is disconnected. If any is disconnected stop the system after operating for a specified time. If the disconnection is detected 4 times in succession, then the system will be down.

Detail

Detect Disconnection

If a 630-second timer for open control becomes over, and a 9-minute timer for the compressor operation continuation is not counting time, the following adjustment must be made.

1. When the operation mode is cooling
When the discharge pipe temperature is lower than the outdoor heat exchanger temperature, the discharge pipe thermistor disconnection must be ascertained.
2. When the operation mode is heating (only for heat pump model)
When the discharge pipe temperature is lower than the max temperature of operating room heat exchanger, the discharge pipe thermistor disconnection must be ascertained.

Adjustment when the thermistor is disconnected

When compressor stop repeats specified time, the system should be down.

3.11.8 Control when frequency is changed

When the target pipe temperature control is active, if the target frequency is changed for a specified value in a certain time period, cancel the target discharge pipe temperature control and change the opening of the target electronic expansion valve according to the shift.

3.11.9 High Temperature of the Discharge Pipe

When the compressor is operating, if the discharge pipe temperature exceeds a certain value, open the electronic expansion valve and remove the refrigerant to the low pressure side and lower discharge temperature.

3.11.10 Oil Recovery Function

Outline

The electronic expansion valve opening in the cooling stopped room must be set as to open for a certain time at a specified interval so that the oil in the cooling stopped room may not be accumulated.

Detail

During cooling operation, every 1 hour continuous operation, the electronic expansion valves in the operation stopped room must be opened by 80 pulses for specified time.

3.11.11 Target Discharge Pipe Temperature Control

Obtain the target discharge pipe temperature from the indoor and outdoor heat exchange temperature, and adjust the electronic expansion valve opening so that the actual discharge pipe temperature become close to that temperature. (Indirect SH control using the discharge pipe temperature)

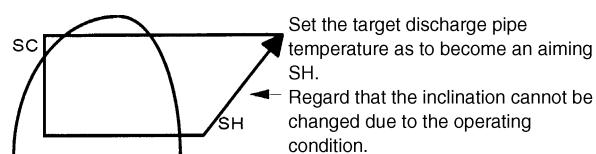

(R1389)

Determine a correction value of the electronic expansion valve compensation and drive it according to the deflection of the target discharge temperature and actual discharge temperature, and the discharge temperature variation by the 20 sec.

3.12 Malfunctions

3.12.1 Sensor Malfunction Detection

Sensor malfunction may occur either in the thermistor or current transformer (CT) system.

Relating to Thermistor Malfunction

1. Outdoor heat exchanger thermistor
2. Discharge pipe thermistor
3. Fin thermistor
4. Gas pipe thermistor
5. Outdoor air temperature thermistor
6. Liquid pipe thermistor

Relating to CT Malfunction

When the output frequency is more than 55 Hz and the input current is less than 0.5A, carry out abnormal adjustment.

3.12.2 Detection of Overload and Over Current

Outline

In order to protect the inverter, detect an excessive output current, and for protecting compressor, monitor the OL operation.

Detail

- ◆ If the OL (compressor head) temperature exceeds 120°C (2YC36), the compressor gets interrupted.

3.12.3 Insufficient Gas Control

Outline

If a power consumption is below the specified value in which the frequency is higher than the specified frequency, it must be regarded as gas insufficient.

In addition to such conventional function, if the discharge temperature is higher than the target discharge pipe temperature, and more than the specified temperature, and the electronic expansion valve is fully open (450 pulses) more than the specified time, it is considered as an insufficient gas.

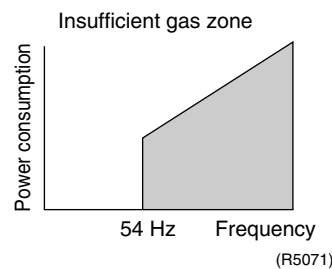

With the conventional function, a power consumption is weak comparing with that in the normal operation when gas is insufficient, and gas insufficiency is detected by checking a power consumption.

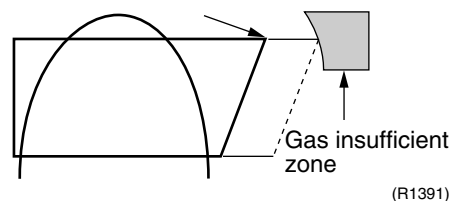

When operating with insufficient gas, although the rise of discharge pipe temperature is great and the electronic expansion valve is open, it is presumed as an insufficient gas if the discharge pipe temperature is higher than the target discharge pipe temperature.



Refer to “Insufficient Gas” on page 268 for detail.

Detail**Judgment by Input Current**

When an output frequency is exceeds 54 Hz and the input current is less than specified value, the adjustment is made for insufficient gas.

Judgment by Discharge Pipe Temperature

When discharge pipe temperature is 20°C higher than target value and the electronic expansion valve opening is 450 plus (max.), the adjustment is made for insufficient gas.

3.12.4 Preventing Indoor Freezing

During cooling, if the heat exchanger temperature in the operation stopped room becomes below the specified temperature for the specified time, open the electronic expansion valve in the operation stopped room as specified, and carry out the fully closed operation. After this, if freezing abnormality occurs more than specified time, the system shall be down as the system abnormality.

3.13 Forced Operation Mode**Outline**

Forced operating mode includes functions such as; forced cooling, forced heating, incorrect wiring, incorrect piping check.

Operating mode must be selected by operating the forced operation switch.

Detail**Forced Cooling, Forced Heating (Only for Heat Pump Model)**

Item	Forced Cooling	Forced Heating
Forced operation allowing conditions	1) The indoor unit is not abnormal, but the indoor unit which is not in the freezing prohibiting zone is present in more than 1 room.	1) The indoor unit is not abnormal. The indoor unit which is not in the peak-cut prohibited zone is present in more than 1 room.
	2) The outdoor unit is not abnormal and not in the 3-minute stand-by mode.	←
	3) The operating mode of the outdoor unit is the stop mode.	←
	4) The slide selection switch of the forced operation is the cooling mode. The forced operation is allowed when the above "and" conditions are met.	4) The slide selection switch of the forced operation is the heating mode. The forced operation is allowed when the above "and" conditions are met.
Starting / adjustment	If the forced operation switch is pressed as the above conditions are met.	←
1) Determine operating room	All rooms	One of the available units runs. Priority is given to the youngest number's room in alphabetical order. (A > B > C > D)
2) Command frequency	◆ 2YC36: 52 Hz	◆ 2YC36: 42 Hz (Outdoor air temp:0°C)
3) Electronic expansion valve opening	It depends on the capacity of the operating indoor unit.	←
4) Outdoor unit adjustment	Compressor is in operation.	←
5) Indoor unit adjustment	The command of forced operation is transmitted to the indoor unit.	←
End	1) When the forced operation switch is pressed again.	←
	2) The operation is to end automatically after 15 min.	←
Others	The protect functions are prior to all others in the forced operation.	←

3.14 Wiring-Error Check

Outline

The convenient Wiring Error Check function is designed for the microcomputer to correct wiring errors itself.

If local wiring is unclear in the case of buried piping, for example, just press the wiring error check switch that is behind the right-hand panel of the outdoor unit. Even if the connections for Room A and Room B are confused, the system may run without a hassle. Note that this check function does not work in the following cases.

- ◆ For about 30 seconds after the power is turned on (during initial setup).
- ◆ For 3-minute standby period after the compressor has stopped.
- ◆ When the outdoor air temperature is below 5°C.
- ◆ If the indoor unit is in trouble (also in case of all-room transmission failure).

When the piping and wiring are perfect, there is no need to use this function.

Operation

1. Remove the 2 screws from the service panel (right side panel) and detach the panel.
2. Press the wiring error check switch on the service monitor PCB, and the wiring error check function is activated.
3. In about 10-15 minutes, the checking will end automatically.
4. When the checking is over, the service monitor LED indicators start flashing.

LED	1	2	3	4	Judgment
Status	All flashing at once				Self-correction impossible
	Flashing one after another				Self-correction complete

Self-correction complete...The LED indicators 1 ~ 4 flash one after another.

Self-correction impossible...The LED indicators flash all at the same time.

- ◆ Transmission failure occurs at any of the indoor units.
- ◆ The indoor unit heat exchanger thermistor is disconnected.
- ◆ An indoor unit is in trouble (if a trouble occurs during the wiring error checking).

Emergency stop...Any of the LED indicators 1 ~ 4 stays on.



Note:

1. After self-correction completed, LED 3 and LED 4 are not displayed for 2 rooms, LED 4 is not displayed for 3 rooms.
2. It takes about 10-15 minutes (after pressing the wiring error check switch) to complete the checking. (Wrong wiring between the upper and lower units cannot be self-corrected.)
3. Wrongly connected liquid and gas pipes cannot be self-corrected either. Be sure to make the liquid pipe and the gas pipe in pairs.
4. To forced-terminate the wiring error check procedure halfway, press the wiring error check switch again.
In this case, the microcomputer's memory gets back to its initial status (Room A wiring → Port A piping, Room B wiring → Port B piping).
5. In replacing the outdoor unit PCB, be sure to use this function.
6. Make the power slide setting after doing the wiring error checking. (Otherwise, if the wiring is reversed, the air-conditioners being connected are set up in the reverse way.)

Basic Knowledge

- ◆ This function works in this way. Refrigerant is let flow from Port A and on. The temperatures of the indoor unit heat exchanger thermistors are detected one by one to check up the matching between the pipes and wiring.
- ◆ With this function on, freezing (crackling) noise may be heard from the indoor unit. This is not a problem. (This is because the heat exchange temperature is made to drop below 0°C in order to increase the detection accuracy.)
- ◆ The indoor fan is made to turn on and off at the same time.

Checking the current setting data on the microcomputer memory

Those data can be checked by looking at the service monitor LED indicators, when the wiring error checking is over, during forced operation, at the stop of the system. The LED indicators stop flashing when the forced operation is over.
 LED1...Room A wiring, LED2...Room B wiring
 1st flashing LED...Port A piping, 2nd flashing LED...Port B piping
 The first stay-on LED means the room that is connected with Port A. The next stay-on LED means the one connected with Port B.

Example

Let's suppose the LED indicators are flashing as follows.

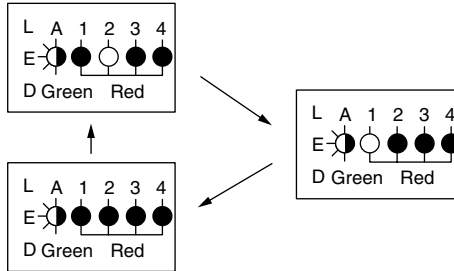

The above means that Port A is connected with Port B and Port B with Room A (or self-corrected this way.)

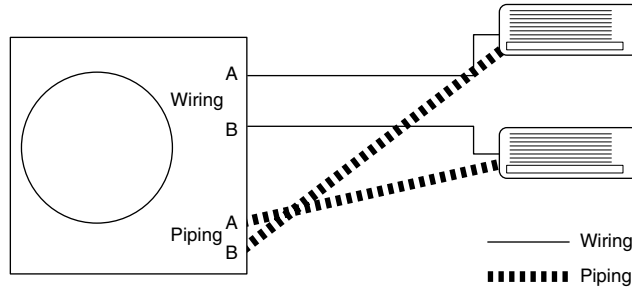

3.15 Additional Function

3.15.1 Connection Pipe Condensation Preventing Function

This control is intended to adjust the electronic expansion valve opening so that the outdoor unit gas pipe temperature (GDN) be kept below 8°C.

3.15.2 Priority Room Setting

Electronic expansion valves are controlled to provide the unit designated as the priority room with the capacity of other room units.

(Distribution of capacity: Priority room unit --- ΔD Max., other room units --- $\Delta D - \alpha$)

- ◆ Setting method
 - Turn off the circuit breaker before changing the setting.
 - Only one room can be set as the priority room.
- ◆ Control start conditions
 - Priority room setting is made.
 - AND
 - “Powerful” signal from the priority room unit is received.



Note: The operation mode of the priority room unit has precedence.

- ◆ Cancellation of control
 - The control function is canceled when the “Powerful” operation mode is switched off or 20 minutes elapse after “Powerful Operation” started.

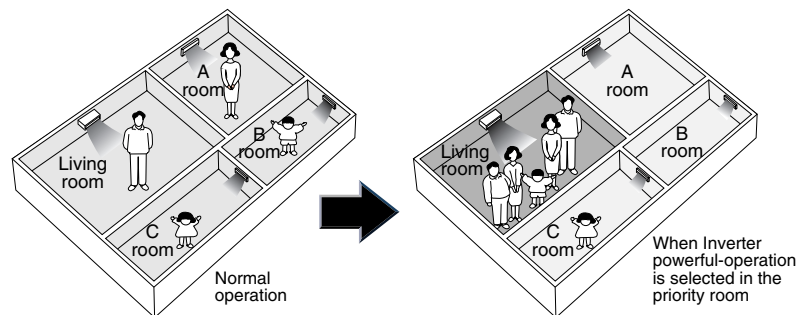

The prioritised room will be heated/cooled much more quickly

(R1396)

3.15.3 POWERFUL Operation Mode

Compressor operating frequency is increased to PI Max. (Max. Hz of operating room unit ΣS) and outdoor unit airflow rate is increased.

3.15.4 Cooling / Heating Mode Lock

Use the S15 connector to set the unit to only cool or heat.

Setting to only heat (H): Short-circuit pins 1 and 3 of the connector <S15>.

Setting to only cool (C): short-circuit pins 3 and 5 of the connector <S15>.

The following specifications apply to the connector housing and pins.

JST products Housing: VHR-5N

Pin: SVH-21T-1, 1

Note that forced operation is also possible in COOL / HEAT mode.

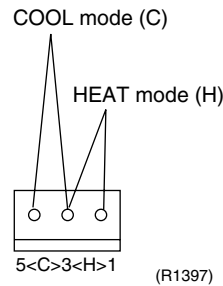

3.15.5 ECONO-mode-proof Setting

Outline

When installing in hotels, you can make ECONO mode ineffective on the outdoor unit.

Operation

The ECONO mode can be switched over between "effective" and "ineffective" by pressing the forced operation switch (SW1) and wiring error check switch (SW3) at the same time and holding them for 5 seconds while the compressor is stopped. The LEDs are lit in turn for 15 seconds to show the ECONO mode status.

The factory setting is "effective".

	effective → ineffective	ineffective → effective
LED flashing order	4 → 3 → 2 → 1	1 → 2 → 3 → 4

Part 5

Operation Manual

1. System Configuration.....	102
1.1 Operation Instructions	102
2. Instruction.....	103
2.1 FTK(X)S, FTXG, CTXG, FDK(X)S, FLK(X)S Series	103
2.2 FVXS Series.....	179
2.3 FHQ Series.....	210

1. System Configuration

1.1 Operation Instructions

After the installation and test operation of the room air conditioner have been completed, it should be operated and handled as described below. Every user would like to know the correct method of operation of the room air conditioner, to check if it is capable of cooling (or heating) well, and to know a clever method of using it.

In order to meet this expectation of the users, giving sufficient explanations taking enough time can be said to reduce about 80% of the requests for servicing. However good the installation work is and however good the functions are, the customer may blame either the room air conditioner or its installation work because of improper handling. The installation work and handing over of the unit can only be considered to have been completed when its handling has been explained to the user without using technical terms but giving full knowledge of the equipment.

2. Instruction

2.1 FTK(X)S, FTXG, CTXG, FDK(X)S, FLK(X)S Series

2.1.1 Manual Contents and Reference Page

Model Series	Wall Mounted Type			
	FTK(X)S20/25/35/50D	FTK(X)S20/25/35C	FTK(X)S50F	FTXG25/35E CTXG50E
Read before Operation				
Safety Precautions	104	104	104	104
Names of Parts	106	109	112	115
Preparation before Operation ★	124	124	124	124
Operation				
AUTO, DRY, COOL, HEAT, FAN Operation ★	127	127	127	127
Adjusting the Air Flow Direction	129	131	133	135
POWERFUL Operation ★	139	139	139	139
OUTDOOR UNIT QUIET Operation ★	140	140	140	140
ECONO Operation	141	—	—	—
HOME LEAVE Operation ★	—	142	142	—
INTELLIGENT EYE Operation	144	146	148	150
TIMER Operation ★	152	152	152	152
Note for Multi System	154	154	154	154
Care				
Care and Cleaning	156	159	162	165
Trouble Shooting				
Trouble Shooting	175	175	175	175
Drawing No.	3P194516-2B	3P194444-1B	3P190111-1B	C : 3P166453-1C



Model Series	Duct Connected Type		Floor/Ceiling Suspended Dual Type
	FDK(X)S25/35C	FDK(X)S50C FDK(X)S25/35E	FLK(X)S25/35/50B
Read before Operation			
Safety Precautions	104	104	104
Names of Parts	118	118	121
Preparation before Operation ★	124	124	124
Operation			
AUTO, DRY, COOL, HEAT, FAN Operation ★	127	127	127
Adjusting the Air Flow Direction	—	—	137
POWERFUL Operation ★	139	139	139
OUTDOOR UNIT QUIET Operation ★	140	140	140
ECONO Operation	—	—	—
HOME LEAVE Operation ★	142	142	142
INTELLIGENT EYE Operation	—	—	—
TIMER Operation ★	152	152	152
Note for Multi System	154	154	154
Care			
Care and Cleaning	168	170	172
Trouble Shooting			
Trouble Shooting	175	175	175
Drawing No.	3P196326-8B	3P196326-9B	3P194444-5B

★ : Illustrations are for wall mounted type FTK(X)S50F as representative.

2.1.2 Safety Precautions

Safety precautions

- Keep this manual where the operator can easily find them.
- Read this manual attentively before starting up the unit.
- For safety reason the operator must read the following cautions carefully.
- This manual classifies precautions into WARNING and CAUTION. Be sure to follow all precautions below: they are all important for ensuring safety.

 WARNING If you do not follow these instructions exactly, the unit may cause property damage, personal injury or loss of life.	 CAUTION If you do not follow these instructions exactly, the unit may cause minor or moderate property damage or personal injury.
---	--



Never do.



Be sure to earth the air conditioner.



Never touch the air conditioner (including the remote controller) with a wet hand.



Be sure to follow the instructions.



Never cause the air conditioner (including the remote controller) to get wet.





WARNING

- In order to avoid fire, explosion or injury, do not operate the unit when harmful, among which flammable or corrosive gases, are detected near the unit. 
- It is not good for health to expose your body to the air flow for a long time.
- Do not put a finger, a rod or other objects into the air outlet or inlet. As the fan is rotating at a high speed, it will cause injury.
- Do not attempt to repair, relocate, modify or reinstall the air conditioner by yourself. Incorrect work will cause electric shocks, fire etc.
For repairs and reinstallation, consult your Daikin dealer for advice and information.

- The refrigerant used in the air conditioner is safe. Although leaks should not occur, if for some reason any refrigerant happens to leak into the room, make sure it does not come in contact with any flame as of gas heaters, kerosene heaters or gas range. 
- If the air conditioner is not cooling (heating) properly, the refrigerant may be leaking, so call your dealer. When carrying out repairs accompanying adding refrigerant, check the content of the repairs with our service staff.
- Do not attempt to install the air conditioner by your self. Incorrect work will result in water leakage, electric shocks or fire. For installation, consult the dealer or a qualified technician.
- In order to avoid electric shock, fire or injury, if you detect any abnormally such as smell of fire, stop the operation and turn off the breaker. And call your dealer for instructions.



CAUTION

- The air conditioner must be earthed. Incomplete earthing may result in electric shocks. Do not connect the earth line to a gas pipe, water pipe, lightning rod, or a telephone earth line. 
- In order to avoid any quality deterioration, do not use the unit for cooling precision instruments, food, plants, animals or works of art. 
- Never expose little children, plants or animals directly to the air flow.
- Do not place appliances which produce open fire in places exposed to the air flow from the unit or under the indoor unit. It may cause incomplete combustion or deformation of the unit due to the heat.
- Do not block air inlets nor outlets. Impaired air flow may result in insufficient performance or trouble.

- Do not stand or sit on the outdoor unit. Do not place any object on the unit to avoid injury, do not remove the fan guard.
- Do not place anything under the indoor or outdoor unit that must be kept away from moisture. In certain conditions, moisture in the air may condense and drip.
- After a long use, check the unit stand and fittings for damage.
- Do not touch the air inlet and aluminum fins of outdoor unit. It may cause injury.
- The appliance is not intended for use by young children or infirm persons without supervision.
- Young children should be supervised to ensure that they do not play with the appliance.

- To avoid oxygen deficiency, ventilate the room sufficiently if equipment with burner is used together with the air conditioner. 
- Before cleaning, be sure to stop the operation, turn the breaker off or pull out the supply cord.
- Do not connect the air conditioner to a power supply different from the one as specified. It may cause trouble or fire.
- Depending on the environment, an earth leakage breaker must be installed. Lack of an earth leakage breaker may result in electric shocks.
- Arrange the drain hose to ensure smooth drainage. Incomplete draining may cause wetting of the building, furniture etc.
- Do not place objects in direct proximity of the outdoor unit and do not let leaves and other debris accumulate around the unit.
Leaves are a hotbed for small animals which can enter the unit. Once in the unit, such animals can cause malfunctions, smoke or fire when making contact with electrical parts.

- Do not operate the air conditioner with wet hands. 

- Do not wash the indoor unit with excessive water, only use a slightly wet cloth.
- Do not place things such as vessels containing water or anything else on top of the unit. Water may penetrate into the unit and degrade electrical insulations, resulting in an electric shock. 

Installation site

- To install the air conditioner in the following types of environments, consult the dealer.
 - Places with an oily ambient or where steam or soot occurs.
 - Salty environment such as coastal areas.
 - Places where sulfide gas occurs such as hot springs.
 - Places where snow may block the outdoor unit.

The drain from the outdoor unit must be discharged to a place of good drainage.

Consider nuisance to your neighbours from noises

- For installation, choose a place as described below.
 - A place solid enough to bear the weight of the unit which does not amplify the operation noise or vibration.
 - A place from where the air discharged from the outdoor unit or the operation noise will not annoy your neighbours.

Electrical work

- For power supply, be sure to use a separate power circuit dedicated to the air conditioner.

System relocation

- Relocating the air conditioner requires specialized knowledge and skills. Please consult the dealer if relocation is necessary for moving or remodeling.

2.1.3 Names of Parts

FTK(X)S 20/25/35/50 D

Names of parts

■ Indoor Unit

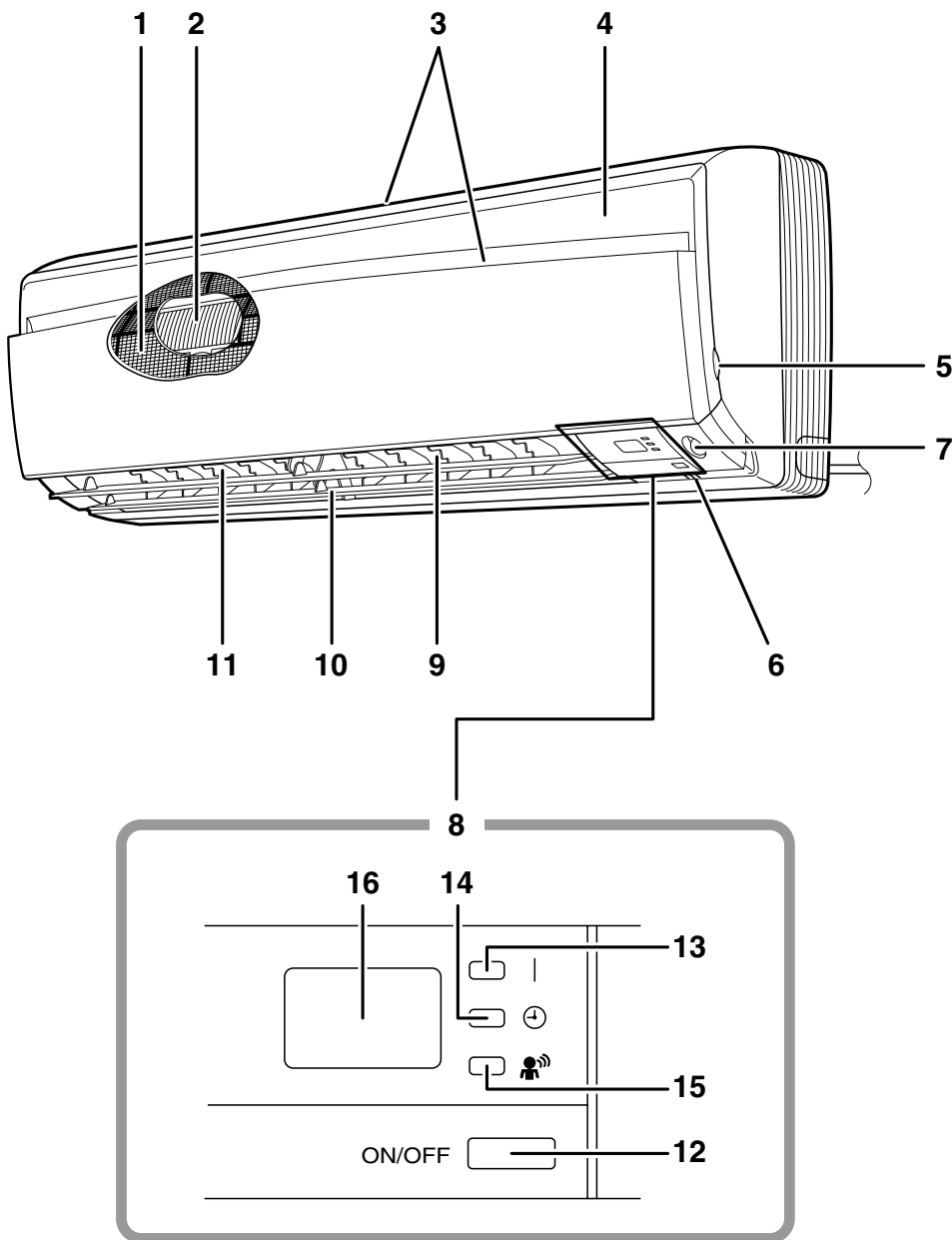

■ Outdoor Unit

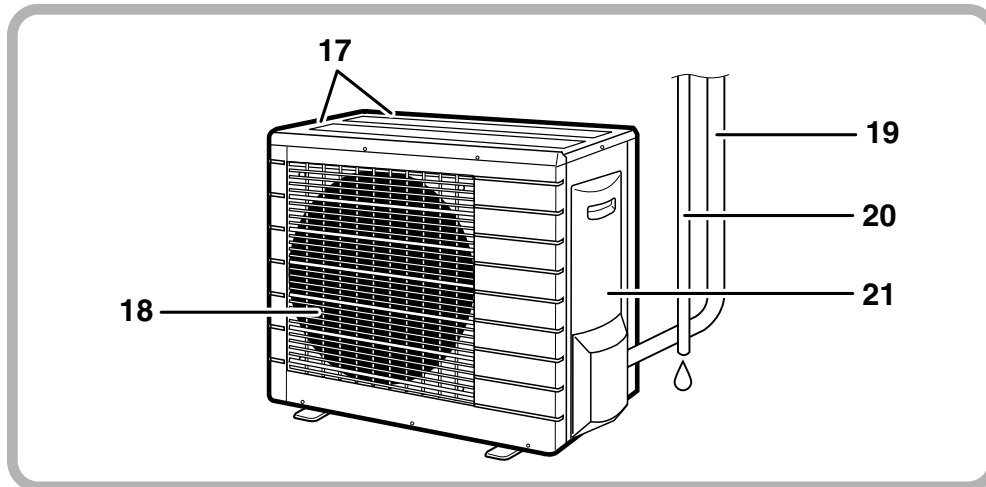

■ Indoor Unit

1. Air filter
2. Titanium Apatite Photocatalytic Air-Purifying Filter:
 - These filters are attached to the inside of the air filters.
3. Air inlet
4. Front panel
5. Panel tab
6. Room temperature sensor:
 - It senses the air temperature around the unit.
7. INTELLIGENT EYE sensor:
 - It detects the movements of people and automatically switches between normal operation and energy saving operation.
8. Display
9. Air outlet
10. Flaps (horizontal blades)
11. Louvers (vertical blades):
 - The louvers are inside of the air outlet.

12. Indoor Unit ON/OFF switch:

- Push this switch once to start operation. Push once again to stop it.
- The operation mode refers to the following table.

	Mode	Temperature setting	Air flow rate
F(C)TKS	COOL	22°C	AUTO
F(C)TXS	AUTO	25°C	AUTO

- This switch is useful when the remote controller is missing.

13. Operation lamp (green)

14. TIMER lamp (yellow)

15. INTELLIGENT EYE lamp (green)

16. Signal receiver:

- It receives signals from the remote controller.
- When the unit receives a signal, you will hear a short beep.
 - Operation startbeep-beep
 - Settings changed.....beep
 - Operation stopbeeeep

■ Outdoor Unit

17. Air inlet: (Back and side)
18. Air outlet
19. Refrigerant piping and inter-unit cable
20. Drain hose
21. Earth terminal:
 - It is inside of this cover.

Appearance of the outdoor unit may differ from some models.

■ Remote Controller

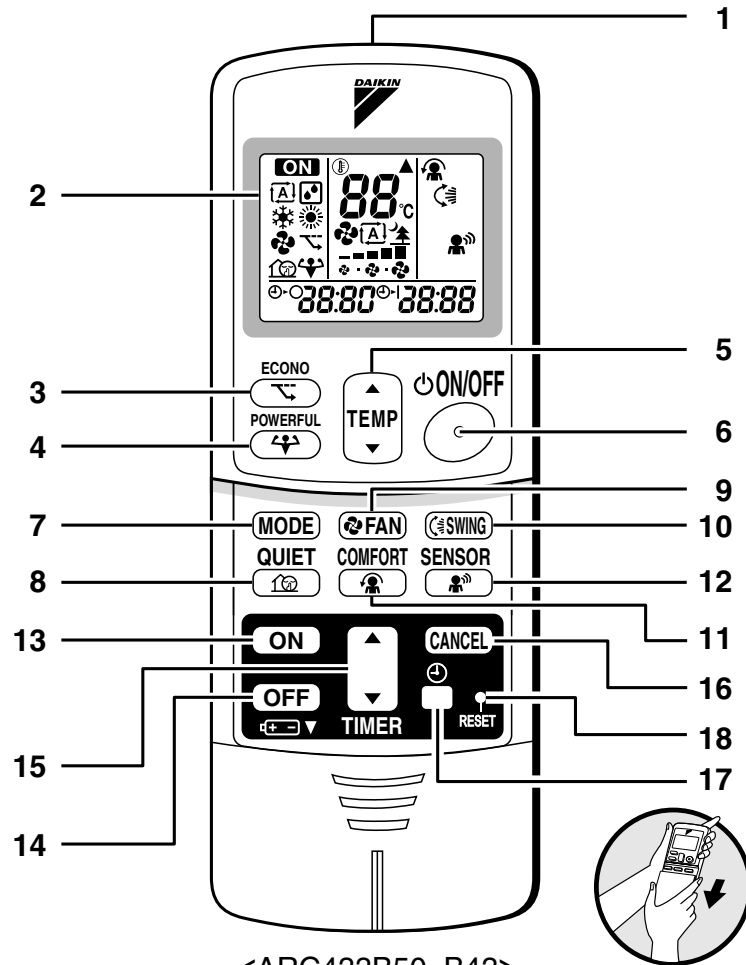

<ARC433B50, B43>

- | | |
|--|--|
| <p>1. Signal transmitter:</p> <ul style="list-style-type: none"> • It sends signals to the indoor unit. <p>2. Display:</p> <ul style="list-style-type: none"> • It displays the current settings.
(In this illustration, each section is shown with all its displays ON for the purpose of explanation.) <p>3. ECONO button:
ECONO operation</p> <p>4. POWERFUL button:
POWERFUL operation</p> <p>5. TEMPERATURE adjustment buttons:</p> <ul style="list-style-type: none"> • It changes the temperature setting. <p>6. ON/OFF button:</p> <ul style="list-style-type: none"> • Press this button once to start operation.
Press once again to stop it. <p>7. MODE selector button:</p> <ul style="list-style-type: none"> • It selects the operation mode.
(AUTO/DRY/COOL/HEAT/FAN) | <p>8. QUIET button: OUTDOOR UNIT QUIET operation</p> <p>9. FAN setting button:</p> <ul style="list-style-type: none"> • It selects the air flow rate setting. <p>10. SWING button:</p> <ul style="list-style-type: none"> • Adjusting the Air Flow Direction. <p>11. COMFORT AIRFLOW button: COMFORT AIRFLOW operation</p> <p>12. SENSOR button: INTELLIGENT EYE operation</p> <p>13. ON TIMER button</p> <p>14. OFF TIMER button</p> <p>15. TIMER Setting button:</p> <ul style="list-style-type: none"> • It changes the time setting. <p>16. TIMER CANCEL button:</p> <ul style="list-style-type: none"> • It cancels the timer setting. <p>17. CLOCK button</p> <p>18. RESET button:</p> <ul style="list-style-type: none"> • Restart the unit if it freezes.
• Use a thin object to push. |
|--|--|

FTK(X)S 20/25/35 C

Names of parts

■ Indoor Unit

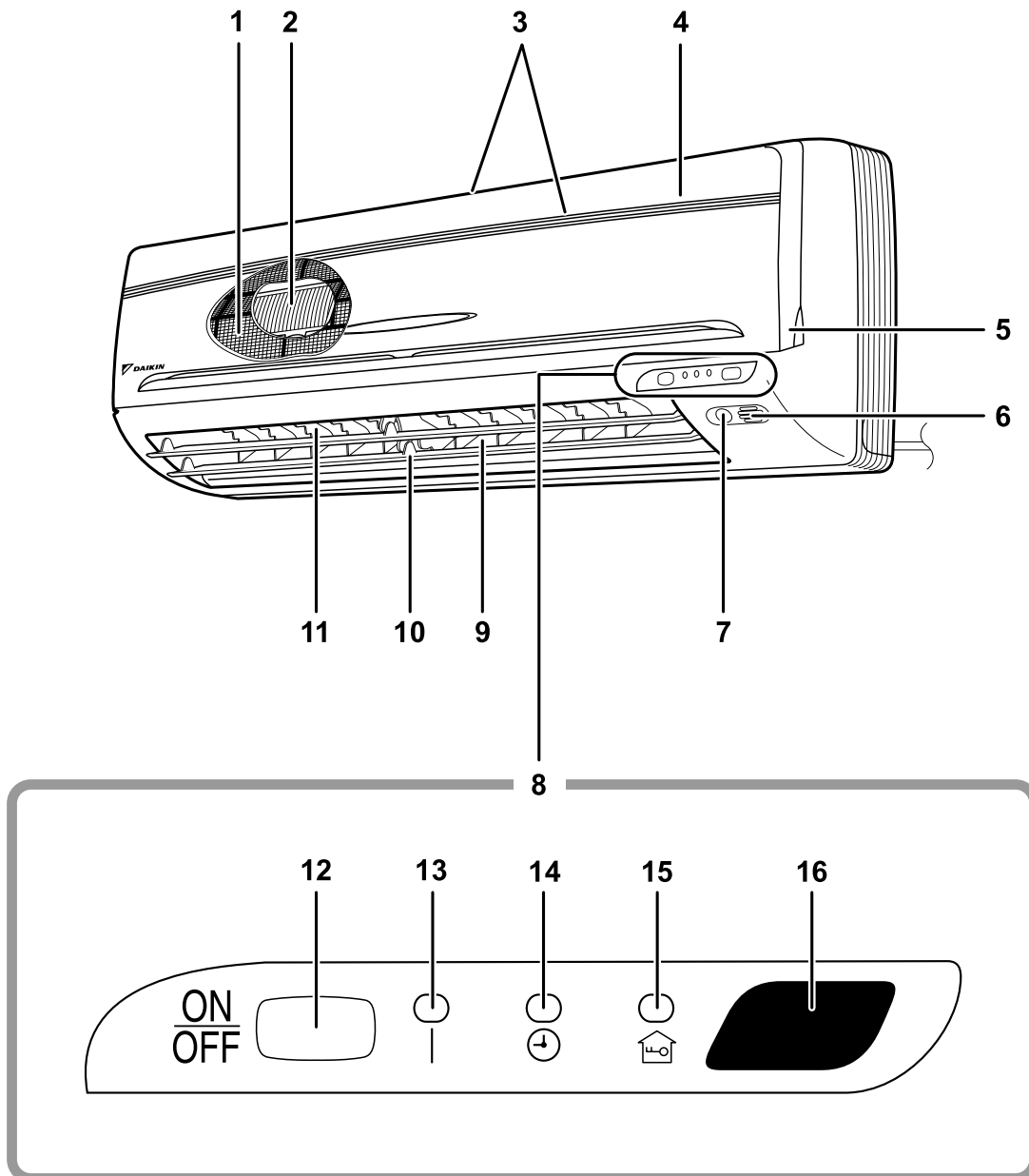

■ Outdoor Unit

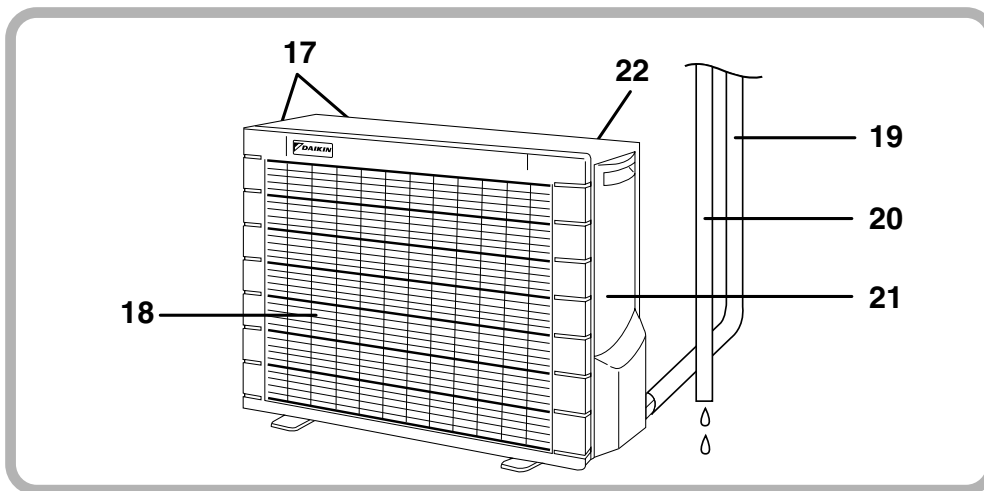

■ Indoor Unit

1. Air filter
2. Air purifying filter with photocatalytic deodorizing function:
 - These filters are attached to the inside of the air filters.
3. Air inlet
4. Front panel
5. Panel tab
6. Room temperature sensor:
 - It senses the air temperature around the unit.
7. INTELLIGENT EYE sensor:
 - It detects the movements of people and automatically switches between normal operation and energy saving operation.
8. Display
9. Air outlet
10. Flaps (horizontal blades)
11. Louvers (vertical blades):
 - The louvers are inside of the air outlet.

12. Indoor Unit ON/OFF switch:
 - Push this switch once to start operation. Push once again to stop it.
 - The operation mode refers to the following table.

	Mode	Temperature setting	Air flow rate
FTKS	COOL	22°C	AUTO
FTXS	AUTO	25°C	AUTO

- This switch is useful when the remote controller is missing.
13. Operation lamp (green)
 14. TIMER lamp (yellow)
 15. HOME LEAVE lamp (red)
 16. Signal receiver:
 - It receives signals from the remote controller.
 - When the unit receives a signal, you will hear a short beep.
 - Operation startbeep-beep
 - Settings changed.....beep
 - Operation stopbeeeeeep

■ Outdoor Unit

17. Air inlet: (Back and side)
18. Air outlet
19. Refrigerant piping and inter-unit cable
20. Drain hose
21. Earth terminal:
 - It is inside of this cover.
22. Outside air temperature sensor: (Back side)
 - It senses the ambient temperature around the unit.

Appearance of the outdoor unit may differ from some models.

■ Remote Controller

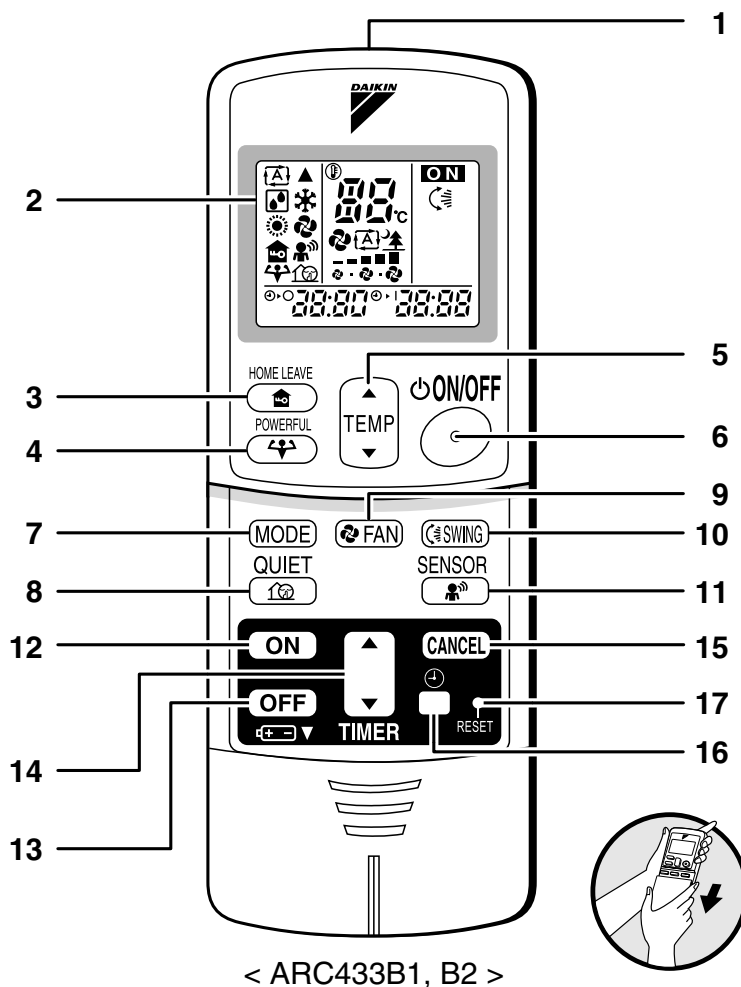

1. Signal transmitter:

- It sends signals to the indoor unit.

2. Display:

- It displays the current settings.
(In this illustration, each section is shown with all its displays ON for the purpose of explanation.)

3. HOME LEAVE button:

- HOME LEAVE operation

4. POWERFUL button:

- POWERFUL operation

5. TEMPERATURE adjustment buttons:

- It changes the temperature setting.

6. ON/OFF button:

- Press this button once to start operation.
Press once again to stop it.

7. MODE selector button:

- It selects the operation mode.

(AUTO/DRY/COOL/HEAT/FAN)

8. QUIET button: OUTDOOR UNIT QUIET operation

9. FAN setting button:

- It selects the air flow rate setting.

10. SWING button

11. SENSOR button: INTELLIGENT EYE operation

12. ON TIMER button

13. OFF TIMER button

14. TIMER Setting button:

- It changes the time setting.

15. TIMER CANCEL button:

- It cancels the timer setting.

16. CLOCK button

17. RESET button:

- Restart the unit if it freezes.
• Use a thin object to push.

FTK(X)S 50 F

Names of parts

■ Indoor Unit

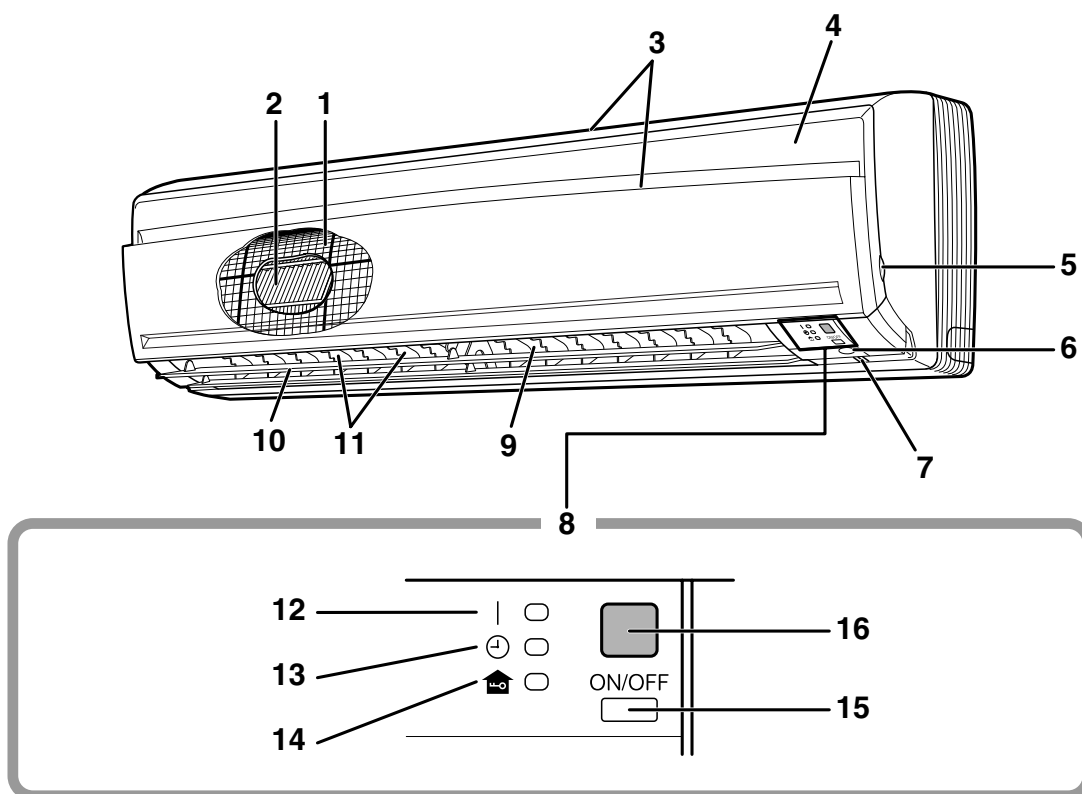

■ Outdoor Unit

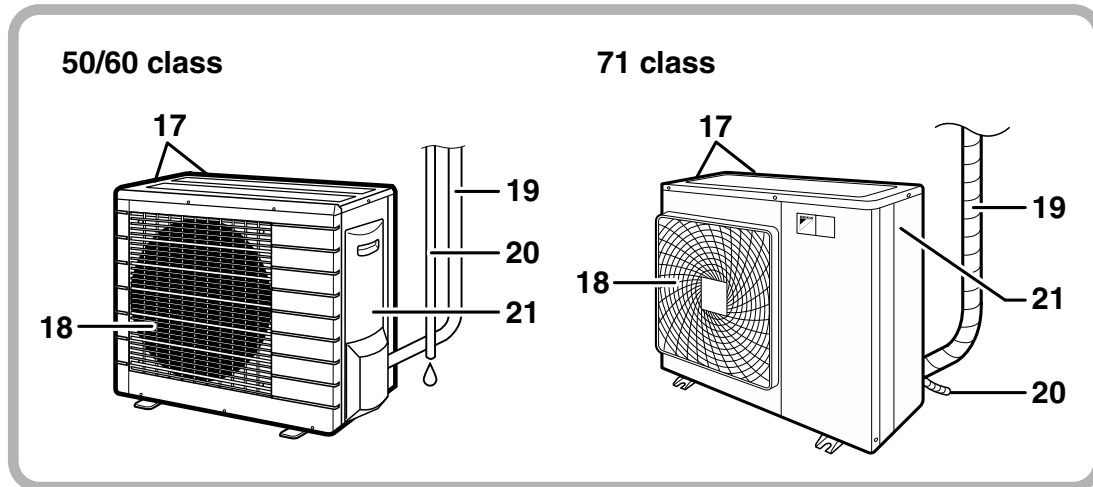

■ Indoor Unit

1. Air filter
2. Titanium Apatite Photocatalytic Air-Purifying Filter
3. Air inlet
4. Front panel
5. Panel tab
6. INTELLIGENT EYE sensor:
 - It detects the movements of people and automatically switches between normal operation and energy saving operation.
7. Room temperature sensor:
 - It senses the air temperature around the unit.
8. Display
9. Air outlet
10. Flap (horizontal blade)
11. Louvers (vertical blades):
 - The Louvers are inside of the air outlet.
12. Operation lamp (green)
13. TIMER lamp (yellow)

14. HOME LEAVE lamp (red):

- Lights up when you use HOME LEAVE Operation.

15. Indoor Unit ON/OFF switch:

- Push this switch once to start operation. Push once again to stop it.
- The operation mode refer to the following table.

	Mode	Temperature setting	Air flow rate
FTKS	COOL	22°C	AUTO
FTXS	AUTO	25°C	AUTO

- This switch is useful when the remote controller is missing.

16. Signal receiver:

- It receives signals from the remote controller.
- When the unit receives a signal, you will hear a short beep.
 - Operation startbeep-beep
 - Settings changed.....beep
 - Operation stopbeeeep

■ Outdoor Unit

17. Air inlet: (Back and side)
18. Air outlet
19. Refrigerant piping and inter-unit cable
20. Drain hose
21. Earth terminal:
 - It is inside of this cover.

Appearance of the outdoor unit may differ from some models.

■ Remote Controller

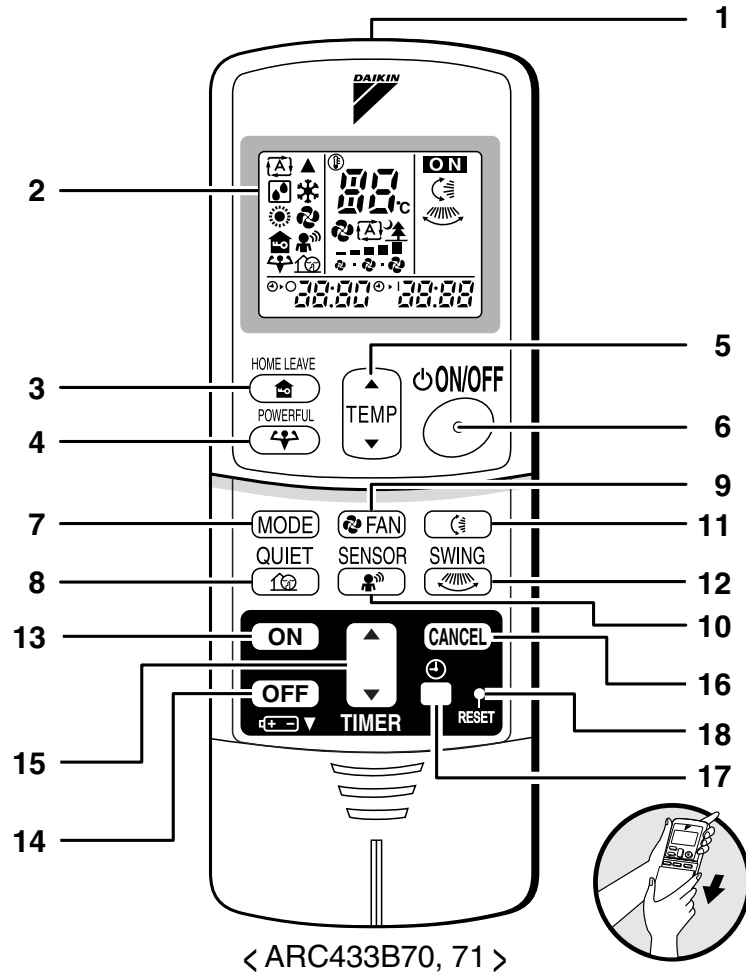

- | | |
|--|--|
| <p>1. Signal transmitter:</p> <ul style="list-style-type: none"> • It sends signals to the indoor unit. <p>2. Display:</p> <ul style="list-style-type: none"> • It displays the current settings.
(In this illustration, each section is shown with all its displays ON for the purpose of explanation.) <p>3. HOME LEAVE button:
HOME LEAVE operation</p> <p>4. POWERFUL button:
POWERFUL operation</p> <p>5. TEMPERATURE adjustment buttons:</p> <ul style="list-style-type: none"> • It changes the temperature setting. <p>6. ON/OFF button:</p> <ul style="list-style-type: none"> • Press this button once to start operation.
Press once again to stop it. <p>7. MODE selector button:</p> <ul style="list-style-type: none"> • It selects the operation mode.
(AUTO/DRY/COOL/HEAT/FAN) | <p>8. QUIET button: OUTDOOR UNIT QUIET operation</p> <p>9. FAN setting button:</p> <ul style="list-style-type: none"> • It selects the air flow rate setting. <p>10. SENSOR button: INTELLIGENT EYE operation</p> <p>11. SWING button:</p> <ul style="list-style-type: none"> • Flap (Horizontal blade) <p>12. SWING button:</p> <ul style="list-style-type: none"> • Louver (Vertical blades) <p>13. ON TIMER button</p> <p>14. OFF TIMER button</p> <p>15. TIMER Setting button:</p> <ul style="list-style-type: none"> • It changes the time setting. <p>16. TIMER CANCEL button:</p> <ul style="list-style-type: none"> • It cancels the timer setting. <p>17. CLOCK button</p> <p>18. RESET button:</p> <ul style="list-style-type: none"> • Restart the unit if it freezes. • Use a thin object to push. |
|--|--|

FTXG 25/35 E, CTXG 50 E

Names of parts

■ Indoor Unit

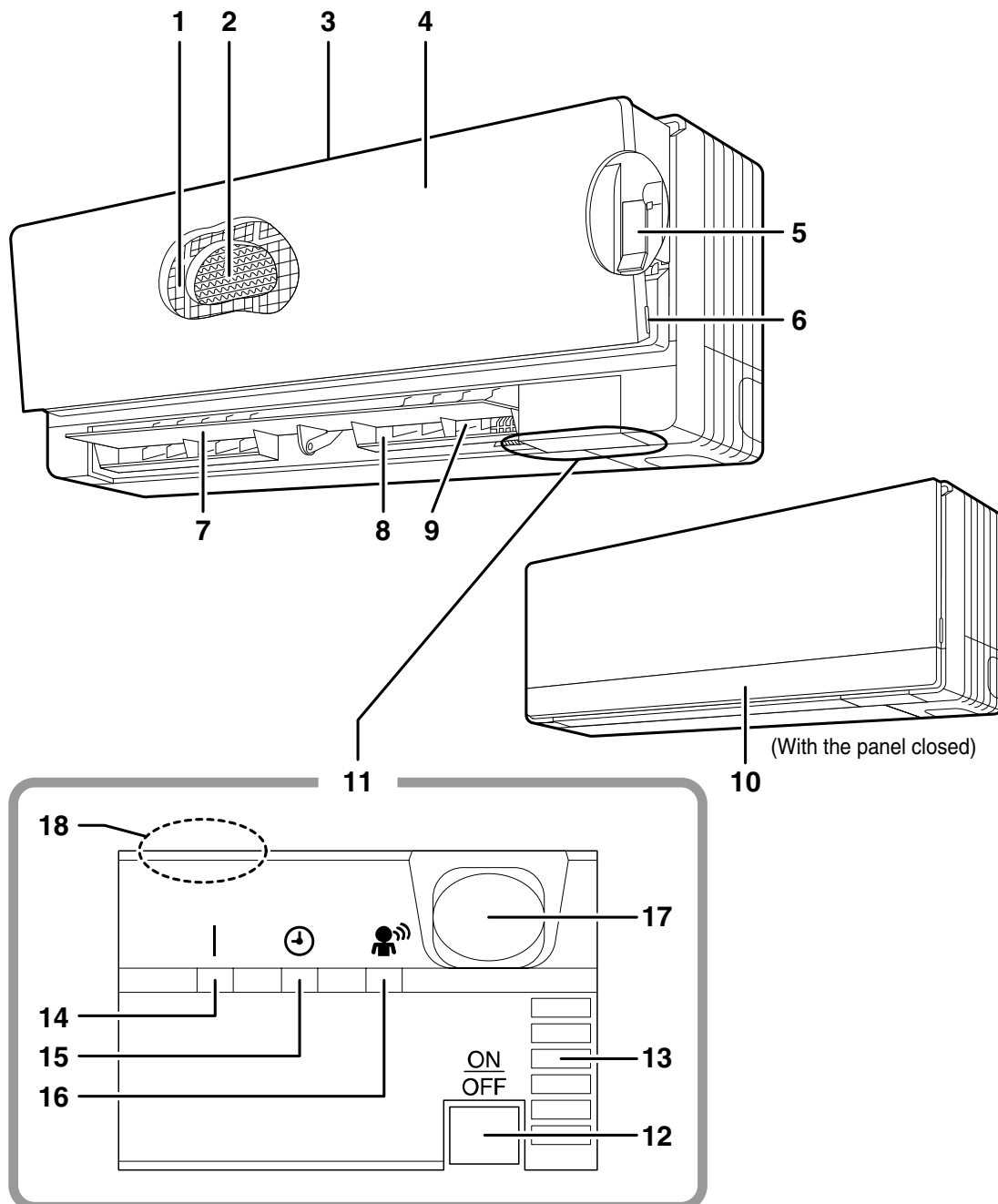

■ Outdoor Unit

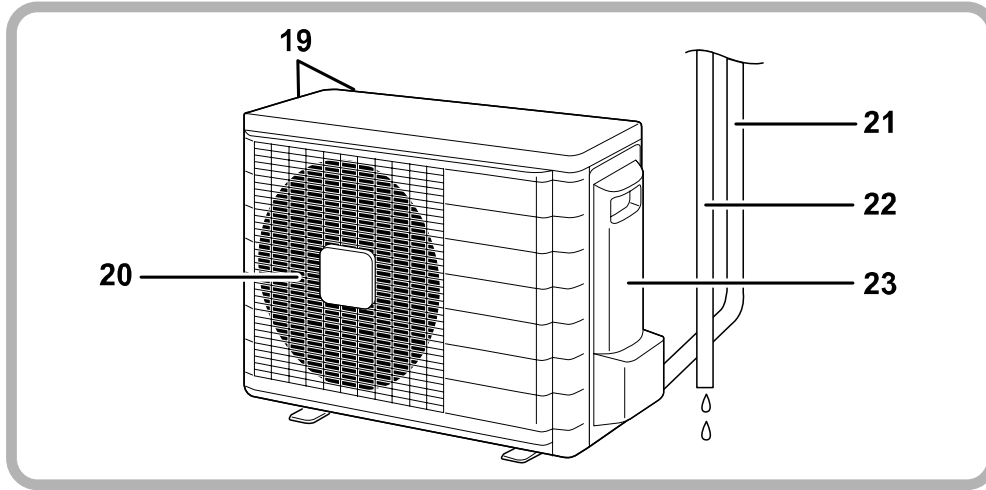

■ Indoor Unit

1. Air filter
2. Titanium Apatite Photocatalytic Air-Purifying Filter:
 - These filters are attached to the inside of the air filters.
3. Air inlet
4. Front panel
5. Supporting plate:
 - The supporting plate is used to support the front panel during maintenance.
6. Panel tab
7. Flap (horizontal blade)
8. Air outlet
9. Louvers (vertical blades):
 - The louvers are inside of the air outlet.
10. Outlet vent panel
11. Display
12. Indoor Unit ON/OFF switch:
 - Push this switch once to start operation. Push once again to stop it.

- The operation mode refers to the following table.

	Mode	Temperature setting	Air flow rate
F(C)TXG	AUTO	25°C	AUTO

- This switch is useful when the remote controller is missing.
13. Room temperature sensor:
 - It senses the air temperature around the unit.
 14. Operation lamp (green)
 15. TIMER lamp (yellow)
 16. INTELLIGENT EYE lamp (green)
 17. INTELLIGENT EYE sensor:
 - It detects the movements of people and automatically switches between normal operation and energy saving operation.
 18. Signal receiver:
 - It receives signals from the remote controller.
 - When the unit receives a signal, you will hear a short beep.
 - Operation startbeep-beep
 - Settings changed.....beep
 - Operation stopbeeeeeeep

■ Outdoor Unit

19. Air inlet: (Back and side)
20. Air outlet
21. Refrigerant piping and inter-unit cable
22. Drain hose
23. Earth terminal:
 - It is inside of this cover.

Appearance of the outdoor unit may differ from some models.

■ Remote Controller

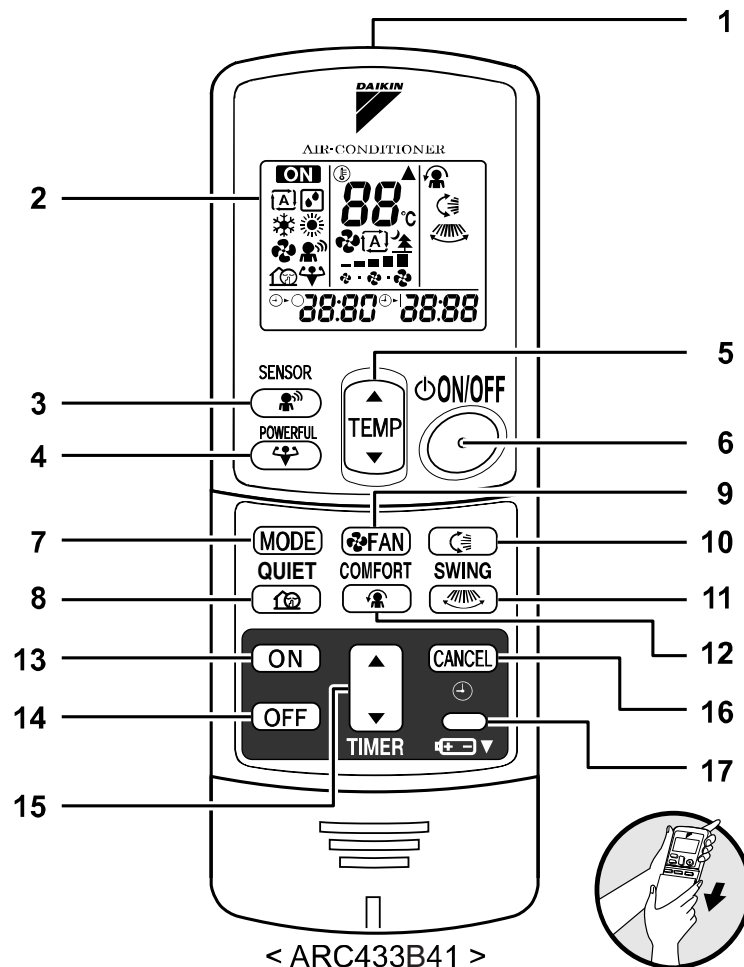

- 1. Signal transmitter:**
 - It sends signals to the indoor unit.
- 2. Display:**
 - It displays the current settings.
(In this illustration, each section is shown with all its displays ON for the purpose of explanation.)
- 3. SENSOR button:** INTELLIGENT EYE operation
- 4. POWERFUL button:** POWERFUL operation
- 5. TEMPERATURE adjustment buttons:**
 - It changes the temperature setting.
- 6. ON/OFF button:**
 - Press this button once to start operation.
Press once again to stop it.
- 7. MODE selector button:**
 - It selects the operation mode.
(AUTO/DRY/COOL/HEAT/FAN)
- 8. SILENT button:** OUTDOOR UNIT SILENT operation
- 9. FAN setting button:**
 - It selects the air flow rate setting.
- 10. SWING button:**
 - Flap (Horizontal blade)
- 11. SWING button:**
 - Louvers (Vertical blades)
- 12. COMFORT AIRFLOW mode button:**
- 13. ON TIMER button**
- 14. OFF TIMER button**
- 15. TIMER Setting button:**
 - It changes the time setting.
- 16. TIMER CANCEL button:**
 - It cancels the timer setting.
- 17. CLOCK button**

FDK(X)S 25/35/50 C, FDK(X)S 25/35 E

Names of parts

■ Indoor Unit

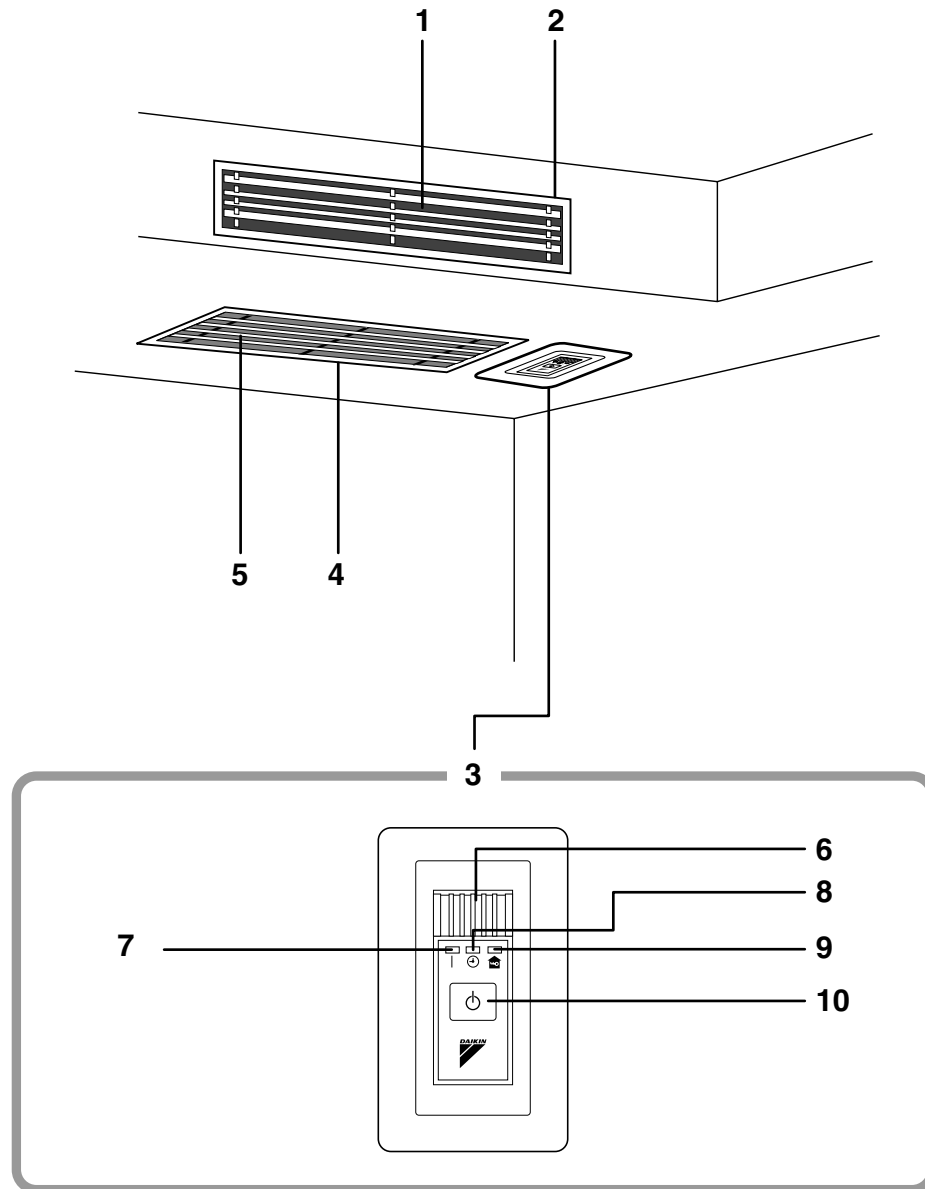

■ Outdoor Unit

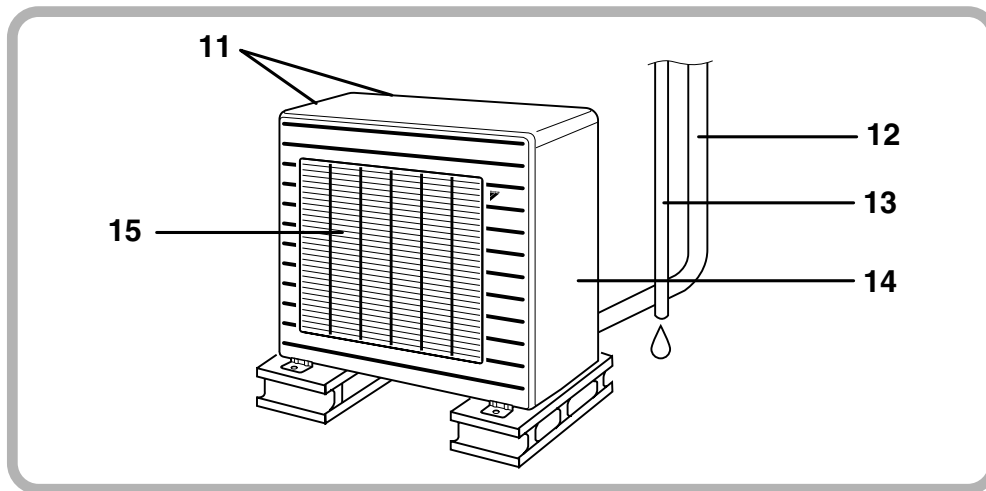

■ Indoor Unit

1. Air outlet

2. Air outlet grille: (Field supply)

- Appearance of the Air outlet grille and Air inlet grille may differ with some models.

3. Display, Control panel

4. Suction grille: (Option)

- Appearance of the suction grille and Air inlet grille may differ with some models.

5. Air inlet

6. Room temperature sensor:

- It senses the air temperature around the unit.

7. Operation lamp (green)

8. TIMER lamp (yellow)

9. HOME LEAVE lamp (red):

- Lights up when you use HOME LEAVE operation.

10. Indoor Unit ON/OFF switch:

- Push this switch once to start operation. Push once again to stop it.
- This switch is useful when the remote controller is missing.

- The operation mode refers to the following table.

	Mode	Temperature setting	Air flow rate
F(C)DKS	COOL	22°C	AUTO
F(C)DXS	AUTO	25°C	AUTO

■ Outdoor Unit

11. Air inlet: (Back and side)

12. Refrigerant piping and inter-unit cable

13. Drain hose

Appearance of the outdoor unit may differ from some models.

14. Earth terminal:

- It is inside of this cover.

15. Air outlet

■ Remote Controller

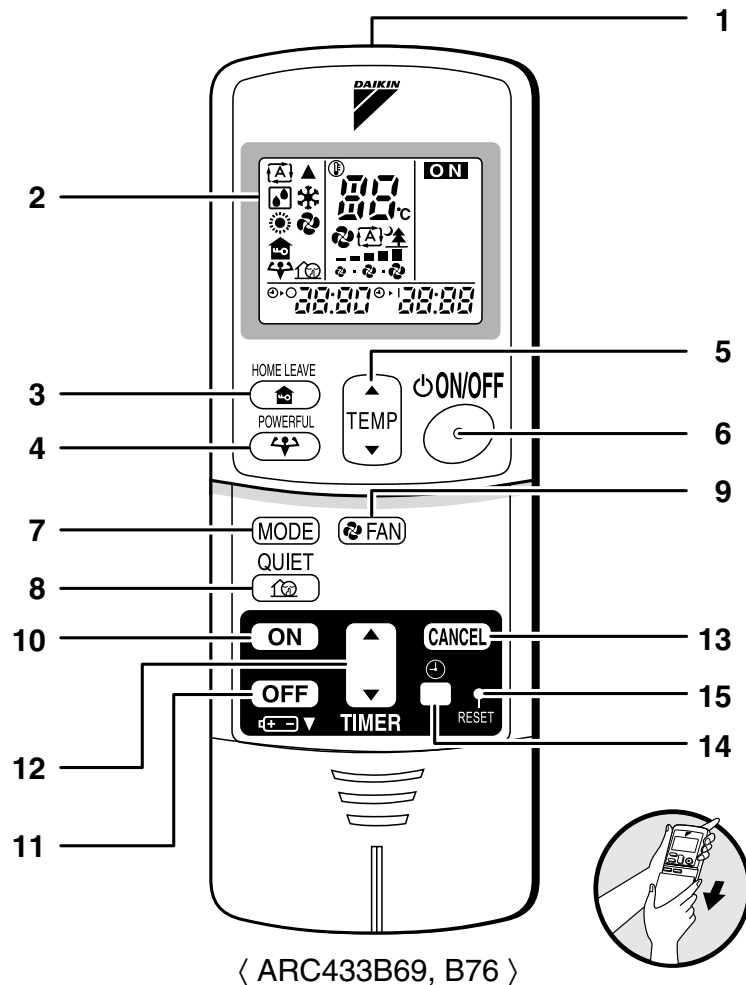

〈 ARC433B69, B76 〉

1. Signal transmitter:

- It sends signals to the indoor unit.

2. Display:

- It displays the current settings.
(In this illustration, each section is shown with all its displays ON for the purpose of explanation.)

3. HOME LEAVE button:

HOME LEAVE operation

4. POWERFUL button:

POWERFUL operation

5. TEMPERATURE adjustment buttons:

- It changes the temperature setting.

6. ON/OFF button:

- Press this button once to start operation.
Press once again to stop it.

7. MODE selector button:

- It selects the operation mode.
(AUTO/DRY/COOL/HEAT/FAN)

8. QUIET button: OUTDOOR UNIT QUIET operation

9. FAN setting button:

- It selects the air flow rate setting.

10. ON TIMER button

11. OFF TIMER button

12. TIMER Setting button:

- It changes the time setting.

13. TIMER CANCEL button:

- It cancels the timer setting.

14. CLOCK button

15. RESET button:

- Restart the unit if it freezes.
- Use a thin object to push.

FLK(X)S 25/35/50 B

Names of parts

■ Indoor Unit

The indoor unit can be installed either to the ceiling or to a wall. The descriptions contained in this manual show the case when installation is being carried out to the ceiling. (The methods of operation used are the same when installing to a wall.)

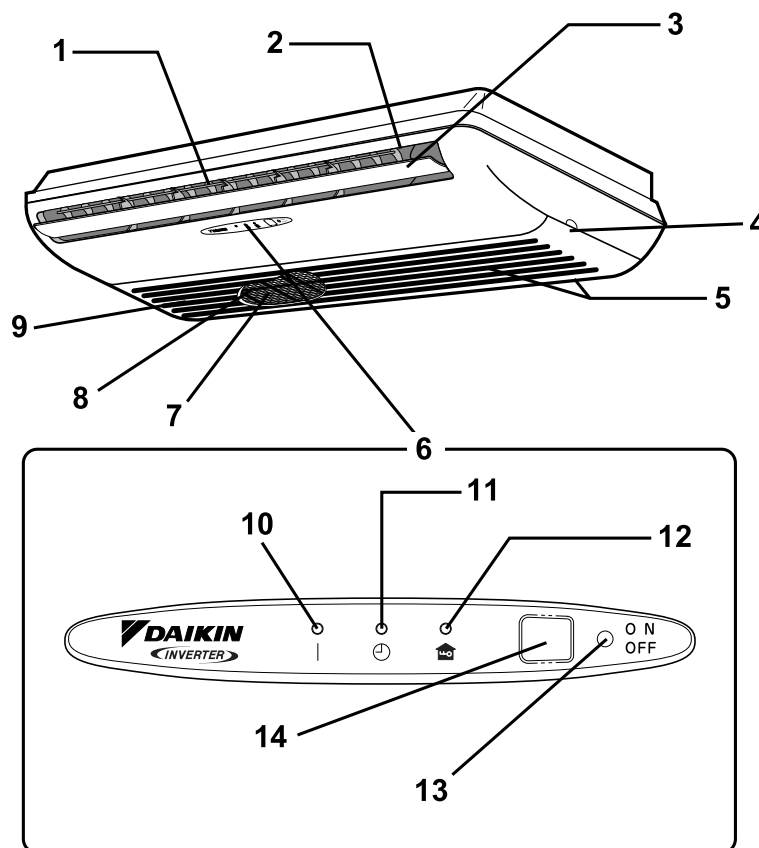

■ Opening the front panel

How to open the front panel

⚠ CAUTION

- Before opening the front panel, be sure to stop the operation and turn the breaker OFF.

■ Outdoor Unit

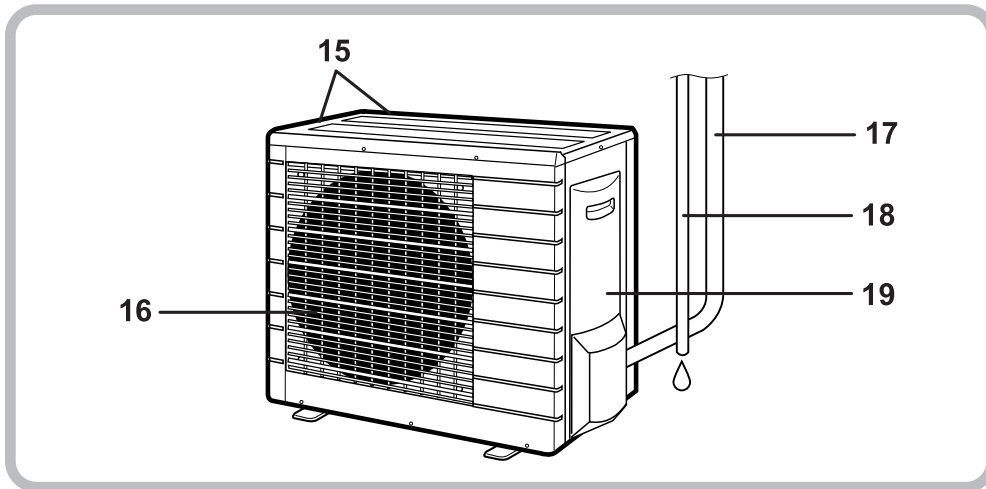

■ Indoor Unit

1. **Louvers (vertical blades):**
The louvers are inside of the air outlet.
2. **Air outlet**
3. **Flap (horizontal blade)**
4. **Panel tab**
5. **Air inlet**
6. **Display**
7. **Air filter**
8. **Photocatalytic deodorizing filter or Air purifying filter:**
 - These filters are attached to the inside of the air filters.
9. **Front panel**
10. **Operation lamp (green)**
11. **TIMER lamp (yellow)**
12. **HOME LEAVE lamp (red):**
Lights up when you use HOME LEAVE Operation.

13. Indoor unit ON/OFF switch:

- Push this switch once to start operation. Push once again to stop it.
- The operation mode refers to the following table.

	Mode	Temperature setting	Air flow rate
FLKS	COOL	22°C	AUTO
FLXS	AUTO	25°C	AUTO

- Push the switch using an object with a sharp tip, such as a pen.
- This switch is useful when the remote controller is missing.

14. Signal receiver:

- It receives signals from the remote controller.
- When the unit receives a signal, you will hear a short beep.
 - Operation startbeep-beep
 - Settings changed.....beep
 - Operation stopbeeeep

■ Outdoor Unit

15. **Air inlet:** (Back and side)
16. **Air outlet**
17. **Refrigerant piping and inter-unit cable**
18. **Drain hose**
19. **Earth terminal:**
 - It is inside of this cover.

Appearance of the outdoor unit may differ from some models.

■ Remote Controller

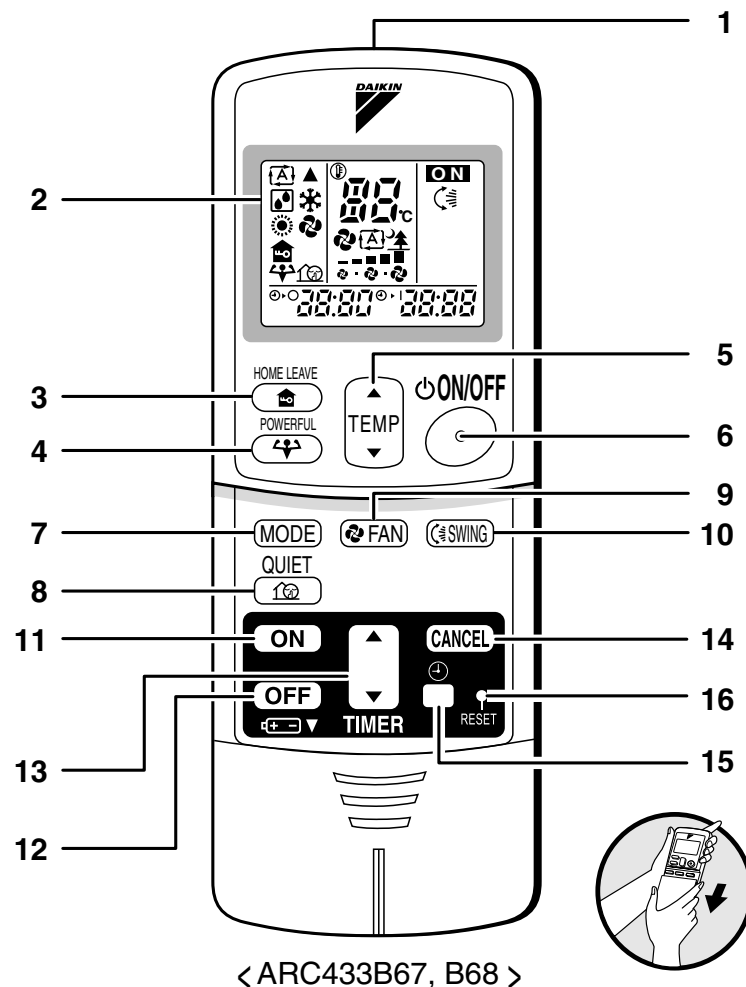

- 1. Signal transmitter:**
 - It sends signals to the indoor unit.
- 2. Display:**
 - It displays the current settings.
(In this illustration, each section is shown with all its displays ON for the purpose of explanation.)
- 3. HOME LEAVE button:**
HOME LEAVE operation
- 4. POWERFUL button:**
POWERFUL operation
- 5. TEMPERATURE adjustment buttons:**
 - It changes the temperature setting.
- 6. ON/OFF button:**
 - Press this button once to start operation.
Press once again to stop it.
- 7. MODE selector button:**
 - It selects the operation mode.
(AUTO/DRY/COOL/HEAT/FAN)
- 8. QUIET button:** OUTDOOR UNIT QUIET operation
- 9. FAN setting button:**
 - It selects the air flow rate setting.
- 10. SWING button**
- 11. ON TIMER button**
- 12. OFF TIMER button**
- 13. TIMER Setting button:**
 - It changes the time setting.
- 14. TIMER CANCEL button:**
 - It cancels the timer setting.
- 15. CLOCK button**
- 16. RESET button:**
 - Restart the unit if it freezes.
 - Use a thin object to push.

2.1.4 Preparation Before Operation

Preparation Before Operation

■ To set the batteries

1. Slide the front cover to take it off.
2. Set two dry batteries (AAA).
3. Set the front cover as before.

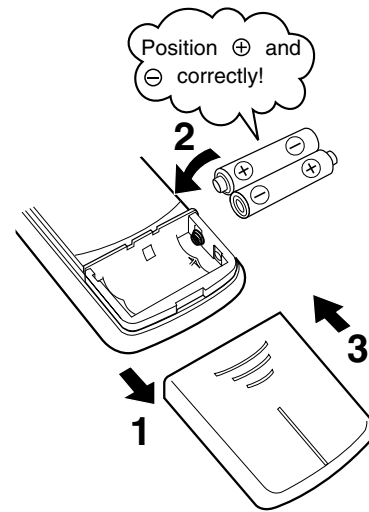

ATTENTION

■ About batteries

- When replacing the batteries, use batteries of the same type, and replace the two old batteries together.
- When the system is not used for a long time, take the batteries out.
- We recommend replacing once a year, although if the remote controller display begins to fade or if reception deteriorates, please replace with new alkali batteries. Using manganese batteries reduces the lifespan.
- The attached batteries are provided for the initial use of the system.
The usable period of the batteries may be short depending on the manufactured date of the air conditioner.

Preparation Before Operation

■ To operate the remote controller

- To use the remote controller, aim the transmitter at the indoor unit. If there is anything to block signals between the unit and the remote controller, such as a curtain, the unit will not operate.
- Do not drop the remote controller. Do not get it wet.
- The maximum distance for communication is about 7m.

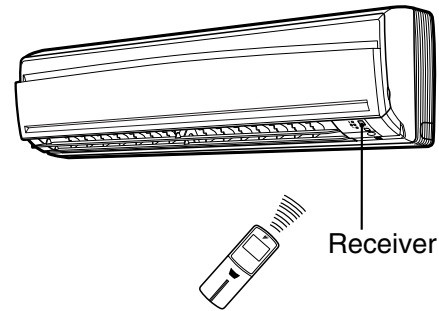

■ To fix the remote controller holder on the wall

1. Choose a place from where the signals reach the unit.
2. Fix the holder to a wall, a pillar, or similar location with the screws procured locally.
3. Place the remote controller in the remote controller holder.

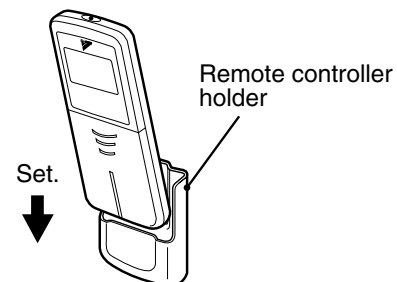

- To remove, pull it upwards.

ATTENTION

■ About remote controller

- Never expose the remote controller to direct sunlight.
- Dust on the signal transmitter or receiver will reduce the sensitivity. Wipe off dust with soft cloth.
- Signal communication may be disabled if an electronic-starter-type fluorescent lamp (such as inverter-type lamps) is in the room. Consult the shop if that is the case.
- If the remote controller signals happen to operate another appliance, move that appliance to somewhere else, or consult the shop.

■ To set the clock

1. Press “CLOCK button”.

0:00 is displayed.

⌚ blinks.

2. Press “TIMER setting button” to set the clock to the present time.

Holding down “▲” or “▼” button rapidly increases or decreases the time display.

3. Press “CLOCK button”.

⌚ blinks.

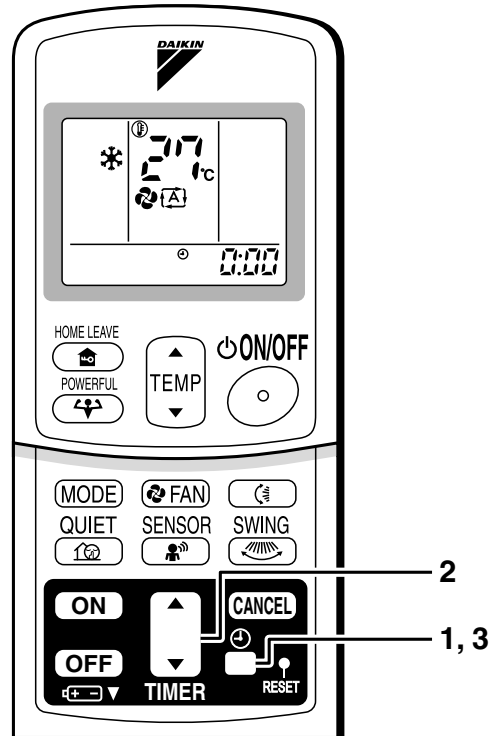

■ Turn the breaker ON

- Turning ON the breaker opens the flap, then closes it again. (This is a normal procedure.)

NOTE

■ Tips for saving energy

- Be careful not to cool (heat) the room too much. Keeping the temperature setting at a moderate level helps save energy.
- Cover windows with a blind or a curtain. Blocking sunlight and air from outdoors increases the cooling (heating) effect.
- Clogged air filters cause inefficient operation and waste energy. Clean them once in about every two weeks.

Recommended temperature setting

For cooling: 26°C – 28°C
For heating: 20°C – 24°C

■ Please note

- The air conditioner always consumes 15-35 watts of electricity even while it is not operating.
- If you are not going to use the air conditioner for a long period, for example in spring or autumn, turn the breaker OFF.
- Use the air conditioner in the following conditions.

Mode	Operating conditions	If operation is continued out of this range
COOL	Outdoor temperature: (2/3/MXS) –10 to 46°C (4/5MK(X)S) –10 to 46°C (RK(X)S) –10 to 46°C Indoor temperature: 18 to 32°C Indoor humidity: 80% max.	<ul style="list-style-type: none"> • A safety device may work to stop the operation. (In multi system, it may work to stop the operation of the outdoor unit only.) • Condensation may occur on the indoor unit and drip.
HEAT	Outdoor temperature: (2/3/4/5MXS) –15 to 15.5°C (RXS) –15 to 18°C Indoor temperature: 10 to 30°C	<ul style="list-style-type: none"> • A safety device may work to stop the operation.
DRY	Outdoor temperature: (2/3/MXS) –10 to 46°C (4/5MK(X)S) –10 to 46°C (RK(X)S) –10 to 46°C Indoor temperature: 18 to 32°C Indoor humidity: 80% max.	<ul style="list-style-type: none"> • A safety device may work to stop the operation. • Condensation may occur on the indoor unit and drip.

- Operation outside this humidity or temperature range may cause a safety device to disable the system.

2.1.5 AUTO • DRY • COOL • HEAT • FAN Operation

AUTO • DRY • COOL • HEAT • FAN Operation

The air conditioner operates with the operation mode of your choice.

From the next time on, the air conditioner will operate with the same operation mode.

■ To start operation

1. Press “MODE selector button” and select a operation mode.

- Each pressing of the button advances the mode setting in sequence.

- Ⓐ: AUTO
- ☐: DRY
- ❄: COOL
- ☀: HEAT
- 🌀: FAN

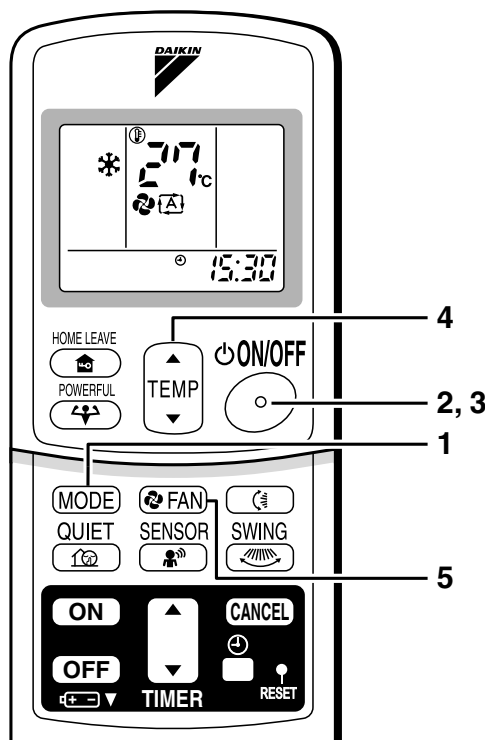
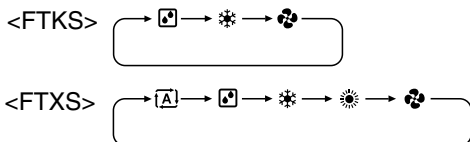

2. Press “ON/OFF button”.

- The OPERATION lamp lights up.

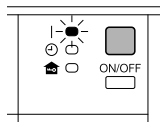

■ To stop operation

3. Press “ON/OFF button” again.

- Then OPERATION lamp goes off.





■ To change the temperature setting

4. Press “TEMPERATURE adjustment button”.

DRY or FAN mode	AUTO or COOL or HEAT mode
The temperature setting is not variable.	Press “▲” to raise the temperature and press “▼” to lower the temperature.
	Set to the temperature you like. 

■ To change the air flow rate setting

5. Press “FAN setting button”.

DRY mode	AUTO or HEAT or COOL or FAN mode
The air flow rate setting is not variable.	Five levels of air flow rate setting from “  ” to “  ” plus “  ” “  ” are available. 

- Indoor unit quiet operation

When the air flow is set to “”, the noise from the indoor unit will become quieter. Use this when making the noise quieter.

The unit might lose capacity when the air flow rate is set to a weak level.

NOTE

■ Note on HEAT operation

- Since this air conditioner heats the room by taking heat from outdoor air to indoors, the heating capacity becomes smaller in lower outdoor temperatures. If the heating effect is insufficient, it is recommended to use another heating appliance in combination with the air conditioner.
- The heat pump system heats the room by circulating hot air around all parts of the room. After the start of heating operation, it takes some time before the room gets warmer.
- In heating operation, frost may occur on the outdoor unit and lower the heating capacity. In that case, the system switches into defrosting operation to take away the frost.
- During defrosting operation, hot air does not flow out of indoor unit.

■ Note on COOL operation

- This air conditioner cools the room by blowing the hot air in the room outside, so if the outside temperature is high, performance drops.

■ Note on DRY operation

- The computer chip works to rid the room of humidity while maintaining the temperature as much as possible. It automatically controls temperature and fan strength, so manual adjustment of these functions is unavailable.

■ Note on AUTO operation

- In AUTO operation, the system selects a temperature setting and an appropriate operation mode (COOL or HEAT) based on the room temperature at the start of the operation.
- The system automatically reselects setting at a regular interval to bring the room temperature to user-setting level.
- If you do not like AUTO operation, you can manually select the operation mode and setting you like.

■ Note on air flow rate setting

- At smaller air flow rates, the cooling (heating) effect is also smaller.

2.1.6 Adjusting the Air Flow Direction

FTK(X)S 20/25/35/50 D

Adjusting the Air Flow Direction

You can adjust the air flow direction to increase your comfort.

■ To adjust the horizontal blades (flaps)

1. Press “SWING button”.

- “” is displayed on the LCD and the flaps will begin to swing.

2. When the flaps have reached the desired position, press “SWING button” once more.

- The flap will stop moving.
- “” disappears from the LCD.

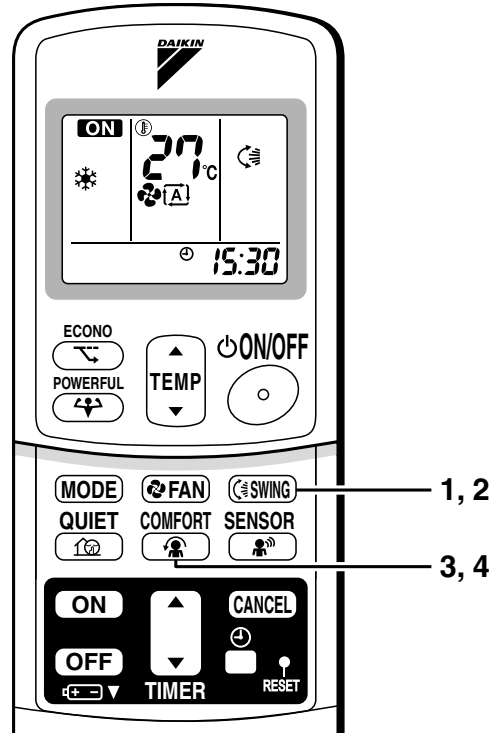

■ To adjust the vertical blades (louvers)

Hold the knob and move the louvers.

(You will find a knob on the left-side and the right-side blades.)

- When the unit is installed in the corner of a room, the direction of the louvers should be facing away from the wall.
If they face the wall, the wall will block off the wind, causing the cooling (or heating) efficiency to drop.

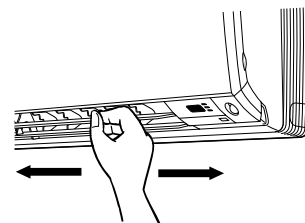

■ To start COMFORT AIRFLOW operation

3. Press “COMFORT AIRFLOW button”.

- The flap position will change, preventing air from blowing directly on the occupants of the room.
 - “” is displayed on the LCD.
- 〈COOL/DRY〉 The flap will go up.
 〈HEAT〉 The flap will go down.

■ To cancel COMFORT AIRFLOW operation

4. Press “COMFORT AIRFLOW button” again.

- The flaps will return to the memory position from before COMFORT AIRFLOW mode.
- “” disappears from the LCD.

Notes on COMFORT AIRFLOW operation

- POWERFUL operation and COMFORT AIRFLOW operation cannot be used at the same time. Priority is given to POWERFUL operation.

Notes on flaps and louvers angles

- When “**SWING button**” is selected, the flaps swinging range depends on the operation mode. (See the figure.)

■ ATTENTION

- Always use a remote controller to adjust the flaps angle. If you attempt to move it forcibly with hand when it is swinging, the mechanism may be broken.
- Be careful when adjusting the louvers. Inside the air outlet, a fan is rotating at a high speed.

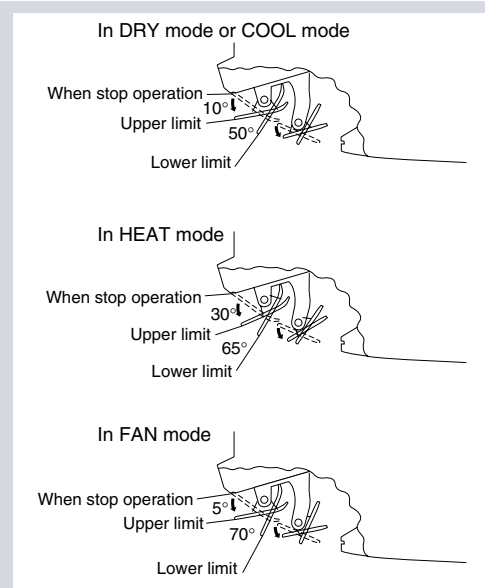

FTK(X)S 20/25/35 C

Adjusting the Air Flow Direction

You can adjust the air flow direction to increase your comfort.

■ To adjust the horizontal blades (flaps)

1. Press “SWING button”.

- “” is displayed on the LCD and the flaps will begin to swing.

2. When the flaps have reached the desired position, press “SWING button” once more.

- The flap will stop moving.
- “” disappears from the LCD.

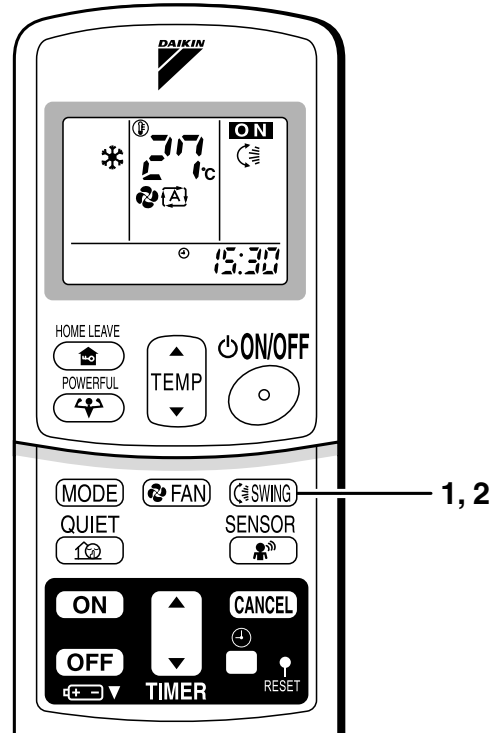

■ To adjust the vertical blades (louvers)

Hold the knob and move the louvers.

(You will find a knob on the left-side and the right-side blades.)

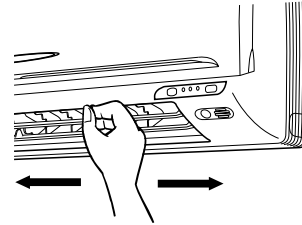

Notes on flaps and louvers angles.

- When “ **SWING button** ” is selected, the flaps swinging range depends on the operation mode. (See the figure.)

■ ATTENTION

- Always use a remote controller to adjust the flaps angle. If you attempt to move it forcibly with hand when it is swinging, the mechanism may be broken.
- Be careful when adjusting the louvers. Inside the air outlet, a fan is rotating at a high speed.

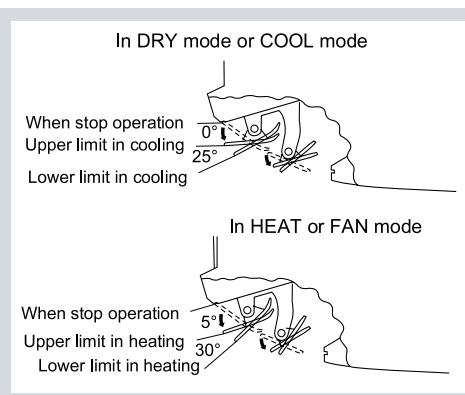





FTK(X)S 50 F

Adjusting the Air Flow Direction



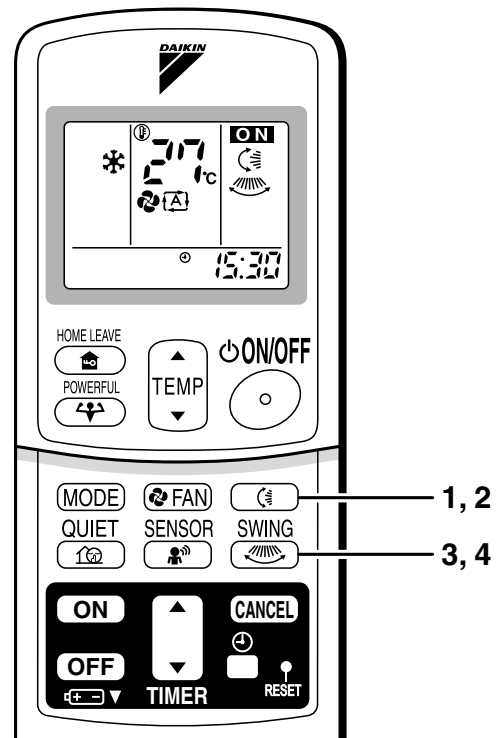

You can adjust the air flow direction to increase your comfort.

■ To adjust the horizontal blade (flap)





1. Press “SWING button ”.
 - “” is displayed on the LCD and the flaps will begin to swing.
2. When the flap has reached the desired position, press “SWING button ” once more.
 - The flap will stop moving.
 - “” disappears from the LCD.



■ To adjust the vertical blades (louvers)

3. Press “SWING button ”.
 - “” is displayed on the LCD.
4. When the louvers have reached the desired position, press the “SWING button ” once more.
 - The louvers will stop moving.
 - “” disappears from the LCD.

■ **To 3-D Airflow**

1. 3. Press the “SWING button ” and the “SWING button ”:
the “” and “” display will light up and the flap and louvers will move in turn.

■ **To cancel 3-D Airflow**

2. 4. Press either the “SWING button ” or the “SWING button ”.

Notes on louvers angles

- **ATTENTION**
 - Always use a remote controller to adjust the louvers angles. In side the air outlet, a fan is rotating at a high speed.

Notes on flap angle

- When “SWING button” is selected, the flaps swinging range depends on the operation mode. (See the figure.)

Three-Dimensional (3-D) Airflow

- Using three-dimensional airflow circulates cold air, which tends to collected at the bottom of the room, and hot air, which tends to collect near the ceiling, throughout the room, preventing areas of cold and hot developing.

- **ATTENTION**
 - Always use a remote controller to adjust the flaps angle. If you attempt to move it forcibly with hand when it is swinging, the mechanism may be broken.
 - Be careful when adjusting the louvers. Inside the air outlet, fan is rotating at a high speed.

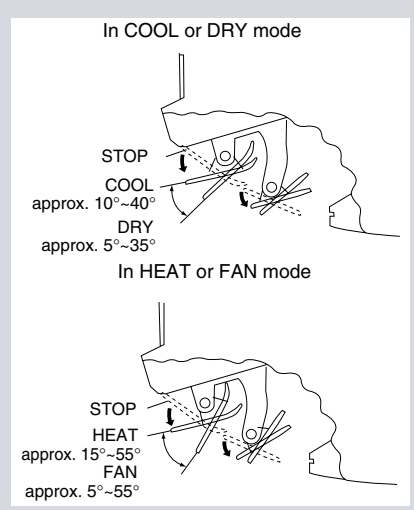





FTXG 25/35 E, CTXG 50 E

Adjusting the Air Flow Direction



You can adjust the air flow direction to increase your comfort.

■ To adjust the horizontal blade (flap)

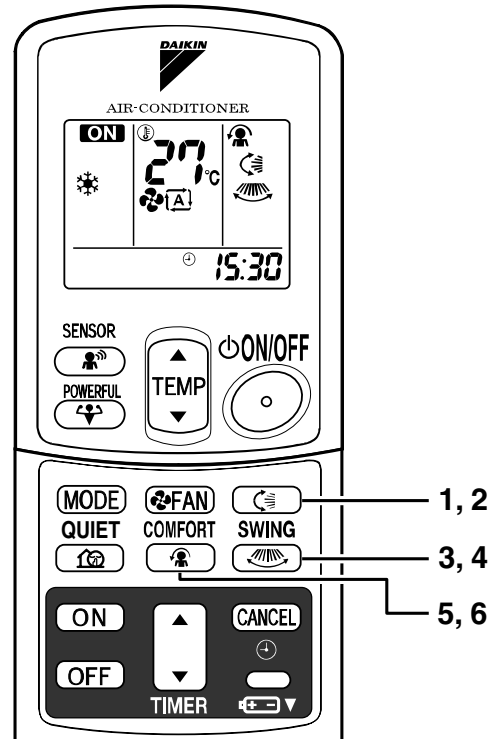



1. Press “SWING button ”.
 - “” is displayed on the LCD.
2. When the flap has reached the desired position, press “SWING button ” once more.
 - The flap will stop moving.
 - “” disappears from the LCD.



■ To adjust the vertical blades (louvers)

3. Press “SWING button ”.
 - “” is displayed on the LCD.
4. When the louvers have reached the desired position, press the “SWING button ” once more.
 - The louvers will stop moving.

■ To 3-D Airflow

1. 3. Press the “SWING button ” and the “SWING button ”:
the “” and “” display will light up and the flap and louvers will move in turn.

■ To cancel 3-D Airflow

2. 4. Press either the “SWING button ” or the “SWING button ”.

■ To start COMFORT AIRFLOW operation

5. Press “COMFORT AIRFLOW button”.

- The flap orientation will change, preventing air from blowing directly on the occupants of the room.
- “” is displayed on the LCD.
 〈COOL/DRY〉 The flap will go up.
 〈HEAT〉 The flap will go down.

■ To cancel COMFORT AIRFLOW operation

6. Press “COMFORT AIRFLOW button” again.

- The flaps will return to the memory position from before COMFORT AIRFLOW mode.
- “” disappears from the LCD.

NOTE

- When “**SWING button** ” is selected, the flap swinging range depends on the operation mode. (See the figure.)

Three-Dimensional (3-D) Airflow

- Using three-dimensional airflow circulates cold air, which tends to be collected at the bottom of the room, and hot air, which tends to collect near the ceiling, throughout the room, preventing areas of cold and hot developing.

Comfort Airflow

- The air flow is set automatically.
- The air direction is as shown in the figure at right.

■ ATTENTION

- Always use a remote controller to adjust the flap angle. If you attempt to move it forcibly with hand when it is swinging, the mechanism may be broken.
- Always use a remote controller to adjust the louvers angles.

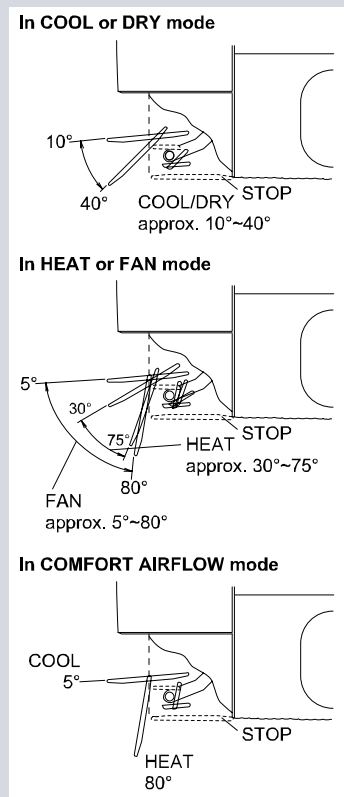

FLK(X)S 25/35/50 B

Adjusting the Air Flow Direction

You can adjust the air flow direction to increase your comfort.

■ To adjust the horizontal blade (flap)

1. Press “SWING button”.

- “” is displayed on the LCD and the flaps will begin to swing.

2. When the flaps have reached the desired position, press “SWING button” once more.

- The flap will stop moving.
- “” disappears from the LCD.

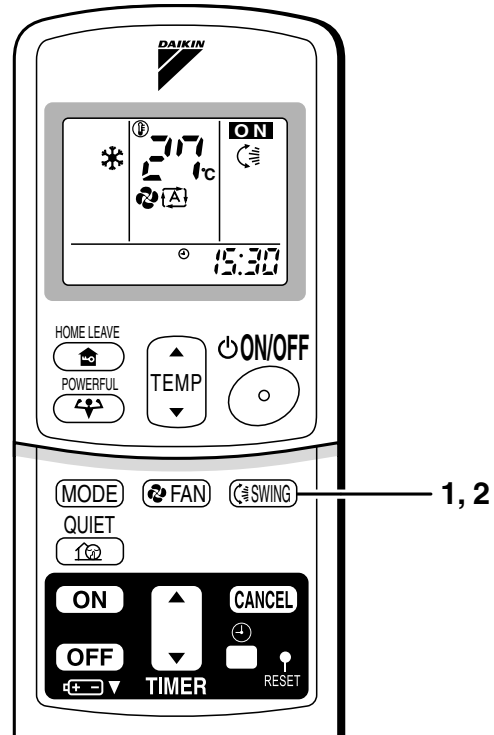

■ To adjust the vertical blades (louvers)

- When adjusting the louver, use a robust and stable stool and watch your steps carefully.
Hold the knob and move the louvers.
(You will find a knob on the left side and the right side blades.)

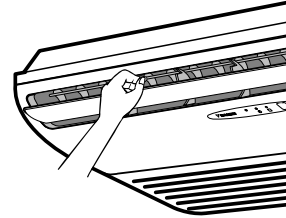

Notes on flap and louvers angles.

- Unless [SWING] is selected, you should set the flap at a near- horizontal angle in COOL or DRY mode to obtain the best performance.
- In COOL or DRY mode, if the flap is fixed at a downward position, the flap automatically moves in about 60 minutes to prevent condensation on it.

■ ATTENTION

- Always use a remote controller to adjust the flap angle.
If you attempt to move it forcibly with hand when it is swinging, the mechanism may be broken.
- Be careful when adjusting the louvers. Inside the air outlet, a fan is rotating at a high speed.

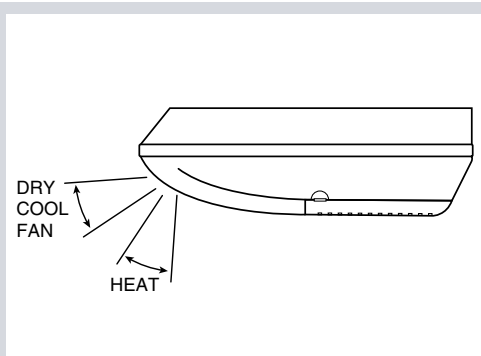

2.1.7 POWERFUL Operation

POWERFUL Operation

POWERFUL operation quickly maximizes the cooling (heating) effect in any operation mode. You can get the maximum capacity.

■ To start POWERFUL operation

1. Press “POWERFUL button”.
 - POWERFUL operation ends in 20 minutes. Then the system automatically operates again with the settings which were used before POWERFUL operation.
 - When using Powerful operation, there are some functions which are not available.
 - “” is displayed on the LCD.

■ To cancel POWERFUL operation

2. Press “POWERFUL button” again.
 - “” disappears from the LCD.

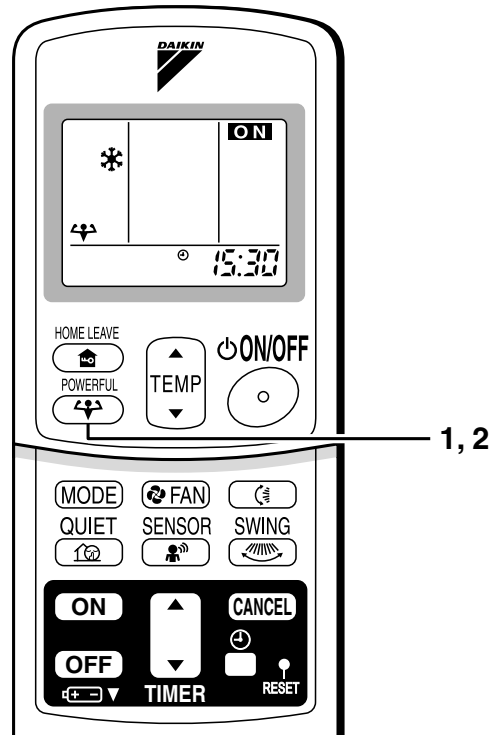

NOTE

■ Notes on POWERFUL operation

- POWERFUL Operation cannot be used together with QUIET Operation. Priority is given to the function of whichever button is pressed last.
- POWERFUL Operation can only be set when the unit is running. Pressing the operation stop button causes the settings to be canceled, and the “” disappears from the LCD.
- **In COOL and HEAT mode**
To maximize the cooling (heating) effect, the capacity of outdoor unit must be increased and the air flow rate be fixed to the maximum setting.
The temperature and air flow settings are not variable.
- **In DRY mode**
The temperature setting is lowered by 2.5°C and the air flow rate is slightly increased.
- **In FAN mode**
The air flow rate is fixed to the maximum setting.
- **When using priority-room setting**
See “Note for multi system”.

2.1.8 OUTDOOR UNIT QUIET Operation

OUTDOOR UNIT QUIET Operation

OUTDOOR UNIT QUIET operation lowers the noise level of the outdoor unit by changing the frequency and fan speed on the outdoor unit. This function is convenient during night.

■ To start OUTDOOR UNIT QUIET operation

1. Press “QUIET button”.
 - “” is displayed on the LCD.

■ To cancel OUTDOOR UNIT QUIET operation

2. Press “QUIET button” again.
 - “” disappears from the LCD.

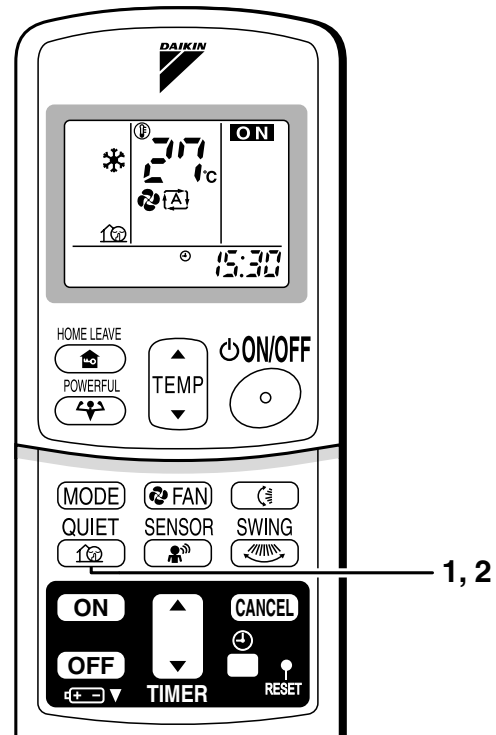

NOTE

- **Note on OUTDOOR UNIT QUIET operation**
 - If using a multi system, this function will work only when the OUTDOOR UNIT QUIET operation is set on all operated indoor units. However, if using priority-room setting, see “Note for multi system”
 - This function is available in COOL, HEAT, and AUTO modes. (This is not available in FAN and DRY mode.)
 - POWERFUL operation and OUTDOOR UNIT QUIET operation cannot be used at the same time. Priority is given to the function of whichever button is pressed last.
 - If operation is stopped using the remote controller or the main unit ON/OFF switch when using OUTDOOR UNIT QUIET operation, “” will remain on the remote controller display.

2.1.9 ECONO Operation

ECONO Operation

ECONO operation is a function which enables efficient operation by lowering the maximum power consumption value.

■ To start ECONO operation

1. Press “ECONO button” .
 - “” is displayed on the LCD.

■ To cancel ECONO operation

2. Press “ECONO button” again.
 - “” disappears from the LCD.

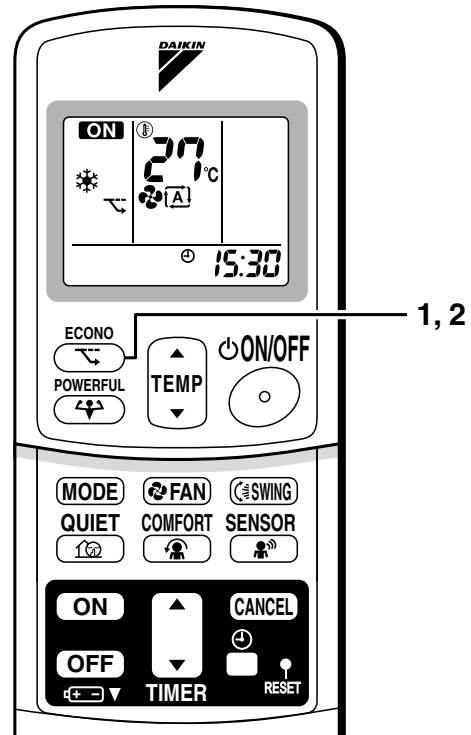

NOTE

- ECONO Operation can only be set when the unit is running. Pressing the operation stop button causes the settings to be canceled, and the “” disappears from the LCD.
- ECONO operation is a function which enables efficient operation by limiting the power consumption of the outdoor unit (operating frequency).
- ECONO operation functions in AUTO, COOL, DRY, and HEAT modes.
- POWERFUL operation and ECONO operation cannot be used at the same time. Priority is given to the function of whichever button is pressed last.
- Power consumption may not drop even if ECONO operation is used, when the level of power consumption is already low.

2.1.10 HOME LEAVE Operation

HOME LEAVE Operation

HOME LEAVE operation is a function which allows you to record your preferred temperature and air flow rate settings.

■ To start HOME LEAVE operation

1. Press “HOME LEAVE button”.

- “” is displayed on the LCD.
- The HOME LEAVE lamp lights up.

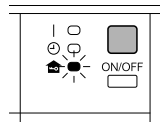

■ To cancel HOME LEAVE operation

2. Press “HOME LEAVE button” again.



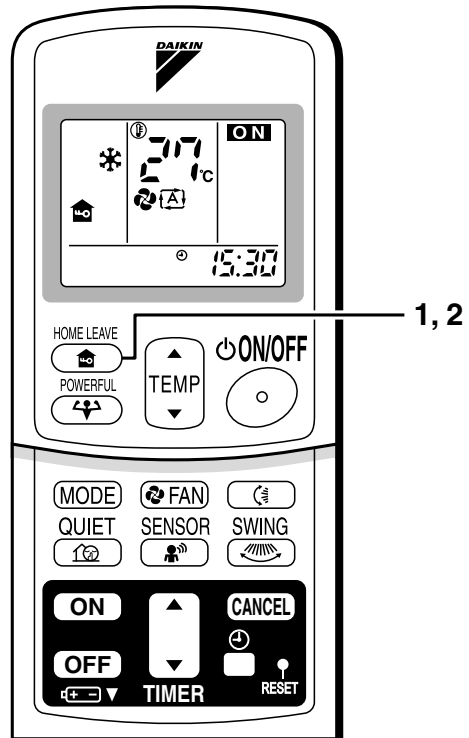



- “” disappears from the LCD.
- The HOME LEAVE lamp goes off.



Before using HOME LEAVE operation.

■ To set the temperature and air flow rate for HOME LEAVE operation

When using HOME LEAVE operation for the first time, please set the temperature and air flow rate for HOME LEAVE operation. Record your preferred temperature and air flow rate.

	Initial setting		Selectable range	
	temperature	Air flow rate	temperature	Air flow rate
Cooling	25°C	“  ”	18-32°C	5 step, “  ” and “  ”
Heating	25°C	“  ”	10-30°C	5 step, “  ” and “  ”

1. Press “HOME LEAVE button”. Make sure “” is displayed in the remote controller display.

2. Adjust the set temperature with “▲” or “▼” as you like.

3. Adjust the air flow rate with “FAN” setting button as you like.

Home leave operation will run with these settings the next time you use the unit. To change the recorded information, repeat steps 1 – 3.

■ What's the HOME LEAVE operation?

Is there a set temperature and air flow rate which is most comfortable, a set temperature and air flow rate which you use the most? HOME LEAVE operation is a function that allows you to record your favorite set temperature and air flow rate. You can start your favorite operation mode simply by pressing the HOME LEAVE button on the remote controller. This function is convenient in the following situations.

■ Useful in these cases

1. Use as an energy-saving mode.

Set the temperature 2-3°C higher (cooling) or lower (heating) than normal. Setting the fan strength to the lowest setting allows the unit to be used in energy-saving mode. Also convenient for use while you are out or sleeping.

• Every day before you leave the house...

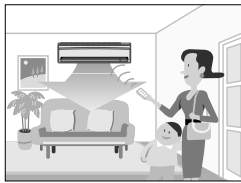

When you go out, push the "HOME LEAVE Operation" button, and the air conditioner will adjust capacity to reach the preset temperature for HOME LEAVE Operation.



When you return, you will be welcomed by a comfortably air conditioned room.

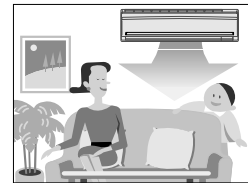

Push the "HOME LEAVE Operation" button again, and the air conditioner will adjust capacity to the set temperature for normal operation.

• Before bed...

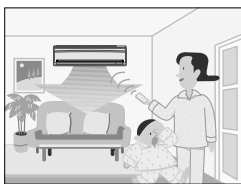

Set the unit to HOME LEAVE Operation before leaving the living room when going to bed.

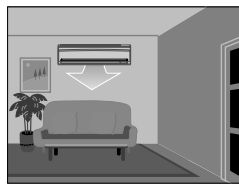

The unit will maintain the temperature in the room at a comfortable level while you sleep.

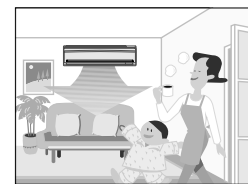

When you enter the living room in the morning, the temperature will be just right. Disengaging HOME LEAVE Operation will return the temperature to that set for normal operation. Even the coldest winters will pose no problem!

2. Use as a favorite mode.

Once you record the temperature and air flow rate settings you most often use, you can retrieve them by pressing HOME LEAVE button. You do not have to go through troublesome remote control operations.

NOTE

- Once the temperature and air flow rate for HOME LEAVE operation are set, those settings will be used whenever HOME LEAVE operation is used in the future. To change these settings, please refer to the "Before using HOME LEAVE operation" section above.
- HOME LEAVE operation is only available in COOL and HEAT mode. Cannot be used in AUTO, DRY, and FAN mode.
- HOME LEAVE operation runs in accordance with the previous operation mode (COOL or HEAT) before using HOME LEAVE operation.
- HOME LEAVE operation and POWERFUL operation cannot be used at the same time. Last button that was pressed has priority.
- The operation mode cannot be changed while HOME LEAVE operation is being used.
- When operation is shut off during HOME LEAVE operation, using the remote controller or the indoor unit ON/OFF switch, "🏠" will remain on the remote controller display.

2.1.11 INTELLIGENT EYE Operation

FTK(X)S 20/25/35/50 D

INTELLIGENT EYE Operation

“INTELLIGENT EYE” is the infrared sensor which detects the human movement.

■ To start INTELLIGENT EYE operation

1. Press “SENSOR button”.
 - “” is displayed on the LCD.

■ To cancel the INTELLIGENT EYE operation

2. Press “SENSOR button” again.
 - “” disappears from the LCD.

[EX.]

When somebody in the room

- Normal operation.



When nobody in the room

- 20 min. after, start **energy saving** operation.



Somebody back in the room

- Back to normal operation.

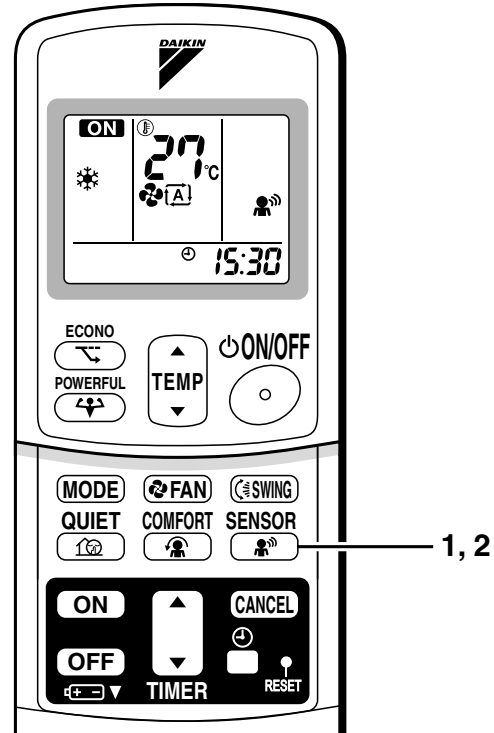

INTELLIGENT EYE Operation

“INTELLIGENT EYE” is useful for Energy Saving

■ Energy saving operation

- Change the temperature -2°C in heating / $+2^{\circ}\text{C}$ in cooling / $+2^{\circ}\text{C}$ in dry mode from set temperature.
- Decrease the air flow rate slightly in fan operation. (In FAN mode only)

Notes on “INTELLIGENT EYE”

- Application range is as follows.

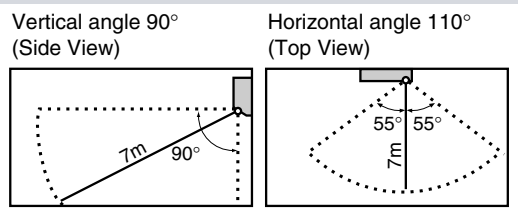

- Sensor may not detect moving objects further than 7m away. (Check the application range)
- Sensor detection sensitivity changes according to indoor unit location, the speed of passersby, temperature range, etc.
- The sensor also mistakenly detects pets, sunlight, fluttering curtains and light reflected off of mirrors as passersby.
- INTELLIGENT EYE operation will not go on during powerful operation.
- Night set mode will not go on during you use INTELLIGENT EYE operation.

⚠ CAUTION

- Do not place large objects near the sensor.
Also keep heating units or humidifiers outside the sensor's detection area. This sensor can detect objects it shouldn't as well as not detect objects it should.
- Do not hit or violently push the INTELLIGENT EYE sensor. This can lead to damage and malfunction.

FTK(X)S 20/25/35 C

INTELLIGENT EYE Operation

“INTELLIGENT EYE” is the infrared sensor which detects the human movement.

■ To start INTELLIGENT EYE operation

1. Press “SENSOR button”.
 - “” is displayed on the LCD.

■ To cancel the INTELLIGENT EYE operation

2. Press “SENSOR button” again.
 - “” disappears from the LCD.

[EX.]

When somebody in the room

- Normal operation



When nobody in the room

- 20 min. after, start energy saving operation.



Somebody back in the room

- Back to normal operation.

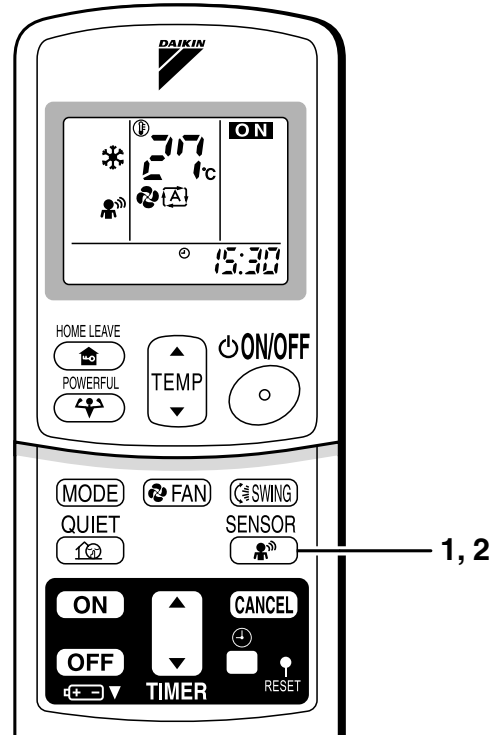

■ To adjust the angle of the INTELLIGENT EYE sensor

- You can adjust the angle of the INTELLIGENT EYE sensor to increase the detection area.
(Adjustable angle: 15° to right and left of centre)

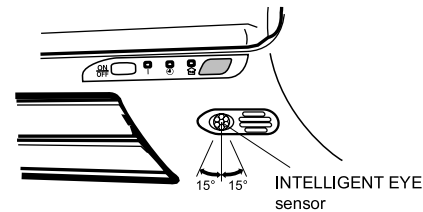

- Gently push and slide the sensor to adjust the angle.
- After adjusting the angle, wipe the sensor gently with a clean cloth, being careful not to scratch the sensor.

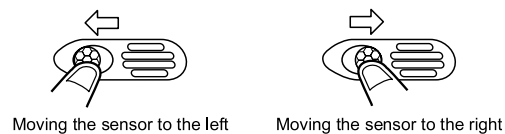

“INTELLIGENT EYE” is useful for Energy Saving.

■ Energy saving operation

- Change the temperature -2°C in heating / $+2^{\circ}\text{C}$ in cooling / $+1^{\circ}\text{C}$ in dry mode from set temperature.
- Decrease the air flow rate slightly in fan operation. (In FAN mode only)

Notes on “INTELLIGENT EYE”.

- Application range is as follows.

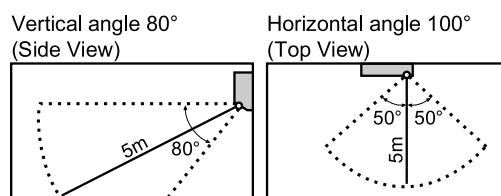

- Sensor may not detect moving objects further than 5m away. (Check the application range)
- Sensor detection sensitivity changes according to indoor unit location, the speed of passersby, temperature range, etc.
- The sensor also mistakenly detects pets, sunlight, fluttering curtains and light reflected off of mirrors as passersby.
- INTELLIGENT EYE operation will not go on during powerful operation.
- Night set mode will not go on during you use INTELLIGENT EYE operation.

⚠ CAUTION

- Do not place large objects near the sensor.
Also keep heating units or humidifiers outside the sensor's detection area. This sensor can detect objects it shouldn't as well as not detect objects it should.
- Do not hit or violently push the INTELLIGENT EYE sensor. This can lead to damage and malfunction.

FTK(X)S 50 F

INTELLIGENT EYE Operation

“INTELLIGENT EYE” is the infrared sensor which detects the human movement.

■ To start INTELLIGENT EYE operation

1. Press “SENSOR button”.
 - “” is displayed on the LCD.

■ To cancel the INTELLIGENT EYE operation

2. Press “SENSOR button” again.
 - “” disappears from the LCD.

[EX.]

When somebody in the room

- Normal operation



When nobody in the room

- 20 min. after, start energy saving operation.



Somebody back in the room

- Back to normal operation.

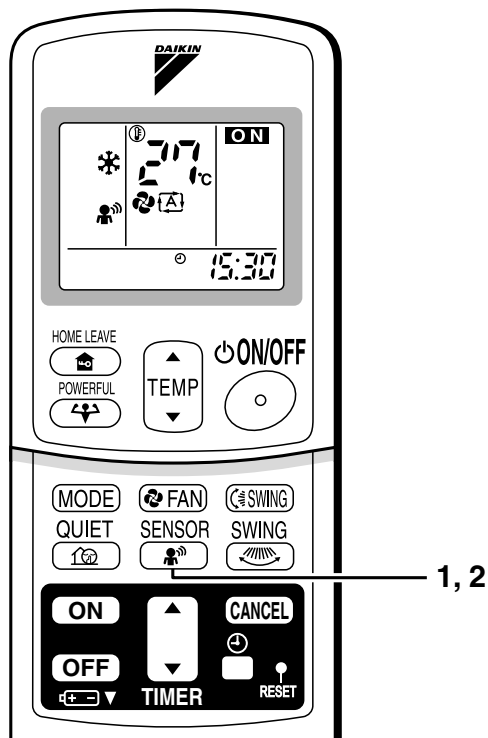

“INTELLIGENT EYE” is useful for Energy Saving.

■ Energy saving operation

- Change the temperature -2°C in heating / $+2^{\circ}\text{C}$ in cooling / $+1^{\circ}\text{C}$ in dry mode from set temperature.
- Decrease the air flow rate slightly in fan operation. (In FAN mode only)

Notes on “INTELLIGENT EYE”

- Application range is as follows.

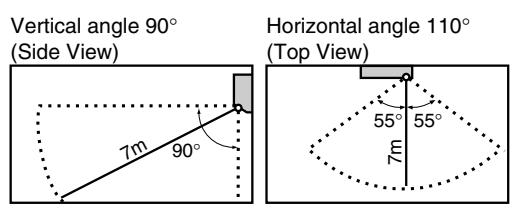

- Sensor may not detect moving objects further than 7m away. (Check the application range)
- Sensor detection sensitivity changes according to indoor unit location, the speed of passersby, temperature range, etc.
- The sensor also mistakenly detects pets, sunlight, fluttering curtains and light reflected off of mirrors as passersby.
- INTELLIGENT EYE operation will not go on during powerful operation.
- Night set mode will not go on during you use INTELLIGENT EYE operation.

CAUTION

- Do not place large objects near the sensor.
Also keep heating units or humidifiers outside the sensor's detection area. This sensor can detect objects it shouldn't as well as not detect objects it should.
- Do not hit or violently push the INTELLIGENT EYE sensor. This can lead to damage and malfunction.

FTXG 25/35 E, CTXG 50 E

INTELLIGENT EYE Operation

“INTELLIGENT EYE” is the infrared sensor which detects the human movement.

■ To start INTELLIGENT EYE operation

1. Press “SENSOR button”.
 - “” is displayed on the LCD.

■ To cancel the INTELLIGENT EYE operation

2. Press “SENSOR button” again.
 - “” disappears from the LCD.

[EX.]

When somebody in the room

- Normal operation.
- The INTELLIGENT EYE lamp lights up.

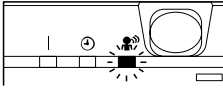

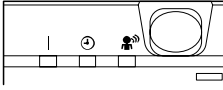

When somebody in the room

- 20 min. after, start **energy saving operation**.
- The INTELLIGENT EYE lamp goes off.

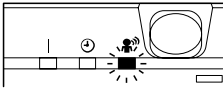
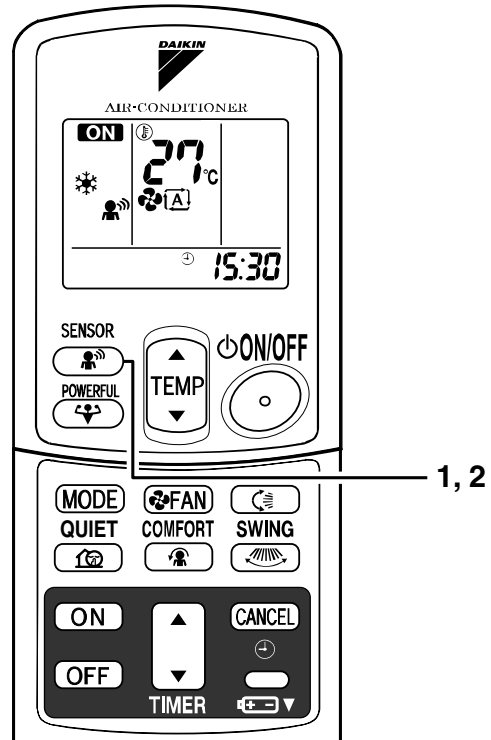

Somebody back in the room

- Back to normal operation.
- The INTELLIGENT EYE lamp lights up.

“INTELLIGENT EYE” is useful for Energy Saving

■ Energy saving operation

- Change the temperature -2°C in heating / $+2^{\circ}\text{C}$ in cooling / $+2^{\circ}\text{C}$ in dry mode from set temperature.
- Decrease the air flow rate slightly in fan operation. (In FAN mode only)

Notes on “INTELLIGENT EYE”

- Application range is as follows.

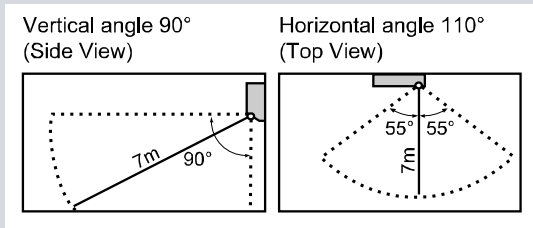

- Sensor may not detect moving objects further than 7m away. (Check the application range)
- Sensor detection sensitivity changes according to indoor unit location, the speed of passersby, temperature range, etc.
- The sensor also mistakenly detects pets, sunlight, fluttering curtains and light reflected off of mirrors as passersby.
- INTELLIGENT EYE operation will not go on during powerful operation.
- Night set mode will not go on during you use INTELLIGENT EYE operation.

CAUTION

- Do not place large objects near the sensor.
Also keep heating units or humidifiers outside the sensor's detection area. This sensor can detect objects it shouldn't as well as not detect objects it should.
- Do not hit or violently push the INTELLIGENT EYE sensor. This can lead to damage and malfunction.

2.1.12 TIMER Operation

TIMER Operation

Timer functions are useful for automatically switching the air conditioner on or off at night or in the morning. You can also use OFF TIMER and ON TIMER in combination.

■ To use OFF TIMER operation

- Check that the clock is correct.
If not, set the clock to the present time.

1. Press “OFF TIMER button”.

0:00 is displayed.

⊕-⊖ blinks.

2. Press “TIMER Setting button” until the time setting reaches the point you like.

- Every pressing of either button increases or decreases the time setting by 10 minutes. Holding down either button changes the setting rapidly.

3. Press “OFF TIMER button” again.

- The TIMER lamp lights up.

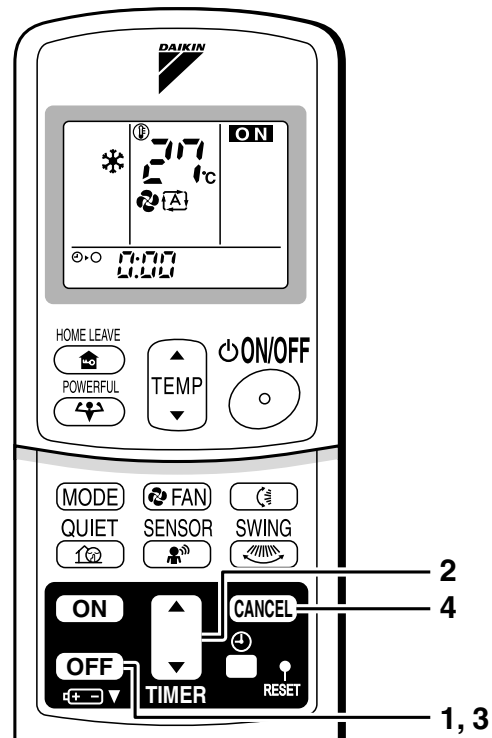
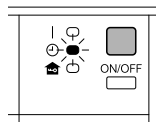

■ To cancel the OFF TIMER Operation

4. Press “CANCEL button”.

- The TIMER lamp goes off.

NOTE

- When TIMER is set, the present time is not displayed.
- Once you set ON, OFF TIMER, the time setting is kept in the memory. (The memory is canceled when remote controller batteries are replaced.)
- When operating the unit via the ON/OFF Timer, the actual length of operation may vary from the time entered by the user. (Maximum approx. 10 minutes)

■ NIGHT SET MODE

When the OFF TIMER is set, the air conditioner automatically adjusts the temperature setting (0.5°C up in COOL, 2.0°C down in HEAT) to prevent excessive cooling (heating) for your pleasant sleep.

■ To use ON TIMER operation

- Check that the clock is correct. If not, set the clock to the present time.

1. Press “ON TIMER button”.

6:00 is displayed.

⊕-| blinks.

2. Press “TIMER Setting button” until the time setting reaches the point you like.

- Every pressing of either button increases or decreases the time setting by 10 minutes. Holding down either button changes the setting rapidly.

3. Press “ON TIMER button” again.

- The TIMER lamp lights up.

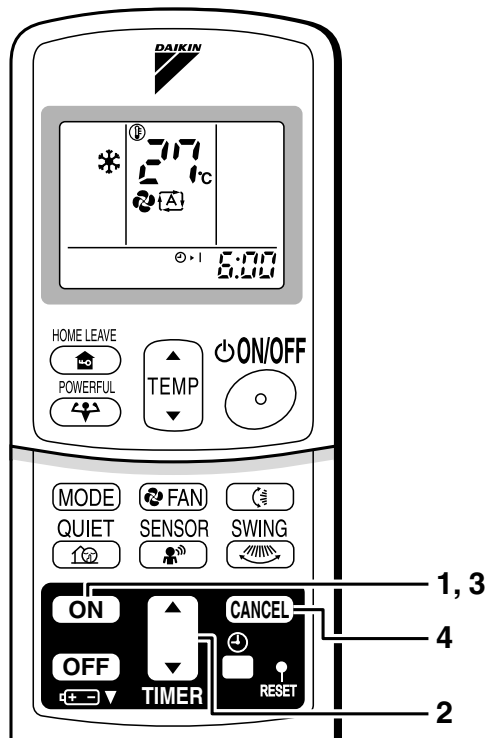
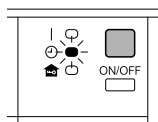

■ To cancel ON TIMER operation

4. Press “CANCEL button”.

- The TIMER lamp goes off.

■ To combine ON TIMER and OFF TIMER

- A sample setting for combining the two timers is shown below.

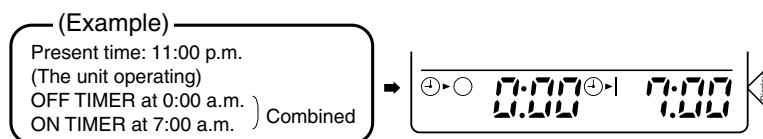

ATTENTION

■ In the following cases, set the timer again.

- After a breaker has turned OFF.
- After a power failure.
- After replacing batteries in the remote controller.

2.1.13 Note for Multi System

Note for Multi System

<< What is a “Multi System”? >>

This system has one outdoor unit connected to multiple indoor units.

■ Selecting the Operation Mode

1. With the Priority Room Setting present but inactive or not present.

When more than one indoor unit is operating, priority is given to the first unit that was turned on.

In this case, set the units that are turned on later to the same operation mode (*1) as the first unit.

Otherwise, they will enter the Standby Mode, and the operation lamp will flash; this does not indicate malfunction.

(*1)

- COOL, DRY and FAN mode may be used at the same time.
- AUTO mode automatically selects COOL mode or HEAT mode based on the room temperature. Therefore, AUTO mode is available when selecting the same operation mode as that of the room with the first unit to be turned on.

<CAUTION>

Normally, the operation mode in the room where the unit is first run is given priority, but the following situations are exceptions, so please keep this in mind.

If the operation mode of the first room is **FAN Mode**, then using **Heating Mode** in any room after this will give priority to **heating**. In this situation, the air conditioner running in FAN Mode will go on standby, and the operation lamp will flash.

2. With the Priority Room Setting active.

See “Priority Room Setting” on the next page.

■ NIGHT QUIET Mode (Available only for cooling operation)

NIGHT QUIET Mode requires initial programming during installation. Please consult your retailer or dealer for assistance. NIGHT QUIET Mode reduces the operation noise of the outdoor unit during the night time hours to prevent annoyance to neighbors.

- The NIGHT QUIET Mode is activated when the temperature drops 5°C or more below the highest temperature recorded that day. Therefore, when the temperature difference is less than 5°C, this function will not be activated.
- NIGHT QUIET Mode reduces slightly the cooling efficiency of the unit.

■ OUTDOOR UNIT QUIET Operation

1. With the Priority Room Setting present but inactive or not present.

When using the OUTDOOR UNIT QUIET operation feature with the Multi system, set all indoor units to OUTDOOR UNIT QUIET operation using their remote controllers.

When clearing OUTDOOR UNIT QUIET operation, clear one of the operating indoor units using their remote controller.

However OUTDOOR UNIT QUIET operation display remains on the remote controller for other rooms.

We recommend you release all rooms using their remote controllers.

2. With the Priority Room Setting active.

See “Priority Room Setting” on the next page.

■ Cooling / Heating Mode Lock (Available only for heat pump models)

The Cooling / Heating Mode Lock requires initial programming during installation. Please consult your retailer or dealer for assistance. The Cooling / Heating Mode Lock sets the unit forcibly to either Cooling or Heating Mode. This function is convenient when you wish to set all indoor units connected to the Multi system to the same operation mode.

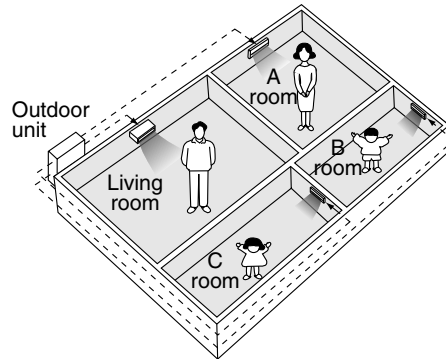

Note for Multi System

■ Priority Room Setting

The Priority Room Setting requires initial programming during installation. Please consult your retailer or dealer for assistance.

The room designated as the Priority Room takes priority in the following situations;

1. Operation Mode Priority.

As the operation mode of the Priority Room takes precedence, the user can select a different operation mode from other rooms.

〈Example〉

* Room A is the Priority Room in the examples.

When COOL mode is selected in Room A while operating the following modes in Room B,C and D :

Operation mode in Room B, C and D	Status of Room B, C and D when the unit in Room A is in COOL mode
COOL or DRY or FAN	Current operation mode maintained
HEAT	The unit enters Standby Mode. Operation resumes when the Room A unit stops operating.
AUTO	If the unit is set to COOL mode, operation continues. If set to HEAT mode, it enters Standby Mode. Operation resumes when the Room A unit stops operating.

2. Priority when POWERFUL operation is used.

〈Example〉

* Room A is the Priority Room in the examples.

The indoor units in Rooms A,B,C and D are all operating. If the unit in Room A enters POWERFUL operation, operation capacity will be concentrated in Room A. In such a case, the cooling (heating) efficiency of the units in Rooms B,C and D may be slightly reduced.

3. Priority when using OUTDOOR UNIT QUIET operation.

〈Example〉

* Room A is the Priority Room in the examples.

Just by setting the unit in Room A to QUIET operation, the air conditioner starts OUTDOOR UNIT QUIET operation.

You don't have to set all the operated indoor units to QUIET operation.

2.1.14 Care and Cleaning

FTK(X)S 20/25/35/50 D

Care and Cleaning

⚠ CAUTION Before cleaning, be sure to stop the operation and turn the breaker OFF.

Units

■ Indoor unit, Outdoor unit and Remote controller

1. Wipe them with dry soft cloth.

■ Front panel

1. Open the front panel.

- Hold the panel by the tabs on the two sides and lift it until it stops with a click.

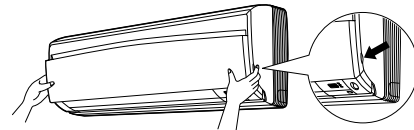

2. Remove the front panel.

- Lift the front panel up, slide it slightly to the right, and remove it from the horizontal axle.

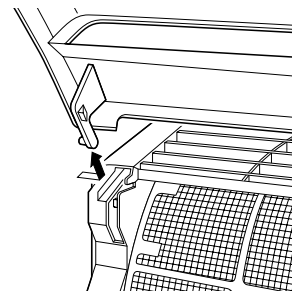

3. Clean the front panel.

- Wipe it with a soft cloth soaked in water.
- Only neutral detergent may be used.
- In case of washing the panel with water, dry it with cloth, dry it up in the shade after washing.

4. Attach the front panel.

- Set the 2 keys of the front panel into the slots and push them in all the way.
- Close the front panel slowly and push the panel at the 3 points.
(1 on each side and 1 in the middle.)

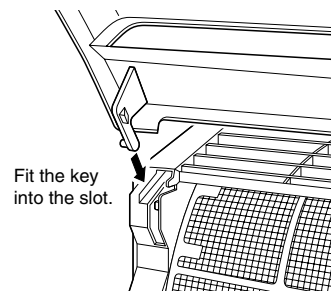

⚠ CAUTION

- Don't touch the metal parts of the indoor unit. If you touch those parts, this may cause an injury.
- When removing or attaching the front panel, use a robust and stable stool and watch your steps carefully.
- When removing or attaching the front panel, support the panel securely with hand to prevent it from falling.
- For cleaning, do not use hot water above 40°C, benzine, gasoline, thinner, nor other volatile oils, polishing compound, scrubbing brushes, nor other hand stuff.
- After cleaning, make sure that the front panel is securely fixed.

Filters

1. **Open the front panel.**
2. **Pull out the air filters.**
 - Push a little upwards the tab at the center of each air filter, then pull it down.
3. **Take off the Titanium Apatite Photocatalytic Air-Purifying Filter.**
 - Hold the recessed parts of the frame and unhook the four claws.
4. **Clean or replace each filter.**
See figure.

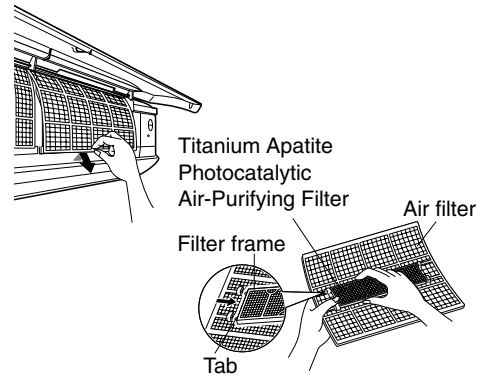
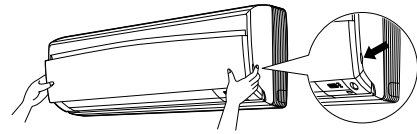

5. **Set the air filter and Titanium Apatite Photocatalytic Air-Purifying Filter as they were and close the front panel.**
 - Insert claws of the filters into slots of the front panel. Close the front panel slowly and push the panel at the 3 points. (1 on each side and 1 in the middle.)

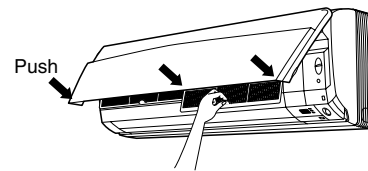

■ Air Filter

1. **Wash the air filters with water or clean them with vacuum cleaner.**
 - If the dust does not come off easily, wash them with neutral detergent thinned with lukewarm water, then dry them up in the shade.
 - It is recommended to clean the air filters every two weeks.

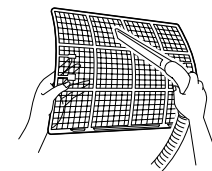

■ Titanium Apatite Photocatalytic Air-Purifying Filter.

The Titanium Apatite Photocatalytic Air-Purifying Filter can be renewed by washing it with water once every 6 months. We recommend replacing it once every 3 years.

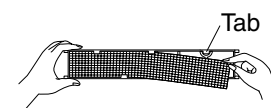

[Maintenance]

1. **Remove dust with a vacuum cleaner and wash lightly with water.**
2. **If it is very dirty, soak it for 10 to 15 minutes in water mixed with a neutral cleaning agent.**
3. **Do not remove filter from frame when washing with water.**
4. **After washing, shake off remaining water and dry in the shade.**
5. **Since the material is made out of paper, do not wring out the filter when removing water from it.**

[Replacement]

1. **Remove the tabs on the filter frame and replace with a new filter.**
 - Dispose of the old filter as flammable waste.

NOTE

- Operation with dirty filters:
 (1) cannot deodorize the air. (2) cannot clean the air.
 (3) results in poor heating or cooling. (4) may cause odour.
- To order Titanium Apatite Photocatalytic Air-Purifying Filter contact to the service shop there you bought the air conditioner.
- Dispose of old filters as burnable waste.

Item	Part No.
Titanium Apatite Photocatalytic Air-Purifying Filter. (without frame) 1 set	KAF970A46

Check

Check that the base, stand and other fittings of the outdoor unit are not decayed or corroded.
Check that nothing blocks the air inlets and the outlets of the indoor unit and the outdoor unit.
Check that the drain comes smoothly out of the drain hose during COOL or DRY operation. <ul style="list-style-type: none"> • If no drain water is seen, water may be leaking from the indoor unit. Stop operation and consult the service shop if this is the case.

■ Before a long idle period

- 1. Operate the “FAN only” for several hours on a fine day to dry out the inside.**
 - Press “MODE selector button” and select “FAN” operation.
 - Press “ON/OFF button” and start operation.
- 2. After operation stops, turn off the breaker for the room air conditioner.**
- 3. Clean the air filters and set them again.**
- 4. Take out batteries from the remote controller.**
 - When a multi outdoor unit is connected, make sure the heating operation is not used at the other room before you use the fan operation.

FTK(X)S 20/25/35 C

Care and Cleaning



CAUTION Before cleaning, be sure to stop the operation and turn the breaker OFF.

Units

■ Indoor unit, Outdoor unit and Remote controller

1. Wipe them with dry soft cloth.

■ Front panel

1. Open the front panel.

- Hold the panel by the tabs on the two sides and lift it until it stops with a click.

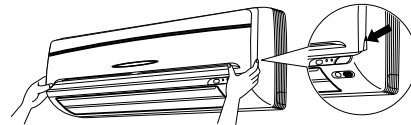

2. Remove the front panel.

- Supporting the front panel with one hand, release the lock by sliding down the knob with the other hand.
- To remove the front panel, pull it toward yourself with both hands.

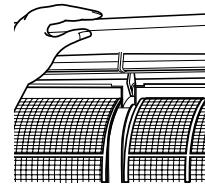

3. Clean the front panel.

- Wipe it with a soft cloth soaked in water.
- Only neutral detergent may be used.
- In case of washing the panel with water, dry it with cloth, dry it up in the shade after washing.

4. Attach the front panel.

- Set the 3 keys of the front panel into the slots and push them in all the way.
- Close the front panel slowly and push the panel at the 3 points.
(1 on each side and 1 in the middle.)
- Check to see if the rotating axis in the upper center section is moving.

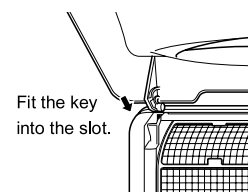

⚠ CAUTION

- Don't touch the metal parts of the indoor unit. If you touch those parts, this may cause an injury.
- When removing or attaching the front panel, use a robust and stable stool and watch your steps carefully.
- When removing or attaching the front panel, support the panel securely with hand to prevent it from falling.
- For cleaning, do not use hot water above 40°C, benzene, gasoline, thinner, nor other volatile oils, polishing compound, scrubbing brushes, nor other hand stuff.
- After cleaning, make sure that the front panel is securely fixed.

Filters

1. **Open the front panel.**
2. **Pull out the air filters.**
 - Push a little upwards the tab at the center of each air filter, then pull it down.

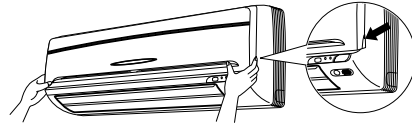

3. **Take off the air purifying filter with photocatalytic deodorizing function.**
 - Hold the recessed parts of the frame and unhook the four claws.

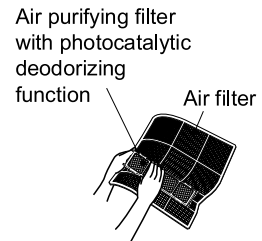
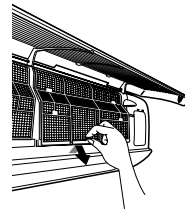

4. **Clean or replace each filter.**
See figure.

5. **Set the air filter and the air purifying filter with photocatalytic deodorizing function as they were and close the front panel.**
 - Insert claws of the filters into slots of the front panel. Close the front panel slowly and push the panel at the 3 points. (1 on each side and 1 in the middle.)

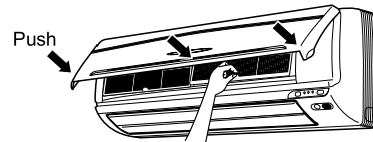

■ **Air Filter**

1. **Wash the air filters with water or clean them with vacuum cleaner.**
 - If the dust does not come off easily, wash them with neutral detergent thinned with lukewarm water, then dry them up in the shade.
 - It is recommended to clean the air filters every two weeks.

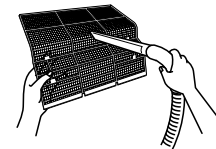

■ **Air purifying filter with photocatalytic deodorizing function. (gray)**

The Air purifying filter with photocatalytic deodorizing function can be renewed by washing it with water once every 6 months. We recommend replacing it once every 3 years.

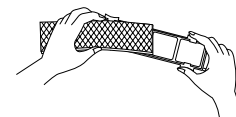

[**Maintenance**]

1. **Remove dust with a vacuum cleaner and wash lightly with water.**
2. **If it is very dirty, soak it for 10 to 15 minutes in water mixed with a neutral cleaning agent.**
3. **Do not remove filter from frame when washing with water.**
4. **After washing, shake off remaining water and dry in the shade.**
5. **Since the material is made out of paper, do not wring out the filter when removing water from it.**

[**Replacement**]

1. **Remove the tabs on the filter frame and replace with a new filter.**
 - Dispose of the old filter as flammable waste.

Check

Check that the base, stand and other fittings of the outdoor unit are not decayed or corroded.
Check that nothing blocks the air inlets and the outlets of the indoor unit and the outdoor unit.
Check that the drain comes smoothly out of the drain hose during COOL or DRY operation. <ul style="list-style-type: none"> If no drain water is seen, water may be leaking from the indoor unit. Stop operation and consult the service shop if this is the case.

■ Before a long idle period

1. Operate the “FAN only” for several hours on a fine day to dry out the inside.

- Press “MODE” button and select “FAN” operation.
- Press “ON/OFF” button and start operation.

2. After operation stops, turn off the breaker for the room air conditioner.

3. Clean the air filters and set them again.

4. Take out batteries from the remote controller.

- When a multi outdoor unit is connected, make sure the heating operation is not used at the other room before you use the fan operation.

NOTE

- Operation with dirty filters:
 - (1) cannot deodorize the air. (2) cannot clean the air.
 - (3) results in poor heating or cooling. (4) may cause odour.
- To order air purifying filter with photocatalytic deodorizing function contact to the service shop there you bought the air conditioner.
- Dispose of old filters as burnable waste.

Item	Part No.
Air purifying filter with photocatalytic deodorizing function. (with frame) 1 set	KAF918A43
Air purifying filter with photocatalytic deodorizing function. (without frame) 1 set	KAF918A44

FTK(X)S 50 F

Care and Cleaning

⚠ CAUTION Before cleaning, be sure to stop the operation and turn the breaker OFF.

Units

■ Indoor unit, Outdoor unit and Remote controller

1. Wipe them with dry soft cloth.

■ Front panel

1. Open the front panel.

- Hold the panel by the tabs on the two sides and lift it until it stops with a click.

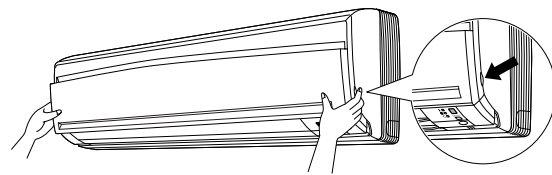

2. Remove the front panel.

- Open the front panel further while sliding it to either the left or right and pulling it toward you. This will disconnect the rotation dowel on one side. Then disconnect the rotation dowel on the other side in the same manner.

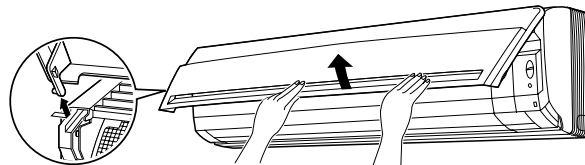

3. Clean the front panel.

- Wipe it with a soft cloth soaked in water.
- Only neutral detergent may be used.
- In case of washing the panel with water, dry it with cloth, dry it up in the shade after washing.

4. Attach the front panel.

- Align the rotation dowels on the left and right of the front panel with the slots, then push them all the way in.
- Close the front panel slowly. (Press the panel at both sides and the center.)

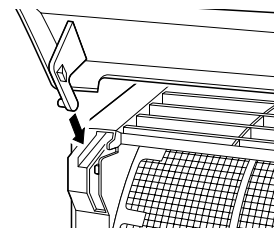

⚠ CAUTION

- Don't touch the metal parts of the indoor unit. If you touch those parts, this may cause an injury.
- When removing or attaching the front panel, use a robust and stable stool and watch your steps carefully.
- When removing or attaching the front panel, support the panel securely with hand to prevent it from falling.
- For cleaning, do not use hot water above 40°C, benzene, gasoline, thinner, nor other volatile oils, polishing compound, scrubbing brushes, nor other hand stuff.
- After cleaning, make sure that the front panel is securely fixed.

Filters

1. Open the front panel.

2. Pull out the air filters.

- Push a little upwards the tab at the center of each air filter, then pull it down.

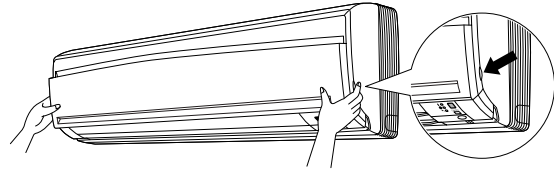

3. Take off the Titanium Apatite Photocatalytic Air-Purifying Filter.

- Press the top of the air-cleaning filter onto the tabs (3 tabs at top). Then press the bottom of the filter up slightly, and press it onto the tabs (3 at bottom).

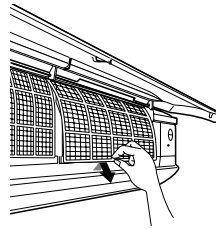

tabs (3 tabs at top)

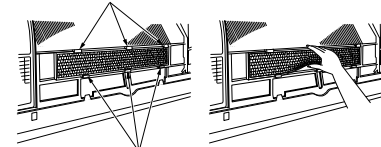

tabs (3 at bottom)

4. Clean or replace each filter.

See figure.

5. Set the air filter and the Titanium Apatite Photocatalytic Air-Purifying Filter as they were and close the front panel.

- Press the front panel at both sides and the center.

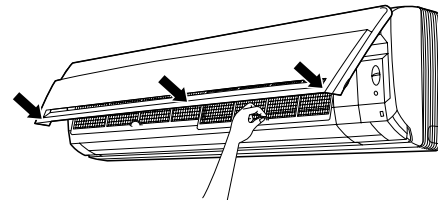

■ Air Filter

1. Wash the air filters with water or clean them with vacuum cleaner.

- If the dust does not come off easily, wash them with neutral detergent thinned with lukewarm water, then dry them up in the shade.
- It is recommended to clean the air filters every two weeks.

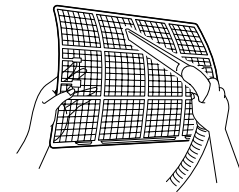

■ Titanium Apatite Photocatalytic Air-purifying Filter

The Titanium Apatite Photocatalytic Air-Purifying Filter can be renewed by washing it with water once every 6 months. We recommend replacing it once every 3 years.

[Maintenance]

1. Remove dust with a vacuum cleaner and wash lightly with water.
2. If it is very dirty, soak it for 10 to 15 minutes in water mixed with a neutral cleaning agent.
3. After washing, shake off remaining water and dry in the shade.
4. Since the material is made out of polyester, do not wring out the filter when removing water from it.

[Replacement]

1. Remove the tabs on the filter frame and replace with a new filter.
 - Dispose of the old filter as non-flammable waste.

NOTE

- Operation with dirty filters:
 (1) cannot deodorize the air. (2) cannot clean the air.
 (3) results in poor heating or cooling. (4) may cause odour.
- To order Titanium Apatite Photocatalytic Air-Purifying Filter contact to the service shop there you bought the air conditioner.
- Dispose of old filters as non-flammable waste.

Item	Part No.
Titanium Apatite Photocatalytic Air-Purifying Filter (without frame) 1 set	KAF952B42

Check

Check that the base, stand and other fittings of the outdoor unit are not decayed or corroded.
Check that nothing blocks the air inlets and the outlets of the indoor unit and the outdoor unit
Check that the drain comes smoothly out of the drain hose during COOL or DRY operation. <ul style="list-style-type: none"> • If no drain water is seen, water may be leaking from the indoor unit. Stop operation and consult the service shop if this is the case.

■ Before a long idle period

- 1. Operate the “FAN only” for several hours on a fine day to dry out the inside.**
 - Press “MODE” button and select “FAN” operation.
 - Press “ON/OFF” button and start operation.
- 2. After operation stops, turn off the breaker for the room air conditioner.**
- 3. Clean the air filters and set them again.**
- 4. Take out batteries from the remote controller.**
 - When a multi outdoor unit is connected, make sure the heating operation is not used at the other room before you use the fan operation.

FTXG 25/35 E, CTXG 50 E

Care and Cleaning



CAUTION

- Before cleaning, be sure to stop the operation and turn the breaker OFF.
- Always shut down the unit (and close the panel) before doing any work. Opening the panel during operation may cause the panel to fall off.

Units

■ Indoor unit, Outdoor unit and Remote controller

1. Wipe them with dry soft cloth.

■ Front panel

1. Open the front panel.

- Open the front panel by placing a finger on the panel tab on either side of the front panel.

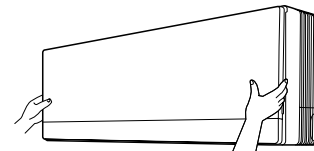

2. Remove the front panel.

- With the front panel open so that it is almost horizontal, slide it to the right. The revolving axis on the left will come off. The revolving axis on the right can be removed by sliding the front panel to the left.

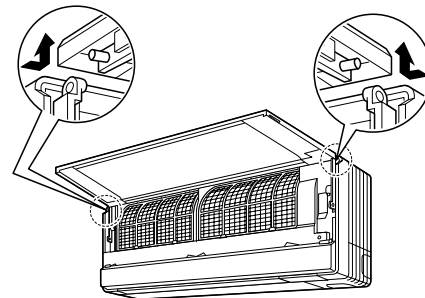

3. Clean the front panel.

- Wipe it with a soft cloth soaked in water.
- Only neutral detergent may be used.
- In case of washing the front panel with water, dry it with cloth, dry it up in the shade after washing.

4. Attach the front panel.

- Place the revolving axes on either side of the front panel into the holes and slowly close. (Press either side of the front panel.)

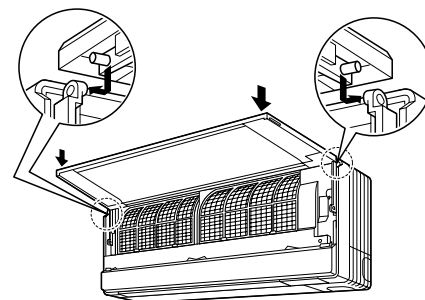

CAUTION

- Don't touch the metal parts of the indoor unit. If you touch those parts, this may cause an injury.
- When removing or attaching the front panel, use a robust and stable stool and watch your steps carefully.
- When removing or attaching the front panel, support the front panel securely with hand to prevent it from falling.
- For cleaning, do not use hot water above 40°C, benzine, gasoline, thinner, nor other volatile oils, polishing compound, scrubbing brushes, nor other hand stuff.
- After cleaning, make sure that the front panel is securely fixed.

Filters

1. Open the front panel.

- Open the front panel by placing a finger on the panel tab on either side of the front panel and then secure it using the supporting plate on the right.

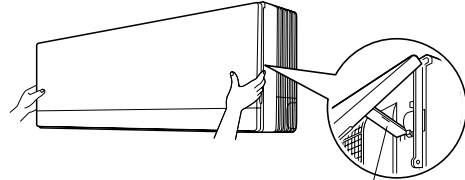

Supporting plate

2. Pull out the air filters.

- Push a little upwards the tab at the center of each air filter, then pull it down.

3. Take off the Titanium Apatite Photocatalytic Air-Purifying Filter.

- Hold the recessed parts of the frame and unhook the four claws.

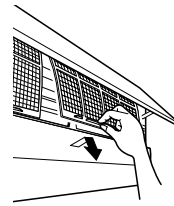

Titanium Apatite Photocatalytic Air-Purifying Filter

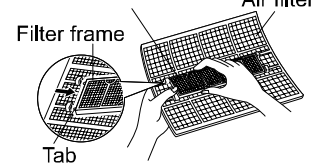

4. Clean or replace each filter.

See figure.

5. Set the air filter and the Titanium Apatite Photocatalytic Air-Purifying Filter as they were and close the front panel.

- Be sure to insert the two tabs below.
- Return the supporting plate to its previous position.
- Press either side of the front panel.

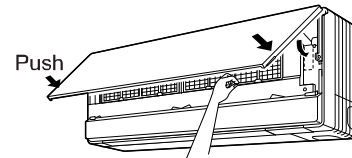

■ Air Filter

1. Wash the air filters with water or clean them with vacuum cleaner.

- If the dust does not come off easily, wash them with neutral detergent thinned with lukewarm water, then dry them up in the shade.
- It is recommended to clean the air filters every two weeks.

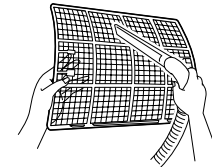

■ Titanium Apatite Photocatalytic Air-Purifying Filter (gray)

The Titanium Apatite Photocatalytic Air-Purifying Filter can be renewed by washing it with water once every 6 months. We recommend replacing it once every 3 years.

[Maintenance]

1. Remove dust with a vacuum cleaner and wash lightly with water.
2. If it is very dirty, soak it for 10 to 15 minutes in water mixed with a neutral cleaning agent.
3. Do not remove filter from frame when washing with water.
4. After washing, shake off remaining water and dry in the shade.
5. Since the material is made out of paper, do not wring out the filter when removing water from it.

[Replacement]

1. Remove the tabs on the filter frame and replace with a new filter.
 - Dispose of the old filter as flammable waste.

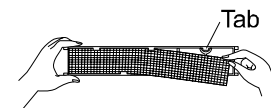

NOTE

- Operation with dirty filters:
 - (1) cannot deodorize the air. (2) cannot clean the air.
 - (3) results in poor heating or cooling. (4) may cause odour.
- To order Titanium Apatite Photocatalytic Air-Purifying Filter contact to the service shop there you bought the air conditioner.
- Dispose of old filters as burnable waste.

Item	Part No.
Titanium Apatite Photocatalytic Air-Purifying Filter. (with frame) 1 set	KAF952B41
Titanium Apatite Photocatalytic Air-Purifying Filter. (without frame) 1 set	KAF952B42

Check

Check that the base, stand and other fittings of the outdoor unit are not decayed or corroded.
Check that nothing blocks the air inlets and the outlets of the indoor unit and the outdoor unit.
Check that the drain comes smoothly out of the drain hose during COOL or DRY operation. <ul style="list-style-type: none"> • If no drain water is seen, water may be leaking from the indoor unit. Stop operation and consult the service shop if this is the case.

■ Before a long idle period

- 1. Operate the “FAN only” for several hours on a fine day to dry out the inside.**
 - Press “MODE” button and select “FAN” operation.
 - Press “ON/OFF” button and start operation.
- 2. After operation stops, turn off the breaker for the room air conditioner.**
- 3. Clean the air filters and set them again.**
- 4. Take out batteries from the remote controller.**
 - When a multi outdoor unit is connected, make sure the heating operation is not used at the other room before you use the fan operation.

FDK(X)S 25/35 C

Care and Cleaning



CAUTION • Only a qualified service person is allowed to perform maintenance.

- Before cleaning, be sure to stop the operation and turn the breaker OFF.

■ Cleaning the air filter

1. Removing the air filter.

- Rear suction
Pull the bottom side of the air filter backwards, over the 3 bends.
- Bottom suction
Pull the filter over the 3 bends situated at the backside of the unit.

2. Cleaning the air filter.

Remove dust from the air filter using a vacuum cleaner and gently rinse them in cool water. Do not use detergent or hot water to avoid filter shrinking or deformation. After cleaning dry them in the shade.

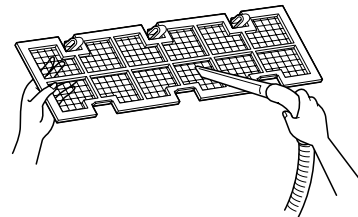

3. Replacing the air filter.

- Rear suction
Hook the filter behind the flap situated at the top of the unit and push the other side gently over the 3 bends.
- Bottom suction
Hook the filter behind the flap situated at the middle of the unit and push the other side gently over the 3 bends.

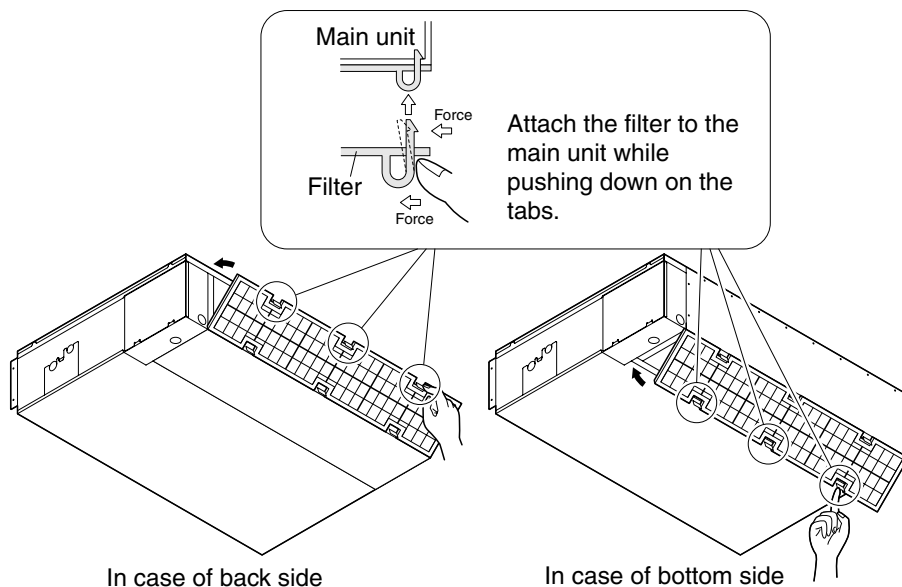

■ Cleaning the drain pan

- Clean the drain pan periodically, or drain piping may be clogged with dust and may result in water leakage. Ask your DAIKIN dealer to clean them.
- Prepare a cover locally to prevent any dust in the air around the indoor unit from getting in the drain pan, if there is a great deal of dust present.

CAUTION

- Do not operate the air conditioner without filters, this to avoid dust accumulation inside the unit.
- Do not remove the air filter except when cleaning. Unnecessary handling may damage the filter.
- Do not use gasoline, benzene, thinner, polishing powder, liquid insecticide, It may cause discoloring or warping.
- Do not let the indoor unit get wet. It may cause an electric shock or a fire.
- Operation with dusty air filters lowers the cooling and heating capacity and wastes energy.
- The suction grille is option.
- Do not use water or air of 50°C or higher for cleaning air filters and outside panels.

Check

Check that the base, stand and other fittings of the outdoor unit are not decayed or corroded.
Check that nothing blocks the air inlets and the outlets of the indoor unit and the outdoor unit
Check that the drain comes smoothly out of the drain hose during COOL or DRY operation. <ul style="list-style-type: none"> • If no drain water is seen, water may be leaking from the indoor unit. Stop operation and consult the service shop if this is the case.

■ Before a long idle period

- 1. Operate the “FAN only” for several hours on a fine day to dry out the inside.**
 - Press “MODE selector button” and select “FAN” operation.
 - Press “ON/OFF button” and start operation.
- 2. After operation stops, turn off the breaker for the room air conditioner.**
- 3. Clean the air filters and set them again.**
- 4. Take out batteries from the remote controller.**
 - When a multi outdoor unit is connected, make sure the heating operation is not used at the other room before you use the fan operation.

FDK(X)S 50 C, FDK(X)S 25/35 E

Care and Cleaning



CAUTION • Only a qualified service person is allowed to perform maintenance.

- Before cleaning, be sure to stop the operation and turn the breaker OFF.

■ Cleaning the air filter

1. Removing the air filter.

- Rear suction
Pull the bottom side of the air filter backwards, over the bends. (2 bends for 25/35 type, 3 bends for 50/60 type)
- Bottom suction
Pull the filter over the bends (2 bends for 25/35 type, 3 bends for 50/60 type) situated at the backside of the unit.

2. Cleaning the air filter.

Remove dust from the air filter using a vacuum cleaner and gently rinse them in cool water. Do not use detergent or hot water to avoid filter shrinking or deformation. After cleaning dry them in the shade.

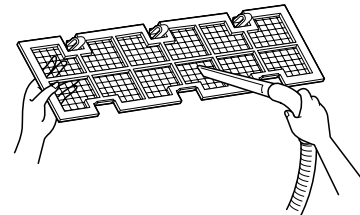

3. Replacing the air filter.

- Rear suction
Hook the filter behind the flap situated at the top of the unit and push the other side gently over the bends. (2 bends for 25/35 type, 3 bends for 50/60 type)
- Bottom suction
Hook the filter behind the flap situated at the middle of the unit and push the other side gently over the bends. (2 bends for 25/35 type, 3 bends for 50/60 type)

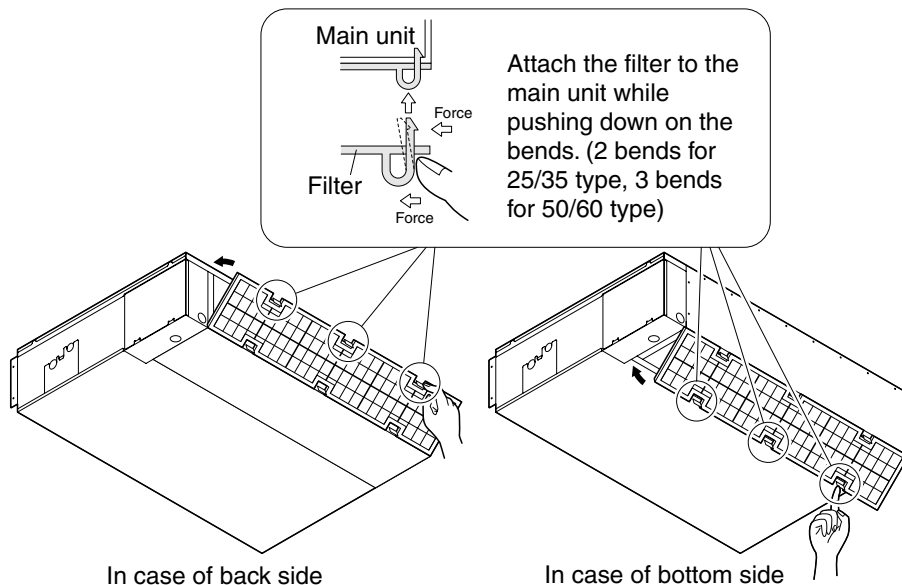

■ Cleaning the drain pan

- Clean the drain pan periodically, or drain piping may be clogged with dust and may result in water leakage. Ask your DAIKIN dealer to clean them.
- Prepare a cover locally to prevent any dust in the air around the indoor unit from getting in the drain pan, if there is a great deal of dust present.

CAUTION

- Do not operate the air conditioner without filters, this to avoid dust accumulation inside the unit.
- Do not remove the air filter except when cleaning. Unnecessary handling may damage the filter.
- Do not use gasoline, benzene, thinner, polishing powder, liquid insecticide, It may cause discoloring or warping.
- Do not let the indoor unit get wet. It may cause an electric shock or a fire.
- Operation with dusty air filters lowers the cooling and heating capacity and wastes energy.
- The suction grille is option.
- Do not use water or air of 50°C or higher for cleaning air filters and outside panels.
- Ask your DAIKIN dealer how to clean it.

Check

Check that the base, stand and other fittings of the outdoor unit are not decayed or corroded.
Check that nothing blocks the air inlets and the outlets of the indoor unit and the outdoor unit
Check that the drain comes smoothly out of the drain hose during COOL or DRY operation. <ul style="list-style-type: none"> • If no drain water is seen, water may be leaking from the indoor unit. Stop operation and consult the service shop if this is the case.

■ Before a long idle period

- 1. Operate the “FAN only” for several hours on a fine day to dry out the inside.**
 - Press “MODE selector button” and select “FAN” operation.
 - Press “ON/OFF button” and start operation.
- 2. Clean the air filters and set them again.**
- 3. Take out batteries from the remote controller.**
- 4. Turn OFF the breaker for the room air conditioner.**
 - When a multi outdoor unit is connected, make sure the heating operation is not used at the other room before you use the fan operation.

FLK(X)S 25/35/50 B

Care and Cleaning



CAUTION Before cleaning, be sure to stop the operation and turn the breaker OFF.

Units

■ Indoor unit, Outdoor unit and Remote controller

1. Wipe them with dry soft cloth.

■ Front panel

1. Open the front panel.

- Hold the panel by the tabs on the two sides and lift it until it stops.

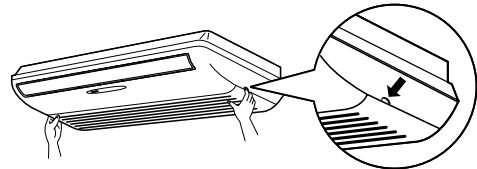

2. Clean the front panel.

- Wipe it with a soft cloth soaked in water.
- Only neutral detergent may be used.
- In case of washing the panel with water, dry it with cloth, dry it up in the shade after washing.

3. Close the front panel.

- Push the panel at the 5 points indicated by ↑.
- Operation without air filters may result in troubles as dust will accumulate inside the indoor unit.

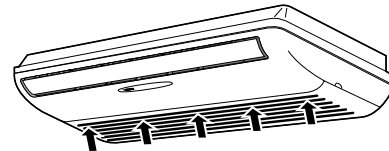

⚠ CAUTION

- Don't touch the metal parts of the indoor unit. If you touch those parts, this may cause an injury.
- When removing or attaching the front panel, use a robust and stable stool and watch your steps carefully.
- When removing or attaching the front panel, support the panel securely with hand to prevent it from falling.
- For cleaning, do not use hot water above 40°C, benzene, gasoline, thinner, nor other volatile oils, polishing compound, scrubbing brushes, nor other hand stuff.
- After cleaning, make sure that the front panel is securely fixed.

Filters

1. Open the front panel.
2. Pull out the air filters.
 - Push upwards the tab at the center of each air filter, then pull it down.

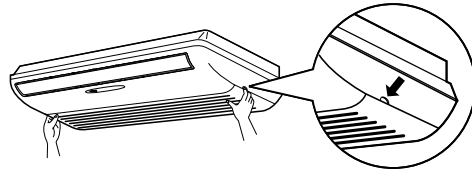

3. Take off the air purifying filter, photocatalytic deodorizing filter.
 - Hold the recessed parts of the frame and unhook the four claws.

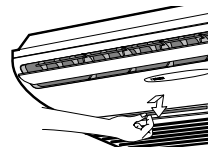

4. Clean or replace each filter.
 - See figure.

See figure.

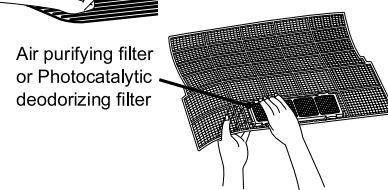

5. Set the air filter, air purifying filter and photocatalytic deodorizing filter as they were and close the front panel.
 - Insert claws of the filters into slots of the front panel.
 - Push the panel at the 5 points.

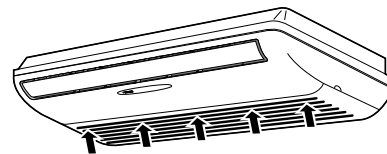

■ Air Filter

1. Wash the air filters with water or clean them with vacuum cleaner.
 - If the dust does not come off easily, wash them with neutral detergent thinned with lukewarm water, then dry them up in the shade.
 - It is recommended to clean the air filters every two weeks.

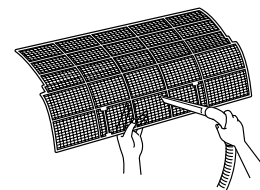

■ Air Purifying Filter (green)

(Replace approximately once every 3 months.)

1. Detach the filter element and attach a new one.
 - Insert with the green side up.
 - It is recommended to replace the air purifying filter every three months.

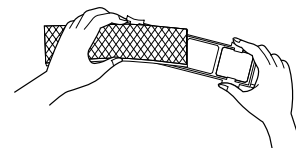

■ Photocatalytic Deodorizing Filter (gray)

[Maintenance]

1. Dry the photocatalytic deodorizing filter in the sun.
 - After removing the dust with a vacuum cleaner, place the filter in the sun for approximately 6 hours. By drying the photocatalytic deodorizing filter in the sun, its deodorizing and antibacterial capabilities are regenerated.
 - Because the filter material is paper, it can not be cleaned with water.
 - It is recommended dry the filter once every 6 months.

[Replacement]

1. Detach the filter element and attach a new one.

Check

Check that the base, stand and other fittings of the outdoor unit are not decayed or corroded.
Check that nothing blocks the air inlets and the outlets of the indoor unit and the outdoor unit.
Check that the drain comes smoothly out of the drain hose during COOL or DRY operation. <ul style="list-style-type: none"> • If no drain water is seen, water may be leaking from the indoor unit. Stop operation and consult the service shop if this is the case.

■ Before a long idle period

1. Operate the “FAN only” for several hours on a fine day to dry out the inside.

- Press “MODE” button and select “FAN”operation.
- Press “ON/OFF” button and start operation.

2. After operation stops, turn off the breaker for the room air conditioner.

3. Clean the air filters and set them again.

4. Take out batteries from the remote controller.

- When a multi outdoor unit is connected, make sure the heating operation is not used at the other room before you use the fan operation.

NOTE

- Operation with dirty filters :
 - (1) cannot deodorize the air. (2) cannot clean the air.
 - (3) results in poor heating or cooling. (4) may cause odour.
- The air purifying filter and Photocatalytic deodorizing filter cannot be reused, even if washed.
- In principle, there is no need to replace the photocatalytic deodorizing filter. Remove the dust periodically with a vacuum cleaner. However, it is recommended to replace the filter in the following cases.
 - (1) The paper material is torn or broken during cleaning.
 - (2) The filter has become extremely dirty after long use.
- To order air purifying filter or Photocatalytic deodorizing filter, contact to the service shop where you bought the air conditioner.
- Dispose of old air filters as non-burnable waste and Photocatalytic deodorizing filters as burnable waste.

Item	Part No.
Photocatalytic deodorizing filter (with frame)	KAZ917B41
Photocatalytic deodorizing filter (without frame)	KAZ917B42
Air purifying filter (with frame)	KAF925B41
Air purifying filter (without frame)	KAF925B42

2.1.15 Troubleshooting

Trouble Shooting

These cases are not troubles.

The following cases are not air conditioner troubles but have some reasons. You may just continue using it.

Case	Explanation
Operation does not start soon. <ul style="list-style-type: none"> When ON/OFF button was pressed soon after operation was stopped. When the mode was reselected. 	<ul style="list-style-type: none"> This is to protect the air conditioner. You should wait for about 3 minutes.
Hot air does not flow out soon after the start of heating operation.	<ul style="list-style-type: none"> The air conditioner is warming up. You should wait for 1 to 4 minutes. (The system is designed to start discharging air only after it has reached a certain temperature.)
The heating operation stops suddenly and a flowing sound is heard.	<ul style="list-style-type: none"> The system is taking away the frost on the outdoor unit. You should wait for about 4 to 12 minutes.
The outdoor unit emits water or steam.	<ul style="list-style-type: none"> In HEAT mode <ul style="list-style-type: none"> The frost on the outdoor unit melts into water or steam when the air conditioner is in defrost operation. In COOL or DRY mode <ul style="list-style-type: none"> Moisture in the air condenses into water on the cool surface of outdoor unit piping and drips.
Mist comes out of the indoor unit.	<ul style="list-style-type: none"> This happens when the air in the room is cooled into mist by the cold air flow during cooling operation. This is because the air in the room is cooled by the heat exchanger and becomes mist during defrost operation.
The indoor unit gives out odour.	<ul style="list-style-type: none"> This happens when smells of the room, furniture, or cigarettes are absorbed into the unit and discharged with the air flow. (If this happens, we recommend you to have the indoor unit washed by a technician. Consult the service shop where you bought the air conditioner.)
The outdoor fan rotates while the air conditioner is not in operation.	<ul style="list-style-type: none"> After operation is stopped: <ul style="list-style-type: none"> The outdoor fan continues rotating for another 60 seconds for system protection. While the air conditioner is not in operation: <ul style="list-style-type: none"> When the outdoor temperature is very high, the outdoor fan starts rotating for system protection.
The operation stopped suddenly. (OPERATION lamp is on.)	<ul style="list-style-type: none"> For system protection, the air conditioner may stop operating on a sudden large voltage fluctuation. It automatically resumes operation in about 3 minutes.

Check again.

Please check again before calling a repair person.

Case	Check
<p>The air conditioner does not operate. (OPERATION lamp is off.)</p>	<ul style="list-style-type: none"> • Hasn't a breaker turned OFF or a fuse blown? • Isn't it a power failure? • Are batteries set in the remote controller? • Is the timer setting correct?
<p>Cooling (Heating) effect is poor.</p>	<ul style="list-style-type: none"> • Are the air filters clean? • Is there anything to block the air inlet or the outlet of the indoor and the outdoor units? • Is the temperature setting appropriate? • Are the windows and doors closed? • Are the air flow rate and the air direction set appropriately?
<p>Operation stops suddenly. (OPERATION lamp flashes.)</p>	<ul style="list-style-type: none"> • Are the air filters clean? • Is there anything to block the air inlet or the outlet of the indoor and the outdoor units? Clean the air filters or take all obstacles away and turn the breaker OFF. Then turn it ON again and try operating the air conditioner with the remote controller. If the lamp still blinks, call the service shop where you bought the air conditioner. • Are operation modes all the same for indoor units connected to outdoor units in the multi system? If not, set all indoor units to the same operation mode and confirm that the lamps flash. Moreover, when the operation mode is in "AUTO", set all indoor unit operation modes to "COOL" or "HEAT" for a moment and check again that the lamps are normal. If the lamps stop flashing after the above steps, there is no malfunction.
<p>An abnormal functioning happens during operation.</p>	<ul style="list-style-type: none"> • The air conditioner may malfunction with lightning or radio waves. Turn the breaker OFF, turn it ON again and try operating the air conditioner with the remote controller.

Call the service shop immediately.



WARNING

- When an abnormality (such as a burning smell) occurs, stop operation and turn the breaker OFF.
Continued operation in an abnormal condition may result in troubles, electric shocks or fire.
Consult the service shop where you bought the air conditioner.
- Do not attempt to repair or modify the air conditioner by yourself.
Incorrect work may result in electric shocks or fire.
Consult the service shop where you bought the air conditioner.

If one of the following symptoms takes place, call the service shop immediately.

- **The power cord is abnormally hot or damaged.**
- **An abnormal sound is heard during operation.**
- **The safety breaker, a fuse, or the earth leakage breaker cuts off the operation frequently.**
- **A switch or a button often fails to work properly.**
- **There is a burning smell.**
- **Water leaks from the indoor unit.**



Turn the breaker OFF and call the service shop.

■ After a power failure

The air conditioner automatically resumes operation in about 3 minutes. You should just wait for a while.

■ Lightning

If lightning may strike the neighboring area, stop operation and turn the breaker OFF for system protection.

Disposal requirements



Your air conditioning product is marked with this symbol. This means that electrical and electronic products shall not be mixed with unsorted household waste.

Do not try to dismantle the system yourself: the dismantling of the air conditioning system, treatment of the refrigerant, of oil and of other parts must be done by a qualified installer in accordance with relevant local and national legislation.

Air conditioners must be treated at a specialized treatment facility for re-use, recycling and recovery. By ensuring this product is disposed of correctly, you will help to prevent potential negative consequences for the environment and human health. Please contact the installer or local authority for more information.

Batteries must be removed from the remote controller and disposed of separately in accordance with relevant local and national legislation.

We recommend periodical maintenance.

In certain operating conditions, the inside of the air conditioner may get foul after several seasons of use, resulting in poor performance. It is recommended to have periodical maintenance by a specialist aside from regular cleaning by the user. For specialist maintenance, contact the service shop where you bought the air conditioner.

The maintenance cost must be born by the user.

Fault diagnosis.

FAULT DIAGNOSIS BY REMOTE CONTROLLER

In the ARC433 series, the temperature display sections on the main unit indicate corresponding codes.

1. When the **TIMER CANCEL** button is held down for 5 seconds, a “00” indication flashes on the temperature display section.

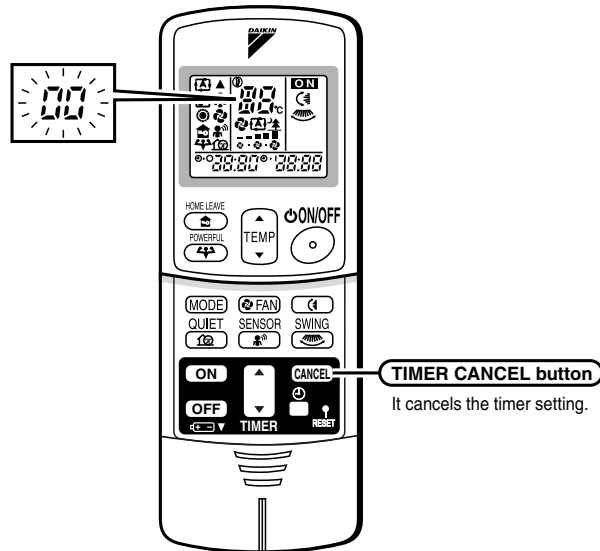

2. Press the **TIMER CANCEL** button repeatedly until a continuous beep is produced.

- The code indication changes as shown below, and notifies with a long beep.

	CODE	MEANING
SYSTEM	00	NORMAL
	U0	REFRIGERANT SHORTAGE
	U2	DROP VOLTAGE OR MAIN CIRCUIT OVERVOLTAGE
	U4	FAILURE OF TRANSMISSION (BETWEEN INDOOR UNIT AND OUTDOOR UNIT)
INDOOR UNIT	A1	INDOOR PCB DEFECTIVENESS
	A5	HIGH PRESSURE CONTROL OR FREEZE-UP PROTECTOR
	A6	FAN MOTOR FAULT
	C4	FAULTY HEAT EXCHANGER TEMPERATURE SENSOR
OUTDOOR UNIT	C9	FAULTY SUCTION AIR TEMPERATURE SENSOR
	EA	COOLING-HEATING SWITCHING ERROR
	E5	OL STARTED
	E6	FAULTY COMPRESSOR START UP
	E7	DC FAN MOTOR FAULT
	E8	OPERATION HALT DUE TO DETECTION OF INPUT OVER CURRENT
	F3	HIGH TEMPERATURE DISCHARGE PIPE CONTROL
	H6	OPERATION HALT DUE TO FAULTY POSITION DETECTION SENSOR
	H8	CT ABNORMALITY
	H9	FAULTY SUCTION AIR TEMPERATURE SENSOR
	J3	FAULTY DISCHARGE PIPE TEMPERATURE SENSOR
	J6	FAULTY HEAT EXCHANGER TEMPERATURE SENSOR
	L4	HIGH TEMPERATURE AT INVERTER CIRCUIT HEATSINK
	L5	OUTPUT OVERCURRENT
P4	FAULTY INVERTER CIRCUIT HEATSINK TEMPERATURE SENSOR	

NOTE

1. A short beep and two consecutive beeps indicate non-corresponding codes.
2. To cancel the code display, hold the **TIMER CANCEL** button down for 5 seconds. The code display also cancel itself if the button is not pressed for 1 minute.

2.2 FVXS Series

2.2.1 Safety Precautions

Safety precautions

- Keep this manual where the operator can easily find them.
- Read this manual attentively before starting up the unit.
- For safety reason the operator must read the following cautions carefully.
- This manual classifies precautions into WARNINGS and CAUTIONS. Be sure to follow all precautions below: they are all important for ensuring safety.

WARNING

If you do not follow these instructions exactly, the unit may cause property damage, personal injury or loss of life.

CAUTION

If you do not follow these instructions exactly, the unit may cause minor or moderate property damage or personal injury.



Never do.



Be sure to follow the instructions.



Be sure to earth the air conditioner.



Never cause the air conditioner (including the remote controller) to get wet.





Never touch the air conditioner (including the remote controller) with a wet hand.



WARNING

- In order to avoid fire, explosion or injury, do not operate the unit when harmful, among which flammable or corrosive gases, are detected near the unit. 
- It is not good for health to expose your body to the air flow for a long time.
- Do not put a finger, a rod or other objects into the air outlet or inlet. As the fan is rotating at a high speed, it will cause injury.
- Do not attempt to repair, relocate, modify or reinstall the air conditioner by yourself. Incorrect work will cause electric shocks, fire etc. For repairs and reinstallation, consult your Daikin dealer for advice and information.

- The refrigerant used in the air conditioner is safe. Although leaks should not occur, if for some reason any refrigerant happens to leak into the room, make sure it does not come in contact with any flame as of gas heaters, kerosene heaters or gas range. 
- If the air conditioner is not cooling (heating) properly, the refrigerant may be leaking, so call your dealer. When carrying out repairs accompanying adding refrigerant, check the content of the repairs with our service staff.
- Do not attempt to install the air conditioner by your self. Incorrect work will result in water leakage, electric shocks or fire. For installation, consult the dealer or a qualified technician.
- In order to avoid electric shock, fire or injury, if you detect any abnormally such as smell of fire, stop the operation and turn off the breaker. And call your dealer for instructions.
- Depending on the environment, an earth leakage breaker must be installed. Lack of an earth leakage breaker may result in electric shocks or fire.

- The air conditioner must be earthed. Incomplete earthing may result in electric shocks. Do not connect the earth line to a gas pipe, water pipe, lightning rod, or a telephone earth line. 



CAUTION

- In order to avoid any quality deterioration, do not use the unit for cooling precision instruments, food, plants, animals or works of art. 
- Never expose little children, plants or animals directly to the air flow.
- Do not place appliances which produce open fire in places exposed to the air flow from the unit or under the indoor unit. It may cause incomplete combustion or deformation of the unit due to the heat.

- Do not block air inlets nor outlets. Impaired air flow may result in insufficient performance or trouble.
- Do not stand or sit on the outdoor unit. Do not place any object on the unit to avoid injury, do not remove the fan guard.
- Do not place anything under the indoor or outdoor unit that must be kept away from moisture. In certain conditions, moisture in the air may condense and drip.
- After a long use, check the unit stand and fittings for damage.
- Do not touch the air inlet and aluminum fins of outdoor unit. It may cause injury.
- The appliance is not intended for use by young children or infirm persons without supervision.
- Young children should be supervised to ensure that they do not play with the appliance.

- To avoid oxygen deficiency, ventilate the room sufficiently if equipment with burner is used together with the air conditioner. 
- Before cleaning, be sure to stop the operation, turn the breaker off or pull out the supply cord.
- Do not connect the air conditioner to a power supply different from the one as specified. It may cause trouble or fire.
- Arrange the drain hose to ensure smooth drainage. Incomplete draining may cause wetting of the building, furniture etc.
- Do not place objects in direct proximity of the outdoor unit and do not let leaves and other debris accumulate around the unit.
Leaves are a hotbed for small animals which can enter the unit. Once in the unit, such animals can cause malfunctions, smoke or fire when making contact with electrical parts.

- Do not operate the air conditioner with wet hands. 

- Do not wash the indoor unit with excessive water, only use a slightly wet cloth.
- Do not place things such as vessels containing water or anything else on top of the unit. Water may penetrate into the unit and degrade electrical insulations, resulting in an electric shock. 

Installation site.

- To install the air conditioner in the following types of environments, consult the dealer.
 - Places with an oily ambient or where steam or soot occurs.
 - Salty environment such as coastal areas.
 - Places where sulfide gas occurs such as hot springs.
 - Places where snow may block the outdoor unit.
- The drain from the outdoor unit must be discharged to a place of good drainage.

Consider nuisance to your neighbours from noises.

- For installation, choose a place as described below.
 - A place solid enough to bear the weight of the unit which does not amplify the operation noise or vibration.
 - A place from where the air discharged from the outdoor unit or the operation noise will not annoy your neighbours.

Electrical work.

- For power supply, be sure to use a separate power circuit dedicated to the air conditioner.

System relocation.

- Relocating the air conditioner requires specialized knowledge and skills. Please consult the dealer if relocation is necessary for moving or remodeling.

2.2.2 Names of Parts

Names of parts

■ Indoor Unit

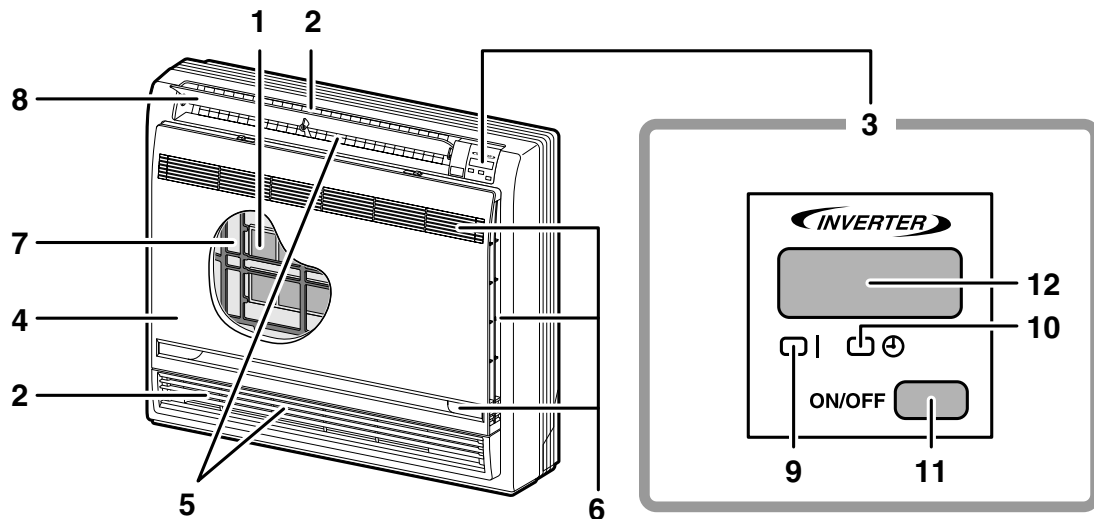

■ Opening the Front Panel

How to open the front panel: (page 26.)

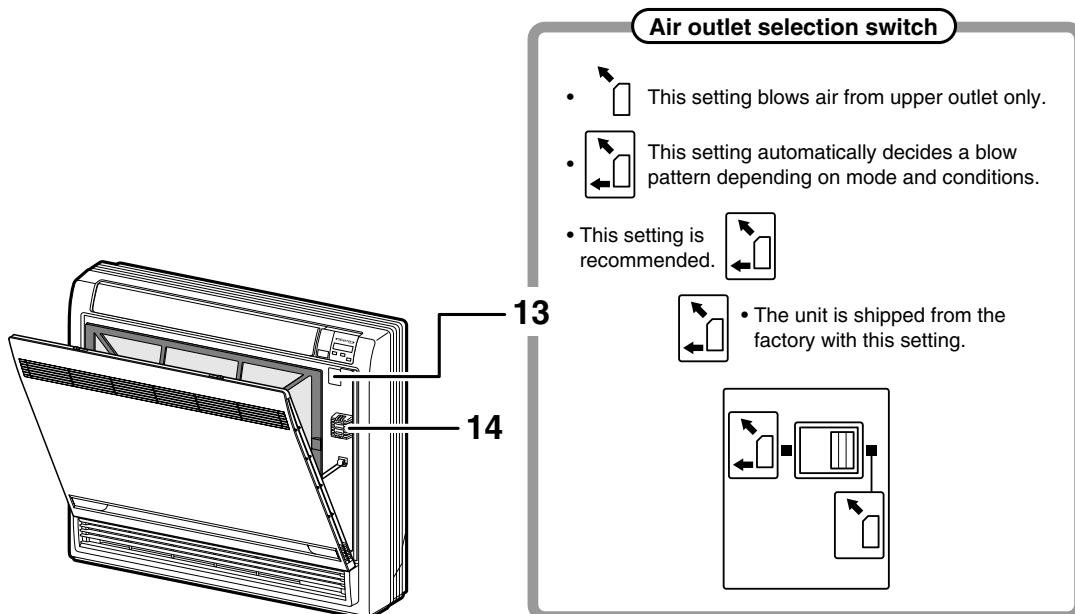

CAUTION

Before opening the front panel, be sure to stop the operation and turn the breaker OFF. Do not touch the metal parts on the inside of the indoor unit, as it may result in injury.

Outdoor Unit

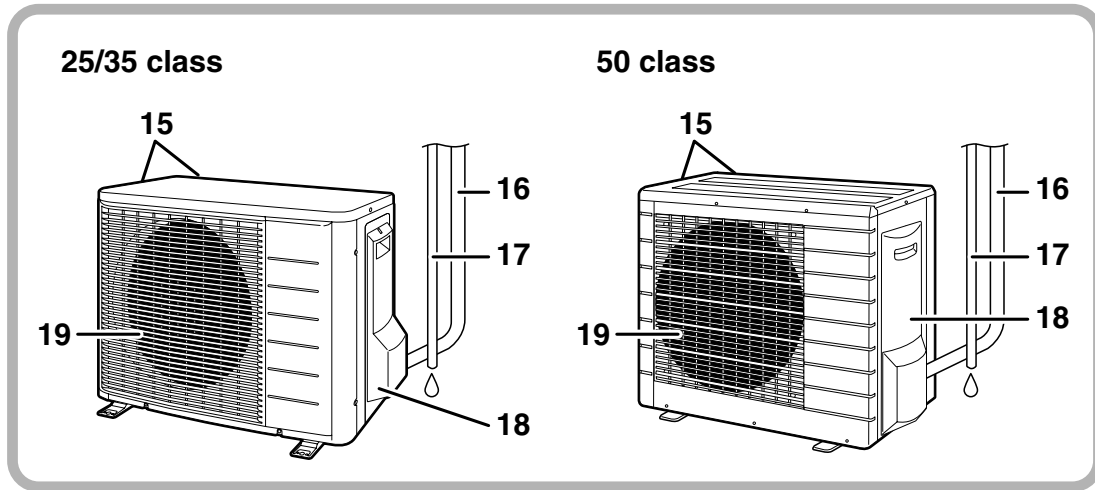

Indoor Unit

1. Titanium Apatite Photocatalytic Air-Purifying Filter:

- These filters are attached to the inside of the air filters.

2. Air outlet

3. Display

4. Front panel

5. Louvers (vertical blades): (page 12.)

- The louvers are inside of the air outlet.

6. Air inlet

7. Air filter

8. Flap (horizontal blade): (page 12.)

9. Operation lamp (green)

10. TIMER lamp (yellow): (page 17.)

11. Indoor Unit ON/OFF switch:

- Push this switch once to start operation. Push once again to stop it.

- The operation mode refers to the following table.

Model	Mode	Temperature setting	Air flow rate
COOLING ONLY	COOL	22°C	AUTO
HEAT PUMP	AUTO	25°C	AUTO

- This switch is useful when the remote controller is missing.

12. Signal receiver:

- It receives signals from the remote controller.
- When the unit receives a signal, you will hear a short beep.
 - Operation start beep-beep
 - Settings changed beep
 - Operation stop..... beeeep

13. Air outlet selection switch: (page 13.)

14. Room temperature sensor:

- It senses the air temperature around the unit.

Outdoor Unit

15. Air inlet: (Back and side)

16. Refrigerant piping and inter-unit cable

17. Drain hose

18. Earth terminal:

- It is inside of this cover.

19. Air outlet

Appearance of the outdoor unit may differ from some models.

■ Remote Controller

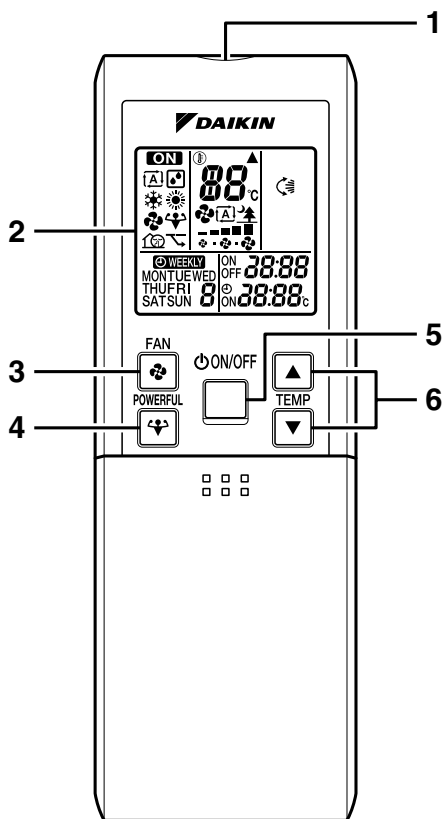

<ARC452A1>

- 1. Signal transmitter:**
 - It sends signals to the indoor unit.
- 2. Display:**
 - It displays the current settings.
(In this illustration, each section is shown with all its displays ON for the purpose of explanation.)
- 3. FAN setting button:**
 - It selects the air flow rate setting.
- 4. POWERFUL button:**
 - POWERFUL operation (page 14.)
- 5. ON/OFF button:**
 - Press this button once to start operation.
Press once again to stop it.
- 6. TEMPERATURE adjustment buttons:**
 - It changes the temperature setting.
- 7. MODE selector button:**
 - It selects the operation mode.
(AUTO/DRY/COOL/HEAT/FAN) (page 10.)
- 8. QUIET button:**
 - OUTDOOR UNIT QUIET operation (page 15.)

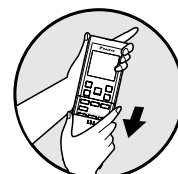

<Open the lid>

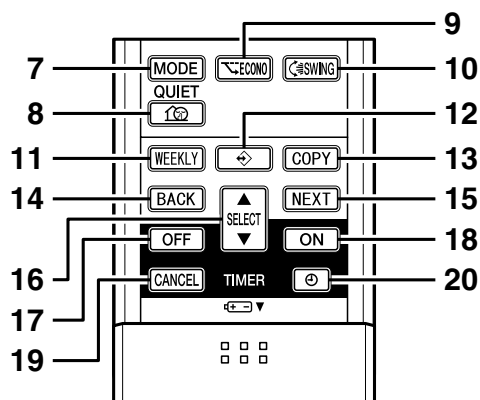

- 9. ECONO button:**
 - ECONO operation (page 16.)
- 10. SWING button:**
 - Adjusting the Air Flow Direction (page 12.)
- 11. WEEKLY button:**
 - WEEKLY TIMER operation (page 19.)
- 12. PROGRAM button:**
 - WEEKLY TIMER operation (page 19.)
- 13. COPY button:**
 - WEEKLY TIMER operation (page 19.)
- 14. BACK button:**
 - WEEKLY TIMER operation (page 19.)
- 15. NEXT button:**
 - WEEKLY TIMER operation (page 19.)
- 16. SELECT button:**
 - It changes the timer setting. (page 17.)
- 17. OFF TIMER button:** (page 17.)
- 18. ON TIMER button:** (page 18.)
- 19. TIMER CANCEL button:**
 - It cancels the timer setting. (page 17, 18.)
 - It cannot be used for the WEEKLY TIMER operation.
- 20. CLOCK button:** (page 8.)

2.2.3 Preparation before Operation

Preparation Before Operation

■ To set the batteries

1. Slide the front cover to take it off.
2. Set two dry batteries (LR03-AAA).
3. Set the front cover as before.

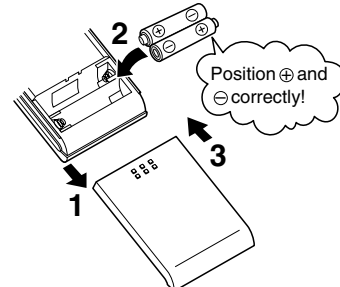

■ To operate the remote controller

- To use the remote controller, aim the transmitter at the indoor unit. If there is anything to block signals between the unit and the remote controller, such as a curtain, the unit will not operate.
- Do not drop the remote controller. Do not get it wet.
- The maximum distance for communication is about 7m.

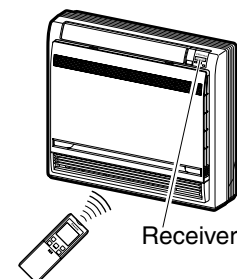

■ To fix the remote controller holder on the wall

1. Choose a place from where the signals reach the unit.
2. Fix the holder to a wall, a pillar, or similar location with the screws procured locally.
3. Place the remote controller in the remote controller holder.

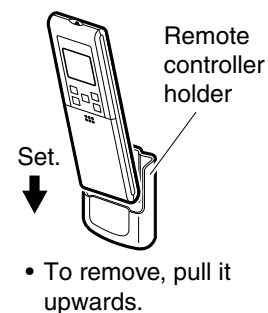

ATTENTION

■ About batteries

- When replacing the batteries, use batteries of the same type, and replace the two old batteries together.
- When the system is not used for a long time, take the batteries out.
- We recommend replacing once a year, although if the remote controller display begins to fade or if reception deteriorates, please replace with new alkaline batteries. Using manganese batteries reduces the lifespan.
- The attached batteries are provided for the initial use of the system.
The usable period of the batteries may be short depending on the manufactured date of the air conditioner.

■ About remote controller

- Never expose the remote controller to direct sunlight.
- Dust on the signal transmitter or receiver will reduce the sensitivity. Wipe off dust with soft cloth.
- Signal communication may be disabled if an electronic-starter-type fluorescent lamp (such as inverter-type lamps) is in the room. Consult the shop if that is the case.
- If the remote controller signals happen to operate another appliance, move that appliance to somewhere else, or consult the shop.

Preparation Before Operation

■ To set the clock

1. Press “CLOCK button”.

0:00 is displayed.

MON and  blinks.

2. Press “SELECT button” to set the current day of the week.

3. Press “CLOCK button”.

 blinks.

4. Press “SELECT button” to set the clock to the present time.

Holding down “▲” or “▼” button rapidly increases or decreases the time display.

5. Press “CLOCK button”.

Always point the remote controller at the indoor unit when pushing the buttons when setting the indoor unit's internal clock.

 blinks.

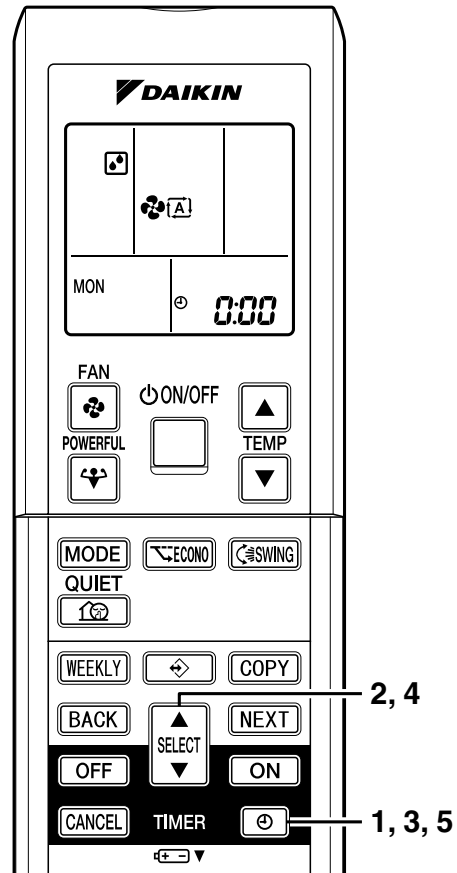

NOTE

- If the indoor unit's internal clock is not set to the correct time, the WEEKLY TIMER will not operate punctually.

■ Turn the breaker ON

- Turning ON the breaker closes the flap. (This is a normal procedure.)

NOTE

■ Tips for saving energy

- Be careful not to cool (heat) the room too much.
Keeping the temperature setting at a moderate level helps save energy.
- Cover windows with a blind or a curtain.
Blocking sunlight and air from outdoors increases the cooling (heating) effect.
- Clogged air filters cause inefficient operation and waste energy.
Clean them once in about every two weeks.

Recommended temperature setting
For cooling: 26°C – 28°C For heating: 20°C – 24°C

■ Please note

- The air conditioner always consumes 15-35 watts of electricity even while it is not operating.
- If you are not going to use the air conditioner for a long period, for example in spring or autumn, turn the breaker OFF.
- Use the air conditioner in the following conditions.

Mode	Operating conditions	If operation is continued out of this range
COOL	Outdoor temperature: (2MK(X)S40/50) 10 to 46°C (2MK(X)S52) –10 to 46°C (3/4/5MK(X)S) –10 to 46°C (RK(X)S) –10 to 46°C Indoor temperature: 18 to 32°C Indoor humidity: 80% max.	<ul style="list-style-type: none"> • A safety device may work to stop the operation. (In multi system, it may work to stop the operation of the outdoor unit only.) • Condensation may occur on the indoor unit and drip.
HEAT	Outdoor temperature: (2MXS40) –10 to 24°C (2MXS50/52) –15 to 24°C (3/4/5MXS) –15 to 24°C (RXS) –15 to 24°C Indoor temperature: 10 to 30°C	<ul style="list-style-type: none"> • A safety device may work to stop the operation.
DRY	Outdoor temperature: (2MK(X)S40/50) 10 to 46°C (2MK(X)S52) –10 to 46°C (3/4/5MK(X)S) –10 to 46°C (RK(X)S) –10 to 46°C Indoor temperature: 18 to 32°C Indoor humidity: 80% max.	<ul style="list-style-type: none"> • A safety device may work to stop the operation. • Condensation may occur on the indoor unit and drip.

- Operation outside this humidity or temperature range may cause a safety device to disable the system.

2.2.4 AUTO · DRY · COOL · HEAT · FAN Operation

AUTO · DRY · COOL · HEAT · FAN Operation

The air conditioner operates with the operation mode of your choice.

From the next time on, the air conditioner will operate with the same operation mode.

■ To start operation

1. Press “MODE selector button” and select a operation mode.

- Each pressing of the button advances the mode setting in sequence.

: AUTO

: DRY

: COOL

: HEAT

: FAN

Cooling only model 

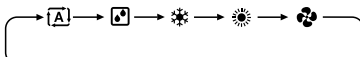
Heat pump model 

2. Press “ON/OFF button”.

- The OPERATION lamp lights up.

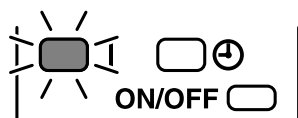

■ To stop operation

3. Press “ON/OFF button” again.

- Then OPERATION lamp goes off.

■ To change the temperature setting



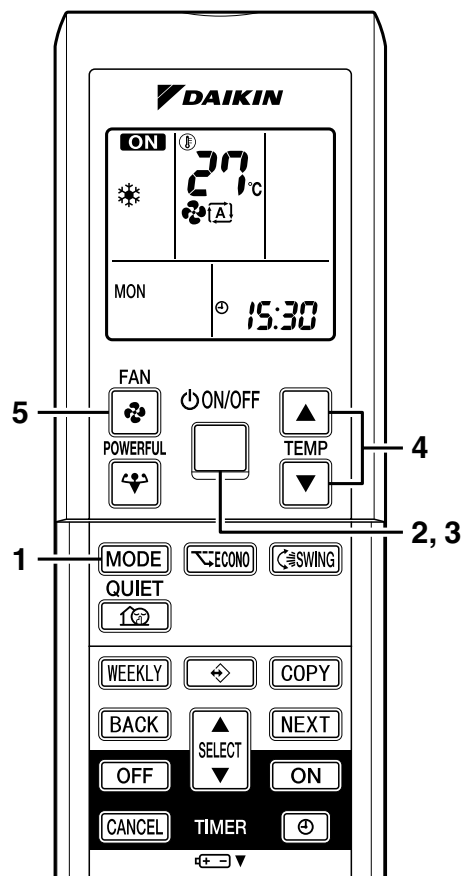

4. Press “TEMPERATURE adjustment button”.

DRY or FAN mode	AUTO or COOL or HEAT mode
The temperature setting is not variable.	Press “▲” to raise the temperature and press “▼” to lower the temperature.
	Set to the temperature you like. 



■ To change the air flow rate setting

5. Press “FAN setting button”.

DRY mode	AUTO or COOL or HEAT or FAN mode
The air flow rate setting is not variable.	Five levels of air flow rate setting from “  ” to “  ” plus “  ” “  ” are available. 

- Indoor unit quiet operation

When the air flow is set to “”, the noise from the indoor unit will become quieter. Use this when making the noise quieter.

The unit might lose capacity when the air flow rate is set to a weak level.

NOTE





- Note on HEAT operation**
 - Since this air conditioner heats the room by taking heat from outdoor air to indoors, the heating capacity becomes smaller in lower outdoor temperatures. If the heating effect is insufficient, it is recommended to use another heating appliance in combination with the air conditioner.
 - The heat pump system heats the room by circulating hot air around all parts of the room. After the start of heating operation, it takes some time before the room gets warmer.
 - In heating operation, frost may occur on the outdoor unit and lower the heating capacity. In that case, the system switches into defrosting operation to take away the frost.
 - During defrosting operation, hot air does not flow out of indoor unit.
- Note on COOL operation**
 - This air conditioner cools the room by blowing the hot air in the room outside, so if the outside temperature is high, performance drops.
- Note on DRY operation**
 - The computer chip works to rid the room of humidity while maintaining the temperature as much as possible. It automatically controls temperature and fan strength, so manual adjustment of these functions is unavailable.
- Note on AUTO operation**
 - In AUTO operation, the system selects a temperature setting and an appropriate operation mode (COOL or HEAT) based on the room temperature at the start of the operation.
 - The system automatically reselects setting at a regular interval to bring the room temperature to user-setting level.
 - If you do not like AUTO operation, you can manually select the operation mode and setting you like.
- Note on air flow rate setting**
 - At smaller air flow rates, the cooling (heating) effect is also smaller.

2.2.5 Adjusting the Air Flow Direction

Adjusting the Air Flow Direction

You can adjust the air flow direction to increase your comfort.

■ To adjust the horizontal blade (flap)

1. Press “SWING button ”.
 - “” is displayed on the LCD and the flaps will begin to swing.
2. When the flap has reached the desired position, press “SWING button ” once more.
 - The flap will stop moving.
 - “” disappears from the LCD.

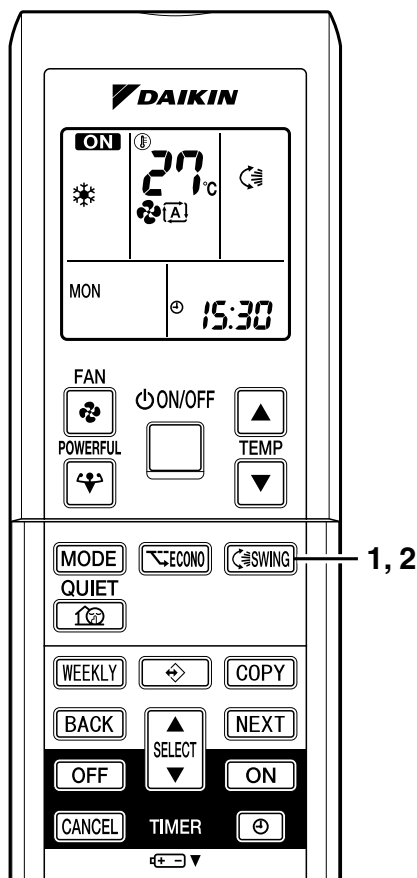

■ To adjust the vertical blades (louvers)

Hold the knob and move the louver.
(You will find a knob on the left-side and the right-side blades.)

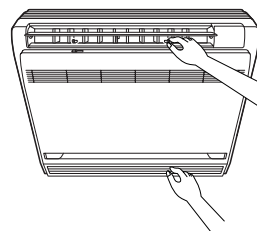

Notes on flap and louvers angle

- Unless “SWING” is selected, you should set the flap at a near-horizontal angle in HEAT mode and at a upward position in COOL or DRY mode to obtain the best performance.

■ ATTENTION

- When adjusting the flap by hand, turn off the unit, and use the remote controller to restart the unit.
- Be careful when adjusting the louvers. Inside the air outlet, a fan is rotating at a high speed.

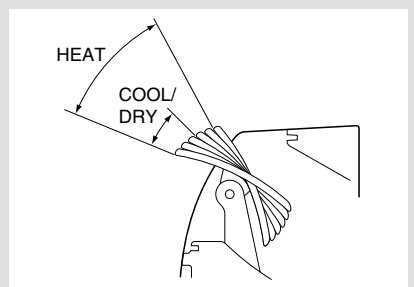

■ Air flow selection

- Make air flow selection according to what suits you.

When setting the air flow selection switch to .

- Air conditioner automatically decides the appropriate blowing pattern depending on the operating mode/situation.

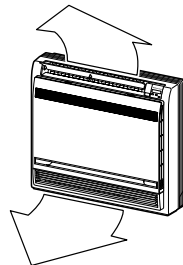
Operating mode	Situation	Blowing pattern
COOL mode	<ul style="list-style-type: none"> • When the room has become fully cool, or when one hour has passed since turning on the air conditioner. 	<ul style="list-style-type: none"> • So that air does not come into direct contact with people, air is blown upper air outlet, room temperature is equalized.
	<ul style="list-style-type: none"> • At start of operation or other times when the room is not fully cooled. 	<div style="text-align: center;">  </div> <ul style="list-style-type: none"> • Air is blown from the upper and lower air outlets for high speed cooling during COOL mode, and for filling the room with warm air during HEAT mode.
HEAT mode	<ul style="list-style-type: none"> • At times other than below. (Normal time.) 	
	<ul style="list-style-type: none"> • At start or when air temperature is low. 	<ul style="list-style-type: none"> • So that air does not come into direct contact with people. Air is blown upper air outlet.

- During Dry mode, so that cold air does not come into direct contact with people, air is blown upper air outlet.

When setting the air outlet selection switch to .

- Regardless of the operating mode or situation, air blows from the upper air outlet.
- Use this switch when you do not want air coming out of the lower air outlet. (While sleeping etc.)

CAUTION

- Do not try to adjust the flap by hand.
- When adjusting by hand, the mechanism may not operate properly or condensation may drip from air outlets.

2.2.6 POWERFUL Operation

POWERFUL Operation

POWERFUL operation quickly maximizes the cooling (heating) effect in any operation mode. You can get the maximum capacity.

■ To start POWERFUL operation

1. Press “POWERFUL button”.

- POWERFUL operation ends in 20minutes. Then the system automatically operates again with the settings which were used before POWERFUL operation.
- When using POWERFUL operation, there are some functions which are not available.
- “” is displayed on the LCD.

■ To cancel POWERFUL operation

2. Press “POWERFUL button” again.

- “” disappears from the LCD.

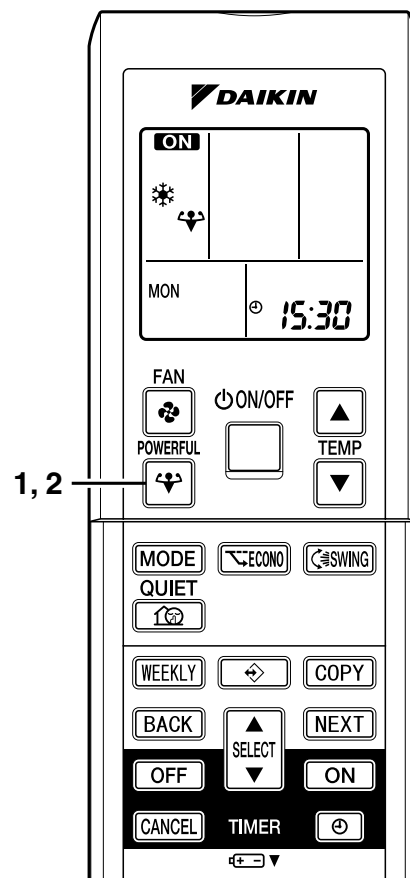

NOTE

■ Notes on POWERFUL operation

- POWERFUL Operation cannot be used together with ECONO or QUIET Operation. Priority is given to the function of whichever button is pressed last.
- POWERFUL Operation can only be set when the unit is running. Pressing the operation stop button causes the settings to be canceled, and the “” disappears from the LCD.
- **In COOL and HEAT mode**
To maximize the cooling (heating) effect, the capacity of outdoor unit must be increased and the air flow rate be fixed to the maximum setting.
The temperature and air flow settings are not variable.
- **In DRY mode**
The temperature setting is lowered by 2.5°C and the air flow rate is slightly increased.
- **In FAN mode**
The air flow rate is fixed to the maximum setting.
- **When using priority-room setting**
See “Note for multi system”.

2.2.7 OUTDOOR UNIT QUIET Operation

OUTDOOR UNIT QUIET Operation

OUTDOOR UNIT QUIET operation lowers the noise level of the outdoor unit by changing the frequency and fan speed on the outdoor unit. This function is convenient during night.

■ To start OUTDOOR UNIT QUIET operation

1. Press “QUIET button”.

- “” is displayed on the LCD.

■ To cancel OUTDOOR UNIT QUIET operation

2. Press “QUIET button” again.

- “” disappears from the LCD.

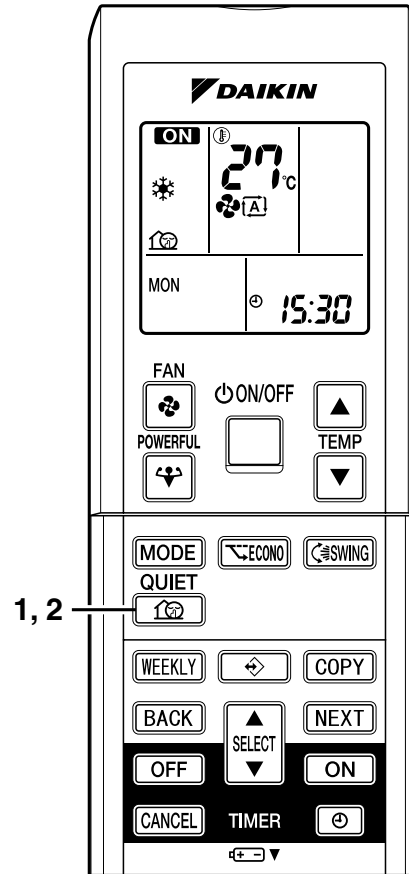

NOTE

■ Note on OUTDOOR UNIT QUIET operation

- If using a multi system, this function will work only when the OUTDOOR UNIT QUIET operation is set on all operated indoor units. However, if using priority-room setting, see “Note for multi system”
- This function is available in COOL, HEAT, and AUTO modes. (This is not available in FAN and DRY mode.)
- POWERFUL operation and OUTDOOR UNIT QUIET operation cannot be used at the same time. Priority is given to the function of whichever button is pressed last.
- If operation is stopped using the remote controller or the main unit ON/OFF switch when using OUTDOOR UNIT QUIET operation, “” will remain on the remote controller display.

2.2.8 ECONO Operation

ECONO Operation

ECONO operation is a function which enables efficient operation by lowering the maximum power consumption value.

■ To start ECONO operation

1. Press “ECONO button”.
 - “” is displayed on the LCD.

■ To cancel ECONO operation

2. Press “ECONO button” again.
 - “” disappears from the LCD.

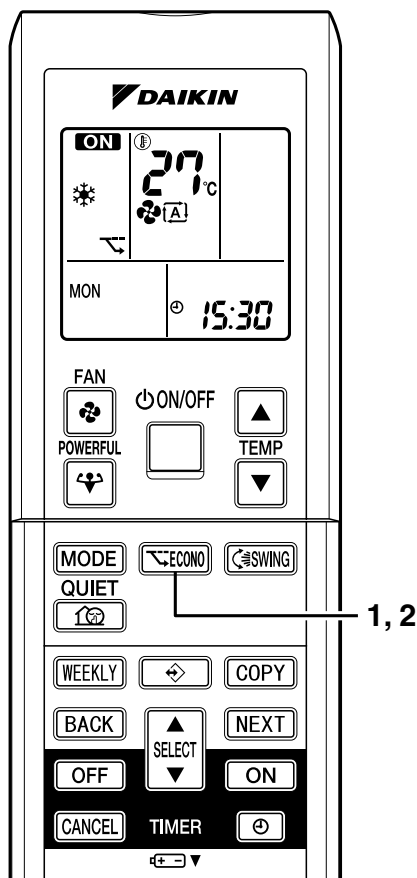

NOTE

- ECONO Operation can only be set when the unit is running. Pressing the operation stop button causes the settings to be canceled, and the “” disappears from the LCD.
- ECONO operation is a function which enables efficient operation by limiting the power consumption of the outdoor unit (operating frequency).
- ECONO operation functions in AUTO, COOL, DRY, and HEAT modes.
- POWERFUL operation and ECONO operation cannot be used at the same time. Priority is given to the function of whichever button is pressed last.
- Power consumption may not drop even if ECONO operation is used, when the level of power consumption is already low.

2.2.9 TIMER Operation

TIMER Operation

Timer functions are useful for automatically switching the air conditioner on or off at night or in the morning. You can also use OFF TIMER and ON TIMER in combination.

■ To use OFF TIMER operation

- Check that the clock is correct. If not, set the clock to the present time. (page 8.)

1. Press “OFF TIMER button”.

0:00 is displayed.

OFF blinks.

2. Press “SELECT button” until the time setting reaches the point you like.

- Every pressing of either button increases or decreases the time setting by 10 minutes. Holding down either button changes the setting rapidly.

3. Press “OFF TIMER button” again.

- The TIMER lamp lights up.

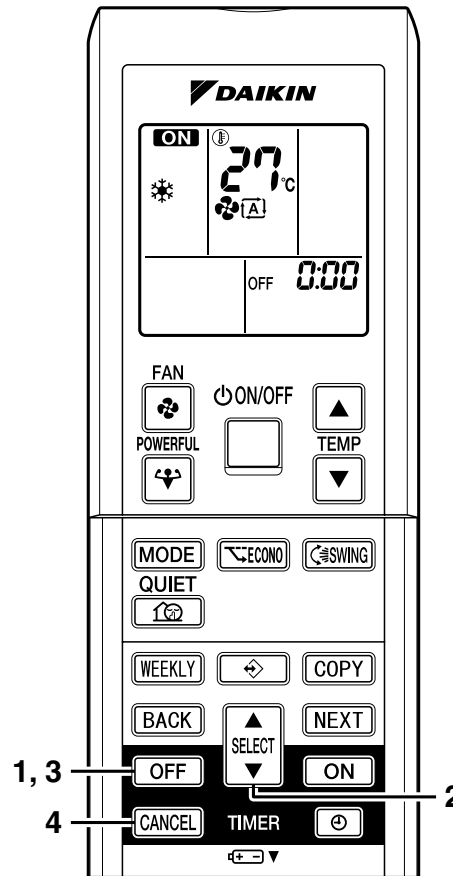
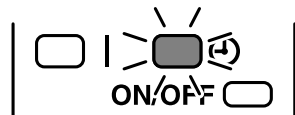

■ To cancel the OFF TIMER Operation

4. Press “CANCEL button”.

- The TIMER lamp goes off.

NOTE

- When TIMER is set, the present time is not displayed.
- Once you set ON, OFF TIMER, the time setting is kept in the memory. (The memory is canceled when remote controller batteries are replaced.)
- When operating the unit via the ON/OFF Timer, the actual length of operation may vary from the time entered by the user. (Maximum approx. 10 minutes)

■ NIGHT SET MODE

When the OFF TIMER is set, the air conditioner automatically adjusts the temperature setting (0.5°C up in COOL, 2.0°C down in HEAT) to prevent excessive cooling (heating) for your pleasant sleep.

TIMER Operation

■ To use ON TIMER operation

- Check that the clock is correct. If not, set the clock to the present time. (page 8.)

1. Press “ON TIMER button”.

6:00 is displayed.

ON blinks.

2. Press “SELECT button” until the time setting reaches the point you like.

- Every pressing of either button increases or decreases the time setting by 10 minutes. Holding down either button changes the setting rapidly.

3. Press “ON TIMER button” again.

- The TIMER lamp lights up.

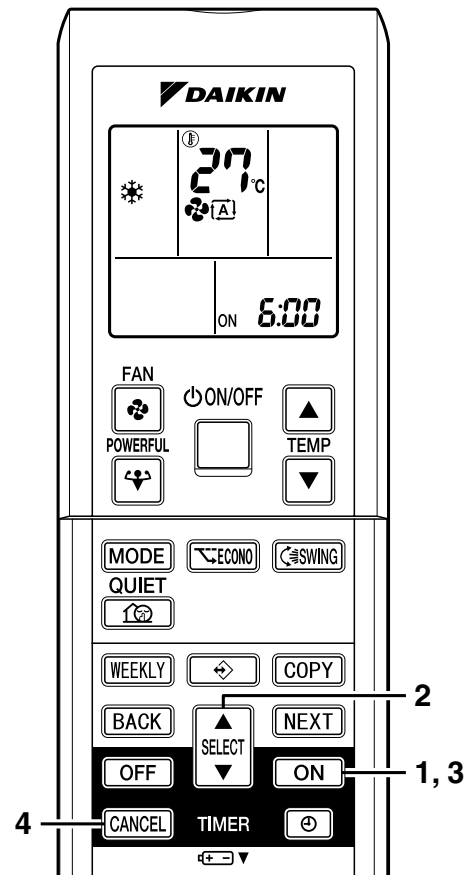
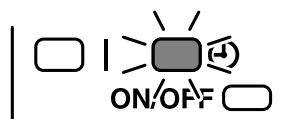

■ To cancel ON TIMER operation

4. Press “CANCEL button”.

- The TIMER lamp goes off.

■ To combine ON TIMER and OFF TIMER

- A sample setting for combining the two timers is shown below.

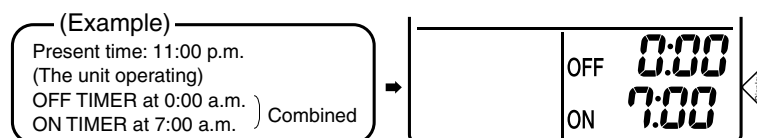

ATTENTION

- In the following cases, set the timer again.
 - After a breaker has turned OFF.
 - After a power failure.
 - After replacing batteries in the remote controller.

2.2.10 WEEKLY TIMER Operation

WEEKLY TIMER Operation

Up to 4 timer settings can be saved for each day of the week.

■ To use WEEKLY TIMER operation

- Make sure the day of the week and time are set. If not, set the day of the week and time. (page 8.)
- The following procedure is to make a reservation on Monday for Tuesday 6:00 am/27°C.

1. Press “” button”.

- The day of the week and the reservation number will be displayed.
- 1 to 4 settings can be made per day.



2. Press the “SELECT button” to select the desired day of the week and reservation number.

- Pressing the “SELECT button” changes the reservation number and the day of the week.

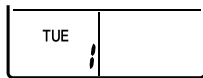

3. Press “NEXT button”.

- The day of the week will be set.
- “ WEEKLY” and “ON” blink.



4. Press “SELECT button” to select the desired mode.

- “ WEEKLY” and “ON” or “OFF” will flash.

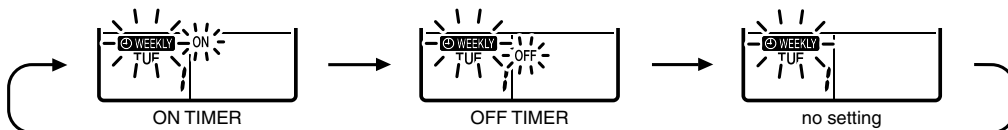

- To go to the next reservation setting, select “no setting”.

5. Press “NEXT button”.

- The weekly mode will be set.
- “ WEEKLY” and “6:00” blink.

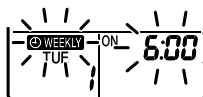

6. Press “SELECT button” to select the desired time.

- The time can be set between 0:00 and 23:50 in 10 minute intervals.
- Press “BACK button” to return to the mode setting.

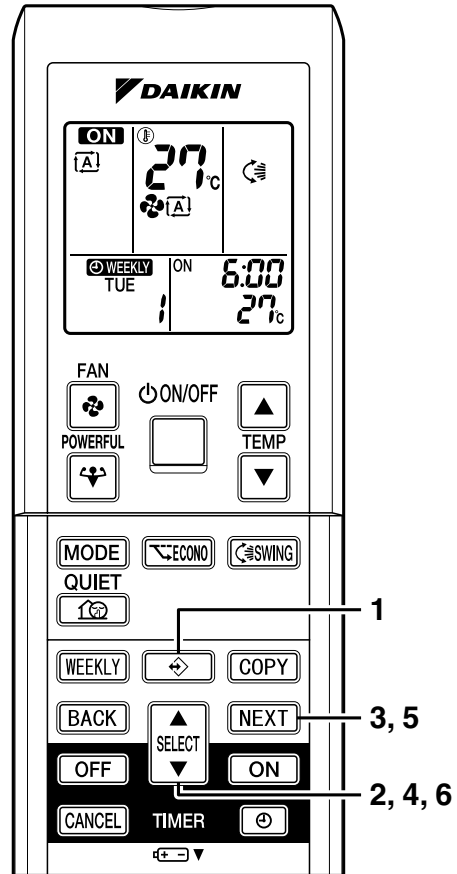

WEEKLY TIMER Operation

7. Press “NEXT button”.

- The time will be set.
- “ WEEKLY” and the temperature blink.

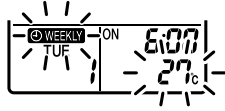

8. Press “SELECT button” to select the desired temperature.

- The temperature can be set between 10°C and 32°C.
- To return to the time setting, press “BACK button”.
- The set temperature is only displayed when the mode setting is on.

9. Press “NEXT button”.

- The temperature will be set.
- The temperature will be set and go to the next reservation setting.
- Set the following using the same procedures.

10. Press “ button” to complete the setting.

- Point the remote controller toward the air conditioner and press the buttons to operate. The air conditioner will beep and the operation lamp will flash.

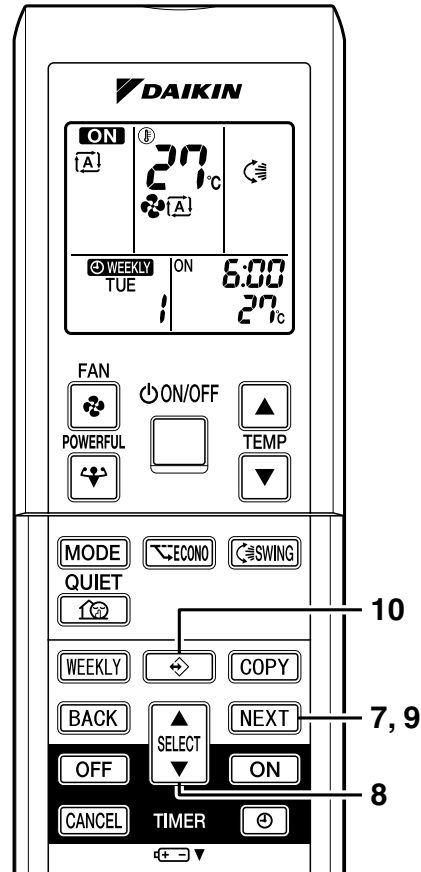

■ To cancel WEEKLY TIMER operation

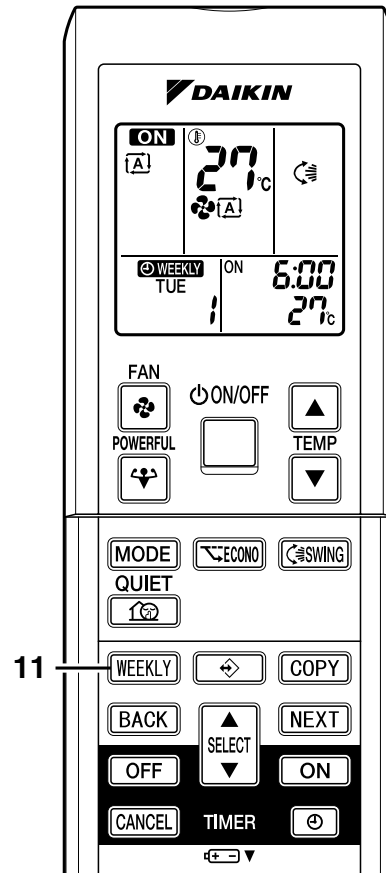

11. Press “WEEKLY button” to deactivate the WEEKLY operation.

- The “ WEEKLY” will disappear from the display.
- The TIMER lamp goes off.
- To reactivate the WEEKLY TIMER operation, press the “WEEKLY button” again.



NOTE

■ WEEKLY TIMER

- Do not forget to set the time on the remote control first.
- The day of the week, time and ON/OFF can be set with WEEKLY TIMER. For ON-TIMER, settings other than the above are based on the remote controller settings just before the operation.
- The “WEEKLY button” activates or deactivates the reservation.
- To set WEEKLY TIMER, press “” button” and make a reservation according to the procedures.
- Only the time and set temperature set with the weekly timer are sent with the “” button”. Set the weekly timer only after setting the operation mode, the fan strength, and the fan direction ahead of time.
- Up to 4 settings per day and up to 28 settings per week can be reserved with WEEKLY TIMER. If a reservation deactivated with “WEEKLY button” is activated once again, the last reservation made will be used.
- Cooling: The unit operates at 18°C even if it is set at 10 to 17°C.
- Heating: The unit operates at 30°C even if it is set at 31 to 32°C.
- Shutting the breaker off, power outages, and other similar events will render operation of the indoor unit’s internal clock inaccurate. Reset the clock. (page 8.)
- The “BACK button” can be used only for the mode, time and temperature settings. It cannot be used to go back to the reservation number.

WEEKLY TIMER Operation

■ Confirming a reservation

- The reservation can be confirmed.

1. Press “ button”.

- The day of the week and the reservation number of the current day will be displayed.

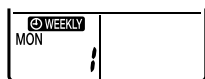

2. Press “SELECT button” to select the day of the week and the reservation number to be confirmed.

- Pressing the “SELECT button” displays the reservation details.

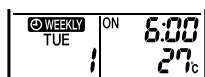

3. Press “ button”.

- Reservation confirmation complete.

■ Canceling all reservations

4. Hold the “WEEKLY button” for 5 seconds.

- Be sure to direct the remote control toward the main unit and check for a receiving tone.
- This operation is not effective while WEEKLY TIMER is being set.
- All reservations will be canceled.

■ Canceling individual reservations

- This function can be used for canceling reservations for each day of the week.
- It can be used while confirming or setting reservations.

5. Select the day of the week to be canceled with the “SELECT button”.

6. Hold the “WEEKLY button” for 5 seconds.

- The selected reservation will be canceled.

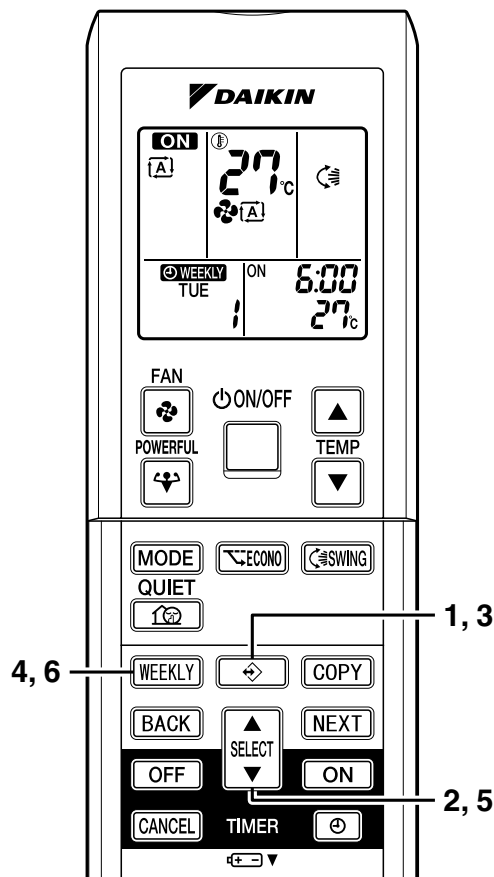

■ Setting WEEKLY TIMER using copy mode

- A reservation made once can be easily copied and the same settings used for another day of the week.

1. Press “ button”.
2. Press “SELECT button” to confirm the day of the week to be copied.

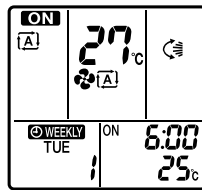

3. Press “COPY button”.
 - This activates copy mode.
 - Copy whole reservation of the selected day of the week.
4. Press “SELECT button” to select the destination day of the week.

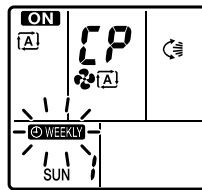

5. Press “COPY button”.
 - The reservation will be copied to the selected day of the week. The whole reservation of the selected day of the week will be copied.
 - The reservation can be copied to another day of the week in succession.

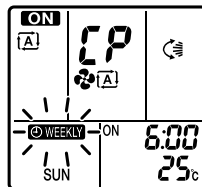

6. Press “ button”.
 - Exit copy mode.

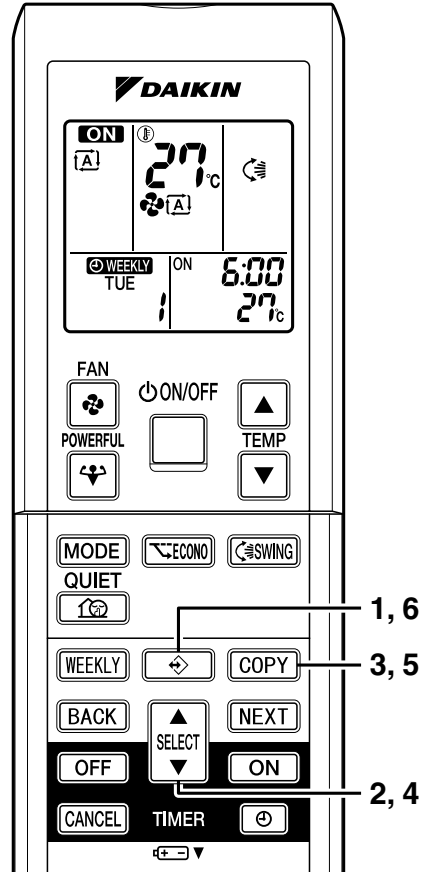

NOTE

■ COPY MODE

- The entire reservation of the source day of the week is copied in the copy mode. Detailed settings can be made after the copy is completed.
- Both WEEKLY TIMER and ON/OFF timer cannot be used at the same time. The ON/OFF timer has priority if it is set while WEEKLY TIMER is still active. WEEKLY TIMER is activated after the reserved ON/OFF timer is completed.

2.2.11 Note for Multi System

Note for Multi System

<< What is a “Multi System”? >>

This system has one outdoor unit connected to multiple indoor units.

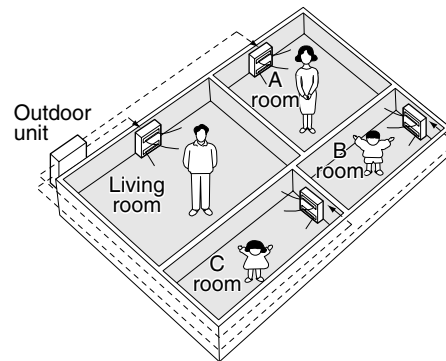

■ Selecting the operation mode

1. With the Priority Room Setting present but inactive or not present.

When more than one indoor unit is operating, priority is given to the first unit that was turned on. In this case, set the units that are turned on later to the same operation mode (*1) as the first unit.

Otherwise, they will enter the Standby Mode, and the operation lamp will flash; this does not indicate malfunction.

(*1)

- COOL, DRY and FAN mode may be used at the same time.
- AUTO mode automatically selects COOL mode or HEAT mode based on the room temperature. Therefore, AUTO mode is available when selecting the same operation mode as that of the room with the first unit to be turned on.

CAUTION

Normally, the operation mode in the room where the unit is first run is given priority, but the following situations are exceptions, so please keep this in mind.

If the operation mode of the first room is **FAN Mode**, then using **Heating Mode** in any room after this will give priority to **heating**. In this situation, the air conditioner running in FAN Mode will go on standby, and the operation lamp will flash.

2. With the Priority Room Setting active.

See “Priority Room Setting” on the next page.

■ NIGHT QUIET Mode (Available only for cooling operation)

NIGHT QUIET Mode requires initial programming during installation. Please consult your retailer or dealer for assistance. NIGHT QUIET Mode reduces the operation noise of the outdoor unit during the night time hours to prevent annoyance to neighbors.

- The NIGHT QUIET Mode is activated when the temperature drops 5°C or more below the highest temperature recorded that day. Therefore, when the temperature difference is less than 5°C, this function will not be activated.
- NIGHT QUIET Mode reduces slightly the cooling (heating) efficiency of the unit.

■ OUTDOOR UNIT QUIET operation (page 15.)

1. With the Priority Room Setting present but inactive or not present.

When using the OUTDOOR UNIT QUIET operation feature with the Multi system, set all indoor units to OUTDOOR UNIT QUIET operation using their remote controllers.

When clearing OUTDOOR UNIT QUIET operation, clear one of the operating indoor units using their remote controller. However OUTDOOR UNIT QUIET operation display remains on the remote controller for other rooms. We recommend you release all rooms using their remote controllers.

2. With the Priority Room Setting active.

See “Priority Room Setting” on the next page.

■ Cooling / Heating mode lock (Available only for heat pump models)

The Cooling / Heating Mode Lock requires initial programming during installation. Please consult your retailer or dealer for assistance. The Cooling / Heating Mode Lock sets the unit forcibly to either Cooling or Heating Mode. This function is convenient when you wish to set all indoor units connected to the Multi system to the same operation mode.

■ Priority Room Setting

The Priority Room Setting requires initial programming during installation. Please consult your retailer or dealer for assistance.

The room designated as the Priority Room takes priority in the following situations;

1. Operation mode Priority.

As the operation mode of the Priority Room takes precedence, the user can select a different operation mode from other rooms.

〈Example〉

* Room A is the Priority Room in the examples.

When COOL mode is selected in Room A while operating the following modes in Room B,C and D:

Operation mode in Room B, C and D	Status of Room B, C and D when the unit in Room A is in COOL mode
COOL or DRY or FAN	Current operation mode maintained
HEAT	The unit enters Standby Mode. Operation resumes when the Room A unit stops operating.
AUTO	If the unit is set to COOL mode, operation continues. If set to HEAT mode, it enters Standby Mode. Operation resumes when the Room A unit stops operating.

2. Priority when POWERFUL operation is used.

〈Example〉

* Room A is the Priority Room in the examples.

The indoor units in Rooms A,B,C and D are all operating. If the unit in Room A enters POWERFUL operation, operation capacity will be concentrated in Room A. In such a case, the cooling (heating) efficiency of the units in Rooms B,C and D may be slightly reduced.

3. Priority when using OUTDOOR UNIT QUIET operation.

〈Example〉

* Room A is the Priority Room in the examples.

Just by setting the unit in Room A to QUIET operation, the air conditioner starts OUTDOOR UNIT QUIET operation.

You don't have to set all the operated indoor units to QUIET operation.

2.2.12 Care and Cleaning

Care and Cleaning

⚠ CAUTION Before cleaning, be sure to stop the operation and turn the breaker OFF.

Units

■ Indoor unit, Outdoor unit and Remote controller

1. Wipe them with dry soft cloth.

■ Front panel

1. **Open the front panel.**
 - Slide the two stoppers on the left and right sides inward until they click.
2. **Remove the front panel.**
 - Remove the string.
 - Allowing the front panel to fall forward will enable you to remove it.
3. **Clean the front panel.**
 - Wipe it with a soft cloth soaked in water.
 - Only neutral detergent may be used.
 - In case of washing the front panel with water, dry it with cloth, dry it up in the shade after washing.
4. **Attach the front panel.**
 - Insert the front panel into the grooves of the unit (3 places).
 - Attach the string to the right, inner-side of the front grille.
 - Close the panel slowly.

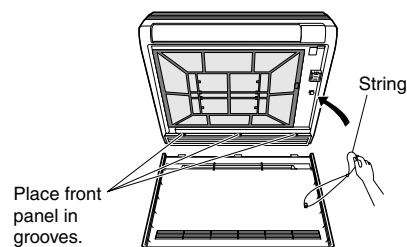
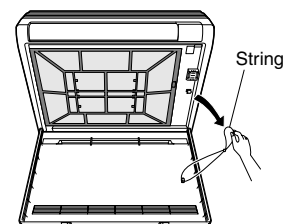
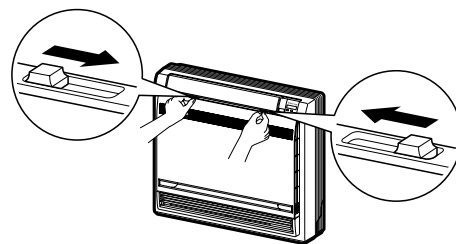

⚠ CAUTION

- Don't touch the metal parts of the indoor unit. If you touch those parts, this may cause an injury.
- When removing or attaching the front panel, use a robust and stable stool and watch your steps carefully.
- When removing or attaching the front panel, support the panel securely with hand to prevent it from falling.
- For cleaning, do not use hot water above 40°C, benzine, gasoline, thinner, nor other volatile oils, polishing compound, scrubbing brushes, nor other hand stuff.
- After cleaning, make sure that the front panel is securely fixed.

Filters

1. **Open the front panel. (page 26.)**
2. **Remove the air filter.**
 - Press the claws on the right and left of the air filter down slightly, then pull upward.
3. **Take off the Titanium Apatite Photocatalytic Air-Purifying Filter.**
 - Hold the tabs of the frame, and remove the claws in 4 places.
4. **Clean or replace each filter.**

See figure.
5. **Set the air filter and Titanium Apatite Photocatalytic Air-Purifying Filter as they were and close the front panel.**
 - Operation without air filters may result in troubles as dust will accumulate inside the indoor unit.

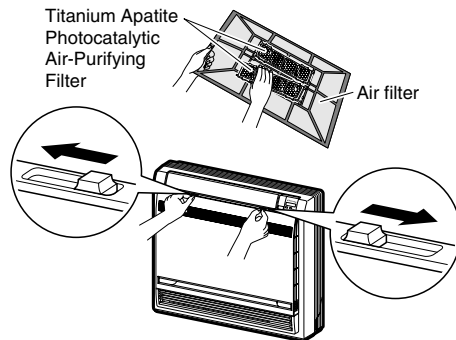
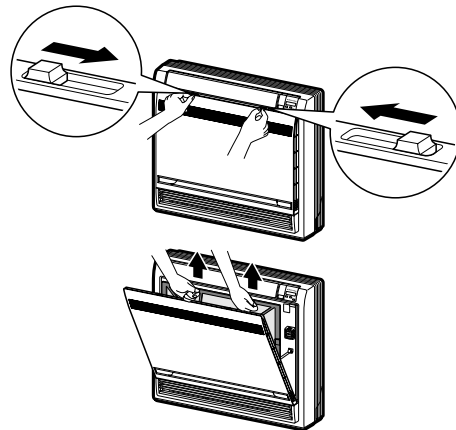

■ **Air Filter**

1. **Wash the air filters with water or clean them with vacuum cleaner.**
 - If the dust does not come off easily, wash them with neutral detergent thinned with lukewarm water, then dry them up in the shade.
 - It is recommended to clean the air filters every 2 weeks.

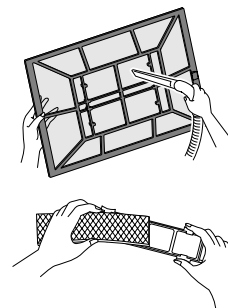

■ **Titanium Apatite Photocatalytic Air-Purifying Filter**

The Titanium Apatite Photocatalytic Air-Purifying Filter can be renewed by washing it with water once every 6 months. We recommend replacing it once every 3 years.

[**Maintenance**]

1. **Vacuum dusts, and soak in warm water or water for about 10 to 15 minutes if dirt is heavy.**
2. **Do not remove filter from frame when washing with water.**
3. **After washing, shake off remaining water and dry in the shade.**
4. **Since the material is made out of paper, do not wring out the filter when removing water from it.**

[**Replacement**]

1. **Remove the tabs on the filter frame and replace with a new filter.**
 - Dispose of the old filter as flammable waste.

NOTE

- Operation with dirty filters:
 (1) cannot deodorize the air. (2) cannot clean the air.
 (3) results in poor heating or cooling. (4) may cause odour.
- To order Titanium Apatite Photocatalytic Air-Purifying Filter contact to the service shop there you bought the air conditioner.
- Dispose of the old filter as flammable waste.

Item	Part No.
Titanium Apatite Photocatalytic Air-Purifying Filter (without frame) 1 set	KAF968A42

Check

Check that the base, stand and other fittings of the outdoor unit are not decayed or corroded.
Check that nothing blocks the air inlets and the outlets of the indoor unit and the outdoor unit.
Check that the drain comes smoothly out of the drain hose during COOL or DRY operation. <ul style="list-style-type: none"> • If no drain water is seen, water may be leaking from the indoor unit. Stop operation and consult the service shop if this is the case.

■ Before a long idle period

1. Operate the “FAN only” for several hours on a fine day to dry out the inside.
 - Press “MODE” button and select “FAN” operation.
 - Press “ON/OFF” button and start operation.
2. After operation stops, turn off the breaker for the room air conditioner.
3. Clean the air filters and set them again.
4. Take out batteries from the remote controller.

NOTE

- When a multi outdoor unit is connected, make sure the heating operation is not used at the other room before you use the fan operation. (page 24.)

2.2.13 Troubleshooting

Trouble Shooting

These cases are not troubles.

The following cases are not air conditioner troubles but have some reasons. You may just continue using it.

Case	Explanation
Operation does not start soon. <ul style="list-style-type: none"> • When ON/OFF button was pressed soon after operation was stopped. • When the mode was reselected. 	<ul style="list-style-type: none"> • This is to protect the air conditioner. You should wait for about 3 minutes.
Hot air does not flow out soon after the start of heating operation.	<ul style="list-style-type: none"> • The air conditioner is warming up. You should wait for 1 to 4 minutes. (The system is designed to start discharging air only after it has reached a certain temperature.)
The heating operation stops suddenly and a flowing sound is heard.	<ul style="list-style-type: none"> • The system is taking away the frost on the outdoor unit. You should wait for about 4 to 12 minutes.
The outdoor unit emits water or steam.	<ul style="list-style-type: none"> ■ In HEAT mode <ul style="list-style-type: none"> • The frost on the outdoor unit melts into water or steam when the air conditioner is in defrost operation. ■ In COOL or DRY mode <ul style="list-style-type: none"> • Moisture in the air condenses into water on the cool surface of outdoor unit piping and drips.
Mist comes out of the indoor unit.	<ul style="list-style-type: none"> ■ This happens when the air in the room is cooled into mist by the cold air flow during cooling operation. ■ This is because the air in the room is cooled by the heat exchanger and becomes mist during defrost operation.
The indoor unit gives out odour.	<ul style="list-style-type: none"> ■ This happens when smells of the room, furniture, or cigarettes are absorbed into the unit and discharged with the air flow. (If this happens, we recommend you to have the indoor unit washed by a technician. Consult the service shop where you bought the air conditioner.)
The outdoor fan rotates while the air conditioner is not in operation.	<ul style="list-style-type: none"> ■ After operation is stopped: <ul style="list-style-type: none"> • The outdoor fan continues rotating for another 60 seconds for system protection. ■ While the air conditioner is not in operation: <ul style="list-style-type: none"> • When the outdoor temperature is very high, the outdoor fan starts rotating for system protection.
The operation stopped suddenly. (OPERATION lamp is on.)	<ul style="list-style-type: none"> ■ For system protection, the air conditioner may stop operating on a sudden large voltage fluctuation. It automatically resumes operation in about 3 minutes.

Check again.

Please check again before calling a repair person.

Case	Check
The air conditioner does not operate. (OPERATION lamp is off.)	<ul style="list-style-type: none"> • Hasn't a breaker turned OFF or a fuse blown? • Isn't it a power failure? • Are batteries set in the remote controller? • Is the timer setting correct?
Cooling (Heating) effect is poor.	<ul style="list-style-type: none"> • Are the air filters clean? • Is there anything to block the air inlet or the outlet of the indoor and the outdoor units? • Is the temperature setting appropriate? • Are the windows and doors closed? • Are the air flow rate and the air direction set appropriately?
Operation stops suddenly. (OPERATION lamp flashes.)	<ul style="list-style-type: none"> • Are the air filters clean? • Is there anything to block the air inlet or the outlet of the indoor and the outdoor units? Clean the air filters or take all obstacles away and turn the breaker OFF. Then turn it ON again and try operating the air conditioner with the remote controller. If the lamp still flashes, call the service shop where you bought the air conditioner. • Are operation modes all the same for indoor units connected to outdoor units in the multi system? If not, set all indoor units to the same operation mode and confirm that the lamps flash. Moreover, when the operation mode is in "AUTO", set all indoor unit operation modes to "COOL" or "HEAT" for a moment and check again that the lamps are normal. If the lamps stop flashing after the above steps, there is no malfunction. (page 24.)
An abnormal functioning happens during operation.	<ul style="list-style-type: none"> • The air conditioner may malfunction with lightning or radio waves. Turn the breaker OFF, turn it ON again and try operating the air conditioner with the remote controller.
Attempted heating, but the unit would not accept the instruction.	<ul style="list-style-type: none"> • When selecting heating, warning beeps are heard, the main unit operating lamp (green) blinks for 5 seconds, and the current operating status is maintained.
The remote controller allows selection of "heating" even though the unit is cooling only model.	<p>Check the specifications of the outdoor unit. If the outdoor unit is cooling only model, set the remote controller for a cooling only model using the cooling only/heat pump switch on the remote controller.</p> <p>If you do not know how to switch the setting, contact the service shop where you purchased the air conditioner.</p>
Heating cannot be selected, even though the unit is heat pump model.	<ul style="list-style-type: none"> • Set the remote controller so that it is for a heat pump model by using the cooling only/heat pump switch on the remote controller. If you do not know how to switch the setting, contact the service shop where you purchased the air conditioner.

Call the service shop immediately.



WARNING

- When an abnormality (such as a burning smell) occurs, stop operation and turn the breaker OFF. Continued operation in an abnormal condition may result in troubles, electric shocks or fire. Consult the service shop where you bought the air conditioner.
- Do not attempt to repair or modify the air conditioner by yourself. Incorrect work may result in electric shocks or fire. Consult the service shop where you bought the air conditioner.

If one of the following symptoms takes place, call the service shop immediately.

<ul style="list-style-type: none"> ■ The power cord is abnormally hot or damaged. ■ An abnormal sound is heard during operation. ■ The safety breaker, a fuse, or the earth leakage breaker cuts off the operation frequently. ■ A switch or a button often fails to work properly. ■ There is a burning smell. ■ Water leaks from the indoor unit. 		<p>Turn the breaker OFF and call the service shop.</p>
---	--	--

<ul style="list-style-type: none"> ■ After a power failure The air conditioner automatically resumes operation in about 3 minutes. You should just wait for a while. 	<ul style="list-style-type: none"> ■ Lightning If lightning may strike the neighbouring area, stop operation and turn the breaker OFF for system protection.
--	--

Disposal requirements

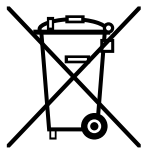

Your air conditioning product is marked with this symbol. This means that electrical and electronic products shall not be mixed with unsorted household waste.

Do not try to dismantle the system yourself: the dismantling of the air conditioning system, treatment of the refrigerant, of oil and of other parts must be done by a qualified installer in accordance with relevant local and national legislation.

Air conditioners must be treated at a specialized treatment facility for re-use, recycling and recovery. By ensuring this product is disposed of correctly, you will help to prevent potential negative consequences for the environment and human health. Please contact the installer or local authority for more information.

Batteries must be removed from the remote controller and disposed of separately in accordance with relevant local and national legislation.

We recommend periodical maintenance.

In certain operating conditions, the inside of the air conditioner may get foul after several seasons of use, resulting in poor performance. It is recommended to have periodical maintenance by a specialist aside from regular cleaning by the user. For specialist maintenance, contact the service shop where you bought the air conditioner. The maintenance cost must be born by the user.

Important information regarding the refrigerant used.

This product contains fluorinated greenhouse gases covered by the Kyoto Protocol.

Refrigerant type: **R410A**

GWP⁽¹⁾ value: **1975**

⁽¹⁾ GWP = global warming potential

Periodical inspections for refrigerant leaks may be required depending on European or local legislation. Please contact your local dealer for more information.

Fault diagnosis.

FAULT DIAGNOSIS BY REMOTE CONTROLLER

In the ARC452A series, the temperature display sections on the main unit indicate corresponding codes.

1. When the **TIMER CANCEL** button is held down for 5 seconds, a “00” indication flashes on the temperature display section.

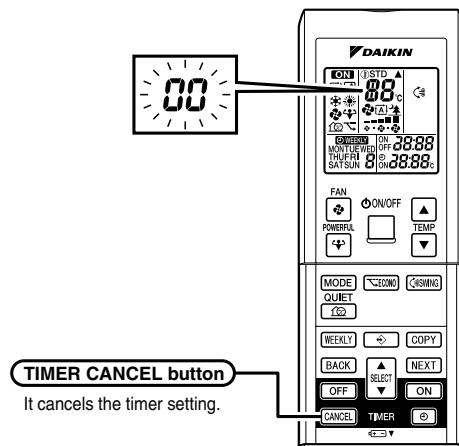

2. Press the **TIMER CANCEL** button repeatedly until a continuous beep is produced.

- The code indication changes as shown below, and notifies with a long beep.

	CODE	MEANING
SYSTEM	00	NORMAL
	UA	INDOOR-OUTDOOR UNIT COMBINATION FAULT
	U0	REFRIGERANT SHORTAGE
	U2	DROP VOLTAGE OR MAIN CIRCUIT OVERVOLTAGE
	U4	FAILURE OF TRANSMISSION (BETWEEN INDOOR UNIT AND OUTDOOR UNIT)
INDOOR UNIT	A1	INDOOR PCB DEFECTIVENESS
	A5	HIGH PRESSURE CONTROL OR FREEZE-UP PROTECTOR
	A6	FAN MOTOR FAULT
	C4	FAULTY HEAT EXCHANGER TEMPERATURE SENSOR
	C9	FAULTY SUCTION AIR TEMPERATURE SENSOR
OUTDOOR UNIT	EA	COOLING-HEATING SWITCHING ERROR
	E1	CIRCUIT BOARD FAULT
	E5	OL STARTED
	E6	FAULTY COMPRESSOR START UP
	E7	DC FAN MOTOR FAULT
	E8	OVERCURRENT INPUT
	F3	HIGH TEMPERATURE DISCHARGE PIPE CONTROL
	F6	HIGH PRESSURE CONTROL (IN COOLING)
	H0	SENSOR FAULT
	H6	OPERATION HALT DUE TO FAULTY POSITION DETECTION SENSOR
	H8	DC CURRENT SENSOR FAULT
	H9	FAULTY SUCTION AIR TEMPERATURE SENSOR
	J3	FAULTY DISCHARGE PIPE TEMPERATURE SENSOR
	J6	FAULTY HEAT EXCHANGER TEMPERATURE SENSOR
	L3	ELECTRICAL PARTS HEAT FAULT
	L4	HIGH TEMPERATURE AT INVERTER CIRCUIT HEATSINK
	L5	OUTPUT OVERCURRENT
P4	FAULTY INVERTER CIRCUIT HEATSINK TEMPERATURE SENSOR	

NOTE

1. A short beep and two consecutive beeps indicate non-corresponding codes.
2. To cancel the code display, hold the **TIMER CANCEL** button down for 5 seconds. The code display also cancel itself if the button is not pressed for 1 minute.

2.3 FHQ Series

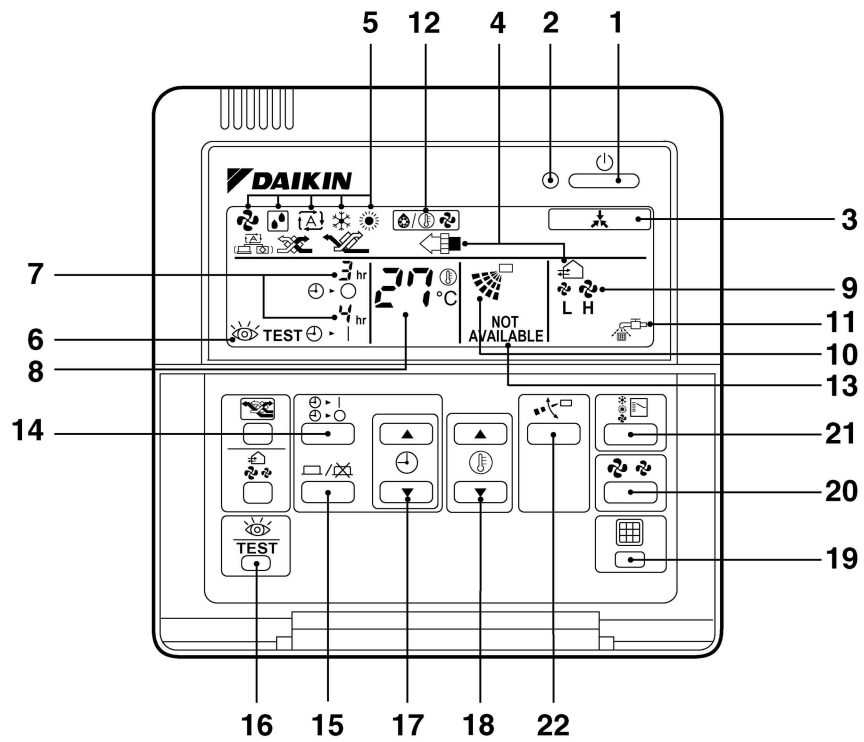

1

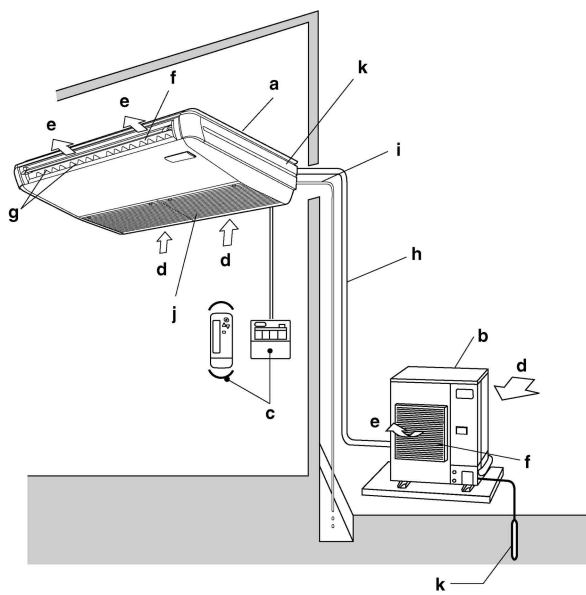

2

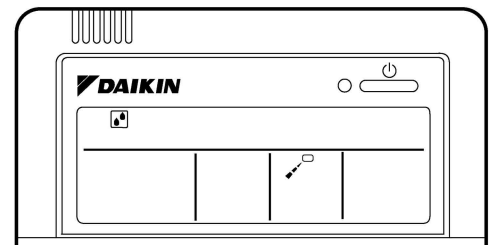

3

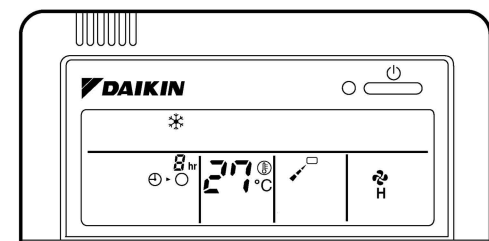

4

[1]

Important information regarding the refrigerant used

This product contains fluorinated greenhouse gases covered by the Kyoto Protocol.

Refrigerant type	R410A	R407C
GWP ⁽¹⁾ value	1975	1652.5

⁽¹⁾ GWP = global warming potential

Periodical inspections for refrigerant leaks may be required depending on European or local legislation. Please contact your local dealer for more information.

1. WHAT TO DO BEFORE OPERATION

This operation manual is for the following systems with standard control. Before initiating operation, contact your Daikin dealer for the operation that corresponds to your system.

• Pair system or Simultaneous operation system

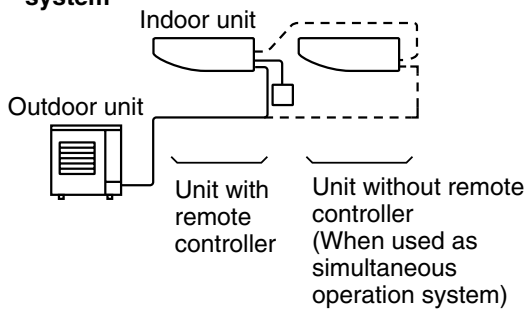

• Multi system

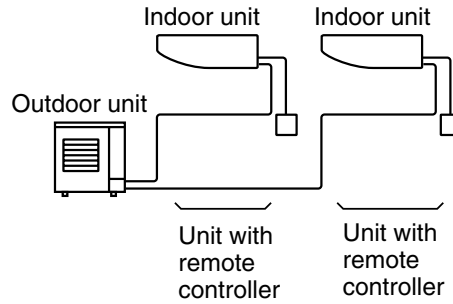

NOTE

- If the unit you purchased is controlled by a wireless remote controller, also refer to the wireless remote controller's operation manual.

If your installation has a customized control system, ask your Daikin dealer for the operation that corresponds to your system.

- Heat pump type
This system provides cooling, heating, automatic, program dry, and fan operation modes.
- Cooling only type
This system provides cooling, program dry, and fan operation modes.

PRECAUTIONS FOR GROUP CONTROL SYSTEM OR TWO REMOTE CONTROLLER CONTROL SYSTEM

This system provides two other control systems beside individual control (one remote controller controls one indoor unit) system. Confirm the following if your unit is of the following control system type.

- **Group control system**
One remote controller controls up to 16 indoor units.
All indoor units are equally set.
- **Two remote controllers control system**
Two remote controllers control one indoor unit (In case of group control system, one group of indoor units)
The unit is individually operated.

NOTE

- Contact your Daikin dealer in case of changing the combination or setting of group control and two remote controllers control system.

Names and functions of parts

Refer to figure 2 on page [1]

a	Indoor unit
b	Outdoor unit <ul style="list-style-type: none"> The external appearance of the outdoor unit varies depending on its capacity class. The outdoor unit shown in the figure is for reference to indicate features. Contact your Daikin Dealer and verify which outdoor unit you have.
c	Remote controller
d	Inlet air
e	Discharged air
f	Air outlet
g	Air flow flap (at air outlet)
h	Refrigerant piping, connection electric wire
i	Drain pipe
j	Suction grille The built-in air filter removes dust and dirt.
k	Ground wire Wire to ground from the outdoor unit to prevent electrical shocks.

2. SAFETY CONSIDERATIONS

We recommend that you read this instruction manual carefully before use to gain full advantage of the function of the air conditioner, and to avoid malfunction due to erroneous handling.

This air conditioner comes under the term “appliances not accessible to the general public.”

- **The precautions described below are WARNING and CAUTION. These are very important precautions concerning safety. Be sure to observe all of them without fail.**

⚠ WARNING...These are the matters with possibilities leading to serious consequences such as death or serious injury due to erroneous handling.

⚠ CAUTION....These are the matters with possibilities leading to injury or material damage due to erroneous handling including probabilities leading to serious consequences in some cases.

- **After reading, keep this manual at a place where any user can read at any time. Furthermore, make certain that this operation manual is handed to a new user when he takes over the operation.**

⚠ WARNING

Avoid exposure of your body directly to the cold air for a long time, or avoid excessive exposure of your body to the cold air.

Otherwise, your physical condition may be deteriorated and/or your health may be ruined.

When the air conditioner is in abnormal conditions (smell of something burning, etc), unplug the power cord from the outlet, and contact the dealer where you purchased the air conditioner.

Continued operation under such circumstances may result in a failure, electric shock, and fire.

Ask your dealer for installation of the air conditioner.

Incomplete installation performed by yourself may result in a failure, a water leakage, electric shock, and fire.

Ask your dealer for improvement, repair, and maintenance.

Incomplete improvement, repair, and maintenance may result in a failure, a water leakage, electric shock, and fire.

Do not insert your finger, a stick, etc., into the air inlet, outlet, and fan blades.

A fan in high-speed running may result in injury.

For refrigerant leakage, consult your dealer.

When the air conditioner is to be installed in a small room, it is necessary to take proper measures so that the amount of any leaked refrigerant does not exceed the limiting concentration even when it leaks. If the refrigerant leaks exceeding the level of limiting concentration, an oxygen deficiency accident may happen.

For installation of separately sold component parts, ask a specialist.

Be sure to use the separately sold component parts designated by our company.

Incomplete installation performed by yourself may result in a failure, a water leakage, electric shock, and fire.

Ask your dealer to move and reinstall the air conditioner.

Incomplete installation may result in a failure, a water leakage, electric shock, and fire.

Do not use any fuse with improper capacity.

The use of a piece of wire and whatnot may result in a failure and fire.

The refrigerant in the air conditioner is safe and normally does not leak. If the refrigerant leaks inside the room, the contact with a fire of a burner, a heater or a cooker may result in a harmful gas.

Do not use the air conditioner until when a service person confirms to finish repairing the portion where the refrigerant leaks.

Be sure to establish an earth.

Do not earth the unit to a utility pipe, arrester, or telephone earth.

Incomplete earth may cause electrical shock, or fire.

A high surge current from lightning or other sources may cause damage to the air conditioner.

Be sure to install an earth leakage breaker.
Failure to install an earth leakage breaker may result in electric shocks, or fire.

Consult the dealer if the air conditioner submerges owing to a natural disaster, such as a flood or typhoon.

Do not operate the air conditioner in that case, or otherwise a malfunction, electric shock, or fire may result.

⚠ CAUTION

Do not use the air conditioner for other purposes.

Do not use the air conditioner for a special application such as the storage of foods, animals and plants, precision machines, and art objects as otherwise the deterioration of quality may result.

Do not remove the air outlet of the outdoor unit.

The fan may get exposed and result in injury.

When the air conditioner is used in combination with burners or heaters, perform sufficient ventilation.

Insufficient ventilation may result in an oxygen deficiency accident.

Check and make sure that foundation blocks are not damaged after a long use.

If they are left in a damaged condition, the unit may fall and result in injury.

Neither place a flammable spray bottle near the air conditioner nor perform spraying.

Doing so may result in a fire.

To clean the air conditioner, stop operation, and unplug the power cord from the outlet.

Otherwise, an electric shock and injury may result.

Do not operate the air conditioner with a wet hand.

An electric shock may result.

Do not place items that might be damaged by water under the indoor unit.

Water may condensate and drip if the humidity reaches 80% or if the drain exit gets clogged.

Do not place a burner or heater at a place directly exposed to the wind from the air conditioner.

Incomplete combustion of the burner or heater may result.

Do not allow a child to mount on the outdoor unit or avoid placing any object on it.

Falling or tumbling may result in injury.

Do not expose animals and plants directly to the wind from the air conditioner.

Adverse influence to animals and plants may result.

Do not wash the air conditioner with water.

Electric shock or fire may result.

Do not install the air conditioner at any place where flammable gas may leak out.

If the gas leaks out and stays around the air conditioner, a fire may break out.

Execute complete drain piping for perfect drainage.

Incomplete piping may result in a water leakage.

The appliance is not intended for use by young children or infirm persons without supervision.

Young children should be supervised to ensure that they do not play with the appliance.

Consult with installation contractor for cleaning the inside of the air conditioner.

Wrong cleaning may make the plastics parts broken or cause failure of water leakage or electric shock.

Do not touch the air inlet or aluminium fin of the air conditioner.

Otherwise, injury may be caused.

Do not start or stop operating the air conditioner with the power supply breaker turned ON or OFF.

Otherwise, fire or water leakage may result.

Furthermore, the fan will rotate abruptly if power failure compensation is enabled, which may result in injury.

Do not place objects in direct proximity of the outdoor unit and do not let leaves and other debris accumulate around the unit.

Leaves are a hotbed for small animals which can enter the unit. Once in the unit, such animals can cause malfunctions, smoke or fire when making contact with electrical parts.

Never touch the internal parts of the remote controller.

Do not remove the front panel. Some parts inside are dangerous to touch, and a machine trouble may happen.

For checking and adjusting the internal parts, contact your dealer.

Avoid placing the remote controller in a spot splashed with water.

Water coming inside the machine may cause an electric leak or may damage the internal electronic parts.

Watch your steps at the time of air filter cleaning or inspection.

High-place work is required, to which utmost attention must be paid.

If the scaffold is unstable, you may fall or topple down, thus causing injury.

3. OPERATION RANGE

If the temperature or the humidity is beyond the following conditions, safety devices may work and the air conditioner may not operate, or sometimes, water may drop from the indoor unit.

COOLING

OUTDOOR UNIT	INDOOR		HUMIDITY	OUTDOOR TEMPERATURE	
	TEMPERATURE				
R35 · 45 · 60	DB	18 to 33	80% or below	DB	- 15 to 46
	WB	12 to 24			
RY35 · 45 · 60	DB	18 to 33	80% or below	DB	- 5 to 46
	WB	12 to 24			
R71 · 100 · 125 RP71 · 100 · 125 REP71 · 100 · 125	DB	21 to 35	80% or below	DB	- 15 to 46
	WB	14 to 25			
RY71 · 100 · 125 RYP71 · 100 · 125 RYEP71 · 100 · 125	DB	18 to 35	80% or below	DB	- 5 to 46
	WB	12 to 25			
RZP71 · 100 · 125	DB	21 to 35	80% or below	DB	- 5 to 50
	WB	14 to 25			
RQ71 · 100 · 125	DB	18 to 37	80% or below	DB	- 5 to 46
	WB	12 to 28			
RR71 · 100 · 125	DB	18 to 37	80% or below	DB	- 15 to 46
	WB	12 to 28			
RZQ71 · 100 · 125 · 140	DB	18 to 37	80% or below	DB	- 15 to 50
	WB	12 to 28			
RS50 · 60 RKS35 · 50 · 60 RXS35 · 50 · 60	DB	21 to 32	80% or below	DB	- 10 to 46
	WB	14 to 23			
3MKS50 4MKS58 · 75 · 90 3MXS52 · 2MXS52 4MXS68 · 80	DB	21 to 32	80% or below	DB	- 10 to 46
	WB	14 to 23			
RMKS112 · 140 · 160 RMS112 · 140 · 160	DB	21 to 32	80% or below	DB	- 5 to 46
	WB	14 to 23			

HEATING

OUTDOOR UNIT	INDOOR TEMPERATURE	OUTDOOR TEMPERATURE		
		DB	WB	
RY35 · 45 · 60	DB	15 to 27	DB	- 9 to 21
			WB	- 10 to 15.5
RY71 · 100 · 125 RYP71 · 100 · 125 RYEP71 · 100 · 125	DB	15 to 27	DB	- 9 to 21
			WB	- 10 to 15.5
RZP71 · 100 · 125	DB	15 to 27	DB	- 14 to 21
			WB	- 15 to 15.5
RQ71 · 100 · 125	DB	10 to 27	DB	- 9 to 21
			WB	- 10 to 15
RZQ71 · 100 · 125 · 140	DB	10 to 27	DB	- 19.5 to 21
			WB	- 20 to 15.5
RXS35 · 50 · 60	DB	10 to 30	DB	- 14 to 24
			WB	- 15 to 18
3MXS52 · 2MXS52 4MXS68 · 80	DB	10 to 30	DB	- 14 to 21
			WB	- 15 to 15.5
RMS112 · 140 · 160	DB	10 to 30	DB	- 14 to 21
			WB	- 15 to 15.5

DB: Dry bulb temperature (°C)

WB: Wet bulb temperature (°C)

The setting temperature range of the remote controller is 16°C to 32°C.

4. INSTALLATION SITE

Regarding places for installation

- **Is the air conditioner installed at a well-ventilated place where there are no obstacles around?**
- **Do not use the air conditioner in the following places.**
 - a. Filled with much mineral oil such as cutting oil
 - b. Where there is much salt such as a beach area
 - c. Where sulfured gas exists such as a hot-spring resort
 - d. Where there are considerable voltage fluctuations such as a factory or plant
 - e. Vehicles and vessels
 - f. Where there is much spray of oil and vapor such as a cookery, etc.
 - g. Where there are machines generating electromagnetic waves
 - h. Filled with acid and/or alkaline steam or vapor
- **Is a snow protection measure taken?**
For details, consult your dealer.

Regarding wiring

- **All wiring must be performed by an authorized electrician.**
To do wiring, ask your dealer. Never do it by yourself.
- **Make sure that a separate power supply circuit is provided for this air conditioner and that all electrical work is carried out by qualified personnel according to local laws and regulations.**

Pay attention to running noises, too

- **Are the following places selected?**
 - a. A place that can sufficiently withstand the weight of the air conditioner with less running noises and vibrations.
 - b. A place where the hot wind discharged from the air outlet of the outdoor unit and the running noises.
- **Are you sure that there are no obstacles near the air outlet of the outdoor unit?**
Such obstacles may result in declined performance and increased running noises.
- **If abnormal noises occur in use, stop the operation of the air conditioner, and then consult your dealer or our service station.**









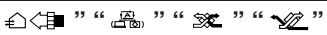
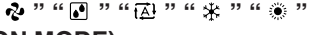

Regarding drainage of drain piping

- **Is the drain piping executed to perform complete drainage?**
If proper drainage is not carried out from the outdoor drain pipes during air-conditioning operation, chances are that dust and dirt are clogged in the pipe. This may result in a water leakage from the indoor unit. Under such circumstances, stop the operation of the air conditioner, and then consult your dealer or our service station.

5. NAME AND FUNCTION OF EACH SWITCH AND DISPLAY ON THE REMOTE CONTROLLER

Refer to figure 1 on page [1]

1	ON/OFF BUTTON
	Press the button and the system will start. Press the button again and the system will stop.
2	OPERATION LAMP (RED)
	The lamp lights up during operation.
3	DISPLAY “  ” (UNDER CENTRALIZED CONTROL)
	When this display shows, the system is UNDER CENTRALIZED CONTROL.

4	DISPLAY “  ” (VENTILATION/AIR CLEANING)
	This display shows that the total heat exchange and the air cleaning unit are in operation (These are optional accessories).
5	DISPLAY “  ” (OPERATION MODE)
	This display shows the current OPERATION MODE. For cooling only type, “  ” (Auto) and “  ” (Heating) are not installed.
6	DISPLAY “  TEST ” (INSPECTION/TEST OPERATION)
	When the INSPECTION/TEST OPERATION BUTTON is pressed, the display shows the system mode is in.
7	DISPLAY “  ” (PROGRAMMED TIME)
	This display shows the PROGRAMMED TIME of the system start or stop.
8	DISPLAY “  ”
	This display shows the set temperature.
9	DISPLAY “  ”
	This display shows the set fan speed.
10	DISPLAY “  ”
	Refer to “AIR FLOW DIRECTION ADJUST”.
11	DISPLAY “  ” (TIME TO CLEAN AIR FILTER)
	Refer to “HOW TO CLEAN THE AIR FILTER”.
12	DISPLAY “  ” (DEFROST)
	Refer to “DEFROST OPERATION”.
13	NON-FUNCTIONING DISPLAY
	If that particular function is not available, pressing the button may display the words “NOT AVAILABLE” for a few seconds.
14	TIMER MODE START/STOP BUTTON
	Refer to “PROGRAM TIMER OPERATION”.
15	TIMER ON/OFF BUTTON
	Refer to “PROGRAM TIMER OPERATION”.
16	INSPECTION/TEST OPERATION BUTTON
	This button is used only by qualified service persons for maintenance purposes.
17	PROGRAMMING TIME BUTTON
	Use this button for programming “START and/or STOP” time.

18	TEMPERATURE SETTING BUTTON Use this button for SETTING TEMPERATURE.
19	FILTER SIGN RESET BUTTON Refer to "HOW TO CLEAN THE AIR FILTER".
20	FAN SPEED CONTROL BUTTON Press this button to select the fan speed, HIGH or LOW, of your choice.
21	OPERATION MODE SELECTOR BUTTON Press this button to select OPERATION MODE.
22	AIR FLOW DIRECTION ADJUST BUTTON Refer to "AIR FLOW DIRECTION ADJUST".
NOTE	
<ul style="list-style-type: none"> For the sake of explanation, all indications are shown on the display in Figure 1 contrary to actual running situations. 	

6. OPERATION PROCEDURE

Refer to figure 1 on page [1]

- Operating procedure varies with heat pump type and cooling only type. Contact your Daikin dealer to confirm your system type.
- To protect the unit, turn on the main power switch 6 hours before operation.
- If the main power supply is turned off during operation, operation will restart automatically after the power turns back on again.

COOLING, HEATING, AUTOMATIC, FAN, AND PROGRAM DRY OPERATION

Operate in the following order.

1 OPERATION MODE SELECTOR

Press OPERATION MODE SELECTOR button several times and select the OPERATION MODE of your choice as follows.

- COOLING OPERATION.....“❄️”
- HEATING OPERATION.....“☀️”
- AUTOMATIC OPERATION.....“🔄”
 - In this operation mode, COOL/HEAT changeover is automatically conducted.
- FAN OPERATION.....“🌀”
- DRY OPERATION.....“💧”
 - The function of this program is to decrease the humidity in your room with the minimum temperature decrease.
 - Micro computer automatically determines TEMPERATURE and FAN SPEED.

- This system does not go into operation if the room temperature is below 16°C.

Refer to figure 3 on page [1]

- For cooling only type, “COOLING”, “FAN” and “DRY” operation are able to select.

2 ON/OFF

Press ON/OFF BUTTON

OPERATION lamp lights up or goes off and the system starts or stops OPERATION.

[EXPLANATION OF HEATING OPERATION]

DEFROST OPERATION

- As the frost on the coil of an outdoor unit increase, heating effect decreases and the system goes into DEFROST OPERATION.
- The indoor unit fan stops and the remote controller display shows “❄️🔄”.
- After 6 to 8 minutes (maximum 10 minutes) of DEFROST OPERATION, the system returns to HEATING OPERATION.

Regarding outside air temperature and heating capacity

- The heating capacity of the air conditioner declines as the outside air temperature falls. In such a case, use the air conditioner in combination with other heating systems.
- A warm air circulating system is employed, and therefore it takes some time until the entire room is warmed up after the start of operation.
- An indoor fan runs to discharge a gentle wind automatically until the temperature inside the air conditioner reaches a certain level. At this time, the remote controller displays “❄️🌀”. Leave it as it stands and wait for a while.
- When the warm air stays under the ceiling and your feet are cold, we recommend that you use a circulator (a fan to circulate the air inside the room). For details, consult your dealer.

ADJUSTMENT

For programming TEMPERATURE, FAN SPEED and AIR FLOW DIRECTION, follow the procedure shown below.

TEMPERATURE SETTING

Press TEMPERATURE SETTING button and program the setting temperature.

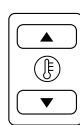

Each time this button is pressed, setting temperature rises 1°C.

Each time this button is pressed, setting temperature lowers 1°C.

- The setting is impossible for fan operation.

NOTE 

- The setting temperature range of the remote controller is 16°C to 32°C.

**FAN SPEED CONTROL**

Press **FAN SPEED CONTROL** button.

High or Low fan speed can be selected.

The micro computer may sometimes control the fan speed in order to protect the unit.

**AIR FLOW DIRECTION ADJUST**

- There are 2 ways of adjusting the air discharge angle.
 1. A. Up and down adjustment
 2. B. Left and right direction

Fig. 1

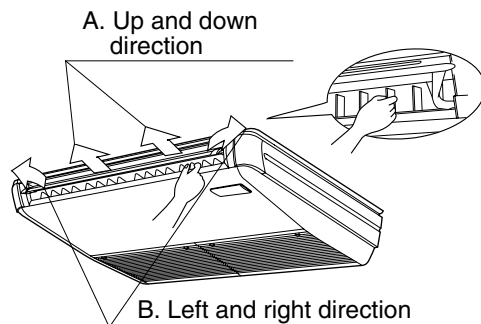
**A. UP AND DOWN DIRECTION**

- The movable limit of the flap is changeable. Contact your Daikin dealer for details.

Press the **AIR FLOW DIRECTION ADJUST** button to select the air direction as following.

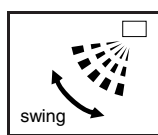

The AIR FLOW FLAP display swings as shown the left and the air flow direction continuously varies. (Automatic swing setting)



Press **AIR FLOW DIRECTION ADJUST** button to select the air direction of your choice.

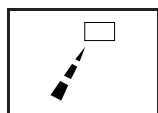

The AIR FLOW FLAP display stops swinging and the air flow direction is fixed (Fixed air flow direction setting).

MOVEMENT OF THE AIR FLOW FLAP

For the following conditions, micro computer controls the air flow direction so it may be different from the display.

Operation mode	Cooling	Heating
Operation condition	<ul style="list-style-type: none"> • When room temperature is lower than the set temperature 	<ul style="list-style-type: none"> • When room temperature is higher than the set temperature • At defrost operation
	<ul style="list-style-type: none"> • When operating continuously at downward air flow direction 	

Operation mode includes automatic operation.

B. LEFT AND RIGHT DIRECTION

- Adjusting air flow direction in the left and right direction. (Refer to Fig. 1)

NOTE 

- Only make adjustments after you have stopped the air flow direction swing in a position where adjustments are possible. Your hand may get caught if you attempt to make adjustments while the unit is swinging.

PROGRAM TIMER OPERATION

Operate in the following order.

- The timer is operated in the following two ways.
- Programming the stop time (⊕ · ○)
 - The system stops operating after the set time has elapsed.
- Programming the start time (⊕ · |)
 - The system starts operating after the set time has elapsed.
- The timer can be programmed a maximum of 72 hours.
- The start and the stop time can be simultaneously programmed.

**TIMER MODE START/STOP**

Press the **TIMER MODE START/STOP** button several times and select the mode on the display.

The display flashes.

For setting the timer stop "⊕ · ○"

For setting the timer start "⊕ · |"

2  **PROGRAMMING TIME**

Press the **PROGRAMMING TIME** button and set the time for stopping or starting the system.

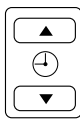

When this button is pressed, the time advances by 1 hour.



When this button is pressed, the time goes backward by 1 hour.

3  **TIMER ON/OFF**

Press the **TIMER ON/OFF** BUTTON.

The timer setting procedure ends. The display “⊕ - ○ or ⊕ - |” changes from flashing light to a constant light.

Refer to figure 4 on page [1]

NOTE

- When setting the timer Off and On at the same time, repeat the above procedure from 1 to 3 once again.

When the timer is programmed to stop the system after 3 hours and start the system after 4 hours, the system will stop after 3 hours and then 1 hour later the system will start.

- After the timer is programmed, the display shows the remaining time.
- Press the **TIMER ON/OFF** BUTTON once again to cancel programming. The display vanishes.

7. OPTIMUM OPERATION

Observe the following precautions to ensure the system operates.

- Adjust the room temperature properly for a comfortable environment. Avoid excessive heating or cooling.
- Prevent direct sunlight from entering a room during cooling operation by using curtains or blinds.
- Ventilate the room regularly. Using the unit for long periods of time requires attentive ventilation of the room.
- Keep doors and windows closed. If the doors and windows remain open, room air will flow out and cause to decrease the effect of cooling and heating.
- Do not place other heaters directly below the indoor unit. They may deform due to the heat.
- Never place objects near the air inlet and the air outlet of the unit. It may cause deterioration in the effect or stop in the operation.

- Turn off the main power supply switch when it is not used for long periods of time. When the main power switch is turned on, some watts of electricity is being used even if the system is not operating. Turn off the main power supply switch for saving energy. When reoperating, turn on the main power supply switch 6hours before operation for smooth running (Refer to MAINTENANCE).
- When the display shows “” (TIME TO CLEAN AIR FILTER), ask a qualified service person to clean the filters (Refer to MAINTENANCE).
- Fully use the function of air flow direction adjust. Cold air gathers on the floor, and warm air gathers in the ceiling. Set the air flow direction parallel during cooling or dry operation, and set it downwards during heating operation. Do not let the air blow directly to a person.
- It takes time for the room temperature to reach the set temperature. We recommend starting the operation in advance using timer operation.

8. MAINTENANCE (FOR SERVICE PERSONNEL)

ONLY A QUALIFIED SERVICE PERSON IS ALLOWED TO PERFORM MAINTENANCE

IMPORTANT!

- **BEFORE OBTAINING ACCESS TO TERMINAL DEVICES, ALL POWER SUPPLY CIRCUITS MUST BE INTERRUPTED**
- To clean the air conditioner, be sure to stop operation, and turn the power switch off. Otherwise, an electric shock and injury may result.
- Do not wash the air conditioner with water. Doing so may result in an electric shock.
- Be careful with a scaffold or staging. Caution must be exercised because of work at a high place.

Fig. 2

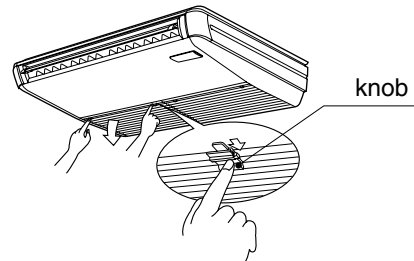

Fig. 3

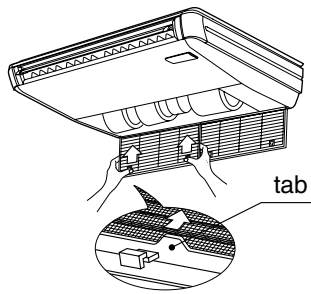

Fig. 4

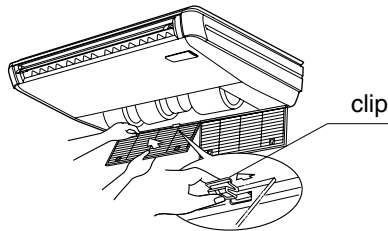
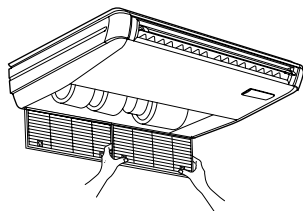



Fig. 5



HOW TO CLEAN THE AIR FILTER

Clean the air filter when the display shows “” (TIME TO CLEAN AIR FILTER).

It will display that it will operate for a set amount of time.

Increase the frequency of cleaning if the unit is installed in a room where the air is extremely contaminated.

If the dirt becomes impossible to clean, change the air filter (Air filter for exchange is optional).

1. Open the suction grille.

Slide both knobs simultaneously as shown and then pull them downward.

(Do the same procedure for closing.)

(Refer to Fig. 2)

2. Remove the air filters.

Push the 2 tabs up, and slowly lower the grille.

(Refer to Fig. 3)

3. Clean the air filter.

Use vacuum cleaner **A)** or wash the air filter with water **B).**

A)Using a vacuum cleaner



B)Washing with water

When the air filter is very dirty, use soft brush and neutral detergent.



Remove water and dry in the shade.

NOTE

- Do not wash the air conditioner with hot water of more than 50°C, as doing so may result in discoloration and/or deformation.
- Do not expose it to fire, as doing so may result in burning.

4. Fix the air filter.

Set the hatch of the air filter to the hook of the suction grille, and fix the air filter.

(Refer to Fig. 5)

5. Close the suction grille.

Refer to item No. 1.

6. After turning on the power, press FILTER SIGN RESET BUTTON.

The “TIME TO CLEAN AIR FILTER” display vanishes.

HOW TO CLEAN AIR OUTLET AND OUTSIDE PANELS

- Clean with soft cloth.
- When it is difficult to remove stains, use water or neutral detergent.

NOTE

- Do not use gasoline, benzene, thinner, polishing powder, liquid insecticide. It may cause discoloring or warping.
- Do not let the indoor unit get wet. It may cause an electric shock or a fire.
- Do not use water or air of 50°C or higher for cleaning air filters and outside panels.

HOW TO CLEAN THE SUCTION GRILLE

1. Open the suction grille.

Slide both knobs and then pull them downward.
(Do the same procedure for closing.)

2. Remove the air filter.

Refer to “HOW TO CLEAN THE AIR FILTER”.

(Refer to Fig. 3)

3. Remove the suction grille.

Open the suction grille and pull the clips on the back of the suction grille forward.

(Refer to Fig. 4)

4. Clean the suction grille.

Wash with a soft bristle brush and neutral detergent or water, and dry thoroughly.



- **When very grimy**

Directly apply the type of detergent used for cleaning ventilation fans or ovens, wait 10 minutes, and then rinse with water.

NOTE 

- Do not wash the air conditioner with hot water of more than 50°C, as doing so may result in discoloration and/or deformation.
- 5. Fix the air filter.**
Refer to “HOW TO CLEAN THE AIR FILTER”.
- 6. Fix the suction grille.**
Refer to item No. 3.
- 7. Close the suction grille.**
Refer to item No. 1.

START UP AFTER A LONG STOP

Confirm the following

- Check that the air inlet and outlet are not blocked. Remove any obstacle.
- Check if the earth is connected.
Might there be a broken wire somewhere?
Contact your dealer if there are any problems

Clean the air filter and outside panels

- After cleaning the air filter, make sure to attach it.

Turn on the main power supply switch

- The display on the remote controller will be shown when the power is turned on.
- To protect the unit, turn on the main power switch at least 6 hours before operation.

WHAT TO DO WHEN STOPPING THE SYSTEM FOR A LONG PERIOD

Turn on FAN OPERATION for a half day and dry the unit.

- Refer to “6. OPERATION PROCEDURE”.

Cut off the power supply.

- When the main power switch is turned on, some watts of electricity is being used even if the system is not operating.
Turn off the main power supply switch for saving energy.
- The display on the remote controller will vanish when the main power switch is turned off.

Clean the air filter and the exterior.

- Be sure to replace the air filter to its original place after cleaning. Refer to “MAINTENANCE”.

9. NOT MALFUNCTION OF THE AIR CONDITIONER

The following symptoms do not indicate air conditioner malfunction

I. THE SYSTEM DOES NOT OPERATE

- **The system does not restart immediately after the ON/OFF BUTTON is pressed.**

If the OPERATION lamp lights, the system is in normal condition.

It does not restart immediately because a safety device operates to prevent overload of the system. After 3 minutes, the system will turn on again automatically.

- **The system does not restart immediately when TEMPERATURE SETTING button is returned to the former position after pushing the button.**

If the OPERATION lamp lights, the system is in normal condition.

It does not restart immediately because a safety device operates to prevent overload of the system. After 3 minutes, the system will turn on again automatically.

- **The system does not start when the display shows “  ” (UNDER CENTRALIZED CONTROL) and it flashes for few seconds after pressing an operation button.**

This is because the system is under centralized control. Flashes on the display indicates that the system cannot be controlled by the remote controller.

- **The system does not start immediately after the power supply is turned on.**

Wait one minute until the micro computer is prepared for operation.

- **The outdoor unit is stopped**

This is because the room temperature has reached the set temperature. The indoor unit switches to fan operation.

II. WHEN “  ” (UNDER CENTRALIZED CONTROL) IS DISPLAYED AND OPERATION IS DIFFERENT FROM THE REMOTE CONTROL DISPLAY.

This is because operating mode is controlled by a micro computer, as shown below, depending on the operating mode of the other connected indoor units when using in a multi system.

- **If the operating mode does not match that of the other indoor units which are already running, the indoor unit goes into standby mode (the fan stops and the air flow flaps become horizontal).**

The unit will go into the above mode if either cooling, dry, or fan operation mode are set together with heating mode.

NOTE

- Normally, the operation mode in the room where the unit is first run is given priority, but the following situations are exceptions, so please keep this in mind.
 - a If the operation mode of the first room is FAN Mode, then using Heating Mode in any room after this will give priority to heating. In this situation, the air conditioner running in FAN Mode will go on standby.
 - b With the Priority Room Setting active Contact your Daikin dealer for the operation that corresponds to your system.
- **If the total capacity of all the indoor units running exceeds the limit, the indoor unit will go into standby mode (fan and air flow direction remain as set). (Only for cooling-only type.)**
- **If another indoor unit goes into heating mode after cooling, the unit may go into dry mode (fan operates whisper and the air flow flaps become horizontal).**

III. THE FAN SPEED IS DIFFERENT FROM THE SETTING.

- **Pressing the fan speed control button does not change the fan speed.**
When the room temperature reaches the set temperature in heating mode, the power supply from the outdoor unit stops and the indoor unit goes into whisper mode (in a multi system, the fan goes back and forth between stop and whisper). This is to prevent the cool air from being blown directly onto anyone in the room.

IV. AIR BLOW DIRECTION IS NOT AS SPECIFIED.

- **Actual air blow direction is not as shown on the remote controller.**
- **Automatic swing setting does not work.**
Refer to "AIR FLOW DIRECTION ADJUST".

V. WHITE MIST COMES OUT OF A UNIT

- **When humidity is high during cooling operation (In oily or dusty places)**
If the inside of an indoor unit is extremely contaminated, the temperature distribution inside a room becomes uneven. It is necessary to clean the inside of the indoor unit. Ask your Daikin dealer for details on cleaning the unit. This operation requires a qualified service person.

- **When the system is changed over to HEATING OPERATION after DEFROST OPERATION.**

Moisture generated by DEFROST becomes steam and exists.

VI. NOISE OF AIR CONDITIONERS

- **A ringing sound after the unit is started.**
This sound is generated by the temperature regulator working.
It will quiet down after about a minute.
- **A continuous flow "Shuh" sound is heard when the systems is in COOLING or DEFROST OPERATION.**
This is the sound of refrigerant gas flowing through both indoor and outdoor units.
- **A "Shuh" sound which is heard at the start or immediately after the stop of operation or which is heard at the start or immediately after the stop of DEFROST OPERATION.**
This is the noise of refrigerant caused by flow stop and flow change.
- **A continuous flow "Shah" sound is heard when the system is in COOLING OPERATION or at a stop.**
The noise is heard when the drain pump is in operation.
- **A "Pishi-pishi" squeaking sound is heard when the system is in operation or after the stop of operation.**
Expansion and contraction of plastic parts caused by temperature change makes this noise.

VII. DUST FROM THE UNITS

- **Dust may blow out from the unit after starting operation from long resting time.**
Dust absorbed by the unit blows out.

VIII. THE UNITS GIVE OFF ODORS

The unit absorbs the smell of rooms, furniture, cigarettes, etc., and then emits them.

IX. THE LIQUID CRYSTAL OF THE REMOTE CONTROLLER SHOW "88"

- **It happens immediately after the main power supply switch is turned on.**
This shows that the remote controller is in normal condition.
This continues temporary.

X. DOES NOT COOL VERY WELL.

- **Program dry operation.**
Program dry operation is designed to lower the room temperature as little as possible.
Refer to page 6.

10. TROUBLE SHOOTING

I. If one of the following malfunctions occurs, take the measures shown below and contact your Daikin dealer.

The system must be repaired by a qualified service person.

⚠ WARNING

When the air conditioner is in abnormal conditions (smell of something burning, etc), unplug the power cord from the outlet, and contact your dealer

Continued operation under such circumstances may result in a failure, electric shock, and fire.

- If a safety device such as a fuse, a breaker or an earth leakage breaker frequently actuates;
Measure: Do not turn on the main power switch.
- If the ON/OFF switch does not properly work;
Measure: Turn off the main power switch.
- If water leaks from unit;
Measure: Stop the operation.
- If the display “” (INSPECTION), “UNIT No.”, and the OPERATION lamp flash and the “MALFUNCTION CODE” appears;

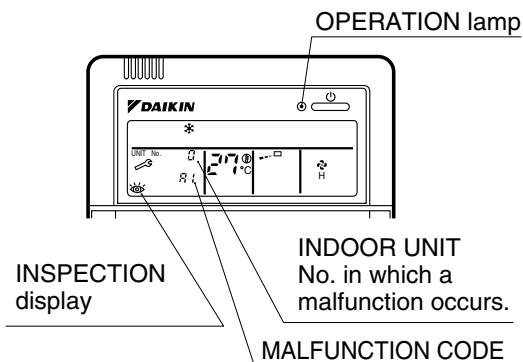

Measure: Notify your Daikin dealer and inform him/her of the display.

II. If the system does not properly operate except for the above mentioned case, and none of the above mentioned malfunctions is evident, investigate the system according to the following procedures.

1. If the system does not operate at all.

- Check if there is a power failure.
Wait until power is restored. If power failure occurs during operation, the system automatically restarts immediately after the power supply recovers.
- Check if no fuse has blown.
Turn off the power supply.

- Check if the breaker is blown.
Turn the power on with the breaker switch in the off position.
Do not turn the power on with the breaker switch in the trip position.
(Contact your dealer.)

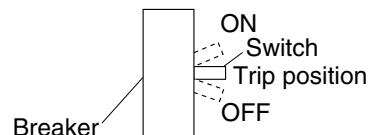

2. If the system stops operating after operating the system.

- Check if the air inlet or outlet of outdoor or indoor unit is blocked by obstacles.
Remove the obstacle and make it well-ventilated.
- Check if the air filter is clogged.
Ask a qualified service person to clean the air filters (Refer to MAINTENANCE).

3. The system operates but it does not sufficiently cool or heat.

- If the air inlet or outlet of the indoor or the outdoor unit is blocked with obstacles.
Remove the obstacle and make it well-ventilated.
- If the air filter is clogged.
Ask a qualified service person to clean the air filters (Refer to MAINTENANCE).
- If the set temperature is not proper (Refer to ADJUSTMENT).
- If the FAN SPEED button is set to LOW SPEED (Refer to ADJUSTMENT).
- If the air flow angle is not proper (Refer to AIR FLOW DIRECTION ADJUST).
- If the doors or the windows are open.
Shut doors or windows to prevent wind from coming in.
- If direct sunlight enters the room (when cooling).
Use curtains or blinds.
- When there are too many inhabitants in the room (when cooling).
Cooling effect decreases if heat gain of the room is too large.
- If the heat source of the room is excessive (when cooling).
Cooling effect decreases if heat gain of the room is too large.

Part 6

Service Diagnosis

1. Caution for Diagnosis.....	224
1.1 Troubleshooting with Operation Lamp	224
2. Problem Symptoms and Measures	226
3. Service Check Function	227
3.1 Check Method 1	227
3.2 Check Method 2	229
4. Code Indication on the Remote Controller	231
4.1 Error Codes and Description of Fault	231
5. Troubleshooting	232
5.1 Indoor Units	232
5.2 Outdoor Units	233
5.3 Indoor Unit PCB Abnormality	234
5.4 Freeze-up Protection Control or High Pressure Control.....	235
5.5 Fan Motor or Related Abnormality	237
5.6 Thermistor or Related Abnormality (Indoor Unit).....	240
5.7 Front Panel Open / Close Fault.....	241
5.8 Signal Transmission Error (between Indoor and Outdoor Unit)	242
5.9 Unspecified Voltage (between Indoor and Outdoor Units).....	243
5.10 Freeze-up Protection Control	244
5.11 Outdoor Unit PCB Abnormality.....	246
5.12 OL Activation (Compressor Overload)	247
5.13 Compressor Lock	248
5.14 DC Fan Lock	249
5.15 Input Over Current Detection	250
5.16 Discharge Pipe Temperature Control.....	252
5.17 High Pressure Control in Cooling	253
5.18 Compressor Sensor System Abnormality	255
5.19 Position Sensor Abnormality	257
5.20 CT or Related Abnormality	258
5.21 Thermistor or Related Abnormality (Outdoor Unit).....	260
5.22 Electrical Box Temperature Rise	262
5.23 Radiation Fin Temperature Rise	264
5.24 Output Over Current Detection.....	266
5.25 Insufficient Gas.....	268
5.26 Low-voltage Detection or Over-voltage Detection.....	270
5.27 Signal Transmission Error (on Outdoor Unit PCB).....	271
5.28 Anti-icing Function in Other Rooms / Unspecified Voltage (between Indoor and Outdoor Units).....	272
6. Check	273
6.1 How to Check.....	273

1. Caution for Diagnosis

1.1 Troubleshooting with Operation Lamp

The operation lamp flashes when any of the following errors is detected.

1. When a protection device of the indoor or outdoor unit is activated or when the thermistor malfunctions, disabling equipment operation.
2. When a signal transmission error occurs between the indoor and outdoor units.

In either case, conduct the diagnostic procedure described in the following pages.

Location of Operation Lamp

In case of
FTK(X)S 20/25/35/50 D Series

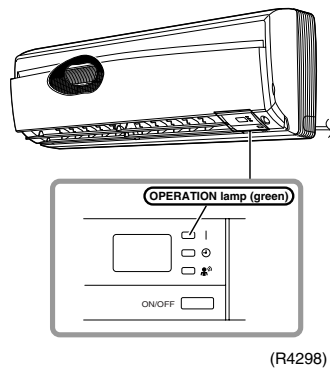

In case of
FTK(X)S 20/25/35 C Series

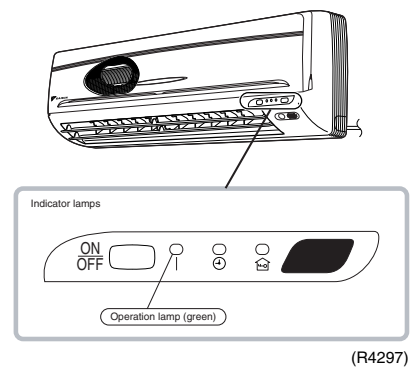

In case of
FTK(X)S 50 F Series

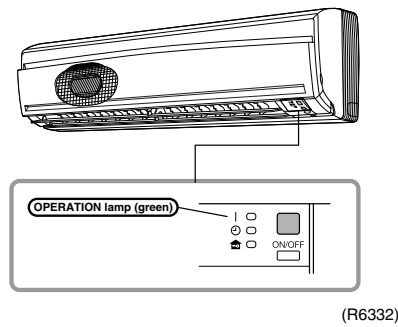

In case of
FTXG 25/35 E, CTXG 50 E Series

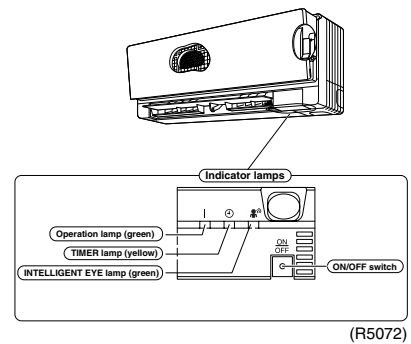

In case of
FDK(X)S 25/35/50 C Series
FDK(X)S 25/35 E Series

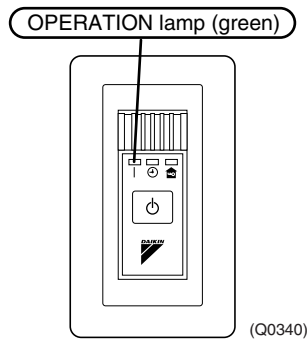

In case of
FVXS 25/35/50 F Series

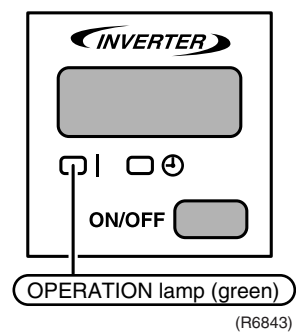

In case of
FLK(X)S 25/35/50 B Series

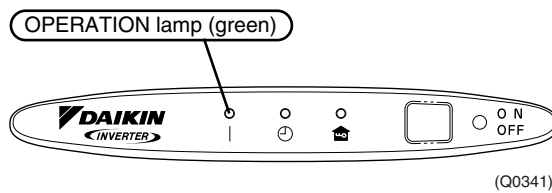

Caution:

Operation stops suddenly. (Operation lamp blinks.)

Cause of above trouble could be "Operation mode conflict".

Check followings;

Are the operation modes all the same for indoor units connected to Multi system outdoor unit?
If not set all indoor units to the same operation mode and confirm that the operation lamp is not blinking.

Moreover, when the operation mode is in "Auto", set all indoor unit operation mode to "Cool" or "Heat" and check again if the operation lamp is normal.

If the lamp stops blinking after the above steps, there is no malfunction.

★Operation stops and operation lamp blinks only for indoor unit which the different operation mode is set later. (The first set operation mode has priority.)

**Troubleshooting
with the LED
Indication**

Outdoor Unit

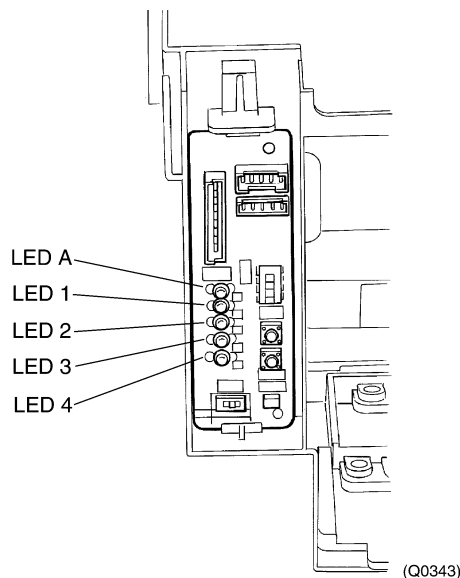

There are green and red LEDs on the PCB. The flashing green LED indicates normal equipment condition, and the OFF condition of the red LED indicates normal equipment condition.

(Troubleshooting with the green LED)

The LED A (green) of the outdoor unit indicate microcomputer operation condition.

Even after the error is cancelled and the equipment operates in normal condition, the LED indication remains.

2. Problem Symptoms and Measures

Problem Symptom	Check Item	Details of Measure	Page No. to be referred
None of the units operates.	Check the power supply.	Check to make sure that the rated voltage is supplied.	—
	Check the type of the indoor units.	Check to make sure that the indoor unit type is compatible with the outdoor unit.	—
	Check the outdoor air temperature.	Heating operation cannot be used when the outdoor air temperature is 15.5°C or higher (only for heat pump model), and cooling operation cannot be used when the outdoor air temperature is below -10 °C	—
	Diagnosis with indoor unit LED indication	—	232
	Diagnosis with outdoor unit LED indication	—	233
	Check the remote controller addresses.	Check to make sure that address settings for the remote controller and indoor unit are correct.	—
Operation sometimes stops.	Check the power supply.	A power failure of 2 to 10 cycles can stop air conditioner operation. (Operation lamp OFF)	—
	Check the outdoor air temperature.	Heating operation cannot be used when the outdoor air temperature is 15.5°C or higher (only for heat pump model), and cooling operation cannot be used when the outdoor air temperature is below -10°C	—
	Diagnosis with indoor unit LED indication	—	232
	Diagnosis with outdoor unit LED indication	—	233
Some indoor units do not operate.	Check the type of the indoor units.	Check to make sure that the indoor unit type is compatible with the outdoor unit.	—
	Diagnosis with indoor unit LED indication	—	232
	Diagnosis with outdoor unit LED indication	—	233
Equipment operates but does not cool, or does not heat (only for heat pump model).	Check for wiring and piping errors in the indoor and outdoor units connection wires and pipes.	Conduct the wiring/piping error check described on the product diagnosis nameplate.	—
	Check for thermistor detection errors.	Check to make sure that the main unit's thermistor has not dismounted from the pipe holder.	—
	Check for faulty operation of the electronic expansion valve.	Set the units to cooling operation, and compare the temperatures of the liquid side connection pipes of the connection section among rooms to check the opening and closing operation of the electronic expansion valves of the individual units.	—
	Diagnosis with indoor unit LED indication	—	232
	Diagnosis with outdoor unit LED indication	—	233
	Diagnosis by service port pressure and operating current	Check for insufficient gas.	279
Large operating noise and vibrations	Check the output voltage of the power transistor.	—	280
	Check the power transistor.	—	—
	Check the installation condition.	Check to make sure that the required spaces for installation (specified in the Engineering Data book, etc.) are provided.	—

3. Service Check Function

3.1 Check Method 1

The temperature display sections on the main unit indicate corresponding codes.

ARC433 Series

- When the timer cancel button is held down for 5 seconds, a "00" indication flashes on the temperature display section.

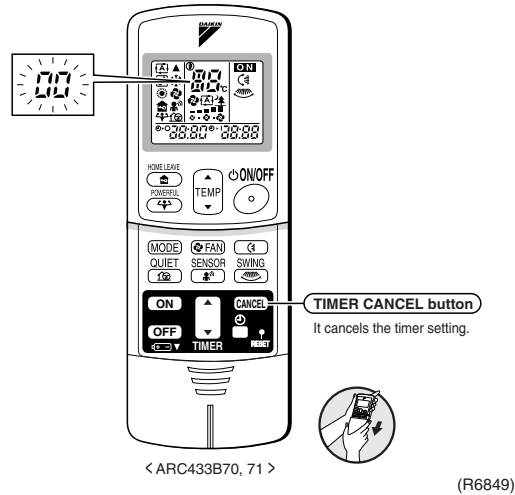

- Press the timer cancel button repeatedly until a continuous beep is produced.
 - The code indication changes in the sequence shown below, and notifies with a long beep.

No.	Code	No.	Code	No.	Code
1	00	12	C7	23	H0
2	U4	13	H8	24	E1
3	F3	14	J3	25	P4
4	E6	15	R3	26	L3
5	L5	16	R1	27	L4
6	R6	17	C4	28	H6
7	E5	18	C5	29	H7
8	F6	19	H9	30	U2
9	C9	20	J6	31	U4
10	U0	21	UR	32	ER
11	E7	22	R5	33	RX

<In case of ARC433B70, 71>

No.	Code	No.	Code	No.	Code
1	00	12	F6	23	R1
2	U4	13	C7	24	E1
3	L5	14	R3	25	UR
4	E6	15	H8	26	U4
5	H6	16	H9	27	P4
6	H0	17	C9	28	L3
7	R6	18	C4	29	L4
8	E7	19	C5	30	H7
9	U0	20	J3	31	U2
10	F3	21	J6	32	ER
11	R5	22	E5	33	RX



Note:

- A short beep and two consecutive beeps indicate non-corresponding codes.
- To cancel the code display, hold the timer cancel button down for 5 seconds. The code display also cancels itself if the button is not pressed for 1 minute.

ARC452A Series

1. When the timer cancel button is held down for 5 seconds, a “00” indication flashes on the temperature display section.

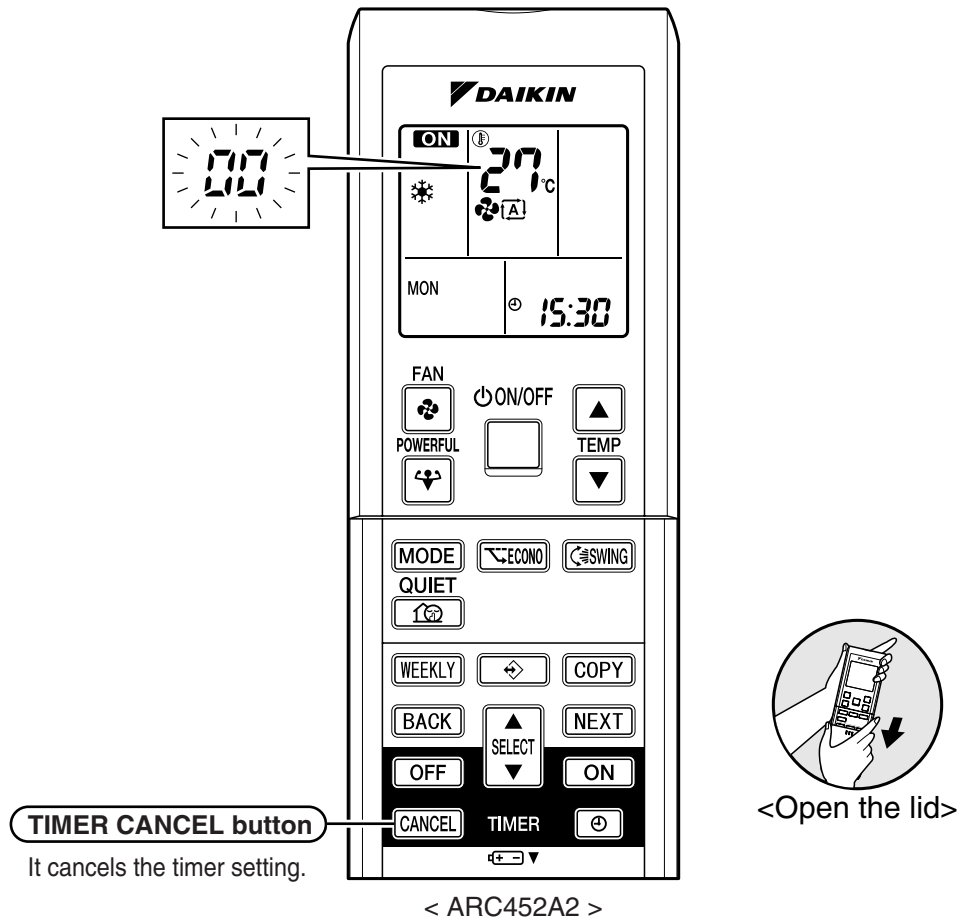

(R6757)

2. Press the timer cancel button repeatedly until a continuous beep is produced.
 - The code indication changes in the sequence shown below, and notifies with a long beep.

No.	Code	No.	Code	No.	Code
1	00	13	C7	25	UR
2	U4	14	R3	26	UR
3	L5	15	H8	27	P4
4	E6	16	H9	28	L3
5	H6	17	C9	29	L4
6	H0	18	C4	30	H7
7	R6	19	C5	31	U2
8	E7	20	J3	32	ER
9	U0	21	J6	33	RR
10	F3	22	E5	34	FR
11	R5	23	R1		
12	F6	24	E1		



Note:

1. A short beep and two consecutive beeps indicate non-corresponding codes.
2. To cancel the code display, hold the timer cancel button down for 5 seconds. The code display also cancels itself if the button is not pressed for 1 minute.

3.2 Check Method 2

1. Enter the diagnosis mode.
Press the 3 buttons (TEMP▲,TEMP▼, MODE) simultaneously.

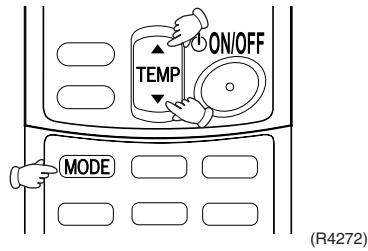

- The digit of the number of tens blinks.
- ★Try again from the start when the digit does not blink.

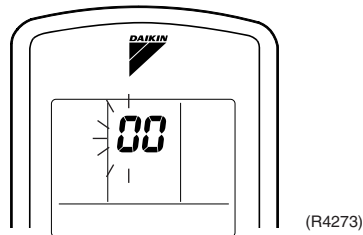

2. Press the TEMP button.
Press TEMP▲ or TEMP▼ and change the digit until you hear the sound of “beep” or “pi pi”.

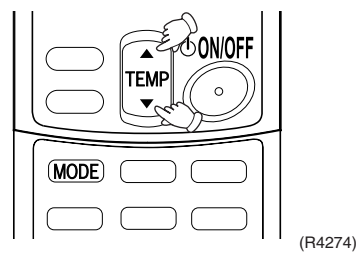

3. Diagnose by the sound.
 - ★“pi” : The number of tens does not accord with the error code.
 - ★“pi pi” : The number of tens accords with the error code.
 - ★“beep” : The both numbers of tens and units accord with the error code. (→ See 7.)
4. Enter the diagnosis mode again.
Press the MODE button.

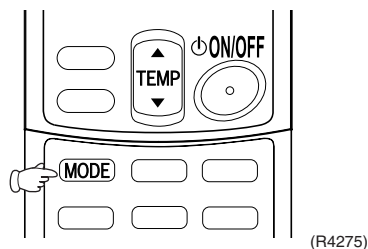

- The digit of the number of units blinks.

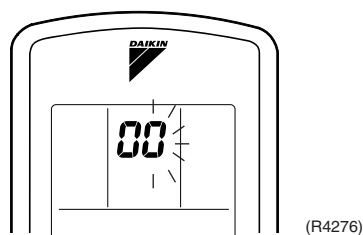

5. Press the TEMP button.
Press TEMP▲ or TEMP▼ and change the digit until you hear the sound of “beep”.

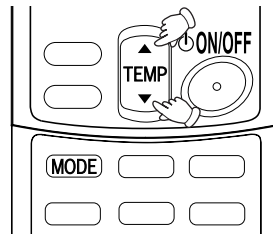

(R4277)

6. Diagnose by the sound.
 - ★“pi” : The both numbers of tens and units do not accord with the error code.
 - ★“pi pi” : The number of tens accords with the error code.
 - ★“beep” : The both numbers of tens and units accord with the error code.
7. Determine the error code.
The digits indicated when you hear the “beep” sound are error code.
(Error codes and description → Refer to page 231.)
8. Exit from the diagnosis mode.
Press the MODE button.

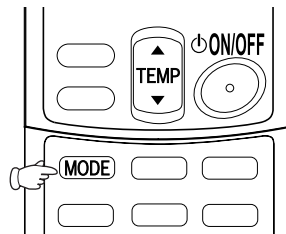

(R4278)

4. Code Indication on the Remote Controller

4.1 Error Codes and Description of Fault

	Code Indication	Description of Problem
System	00	Normal
	U0	Insufficient gas
	U2	Low-voltage detection or over-voltage detection
	U4	Signal transmission error (between indoor and outdoor units)
	U7	Signal transmission error (on outdoor unit PCB)
	U8	Unspecified voltage (between indoor and outdoor units)
	U4	Anti-icing function in other rooms
Indoor Unit	R1	Indoor unit PCB abnormality
	R5	Freeze-up protection function or high pressure control
	R6	Fan motor or related abnormality
	C4	Heat exchanger temperature thermistor abnormality
	C7	Front panel open / close fault
	C9	Room temperature thermistor abnormality
Outdoor Unit	R5	Freeze-up protection control
	E1	Outdoor unit PCB abnormality
	E5	OL activation (compressor overloaded)
	E6	Compressor lock
	E7	DC fan lock
	E8	Input over current detection
	F3	Discharge pipe temperature control
	F6	High pressure control in cooling
	H0	Compressor sensor system abnormality
	H6	Position sensor abnormality
	H8	CT or related abnormality
	H9	Outdoor air thermistor or related abnormality
	J3	Discharge pipe thermistor or related abnormality
	J6	Heat exchanger thermistor or related abnormality
	J8	Liquid pipe thermistor or related abnormality
	J9	Gas pipe thermistor or related abnormality
	L3	Electrical box temperature rise
	L4	Radiation fin temperature rise
	L5	Output over current detection
	P4	Radiation fin thermistor or related abnormality

5. Troubleshooting

5.1 Indoor Units

- : Not used for troubleshooting

* : Varies depending on the cases.

Indication on the remote controller	Description of the Fault		Details of fault (Refer to the indicated page.)
00	Indoor unit in normal condition (Conduct a diagnosis of the outdoor unit.)		—
R1	Indoor unit PCB abnormality		234
R5	Freeze-up protection control or high pressure control (heat pump model only)		235
R6	Fan motor or related abnormality	AC motor (Wall : 20~35 C series, Duct, Floor / Ceiling)	237
		DC motor (Wall : 20~50 D, E series, Floor)	238
E4	Heat exchanger thermistor or related abnormality		240
E7	Front panel open / close fault (FTXG-E series, CTXG-E series)		241
E9	Room temperature thermistor abnormality		240
U4	Signal transmission error (between indoor and outdoor units)		242
UR	Unspecified voltage (between indoor and outdoor units)		243

5.2 Outdoor Units

☉: ON, ●: OFF, ⦿: Blinks

Green : Flashes when in normal condition

Red : OFF in normal condition

- : Not used for troubleshooting

* : Varies depending on the cases.

Outdoor Unit LED Indication					Indication on the remote controller	Description of The Fault	Reference Page
Green	Red						
A	1	2	3	4			
⦿	●	●	●	●	00	Outdoor unit in normal condition (Conduct a diagnosis of the indoor unit.)	—
					UR	Unspecified voltage (between indoor and outdoor units)	272
					UH	Anti-icing function in other rooms	272
⦿	●	●	☉	☉	(U0)	Insufficient gas	268
⦿	☉	●	●	☉	U2	Low-voltage detection or over-voltage detection	270
⦿	●	☉	☉	☉	U7	Signal transmission error (on outdoor unit PCB)	271
⦿	☉	●	☉	☉	R5	Freeze-up protection control	244
⦿	☉	☉	☉	●	E1	Outdoor unit PCB abnormality	246
⦿	☉	●	☉	●	(E5)	OL activation (compressor overload)	247
⦿	●	☉	☉	●	(E6)	Compressor lock	248
⦿	☉	☉	☉	☉	E7	DC fan lock	249
⦿	●	☉	●	☉	E8	Input over current detection	250
⦿	☉	●	☉	●	F3	Discharge pipe temperature control	252
⦿	☉	●	☉	☉	F6	High pressure control in cooling	253
⦿	☉	☉	●	●	H0	Compressor sensor system abnormality	255
					H8	CT or related abnormality	258
⦿	☉	☉	●	●	H5	Position sensor abnormality	257
					H9	Outdoor air thermistor or related abnormality	260
					J3	Discharge pipe thermistor or related abnormality	260
					J6	Heat exchanger thermistor or related abnormality	260
					J8	Liquid pipe thermistor or related abnormality	260
					J9	Gas pipe thermistor or related abnormality	260
⦿	☉	☉	●	☉	P4	Radiation fin thermistor or related abnormality	260
					L3	Electrical box temperature rise	262
⦿	●	●	●	☉	L4	Radiation fin temperature rise (Protection of driver overheating)	264
⦿	●	●	☉	●	L5	Output over current detection	266



Note:

- The indications in the parenthesis () in the remote controller display column are displayed only when system-down occurs.
- When a sensor error occurs, check the remote controller display to determine which sensor is malfunctioning.
If the remote controller does not indicate the error type, conduct the following operation.
*Turn the power switch off and back on again. If the same LED indication appears again immediately after the power is turned on, the fault is in the thermistor.
*If the above condition does not result, the fault is in the CT.
- The indoor unit error indication may take the precedence in the remote controller display.

5.3 Indoor Unit PCB Abnormality

Remote Controller Display	81
Method of Malfunction Detection	Evaluation of zero-cross detection of power supply by indoor unit.
Malfunction Decision Conditions	When there is no zero-cross detection in approximately 10 continuous seconds.
Supposed Causes	<ul style="list-style-type: none"> ■ Faulty indoor unit PCB ■ Faulty connector connection

Troubleshooting

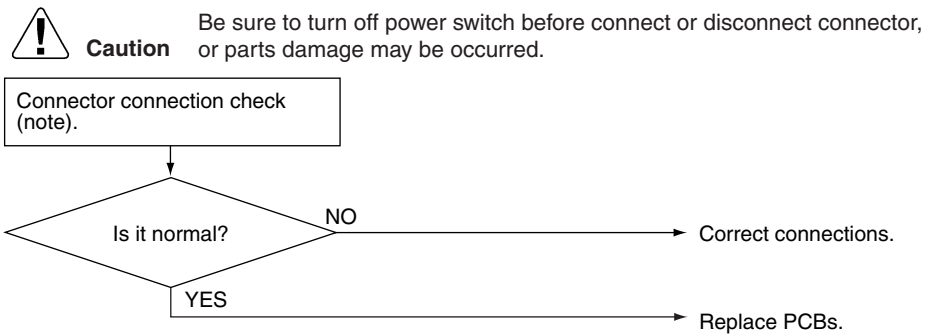

(R7130)

 **Note:** Connector Nos. vary depending on models.
Control connector

Model Type	Connector No.
Wall Mounted Type 20 / 25 / 35 class	Terminal strip~Control PCB
Wall Mounted Type 50 / 60 / 71 class	Terminal strip~Control PCB
Duct Connected Type	Terminal strip~Control PCB
Floor / Ceiling Suspended Dual Type	S37
Floor Standing Type	Terminal strip~Control PCB

5.4 Freeze-up Protection Control or High Pressure Control

Remote Controller Display	
Method of Malfunction Detection	<ul style="list-style-type: none"> ■ High pressure control (heat pump model only) During heating operations, the temperature detected by the indoor heat exchanger thermistor is used for the high pressure control (stop, outdoor fan stop, etc.) ■ The freeze-up protection control (operation halt) is activated during cooling operation according to the temperature detected by the indoor unit heat exchanger thermistor.
Malfunction Decision Conditions	<ul style="list-style-type: none"> ■ High pressure control During heating operations, the temperature detected by the indoor heat exchanger thermistor is above 65°C ■ Freeze-up protection When the indoor unit heat exchanger temperature is below 0°C during cooling operation.
Supposed Causes	<ul style="list-style-type: none"> ■ Operation halt due to clogged air filter of the indoor unit. ■ Operation halt due to dust accumulation on the indoor unit heat exchanger. ■ Operation halt due to short-circuit. ■ Detection error due to faulty indoor unit heat exchanger thermistor. ■ Detection error due to faulty indoor unit PCB.

Troubleshooting



Check No.06
Refer to P.276



Caution

Be sure to turn off power switch before connect or disconnect connector, or parts damage may be occurred.

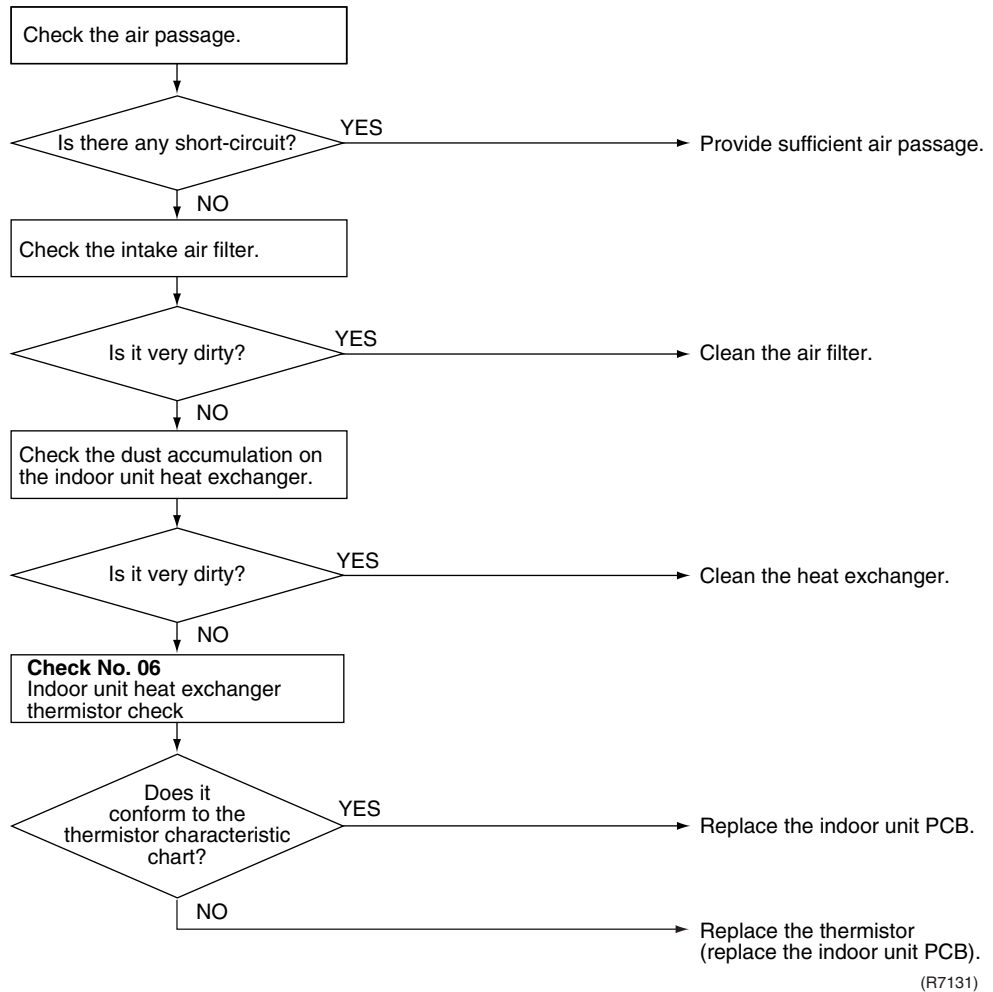

(R7131)



Note:

If the outside temperature is below -10°C in the cooling mode, the system may get interrupted with error *R5* displayed. The system will be reset itself, but this stop will be put in the error history memory.

5.5 Fan Motor or Related Abnormality

5.5.1 AC Motor

Remote Controller Display



Method of Malfunction Detection

The rotation speed detected by the Hall IC during fan motor operation is used to determine abnormal fan motor operation.

Malfunction Decision Conditions

When the detected rotation speed does not reach the demanded rotation speed of the target tap, and is less than 50% of the maximum fan motor rotation speed.

Supposed Causes

- Operation halt due to short circuit inside the fan motor winding.
- Operation halt due to breaking of wire inside the fan motor.
- Operation halt due to breaking of the fan motor lead wires.
- Operation halt due to faulty capacitor of the fan motor.
- Detection error due to faulty control PCB.

Troubleshooting



Check No.16
Refer to P.282



Caution

Be sure to turn off power switch before connect or disconnect connector, or parts damage may be occurred.

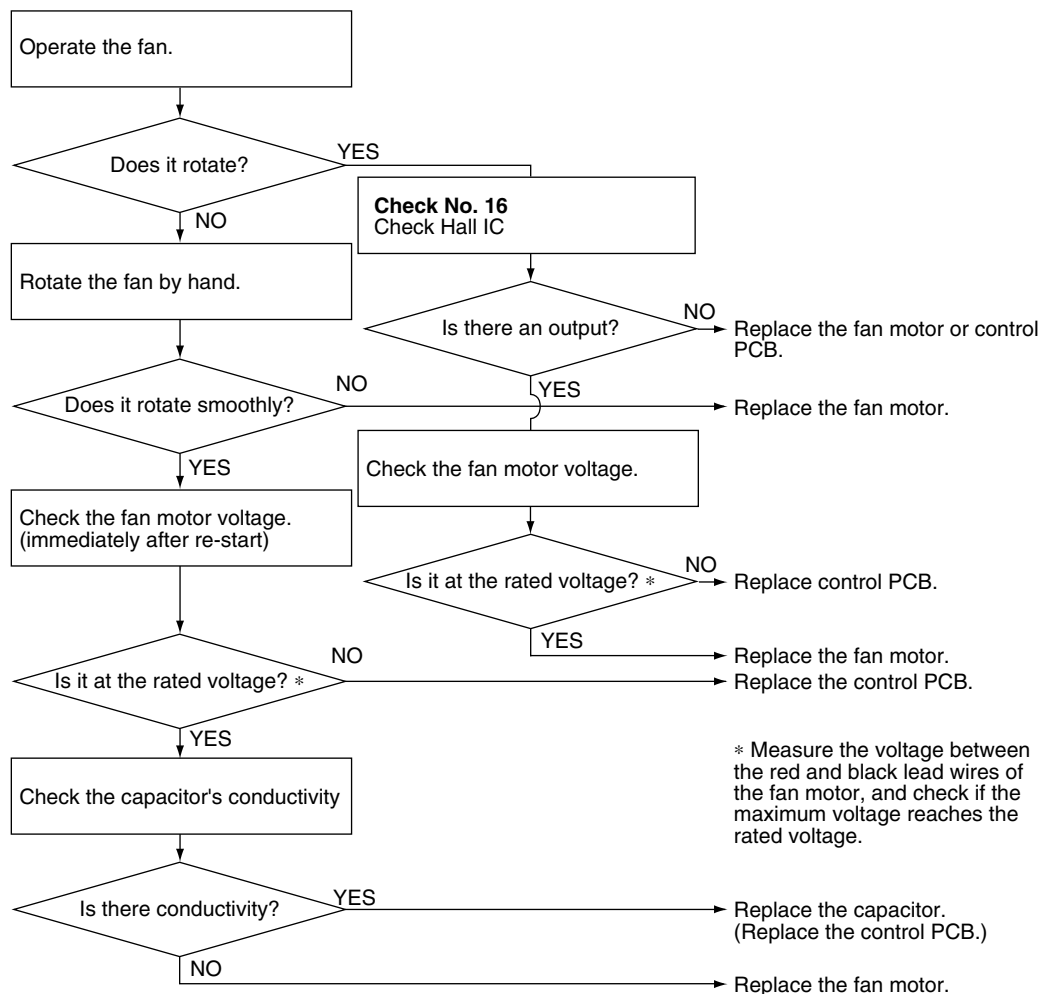

* Measure the voltage between the red and black lead wires of the fan motor, and check if the maximum voltage reaches the rated voltage.

(R7132)

5.5.2 DC Motor

**Remote
Controller
Display**



**Method of
Malfunction
Detection**

The rotation speed detected by the [Hall IC](#) during fan motor operation is used to determine abnormal fan motor operation.

**Malfunction
Decision
Conditions**

When the detected rotation speed does not reach the demanded rotation speed of the target tap, and is less than 50% of the maximum fan motor rotation speed.

**Supposed
Causes**

- Operation halt due to short circuit inside the fan motor winding.
- Operation halt due to breaking of wire inside the fan motor.
- Operation halt due to breaking of the fan motor lead wires.
- Operation halt due to faulty capacitor of the fan motor.
- Detection error due to faulty indoor unit PCB (1).

Troubleshooting



Check No.01
Refer to P.273



Check No.02
Refer to P.273



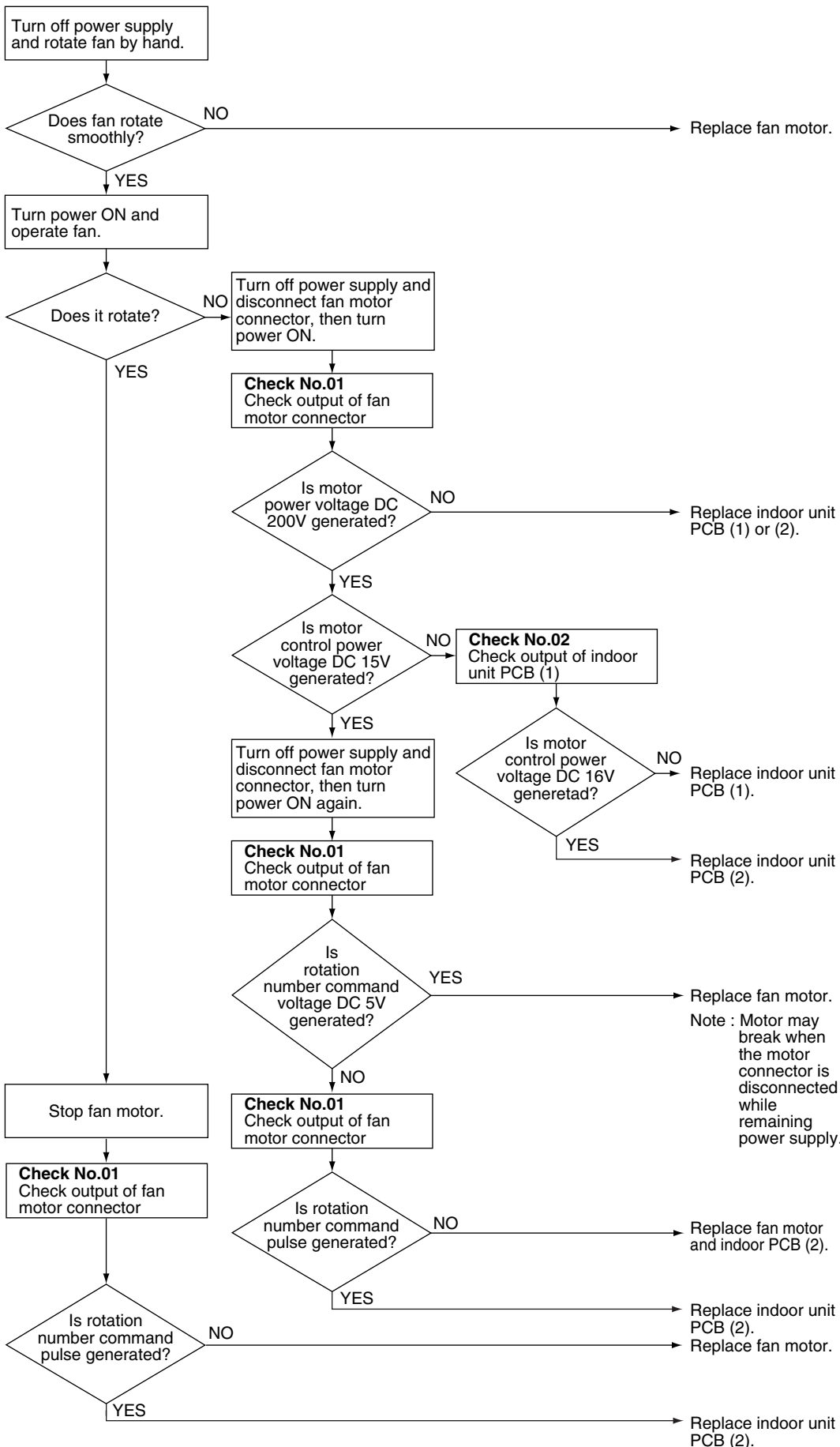

Caution Be sure to turn off power switch before connect or disconnect connector, or parts damage may be occurred.



(R7171)

5.6 Thermistor or Related Abnormality (Indoor Unit)

Remote Controller Display	
Method of Malfunction Detection	The temperatures detected by the thermistors are used to determine thermistor errors.
Malfunction Decision Conditions	When the thermistor input is more than 4.96 V or less than 0.04 V during compressor operation*. * (reference) When above about 212°C (less than 120 ohms) or below about -50°C (more than 1,860 kohms).
Supposed Causes	<ul style="list-style-type: none"> ■ Faulty connector connection ■ Faulty thermistor ■ Faulty PCB

 **Note:** The values vary slightly in some models.

Troubleshooting

Check No.06
 Refer to P.276

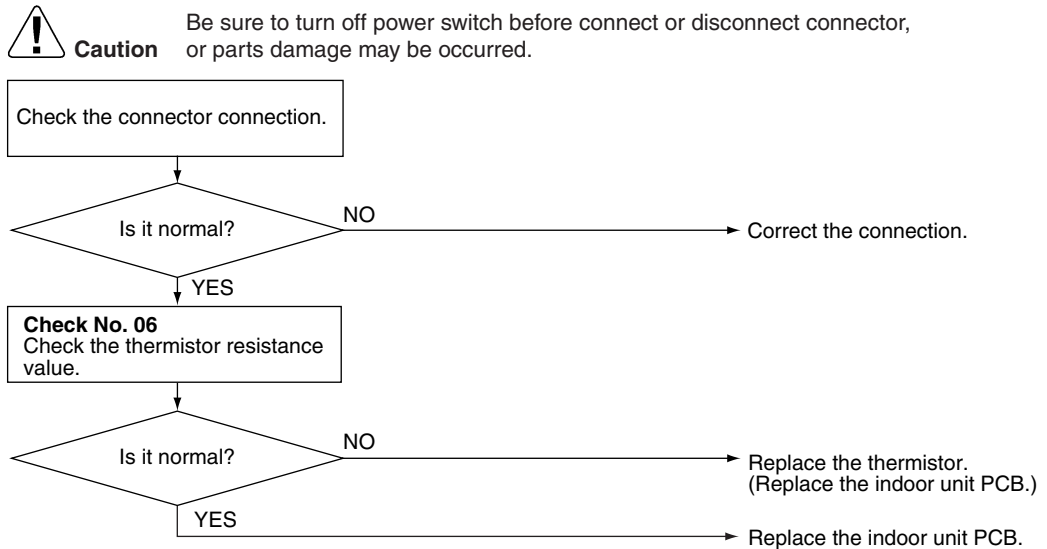

(R7134)

04 : Heat exchanger temperature thermistor
 09 : Room temperature thermistor

5.7 Front Panel Open / Close Fault

Remote
Controller
Display

E7

Method of
Malfunction
Detection

Malfunction
Decision
Conditions

- The system will be shut down when the error occurs twice.

Supposed
Causes

- Malfunction of the reduction motor
- Malfunction or deterioration of the front panel mechanism
- Malfunction of the limit switch

Troubleshooting

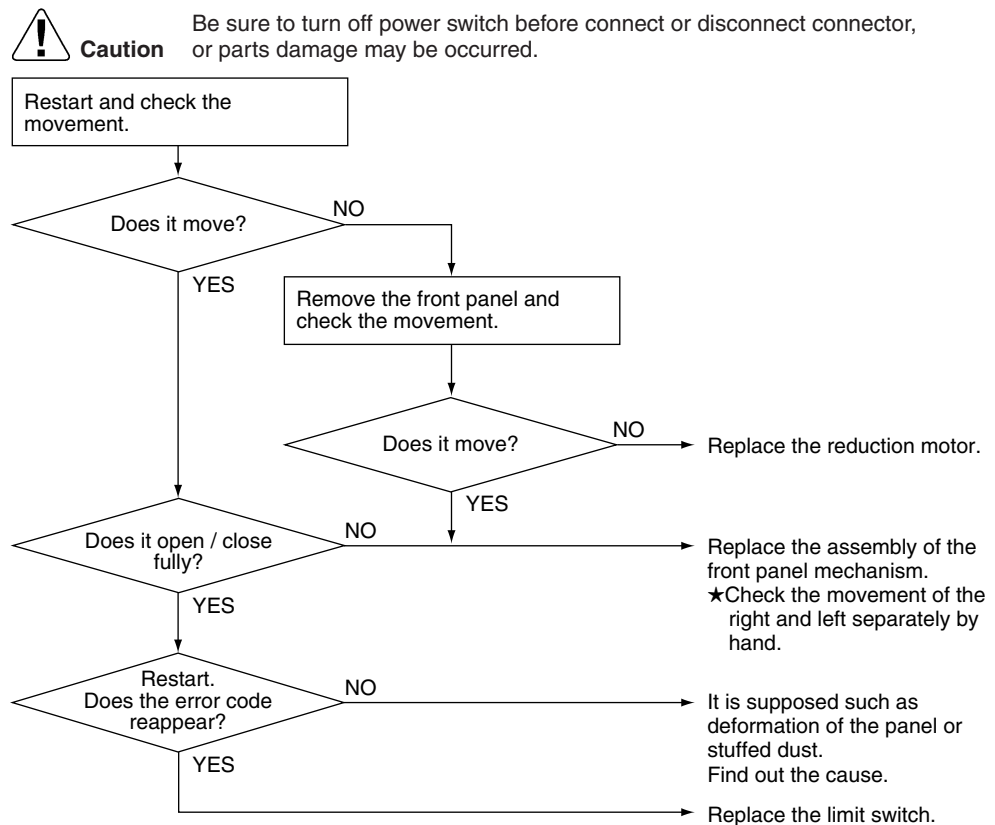

(R7135)



Note: You cannot operate the unit by the remote controller when the front panel mechanism breaks down.

<To the dealers: temporary measure before repair>

1. Pull the plug out or turn the breaker off.
2. Remove the decorative plate.
3. Remove the slot-in panel.
4. Put the plug in or turn the breaker on.
(Wait until the initialization finishes.)
5. Operate the unit by the indoor unit ON/OFF switch.

5.8 Signal Transmission Error (between Indoor and Outdoor Unit)

Remote Controller Display



Method of Malfunction Detection

The data received from the outdoor unit in indoor unit-outdoor unit signal transmission is checked whether it is normal.

Malfunction Decision Conditions

When the data sent from the outdoor unit cannot be received normally, or when the content of the data is abnormal.

Supposed Causes

- Faulty outdoor unit PCB / Faulty indoor unit PCB
- Indoor unit-outdoor unit signal transmission error due to wiring error / due to disturbed power supply waveform / due to breaking of wire in the connection wires between the indoor and outdoor units (wire No. 2)
- Short circuit inside the fan motor winding

Troubleshooting



Check No.10
Refer to P.279

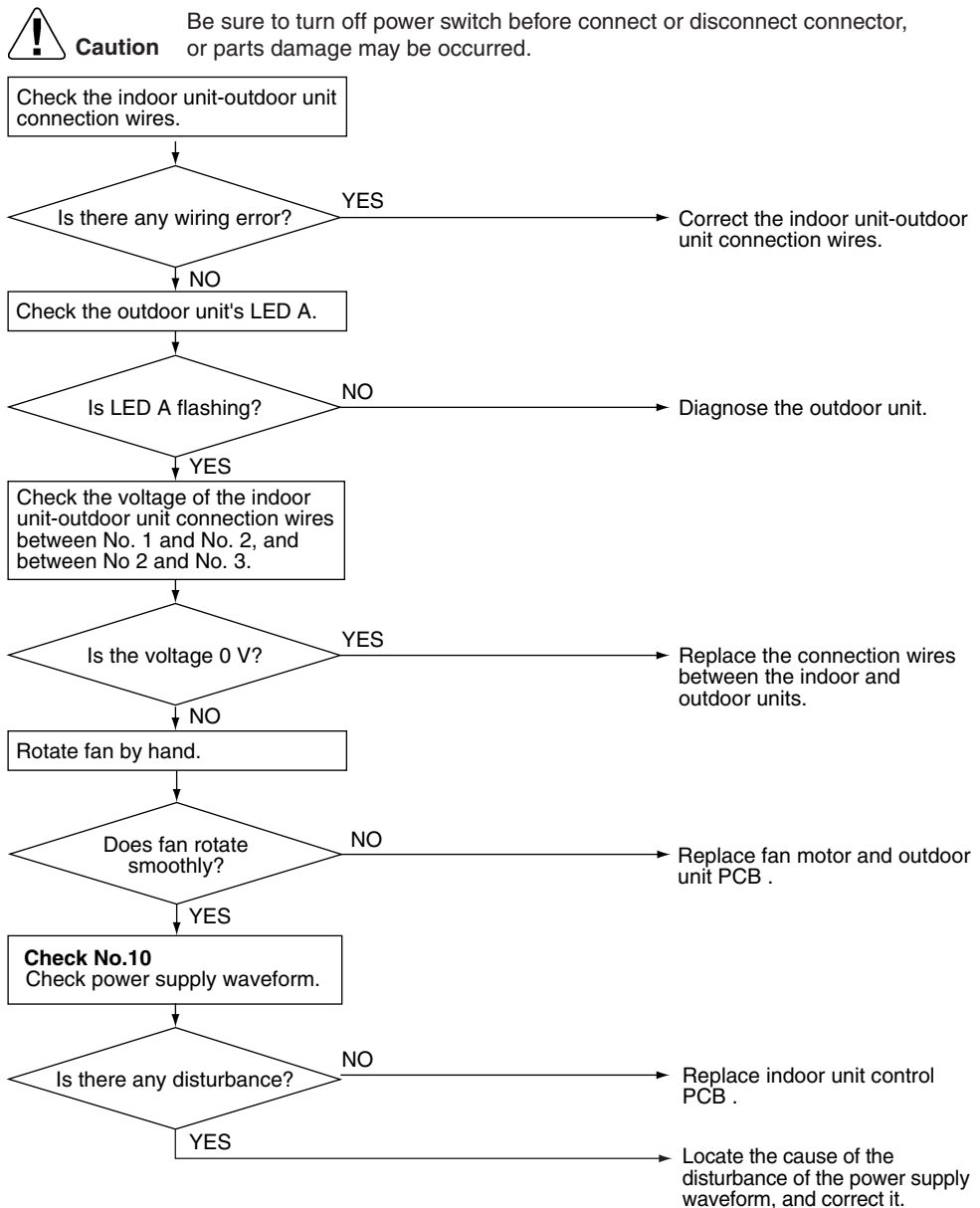

(R7236)

5.9 Unspecified Voltage (between Indoor and Outdoor Units)

Remote
Controller
Display

UR

Method of
Malfunction
Detection

The supply power is detected for its requirements (different from pair type and multi type) by the indoor / outdoor transmission signal.

Malfunction
Decision
Conditions

The pair type and multi type are interconnected.

Supposed
Causes





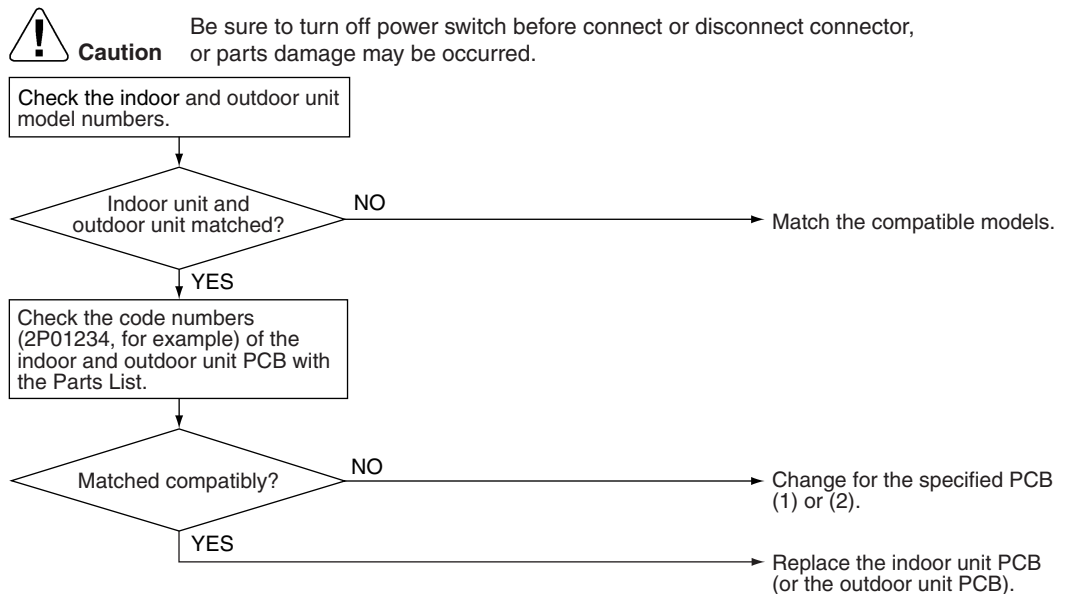

- Wrong models interconnected
- Wrong indoor unit PCB mounted
- Indoor unit PCB defective
- Wrong outdoor unit PCB mounted or defective

Troubleshooting



(R7181)

5.10 Freeze-up Protection Control

<p>Remote Controller Display</p>	
<p>Outdoor Unit LED Display</p>	<p>A  1  2  3  4 </p>
<p>Method of Malfunction Detection</p>	<p>Indoor unit icing, during cooling operation, is detected by checking the temperatures sensed by the indoor unit heat exchanger thermistor and room temperature thermistor that are located in a shut-down room.</p>
<p>Malfunction Decision Conditions</p>	<p>In the cooling mode, the following conditions (A) and (B) are kept together for 5 minutes. (A) Indoor unit heat exchanger temperature $\leq -1^{\circ}\text{C}$ (B) Indoor unit heat exchanger temperature \leq Room temperature -10°C</p> <p>If the freeze-up protection control is activated 4 times continuously, the system will be shut down. (The 4-time counter will reset itself if any of the following errors does not occur for 60 minutes: OL, radiation fin temperature rise, gas shortage, and compressor startup.)</p>
<p>Supposed Causes</p>	<ul style="list-style-type: none"> ■ Wrong wiring or piping ■ EV malfunctioning in each room ■ Short-circuit ■ Indoor unit heat exchanger thermistor defective ■ Room temperature thermistor defective

Troubleshooting



Check No.04
Refer to P.274



Check No.06
Refer to P.276



Caution

Be sure to turn off power switch before connect or disconnect connector, or parts damage may be occurred.

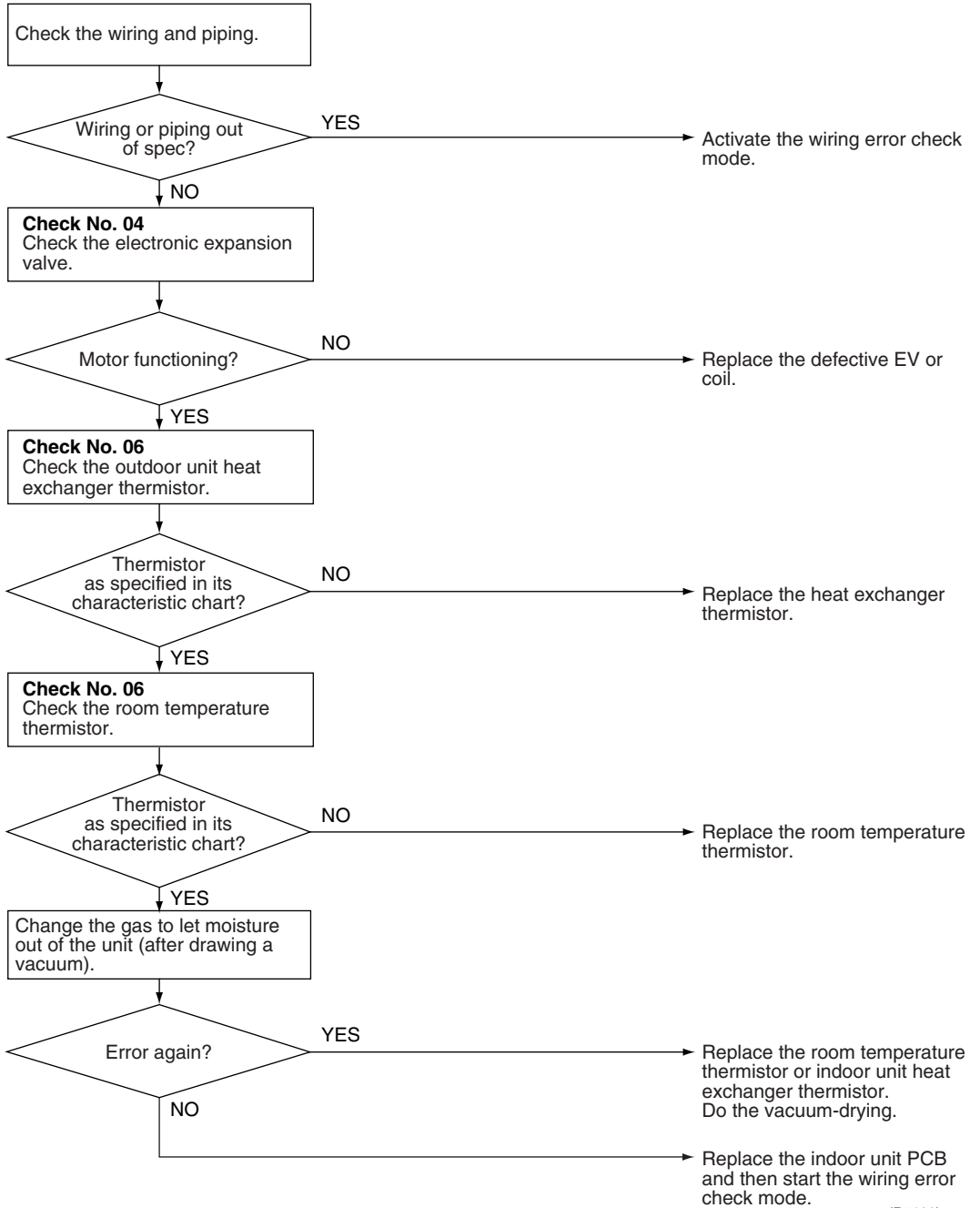

(R7182)

5.11 Outdoor Unit PCB Abnormality

Remote
Controller
Display



Outdoor Unit LED
Display

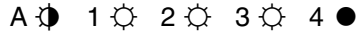

Method of
Malfunction
Detection

- Detect within the programme of the microcomputer that the programme is in normal running order.

Malfunction
Decision
Conditions

- When the programme of the microcomputer is in abnormal running order.

Supposed
Causes

- Out of control of microcomputer caused by external factors
 - Noise
 - Momentary fall of voltage
 - Momentary power loss
- Defective outdoor unit PCB

Troubleshooting

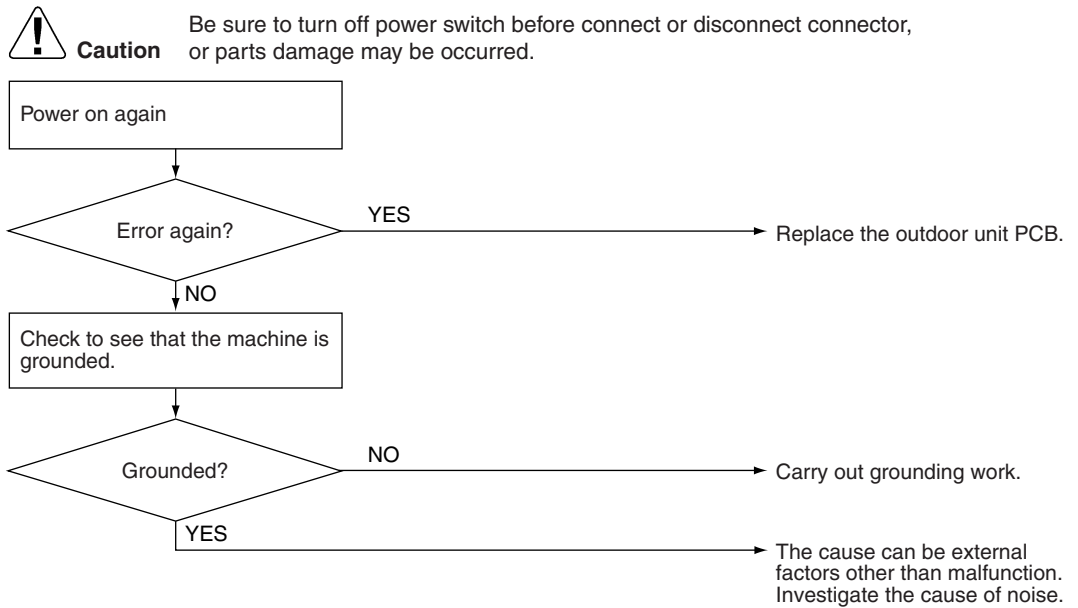

(R7183)

5.12 OL Activation (Compressor Overload)

Remote
Controller
Display



Outdoor Unit LED
Display

A ● 1 ○ 2 ● 3 ○ 4 ●

Method of
Malfunction
Detection

A compressor overload is detected through compressor OL.

Malfunction
Decision
Conditions

- If the compressor OL is activated twice, the system will be shut down.
- The error counter will reset itself if this or any other error does not occur during the following 60-minute compressor running time (total time).
- * The operating temperature condition is not specified.

Supposed
Causes

- Refrigerant shortage
- Four way valve malfunctioning
- Outdoor unit PCB defective
- Water mixed in the local piping
- Electronic expansion valve defective
- Stop valve defective

Troubleshooting



Check No.04
Refer to P.274



Check No.05
Refer to P.275



Check No.06
Refer to P.276



Check No.11
Refer to P.279



Caution

Be sure to turn off power switch before connect or disconnect connector, or parts damage may be occurred.

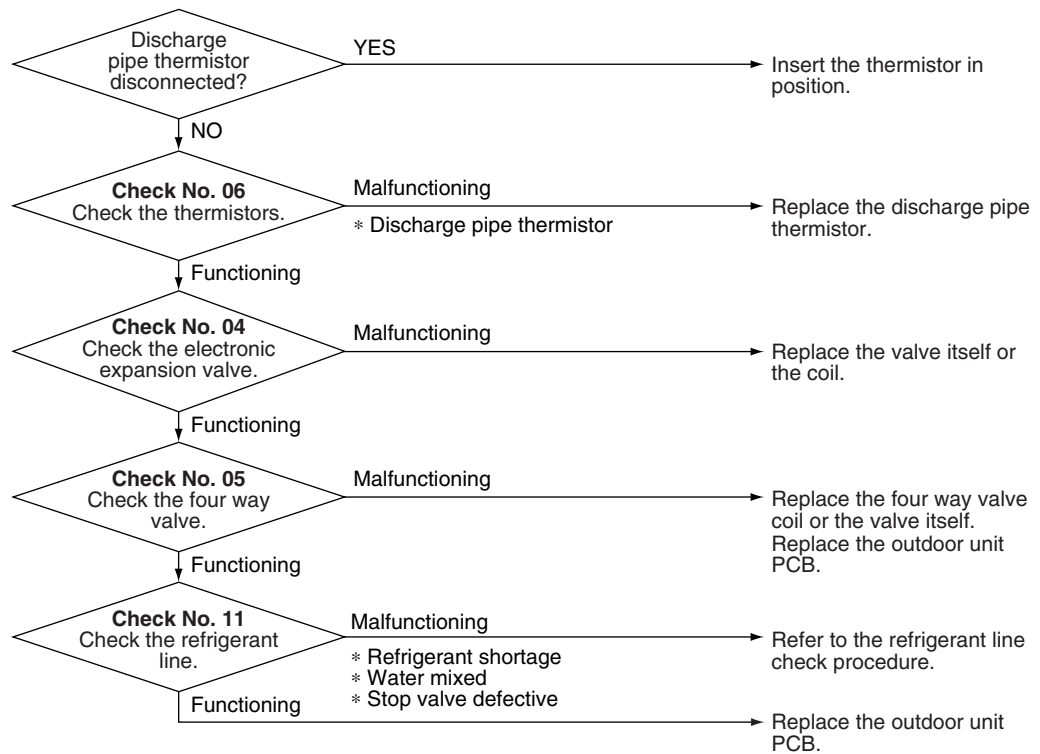

(R7137)

5.13 Compressor Lock

Remote
Controller
Display



Outdoor Unit LED
Display

A 1 2 3 4

Method of
Malfunction
Detection

A compressor lock is detected by checking the compressor running condition through the position detection circuit.

Malfunction
Decision
Conditions

- Judging from current waveform generated when high-frequency voltage is applied to the compressor.
- The system will be shut down if the error occurs 16 times.
- Clearing condition: Continuous run for about 5 minutes (normal)

Supposed
Causes

- Compressor locked

Troubleshooting

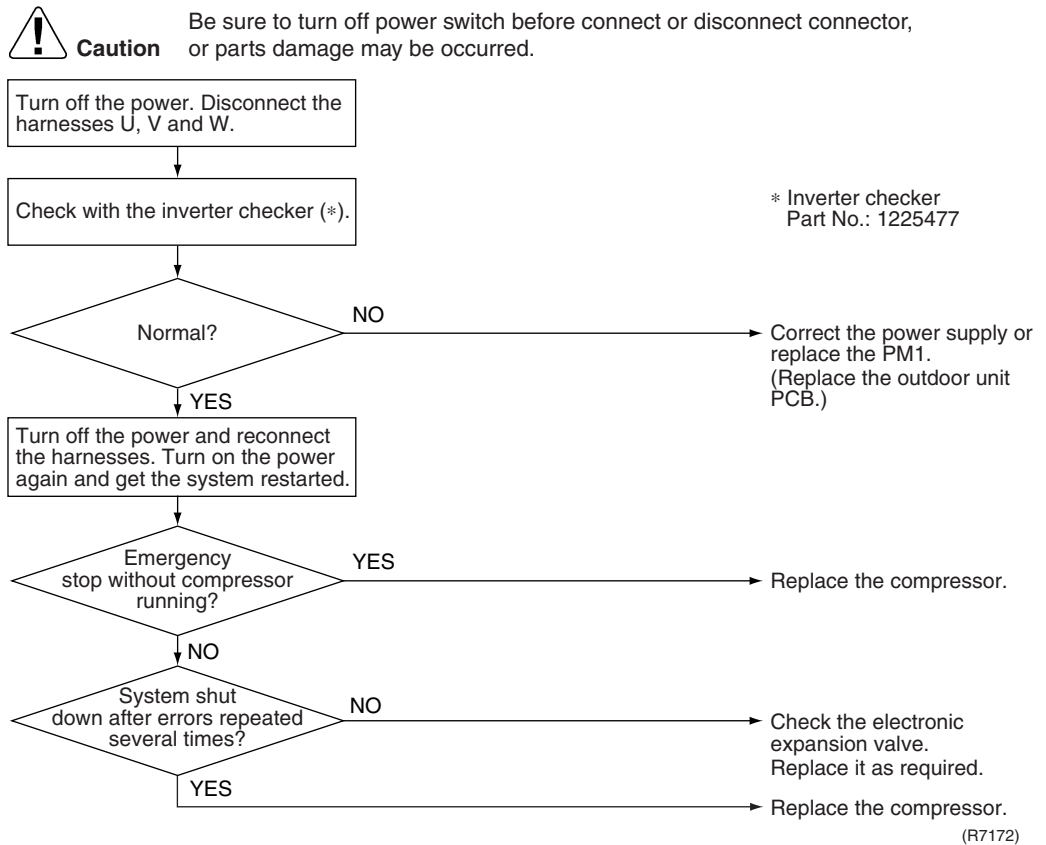

5.14 DC Fan Lock

Remote Controller Display



Outdoor Unit LED Display

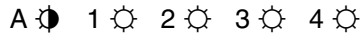

Method of Malfunction Detection

A fan motor line error is detected by checking the high-voltage fan motor rpm being detected by the Hall IC.

Malfunction Decision Conditions

- The fan does not start in 30 seconds even when the fan motor is running.
- The system will be shut down if the error occurs 16 times.
- Clearing condition: Continuous run for about 5 minutes (normal)

Supposed Causes

- Fan motor breakdown
- Harness or connector disconnected between fan motor and PCB or in poor contact
- Foreign matters stuck in the fan

Troubleshooting

 **Check No.15**
Refer to P.281

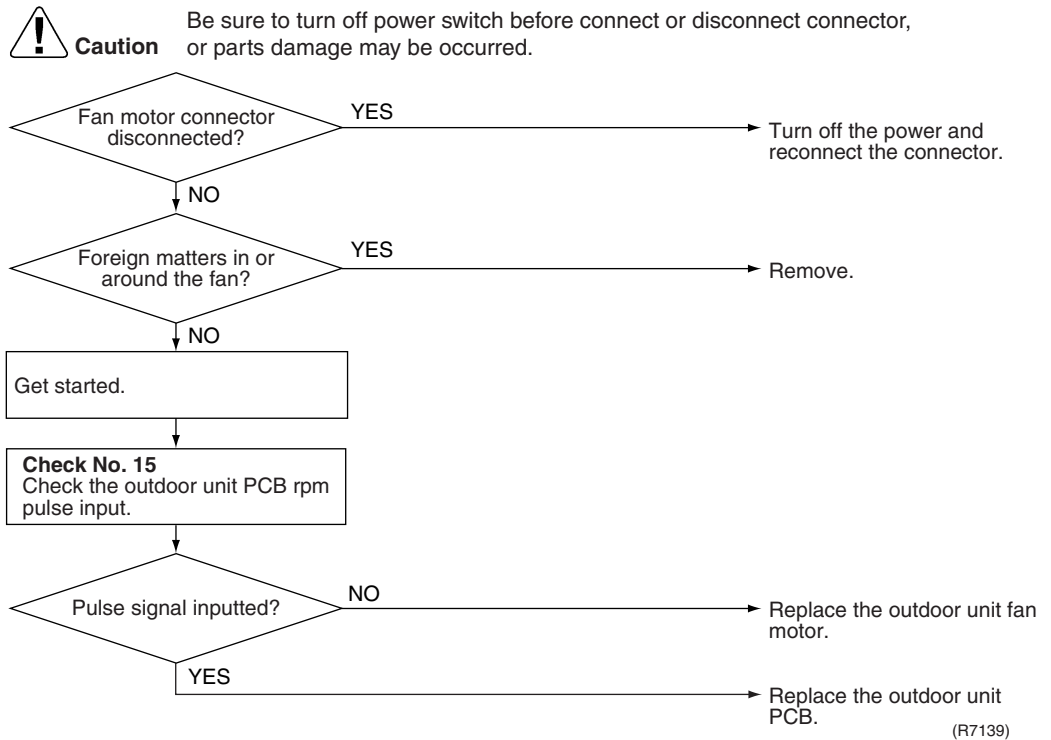

5.15 Input Over Current Detection

Remote
Controller
Display



Outdoor Unit LED
Display



Method of
Malfunction
Detection

Malfunction is detected by checking the input current value.

Malfunction
Decision
Conditions

- The following condition continues for 2.5 seconds.
Input current $\geq 20A$ (typical value)
- The compressor halts if the error occurs, and restarts automatically after 3 minutes stand-by.

Supposed
Causes

- Over-current due to compressor failure
- Over-current due to defective power transistor
- Over-current due to defective inverter main circuit electrolytic capacitor
- Over-current due to defective outdoor unit PCB
- Error detection due to outdoor unit PCB
- Over-current due to short-circuit

Troubleshooting



Check No.07
Refer to P.277



Check No.08
Refer to P.278



Check No.14
Refer to P.281



Caution





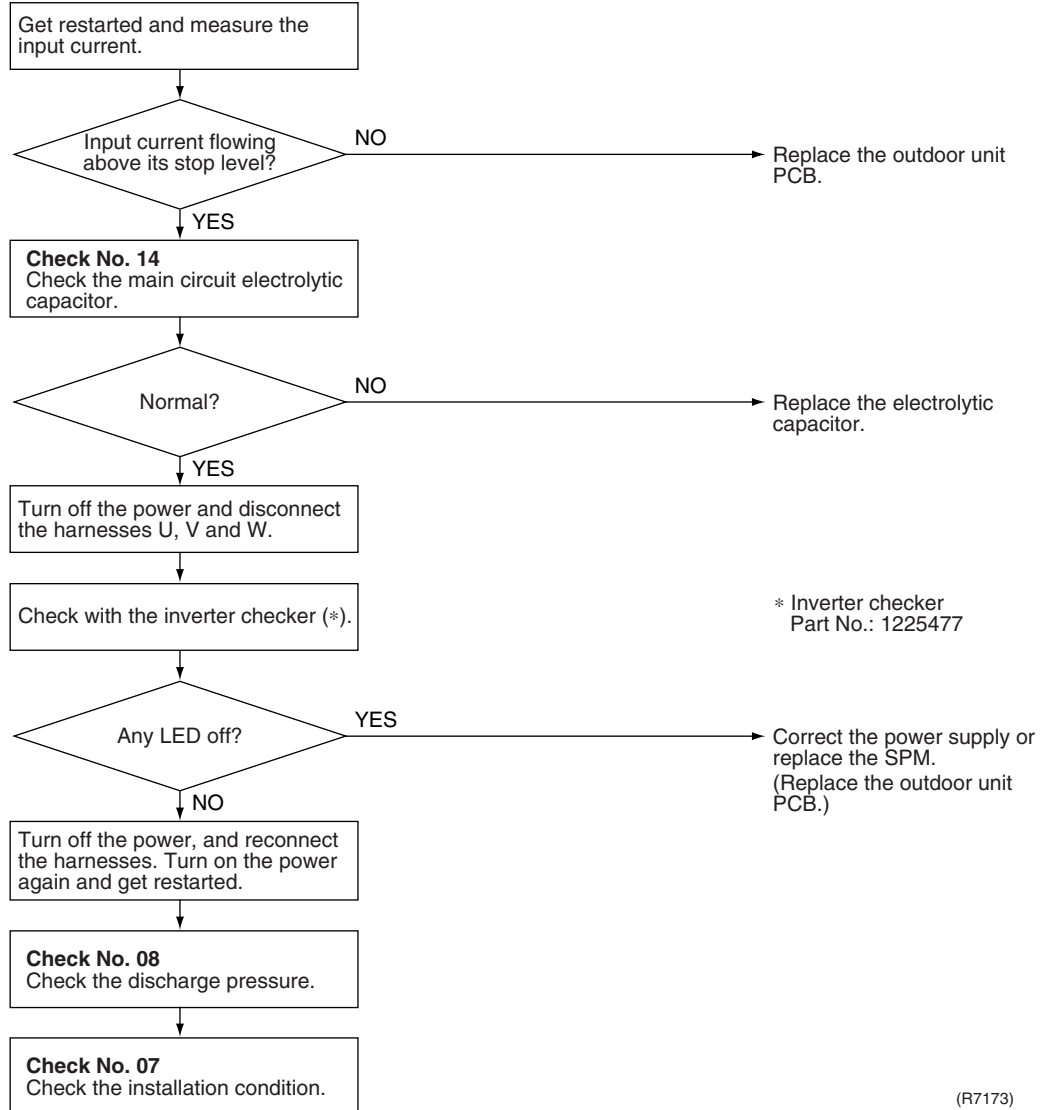

Be sure to turn off power switch before connect or disconnect connector, or parts damage may be occurred.

* An input over-current may result from wrong internal wiring. If the wires have been disconnected and reconnected for part replacement, for example, and the system is interrupted by an input over-current, check the wires again.





(R7173)

5.16 Discharge Pipe Temperature Control

Remote Controller Display	
Outdoor Unit LED Display	A  1  2  3  4 
Method of Malfunction Detection	The discharge pipe temperature control (stop, frequency drooping, etc.) is checked with the temperature being detected by the discharge pipe thermistor.
Malfunction Decision Conditions	<p>2YC36</p> <p>If the temperature being detected by the discharge pipe thermistor rises above 110°C, the compressor will stop. (The error is cleared when the temperature has dropped below 95°C.)</p> <ul style="list-style-type: none"> ■ If the compressor stops 6 times straight due to abnormal discharge pipe temperature, the system will be shut down. ■ The error counter will reset itself if this or any other error does not occur during the following 60-minute compressor running time (total time).
Supposed Causes	<ul style="list-style-type: none"> ■ Refrigerant shortage ■ Four way valve malfunctioning ■ Discharge pipe thermistor defective (heat exchanger or outdoor temperature thermistor defective) ■ Outdoor unit PCB defective ■ Water mixed in the local piping ■ Electronic expansion valve defective ■ Stop valve defective

Troubleshooting

-  **Check No.04**
Refer to P.274
-  **Check No.06**
Refer to P.276
-  **Check No.11**
Refer to P.279

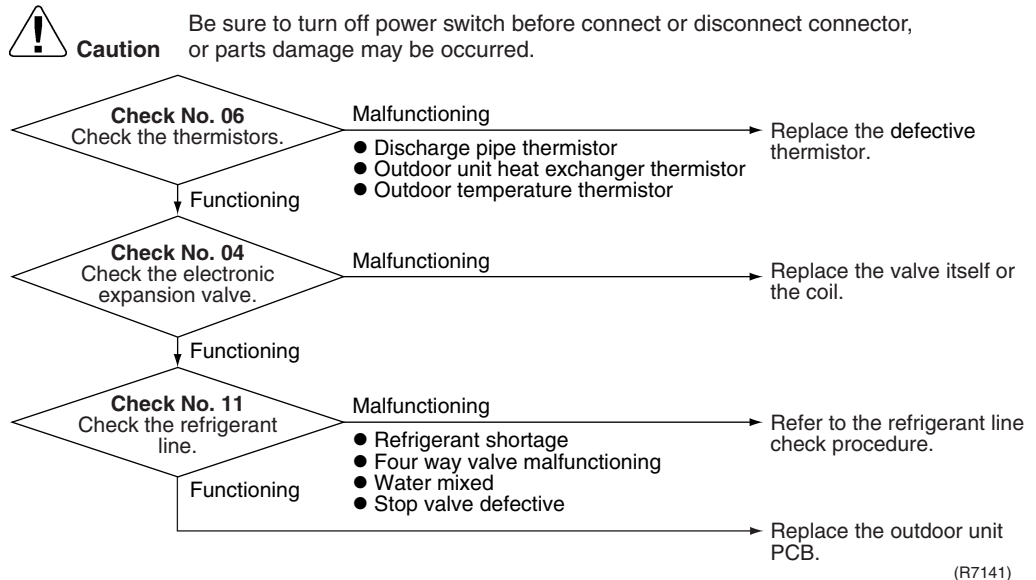

5.17 High Pressure Control in Cooling

Remote Controller Display

Outdoor Unit LED Display

Method of Malfunction Detection

High-pressure control (stop, frequency drop, etc.) is activated in the cooling mode if the temperature being sensed by the heat exchanger thermistor exceeds the limit.

Malfunction Decision Conditions

- Activated when the temperature being sensed by the heat exchanger thermistor rises above 65°C.
- The error is cleared when the temperature drops below 50°C.

Supposed Causes

- The installation space is not large enough.
- Faulty outdoor unit fan
- Faulty electronic expansion valve
- Faulty outdoor unit heat exchanger thermistor
- Faulty outdoor unit PCB
- Faulty stop valve
- Dirty heat exchanger

Troubleshooting



Check No.04
Refer to P.274



Check No.06
Refer to P.276



Check No.07
Refer to P.277



Check No.09
Refer to P.278



Caution

Be sure to turn off power switch before connect or disconnect connector, or parts damage may be occurred.

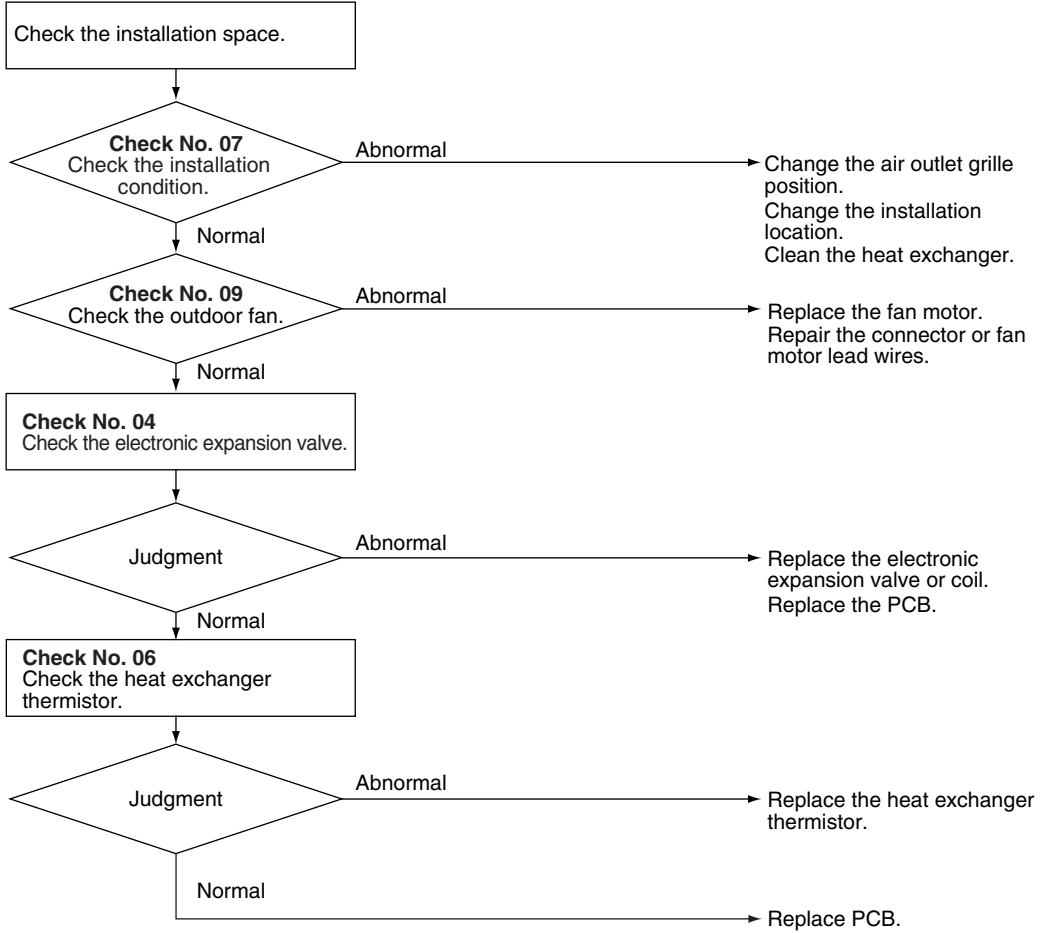





(R7142)

5.18 Compressor Sensor System Abnormality

Remote
Controller
Display

80

Outdoor Unit LED
Display

A  1  2  3  4

Method of
Malfunction
Detection

- Fault condition is identified by the supply voltage and the DC voltage which is detected before the compressor startup.
- Fault condition is identified by compressor current which is detected right after the compressor startup.

Malfunction
Decision
Conditions

- The detected value of the supply voltage and the DC voltage is obviously low or high.
- The compressor current doesn't run when the compressor is started.

Supposed
Causes

- Reactor disconnection
- Compressor disconnection
- Outdoor unit PCB defective
- Compressor defective

Troubleshooting

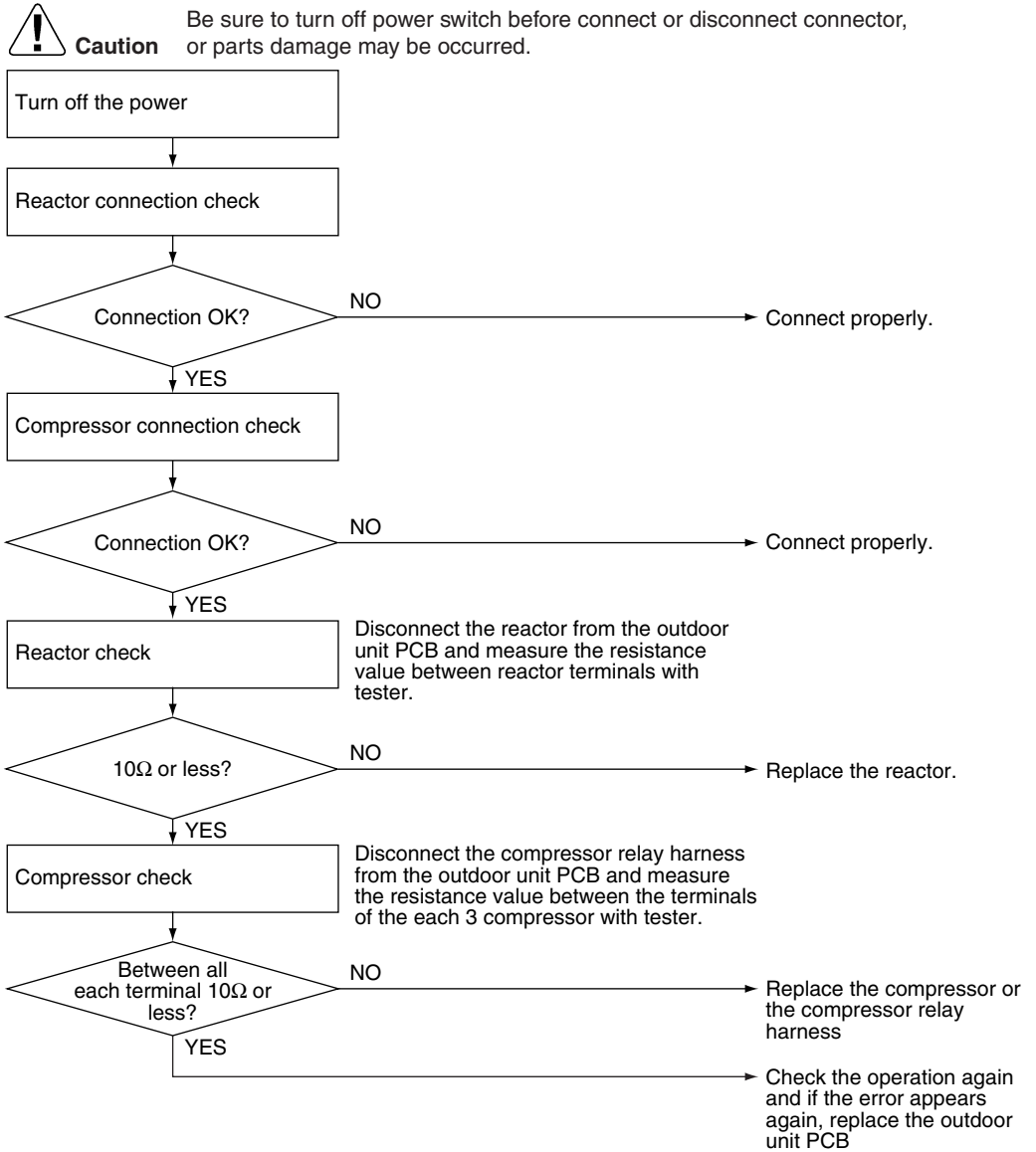

(R7174)

5.19 Position Sensor Abnormality

Remote Controller Display



Outdoor Unit LED Display

A 1 2 3 4

Method of Malfunction Detection

A compressor startup failure is detected by checking the compressor running condition through the position detection circuit.

Malfunction Decision Conditions

- The compressor fails to start in about 15 seconds after the compressor run command signal is sent.
- Clearing condition: Continuous run for about 5 minutes (normal)
- The system will be shut down if the error occurs 16 times.

Supposed Causes

- Compressor relay cable disconnected
- Compressor itself defective
- Outdoor unit PCB defective
- Stop valve closed
- Input voltage out of specification

Troubleshooting



Check No.13
Refer to P.280



Caution

Be sure to turn off power switch before connect or disconnect connector, or parts damage may be occurred.

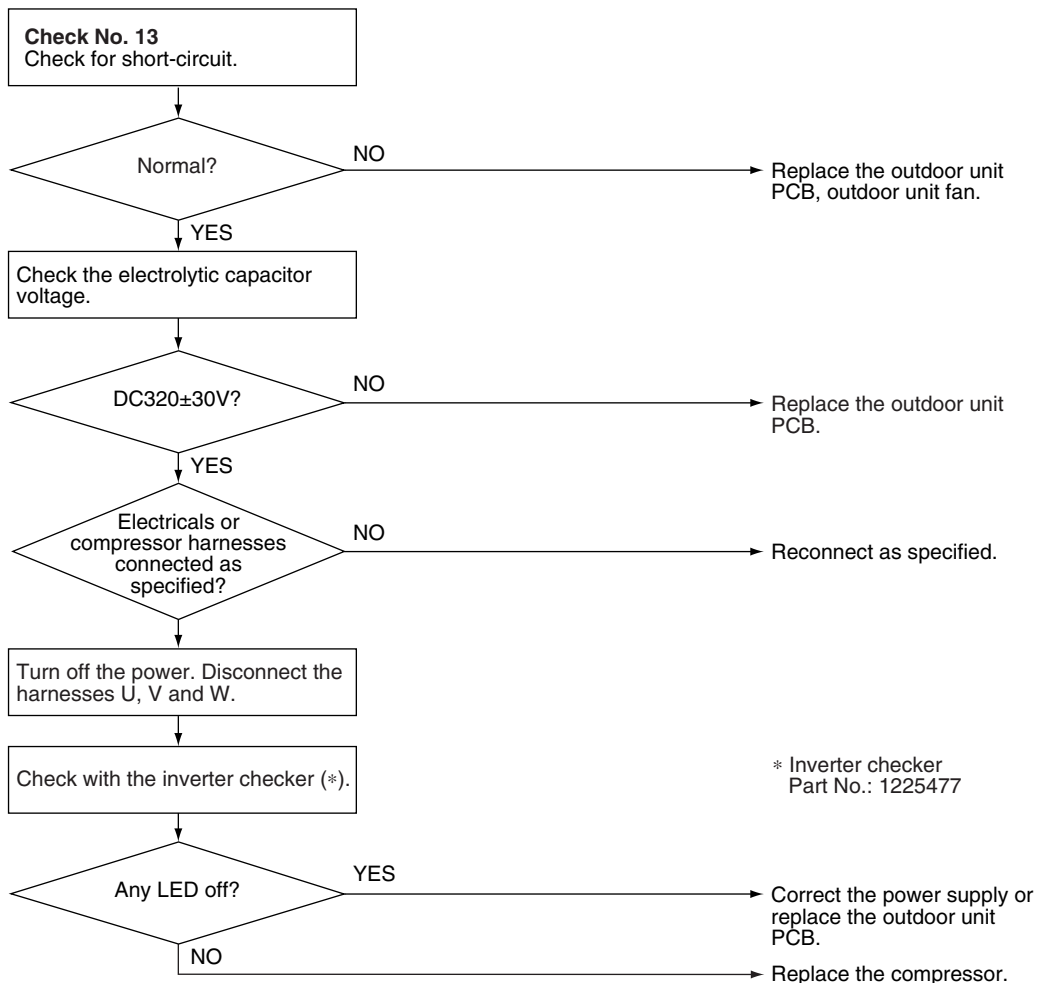

* Inverter checker
Part No.: 1225477

(R7175)

5.20 CT or Related Abnormality

Remote
Controller
Display



Outdoor Unit LED
Display

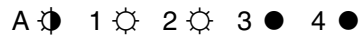

Method of
Malfunction
Detection

A CT or related error is detected by checking the compressor running frequency and CT-detected input current.

Malfunction
Decision
Conditions

- The compressor running frequency is below 55 Hz and the CT input is below 0.1 V. (The input current is also below 0.5 A.)
- If this error repeats 4 times, the system will be shut down.
- The error counter will reset itself if this or any other error does not occur during the following 60-minute compressor running time (total time).

Supposed
Causes

- Power transistor defective
- Internal wiring broken or in poor contact
- Reactor defective
- Outdoor unit PCB defective

Troubleshooting



Check No.12
Refer to P.280



Caution

Be sure to turn off power switch before connect or disconnect connector, or parts damage may be occurred.

Turn off the power and turn it on again.

Get the system started.

* Running current as shown at right with relay cable 1 or 2?

YES

Replace the outdoor unit PCB.

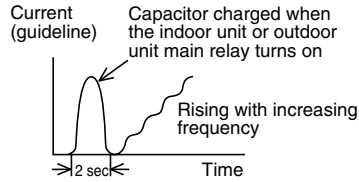

NO

Check No. 12
Check the capacitor voltage.

DC380±30V?

YES

Turn off the power. Disconnect the harnesses U, V and W.

Check with the inverter checker (*).

* Inverter checker
Part No.: 1225477

Any LED off?

YES

Correct the power supply or replace the PM1.
(Replace the outdoor unit PCB.)

NO

Turn off the power and reconnect the above harnesses. Then turn on the power again and get the system restarted.

Compressor running?

YES

Replace the outdoor unit PCB.

NO

Replace the compressor.

Voltage within the allowable range (Supply voltage±15%)?

YES





Replace the outdoor unit PCB.

NO

Check the supply voltage.

(R7184)

5.21 Thermistor or Related Abnormality (Outdoor Unit)

<p>Remote Controller Display</p>	<p>P4, U3, U6, U8, U9, H9</p>
<p>Outdoor Unit LED Display</p>	<p>A  1  2  3  4</p>
<p>Method of Malfunction Detection</p>	<p>This type of error is detected by checking the thermistor input voltage to the microcomputer. [A thermistor error is detected by checking the temperature being detected by each thermistor.]</p>
<p>Malfunction Decision Conditions</p>	<p>When the thermistor input is above 4.96 V or below 0.04 V with the power on, the U3 error is judged if the discharge pipe thermistor temperature is smaller than the condenser thermistor temperature, or the system will be shut down if all the units are judged with the U3 error.</p>
<p>Supposed Causes</p>	<ul style="list-style-type: none"> ■ Connector in poor contact ■ Thermistor defective ■ Outdoor unit PCB defective ■ Indoor unit PCB defective ■ Condenser thermistor defective in the case of U3 error (outdoor unit heat exchanger thermistor in the cooling mode, or indoor unit heat exchanger thermistor in the heating mode)

Troubleshooting



Check No.06
Refer to P.276



Caution

Be sure to turn off power switch before connect or disconnect connector, or parts damage may be occurred.

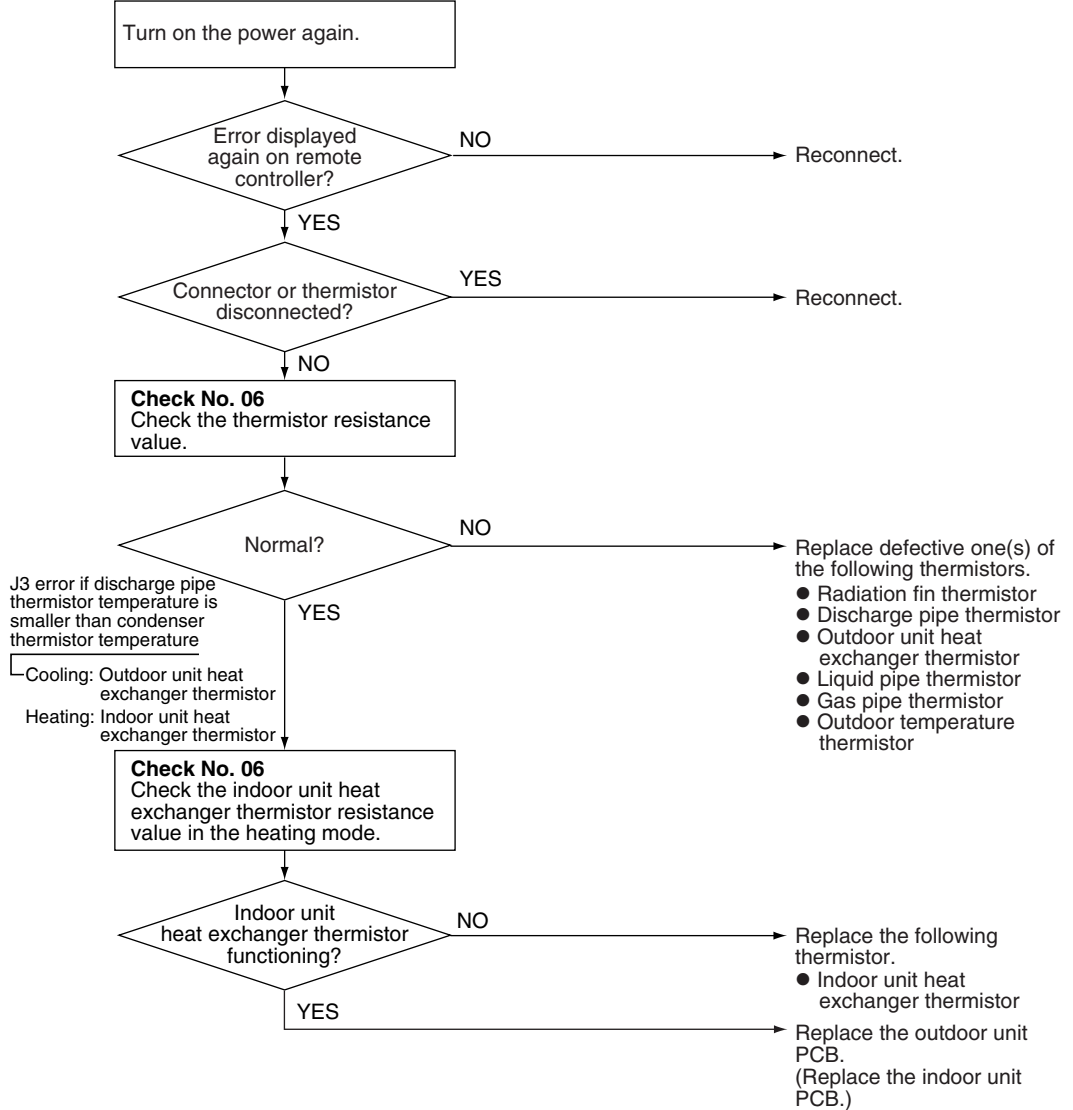

(R7176)

- P4 : Radiation fin thermistor
- J3 : Discharge pipe thermistor
- J5 : Outdoor unit heat exchanger thermistor
- J8 : Liquid pipe thermistor
- J9 : Gas pipe thermistor
- J9 : Outdoor temperature thermistor

5.22 Electrical Box Temperature Rise

Remote
Controller
Display



Outdoor Unit LED
Display



Method of
Malfunction
Detection

An electrical box temperature rise is detected by checking the radiation fin thermistor with the compressor off.

Malfunction
Decision
Conditions

- With the compressor off, the radiation fin temperature is above 100°C.
- The error is cleared when the temperature drops below 70°C.

Supposed
Causes

- Fin temperature rise due to defective outdoor unit fan
- Fin temperature rise due to short-circuit
- Fin thermistor defective
- Connector in poor contact
- Outdoor unit PCB defective

Troubleshooting



Check No.07
Refer to P.277



Check No.09
Refer to P.278



Caution

Be sure to turn off power switch before connect or disconnect connector, or parts damage may be occurred.

Turn off the power and turn it on again.



WARNING

To cool down the electricals, the outdoor unit fan gets started when the radiation fin temperature rises above 100°C and stops itself when it drops below 85°C.

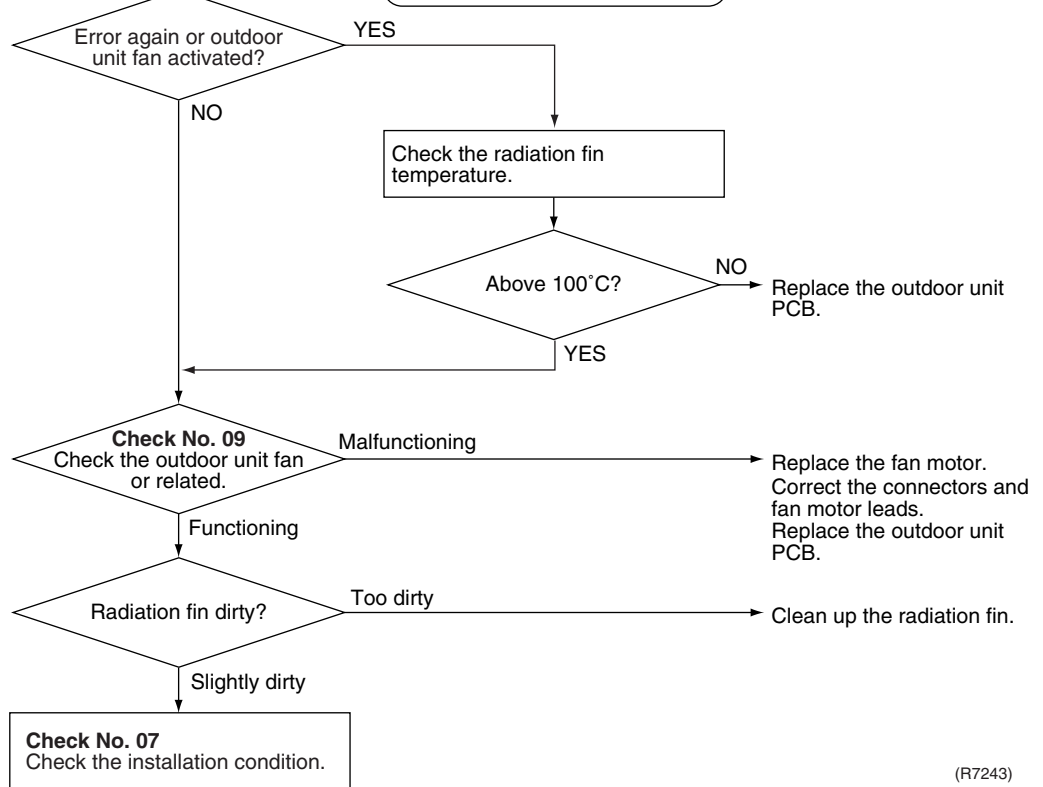



(R7243)

5.23 Radiation Fin Temperature Rise

Remote
Controller
Display

L4

Outdoor Unit LED
Display

A  1 ● 2 ● 3 ● 4 

Method of
Malfunction
Detection

A radiation fin temperature rise is detected by checking the radiation fin temperature being detected by the fin thermistor with the compressor on.

Malfunction
Decision
Conditions

- The radiation fin temperature with the compressor on is above 103°C.
- The error is cleared when the temperature drops below 95°C.
- If a radiation fin temperature rise takes place 255 times successively, the system will be shut down.
- The error counter will reset itself if this or any other error does not occur during the following 60-minute compressor running time (total time).

Supposed
Causes

- Fin temperature rise due to defective outdoor unit fan
- Fin temperature rise due to short-circuit
- Fin thermistor defective
- Connector in poor contact
- Outdoor unit PCB defective
- Silicon grease is not applied properly on the heat radiation fin after replacing outdoor unit PCB

Troubleshooting



Check No.07
Refer to P.277



Check No.09
Refer to P.278



Caution

Be sure to turn off power switch before connect or disconnect connector, or parts damage may be occurred.

Turn off the power and turn it on again to get the system started.

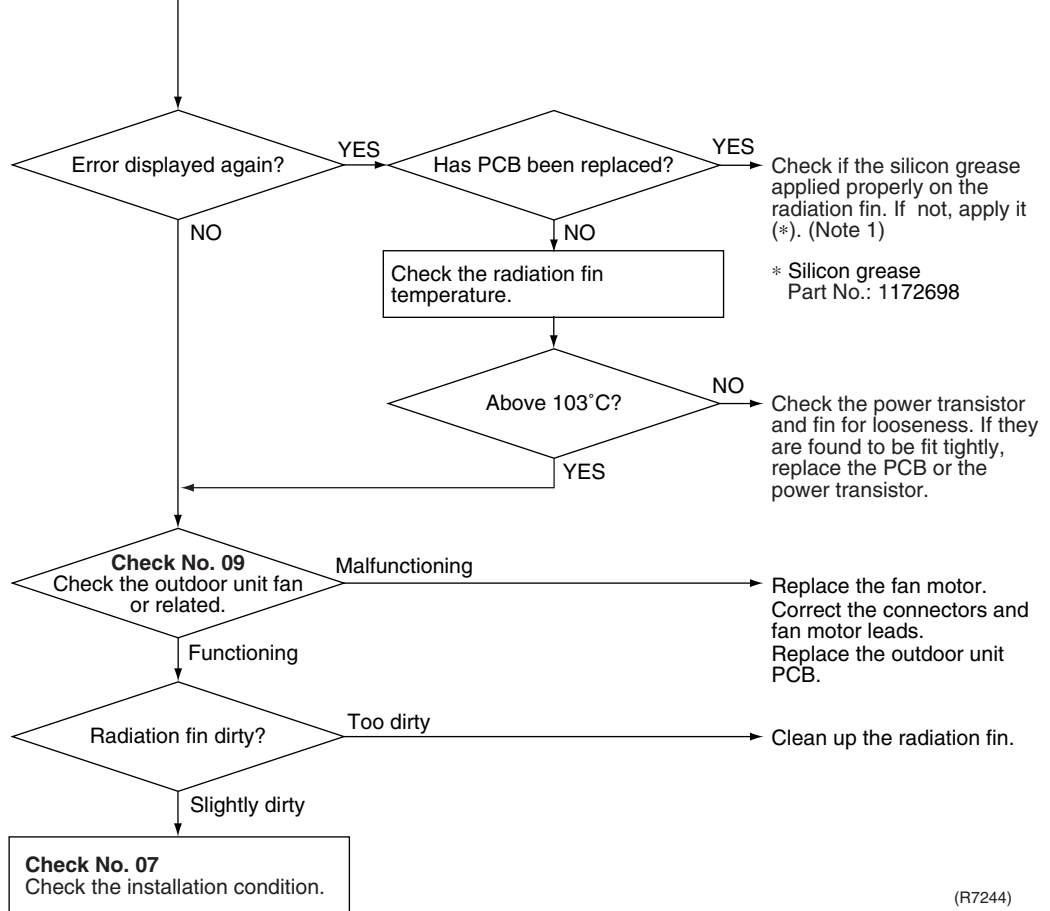

(R7244)





Note1: Refer to “1.3 Application of Silicon grease to a power transistor and a diode bridge” on P319.

5.24 Output Over Current Detection

Remote
Controller
Display

LS

Outdoor Unit LED
Display

A  1 ● 2 ● 3  4 ●

Method of
Malfunction
Detection

An output over-current is detected by checking the current that flows in the inverter DC section.

Malfunction
Decision
Conditions

- A position signal error occurs while the compressor is running.
- A speed error occurs while the compressor is running.
- An output over-current input is fed from the output over-current detection circuit to the microcomputer.
- The system will be shut down if the error occurs 16 times.
- Clearing condition: Continuous run for about 5 minutes (normal)

Supposed
Causes

- Over-current due to defective power transistor
- Over-current due to wrong internal wiring
- Over-current due to abnormal supply voltage
- Over-current due to defective PCB
- Error detection due to defective PCB
- Over-current due to closed stop valve
- Over-current due to compressor failure
- Over-current due to poor installation condition

Troubleshooting



Check No.07
 Refer to P.277

Check No.08
 Refer to P.278

Check No.13
 Refer to P.280

 **Caution** Be sure to turn off power switch before connect or disconnect connector, or parts damage may be occurred.

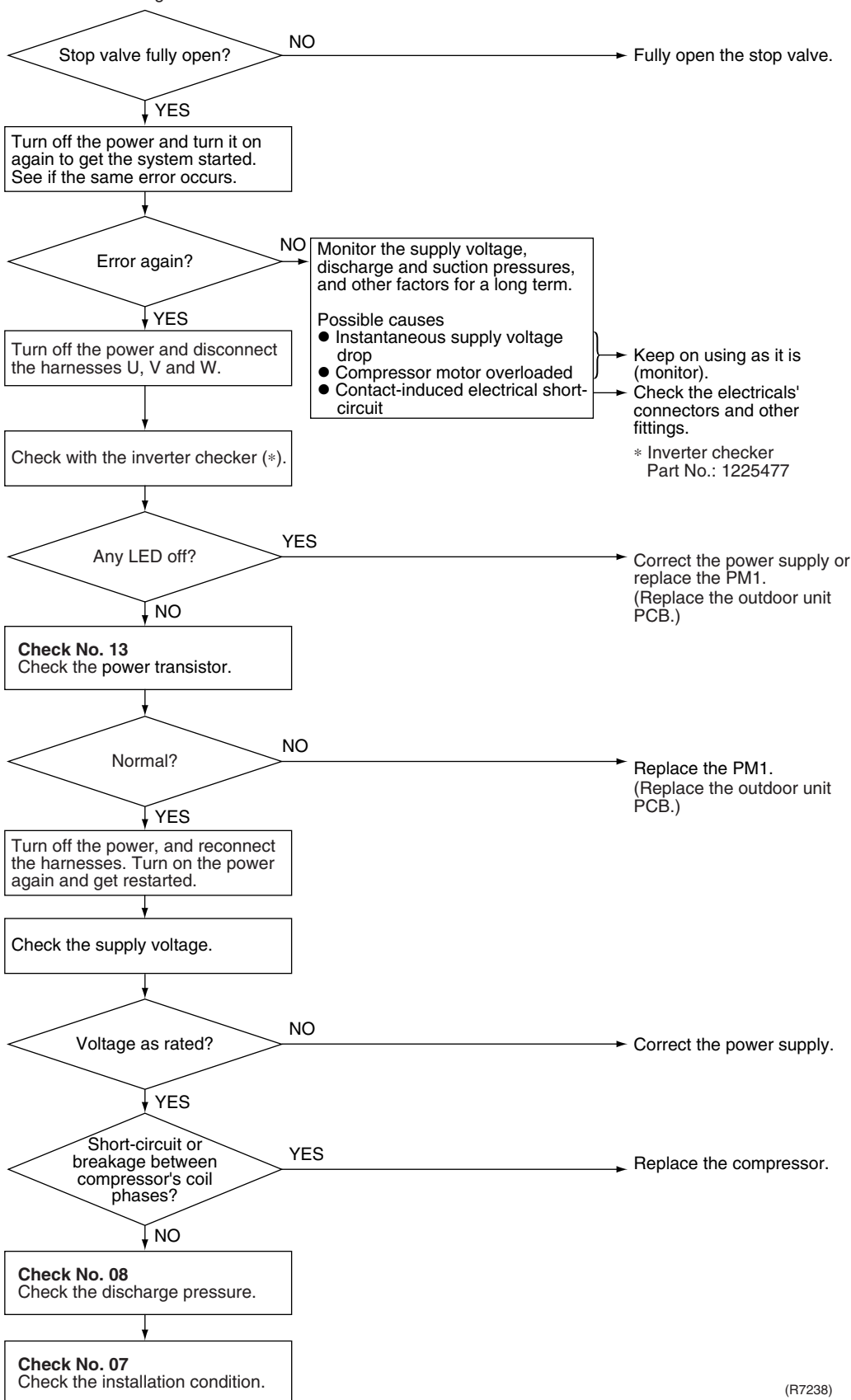



* An input over-current may result from wrong internal wiring. If the wires have been disconnected and reconnected for part replacement, for example, and the system is interrupted by an input over-current, check the wires again.



Keep on using as it is (monitor).
 Check the electricals' connectors and other fittings.
 * Inverter checker
 Part No.: 1225477

(R7238)

5.25 Insufficient Gas

<p>Remote Controller Display</p>	
<p>Outdoor Unit LED Display</p>	<p>A  1  2  3  4</p>
<p>Method of Malfunction Detection</p>	<p>Gas shortage detection I: Gas shortage is detected by checking the input current value and the compressor running frequency. If the gas is short, the input current is smaller than the normal value.</p> <p>Gas shortage detection II: Gas shortage is detected by checking the discharge temperature and the opening of the electronic expansion valve. If the gas is short, the discharge temperature tends to rise.</p>
<p>Malfunction Decision Conditions</p>	<p>Gas shortage detection I (typical value): The following conditions continue for 7 minutes.</p> <ul style="list-style-type: none"> ◆ DC current $\leq 0.01 \times \text{output frequency} + 0.3$ ◆ Output frequency > 55 (Hz) <p>Gas shortage detection II: The following conditions continue for 80 seconds.</p> <ul style="list-style-type: none"> ◆ Target opening of the electronic expansion valve ≥ 450 (pulse) ◆ Cooling: discharge temperature $> 255 / 256 \times \text{target discharge temperature} + 20$ (°C) Heating: discharge temperature $> 255 / 256 \times \text{target discharge temperature} + 40$ (°C) <p>If a gas shortage error takes place 4 times straight, the system will be shut down. The error counter will reset itself if this or any other error does not occur during the following 60-minute compressor running time (total time).</p>
<p>Supposed Causes</p>	<ul style="list-style-type: none"> ■ Refrigerant shortage (refrigerant leakage) ■ Poor compression performance of compressor ■ Discharge pipe thermistor disconnected, or indoor unit or outdoor unit heat exchanger thermistor disconnected, room or outside air temperature thermistor disconnected ■ Stop valve closed ■ Electronic expansion valve defective

Troubleshooting



Check No.04
Refer to P.274



Check No.06
Refer to P.276



Caution Be sure to turn off power switch before connect or disconnect connector, or parts damage may be occurred.

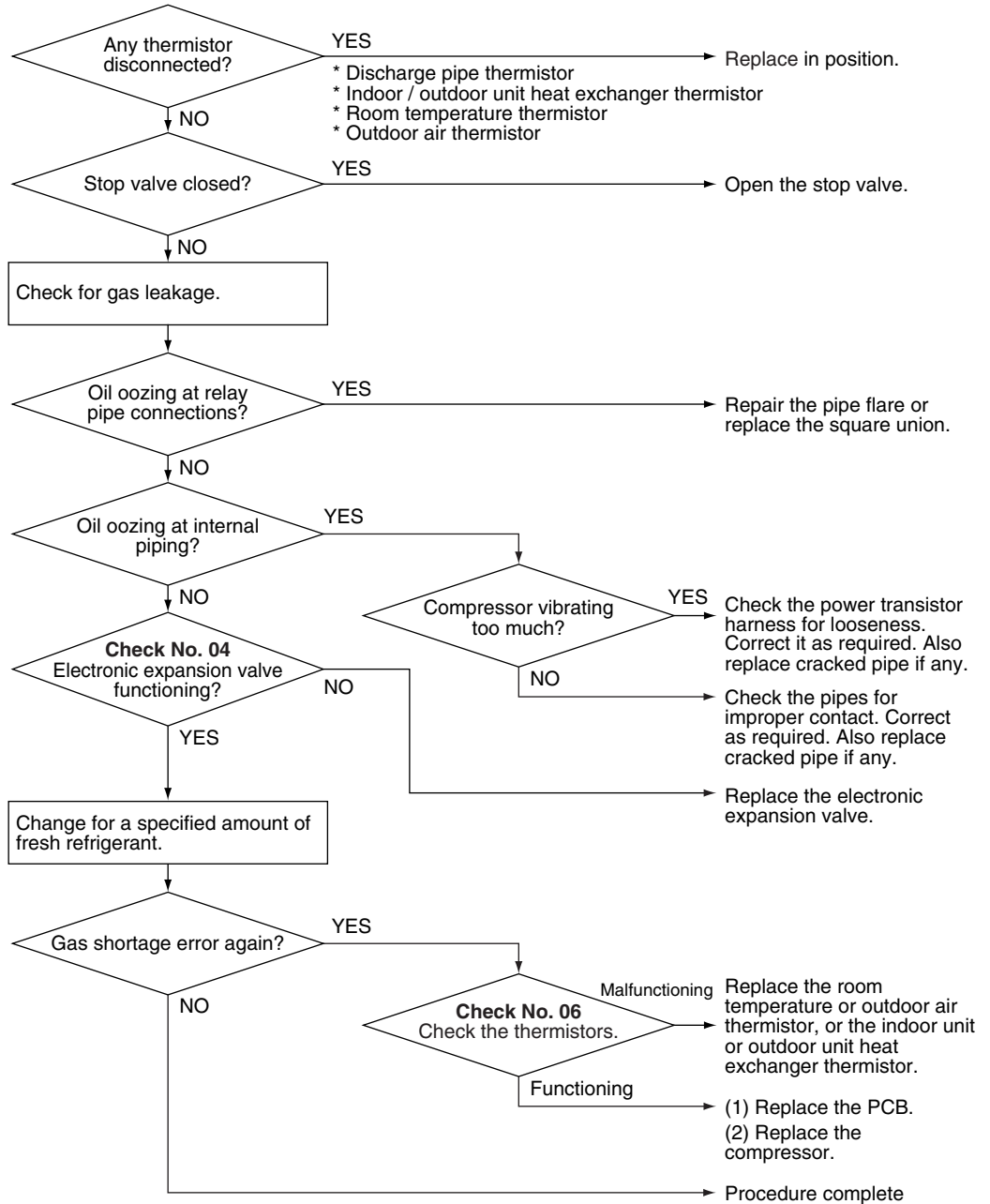

(R7149)

5.26 Low-voltage Detection or Over-voltage Detection

Remote
Controller
Display



Outdoor Unit LED
Display

A 1 2 3 4

Method of
Malfunction
Detection

An abnormal voltage rise or drop is detected by checking the detection circuit or DC voltage detection circuit.

Malfunction
Decision
Conditions

- An over-voltage signal is fed from the over-voltage detection circuit to the microcomputer, or the voltage being detected by the DC voltage detection circuit is judged to be below 150 V for 0.1 second.
- The system will be shut down if the error occurs 16 times.
- Clearing condition: Continuous run for about 60 minutes (normal)

Supposed
Causes

- Supply voltage not as specified
- Over-voltage detector or DC voltage detection circuit defective
- PAM control part(s) defective
- Short circuit inside the fan motor winding.

Troubleshooting

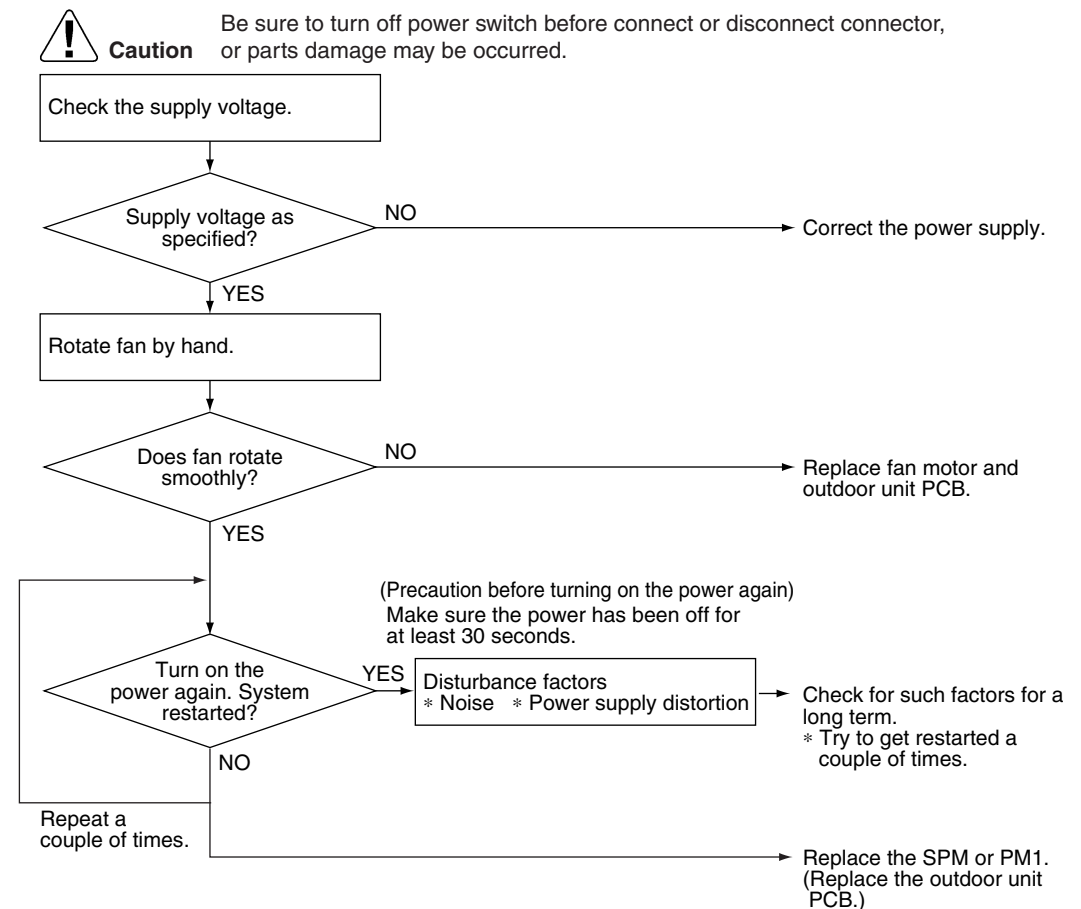

(R7245)

5.27 Signal Transmission Error (on Outdoor Unit PCB)

Remote
Controller
Display

U7

Outdoor Unit LED
Display

A 1 ● 2 ☉ 3 ☉ 4 ☉

Method of
Malfunction
Detection

Communication error between microcomputer mounted on the main PCB and PM1.

Malfunction
Decision
Conditions

- When the data sent from the PM1 can not be received successively for 9 sec.
- The abnormality is determined if the above fault conditions occurs once
- Fault counter is reset when the data from the PM1 can be successfully received.

Supposed
Causes

- Defective outdoor unit PCB

Troubleshooting



Caution

Be sure to turn off power switch before connect or disconnect connector, or parts damage may be occurred.

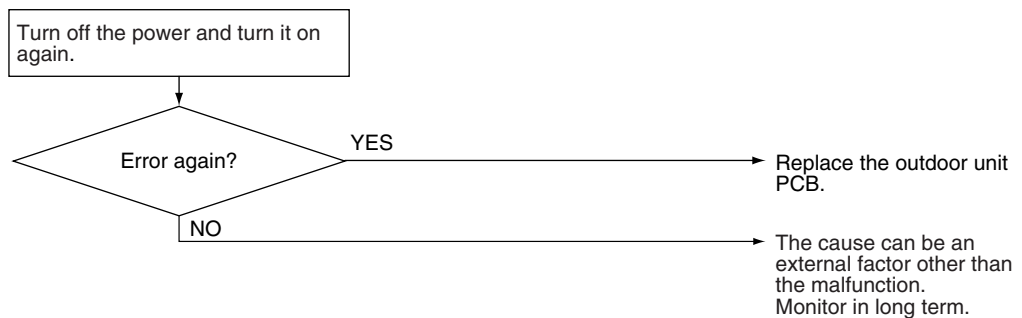

(R7185)

5.28 Anti-icing Function in Other Rooms / Unspecified Voltage (between Indoor and Outdoor Units)

Remote Controller Display

UR, UH

Outdoor Unit LED Display

A  1 ● 2 ● 3 ● 4 ●

Method of Malfunction Detection

A wrong connection is detected by checking the combination of indoor and outdoor units on the microcomputer.

Malfunction Decision Conditions

- Operation halt due to the anti-icing function in other rooms
- Operation halt due to unspecified internal and/or external voltages
- Operation halt due to mismatching of indoor and outdoor units

Supposed Causes

- Operation halt due to the anti-icing function in other rooms
- Wrong connections at the indoor unit
- PCB wrongly connected

Troubleshooting

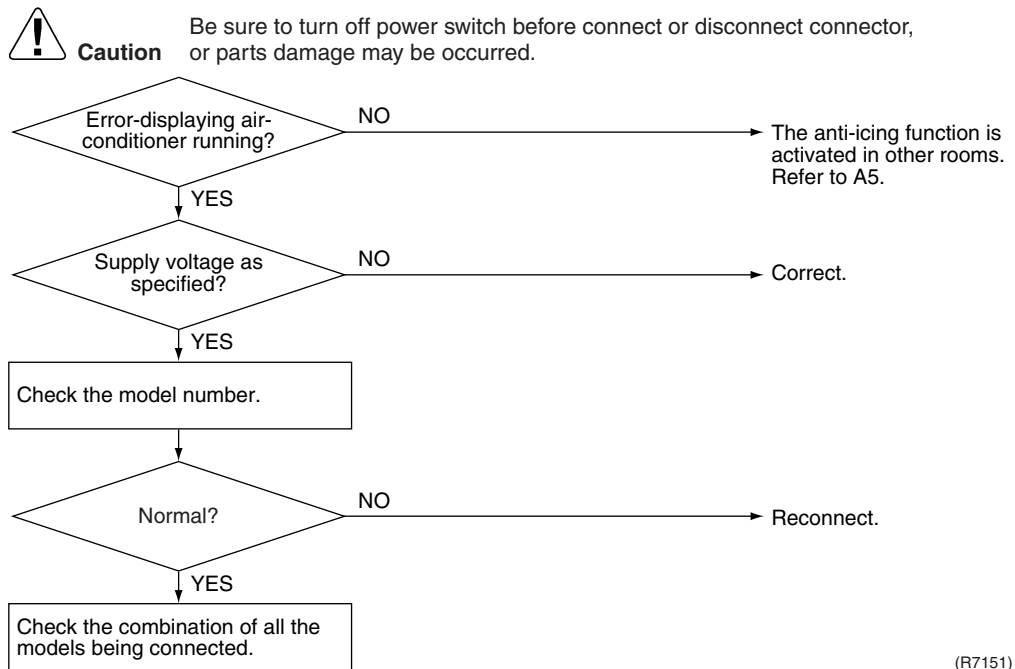

6. Check

6.1 How to Check

6.1.1 Fan Motor Connector Output Check

Check No.01

1. Check connector connection.
2. Check motor power supply voltage output (pins 4-7 and 4-8).
3. Check motor control voltage (pins 4-3).
4. Check rotation command voltage output (pins 4-2).
5. Check rotation pulse input (pins 4-1).

S1 or S301

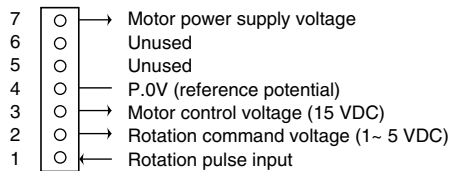

S302

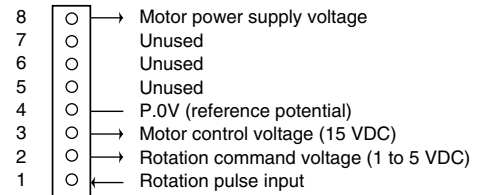

(R4684)

Check No.02

1. Check connector connection.
2. Check motor control voltage output (pins 2-1).

S202

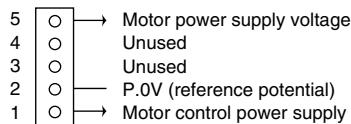

(R1073)

6.1.2 Limit Switch Continuity Check

Check No.03

Remove the front grille. The limit switch is located at the left side of the drain pan assembly. Check the continuity of the switch connection.

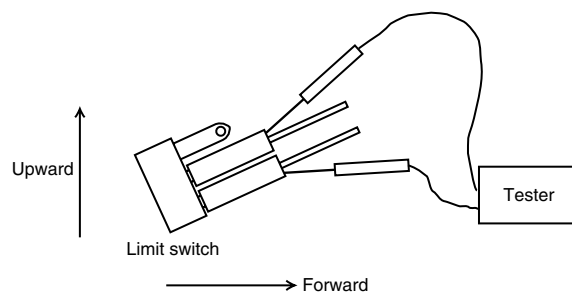

Shutter status	Open	Closed
Continuity	Continuity	No continuity

(Q0363)

- * The shutter can be opened and closed with hand. Keep the shutter open and closed all the way for each continuity check steps.

6.1.3 Electronic Expansion Valve Check

Check No.04

Conduct the followings to check the electronic expansion valve (EV).

1. Check to see if the EV connector is correctly inserted in the PCB. Compare the EV unit and the connector number.
2. Turn the power off and back on again, and check to see if all the EVs generate latching sound.
3. If any of the EVs does not generate latching noise in the above step 2, disconnect that connector and check the conductivity using a tester.
Check the conductivity between pins 1, 3 and 6, and between pins 2, 4 and 5. If there is no conductivity between the pins, the EV coil is faulty.
4. If no EV generates latching sound in the above step 2, the outdoor unit PCB is faulty.
5. If the conductivity is confirmed in the above step 2, mount a good coil (which generated latching sound) in the EV unit that did not generate latching sound, and check to see if that EV generates latching sound.
*If latching sound is generated, the outdoor unit PCB is faulty.
*If latching sound is not generated, the EV unit is faulty.



Note: Please note that the latching sound varies depending on the valve type.

Valve Body Condition (Symptom)	Check Method / Measure
<p>(1) Valve body catches at fully opened or half opened position. (Symptom)</p> <p>Cooling: ■Water leakage at the no-operation unit ■Flow noise of refrigerant in the no-operation unit ■Operation halt due to icing protection</p> <p>Heating: ■The unit does not heat ■Refrigerant flow rate vary by unit (Discharge air temperatures are different by room) ■Peak cut</p>	<p>Reset power supply and conduct cooling operation unit by unit.</p> <div style="border: 1px solid black; padding: 5px; margin-bottom: 5px;">Check the liquid pipe temperature of no-operation unit.</div> <div style="text-align: center;"> </div>
<p>(2) Valve body catches at complete close position. (Symptom)</p> <p>Cooling: ■The only unit having problem does not cool the room . ■When the only faulty unit is in operation, the unit makes pump down. (The low pressure of the unit becomes vacuum) ■IT is activated. ■Abnormal discharge pipe temperature</p> <p>Heating: Insufficient gas due to liquid refrigerant stagnation inside the faulty indoor unit</p> <p>(Only for heat pump model) ■The unit does not heat the room. ■IT is activated. ■Abnormal discharge pipe temperature</p>	<p>Reset power supply and conduct cooling operation unit by unit.</p> <div style="border: 1px solid black; padding: 5px; margin-bottom: 5px;">Check the low pressure</div> <div style="text-align: center;"> </div>
<p>(3) Valve does not open fully. (Symptom)</p> <p>■The unit does not cool nor heat (only for heat pump model.) ■IT is actuated. ■Abnormal discharge pipe temperature</p>	<p>Check the number of rotation of shaft if it is 5 and half from full open to complete close using manual coil for electronic expansion valve. When the number of rotation of shaft is less than the above value, the valve may catch anywhere of the body.</p>

6.1.4 Four Way Valve Performance Check

Check No.05

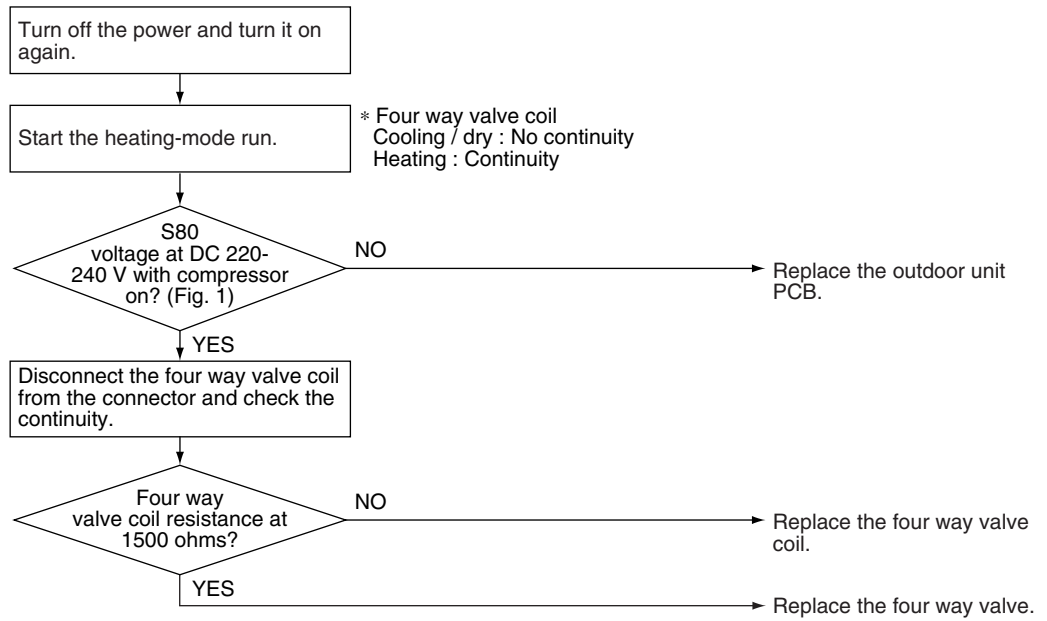

(Fig. 1)

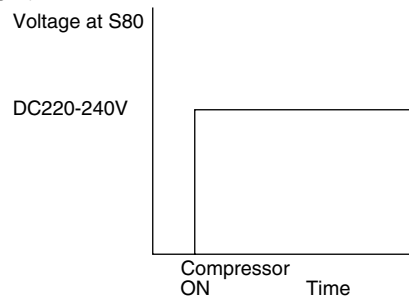

(R7156)

6.1.5 Thermistor Resistance Check

Check No.06

Remove the connectors of the thermistors on the PCB, and measure the resistance of each thermistor using tester.

The relationship between normal temperature and resistance is shown in the graph and the table below.

Temperature (°C)	Thermistor R25°C=20kΩ B=3950
-20	211.0 (kΩ)
-15	150
-10	116.5
-5	88
0	67.2
5	51.9
10	40
15	31.8
20	25
25	20
30	16
35	13
40	10.6
45	8.7
50	7.2

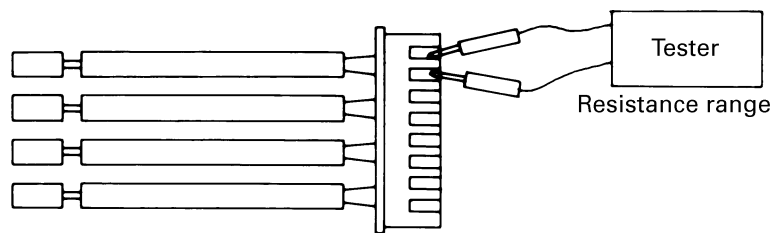

(R25=20k Ω 、 B=3950)

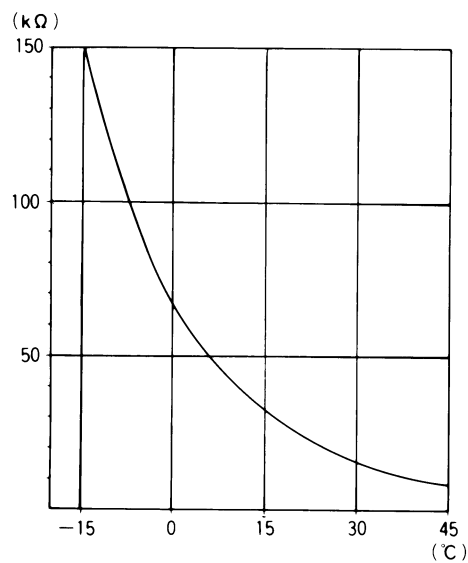

(R1437)

6.1.6 Installation Condition Check

Check No.07

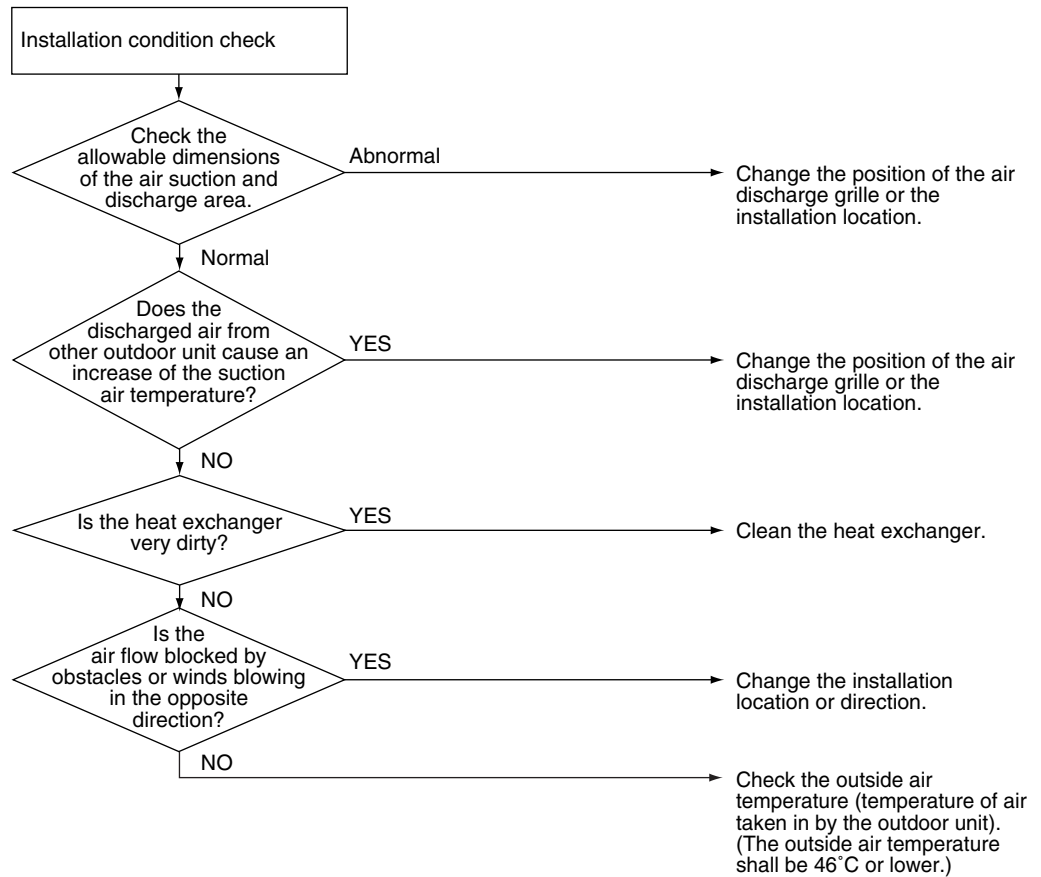

(R7157)

6.1.7 Discharge Pressure Check

Check No.08

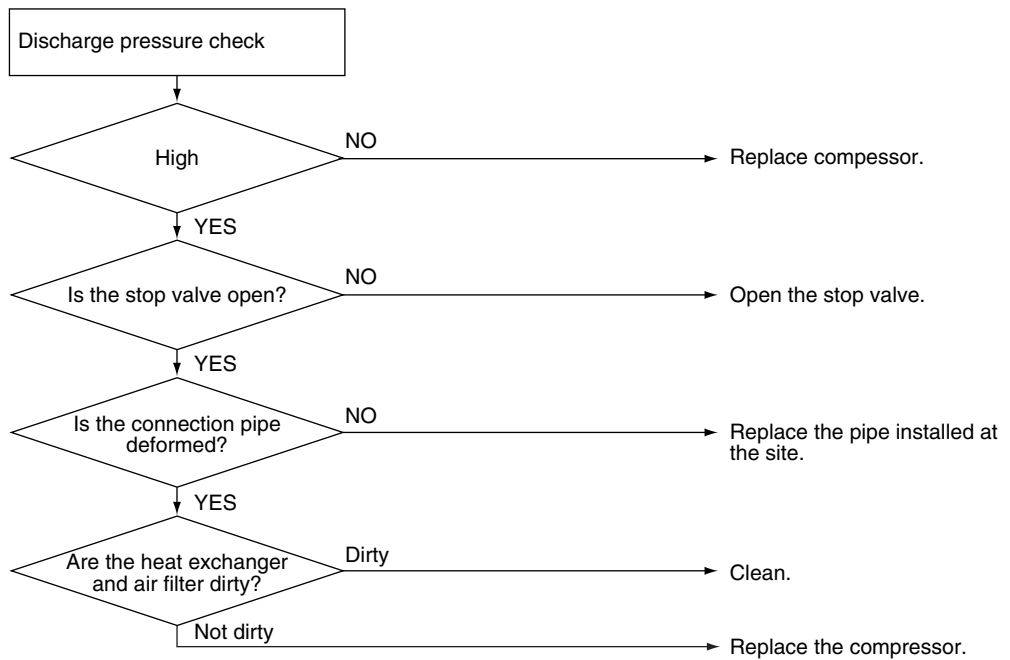

(R7158)

6.1.8 Outdoor Unit Fan System Check (With DC Motor)

Check No.09

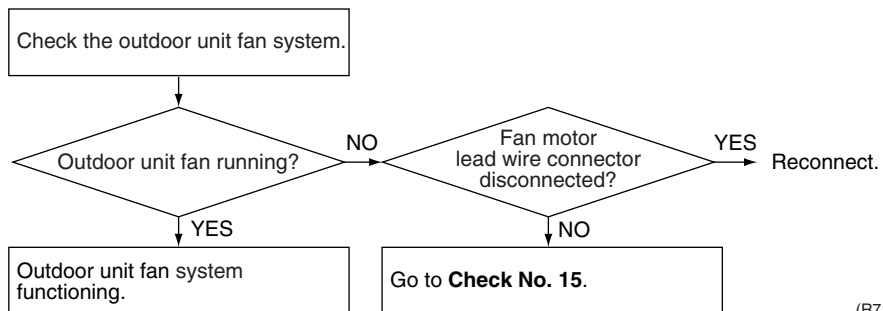

(R7159)

6.1.9 Power Supply Waveforms Check

Check No.10

Measure the power supply waveform between pins 1 and 3 on the terminal board, and check the waveform disturbance.

- Check to see if the power supply waveform is a sine wave (Fig.1).
- Check to see if there is waveform disturbance near the zero cross (sections circled in Fig.2)

[Fig.1]

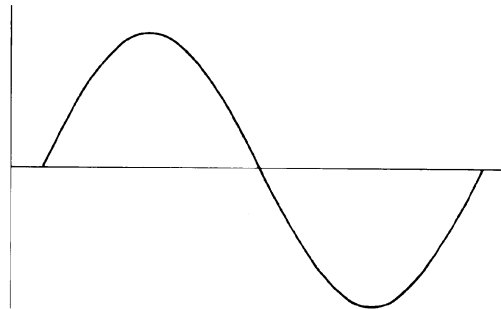

(R1736)

[Fig.2]

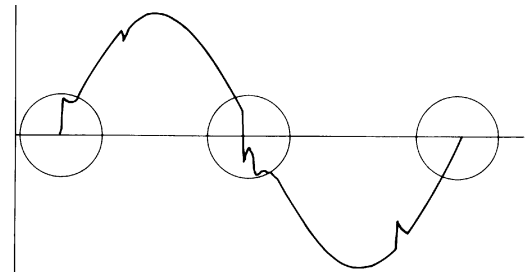

(R1444)

6.1.10 Inverter Units Refrigerant System Check

Check No.11

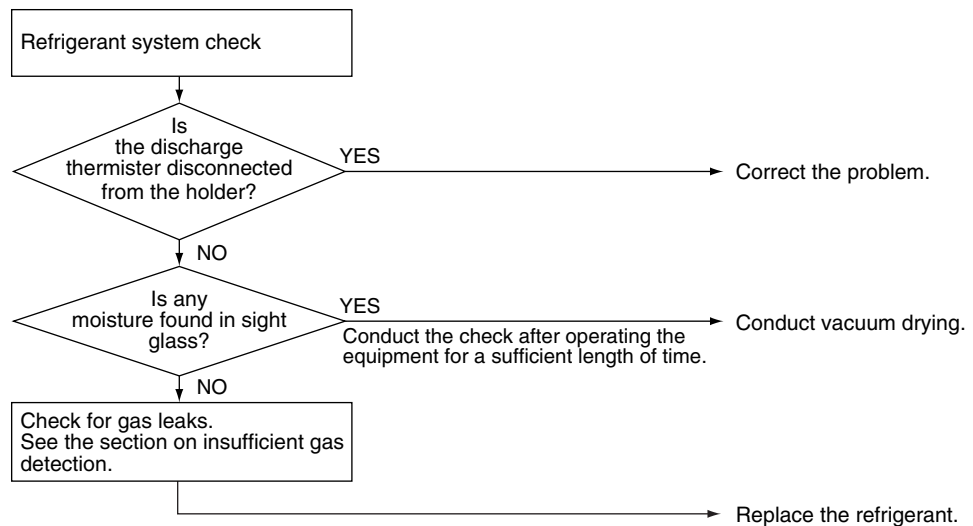

(R7237)

6.1.11 Capacitor Voltage Check

Check No.12

Before this checking, be sure to check the main circuit for short-circuit.

- Checking the capacitor voltage
- With the circuit breaker still on, measure the voltage according to the drawing of the model in question. Be careful never to touch any live parts.

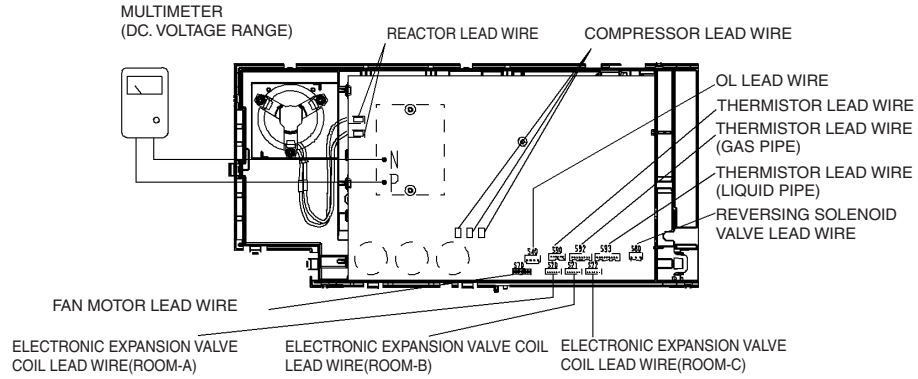

(R5154)

6.1.12 Power Transistor Check

Check No.13

- Checking the power transistor
- Never touch any live parts for at least 10 minutes after turning off the circuit breaker.
- If unavoidably necessary to touch a live part, make sure the power transistor's supply voltage is below 50 V using the tester.
- For the UVW, make measurements at the Faston terminal on the board or the relay connector.

Tester's negative terminal	Power transistor (+)	UVW	Power transistor (-)	UVW
Tester's positive terminal	UVW	Power transistor (+)	UVW	Power transistor (-)
Normal resistance	Several kohms to several Mohms			
Abnormal resistance	0 or ∞			

6.1.13 Main Circuit Electrolytic Capacitor Check

Check No.14

- Checking the main circuit electrolytic capacitor
- Never touch any live parts for at least 10 minutes after turning off the circuit breaker.
- If unavoidably necessary to touch a live part, make sure there is no DC voltage using the tester.
- Check the continuity with the tester. Reverse the pins and make sure there is continuity.

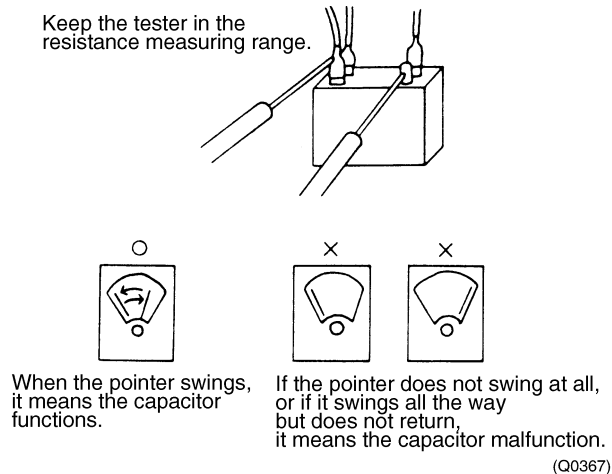

6.1.14 Turning Speed Pulse Input on the Outdoor Unit PCB Check

Check No.15

<Propeller fan motor>

Make sure the voltage of $320\pm 30V$ is being applied.

- (1) Stop the operation first and then the power, and disconnect the connector S70.
- (2) Make sure there is about DC 320 V between pins 4 and 7.
- (3) With the system and the power still off, reconnect the connector S70.
- (4) Make a turn of the fan motor with a hand, and make sure the pulse (0-15 V) appears twice at pins 1 and 4.

If the fan motor protection fuse is blown out, the outdoor-unit fan may also be in trouble. Check the fan too.

If the voltage in Step (2) is not applied, it means the PCB is defective. Replace the PCB.

If the pulse in Step (4) is not available, it means the Hall IC is defective. Replace the DC fan motor. If there are both the voltage (2) and the pulse (4), replace the PCB.

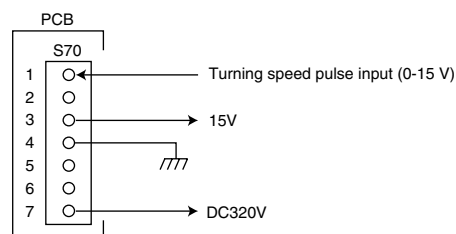

(R5223)

* Propeller fan motor : S70

6.1.15 Hall IC Check

Check No.16

1. Check the connector connection.
2. With the power ON, operation OFF, and the connector connected, check the following.
 - *Output voltage of about 5 V between pins 1 and 3.
 - *Generation of 3 pulses between pins 2 and 3 when the fan motor is operating.

Failure of (1) → faulty PCB → Replace the PCB.

Failure of (2) → faulty Hall IC → Replace the fan motor.

Both (1) and (2) result → Replace the PCB.

The connector has 3 pins, and there are two patterns of lead wire colors.

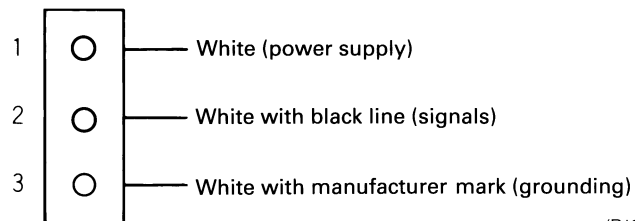
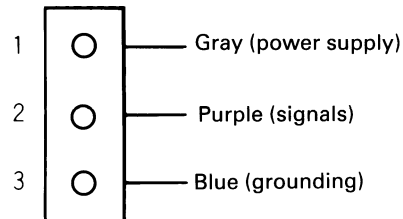

(R1990)

Part 7

Removal Procedure

1. Outdoor Unit.....	284
1.1 Removal of the Panels and Plates	284
1.2 Removal of the Electrical Box	289
1.3 Removal of the PCB.....	296
1.4 Removal of the Propeller Fan / Fan Motor	302
1.5 Removal of the Sound Blanket.....	304
1.6 Removal of Electronic Expansion Valve Coil, Four Way Valve Coil and Thermistor	308
1.7 Removal of the Distributor.....	311
1.8 Removal of the Four Way Valve.....	312
1.9 Removal of the Compressor.....	313

1. Outdoor Unit

1.1 Removal of the Panels and Plates

Procedure



Warning

Be sure to wait 10 minutes or more after turning off all power supplies before disassembling work.

Step	Procedure	Procedure	Points
1	External appearance.	<p>Top panel</p> <p>handle</p> <p>Discharge grille</p> <p>Stop valve cover</p> <p>Front panel (R5494)</p> <p>Outdoor air thermistor</p> <p>(R5495)</p>	<ul style="list-style-type: none"> Take care not to cut your finger by the fins of the heat exchanger.
2	Loosen the 4 screws (2 on both sides) of the top panel.	<p>Top panel</p> <p>Discharge grille</p> <p>Front panel (R5496)</p>	

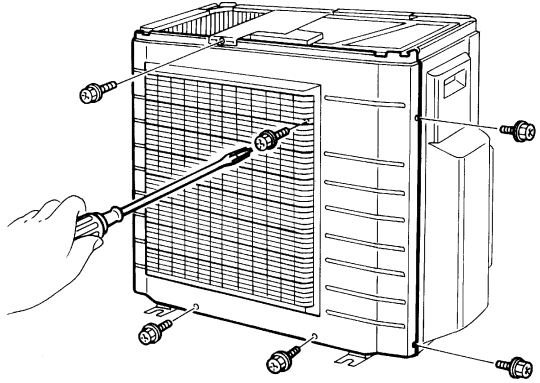
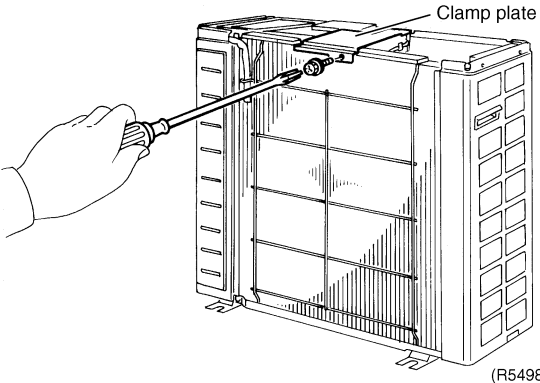
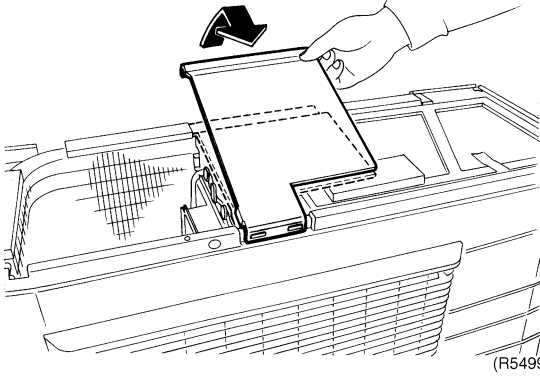
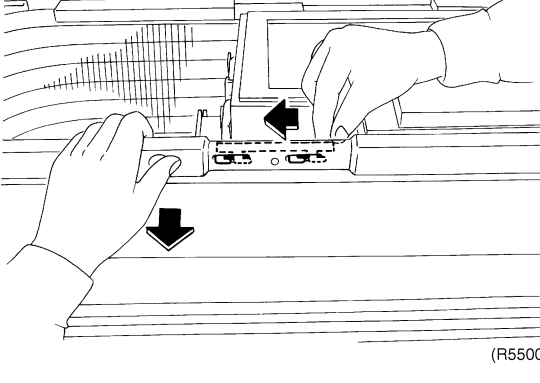
Step	Procedure	Procedure	Points
3	Loosen the 6 screws of the front panel.	 <p>(R5497)</p>	
4	Loosen the 2 screws (each 1 in front and back) of the clamp plate.	 <p>Clamp plate (R5498)</p>	
5	Slide the clamp plate to the left to undo the hooks and remove the plate.	 <p>(R5499)</p>	
6	Undo the upper 2 hooks to remove the front panel.	 <p>(R5500)</p>	<ul style="list-style-type: none"> ■ Align the position of hole of the upper hook to pull the front panel out.

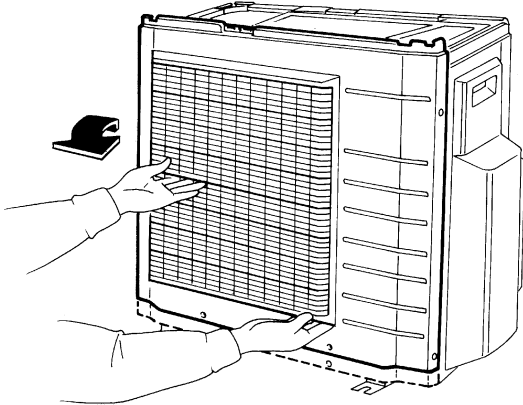
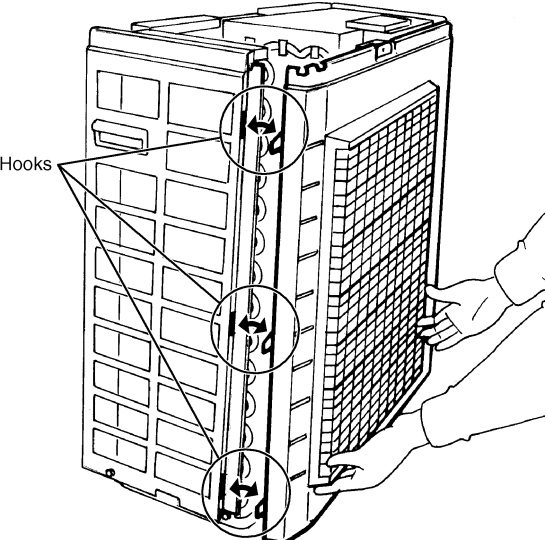
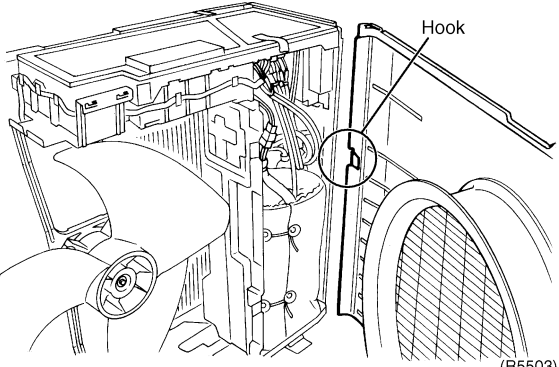
Step	Procedure	Points
7	Lift the front panel up to remove the left side hooks and open the panel.	
	 <p>(R5501)</p>	
8	The front panel has the 3 hooks on the left.	
	 <p>(R5502)</p>	
9	The front panel has the 1 hook on the right.	
	 <p>(R5503)</p>	

Step	Procedure	Points
10	Loosen the 4 screws of the discharge grille.	
11	Loosen the 2 screws of the stop valve cover. And then slide the cover downward to remove.	

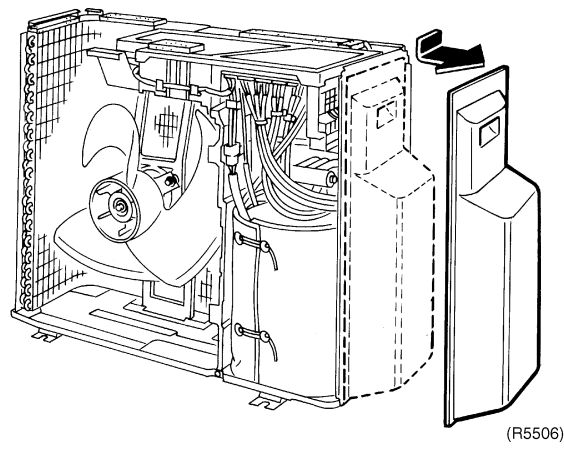
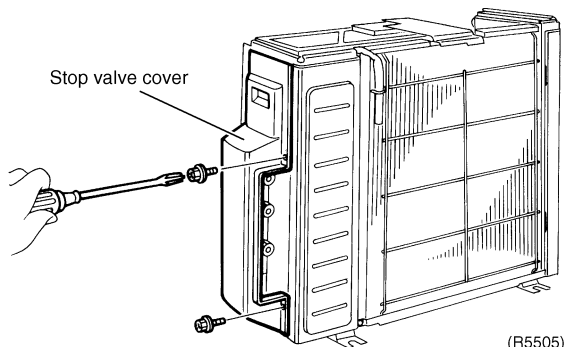
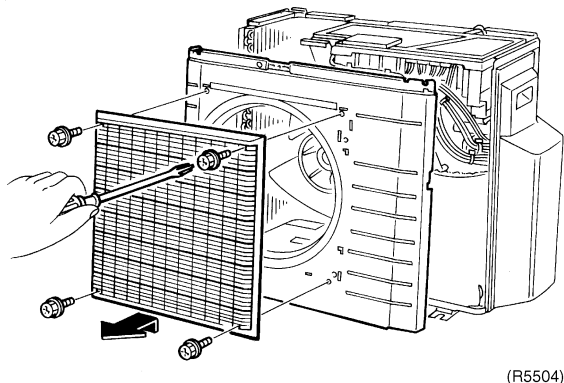

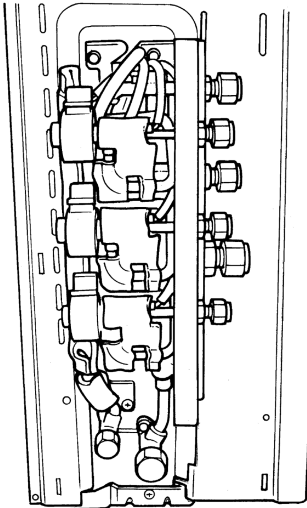
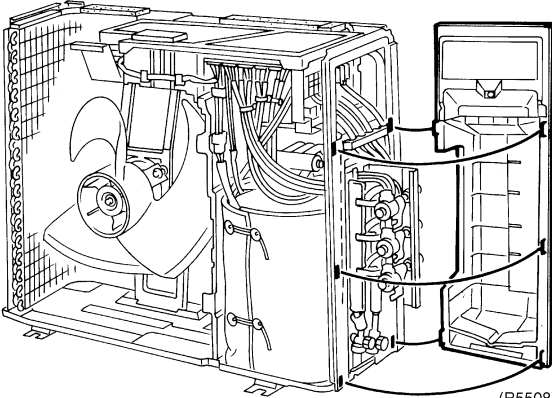
Step	Procedure	Points
	 <p>(R5507)</p>  <p>(R5508)</p>	<ul style="list-style-type: none"> ■ When assembling, make sure to catch the 5 hooks.

1.2 Removal of the Electrical Box

Procedure



Warning

Be sure to wait 10 minutes or more after turning off all power supplies before disassembling work.

Step	Procedure	Points
1. Disconnect the connecting wires	<p>1 Inside structure.</p>	<p>★ Illustrations are for 3 room model.</p>
2. Disconnect the connecting wires.		<ul style="list-style-type: none"> ■ Connecting wires of the A, B, C, D port <ul style="list-style-type: none"> (1) - Black Power supply (2) - White Power supply (3) - Red Transmission ■ Power Supply wires <ul style="list-style-type: none"> (L) - Black (N) - White ■ Fasten the wires on the terminal board with screws.

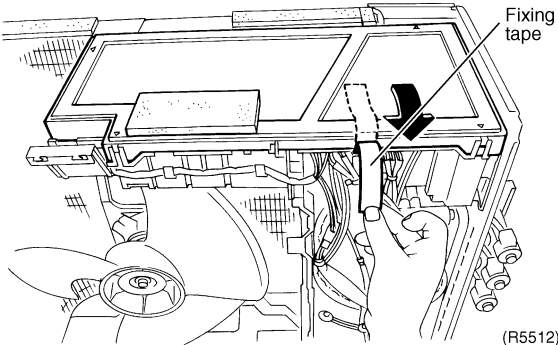
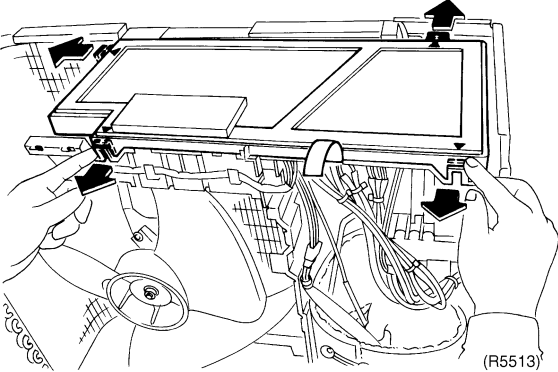
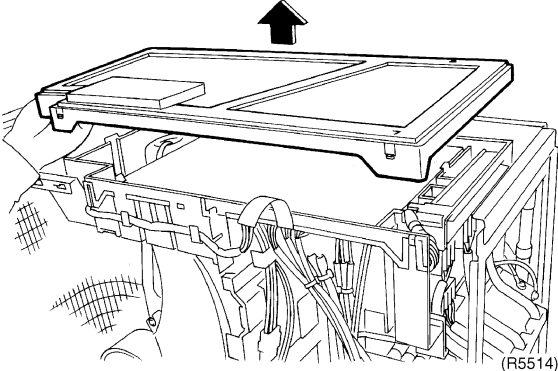
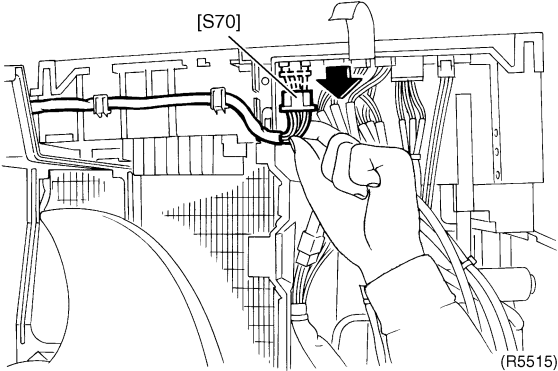
Step	Procedure	Points
2.	Disconnect the each harnesses	
1	Detach the fixing tape for the electrical box (cover).  <p style="text-align: right;">(R5512)</p>	
2	Undo the 4 hooks at the ▲ mark of the drip proof cover.  <p style="text-align: right;">(R5513)</p>	
3	Lift the cover up to remove.  <p style="text-align: right;">(R5514)</p> <p style="text-align: right;">(R5516)</p>	<ul style="list-style-type: none"> ■ Check the LED through the slit.
4	Disconnect the connector for fan motor [S70] from the PCB.  <p style="text-align: right;">(R5515)</p>	

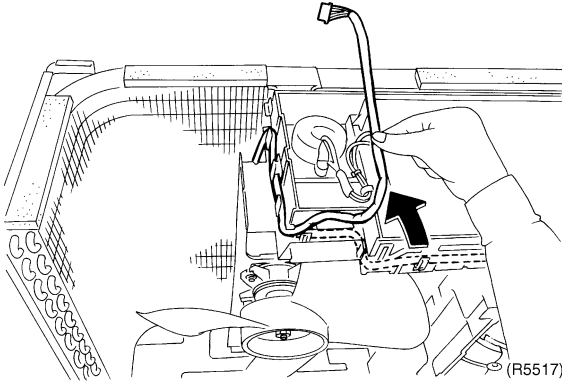
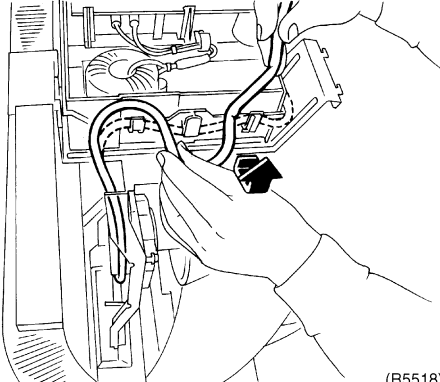
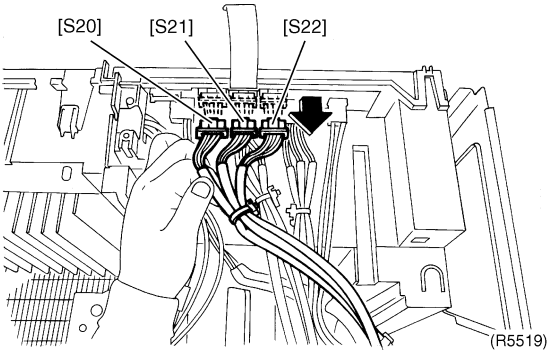
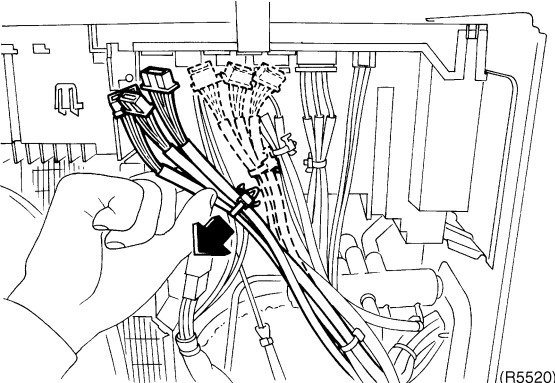
Step	Procedure	Points
5	<p>The figure shows the arrangement of the wire harness for fan motor.</p>  	
6	<p>Disconnect the connectors for electronic expansion valve coil.</p> <p>[S20] - White [S21] - Red [S22] - Blue [S23] - Yellow</p> 	<p>■ The number of the connectors are different according to the number of the connected indoor units.</p>
7	<p>Undo the wire clip.</p> 	

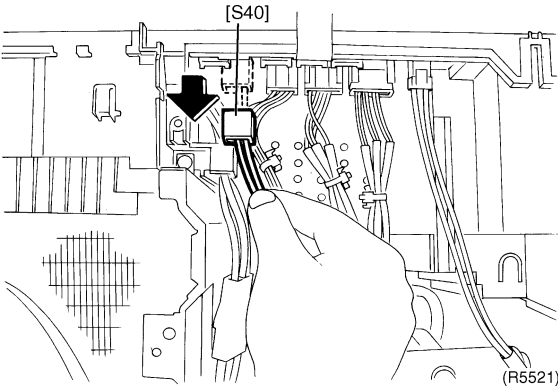
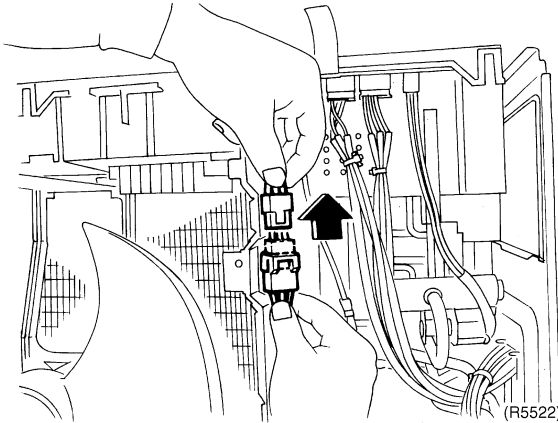
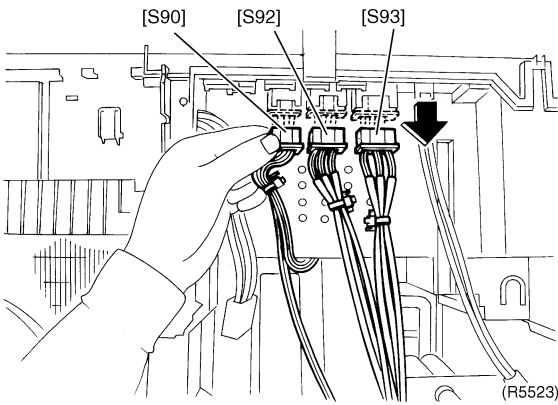
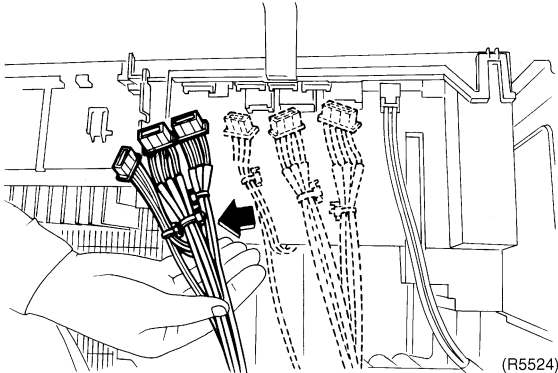
Step	Procedure	Points
8	Disconnect the connector for overload protector [S40].	
	 <p>(R5521)</p>	
9	Disconnect the connector for relay harness of compressor.	
	 <p>(R5522)</p>	
10	Disconnect the each connector. [S90] : Outdoor air, heat exchanger, discharge pipe thermistor [S92] : Gas pipe thermistor [S93] : Liquid pipe thermistor	
	 <p>(R5523)</p>	
	 <p>(R5524)</p>	

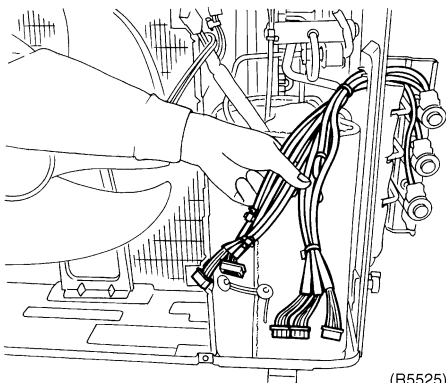
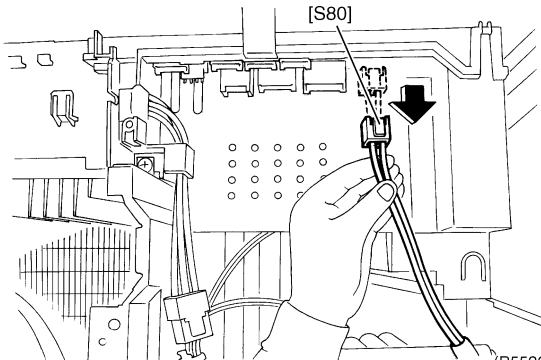
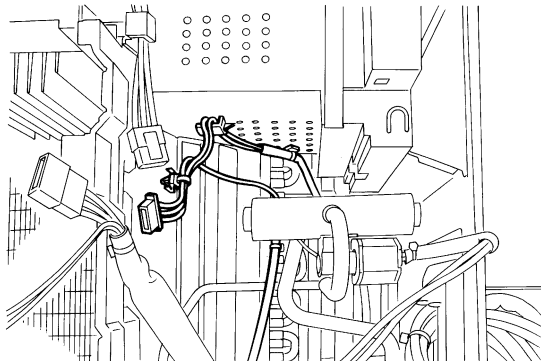
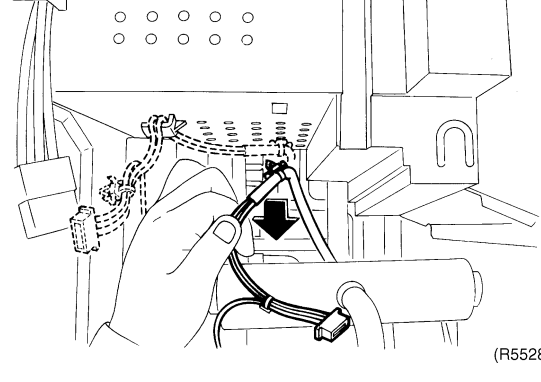
Step		Procedure	Points
11	Disconnect the connector for four way valve [S80].	 <p>(R5525)</p>  <p>(R5526)</p>	
12	The figure shows the arrangement of the wire harness under the electrical box.	 <p>(R5527)</p>	
13	Undo the wire clip for the thermistor lead wire.	 <p>(R5528)</p>	

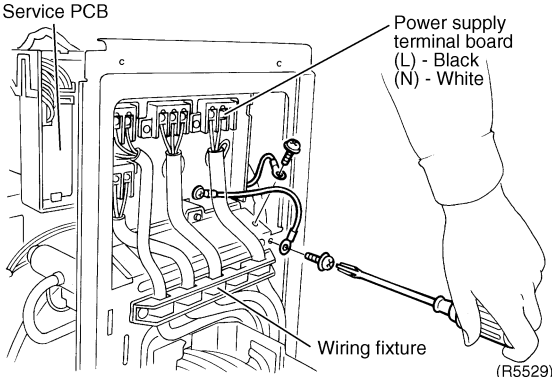
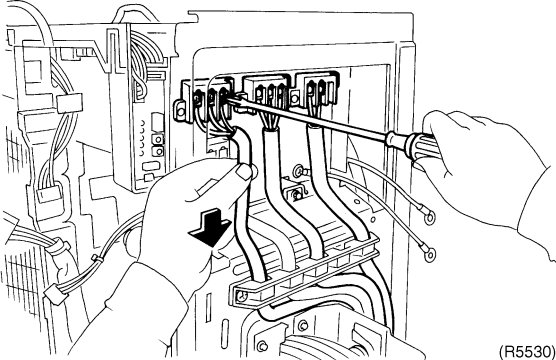
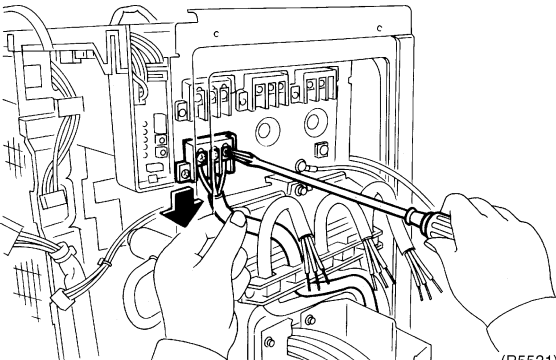
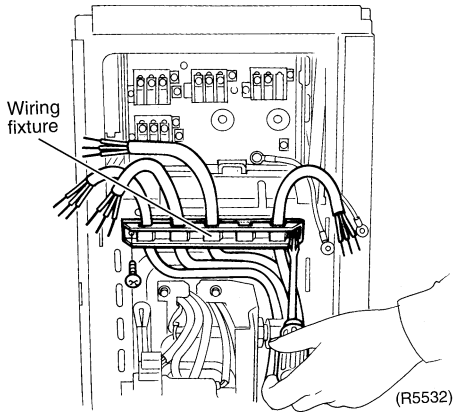
Step	Procedure	Points
<p>3. Remove the electrical box</p> <p>1 Loosen the 2 screws of the earth terminal.</p>	 <p>Service PCB</p> <p>Power supply terminal board (L) - Black (N) - White</p> <p>Wiring fixture</p> <p>(R5529)</p>	
<p>4. Disconnect the power supply connecting wires</p> <p>1 Loosen the screws on the terminal board and disconnect the wires of A, B, C, and D port.</p>	 <p>(R5530)</p>  <p>(R5531)</p>  <p>Wiring fixture</p> <p>(R5532)</p>	

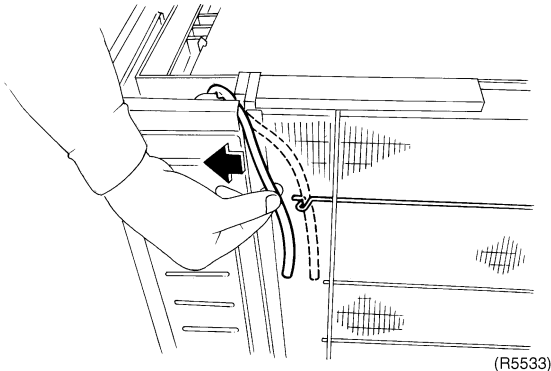
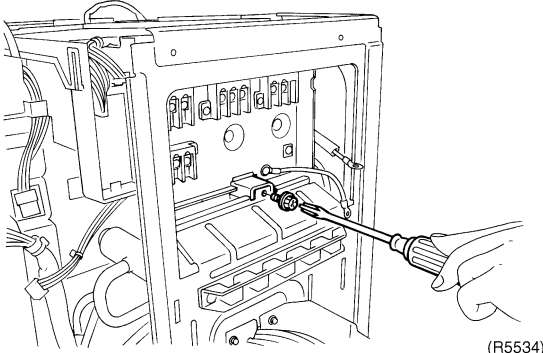
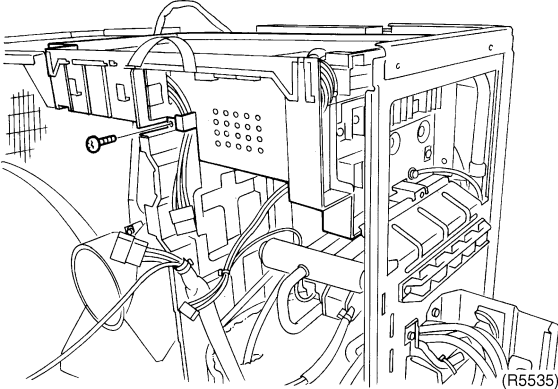
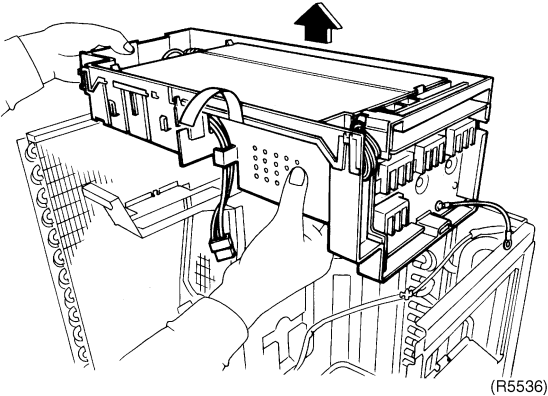
Step	Procedure	Points
2	Detach the outdoor air thermistor.	
	 <p>(R5533)</p>	
3	Loosen the screw on the right side of the electrical box.	
	 <p>(R5534)</p>	
4	Loosen the 1 screw in front of the electrical box.	
	 <p>(R5535)</p>	
5	Lift up the electrical box to remove.	
	 <p>(R5536)</p>	

1.3 Removal of the PCB

Procedure

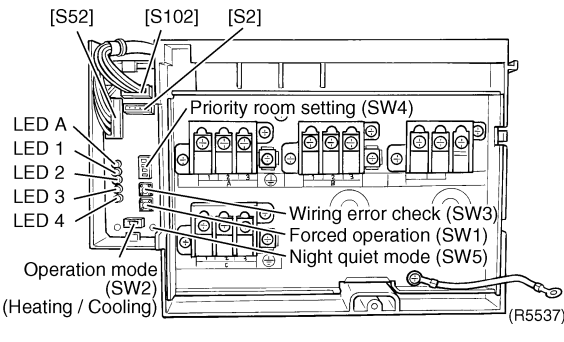
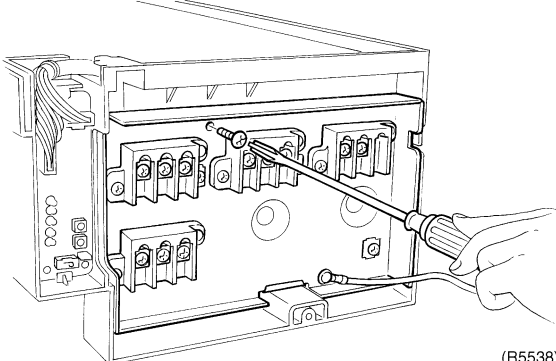
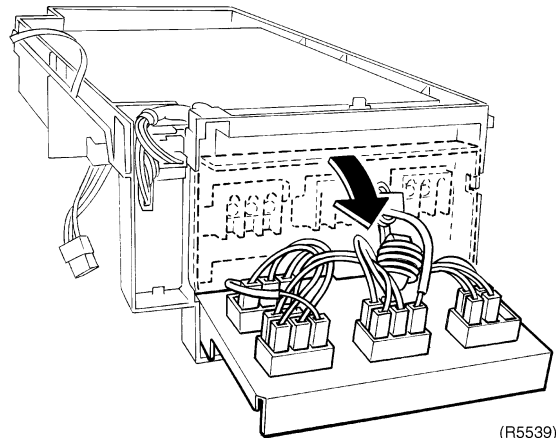
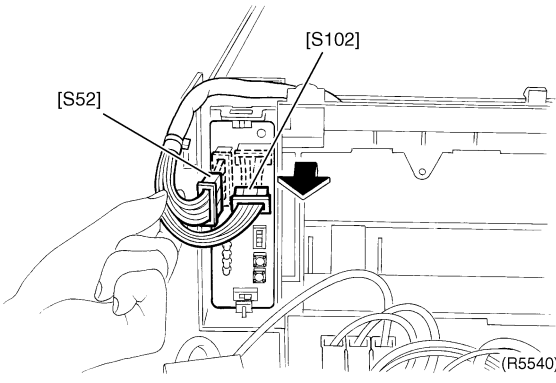

Warning Be sure to wait 10 minutes or more after turning off all power supplies before disassembling work.

Step	Procedure	Points
1.	Remove the service PCB	
1	<p>External appearance of the service PCB and the terminal board.</p> 	
2	<p>Loosen the 1 screw of the terminal board and open it.</p>  	
3	<p>Disconnect the connector [S52] and [S102] from the service PCB.</p> 	

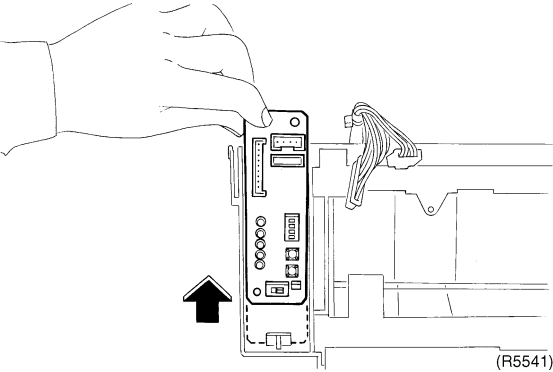
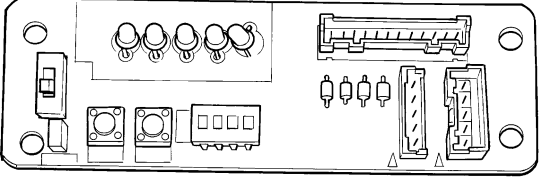
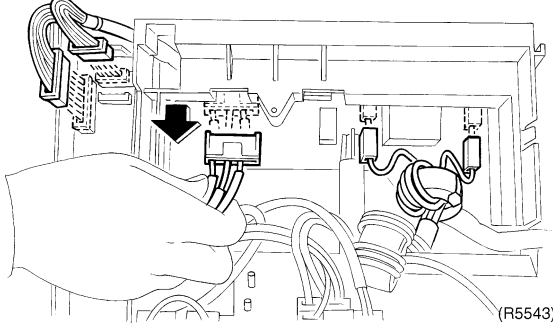
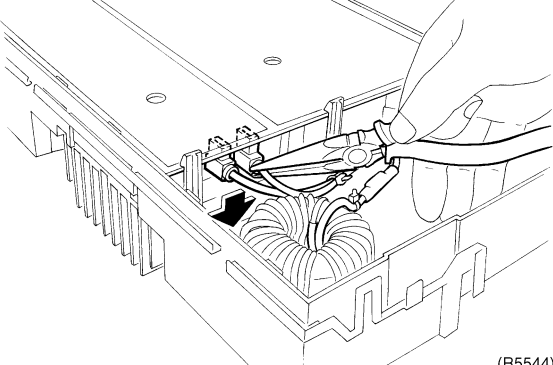
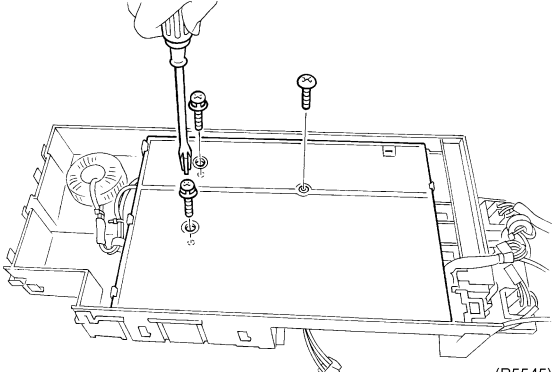
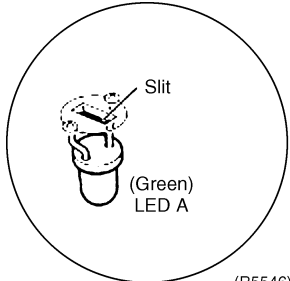
Step	Procedure	Points
4	<p>Widen the upper hook and pull the service PCB upward to remove.</p>  	
2. Remove the control PCB		
1	<p>Disconnect the each connectors on the terminal board.</p> 	
2	<p>Disconnect the 2 connectors for reactor.</p> 	
3	<p>Loosen the 3 screws of the PCB.</p> 	 <ul style="list-style-type: none"> ■ The PCB is down side up for improvement of quality. ■ Service monitor (LED A). ■ Check the LED through the slit.

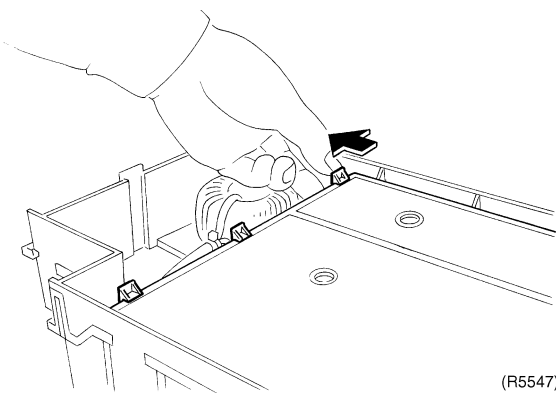
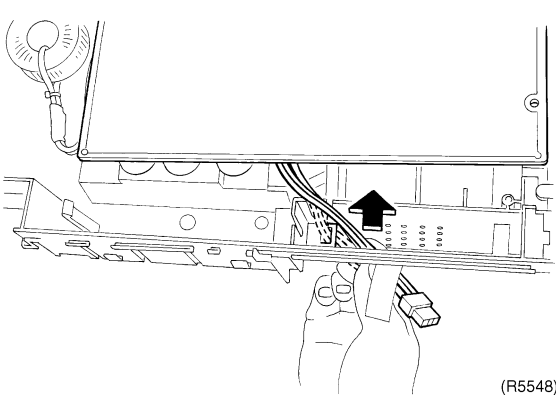
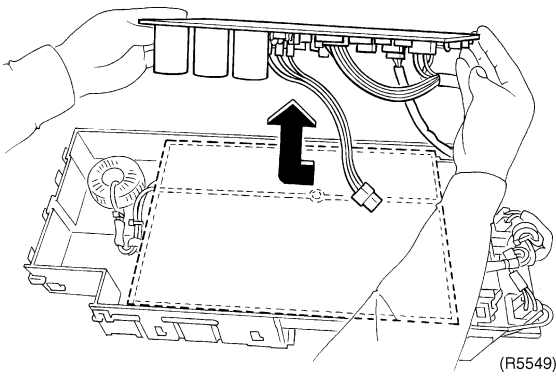
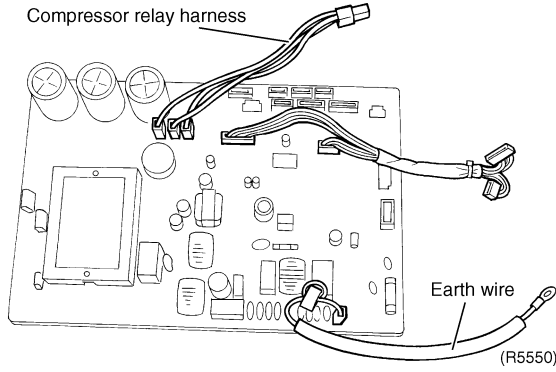
Step	Procedure	Procedure	Points
4	Undo the 3 hooks on the reactor side and slide the control PCB.	 <p>(R5547)</p>	
5	Undo the relay harness for compressor from the hook.	 <p>(R5548)</p>	
6	Lift up the control PCB to remove.	 <p>(R5549)</p>	<ul style="list-style-type: none"> ■ In working, be careful not to break the control PCB with the excessive force because the PCB and the radiation fin are adhered to one another. ■ When assembling, make sure to use the silicon material. ■ Silicon material Part No.: 1172698
7	Each wire harness.	 <p>Compressor relay harness</p> <p>Earth wire</p> <p>(R5550)</p>	

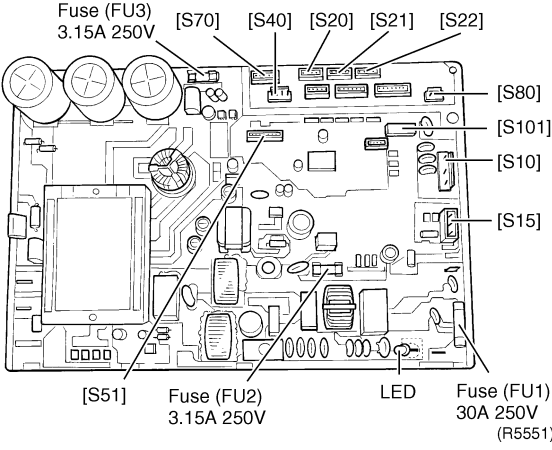
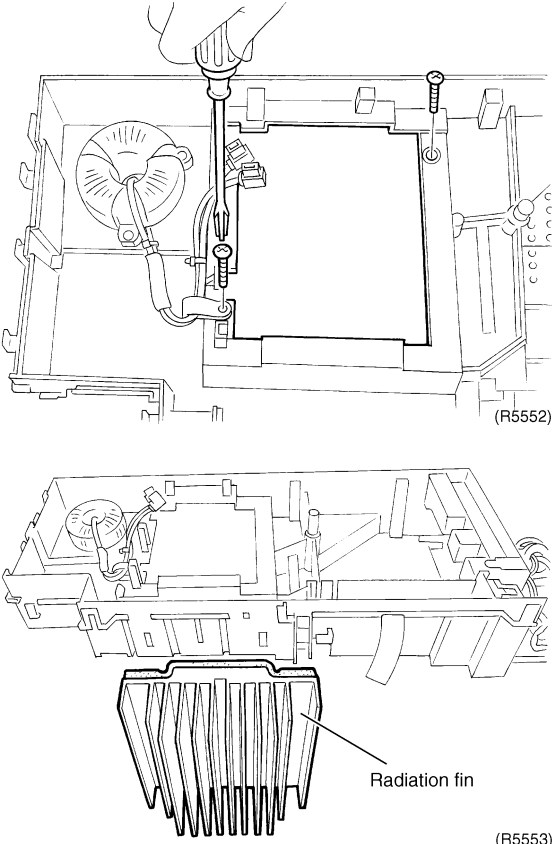
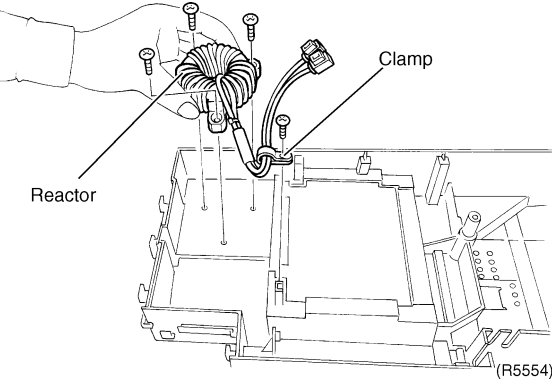
Step		Procedure	Points
8	Names of parts on the control PCB.		
9	Loosen the 2 screws of the radiation fin.		
10	Loosen the 3 screws of the reactor and the 1 screw of the clamp.		

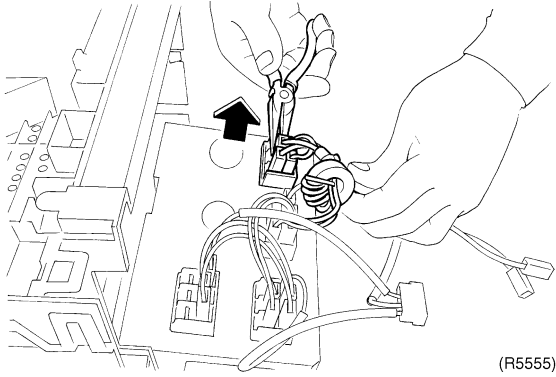
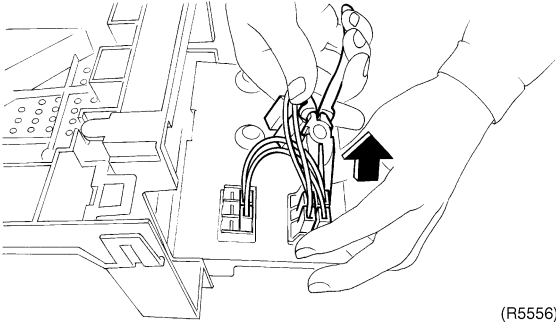
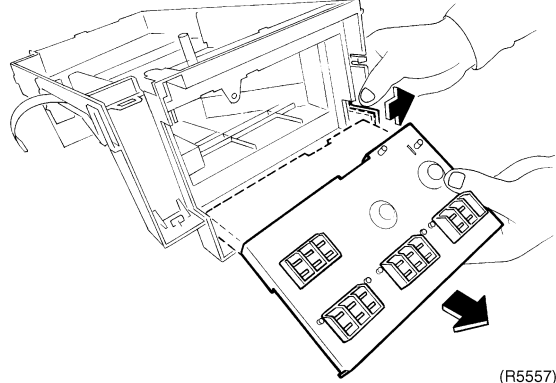
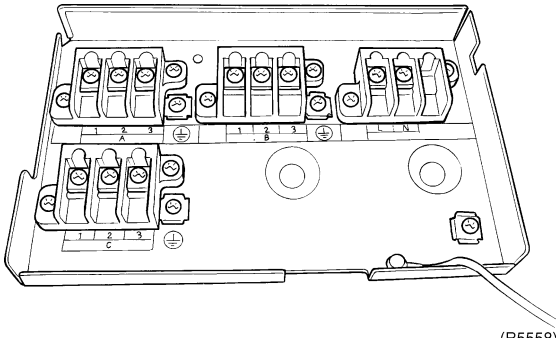
Step	Procedure	Points
<p>3. Disconnect the wire harnesses</p>	 <p>(R5555)</p>  <p>(R5556)</p>	
<p>4. Remove the terminal board</p>	<p>1 Open the electrical box and remove the terminal board.</p>  <p>(R5557)</p>  <p>(R5558)</p>	

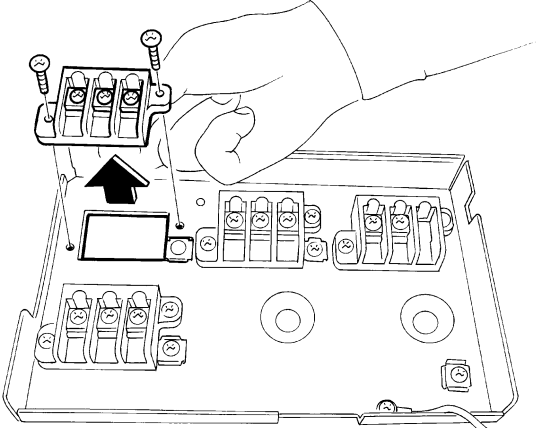
Step	Procedure	Points
2	<p data-bbox="199 219 464 309">Loosen the 2 screws of the terminal board to remove.</p>  <p data-bbox="1002 712 1061 734">(R5559)</p>	

1.4 Removal of the Propeller Fan / Fan Motor

Procedure



Warning Be sure to wait 10 minutes or more after turning off all power supplies before disassembling work.

Step	Procedure	Procedure	Points
1	Remove the fan motor fixing plate.	<p>(R5560)</p>	<ul style="list-style-type: none"> ■ Remove the outer panels and plates. ■ Remove the electrical box.
2	Take out the fan motor fixing plate toward yourself.	<p>(R5561)</p>	<p>(R5564)</p> <ul style="list-style-type: none"> ■ When assembling, fit the lower hooks.
3	Loosen the washer fitted nut to remove the propeller fan.	<p>(R5562)</p> <p>(R5563)</p>	<p>(R5565)</p> <ul style="list-style-type: none"> ■ When assembling, align ▼ mark of the propeller fan with D-cut section of the motor shaft. ■ When assembling, make sure ● mark of the fan motor goes up.

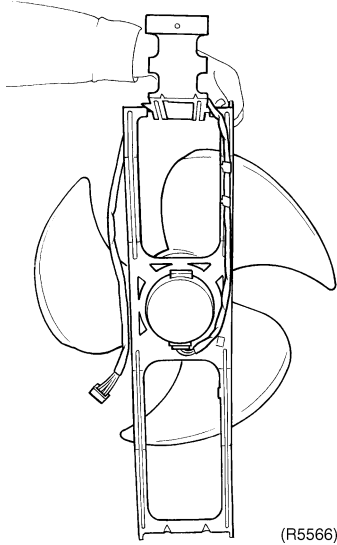
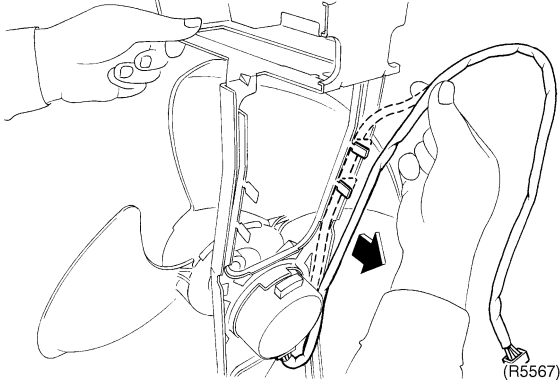
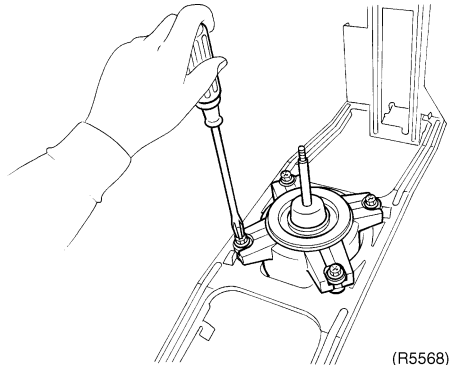
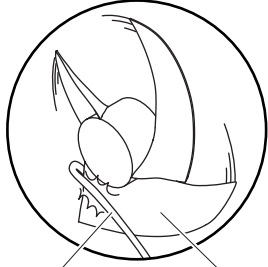
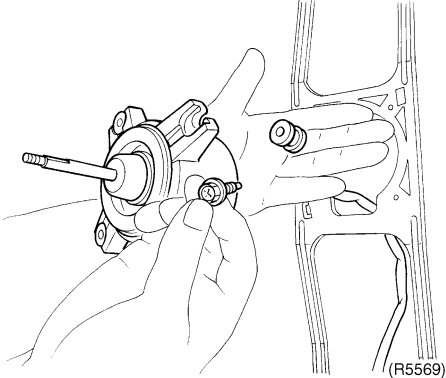
Step	Procedure	Points
<p>4</p>	<p>Undo the 2 fixing hooks of the lead wire. Loosen the 4 screws of the fan motor.</p>  <p>(R5566)</p>  <p>(R5567)</p>  <p>(R5568)</p>	 <p>Lead wire Propeller fan (R3249)</p> <ul style="list-style-type: none"> ■ When assembling, put the lead wire through the back of the motor. (so as not to be entangled with the propeller fan)
<p>5</p>	<p>Detach the 4 screws and 4 rubber vibration isolators.</p>  <p>(R5569)</p>	

1.5 Removal of the Sound Blanket

Procedure





Warning

Be sure to wait 10 minutes or more after turning off all power supplies before disassembling work.

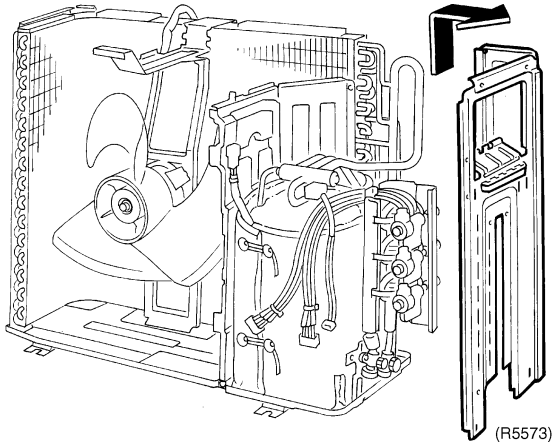
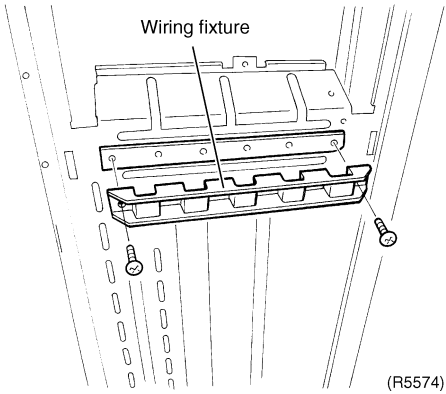
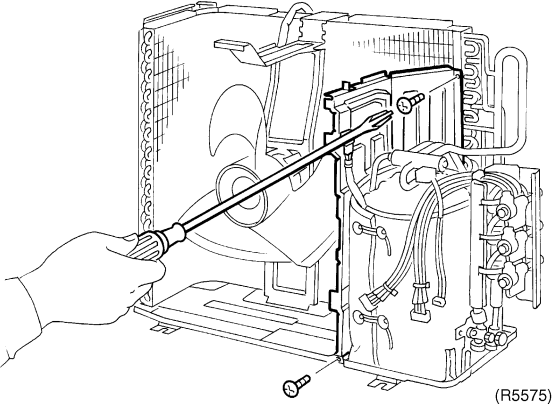
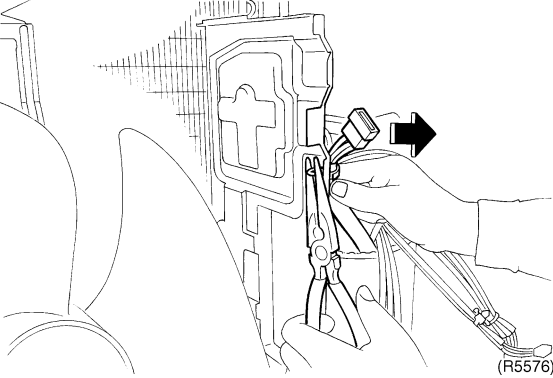
Step	Procedure	Points
1. Remove the right side panel	<p>(R5570)</p>	<ul style="list-style-type: none"> ■ Remove the outer panels and plates. ■ Remove the electrical box.
1 Loosen the 3 screws on the right of the right side panel.	<p>(R5571)</p>	
2 Loosen the 2 screws on the back.	<p>Packing</p> <p>(R5572)</p>	
3 Remove the packing. There is a hook on the back.		

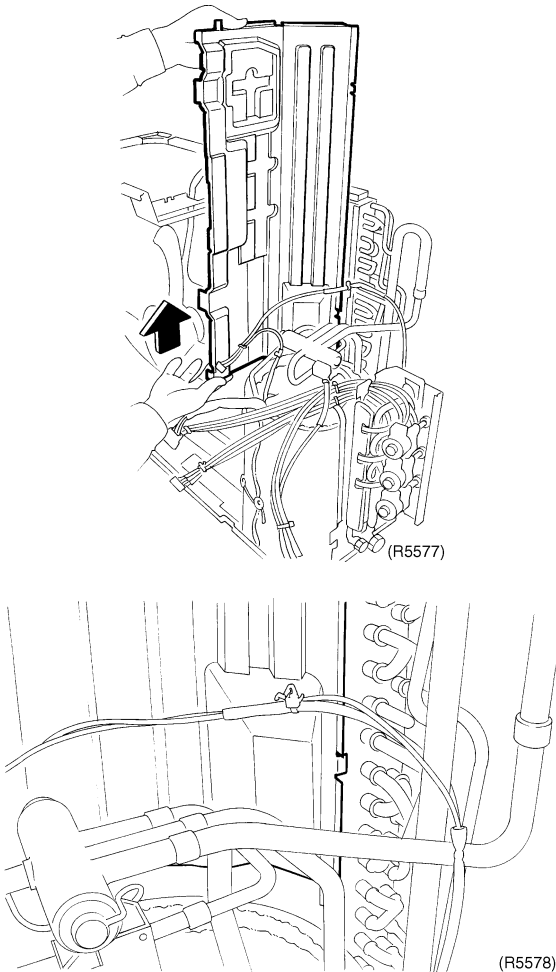
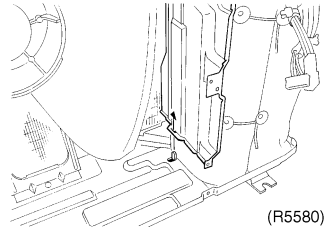
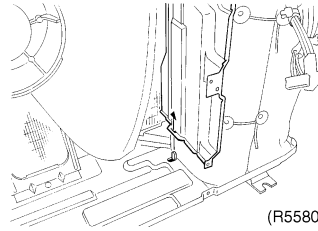
Step	Procedure	Points
<p>4</p>	<p>Pull up the right side panel.</p>  <p>(R5573)</p>	
<p>5</p>	<p>Loosen the 2 screws of the wiring fixture.</p>  <p>Wiring fixture</p> <p>(R5574)</p>	
<p>2. Remove the partition plate</p>		
<p>1</p>	<p>Loosen the 2 screws to remove the partition plate.</p>  <p>(R5575)</p>	
<p>2</p>	<p>Detach the clamp of the relay harness for the compressor.</p>  <p>(R5576)</p>	

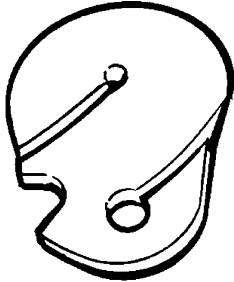
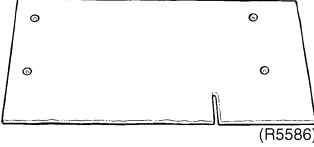
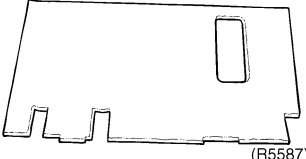
Step	Procedure	Procedure	Points
3	Pull up the partition plate.	 <p>(R5577)</p> <p>(R5578)</p>	 <p>(R5580)</p> <ul style="list-style-type: none"> ■ When assembling, make sure to catch the lower hook of the partition plate.
3.	Remove the sound blanket		
1	Lift up the sound blanket (top-upper) to remove.	 <p>(R5579)</p> <p>(R5581)</p>	<ul style="list-style-type: none"> ■ Since the piping ports on the sound blanket are torn easily, remove the blanket carefully.

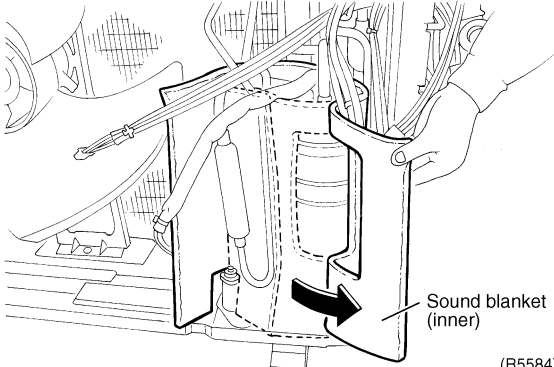
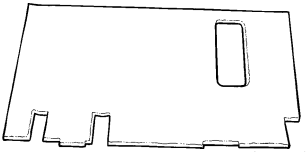
Step		Procedure	Points
2	Remove the sound blanket (top-lower).	 <p>(R5582)</p>	 <p>(R5585)</p>
3	Undo the fixing strings, open the sound blanket (body) and pull it out.	 <p>(R5583)</p>	 <p>(R5586)</p>
4	Open the sound blanket (inner) and pull it out.	 <p>Sound blanket (inner)</p> <p>(R5584)</p>	 <p>(R5587)</p>

1.6 Removal of Electronic Expansion Valve Coil, Four Way Valve Coil and Thermistor

Procedure



Warning

Be sure to wait 10 minutes or more after turning off all power supplies before disassembling work.

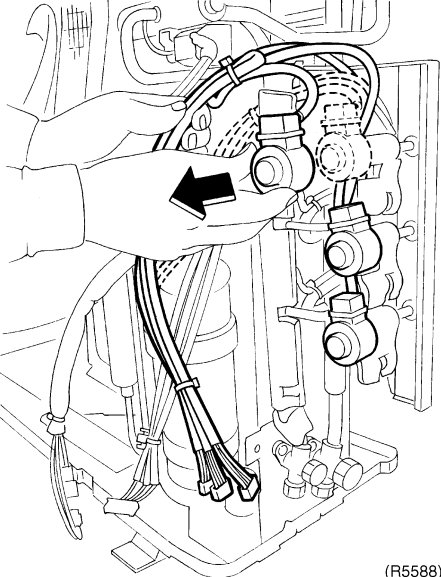
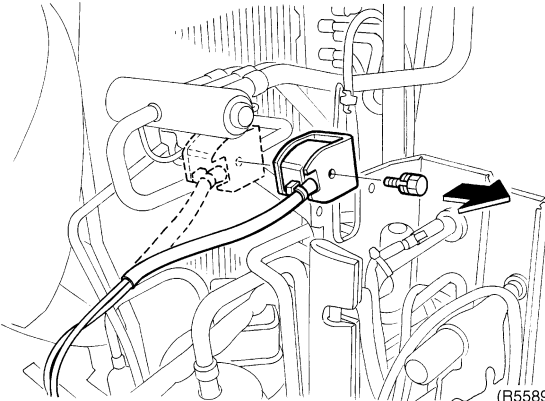
Step	Procedure	Points
1. Remove the electronic expansion valve coil	 <p style="text-align: right;">(R5588)</p>	
2. Remove the four way valve coil	 <p style="text-align: right;">(R5589)</p>	

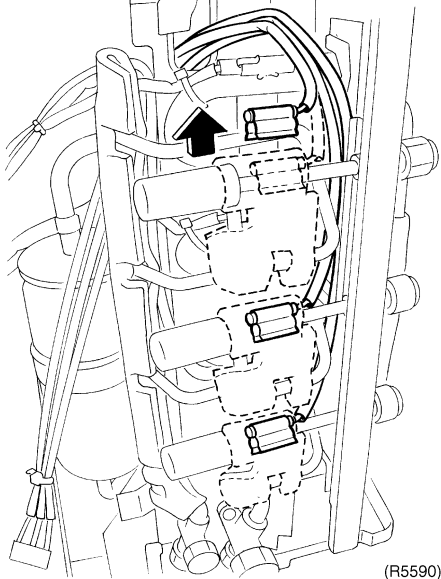
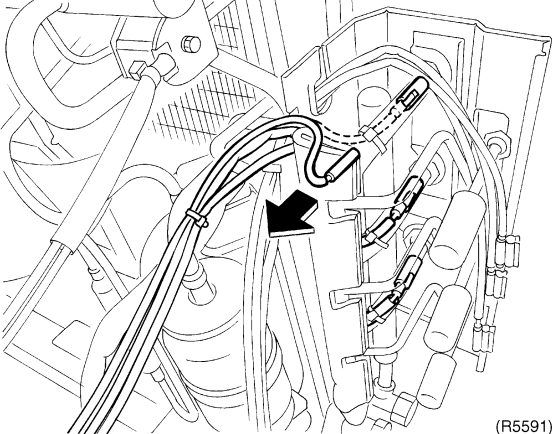
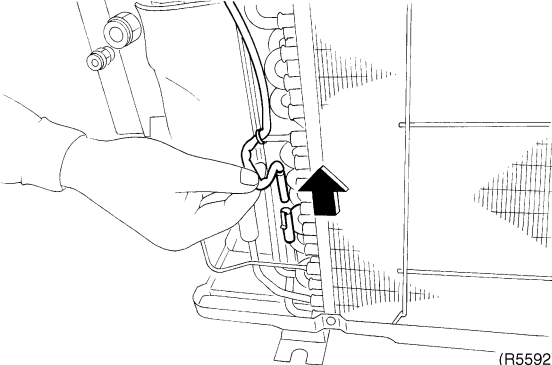
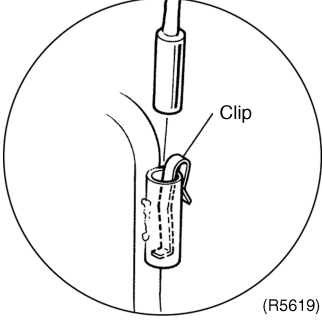
Step	Procedure	Points
<p>3. Remove the liquid/gas pipe thermistor</p> <p>1 Open the putty and remove the liquid pipe thermistor. [S90] : Outdoor air thermistor Heat exchanger thermistor Discharge pipe thermistor [S92] : Gas pipe thermistor Room A (Black) Room B (Gray) Room C (Brown) Room D (Red) [S93] : Liquid pipe thermistor Room A (Black) Room B (Gray) Room C (Yellow) Room D (Blue)</p> <p>2 Open the putty and remove the gas pipe thermistor.</p>	 <p>(R5590)</p>  <p>(R5591)</p>	<ul style="list-style-type: none"> ■ Meet the edge of the thermistor and clip. ■ The number of ports is different according to the models.
<p>4. Remove the heat exchanger thermistor</p> <p>1 Remove the heat exchanger thermistor.</p>	 <p>(R5592)</p>	 <p>(R5619)</p>

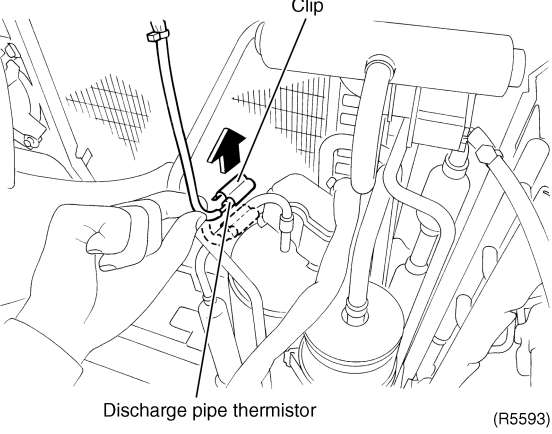
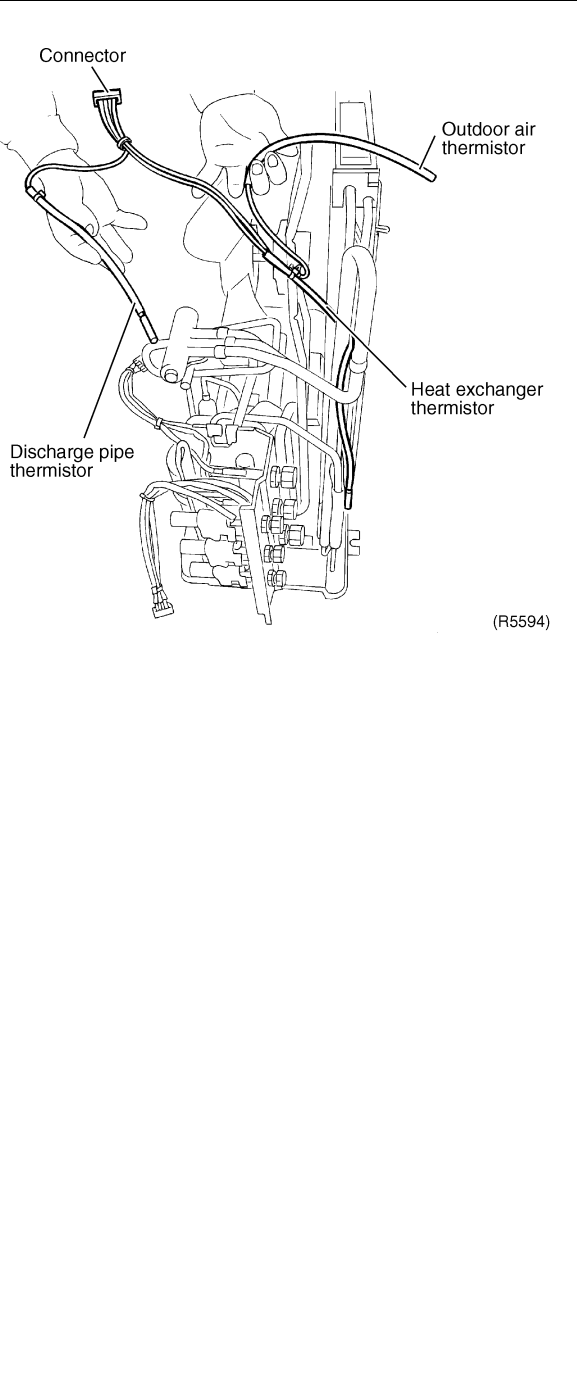



Step	Procedure	Points
<p>5. Remove the discharge pipe thermistor</p>	<p>1 Undo the clip and remove the discharge pipe thermistor.</p> 	<ul style="list-style-type: none"> ■ Meet the edge of the thermistor and clip. ■ Be careful not to loose the clip for the discharge pipe thermistor.
<p>6. Remove the assembly of thermistor.</p>	<p>1 The figure shows the arrangement of the assembly of thermistor.</p> 	

1.7 Removal of the Distributor

Procedure

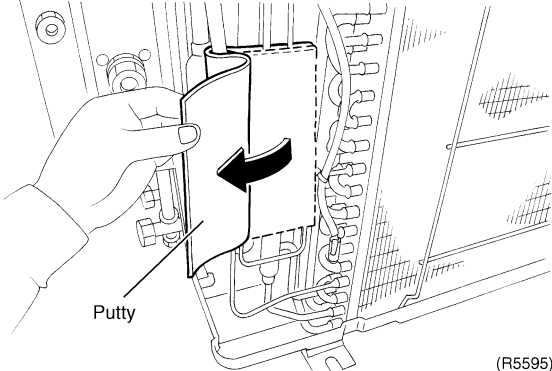
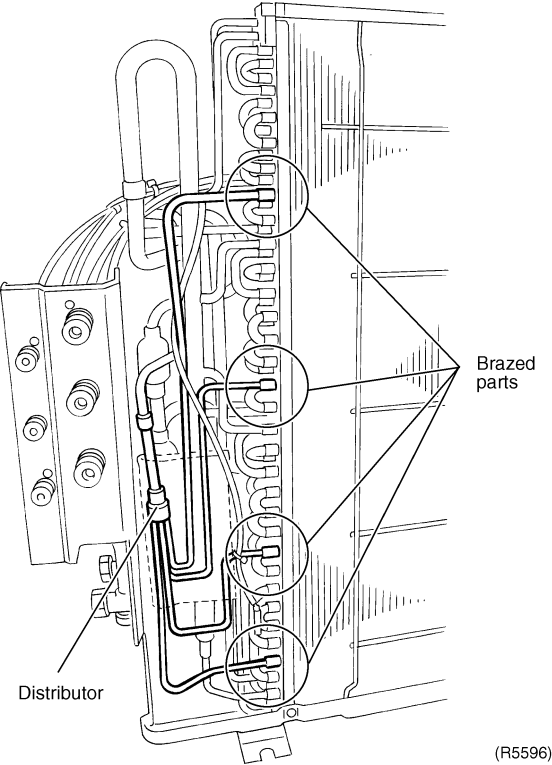

Warning Be sure to wait 10 minutes or more after turning off all power supplies before disassembling work.

Step	Procedure	Procedure	Points
1	Remove the putty.	 <p>(R5595)</p>  <p>(R5596)</p>	<p> Warning Ventilate when refrigerant leaks during the work. (If refrigerant contacts fire, it will cause to arise toxic gas.)</p> <p> Caution Be careful not to get yourself burnt with the pipes and other parts that are heated by the gas welding rod.</p> <p> Caution From the viewpoint of global environment protection, do not discharge the refrigerant gas in the atmosphere. Make sure to recover the refrigerant gas with the recovery system.</p>

1.8 Removal of the Four Way Valve

Procedure

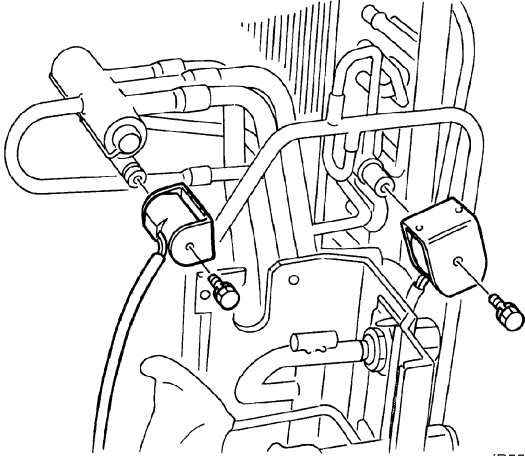
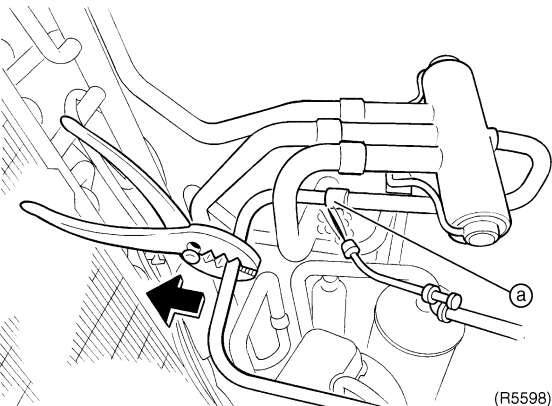
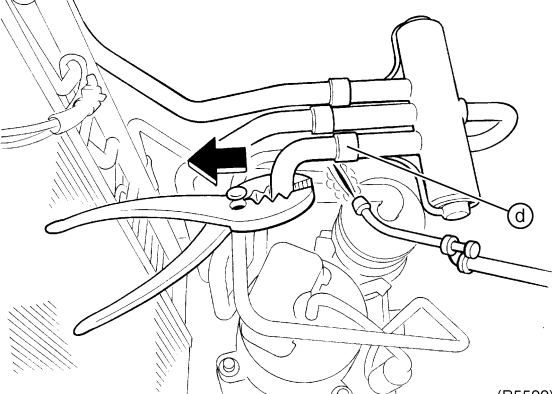
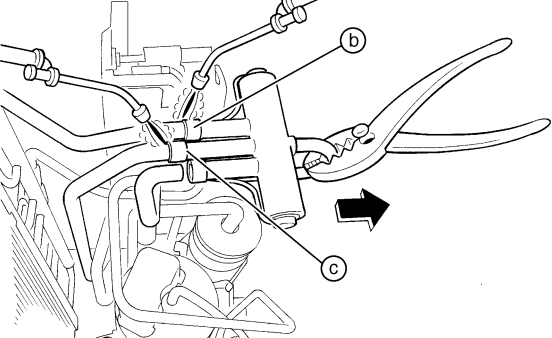

Warning Be sure to wait 10 minutes or more after turning off all power supplies before disassembling work.

Step	Procedure	Points
<p>■ Be sure to apply nitrogen replacement when heating up the brazed part.</p>	 <p style="text-align: right;">(R5597)</p>	<p>Cautions for restoration</p> <ol style="list-style-type: none"> 1. Restore the piping by non-oxidation brazing. In case of you cannot use the nitrogen gas, restore as quickly as possible. 2. It is required to prevent the carbonization of the oil inside the four way valve and the deterioration of the gaskets affected by heat. For the sake of this, wrap the four way valve with wet cloth and provide water so that the cloth will not be dried and avoid excessive heating. (Keep below 120°C)
<p>1 Loosen the 1 screw to remove the four way valve coil.</p> <p>2 Heat up the 4 brazed part of the four way valve. First, disconnect the part "a".</p> <p>■ Provide a protective sheet or a steel plate so that the brazing flame cannot influence peripheries.</p>	 <p style="text-align: right;">(R5598)</p>	<p>■ Be careful so as not to break the pipes by pressing it excessively by pliers when withdrawing it.</p> <p>In case of the difficulty with gas brazing machine</p> <ol style="list-style-type: none"> 1. Disconnect the brazed part where is easy to disconnect and restore. 2. Cut pipes on the main unit by a miniature copper tube cutter in order to make it easy to disconnect.
<p>3 Disconnect the part "d".</p>	 <p style="text-align: right;">(R5599)</p>	<p>i Note: Do not use a metal saw for cutting pipes by all means because the sawdust come into the circuit.</p>
<p>4 Disconnect the part "b" and "c".</p>	 <p style="text-align: right;">(R5600)</p>	



1.9 Removal of the Compressor

Procedure

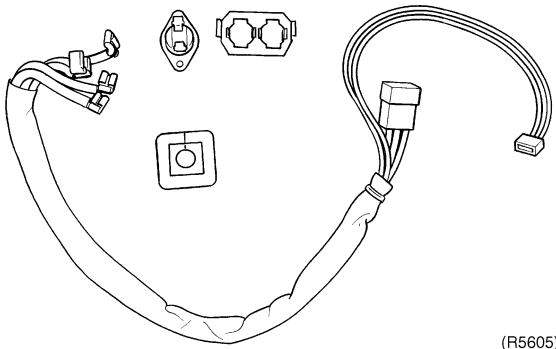

Warning Be sure to wait 10 minutes or more after turning off all power supplies before disassembling work.

Step	Procedure	Points
1. Remove the terminal cover	<p>(R5601)</p>	<p>Make a note.</p> <ul style="list-style-type: none"> ■ Be careful so as not to burn the compressor terminals or the name plate. <p>Warning Since it may happen that refrigeration oil in the compressor will catch fire, prepare wet cloth so as to extinguish fire immediately.</p>
2 Disconnect the flag-shaped terminals. 3 Detach the compressor lead wire.	<p>(R5602)</p>	<p>Warning Ventilate when refrigerant leaks during the work. (If refrigerant contacts fire, it will cause to arise toxic gas.)</p>
4 Detach the overload protector.	<p>(R5603)</p> <p>(R5604)</p>	<p>Caution Be careful not to get yourself burnt with the pipes and other parts that are heated by the gas welding rod.</p>

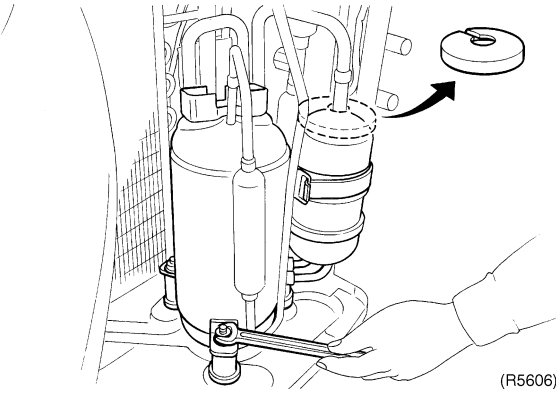
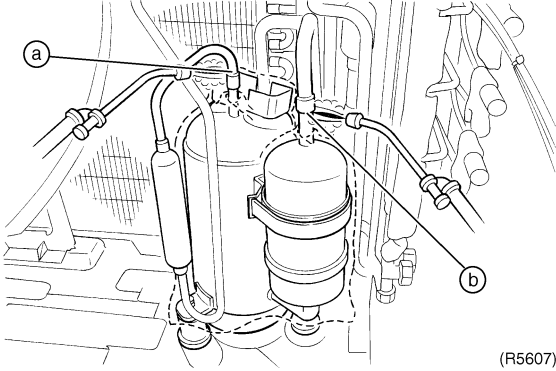
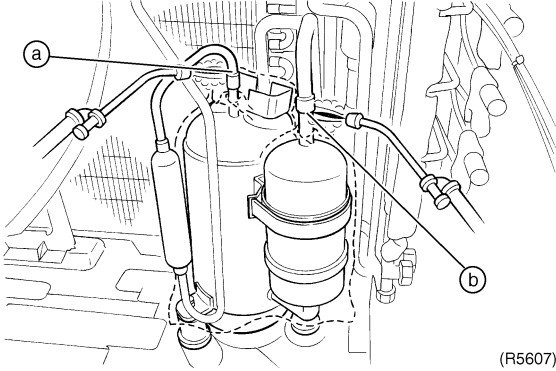
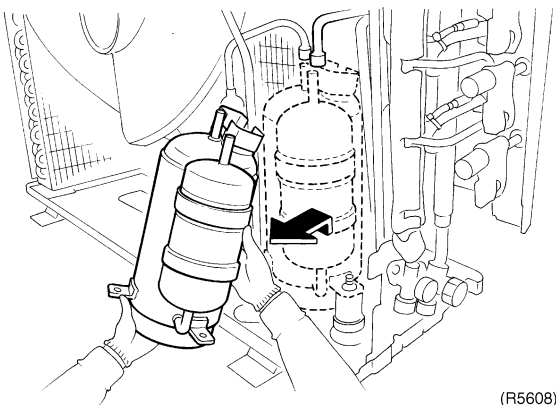
Step		Procedure	Points
5	Remove the 2 sheets of putty.	 <p style="text-align: right;">(R5605)</p>	<p>Warning  Ventilate when refrigerant leaks during the work. (If refrigerant contacts fire, it will cause to arise toxic gas.)</p>
6	There is one nut fixing the compressor. Remove the nut with an open-end spanner.	 <p style="text-align: right;">(R5606)</p>	
■	Before working, make sure that the refrigerant is empty in the circuit.		
■	Be sure to apply nitrogen replacement when heating up the brazed part.		
7	Heat up the brazed part of the discharge side and disconnect (part "a").	 <p style="text-align: right;">(R5607)</p>	
8	Heat up the brazed part of the suction side and disconnect (part "b").	 <p style="text-align: right;">(R5607)</p>	
9	Lift the compressor up to remove.	 <p style="text-align: right;">(R5608)</p>	

Part 8 Others

1. Others	316
1.1 Test Run from the Remote Controller	316
1.2 Jumper Settings	317
1.3 Application of Silicon Grease to a Power Transistor and a Diode Bridge.....	319

1. Others

1.1 Test Run from the Remote Controller

For Heat pump

In cooling mode, select the lowest programmable temperature; in heating mode, select the highest programmable temperature.

- Trial operation may be disabled in either mode depending on the room temperature.
- After trial operation is complete, set the temperature to a normal level.
(26°C to 28°C in cooling mode, 20°C to 24°C in heating mode)
- For protection, the system disables restart operation for 3 minutes after it is turned off.

For Cooling Only

Select the lowest programmable temperature.

- Trial operation in cooling mode may be disabled depending on the room temperature. Use the remote control for trial operation as described below.
- After trial operation is complete, set the temperature to a normal level (26°C to 28°C).
- For protection, the machine disables restart operation for 3 minutes after it is turned off.

Trial Operation and Testing

1. Measure the supply voltage and make sure that it falls in the specified range.
 2. Trial operation should be carried out in either cooling or heating mode.
 3. Carry out the test operation in accordance with the Operation Manual to ensure that all functions and parts, such as louver movement, are working properly.
- The air conditioner requires a small amount of power in its standby mode. If the system is not to be used for some time after installation, shut off the circuit breaker to eliminate unnecessary power consumption.
 - If the circuit breaker trips to shut off the power to the air conditioner, the system will restore the original operation mode when the circuit breaker is opened again.

Trial operation from Remote Controller

- (1) Press ON/OFF button to turn on the system.
- (2) Simultaneously press center of TEMP button and MODE buttons.
- (3) Press MODE button twice.
("T" will appear on the display to indicate that Trial Operation mode is selected.)
- (4) Trial run mode terminates in approx. 30 minutes and switches into normal mode. To quit a trial operation, press ON/OFF button.

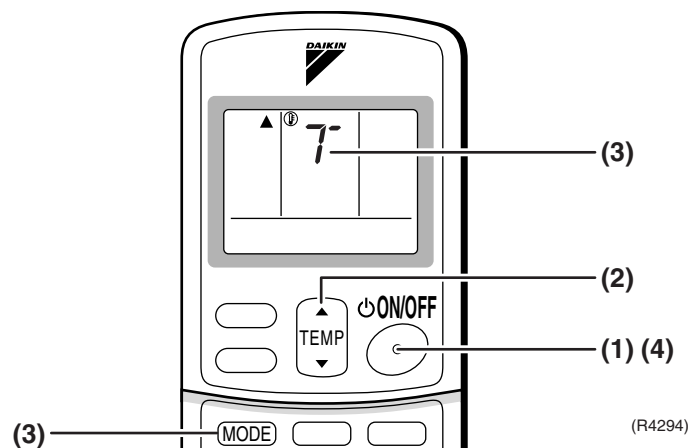

1.2 Jumper Settings

1.2.1 When Two Units are Installed in One Room

When two indoor units are installed in one room, the two wireless remote controllers can be set for different addresses.

How to set the different addresses

- Control PCB of the indoor unit
 - (1) Remove the electrical box.
 - (2) Cut the address jumper **JA** on the control PCB.

- Wireless remote controller
 - (1) Slide the front cover and take it off.
 - (2) Cut the address jumper **J4**.

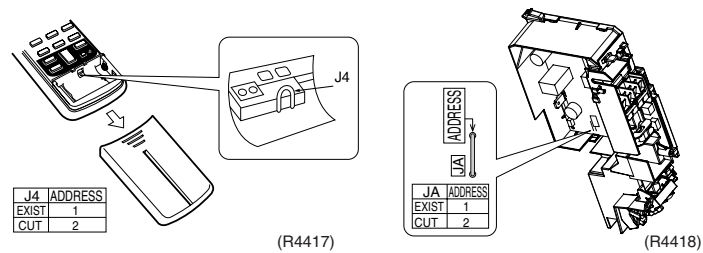

1.2.2 Jumper Setting

Jumper (On indoor PCB)	Function	When connected (factory set)	When cut
JC	Power failure recovery function	Auto start	Unit does not resume operation after recovering from a power failure. Timer ON-OFF settings are cleared.
JB	Fan speed setting when compressor is OFF on thermostat. (effective only at cooling operation)	Fan speed setting ; Remote controller setting	Fan rpm is set to "0" <Fan stop>

1.2.3 Adjusting the Angle of the INTELLIGENT EYE Sensor

FTK(X)S20-35C

- Once installation of the indoor unit is complete, adjust the angle of the INTELLIGENT EYE sensor to ensure the detection area properly covers the room.
(Adjustable angle : 15° to right and left of center)

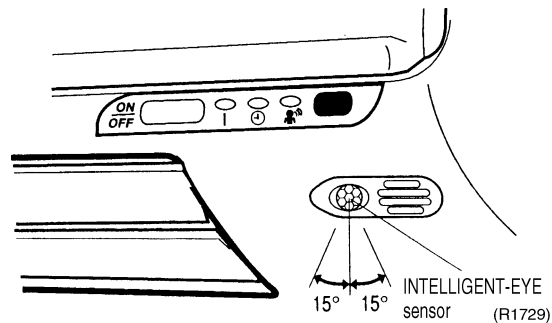

- Gently push and slide the sensor to adjust the angle. Aim so that the sensor is pointing to the center of the room, or to the part of the room that is most frequently used.

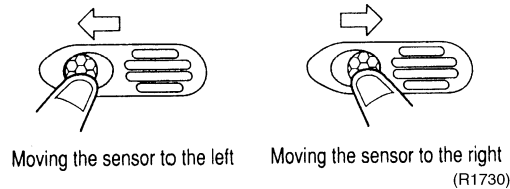

- After adjusting the angle, gently wipe the sensor with a clean cloth, being careful not to scratch the sensor.



Caution

- Do not hit or violently push the INTELLIGENT EYE sensor. This can lead to damage and malfunction.
- Do not place large objects near the sensor. Also keep heating units or humidifiers outside the sensor's detection area.

1.3 Application of Silicon Grease to a Power Transistor and a Diode Bridge

Applicable Models

All outdoor units using inverter type compressor for room air conditioner.

When the printed circuit board of an outdoor unit is replaced, it is required that silicon grease (*1) is certainly applied to the heat radiation part (the contact point to the heat radiation fin) of the power transistor and diode bridge.

*1: Parts number of the silicon grease – 1172698 (Drawing number 3FB03758-1)

Details

The silicon grease is an essential article for encouraging the heat radiation of the power transistor and the diode bridge. Applying the paste should be implemented in accordance with the following instruction.

Remark: There is the possibility of failure with smoke in case of bad heat radiation.

- To completely wipe off the old silicon grease on a heat radiation fin.
- To evenly apply the silicon grease to the whole.
- Do not have any foreign object such as solder or paper waste between the power transistor, the diode bridge and the heat radiation fin.
- To firmly tighten the screws of the power transistor and the diode bridge, and to surely contact to the heat radiation fin without any gap.

<Example>

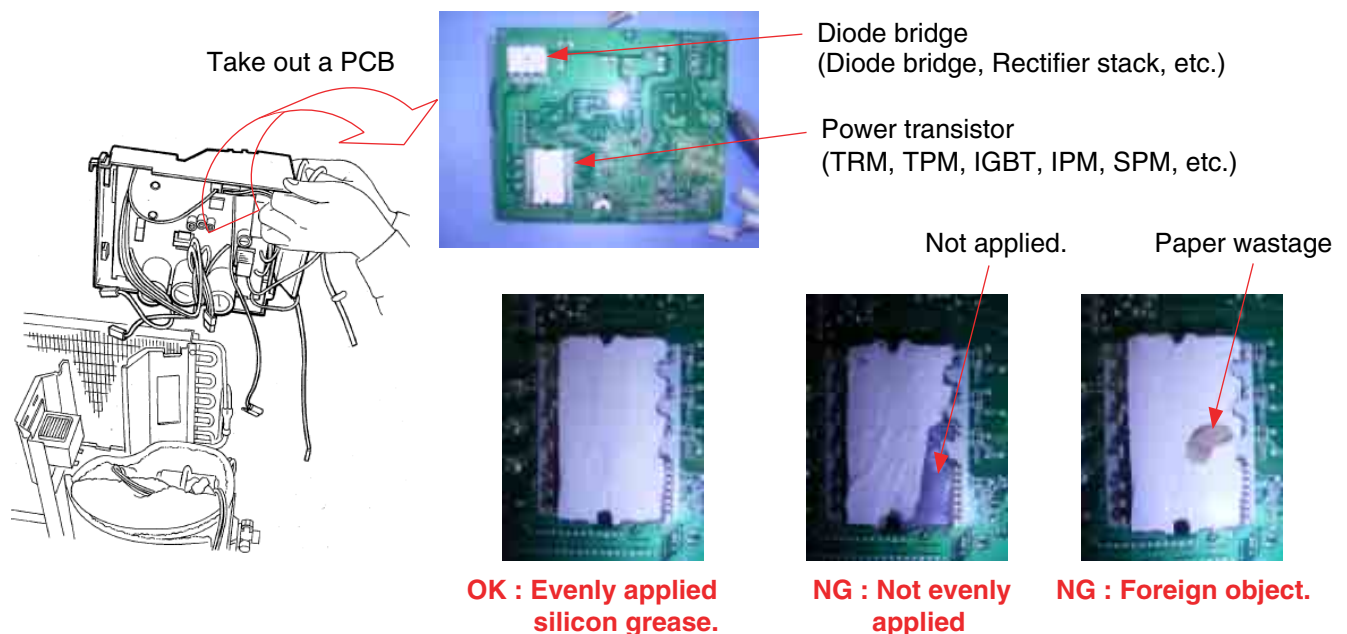

(R7100)

Part 9 Appendix

1. Piping Diagrams.....	322
1.1 Indoor Units.....	322
1.2 Outdoor Units.....	328
2. Wiring Diagrams.....	330
2.1 Indoor Units.....	330
2.2 Outdoor Units.....	335

1. Piping Diagrams

1.1 Indoor Units

1.1.1 Wall Mounted Type

FTKS20D3VMW(L), FTKS25D3VMW(L), FTKS35D3VMW(L)

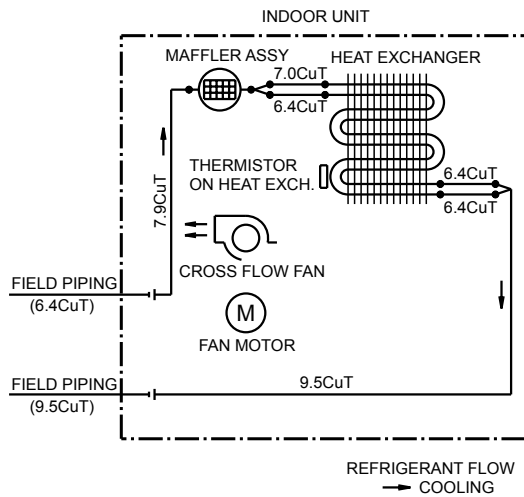

4D050757A

FTKS50D2V1W(L)

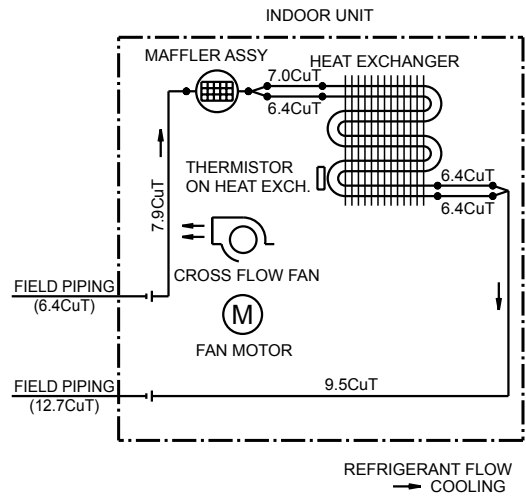

4D051577

FTKS20CAVMB, FTKS25CAVMB, FTKS35CAVMB

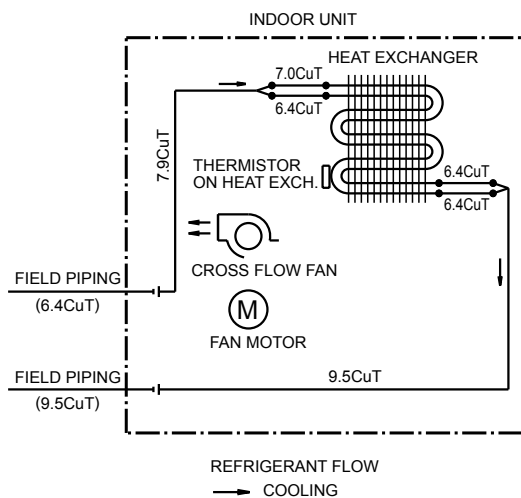

4D033698E

FTKS50FV1B

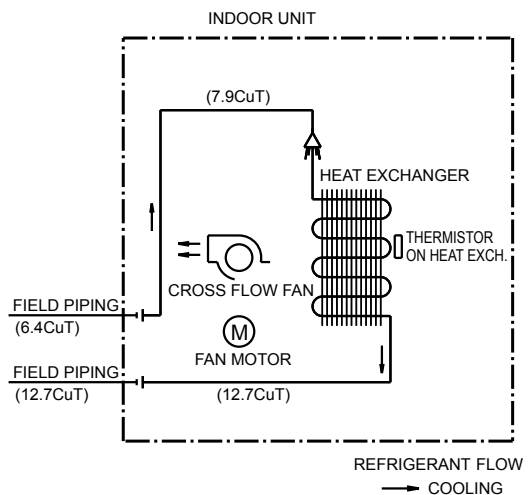

4D054932A

FTXG25EV1BW(S), FTXG35EV1BW(S)

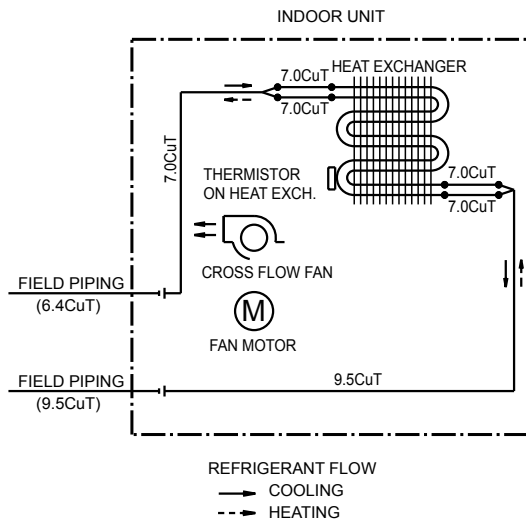

4D045301B

CTXG50EV1BW(S)

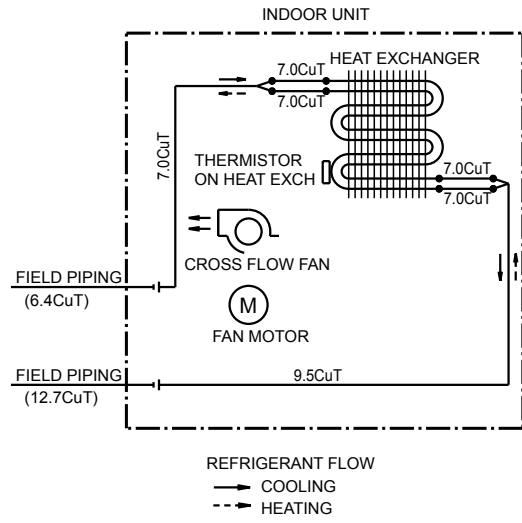

4D050924

FTXS20D3VMW(L), FTXS25D3VMW(L), FTXS35D3VMW(L)

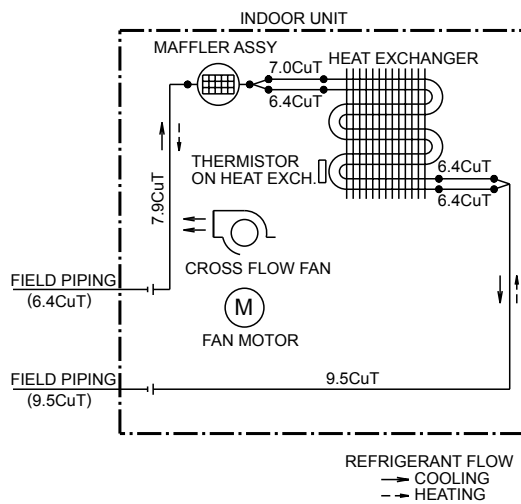

4D047912F

FTXS50D2V1W(L)

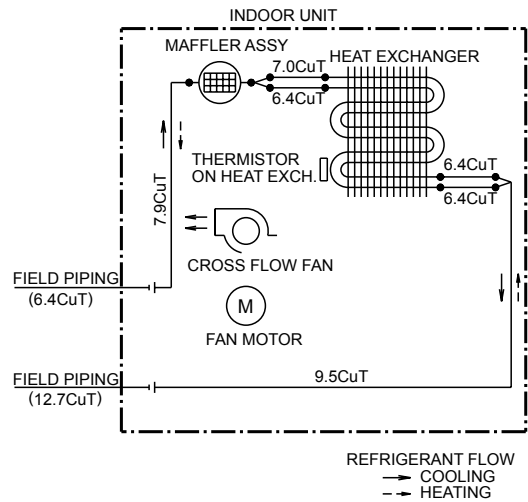

4D047913D

FTXS20CAVMB, FTXS25CAVMB,
FTXS35CAVMB

FTXS50FV1B

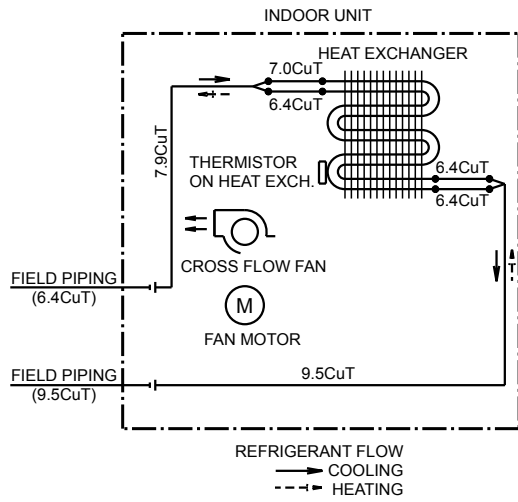

4D049319A

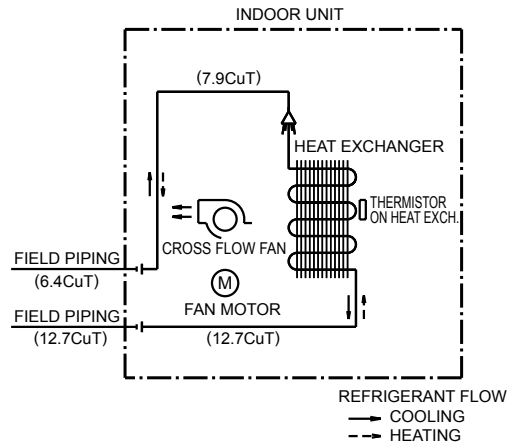

4D040081Q

1.1.2 Duct Connected Type

FDKS25CAVMB, FDKS35CAVMB, FDKS50CVMB, FDKS25EAVMB, FDKS35EAVMB
 FDXS25CAVMB, FDXS35CAVMB, FDXS50CVMB, FDXS25EAVMB, FDXS35EAVMB

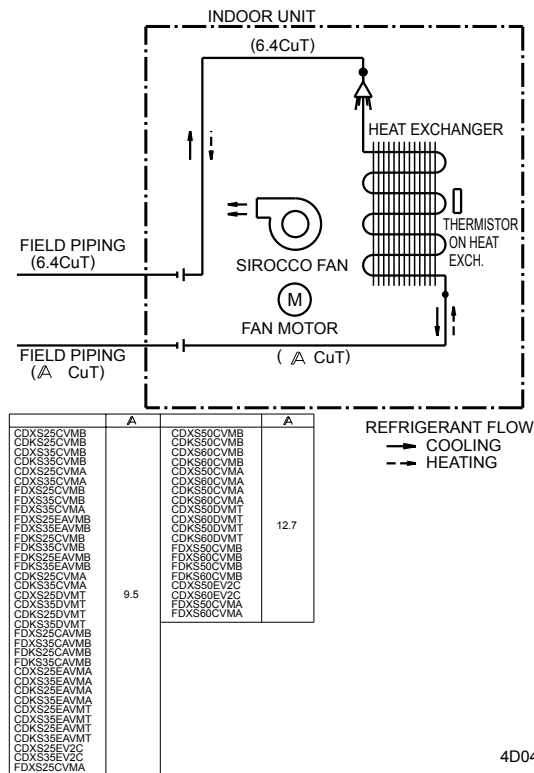

4D045449J

1.1.3 Floor / Ceiling Suspended Dual Type

FLKS25BAVMB, FLKS35BAVMB

FLKS50BAVMB

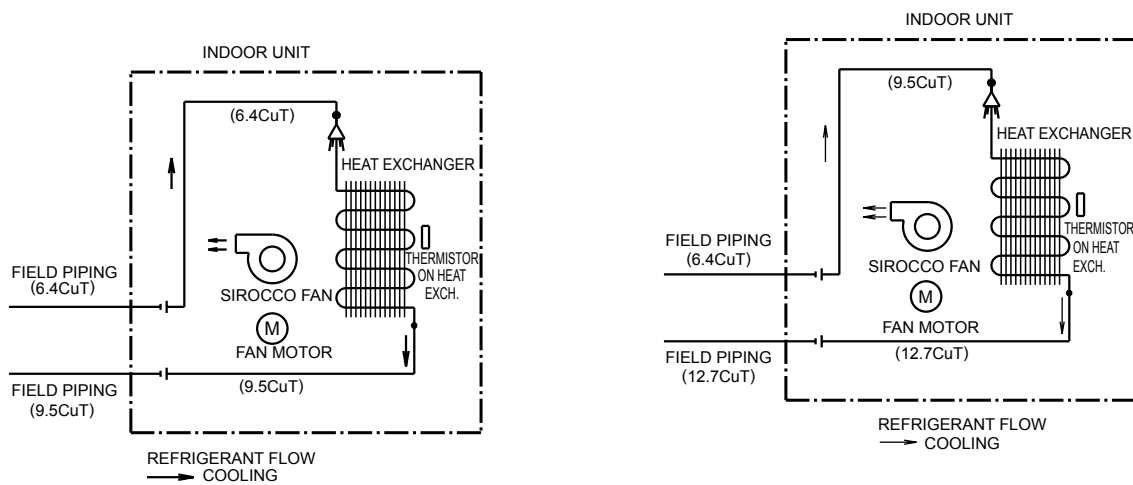

4D034012E

4D048723A

FLXS25BAVMB, FLXS35BAVMB

FLXS50BAVMB

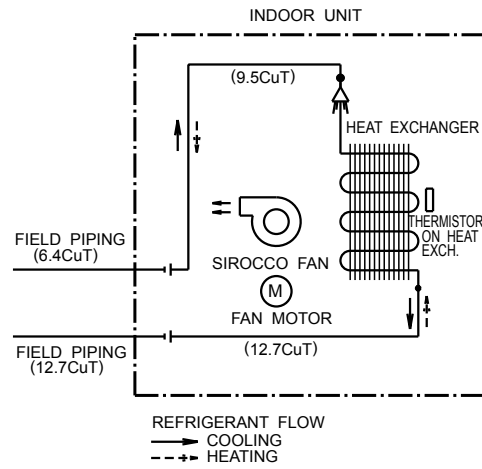
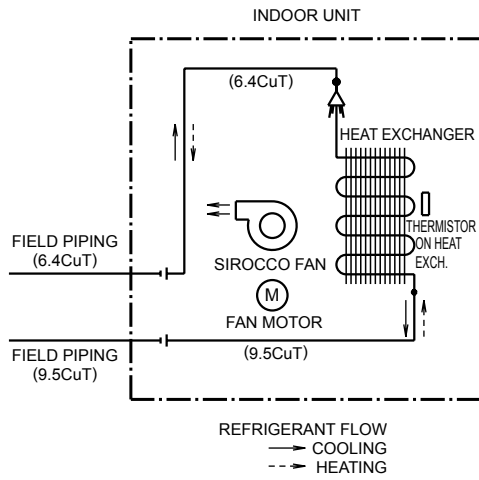

4D048722A

4D048724A

1.1.4 Floor Standing Type

FVXS25FV1B, FVXS35FV1B

FVXS50FV1B

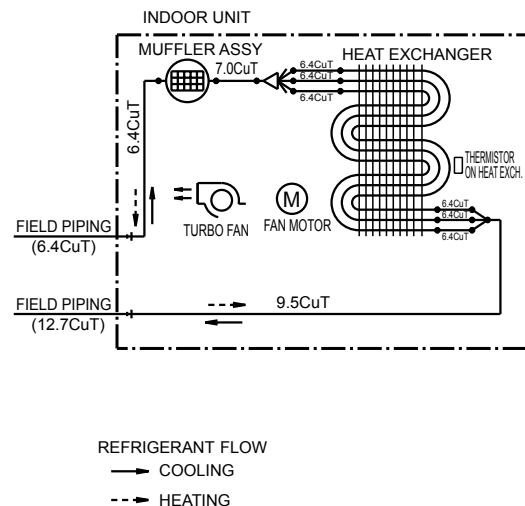
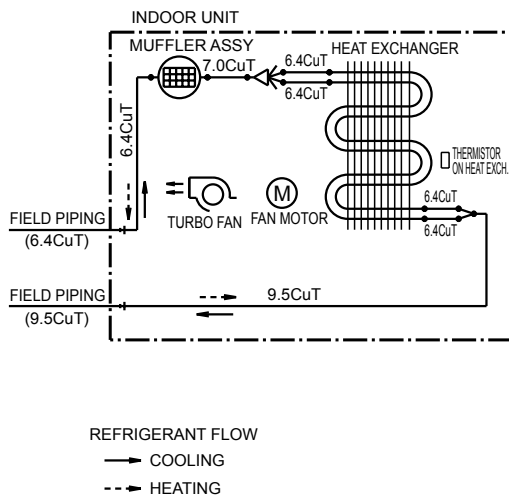

4D056137

4D056138

1.1.5 Ceiling Suspended Type

FHQ35/50BVV1B

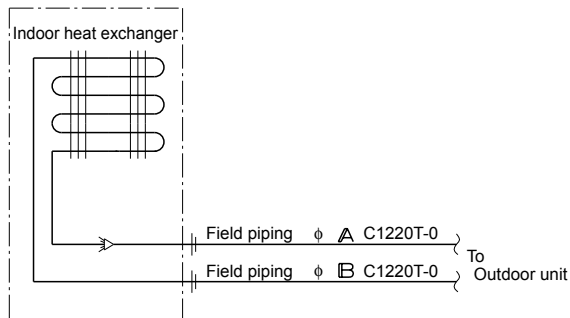

Indoor unit

MODEL	A	B
FHQ35BUBV1B FHQ35BVV1B FCQ35BVE FCQ35C7VEB	6.4	9.5
FHQ50, 60BUBV1B FHQ50, 60BVV1B FCQ50, 60BVE FBQ80BV1 FBQ80BVL FCQ50, 60C7VEB	6.4	12.7
FUQ71, 100, 125BUBV1B FUQ71, 100, 125BVV1B FHQ71, 100, 125BUBV1B FHQ71, 100, 125BVV1B FAQ71, 100BUBV1B FAQ71, 100BVV1B FXUQ70, 100, 125MV1 FHQ71, 100, 125BAV3B FCQ71, 100, 125, 140DV3B FCQ71, 100, 125, 140DAV3B FCQ71BVE FBQ71BV1 FBQ71BVL FCQ71, 100, 125, 140C7VEB FCQH71, 100, 125, 140C7VEB	9.5	15.9

4D037995G

1.2 Outdoor Units

1.2.1 Cooling Only

3MKS50E3V1B

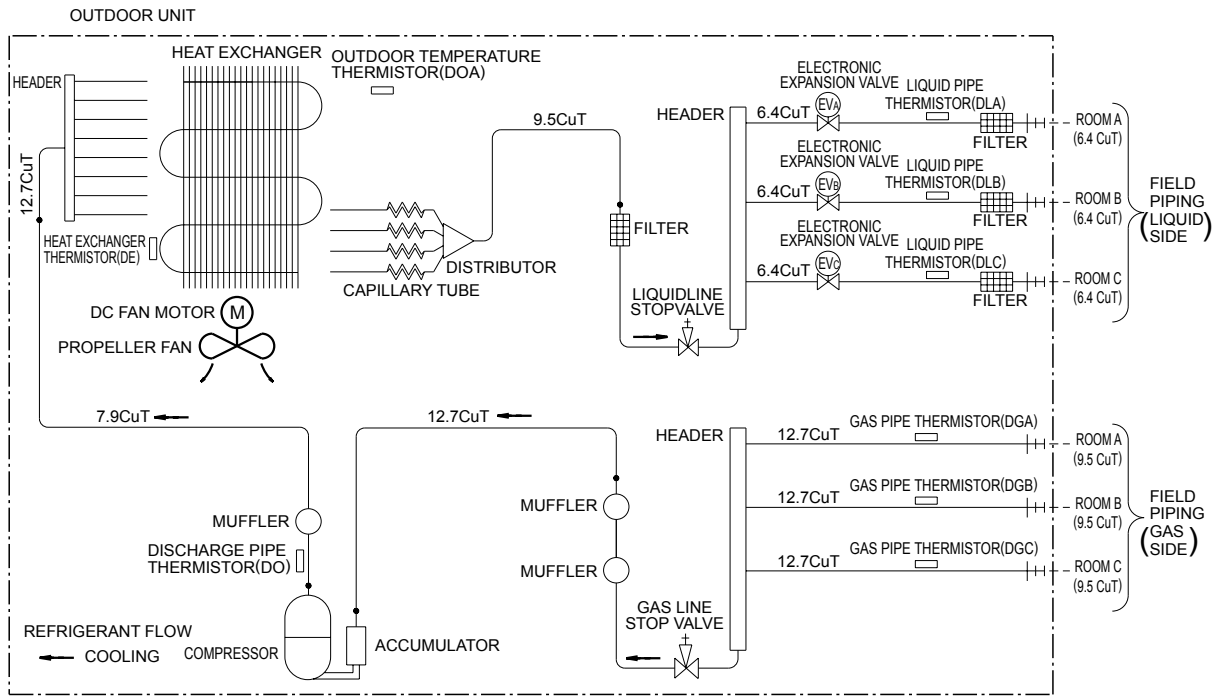

3D052056C

4MKS58E3V1B

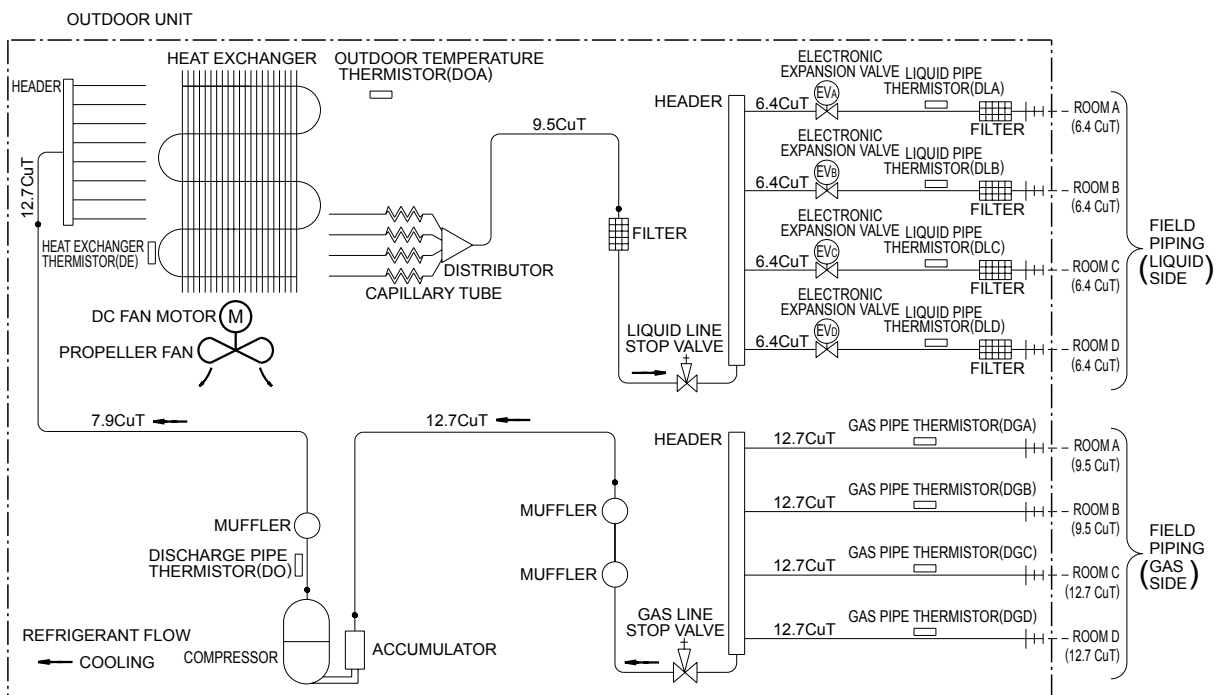

3D052057B

1.2.2 Heat Pump

3MXS52E3V1B

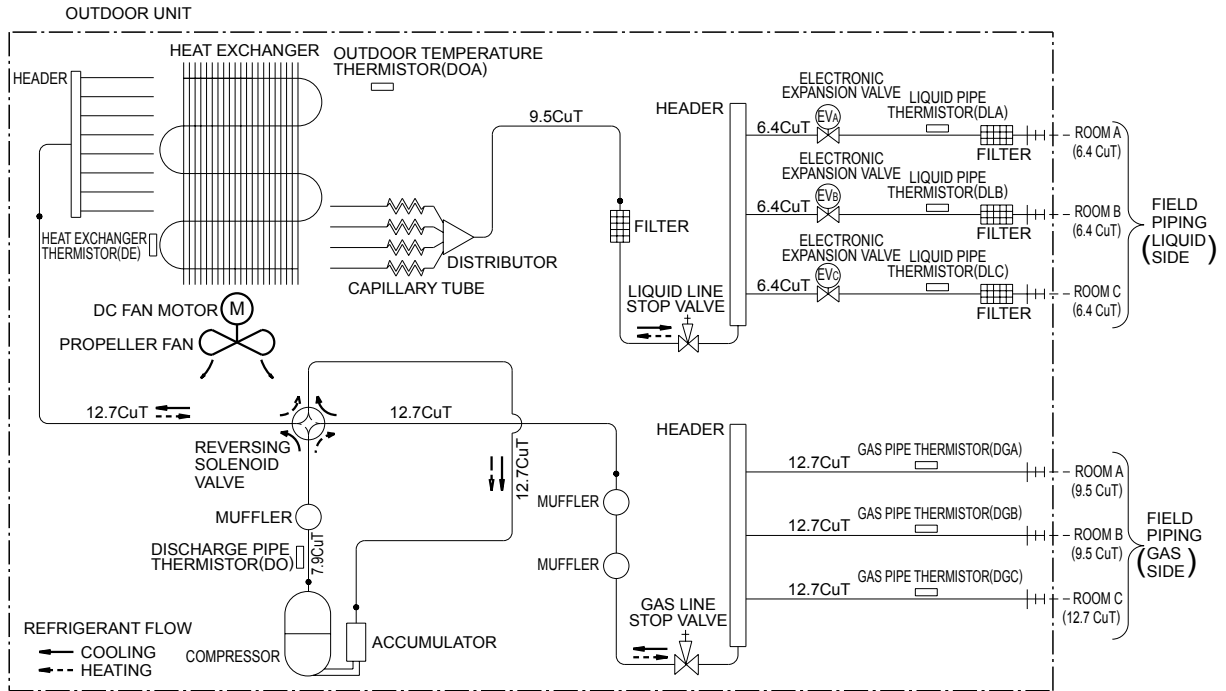

3D052055C

2. Wiring Diagrams

2.1 Indoor Units

2.1.1 Wall Mounted Type

FTKS20D3VMW(L), FTKS25D3VMW(L), FTKS35D3VMW(L)
 FTXS20D3VMW(L), FTXS25D3VMW(L), FTXS35D3VMW(L)

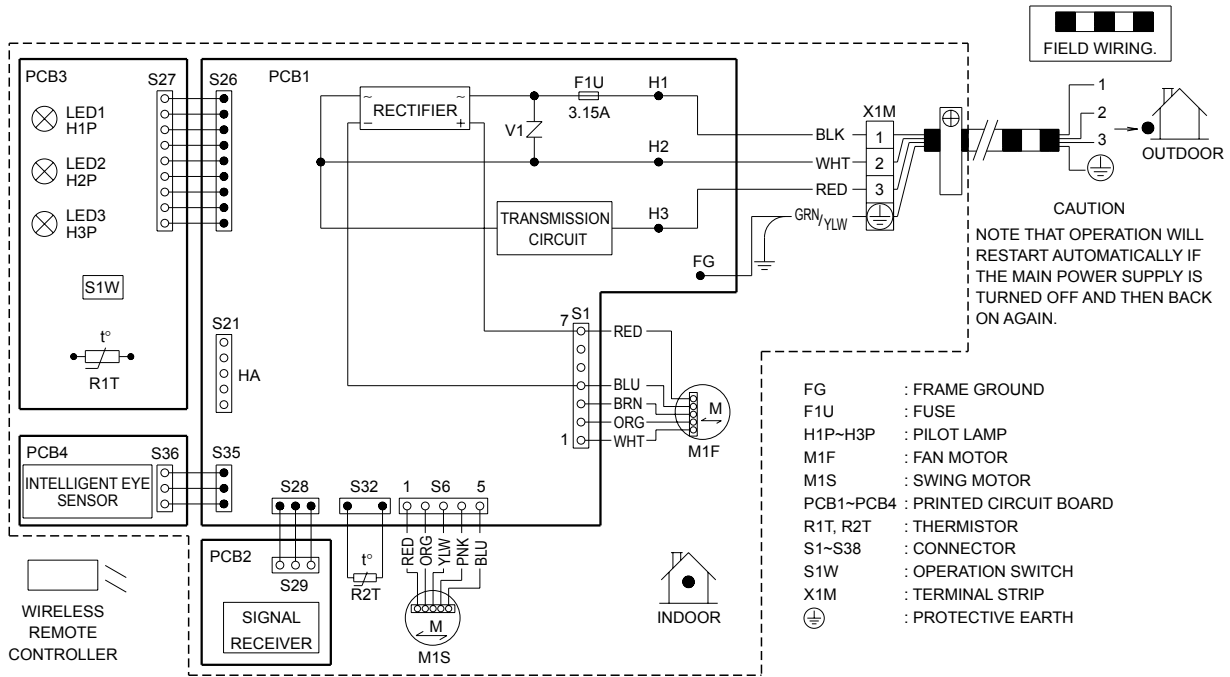

3D051268A

FTKS50D2V1W(L), FTXS50D2V1W(L)

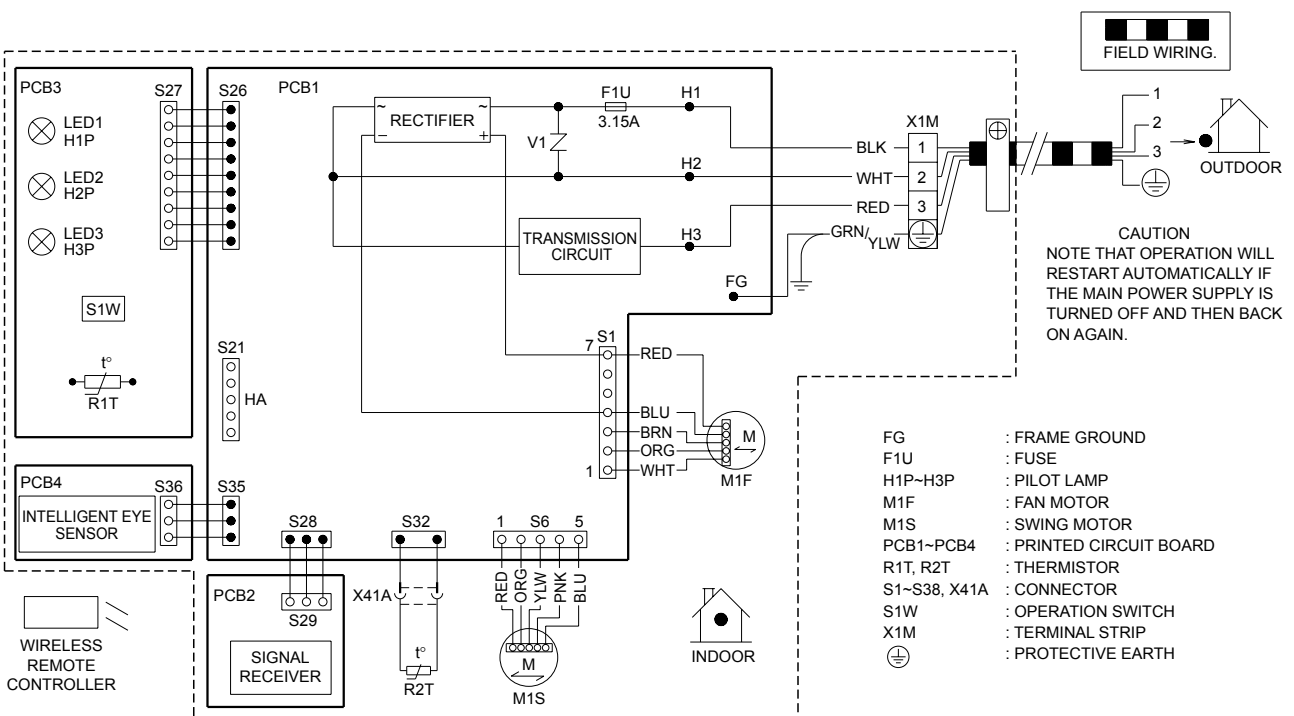

3D051652

FTKS20CAVMB, FTKS25CAVMB, FTKS35CAVMB
FTXS20CAVMB, FTXS25CAVMB, FTXS35CAVMB

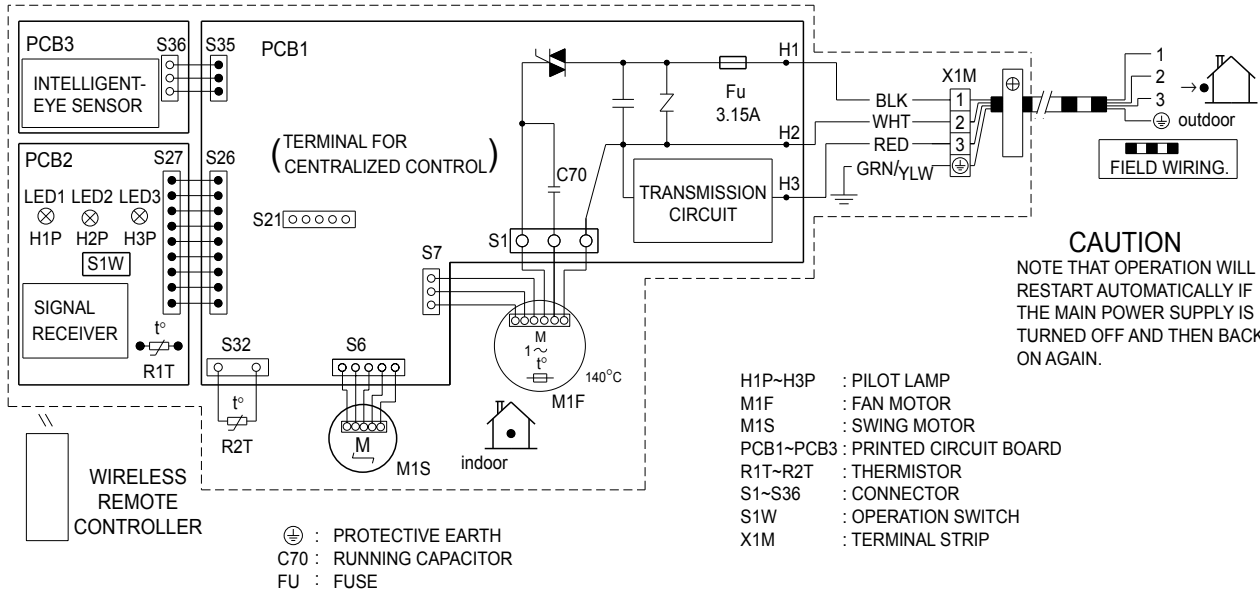

3D033599G

FTKS50FV1B, FTXS50FV1B

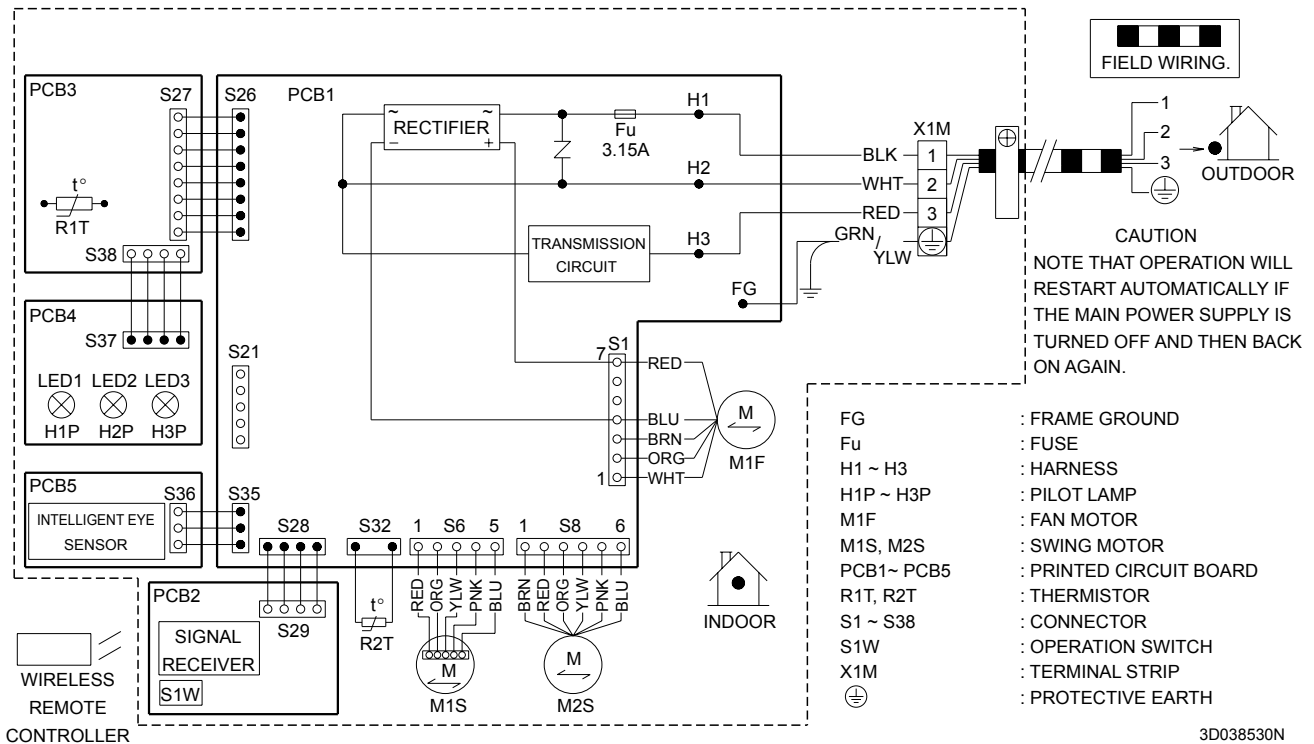

3D038530N

FTXG25EV1BW(S), FTXG35EV1BW(S), CTXG50EV1BW(S)

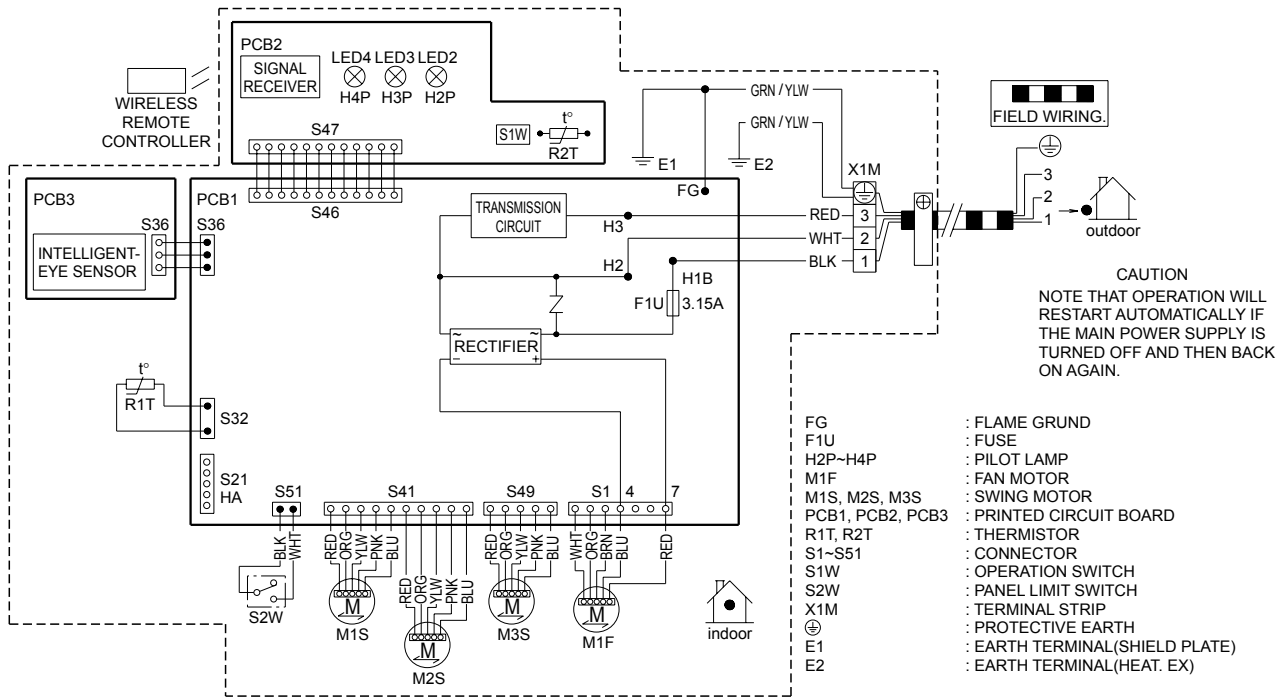

3D050493

2.1.2 Duct Connected Type

FDKS25CAVMB, FDKS35CAVMB, FDKS50CVMB, FDKS25EAVMB, FDKS35EAVMB
FDXS25CAVMB, FDXS35CAVMB, FDXS50CVMB, FDXS25EAVMB, FDXS35EAVMB

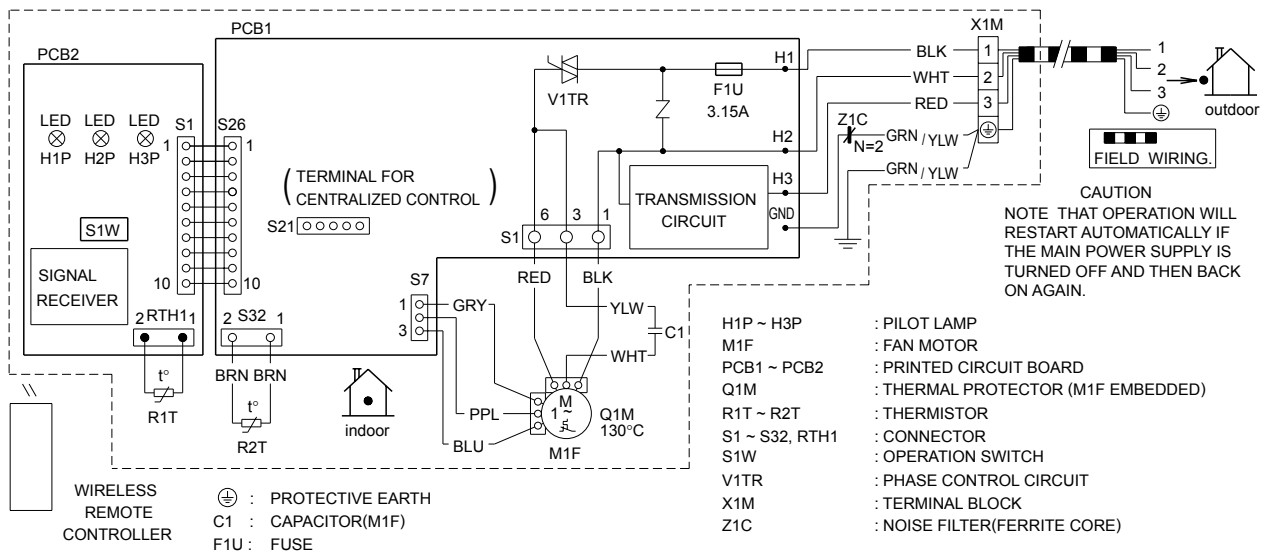

3D045012K

2.1.3 Floor / Ceiling Suspended Dual Type

FLKS25BAVMB, FLKS35BAVMB, FLKS50BAVMB
 FLXS25BAVMB, FLXS35BAVMB, FLXS50BAVMB

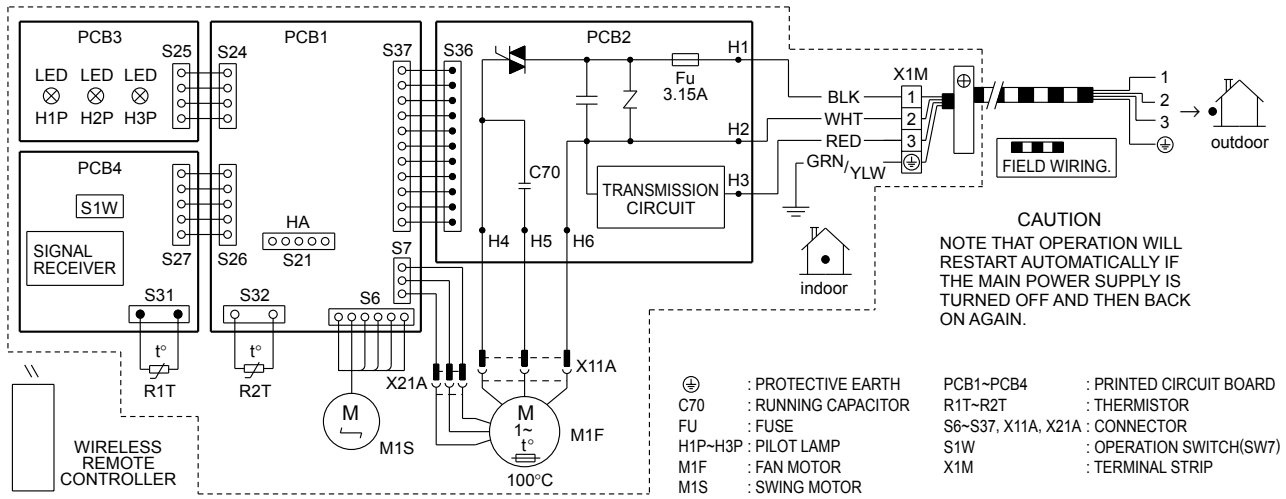

3D033909E

2.1.4 Floor Standing Type

FVXS25FV1B, FVXS35FV1B, FVXS50FV1B

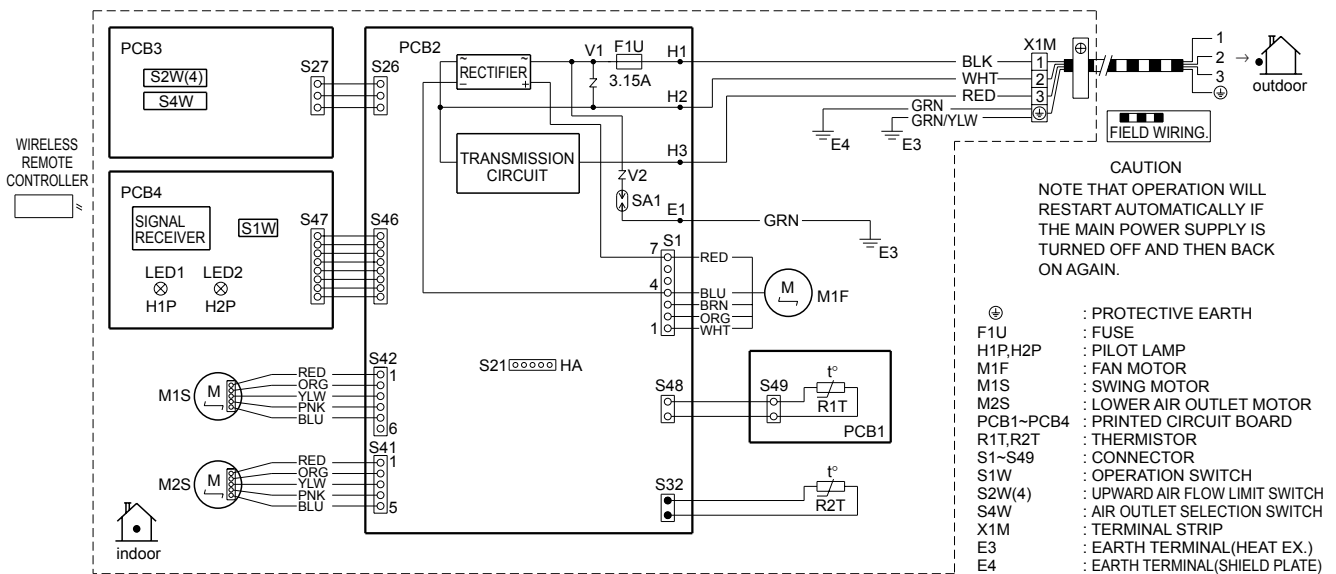

3D055953

2.1.5 Ceiling Suspended Type

FHQ35/50BVV1B

A1P	PRINTED CIRCUIT BOARD	BS1	PUSH BUTTON(ON/OFF)
C1	CAPACITOR(M1F)	H1P	LIGHT EMITTING DIODE (ON-RED)
F1U	FUSE(F5A 250V)	H2P	LIGHT EMITTING DIODE (TIMER-GREEN)
HAP	LIGHT EMITTING DIODE (SERVICE MONITOR GREEN)	H3P	LIGHT EMITTING DIODE (FILTER SIGN-RED)
KAR	MAGNETIC RELAY(M1S)	H4P	LIGHT EMITTING DIODE (DEFROST-ORANGE)
KPR	MAGNETIC RELAY(M1P)	SS1	SELECTOR SWITCH (MAIN/SUB)
M1F	MOTOR(INDOOR FAN)	SS2	SELECTOR SWITCH (WIRELESS ADDRESS SET)
M1S	MOTOR(SWING FLAP)		CONNECTOR FOR OPTIONAL PARTS
Q1M	THERMO SWITCH(M1F EMBEDDED)	X15A	CONNECTOR(FLOAT SWITCH)
R1T	THERMISTOR(AIR)	X25A	CONNECTOR(DRAIN PUMP)
R2T	THERMISTOR(COIL-1)	X33A	CONNECTOR (ADAPTOR FOR WIRING)
R3T	THERMISTOR(COIL-2)	X35A	CONNECTOR (GROUP CONTROL ADAPTOR)
S1Q	LIMIT SWITCH(SWING FLAP)	X40A	CONNECTOR (ON/OFF INPUT FROM OUTSIDE)
T1R	TRANSFORMER(220-240V/22V)	X60A	CONNECTOR (INTERFACE ADAPTOR FOR SKY AIR SERIES)
V1TR	PHASE CONTROL CIRCUIT	X61A	CONNECTOR (INTERFACE ADAPTOR FOR SKY AIR SERIES)
X1M	TERMINAL BLOCK		
X2M	TERMINAL BLOCK		
(RC)	SIGNAL RECEIVER CIRCUIT		
(TC)	SIGNAL TRANSMISSION CIRCUIT		
	WIRED REMOTE CONTROLLER		
R1T	THERMISTOR(AIR)		
SS1	SELECTOR SWITCH(MAIN/SUB)		
	WIRELESS REMOTE CONTROLLER (RECEIVER/DISPLAY UNIT)		
A3P	PRINTED CIRCUIT BOARD		
A4P	PRINTED CIRCUIT BOARD		

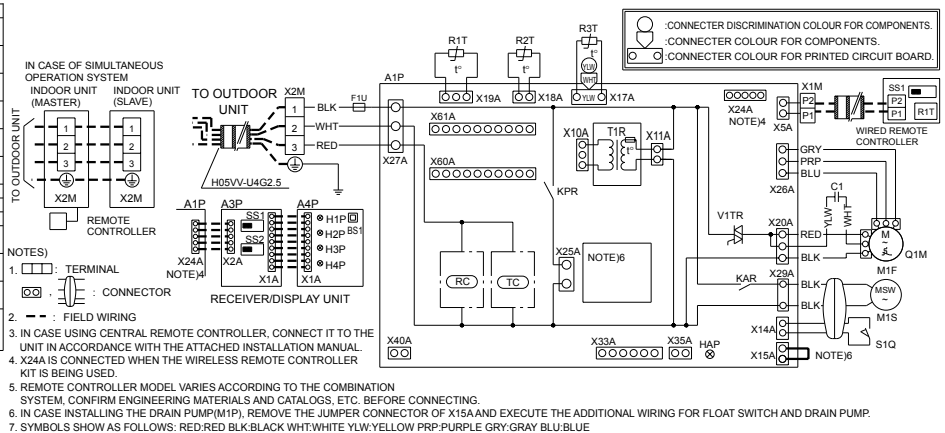
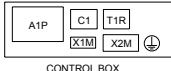

3D037842D

2.2 Outdoor Units

2.2.1 Cooling Only

3MKS50E3V1B

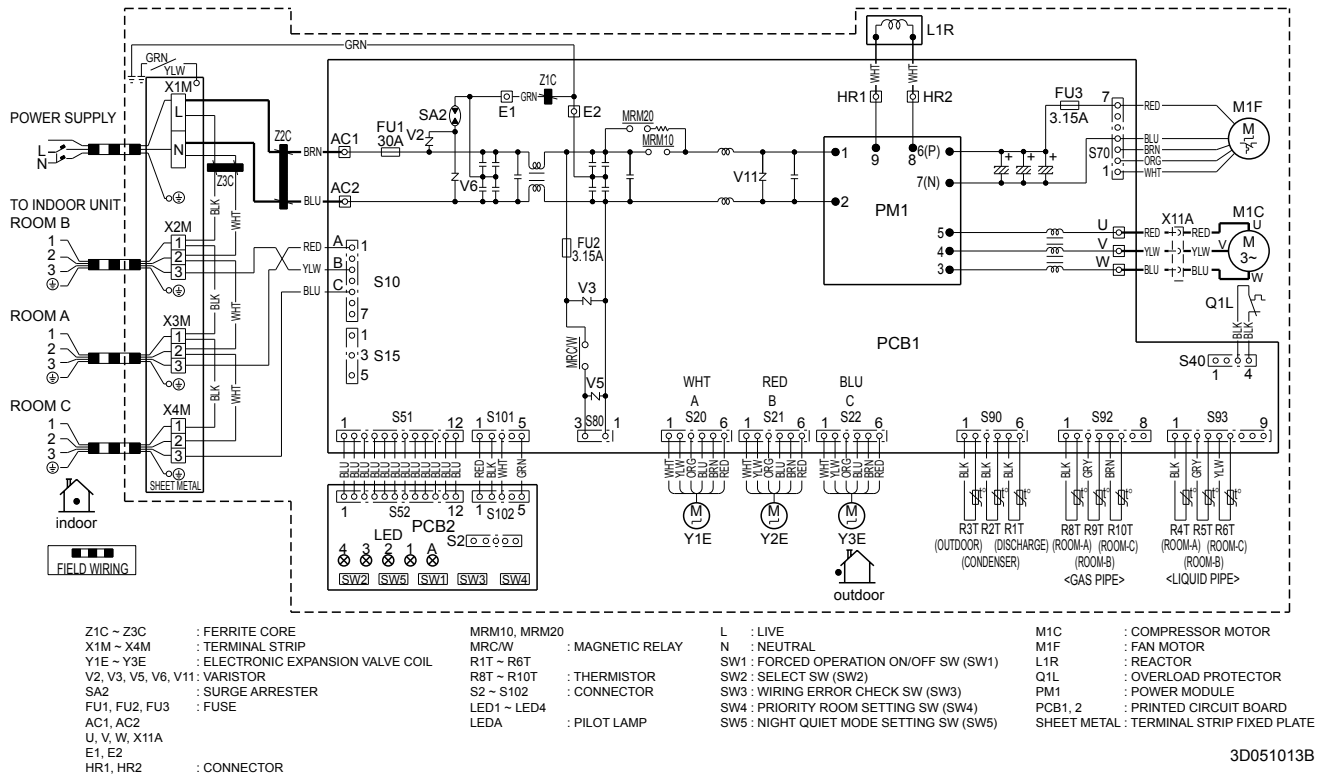

4MKS58E3V1B

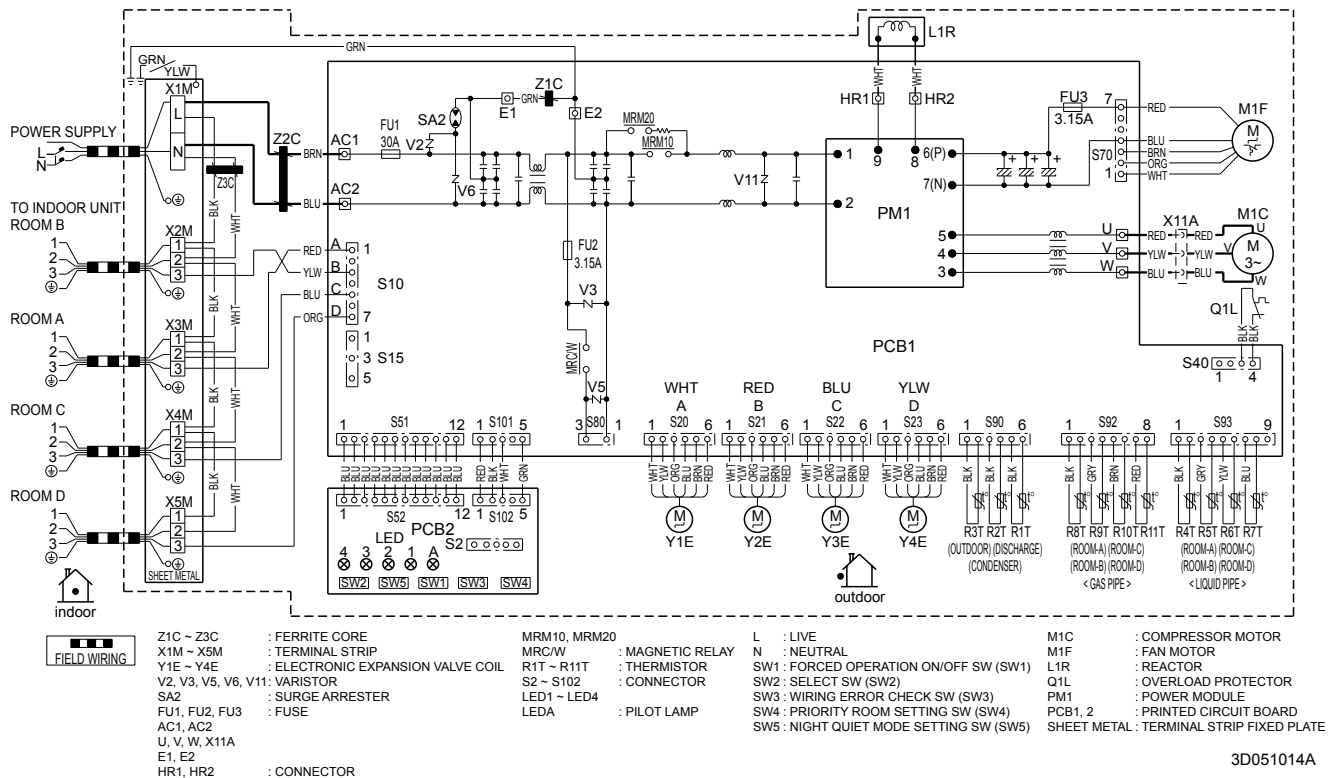

2.2.2 Heat Pump

3MXS52E3V1B

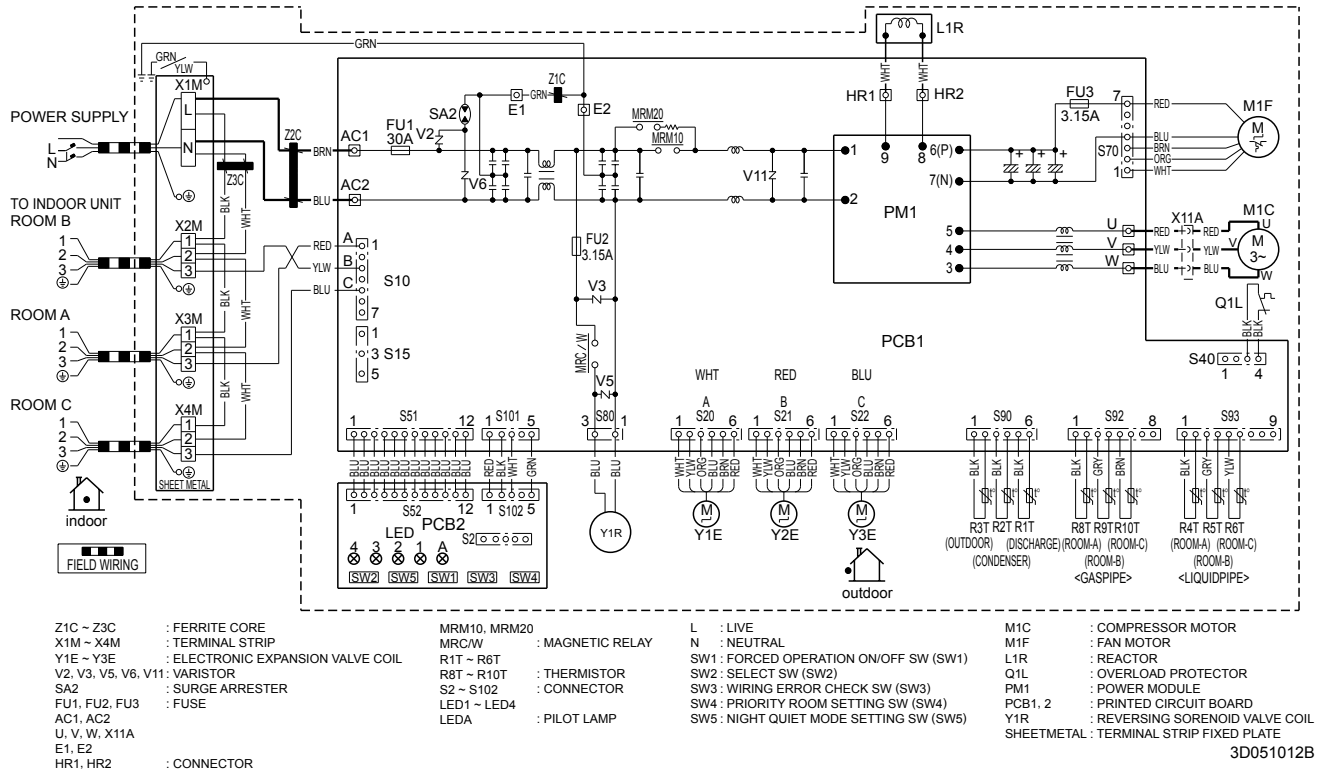

Index

Numerics

3-minute stand-by84

A

A1234
 A5235, 244
 A6237, 238
 AC154
 AC254
 address setting jumper.....36, 38, 41, 43, 45, 47, 50
 adjusting the air flow direction.....129, 189
 air purifying filter.....74
 air purifying filter with photocatalytic deodorizing
 function74
 anti-icing function in other rooms272
 AUTO · DRY · COOL · HEAT · FAN operation
127, 187
 automatic air flow control63
 automatic operation.....65
 auto-restart.....36, 43
 auto-restart function74
 auto-swing.....60

B

buzzer PCB42

C

C4240
 C7241
 C9240
 capacitor voltage check.....280
 care and cleaning.....156, 203
 centralized control.....36, 38, 41, 43, 45, 47
 changing operation room92
 check
 capacitor voltage check280
 discharge pressure check.....278
 electronic expansion valve check274
 fan motor connector output check273
 four way valve performance check275
 Hall IC check282
 installation condition check.....277
 inverter units refrigerant system check.....279
 limit switch continuity check.....273
 main circuit electrolytic capacitor check.....281
 outdoor unit fan system check
 (with DC motor).....278
 power supply waveforms check.....279
 power transistor check.....280
 thermistor resistance check.....276
 turning speed pulse input on the outdoor unit PCB
 check281
 check No.01273
 check No.02273
 check No.03273

check No.04274
 check No.05275
 check No.06276
 check No.07277
 check No.08278
 check No.09278
 check No.10279
 check No.11279
 check No.12280
 check No.13280
 check No.14281
 check No.15281
 check No.16282
 compressor313
 compressor lock248
 compressor overload.....247
 compressor protection function85
 compressor sensor system abnormality.....255
 connection pipe condensation preventing function
98
 connectors.....36, 38, 41, 43, 45, 47, 50, 54
 control PCB297
 control PCB (indoor unit)....37, 40, 42, 44, 45, 48, 51
 cooling / heating mode lock.....99
 CT or related abnormality.....258

D

DC fan lock.....249
 defrost control89
 diagnosis mode229
 diode bridge319
 discharge grille287
 discharge pipe93
 discharge pipe temperature control.....86, 93, 252
 discharge pipe thermistor76, 78, 93
 discharge pressure check278
 display PCB.....37, 42, 46, 49, 51
 distributor311

E

E1246
 E5247
 E6248
 E7249
 E8250
 econo mode68
 econo operation141, 193
 econo-mode-proof setting99
 electrical box289
 electrical box temperature rise262
 electronic expansion valve check.....274
 electronic expansion valve coil.....308
 electronic expansion valve control90
 error codes
 A1234

A5	235, 244
A6	237, 238
C4	240
C7	241
C9	240
E1	246
E5	247
E6	248
E7	249
E8	250
F3	252
F6	253
H0	255
H6	257
H8	258
H9	260
J3	260
J6	260
J8	260
J9	260
L3	262
L4	264
L5	266
P4	260
U0	268
U2	270
U4	242
U7	271
UA	243, 272
UH	272
error codes and description of fault.....	231
F	
F3	252
F6	253
fan control	88
fan motor	302
fan motor connector output check.....	273
fan motor or related abnormality	
AC motor	237
DC motor	238
fan speed control.....	63
fan speed setting.....	36, 38, 41, 43, 45, 47, 50
filter	
air purifying filter with photocatalytic deodorizing	
function	74
air-purifying filter	74
mold proof air filter (prefilter).....	74
photocatalytic deodorizing filter	74
titanium apatite photocatalytic	
air-purifying filter	74
forced operation mode	95
forced operation ON/OFF switch	
.....	36, 38, 41, 43, 45, 47, 50, 54
four way valve	312
four way valve coil.....	308
four way valve operation compensation.....	84
four way valve performance check.....	275
four way valve switching	84
freeze-up protection control	87, 235, 244
frequency control.....	81
frequency principle	58
front panel	285
front panel control	62
front panel mechanism	43, 241
front panel open/close fault	241
FU1	36, 38, 41, 43, 45, 47, 50, 54
FU2	54
FU3	54
functions	2
fuse	36, 38, 41, 43, 45, 47, 50, 54
G	
gas pipe isothermal control during cooling.....	92
gas pipe thermistor.....	76, 78
H	
H0.....	255
H6.....	257
H8.....	258
H9.....	260
HA	36, 41, 43
Hall IC	63, 237, 238
Hall IC check	282
HAP	52
heating peak-cut control	87
high pressure control.....	235
high pressure control in cooling	253
HOME LEAVE operation	71, 142
hot start function.....	73
HR1	54
HR2	54
I	
indoor heat exchanger thermistor	77, 79
indoor unit PCB abnormality	234
input current control	86
input over current detection.....	250
installation condition check	277
instruction	103
instruction FHQ series.....	210
insufficient gas	268
insufficient gas control.....	94
INTELLIGENT EYE	69
INTELLIGENT EYE operation.....	144
INTELLIGENT EYE sensor	318
INTELLIGENT EYE sensor PCB.....	37, 40, 42, 44
inverter POWERFUL operation.....	72
inverter principle	58
inverter units refrigerant system check.....	279
J	
J3	260
J4	317
J6	260
J8	260
J9	260
JA	36, 38, 41, 43, 45, 47, 50, 317
JB	36, 38, 41, 43, 45, 47, 50, 317
JC	36, 38, 41, 43, 45, 47, 50, 317
jumper setting.....	317

- L**
- L3262
 - L4264
 - L5266
 - LED A36, 38, 41, 43, 45, 47, 50, 54
 - LED136, 38, 41, 45, 47, 50, 54
 - LED236, 38, 41, 43, 45, 47, 50, 54
 - LED336, 38, 41, 43, 45, 47, 54
 - LED443, 54
 - limit switch43, 241
 - limit switch continuity check273
 - liquid compression protection function 288
 - liquid pipe thermistor77
 - low-voltage detection270
- M**
- main circuit electrolytic capacitor check281
 - main PCB (outdoor unit)55
 - main structural parts75
 - mode hierarchy80
 - mold proof air filter (prefilter)74
 - motor
 - reduction motor43
 - multi system154, 201
- N**
- names of parts106, 181
 - night set mode67
- O**
- oil recovery function93
 - OL activation247
 - ON/OFF button on indoor unit73
 - opening limit92
 - operation lamp224
 - outdoor air thermistor295
 - outdoor heat exchanger thermistor76, 78
 - outdoor unit fan system check
 - (with DC motor)278
 - outdoor unit PCB abnormality246
 - OUTDOOR UNIT QUIET operation140, 192
 - output over current detection266
 - over current94
 - overload94
 - over-voltage detection270
- P**
- P4260
 - PCB (ceiling suspended type)53
 - photocatalytic deodorizing filter74
 - PI control82
 - piping diagrams322
 - position sensor abnormality257
 - power failure recovery function
 -36, 38, 41, 43, 45, 47, 50
 - power supply PCB48
 - power supply waveforms check279
 - power transistor319
 - power transistor check280
 - power-airflow dual flaps60
 - POWERFUL operation139, 191
 - POWERFUL operation mode98
 - preheating operation84
 - preparation before operation124, 184
 - pressure equalization control92
 - preventing indoor freezing95
 - printed circuit board (PCB)
 - buzzer pcb42
 - ceiling suspended type53
 - control PCB297
 - control PCB (indoor unit)
 -37, 40, 42, 44, 45, 48, 51
 - display PCB37, 42, 46, 49, 51
 - INTELLIGENT EYE sensor PCB ... 37, 40, 42, 44
 - main PCB (outdoor unit)55
 - power supply PCB48
 - removal procedure296
 - sensor PCB51
 - service monitor PCB55
 - service PCB51, 296
 - signal receiver PCB37, 40, 42, 44, 49
 - printed circuit board connector wiring diagram36
 - priority room setting98
 - problem symptoms and measures226
 - programme dry function64
 - propeller fan302
- R**
- radiation fin temperature rise264
 - reduction motor43, 241
 - remote controller227, 228
 - removal procedure
 - compressor313
 - distributor311
 - electrical box289
 - electronic expansion valve coil308
 - fan motor302
 - four way valve312
 - four way valve coil308
 - panels and plates284
 - PCB296
 - propeller fan302
 - sound blanket304
 - thermistor308
 - right side panel304
 - RTH136, 38, 41, 43, 45
- S**
- S136, 38, 41, 43, 45, 50
 - S1054
 - S10154
 - S10254, 296
 - S1554
 - S2054, 291
 - S2136, 38, 41, 43, 45, 47, 50, 54, 291
 - S2254, 291
 - S2354, 291
 - S2447
 - S2547
 - S2636, 38, 41, 45, 47, 50
 - S2736, 38, 41, 47, 50
 - S2836, 41

S29.....	36, 41
S31.....	47
S32.....	36, 38, 41, 43, 45, 47
S35.....	36, 38, 41
S36.....	36, 38, 41, 43, 47
S37.....	41, 47
S38.....	41
S40.....	54, 292
S41.....	43, 50
S42.....	50
S46.....	43, 50
S47.....	43, 50
S48.....	50
S49.....	43, 50
S51.....	43, 54
S52.....	54, 296
S6.....	36, 38, 41, 47
S7.....	38, 45, 47
S70.....	54, 290
S8.....	41
S80.....	54, 293
S90.....	54, 292, 309
S92.....	54, 292, 309
S93.....	54, 292, 309
safety precautions.....	104, 179
SC control.....	92
self-diagnosis digital display.....	74
sensor malfunction detection.....	94
sensor PCB (indoor unit).....	51
service check function.....	227
service monitor PCB.....	55
service PCB.....	51, 296
signal receiver PCB.....	37, 40, 42, 44, 49
signal receiving sign.....	73
signal transmission error.....	242
signal transmission error (on outdoor unit PCB) ...	271
silicon grease.....	319
sound blanket.....	304
specifications.....	14
starting control	
indoor unit.....	62
starting operation control.....	92
stop valve cover.....	287
SW1.....	36, 41, 43, 45, 47, 50, 54
SW2.....	47, 50, 54
SW3.....	54
SW4.....	50, 54
SW5.....	54
SW7.....	38
T	
target discharge pipe temperature control.....	93
terminal board.....	300
test run from the remote controller.....	316
thermistor	
discharge pipe thermistor.....	76, 78, 93, 308
gas pipe thermistor.....	76, 78, 308
heat exchanger thermistor.....	308
indoor heat exchanger thermistor.....	77, 79
liquid pipe thermistor.....	77, 308
outdoor air thermistor.....	308
outdoor heat exchanger thermistor.....	76, 78
thermistor or related abnormality (indoor unit).....	240
thermistor or related abnormality (outdoor unit) ...	260
thermistor resistance check.....	276
thermostat control.....	66
TIMER operation.....	152, 194
titanium apatite photocatalytic air-purifying filter	74
top panel.....	284
troubleshooting.....	175, 206
indoor units.....	232
outdoor units.....	233
troubleshooting with the LED indication.....	225
troubleshooting with the operation lamp.....	224
turning speed pulse input on the outdoor unit PCB	
check.....	281
U	
U0.....	268
U2.....	270
U4.....	242
U7.....	271
UA.....	243, 272
UH.....	272
unspecified voltage (between indoor and outdoor	
units).....	243, 272
V	
V1.....	36, 38, 41, 43, 45, 47, 50
V100.....	54
V2.....	54
V3.....	54
V5.....	54
V9.....	54
varistor.....	36, 38, 41, 43, 45, 47, 50, 54
W	
WEEKLY TIMER operation.....	74, 196
wide-angle louvers.....	60
wiring diagrams.....	330
wiring-error check.....	96
X	
X14A.....	52
X15A.....	52
X17A.....	52
X18A.....	52
X19A.....	52
X20A.....	52
X24A.....	52
X25A.....	52
X26A.....	52
X27A.....	52
X29A.....	52
X33A.....	52
X35A.....	52
X40A.....	52
X5A.....	52
X60A.....	52
X61A.....	52

Drawings & Flow Charts

Numerics

3-D airflow60

A

anti-icing function in other rooms272
 automatic air flow control63
 automatic operation65
 auto-swing60

B

buzzer PCB42

C

capacitor voltage check280
 check No.01273
 check No.02273
 check No.03273
 check No.04274
 check No.05275
 check No.06276
 check No.07277
 check No.08278
 check No.09278
 check No.10279
 check No.11279
 check No.12280
 check No.13280
 check No.14281
 check No.15281
 check No.16282
 comfort airflow mode60
 compressor lock248
 compressor overload247
 compressor protection function85
 compressor sensor system abnormality255
 control PCB (indoor unit)
 37, 39, 40, 42, 44, 45, 48, 51
 cooling / heating mode lock99
 CT or related abnormality258

D

DC fan lock249
 defrost control89
 diagnosis mode229
 diode bridge319
 discharge pipe temperature control86, 252
 discharge pressure check278
 display PCB37, 42, 46, 49, 51

E

econo mode68
 electrical box temperature rise262
 electronic expansion valve check274
 electronic expansion valve control90

F

fan motor connector output check273
 fan motor or related abnormality
 AC motor237
 DC motor238
 four way valve performance check275
 freeze-up protection control87, 235, 244
 frequency control81
 frequency principle58
 front panel open/close fault241
 function of thermistor
 cooling only model78
 heat pump model76

H

Hall IC check282
 heating peak-cut control87
 high pressure control235
 high pressure control in cooling253
 HOME LEAVE operation71
 hot start function73

I

indoor unit PCB abnormality234
 input current control86
 input over current detection250
 installation condition check277
 insufficient gas268
 insufficient gas control94
 INTELLIGENT EYE69
 INTELLIGENT EYE sensor318
 INTELLIGENT EYE sensor PCB ... 37, 39, 40, 42, 44
 inverter features59
 inverter POWERFUL operation72
 inverter units refrigerant system check279

J

jumper settings317

L

limit switch continuity check273
 location of operation lamp224
 low-voltage detection270

M

main circuit electrolytic capacitor check281
 main PCB (outdoor unit)55
 main structural parts75
 mode hierarchy80

N

night set mode67

O		R	
OL activation	247	radiation fin temperature rise	264
ON/OFF button on indoor unit	73	remote controller	227, 228
outdoor unit fan system check (with DC motor) ...	278	S	
outdoor unit PCB abnormality	246	sensor PCB	51
output over current detection	266	service monitor PCB	55
over-voltage detection	270	service PCB	51
P		signal receiver PCB	37, 39, 40, 42, 44, 49
PCB (ceiling suspended type)	53	signal transmission error	242
phase steps	63	signal transmission error (on outdoor unit PCB)	271
piping diagrams		silicon grease	319
3MKS50E3V1B	328	starting control flow	62
3MXS52E3V1B	329	starting timing chart	62
4MKS58E3V1B	328	T	
CTXG50EV1BW(S)	323	target discharge pipe temperature control	93
FDKS25CAVMB	325	test operation from remote controller	316
FDKS25EAVMB	325	thermistor or related abnormality (indoor unit) ...	240
FDKS35CAVMB	325	thermistor or related abnormality (outdoor unit) ..	260
FDKS35EAVMB	325	thermistor resistance check	276
FDKS50CVMB	325	thermostat control	66
FDXS25CAVMB	325	troubleshooting with the LED indication	225
FDXS25EAVMB	325	turning speed pulse input on the outdoor unit PCB check	281
FDXS35CAVMB	325	U	
FDXS35EAVMB	325	unspecified voltage (between indoor and outdoor units)	243, 272
FDXS50CVMB	325	W	
FHQ35/50BVV1B	327	wiring diagrams	
FLKS25BAVMB	325	3MKS50E3V1B	335
FLKS35BAVMB	325	3MXS52E3V1B	336
FLKS50BAVMB	325	4MKS58E3V1B	335
FLXS25BAVMB	326	CTXG50EV1BW(S)	332
FLXS35BAVMB	326	FDKS25CAVMB	332
FLXS50BAVMB	326	FDKS25EAVMB	332
FTKS20CAVMB	322	FDKS35CAVMB	332
FTKS20D3VMW(L)	322	FDKS35EAVMB	332
FTKS25CAVMB	322	FDKS50CVMB	332
FTKS25D3VMW(L)	322	FDXS25CAVMB	332
FTKS35CAVMB	322	FDXS25EAVMB	332
FTKS35D3VMW(L)	322	FDXS35CAVMB	332
FTKS50D2V1W(L)	322	FDXS35EAVMB	332
FTKS50FV1B	322	FDXS50CVMB	332
FTXG25EV1BW(S)	323	FHQ35/50BVV1B	334
FTXG35EV1BW(S)	323	FLKS25BAVMB	333
FTXS20CAVMB	324	FLKS35BAVMB	333
FTXS20D3VMW(L)	323	FLKS50BAVMB	333
FTXS25CAVMB	324	FLXS25BAVMB	333
FTXS25D3VMW(L)	323	FLXS35BAVMB	333
FTXS35CAVMB	324	FLXS50BAVMB	333
FTXS35D3VMW(L)	323	FTKS20CAVMB	331
FTXS50D2V1W(L)	323	FTKS20D3VMW(L)	330
FTXS50FV1B	324	FTKS25CAVMB	331
FVXS25FV1B	326	FTKS25D3VMW(L)	330
FVXS35FV1B	326	FTKS35CAVMB	331
FVXS50FV1B	326	FTKS35D3VMW(L)	330
position sensor abnormality	257	FTKS50D2V1W(L)	330
power supply PCB	48	W	
power supply waveforms check	279		
power transistor	319		
power transistor check	280		
priority room setting	98		
programme dry function	64		

FTKS50FV1B	331
FTXG25EV1BW(S)	332
FTXG35EV1BW(S)	332
FTXS20CAVMB	331
FTXS20D3VMW(L)	330
FTXS25CAVMB	331
FTXS25D3VMW(L)	330
FTXS35CAVMB	331
FTXS35D3VMW(L)	330
FTXS50D2V1W(L)	330
FTXS50FV1B	331
FVXS25FV1B	333
FVXS35FV1B	333
FVXS50FV1B	333
wiring-error check	96

Warning



- Daikin Industries, Ltd.'s products are manufactured for export to numerous countries throughout the world. Daikin Industries, Ltd. does not have control over which products are exported to and used in a particular country. Prior to purchase, please therefore confirm with your local authorised importer, distributor and/or retailer whether this product conforms to the applicable standards, and is suitable for use, in the region where the product will be used. This statement does not purport to exclude, restrict or modify the application of any local legislation.
- Ask a qualified installer or contractor to install this product. Do not try to install the product yourself. Improper installation can result in water or refrigerant leakage, electrical shock, fire or explosion.
- Use only those parts and accessories supplied or specified by Daikin. Ask a qualified installer or contractor to install those parts and accessories. Use of unauthorised parts and accessories or improper installation of parts and accessories can result in water or refrigerant leakage, electrical shock, fire or explosion.
- Read the User's Manual carefully before using this product. The User's Manual provides important safety instructions and warnings. Be sure to follow these instructions and warnings.

If you have any enquiries, please contact your local importer, distributor and/or retailer.

Cautions on product corrosion

1. Air conditioners should not be installed in areas where corrosive gases, such as acid gas or alkaline gas, are produced.
2. If the outdoor unit is to be installed close to the sea shore, direct exposure to the sea breeze should be avoided. If you need to install the outdoor unit close to the sea shore, contact your local distributor.



JMI-0107



JQA-1452

About ISO 9001

ISO 9001 is a plant certification system defined by the International Organization for Standardization (ISO) relating to quality assurance. ISO 9001 certification covers quality assurance aspects related to the "design, development, manufacture, installation, and supplementary service" of products manufactured at the plant.



EC99J2044

About ISO 14001

ISO 14001 is the standard defined by the International Organization for Standardization (ISO) relating to environmental management systems. Our group has been acknowledged by an internationally accredited compliance organisation as having an appropriate programme of environmental protection procedures and activities to meet the requirements of ISO 14001.

Dealer

DAIKIN INDUSTRIES, LTD.

Head Office:
Umeda Center Bldg., 2-4-12, Nakazaki-Nishi,
Kita-ku, Osaka, 530-8323 Japan

Tokyo Office:
JR Shinagawa East Bldg., 2-18-1, Konan,
Minato-ku, Tokyo, 108-0075 Japan

http://www.daikin.com/global_ac/

©All rights reserved