

Service Manual

Inverter Multi for 2 Rooms B-Series



[Applied Models]

- Inverter Multi: Cooling Only
- Inverter Multi: Heat Pump

Inverter Multi for 2 Rooms B-Series

●Cooling Only

Outdoor Unit
2MKS40BVMB

Indoor Unit

FTKS20CVMB(9)

FTKS25CVMB(9)(8)

FTKS35CVMB(9)(8)

FLKS25BVMB

FLKS35BVMB

CDKS25CVMB

CDKS35CVMB

2AMKS40BVMB

ATKS20CVMB(9)

ATKS25CVMB(9)

ATKS35CVMB(9)

ATKS20DVMB

ATKS25DVMB

ATKS35DVMB

●Heat Pump

Outdoor Unit
2MXS40BVMB

Indoor Unit

FTXS20CVMB(9)

FTXS25CVMB(9)(8)

FTXS35CVMB(9)(8)

FLXS25BVMB

FLXS35BVMB

CDXS25CVMB

CDXS35CVMB

2AMXS40BVMB

ATXS20CVMB(9)

ATXS25CVMB(9)

ATXS35CVMB(9)

ATXS20DVMB

ATXS25DVMB

ATXS35DVMB

1. Introduction	V
1.1 Safety Cautions	V
Part 1 List of Functions	1
1. Cooling Only	2
2. Heat Pump	5
Part 2 Specifications	9
1. Cooling Only	10
1.1 Indoor Units	10
1.2 Outdoor Units	14
2. Heat Pump	15
2.1 Indoor Units	15
2.2 Outdoor Units	19
Part 3 Printed Circuit Board Connector Wiring Diagram	21
1. Printed Circuit Board Connector Wiring Diagram	22
1.1 Wall Mounted Type	22
1.2 Duct Connected Type	24
1.3 Floor / Ceiling Suspended Dual Type	26
1.4 Outdoor Unit	28
Part 4 Function and Control	31
1. Main Functions	32
1.1 Frequency Principle	32
1.2 Power-Airflow Dual Flaps, Wide Angle Louvers and Auto-Swing	34
1.3 Fan Speed Control for Indoor Units	35
1.4 Programme Dry Function	36
1.5 Automatic Operation	37
1.6 Night Set Mode	38
1.7 Intelligent Eye	39
1.8 Home Leave Operation	41
1.9 Inverter Powerful Operation	42
1.10 Other Functions	43
2. Function of Main Structural Parts	45
2.1 Main Structural Parts	45
2.2 Function of Thermistor	46
3. Control Specification	49
3.1 Mode Hierarchy	49
3.2 Frequency Control	50
3.3 Controls at Mode Changing / Start-up	52
3.4 Discharge Pipe Control	53
3.5 Input Current Control	53
3.6 Freeze-up Protection Control	54
3.7 Heating Peak-cut Control	54
3.8 Fan Control	55
3.9 Liquid Compression Protection Function 2	55
3.10 Defrost Control	56
3.11 Electronic Expansion Valve Control	57

3.12 Malfunctions	61
3.13 Preventing Indoor Freezing	62
3.14 Forced Operation Mode	62
3.15 Additional Function	62

Part 5 System Configuration..... 63

1. System Configuration	64
2. Instruction (in case of FTK(X)S 20/25/35 CVMB)	65
2.1 Safety Precautions	65
2.2 Names of Parts	67
2.3 Preparation before Operation	70
2.4 AUTO·DRY·COOL·HEAT·FAN Operation	73
2.5 Adjusting the Air Flow Direction	75
2.6 POWERFUL Operation	77
2.7 OUTDOOR UNIT SILENT Operation	78
2.8 HOME LEAVE Operation	79
2.9 INTELLIGENT EYE Operation	81
2.10 TIMER Operation	83
2.11 Note for Multi System	85
2.12 Care and Cleaning	87
2.13 Troubleshooting	90

Part 6 Service Diagnosis..... 95





1. Caution for Diagnosis	96
2. Problem Symptoms and Measures	98
3. Service Check Function	99
4. Troubleshooting	102
4.1 Error Codes and Description	102
4.2 Indoor Unit PCB Abnormality	103
4.3 Freeze-up Protection Control or High Pressure Control	104
4.4 Fan Motor (AC Motor) or Related Abnormality	106
4.5 Thermistor or Related Abnormality (Indoor Unit)	107
4.6 Anti-icing Function	108
4.7 OL Activation (Compressor Overload)	110
4.8 Compressor Lock	111
4.9 DC Fan Lock	112
4.10 Input Over Current Detection	113
4.11 Four Way Valve Abnormality	115
4.12 Discharge Pipe Temperature Control	117
4.13 High Pressure Control in Cooling	118
4.14 Position Sensor Abnormality	120
4.15 CT or Related Abnormality	121
4.16 Thermistor or Related Abnormality (Outdoor Unit)	123
4.17 Electrical Box Temperature Rise	125
4.18 Radiation Fin Temperature Rise	127
4.19 Output Over Current Detection	129
4.20 Insufficient Gas	131
4.21 Over-voltage Detection	133
4.22 Anti-icing Function in Other Rooms / Unspecified Voltage (between Indoor and Outdoor Units)	134

4.23 Outdoor Unit PCB Abnormality or Signal Transmission Circuit Abnormality	135
5. Check	136
5.1 How to Check	136
Part 7 Removal Procedure	145
1. Outdoor Unit	146
1.1 Removal of the Panels / Fan Motor	146
1.2 Removal of the PCB	151
1.3 Removal of the Electrical Box	156
1.4 Removal of the Sound Blanket	159
1.5 Removal of the Thermistor	162
1.6 Removal of the Four Way Valve	163
1.7 Removal of the Electronic Expansion Valve	165
1.8 Removal of the Compressor	166
Part 8 Others	169
1. Others	170
1.1 Test Run from the Remote Controller	170
1.2 Jumper Settings	171
Part 9 Appendix	173
1. Piping Diagrams	174
1.1 Indoor Units	174
1.2 Outdoor Units	176
2. Wiring Diagrams	177
2.1 Indoor Units	177
2.2 Outdoor Units	179
Index	i
Drawings & Flow Charts	v







1. Introduction







1.1 Safety Cautions

Cautions and Warnings

- Be sure to read the following safety cautions before conducting repair work.
- The caution items are classified into “ **Warning**” and “ **Caution**”. The “ **Warning**” items are especially important since they can lead to death or serious injury if they are not followed closely. The “ **Caution**” items can also lead to serious accidents under some conditions if they are not followed. Therefore, be sure to observe all the safety caution items described below.
- About the pictograms
 - △ This symbol indicates an item for which caution must be exercised.
The pictogram shows the item to which attention must be paid.
 - This symbol indicates a prohibited action.
The prohibited item or action is shown inside or near the symbol.
 - This symbol indicates an action that must be taken, or an instruction.
The instruction is shown inside or near the symbol.
- After the repair work is complete, be sure to conduct a test operation to ensure that the equipment operates normally, and explain the cautions for operating the product to the customer.



1.1.1 Caution in Repair



 Warning	
<p>Be sure to disconnect the power cable plug from the plug socket before disassembling the equipment for a repair. Working on the equipment that is connected to a power supply can cause an electrical shock. If it is necessary to supply power to the equipment to conduct the repair or inspecting the circuits, do not touch any electrically charged sections of the equipment.</p>	
<p>If the refrigerant gas discharges during the repair work, do not touch the discharging refrigerant gas. The refrigerant gas can cause frostbite.</p>	
<p>When disconnecting the suction or discharge pipe of the compressor at the welded section, release the refrigerant gas completely at a well-ventilated place first. If there is a gas remaining inside the compressor, the refrigerant gas or refrigerating machine oil discharges when the pipe is disconnected, and it can cause injury.</p>	
<p>If the refrigerant gas leaks during the repair work, ventilate the area. The refrigerant gas can generate toxic gases when it contacts flames.</p>	
<p>The step-up capacitor supplies high-voltage electricity to the electrical components of the outdoor unit. Be sure to discharge the capacitor completely before conducting repair work. A charged capacitor can cause an electrical shock.</p>	
<p>Do not start or stop the air conditioner operation by plugging or unplugging the power cable plug. Plugging or unplugging the power cable plug to operate the equipment can cause an electrical shock or fire.</p>	

 Warning	
Do not repair the electrical components with wet hands. Working on the equipment with wet hands can cause an electrical shock.	
Do not clean the air conditioner by splashing water. Washing the unit with water can cause an electrical shock.	
Be sure to provide the grounding when repairing the equipment in a humid or wet place, to avoid electrical shocks.	
Be sure to turn off the power switch and unplug the power cable when cleaning the equipment. The internal fan rotates at a high speed, and cause injury.	
Do not tilt the unit when removing it. The water inside the unit can spill and wet the furniture and floor.	
Be sure to check that the refrigerating cycle section has cooled down sufficiently before conducting repair work. Working on the unit when the refrigerating cycle section is hot can cause burns.	
Use the welder in a well-ventilated place. Using the welder in an enclosed room can cause oxygen deficiency.	



1.1.2 Cautions Regarding Products after Repair



 Warning	
Be sure to use parts listed in the service parts list of the applicable model and appropriate tools to conduct repair work. Never attempt to modify the equipment. The use of inappropriate parts or tools can cause an electrical shock, excessive heat generation or fire.	
When relocating the equipment, make sure that the new installation site has sufficient strength to withstand the weight of the equipment. If the installation site does not have sufficient strength and if the installation work is not conducted securely, the equipment can fall and cause injury.	
Be sure to install the product correctly by using the provided standard installation frame. Incorrect use of the installation frame and improper installation can cause the equipment to fall, resulting in injury.	For integral units only
Be sure to install the product securely in the installation frame mounted on a window frame. If the unit is not securely mounted, it can fall and cause injury.	For integral units only



 Warning	
Be sure to use an exclusive power circuit for the equipment, and follow the technical standards related to the electrical equipment, the internal wiring regulations and the instruction manual for installation when conducting electrical work. Insufficient power circuit capacity and improper electrical work can cause an electrical shock or fire.	
Be sure to use the specified cable to connect between the indoor and outdoor units. Make the connections securely and route the cable properly so that there is no force pulling the cable at the connection terminals. Improper connections can cause excessive heat generation or fire.	
When connecting the cable between the indoor and outdoor units, make sure that the terminal cover does not lift off or dismount because of the cable. If the cover is not mounted properly, the terminal connection section can cause an electrical shock, excessive heat generation or fire.	
Do not damage or modify the power cable. Damaged or modified power cable can cause an electrical shock or fire. Placing heavy items on the power cable, and heating or pulling the power cable can damage the cable.	
Do not mix air or gas other than the specified refrigerant (R410A) in the refrigerant system. If air enters the refrigerating system, an excessively high pressure results, causing equipment damage and injury.	
If the refrigerant gas leaks, be sure to locate the leak and repair it before charging the refrigerant. After charging refrigerant, make sure that there is no refrigerant leak. If the leak cannot be located and the repair work must be stopped, be sure to perform pump-down and close the service valve, to prevent the refrigerant gas from leaking into the room. The refrigerant gas itself is harmless, but it can generate toxic gases when it contacts flames, such as fan and other heaters, stoves and ranges.	
When replacing the coin battery in the remote controller, be sure to disposed of the old battery to prevent children from swallowing it. If a child swallows the coin battery, see a doctor immediately.	

 Caution	
Installation of a leakage breaker is necessary in some cases depending on the conditions of the installation site, to prevent electrical shocks.	
Do not install the equipment in a place where there is a possibility of combustible gas leaks. If a combustible gas leaks and remains around the unit, it can cause a fire.	
Be sure to install the packing and seal on the installation frame properly. If the packing and seal are not installed properly, water can enter the room and wet the furniture and floor.	For integral units only

1.1.3 Inspection after Repair

 Warning	
Check to make sure that the power cable plug is not dirty or loose, then insert the plug into a power outlet all the way. If the plug has dust or loose connection, it can cause an electrical shock or fire.	
If the power cable and lead wires have scratches or deteriorated, be sure to replace them. Damaged cable and wires can cause an electrical shock, excessive heat generation or fire.	





 Warning	
Do not use a joined power cable or extension cable, or share the same power outlet with other electrical appliances, since it can cause an electrical shock, excessive heat generation or fire.	

 Caution	
Check to see if the parts and wires are mounted and connected properly, and if the connections at the soldered or crimped terminals are secure. Improper installation and connections can cause excessive heat generation, fire or an electrical shock.	
If the installation platform or frame has corroded, replace it. Corroded installation platform or frame can cause the unit to fall, resulting in injury.	
Check the grounding, and repair it if the equipment is not properly grounded. Improper grounding can cause an electrical shock.	
Be sure to measure the insulation resistance after the repair, and make sure that the resistance is 1 Mohm or higher. Faulty insulation can cause an electrical shock.	
Be sure to check the drainage of the indoor unit after the repair. Faulty drainage can cause the water to enter the room and wet the furniture and floor.	

1.1.4 Using Icons

Icons are used to attract the attention of the reader to specific information. The meaning of each icon is described in the table below:

1.1.5 Using Icons List

Icon	Type of Information	Description
 Note:	Note	A “note” provides information that is not indispensable, but may nevertheless be valuable to the reader, such as tips and tricks.
 Caution	Caution	A “caution” is used when there is danger that the reader, through incorrect manipulation, may damage equipment, lose data, get an unexpected result or has to restart (part of) a procedure.
 Warning	Warning	A “warning” is used when there is danger of personal injury.
	Reference	A “reference” guides the reader to other places in this binder or in this manual, where he/she will find additional information on a specific topic.

Part 1

List of Functions

1. Cooling Only.....	2
2. Heat Pump	5

1. Cooling Only

Category	Functions	FTKS20-35CVMB(9)(8)		Category	Functions	FTKS20-35CVMB(9)(8)	
		FTKS20-35CVMB(9)(8)	CDKS25-35CVMB			FTKS20-35CVMB(9)(8)	CDKS25-35CVMB
Basic Function	Inverter (with Inverter Power Control)	○	○	Health & Clean	Air Purifying Filter with Bacteriostatic & Virustatic Functions	—	—
	Operation Limit for Cooling (°CDB)	—	—		Photocatalytic Deodorizing Filter	—	—
	Operation Limit for Heating (°CWB)	—	—		Air Purifying Filter with Photocatalytic Deodorizing Function	○	—
	PAM Control	—	—		Longlife Filter	—	—
Compressor	Oval Scroll Compressor	—	—	Timer	Ultra-Longlife Filter (Option)	—	—
	Swing Compressor	—	—		Mould Proof Air Filter	○	○
	Rotary Compressor	—	—		Wipe-clean Flat Panel	○	—
	Reluctance DC Motor	—	—		Washable Grille	—	—
Comfortable Airflow	Power-Airflow Flap	—	—	Worry Free "Reliability & Durability"	Filter Cleaning Indicator	—	—
	Power-Airflow Dual Flaps	○	—		Good-Sleep Cooling Operation	—	—
	Power-Airflow Diffuser	—	—		24-Hour On/Off Timer	○	○
	Wide-Angle Louvers	○	—		Night Set Mode	○	○
	Vertical Auto-Swing (Up and Down)	○	—		Auto-Restart (after Power Failure)	○	○
	Horizontal Auto-Swing (Right and Left)	—	—		Self-Diagnosis (Digital, LED) Display	○★	○★
	3-D Airflow	—	—		Wiring-Error Check	—	—
3-Step Airflow (H/P Only)	—	—	Anticorrosion Treatment of Outdoor Heat Exchanger	—	—		
Comfort Control	Auto Fan Speed	○	○	Flexibility	Multi-Split / Split Type Compatible Indoor Unit	○	—
	Indoor Unit Silent Operation	○	○		Flexible Voltage Correspondence	○	○
	Night Quiet Mode (Automatic)	—	—		High Ceiling Application	—	—
	Outdoor Unit Silent Operation (Manual)	—	—		Chargeless	—	—
	Intelligent Eye	○	—	Power-Selection	—	—	
	Quick Warming Function	—	—	Remote Control	5-Rooms Centralized Controller (Option)	○	○
	Hot-Start Function	—	—		Remote Control Adaptor (Normal Open-Pulse Contact)(Option)	○	○
	Automatic Defrosting	—	—		Remote Control Adaptor (Normal Open Contact)(Option)	○	○
			DIII-NET Compatible (Adaptor)(Option)		○	○	
Operation	Automatic Operation	—	—	Remote Controller	Wireless	○	○
	Programme Dry Function	○	○		Wired	—	—
	Fan Only	○	○				
Lifestyle Convenience	New Powerful Operation (Non-Inverter)	—	—				
	Inverter Powerful Operation	○	○				
	Priority-Room Setting	—	—				
	Cooling / Heating Mode Lock	—	—				
	Home Leave Operation	○	○				
	Indoor Unit On/Off Switch	○	○				
	Signal Reception Indicator	○	○				
	Temperature Display	—	—				
Another Room Operation	—	—					

Note: ○ : Holding Functions
— : No Functions

★ : Digital Only

Category	Functions	FLKS25-35BVMB	2MKS40BVMB	Category	Functions	FLKS25-35BVMB	2MKS40BVMB	
Basic Function	Inverter (with Inverter Power Control)	○	○	Health & Clean	Air Purifying Filter with Bacteriostatic & Virustatic Functions	○	—	
	Operation Limit for Cooling (°CDB)	—	10 ~ 46		Photocatalytic Deodorizing Filter	○	—	
	Operation Limit for Heating (°CWB)	—	—		Air Purifying Filter with Photocatalytic Deodorizing Function	—	—	
	PAM Control	—	○		Longlife Filter	—	—	
Compressor	Oval Scroll Compressor	—	—		Ultra-Longlife Filter (Option)	—	—	
	Swing Compressor	—	○		Mould Proof Air Filter	○	—	
	Rotary Compressor	—	—		Wipe-clean Flat Panel	—	—	
	Reluctance DC Motor	—	○		Washable Grille	—	—	
Comfortable Airflow	Power-Airflow Flap	—	—		Filter Cleaning Indicator	—	—	
	Power-Airflow Dual Flaps	—	—		Good-Sleep Cooling Operation	—	—	
	Power-Airflow Diffuser	—	—		Timer	24-Hour On/Off Timer	○	—
	Wide-Angle Louvers	—	—			Night Set Mode	○	—
	Vertical Auto-Swing (Up and Down)	○	—	Worry Free "Reliability & Durability"	Auto-Restart (after Power Failure)	○	—	
	Horizontal Auto-Swing (Right and Left)	—	—		Self-Diagnosis (Digital, LED) Display	○★	○	
	3-D Airflow	—	—		Wiring-Error Check	—	—	
	3-Step Airflow (H/P Only)	—	—		Anticorrosion Treatment of Outdoor Heat Exchanger	—	○	
Comfort Control	Auto Fan Speed	○	—		Flexibility	Multi-Split / Split Type Compatible Indoor Unit	○	—
	Indoor Unit Silent Operation	○	—	Flexible Voltage Correspondence		○	○	
	Night Quiet Mode (Automatic)	—	—	High Ceiling Application		—	—	
	Outdoor Unit Silent Operation (Manual)	—	○	Chargeless		—	20m	
	Intelligent Eye	—	—	Power-Selection		—	○	
	Quick Warming Function	—	—	Remote Control	5-Rooms Centralized Controller (Option)	○	—	
	Hot-Start Function	—	—		Remote Control Adaptor (Normal Open-Pulse Contact)(Option)	○	—	
Operation	Automatic Defrosting	—	—	Remote Control Adaptor (Normal Open Contact)(Option)	○	—		
	Automatic Operation	—	—	DIII-NET Compatible (Adaptor)(Option)	○	—		
	Programme Dry Function	○	—	Remote Controller	Wireless	○	—	
Fan Only	○	—	Wired		—	—		
Lifestyle Convenience	New Powerful Operation (Non-Inverter)	—	—					
	Inverter Powerful Operation	○	—					
	Priority-Room Setting	—	—					
	Cooling / Heating Mode Lock	—	—					
	Home Leave Operation	○	—					
	Indoor Unit On/Off Switch	○	—					
	Signal Reception Indicator	○	—					
	Temperature Display	—	—					
Another Room Operation	—	—						

Note: ○ : Holding Functions
— : No Functions

★ : Digital Only

Category	Functions				Category	Functions			
		ATKS20-25-35DVMB	ATKS20-25-35CVMB(9)	2AMKS40BVMB			ATKS20-25-35DVMB	ATKS20-25-35CVMB(9)	2AMKS40BVMB
Basic Function	Inverter (with Inverter Power Control)	○	○	○	Health & Clean	Air Purifying Filter with Bacteriostatic & Virustatic Functions	—	—	—
	Operation Limit for Cooling (°CDB)	—	—	10 ~ 46		Photocatalytic Deodorizing Filter	—	—	—
	Operation Limit for Heating (°CWB)	—	—	—		Air Purifying Filter with Photocatalytic Deodorizing Function	○	○	—
	PAM Control	—	—	○		Longlife Filter	—	—	—
Compressor	Oval Scroll Compressor	—	—	—	Ultra-Longlife Filter (Option)	—	—	—	
	Swing Compressor	—	—	○	Mould Proof Air Filter	○	○	—	
	Rotary Compressor	—	—	—	Wipe-clean Flat Panel	○	—	—	
	Reluctance DC Motor	—	—	○	Washable Grille	—	○	—	
Comfortable Airflow	Power-Airflow Flap	—	—	—	Filter Cleaning Indicator	—	—	—	
	Power-Airflow Dual Flap	○	○	—	Good-Sleep Cooling Operation	—	—	—	
	Power-Airflow Diffuser	—	—	—	Timer	24-Hour On/Off Timer	○	○	—
	Wide-Angle Louvers	○	○	—		Night Set Mode	○	○	—
	Vertical Auto-Swing (Up and Down)	○	○	—	Worry Free "Reliability & Durability"	Auto-Restart (after Power Failure)	○	○	—
	Horizontal Auto-Swing (Right and Left)	—	—	—		Self-Diagnosis (Digital, LED) Display	○★	○★	○
	3-D Airflow	—	—	—		Wiring-Error Check	—	—	—
3-Step Airflow (H/P Only)	—	—	—	Anticorrosion Treatment of Outdoor Heat Exchanger	—	—	○		
Comfort Control	Auto Fan Speed	○	○	—	Flexibility	Multi-Split / Split Type Compatible Indoor Unit	○	○	—
	Indoor Unit Silent Operation	○	○	—		Flexible Voltage Correspondence	○	○	○
	Night Quiet Mode (Automatic)	—	—	—		High Ceiling Application	—	—	—
	Outdoor Unit Silent Operation (Manual)	—	—	○		Chargeless	—	—	20 m
	Intelligent Eye	○	○	—	Power Selection	—	—	○	
	Quick Warming Function	—	—	—	Remote Control	5-Rooms Centralized Controller (Option)	○	○	—
	Hot-Start Function	—	—	—		Remote Control Adaptor (Normal Open-Pulse Contact) (Option)	○	○	—
	Automatic Defrosting	—	—	—		Remote Control Adaptor (Normal Open Contact) (Option)	○	○	—
	—	—	—	DIII-NET Compatible (Adaptor) (Option)		○	○	—	
Operation	Automatic Operation	—	—	—	Remote Controller	Wireless	○	○	—
	Programme Dry Function	○	○	—		Wired	—	—	—
	Fan Only	○	○	—					
Lifestyle Convenience	New Powerful Operation (Non-Inverter)	—	—	—					
	Inverter Powerful Operation	○	○	—					
	Priority-Room Setting	—	—	—					
	Cooling / Heating Mode Lock	—	—	—					
	Home Leave Operation	○	○	—					
	Indoor Unit On/Off Switch	○	○	—					
	Signal Reception Indicator	○	○	—					
	Temperature Display	—	—	—					
Another Room Operation	—	—	—						

Notes: ○ : Holding Functions
— : No Functions

★ : Digital Only

2. Heat Pump

Category	Functions			Category	Functions			
		FTXS20-35CVMB(9)(8)	CDXS25-35CVMB			FTXS20-35CVMB(9)(8)	CDXS25-35CVMB	
Basic Function	Inverter (with Inverter Power Control)	○	○	Health & Clean	Air Purifying Filter with Bacteriostatic & Virustatic Functions	—	—	
	Operation Limit for Cooling (°CDB)	—	—		Photocatalytic Deodorizing Filter	—	—	
	Operation Limit for Heating (°CWB)	—	—		Air Purifying Filter with Photocatalytic Deodorizing Function	○	—	
	PAM Control	—	—		Longlife Filter	—	—	
Compressor	Oval Scroll Compressor	—	—		Ultra-Longlife Filter (Option)	—	—	
	Swing Compressor	—	—		Mould Proof Air Filter	○	○	
	Rotary Compressor	—	—		Wipe-clean Flat Panel	○	—	
	Reluctance DC Motor	—	—		Washable Grille	—	—	
Comfortable Airflow	Power-Airflow Flap	—	—		Timer	Filter Cleaning Indicator	—	—
	Power-Airflow Dual Flaps	○	—			Good-Sleep Cooling Operation	—	—
	Power-Airflow Diffuser	—	—	24-Hour On/Off Timer	○	○		
	Wide-Angle Louvers	○	—	Night Set Mode	○	○		
	Vertical Auto-Swing (Up and Down)	○	—	Worry Free "Reliability & Durability"	Auto-Restart (after Power Failure)	○	○	
	Horizontal Auto-Swing (Right and Left)	—	—		Self-Diagnosis (Digital, LED) Display	★	★	
	3-D Airflow	—	—		Wiring-Error Check	—	—	
3-Step Airflow (H/P Only)	—	—	Anticorrosion Treatment of Outdoor Heat Exchanger		—	—		
Comfort Control	Auto Fan Speed	○	○	Flexibility	Multi-Split / Split Type Compatible Indoor Unit	○	—	
	Indoor Unit Silent Operation	○	○		Flexible Voltage Correspondence	○	○	
	Night Quiet Mode (Automatic)	—	—		High Ceiling Application	—	—	
	Outdoor Unit Silent Operation (Manual)	—	—		Chargeless	—	—	
	Intelligent Eye	○	—	Power-Selection	—	—		
	Quick Warming Function	—	—	Remote Control	5-Rooms Centralized Controller (Option)	○	○	
	Hot-Start Function	○	○		Remote Control Adaptor (Normal Open-Pulse Contact)(Option)	○	○	
	Automatic Defrosting	—	—		Remote Control Adaptor (Normal Open Contact)(Option)	○	○	
			DIII-NET Compatible (Adaptor)(Option)		○	○		
Operation	Automatic Operation	○	○	Remote Controller	Wireless	○	○	
	Programme Dry Function	○	○		Wired	—	—	
	Fan Only	○	○					
Lifestyle Convenience	New Powerful Operation (Non-Inverter)	—	—					
	Inverter Powerful Operation	○	○					
	Priority-Room Setting	—	—					
	Cooling / Heating Mode Lock	—	—					
	Home Leave Operation	○	○					
	Indoor Unit On/Off Switch	○	○					
	Signal Reception Indicator	○	○					
	Temperature Display	—	—					
Another Room Operation	—	—						

Notes: ○ : Holding Functions
— : No Functions

★ : Digital Only

Category	Functions	FLXS25-60BVMB	2MXS40BVMB	Category	Functions	FLXS25-60BVMB	2MXS40BVMB
Basic Function	Inverter (with Inverter Power Control)	○	○	Health & Clean	Air Purifying Filter with Bacteriostatic & Virustatic Functions	○	—
	Operation Limit for Cooling (°CDB)	—	10 ~ 46		Photocatalytic Deodorizing Filter	○	—
	Operation Limit for Heating (°CWB)	—	-10 ~ 15.5		Air Purifying Filter with Photocatalytic Deodorizing Function	—	—
	PAM Control	—	○		Longlife Filter	—	—
Compressor	Oval Scroll Compressor	—	—	Ultra-Longlife Filter (Option)	—	—	
	Swing Compressor	—	○	Mould Proof Air Filter	○	—	
	Rotary Compressor	—	—	Wipe-clean Flat Panel	—	—	
	Reluctance DC Motor	—	○	Washable Grille	—	—	
Comfortable Airflow	Power-Airflow Flap	—	—	Filter Cleaning Indicator	—	—	
	Power-Airflow Dual Flaps	—	—	Good-Sleep Cooling Operation	—	—	
	Power-Airflow Diffuser	—	—	Timer	24-Hour On/Off Timer	○	—
	Wide-Angle Louvers	—	—		Night Set Mode	○	—
	Vertical Auto-Swing (Up and Down)	○	—	Worry Free "Reliability & Durability"	Auto-Restart (after Power Failure)	○	—
	Horizontal Auto-Swing (Right and Left)	—	—		Self-Diagnosis (Digital, LED) Display	○ ★	○
	3-D Airflow	—	—		Wiring-Error Check	—	—
	3-Step Airflow (H/P Only)	—	—		Anticorrosion Treatment of Outdoor Heat Exchanger	—	○
Comfort Control	Auto Fan Speed	○	—	Flexibility	Multi-Split / Split Type Compatible Indoor Unit	○	—
	Indoor Unit Silent Operation	○	—		Flexible Voltage Correspondence	○	○
	Night Quiet Mode (Automatic)	—	—		High Ceiling Application	—	—
	Outdoor Unit Silent Operation (Manual)	—	○		Chargeless	—	20m
	Intelligent Eye	—	—		Power-Selection	—	—
	Quick Warming Function	—	○	Remote Control	5-Rooms Centralized Controller (Option)	○	—
	Hot-Start Function	○	—		Remote Control Adaptor (Normal Open-Pulse Contact)(Option)	○	—
	Automatic Defrosting	—	○		Remote Control Adaptor (Normal Open Contact)(Option)	○	—
Operation	Automatic Operation	○	—	Remote Controller	DIII-NET Compatible (Adaptor)(Option)	○	—
	Programme Dry Function	○	—		Wireless	○	—
	Fan Only	○	—		Wired	—	—
Lifestyle Convenience	New Powerful Operation (Non-Inverter)	—	—				
	Inverter Powerful Operation	○	—				
	Priority-Room Setting	—	—				
	Cooling / Heating Mode Lock	—	—				
	Home Leave Operation	○	—				
	Indoor Unit On/Off Switch	○	—				
	Signal Reception Indicator	○	—				
	Temperature Display	—	—				
Another Room Operation	—	—					

Notes: ○ : Holding Functions
— : No Functions

★ : Digital Only

Category	Functions	ATXS20:25:35DVMB	ATXS20:25:35CVMB(9)	2AMXS40BVMB	Category	Functions	ATXS20:25:35DVMB	ATXS20:25:35CVMB(9)	2AMXS40BVMB
Basic Function	Inverter (with Inverter Power Control)	○	○	○	Health & Clean	Air Purifying Filter with Bacteriostatic & Virustatic Functions	—	—	—
	Operation Limit for Cooling (°CDB)	—	—	10 ~ 46		Photocatalytic Deodorizing Filter	—	—	—
	Operation Limit for Heating (°CWB)	—	—	-10 ~ 15.5		Air Purifying Filter with Photocatalytic Deodorizing Function	○	○	—
	PAM Control	—	—	○		Longlife Filter	—	—	—
Compressor	Oval Scroll Compressor	—	—	—	Ultra-Longlife Filter (Option)	—	—	—	
	Swing Compressor	—	—	○	Mould Proof Air Filter	○	○	—	
	Rotary Compressor	—	—	—	Wipe-clean Flat Panel	○	—	—	
	Reluctance DC Motor	—	—	○	Washable Grille	—	○	—	
Comfortable Airflow	Power Airflow Flap	—	—	—	Filter Cleaning Indicator	—	—	—	
	Power-Airflow Dual Flaps	○	○	—	Good-Sleep Cooling Operation	—	—	—	
	Power-Airflow Diffuser	—	—	—	Timer	24-Hour On/Off Timer	○	○	—
	Wide-Angle Louvers	○	○	—		Night Set Mode	○	○	—
	Vertical Auto-Swing (Up and Down)	○	○	—	Worry Free "Reliability & Durability"	Auto-Restart (after Power Failure)	○	○	—
	Horizontal Auto-Swing (Right and Left)	—	—	—		Self-Diagnosis (Digital, LED) Display	○★	○★	○
	3-D Airflow	—	—	—		Wiring-Error Check	—	—	—
	3-Step Airflow (H/P Only)	—	—	—		Anticorrosion Treatment of Outdoor Heat Exchanger	—	—	○
Comfort Control	Auto Fan Speed	○	○	—	Flexibility	Multi-Split / Split Type Compatible Indoor Unit	○	○	—
	Indoor Unit Silent Operation	○	○	—		Flexible Voltage Correspondence	○	○	○
	Night Quiet Mode (Automatic)	—	—	—		High Ceiling Application	—	—	—
	Outdoor Unit Silent Operation (Manual)	—	—	○		Chargeless	—	—	20m
	Intelligent Eye	○	○	—	Remote Control	Power Selection	—	—	—
	Quick Warming Function	—	—	○		5-Rooms Centralized Controller (Option)	○	○	—
	Hot-Start Function	○	○	—		Remote Control Adaptor (Normal Open-Pulse Contact) (Option)	○	○	—
	Automatic Defrosting	—	—	○		Remote Control Adaptor (Normal Open Contact) (Option)	○	○	—
Operation	Automatic Operation	○	○	—	Remote Controller	DIII-NET Compatible (Adaptor) (Option)	○	○	—
	Programme Dry Function	○	○	—		Wireless	○	○	—
	Fan Only	○	○	—		Wired	—	—	—
Lifestyle Convenience	New Powerful Operation (Non-Inverter)	—	—	—					
	Inverter Powerful Operation	○	○	—					
	Priority-Room Setting	—	—	—					
	Cooling / Heating Mode Lock	—	—	—					
	Home Leave Operation	○	○	—					
	Indoor Unit On/Off Switch	○	○	—					
	Signal Reception Indicator	○	○	—					
	Temperature Display	—	—	—					
Another Room Operation	—	—	—						

Notes: ○ : Holding Functions
 — : No Functions

★ : Digital Only

Part 2 Specifications

1. Cooling Only.....	10
1.1 Indoor Units.....	10
1.2 Outdoor Units.....	14
2. Heat Pump.....	15
2.1 Indoor Units.....	15
2.2 Outdoor Units.....	19

1. Cooling Only

1.1 Indoor Units

Wall Mounted Type

230V, 50Hz

Model			FTKS20CVMB(9)	FTKS25CVMB(9)(8)
Rated Capacity ★			2.0kW Class	2.5kW Class
Front Panel Color			White	White
Air Flow Rates	m ³ /min (cfm)	H	7.7 (272)	7.7 (272)
		M	5.9 (208)	5.9 (208)
		L	4.2 (148)	4.2 (148)
		SL	3.6 (127)	3.6 (127)
Fan	Type	Cross Flow Fan		Cross Flow Fan
	Motor Output	W	18	18
	Speed	Steps	5 Steps, Silent, Auto	5 Steps, Silent, Auto
Air Direction Control			Right, Left, Horizontal, Downward	Right, Left, Horizontal, Downward
Air Filter			Removable-Washable-Mildew Proof	Removable-Washable-Mildew Proof
Running Current (Rated)		A	0.18	0.18
Power Consumption (Rated)		W	40	40
Power Factor		%	96.6	96.6
Temperature Control			Microcomputer Control	Microcomputer Control
Dimensions (HxWxD)		mm	273x784x195	273x784x195
Packaged Dimensions (WxDxH)		mm	834x325x258	834x325x258
Weight		kg	7.5	7.5
Gross Weight		kg	11	11
Operation Sound	H/M/L/SL	dBA	38/32/25/22	38/32/25/22
Sound Power	H	dBA	56	56
Heat Insulation			Both Liquid and Gas Pipes	Both Liquid and Gas Pipes
Piping Connection	Liquid	mm	φ 6.4	φ 6.4
	Gas	mm	φ 9.5	φ 9.5
	Drain	mm	φ18.0	φ18.0
Drawing No.			3D044242B	3D044243B

Model			FTKS35CVMB(9)(8)
Rated Capacity ★			3.5kW Class
Front Panel Color			White
Air Flow Rates	m ³ /min (cfm)	H	7.7 (272)
		M	6.0 (212)
		L	4.4 (155)
		SL	3.8 (134)
Fan	Type	Cross Flow Fan	
	Motor Output	W	18
	Speed	Steps	5 Steps, Silent, Auto
Air Direction Control			Right, Left, Horizontal, Downward
Air Filter			Removable-Washable-Mildew Proof
Running Current (Rated)		A	0.18
Power Consumption (Rated)		W	40
Power Factor		%	96.6
Temperature Control			Microcomputer Control
Dimensions (HxWxD)		mm	273x784x195
Packaged Dimensions (WxDxH)		mm	834x325x258
Weight		kg	7.5
Gross Weight		kg	11
Operation Sound	H/M/L/SL	dBA	39/33/26/23
Sound Power	H	dBA	57
Heat Insulation			Both Liquid and Gas Pipes
Piping Connection	Liquid	mm	φ 6.4
	Gas	mm	φ 9.5
	Drain	mm	φ18.0
Drawing No.			3D044244B

★ See page 14 "Combination Capacity"

Conversion Formulae
kcal/h=kW×860
Btu/h=kW×3414
cfm=m ³ /min×35.3

230V, 50Hz

Model			ATKS20CVMB(9)	ATKS25CVMB(9)		
Rated Capacity ★			2.0kW Class	2.5kW Class		
Front Panel Color			White	White		
Air Flow Rates	m ³ /min (cfm)	H	7.7 (272)	7.7 (272)		
		M	5.9 (208)	5.9 (208)		
		L	4.2 (148)	4.2 (148)		
		SL	3.6 (127)	3.6 (127)		
Fan	Type	Cross Flow Fan		Cross Flow Fan		
	Motor Output	W	18	18		
	Speed	Steps	5 Steps, Silent, Auto	5 Steps, Silent, Auto		
Air Direction Control			Right, Left, Horizontal, Downward	Right, Left, Horizontal, Downward		
Air Filter			Removable-Washable-Mildew Proof	Removable-Washable-Mildew Proof		
Running Current (Rated)			A	0.18		
Power Consumption (Rated)			W	40		
Power Factor			%	96.6		
Temperature Control			Microcomputer Control	Microcomputer Control		
Dimensions (HxWxD)			mm	273x784x185		
Packaged Dimension (WxDxH)			mm	834x325x258		
Weight			kg	7.5		
Gross Weight			kg	11		
Operation Sound	dBA	H	38	38		
		M	32	32		
		L	25	25		
		SL	22	22		
Sound Power			dBA	H	56	56
Heat Insulation			Both Liquid and Gas Pipes			
Piping Connection	Liquid	mm	φ 6.4	φ 6.4		
	Gas	mm	φ 9.5	φ 9.5		
	Drain	mm	φ18.0	φ18.0		
Drawing No.			3D044248B	3D044249B		

Model			ATKS35CVMB(9)		
Rated Capacity ★			3.5kW Class		
Front Panel Color			White		
Air Flow Rates	m ³ /min (cfm)	H	7.7 (272)		
		M	6.1 (215)		
		L	4.4 (155)		
		SL	3.8 (134)		
Fan	Type	Cross Flow Fan			
	Motor Output	W	18		
	Speed	Steps	5 Steps, Silent, Auto		
Air Direction Control			Right, Left, Horizontal, Downward		
Air Filter			Removable-Washable-Mildew Proof		
Running Current (Rated)			A	0.18	
Power Consumption (Rated)			W	40	
Power Factor			%	96.6	
Temperature Control			Microcomputer Control		
Dimensions (HxWxD)			mm	273x784x185	
Packaged Dimension (WxDxH)			mm	834x325x258	
Weight			kg	7.5	
Gross Weight			kg	11	
Operation Sound	dBA	H	39		
		M	33		
		L	26		
		SL	23		
Sound Power			dBA	H	57
Heat Insulation			Both Liquid and Gas Pipes		
Piping Connection	Liquid	mm	φ 6.4	φ 6.4	
	Gas	mm	φ 9.5	φ 9.5	
	Drain	mm	φ18.0	φ18.0	
Drawing No.			3D044250B		

★ See page 14 "Combination Capacity"

Conversion Formulae

kcal/h=kW×860

Btu/h=kW×3414

cfm=m³/min×35.3

230V, 50Hz

Model			ATKS20DVMB	ATKS25DVMB
Rated Capacity ★			2.0kW Class	2.5kW Class
Front Panel Color			White	White
Air Flow Rates	m ³ /min (cfm)	H	7.7 (272)	7.7 (272)
		M	5.9 (208)	5.9 (208)
		L	4.2 (148)	4.2 (148)
		SL	3.6 (127)	3.6 (127)
Fan	Type	Cross Flow Fan		Cross Flow Fan
	Motor Output	W	18	18
	Speed	Steps	5 Steps, Silent, Auto	5 Steps, Silent, Auto
Air Direction Control			Right, Left, Horizontal, Downward	Right, Left, Horizontal, Downward
Air Filter			Removable-Washable-Mildew Proof	Removable-Washable-Mildew Proof
Running Current (Rated)		A	0.18	0.18
Power Consumption (Rated)		W	40	40
Power Factor		%	96.6	96.6
Temperature Control			Microcomputer Control	Microcomputer Control
Dimensions (HxWxD)		mm	273x784x195	273x784x195
Packaged Dimension (WxDxH)		mm	834x325x258	834x325x258
Weight		kg	7.5	7.5
Gross Weight		kg	11	11
Operation Sound	dBA	H	38	38
		M	32	32
		L	25	25
		SL	22	22
Sound Power		dBA	56	56
Heat Insulation			Both Liquid and Gas Pipes	Both Liquid and Gas Pipes
Piping Connection	Liquid	mm	φ 6.4	φ 6.4
	Gas	mm	φ 9.5	φ 9.5
	Drain	mm	φ18.0	φ18.0
Drawing No.			3D048480	3D048481

Model			ATKS35DVMB
Rated Capacity ★			3.5kW Class
Front Panel Color			White
Air Flow Rates	m ³ /min (cfm)	H	7.7 (272)
		M	6.1 (212)
		L	4.4 (155)
		SL	3.8 (134)
Fan	Type	Cross Flow Fan	
	Motor Output	W	18
	Speed	Steps	5 Steps, Silent, Auto
Air Direction Control			Right, Left, Horizontal, Downward
Air Filter			Removable-Washable-Mildew Proof
Running Current (Rated)		A	0.18
Power Consumption (Rated)		W	40
Power Factor		%	96.6
Temperature Control			Microcomputer Control
Dimensions (HxWxD)		mm	273x784x195
Packaged Dimension (WxDxH)		mm	834x325x258
Weight		kg	7.5
Gross Weight		kg	11
Operation Sound	dBA	H	39
		M	33
		L	26
		SL	23
Sound Power		dBA	57
Heat Insulation			Both Liquid and Gas Pipes
Piping Connection	Liquid	mm	φ 6.4
	Gas	mm	φ 9.5
	Drain	mm	φ18.0
Drawing No.			3D048482

★ See page 14 "Combination Capacity"

Conversion Formulae

$$\begin{aligned} \text{kcal/h} &= \text{kW} \times 860 \\ \text{Btu/h} &= \text{kW} \times 3414 \\ \text{cfm} &= \text{m}^3/\text{min} \times 35.3 \end{aligned}$$

Duct Connected Type

230V, 50Hz

Model			CDKS25CVMB	CDKS35CVMB
Rated Capacity ★			2.5kW Class	3.5kW Class
Front Panel Color			—	—
Air Flow Rates	m ³ /min (cfm)	H	9.5 (335)	10.0 (353)
		M	8.8 (311)	9.3 (328)
		L	8.0 (282)	8.5 (300)
		SL	6.7 (237)	7.0 (247)
Fan	Type	Sirocco Fan		Sirocco Fan
	Motor Output	W	62	62
	Speed	Steps	5 Steps, Silent, Auto	5 Steps, Silent, Auto
Air Filter			Removable-Washable-Mildew Proof	Removable-Washable-Mildew Proof
Running Current (Rated)		A	0.47	0.47
Power Consumption (Rated)		W	100	100
Power Factor		%	92.5	92.5
Temperature Control			Microcomputer Control	Microcomputer Control
Dimensions (HxWxD)		mm	200x900x620	200x900x620
Packaged Dimensions (WxDxH)		mm	1,106x751x266	1,106x751x266
Weight		kg	25	25
Gross Weight		kg	31	31
Operation Sound	H/M/L/SL	dBA	35/33/31/29	35/33/31/29
External Static Pressure		Pa	40	40
Heat Insulation			Both Liquid and Gas Pipes	Both Liquid and Gas Pipes
Piping Connection	Liquid	mm	φ 6.4	φ 6.4
	Gas	mm	φ 9.5	φ 9.5
	Drain	mm	VP20 (O.D. φ 26 / I.D. φ 20)	VP20 (O.D. φ 26 / I.D. φ 20)
Drawing No.			3D046065A	3D046066A

Notes: The operating sound is based on the rear side suction inlet and the external static pressure 40 Pa.
 Operating sound for under side suction inlet:[operating sound for rear side suction inlet]+5 dB.
 However, when installation to which the external static pressure becomes low is carried out,
 5 dB or more may go up.

Floor / Ceiling Suspended Dual Type

230V, 50Hz

Model			FLKS25BVMB	FLKS35BVMB
Rated Capacity ★			2.5kW Class	3.5kW Class
Front Panel Color			Almond White	Almond White
Air Flow Rates	m ³ /min (cfm)	H	7.6 (268)	8.6 (304)
		M	6.8 (240)	7.6 (268)
		L	6.0 (212)	6.6 (233)
		SL	5.2 (184)	5.6 (198)
Fan	Type	Sirocco Fan		Sirocco Fan
	Motor Output	W	34	34
	Speed	Steps	5 Steps, Silent, Auto	5 Steps, Silent, Auto
Air Direction Control			Right, Left, Horizontal, Downward	Right, Left, Horizontal, Downward
Air Filter			Removable-Washable-Mildew Proof	Removable-Washable-Mildew Proof
Running Current (Rated)		A	0.34	0.36
Power Consumption (Rated)		W	74	78
Power Factor		%	94.6	94.2
Temperature Control			Microcomputer Control	Microcomputer Control
Dimensions (HxWxD)		mm	490x1,050x200	490x1,050x200
Packaged Dimensions (WxDxH)		mm	1,100x566x280	1,100x566x280
Weight		kg	16	16
Gross Weight		kg	22	22
Operation Sound	H/M/L/SL	dBA	37/34/31/28	38/35/32/29
Sound Power	H	dBA	53	54
Heat Insulation			Both Liquid and Gas Pipes	Both Liquid and Gas Pipes
Piping Connection	Liquid	mm	φ 6.4	φ 6.4
	Gas	mm	φ 9.5	φ 9.5
	Drain	mm	φ18.0	φ18.0
Drawing No.			3D040166A	3D040167A

★ See page 14 "Combination Capacity"

Conversion Formulae
kcal/h=kW×860
Btu/h=kW×3414
cfm=m ³ /min×35.3

1.2 Outdoor Units

230V, 50Hz

Model			2MKS40BVMB	2AMKS40BVMB
Cooling Capacity ★		kW	—	
Power Consumption ★		W	—	
Running Current ★		A	—	
Casing Color			Ivory White	
Compressor	Type		Hermetically Sealed Swing Type	
	Model		1YC23GXD	
	Motor Output	W	600	
Refrigerant Oil	Model		FVC50K	
	Charge	L	0.40	
Refrigerant	Type		R410A	
	Charge	kg	0.98	
Air Flow Rate	m ³ /min	HH	39	
		H	35	
		L	30	
	cfm	HH	1126	
		H	1010	
		L	866	
Fan	Type		Propeller	
	Motor Output	W	50	
Starting Current		A	5.6	
Dimension (H×W×D)		mm	640×685×285	
Packaged Dimension (W×D×H)		mm	800×366×676	
Weight		kg	39	
Gross Weight		kg	42	
Operation Sound	Sound pressure	dBA	47	
	Silent Mode	dBA	43	
Sound Power		dBA	62	
Piping Connection	Liquid	mm	φ 6.4×2	
	Gas	mm	φ 9.5×2	
	Drain	mm	φ 18	
Heat Insulation			Both Liquid & Gas Pipes	
No. of Wiring Connection			3 for Power Supply, 4 for Interunit Wiring	
Max. Piping Length		m	30 (for Total of Each Room) 20 (for One Room)	
Min. Piping Length		m	1.5 (for One Room)	
Amount of Additional Charge		g/m	20 (20m or more)	
Max. Installation Height Difference			15 (between Indoor Unit and Outdoor Unit)	
			7.5 (between Indoor Units)	
Drawing No.			3D040484	3D040485

Notes:

- ★See "Combination Capacity".
- The data are based on the conditions shows in the table below.

Cooling	Piping Length
Indoor ; 27°CDB/19°CWB Outdoor ; 35°CDB	7.5m

Conversion Formulae

kcal/h=kW×860
Btu/h=kW×3414
cfm=m³/min×35.3

Combination Capacity Cooling [230V]

50Hz

Combination of Indoor Unit	Each Capacity (kW)				Total Capacity (kW)		Total Input (W)		Total Current (A)		Power Factor (%)
	A room	B room	—	—	Rating	(min~max)	Rating	(min~max)	Rating	(min~max)	Rating
2.0	2.00	—	—	—	2.00	1.20~2.40	605	340~740	2.8	1.9~3.4	94
2.5	2.50	—	—	—	2.50	1.20~3.00	755	340~1020	3.5	1.9~4.7	94
3.5	3.15	—	—	—	3.15	1.20~3.60	1120	340~1440	5.1	1.9~6.5	95
2.0+2.0	1.90	1.90	—	—	3.80	1.50~4.10	1185	400~1455	5.5	2.2~6.7	94
2.0+2.5	1.80	2.10	—	—	3.90	1.50~4.10	1215	400~1455	5.6	2.2~6.7	94
2.0+3.5	1.70	2.20	—	—	3.90	1.50~4.20	1215	400~1490	5.6	2.2~6.8	94
2.5+2.5	1.95	1.95	—	—	3.90	1.50~4.20	1215	400~1490	5.6	2.2~6.8	94
2.5+3.5	1.75	2.15	—	—	3.90	1.50~4.20	1215	400~1490	5.6	2.2~6.8	94

Note: Cooling capacity is based on 27°CDB/19°CWB (Indoor temperature), 35°CDB (Outdoor temperature).

2. Heat Pump

2.1 Indoor Units

Wall Mounted Type

230V, 50Hz

Model			FTXS20CVMB(9)		FTXS25CVMB(9)(8)	
			Cooling	Heating	Cooling	Heating
Rated Capacity ★			2.5kW Class		2.5kW Class	
Front Panel Color			White			
Air Flow Rates	m ³ /min (cfm)	H	7.7 (272)	7.8 (275)	7.7 (272)	7.8 (275)
		M	5.9 (208)	6.5 (230)	5.9 (208)	6.5 (230)
		L	4.2 (148)	5.3 (187)	4.2 (148)	5.3 (187)
		SL	3.6 (127)	4.6 (162)	3.6 (127)	4.6 (162)
Fan	Type	Cross Flow Fan				
	Motor Output	W	18			
	Speed	Steps	5 Steps, Silent, Auto			
Air Direction Control			Right, Left, Horizontal, Downward		Right, Left, Horizontal, Downward	
Air Filter			Removable-Washable-Mildew Proof			
Running Current (Rated)		A	0.18	0.18	0.18	0.18
Power Consumption (Rated)		W	40	40	40	40
Power Factor		%	96.6	96.6	96.6	96.6
Temperature Control			Microcomputer Control			
Dimensions (HxWxD)		mm	273x784x195		273x784x195	
Packaged Dimensions (WxDxH)		mm	834x325x258		834x325x258	
Weight		kg	7.5			
Gross Weight		kg	11			
Operation Sound	H/M/L/SL	dBA	38/32/25/22	38/33/28/25	38/32/25/22	38/33/28/25
Sound Power	H	dBA	56	56	56	56
Heat Insulation			Both Liquid and Gas Pipes			
Piping Connection	Liquid	mm	φ 6.4		φ 6.4	
	Gas	mm	φ 9.5		φ 9.5	
	Drain	mm	φ18.0		φ18.0	
Drawing No.			3D044245B		3D044246B	

Model			FTXS35CVMB(9)(8)		
			Cooling	Heating	
Rated Capacity ★			3.5kW Class		
Front Panel Color			White		
Air Flow Rates	m ³ /min (cfm)	H	7.7 (272)	8.1 (286)	
		M	6.0 (212)	6.7 (237)	
		L	4.4 (155)	5.3 (187)	
		SL	3.8 (134)	4.6 (162)	
Fan	Type	Cross Flow Fan			
	Motor Output	W	18		
	Speed	Steps	5 Steps, Silent, Auto		
Air Direction Control			Right, Left, Horizontal, Downward		
Air Filter			Removable-Washable-Mildew Proof		
Running Current (Rated)		A	0.18	0.18	
Power Consumption (Rated)		W	40	40	
Power Factor		%	96.6	96.6	
Temperature Control			Microcomputer Control		
Dimensions (HxWxD)		mm	273x784x195		
Packaged Dimensions (WxDxH)		mm	834x325x258		
Weight		kg	7.5		
Gross Weight		kg	11		
Operation Sound	H/M/L/SL	dBA	39/33/26/23	39/34/29/26	
Sound Power	H	dBA	57	57	
Heat Insulation			Both Liquid and Gas Pipes		
Piping Connection	Liquid	mm	φ 6.4		
	Gas	mm	φ 9.5		
	Drain	mm	φ18.0		
Drawing No.			3D044247B		

★ See page 20 "Combination Capacity"

Conversion Formulae

kcal/h=kW×860
 Btu/h=kW×3414
 cfm=m³/min×35.3

230V, 50Hz

Model			ATXS20CVMB(9)				ATXS25CVMB(9)			
			Cooling		Heating		Cooling		Heating	
Rated Capacity ★			2.0kW Class				2.5kW Class			
Front Panel Color			White				White			
Air Flow Rates		m ³ /min (cfm)	H	7.7 (272)	7.8 (275)	7.7 (272)	7.8 (275)			
			M	5.9 (208)	6.5 (230)	5.9 (208)	6.5 (230)			
			L	4.2 (148)	5.3 (187)	4.2 (148)	5.3 (187)			
			SL	3.6 (127)	4.6 (162)	3.6 (127)	4.6 (162)			
Fan	Type	Cross Flow Fan				Cross Flow Fan				
	Motor Output	W	18				18			
	Speed	Steps	5 Steps, Silent, Auto				5 Steps, Silent, Auto			
Air Direction Control			Right, Left, Horizontal, Downward				Right, Left, Horizontal, Downward			
Air Filter			Removable-Washable-Mildew Proof				Removable-Washable-Mildew Proof			
Running Current (Rated)		A	0.18	0.18	0.18	0.18				
Power Consumption (Rated)		W	40	40	40	40				
Power Factor		%	96.6	96.6	96.6	96.6				
Temperature Control			Microcomputer Control				Microcomputer Control			
Dimensions (HxWxD)		mm	273x784x185				273x784x185			
Packaged Dimension (WxDxH)		mm	834x325x258				834x325x258			
Weight		kg	7.5				7.5			
Gross Weight		kg	11				11			
Operation Sound		dBA	H	38	38	38	38			
			M	32	33	32	33			
			L	25	28	25	28			
			SL	22	25	22	25			
Sound Power		dBA	H	56	56	56	56			
Heat Insulation			Both Liquid and Gas Pipes				Both Liquid and Gas Pipes			
Piping Connection		Liquid	mm	φ 6.4		φ 6.4				
		Gas	mm	φ 9.5		φ 9.5				
		Drain	mm	φ18.0		φ18.0				
Drawing No.			3D044251B				3D044252B			

Model			ATXS35CVMB(9)			
			Cooling		Heating	
Rated Capacity ★			3.5kW Class			
Front Panel Color			White			
Air Flow Rates		m ³ /min (cfm)	H	7.7 (272)	8.1 (286)	
			M	6.1 (215)	6.7 (237)	
			L	4.4 (155)	5.3 (187)	
			SL	3.8 (134)	4.6 (162)	
Fan	Type	Cross Flow Fan				
	Motor Output	W	18			
	Speed	Steps	5 Steps, Silent, Auto			
Air Direction Control			Right, Left, Horizontal, Downward			
Air Filter			Removable-Washable-Mildew Proof			
Running Current (Rated)		A	0.18	0.18		
Power Consumption (Rated)		W	40	40		
Power Factor		%	96.6	96.6		
Temperature Control			Microcomputer Control			
Dimensions (HxWxD)		mm	273x784x185			
Packaged Dimension (WxDxH)		mm	834x325x258			
Weight		kg	7.5			
Gross Weight		kg	11			
Operation Sound		dBA	H	39	39	
			M	33	34	
			L	26	29	
			SL	23	26	
Sound Power		dBA	H	57	57	
Heat Insulation			Both Liquid and Gas Pipes			
Piping Connection		Liquid	mm	φ 6.4		
		Gas	mm	φ 9.5		
		Drain	mm	φ18.0		
Drawing No.			3D044253B			

★ See page 20 "Combination Capacity"

Conversion Formulae
kcal/h=kW×860
Btu/h=kW×3414
cfm=m ³ /min×35.3

230V, 50Hz

Model			ATXS20DVMB		ATXS25DVMB	
			Cooling	Heating	Cooling	Heating
Rated Capacity ★			2.0kW Class		2.5kW Class	
Front Panel Color			White			
Air Flow Rates	m ³ /min (cfm)	H	7.7 (272)	7.8 (275)	7.7 (272)	7.8 (275)
		M	5.9 (208)	6.5 (230)	5.9 (208)	6.5 (230)
		L	4.2 (148)	5.3 (187)	4.2 (148)	5.3 (187)
		SL	3.6 (127)	4.6 (162)	3.6 (127)	4.6 (162)
Fan	Type	Cross Flow Fan				
	Motor Output	W	18			
	Speed	Steps	5 Steps, Silent, Auto			
Air Direction Control			Right, Left, Horizontal, Downward		Right, Left, Horizontal, Downward	
Air Filter			Removable-Washable-Mildew Proof		Removable-Washable-Mildew Proof	
Running Current (Rated)		A	0.18	0.18	0.18	0.18
Power Consumption (Rated)		W	40	40	40	40
Power Factor		%	96.6	96.6	96.6	96.6
Temperature Control			Microcomputer Control		Microcomputer Control	
Dimensions (HxWxD)		mm	273x784x185		273x784x195	
Packaged Dimension (WxDxH)		mm	834x325x258			
Weight		kg	7.5			
Gross Weight		kg	11			
Operation Sound	dBA	H	38	38	38	38
		M	32	33	32	33
		L	25	28	25	28
		SL	22	25	22	25
Sound Power	dBA	H	56	56	56	56
Heat Insulation			Both Liquid and Gas Pipes		Both Liquid and Gas Pipes	
Piping Connection	Liquid	mm	φ 6.4		φ 6.4	
	Gas	mm	φ 9.5		φ 9.5	
	Drain	mm	φ18.0		φ18.0	
Drawing No.			3D048474		3D048475	

Model			ATXS35DVMB		
			Cooling	Heating	
Rated Capacity ★			3.5kW Class		
Front Panel Color			White		
Air Flow Rates	m ³ /min (cfm)	H	7.7 (272)	8.1 (286)	
		M	6.1 (212)	6.7 (237)	
		L	4.4 (155)	5.3 (187)	
		SL	3.8 (134)	4.6 (162)	
Fan	Type	Cross Flow Fan			
	Motor Output	W	18		
	Speed	Steps	5 Steps, Silent, Auto		
Air Direction Control			Right, Left, Horizontal, Downward		
Air Filter			Removable-Washable-Mildew Proof		
Running Current (Rated)		A	0.18	0.18	
Power Consumption (Rated)		W	40	40	
Power Factor		%	96.6	96.6	
Temperature Control			Microcomputer Control		
Dimensions (HxWxD)		mm	273x784x195		
Packaged Dimension (WxDxH)		mm	834x325x258		
Weight		kg	7.5		
Gross Weight		kg	11		
Operation Sound	dBA	H	39	39	
		M	33	34	
		L	26	29	
		SL	23	26	
Sound Power	dBA	H	57	57	
Heat Insulation			Both Liquid and Gas Pipes		
Piping Connection	Liquid	mm	φ 6.4		
	Gas	mm	φ 9.5		
	Drain	mm	φ18.0		
Drawing No.			3D048476		

★ See page 20 "Combination Capacity"

Conversion Formulae
kcal/h=kWx860
Btu/h=kWx3414
cfm=m ³ /minx35.3

Duct Connected Type

230V, 50Hz

Model			CDXS25CVMB		CDXS35CVMB	
			Cooling	Heating	Cooling	Heating
Rated Capacity ★			2.5kW Class		3.5kW Class	
Front Panel Color			—		—	
Air Flow Rates	m ³ /min (cfm)	H	9.5 (335)	9.5 (335)	10.0 (353)	10.0 (353)
		M	8.8 (311)	8.8 (311)	9.3 (328)	9.3 (328)
		L	8.0 (282)	8.0 (282)	8.5 (300)	8.5 (300)
		SL	6.7 (237)	6.7 (237)	7.0 (247)	7.0 (247)
Fan	Type	Sirocco Fan		Sirocco Fan		
	Motor Output	W	62		62	
	Speed	Steps	5 Steps, Silent, Auto		5 Steps, Silent, Auto	
Air Filter			Removable-Washable-Mildew Proof		Removable-Washable-Mildew Proof	
Running Current (Rated)		A	0.47	0.47	0.47	0.47
Power Consumption (Rated)		W	100	100	100	100
Power Factor		%	92.5	92.5	92.5	92.5
Temperature Control			Microcomputer Control		Microcomputer Control	
Dimensions (HxWxD)		mm	200×900×620		200×900×620	
Packaged Dimensions (WxDxH)		mm	1,106×751×266		1,106×751×266	
Weight		kg	25		25	
Gross Weight		kg	31		31	
Operation Sound	H/M/L/SL	dBA	35/33/31/29	35/33/31/29	35/33/31/29	35/33/31/29
External Static Pressure		Pa	40		40	
Heat Insulation			Both Liquid and Gas Pipes		Both Liquid and Gas Pipes	
Piping Connection	Liquid	mm	φ 6.4		φ 6.4	
	Gas	mm	φ 9.5		φ 9.5	
	Drain	mm	VP20 (O.D. φ 26 / I.D. φ 20)		VP20 (O.D. φ 26 / I.D. φ 20)	
Drawing No.			3D046061A		3D046062A	

Notes: The operating sound is based on the rear side suction inlet and the external static pressure 40 Pa.
 Operating sound for under side suction inlet:[operating sound for rear side suction inlet]+5 dB.
 However, when installation to which the external static pressure becomes low is carried out,
 5 dB or more may go up.

Floor / Ceiling Suspended Dual Type

230V, 50Hz

Model			FLXS25BVMB		FLXS35BVMB	
			Cooling	Heating	Cooling	Heating
Rated Capacity ★			2.5kW Class		3.5kW Class	
Front Panel Color			Almond White		Almond White	
Air Flow Rates	m ³ /min (cfm)	H	7.6 (268)	9.2 (325)	8.6 (304)	9.8 (346)
		M	6.8 (240)	8.3 (293)	7.6 (268)	8.9 (314)
		L	6.0 (212)	7.4 (261)	6.6 (233)	8.0 (282)
		SL	5.2 (184)	6.6 (233)	5.6 (198)	7.2 (254)
Fan	Type	Sirocco Fan		Sirocco Fan		
	Motor Output	W	34		34	
	Speed	Steps	5 Steps, Silent, Auto		5 Steps, Silent, Auto	
Air Direction Control			Right, Left, Horizontal, Downward		Right, Left, Horizontal, Downward	
Air Filter			Removable-Washable-Mildew Proof		Removable-Washable-Mildew Proof	
Running Current (Rated)		A	0.32	0.34	0.36	0.36
Power Consumption (Rated)		W	70	74	78	78
Power Factor		%	95.1	94.6	94.2	94.2
Temperature Control			Microcomputer Control		Microcomputer Control	
Dimensions (HxWxD)		mm	490×1,050×200		490×1,050×200	
Packaged Dimensions (WxDxH)		mm	1,100×566×280		1,100×566×280	
Weight		kg	16		16	
Gross Weight		kg	22		22	
Operation Sound	H/M/L/SL	dBA	37/34/31/28	37/34/31/29	38/35/32/29	39/36/33/30
Sound Power	H	dBA	53	—	54	—
Heat Insulation			Both Liquid and Gas Pipes		Both Liquid and Gas Pipes	
Piping Connection	Liquid	mm	φ 6.4		φ 6.4	
	Gas	mm	φ 9.5		φ 9.5	
	Drain	mm	φ 18.0		φ 18.0	
Drawing No.			3D040174A		3D040175A	

★ See page 20 "Combination Capacity"

Conversion Formulae
kcal/h=kW×860
Btu/h=kW×3414
cfm=m ³ /min×35.3

2.2 Outdoor Units

230V, 50Hz

Model			2MXS40BVMB		2AMXS40BVMB	
			Cooling	Heating	Cooling	Heating
Cooling Capacity ★	kW	—		—		
Power Consumption ★	W	—		—		
Running Current ★	A	—		—		
Casing Color		Ivory White		Ivory White		
Compressor	Type	Hermetically Sealed Swing Type		Hermetically Sealed Swing Type		
	Model	1YC23GXD		1YC23GXD		
	Motor Output	W	600	600		
Refrigerant Oil	Model	FVC50K		FVC50K		
	Charge	L	0.40	0.40		
Refrigerant	Type	R410A		R410A		
	Charge	kg	1.20	1.20		
Air Flow Rate	m ³ /min	HH	39	35	39	35
		H	35	32	35	32
		L	30	27	30	27
	cfm	HH	1126	1010	1126	1010
		H	1010	924	1010	924
		L	866	779	866	779
Fan	Type	Propeller		Propeller		
	Motor Output	W	50	50		
Starting Current	A	6.2		6.2		
Dimension (H×W×D)	mm	640×685×285		640×685×285		
Packaged Dimension (W×D×H)	mm	800×366×676		800×366×676		
Weight	kg	39		39		
Gross Weight	kg	42		42		
Operation Sound	Sound Pressure	dBA	47	48	47	48
	Silent Mode	dBA	43	44	43	44
Sound Power	dBA	62	—	62	—	
Piping Connection	Liquid	mm	φ 6.4×2		φ 6.4×2	
	Gas	mm	φ 9.5×2		φ 9.5×2	
	Drain	mm	φ18		φ18	
Heat Insulation		Both Liquid & Gas Pipes		Both Liquid & Gas Pipes		
No. of Wiring Connection		3 for Power Supply, 4 for Interunit Wiring		3 for Power Supply, 4 for Interunit Wiring		
Max. Piping Length	m	30 (for Total of Each Room)		30 (for Total of Each Room)		
		20 (for One Room)		20 (for One Room)		
Min. Piping Length	m	1.5 (for One Room)		1.5 (for One Room)		
Amount of Additional Charge	g/m	20 (20m or more)		20 (20m or more)		
Max. Installation Height Difference	m	15 (between Indoor Unit and Outdoor Unit)		15 (between Indoor Unit and Outdoor Unit)		
		7.5 (between Indoor Units)		7.5 (between Indoor Units)		
Drawing No.		3D040482		3D040483		

Notes:

- ★See "Combination Capacity".
- The data are based on the conditions shows in the table below.

Cooling	Heating	Piping Length
Indoor ; 27°CDB/19°CWB Outdoor ; 35°CDB	Indoor ; 20°CDB Outdoor ; 7°CDB/6°CWB	7.5m

Conversion Formulae
kcal/h=kW×860 Btu/h=kW×3414 cfm=m ³ /min×35.3

Combination Capacity Cooling [230V]

50Hz

Combination of Indoor Unit	Each Capacity (kW)				Total Capacity (kW)		Total Input (W)		Total Current (A)		Power Factor (%)
	A room	B room	—	—	Rating	(min~max)	Rating	(min~max)	Rating	(min~max)	Rating
2.0	2.00	—	—	—	2.00	1.20~2.40	605	340~740	2.8	1.9~3.4	94
2.5	2.50	—	—	—	2.50	1.20~3.00	755	340~1020	3.5	1.9~4.7	94
3.5	3.15	—	—	—	3.15	1.20~3.60	1120	340~1440	5.1	1.9~6.5	95
2.0+2.0	1.90	1.90	—	—	3.80	1.50~4.10	1185	400~1455	5.5	2.2~6.7	94
2.0+2.5	1.80	2.10	—	—	3.90	1.50~4.10	1215	400~1455	5.6	2.2~6.7	94
2.0+3.5	1.70	2.20	—	—	3.90	1.50~4.20	1215	400~1490	5.6	2.2~6.8	94
2.5+2.5	1.95	1.95	—	—	3.90	1.50~4.20	1215	400~1490	5.6	2.2~6.8	94
2.5+3.5	1.75	2.15	—	—	3.90	1.50~4.20	1215	400~1490	5.6	2.2~6.8	94

Heating [230V]

50Hz

Combination of indoor unit	Each capacity (kW)				Total capacity (kW)		Total input (W)		Total current (A)		Power factor (%)
	A room	B room	—	—	Rating	(min ~ max)	Rating	(min ~ max)	Rating	(min ~ max)	Rating
2.0	3.00	—	—	—	3.00	1.20~3.70	1000	380~1340	4.6	2.1~6.2	94
2.5	3.40	—	—	—	3.40	1.20~4.10	1135	380~1600	5.2	2.1~7.5	95
3.5	3.80	—	—	—	3.80	1.20~4.40	1350	380~1850	6.2	2.1~8.6	95
2.0+2.0	2.10	2.10	—	—	4.20	1.50~4.60	1140	340~1390	5.2	1.8~6.4	95
2.0+2.5	2.10	2.30	—	—	4.40	1.50~4.70	1190	340~1420	5.4	1.8~6.6	96
2.0+3.5	2.00	2.40	—	—	4.40	1.50~4.70	1190	340~1420	5.4	1.8~6.6	96
2.5+2.5	2.20	2.20	—	—	4.40	1.50~4.70	1190	340~1420	5.4	1.8~6.6	96
2.5+3.5	2.05	2.35	—	—	4.40	1.50~4.70	1190	340~1420	5.4	1.8~6.6	96

Notes:

- Cooling capacity is based on 27°/19°CWB (Indoor temperature), 35°CDB (Outdoor temperature).
Heating capacity is based on 20°CDB (Indoor temperature), 7°CDB/6°CWB (Outdoor temperature).
- It is impossible to connect the indoor unit for one room only.

Part 3

Printed Circuit Board

Connector Wiring Diagram

1. Printed Circuit Board Connector Wiring Diagram.....	22
1.1 Wall Mounted Type	22
1.2 Duct Connected Type.....	24
1.3 Floor / Ceiling Suspended Dual Type.....	26
1.4 Outdoor Unit.....	28

1. Printed Circuit Board Connector Wiring Diagram

1.1 Wall Mounted Type

Name of Connector

1) S1	Connector for fan motor
2) S6	Connector for swing motor (Horizontal Flap)
3) S7	Connector for fan motor
4) S21	Connector for centralized control
5) S26	Connector for display PCB
6) S27	Connector for control PCB
7) S32	Connector for room temp. / heat exchanger thermistor
8) S35	Connector for INTELLIGENT EYE Sensor PCB



Note: Other designations

1) V1	Varistor
2) JA	Address setting jumper
JB	Fan speed setting when compressor is OFF on thermostat.
JC	Power failure recovery function. * Refer to page 171 for more detail.
3) SW7	Forced operation ON/OFF switch
4) LED1	LED for operation (Green)
5) LED2	LED for timer (Yellow)
6) LED3	LED for HOME LEAVE Operation (Red)
7) LED A	LED for service monitor (green)
8) Fu1	Fuse (3.15A)
9) RTH1	Room temperature thermistor

Control PCB (PCB1)
 Display PCB (PCB2)
 Intelligent Eye
 Sensor PCB (PCB3)

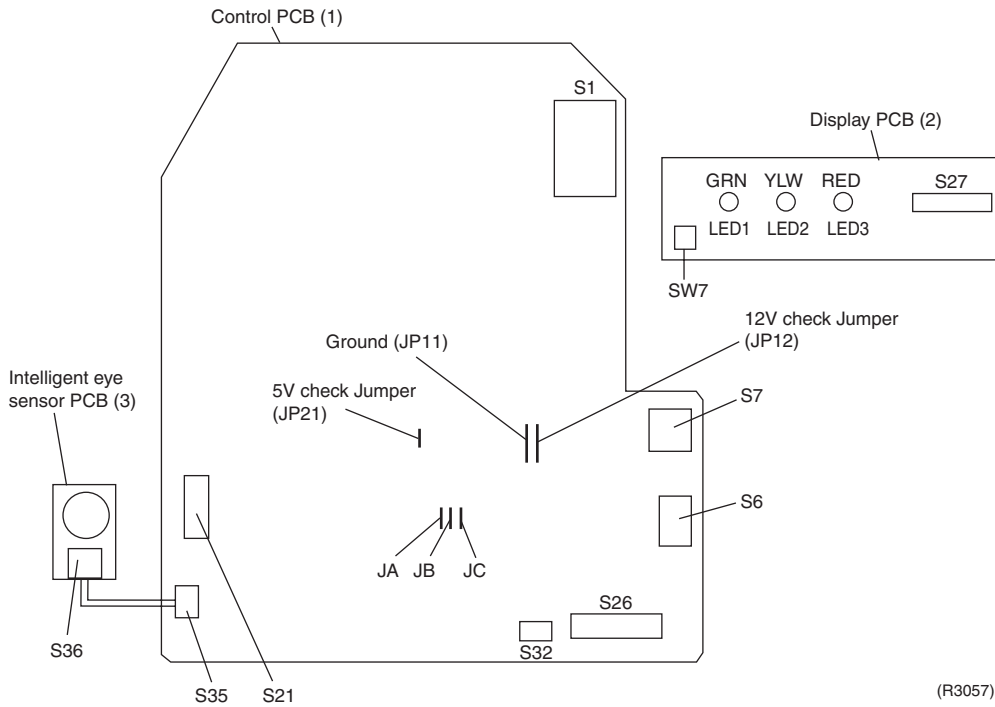

(R3057)

Detail of PCB

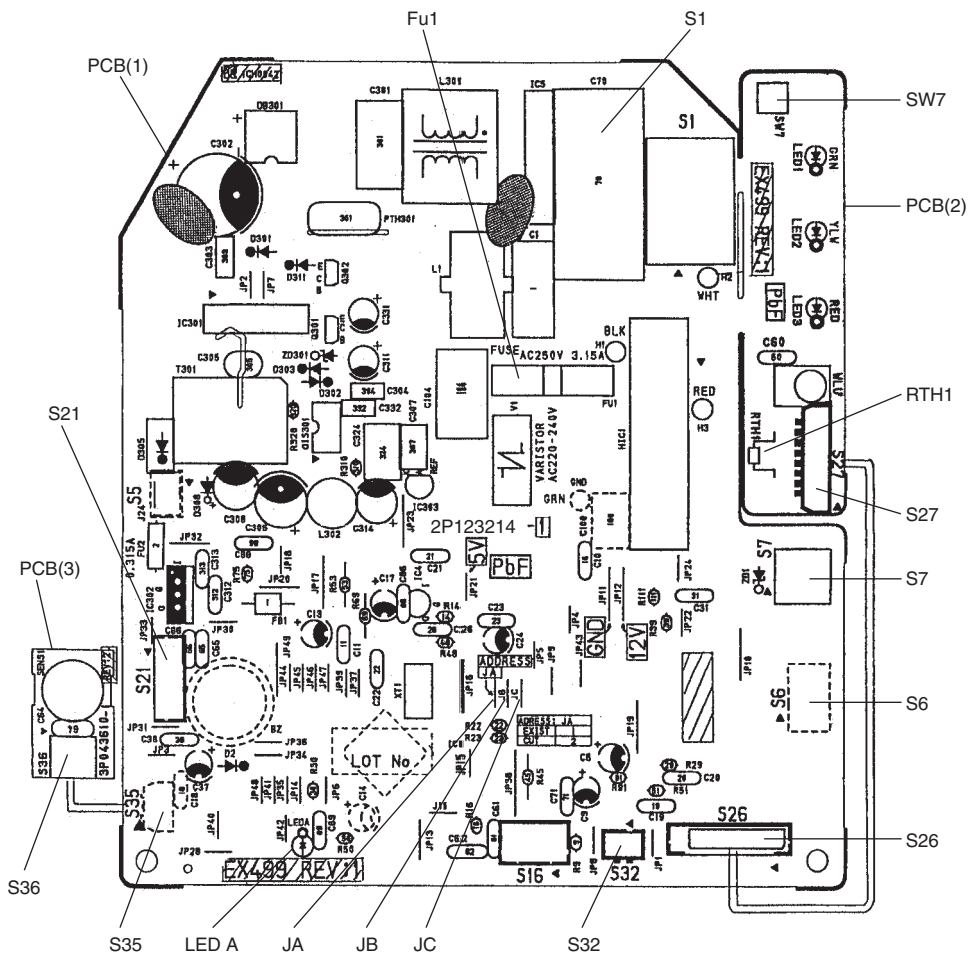

2P123214B

1.2 Duct Connected Type

Name of Connectors

- 1) S1 (on PCB 1) Connector for fan motor
- 2) S1 (on PCB 2) Connector for control PCB
- 3) S7 Connector for fan motor
- 4) S21 Connector for centralized control
- 5) S26 Connector for display PCB
- 6) S32 Connector for room temp/heat exchanger thermistor



Note:

Other designations

- 1) V1 Varistor
- 2) JA Address setting jumper
- JB Fan speed setting when compressor is OFF on thermostat.
- JC Power failure recovery function.
* Refer to page 171 for more detail.
- 3) SW1 Forced operation ON/OFF switch
- 4) LED1 LED for operation (Green)
- 5) LED2 LED for timer (Yellow)
- 6) LED3 LED for HOME LEAVE Operations (Red)
- 7) LED A LED for service monitor (green)
- 8) Fu1 Fuse (3.15A)
- 9) RTH1 Room temperature thermistor

Control PCB (PCB 1) Detail

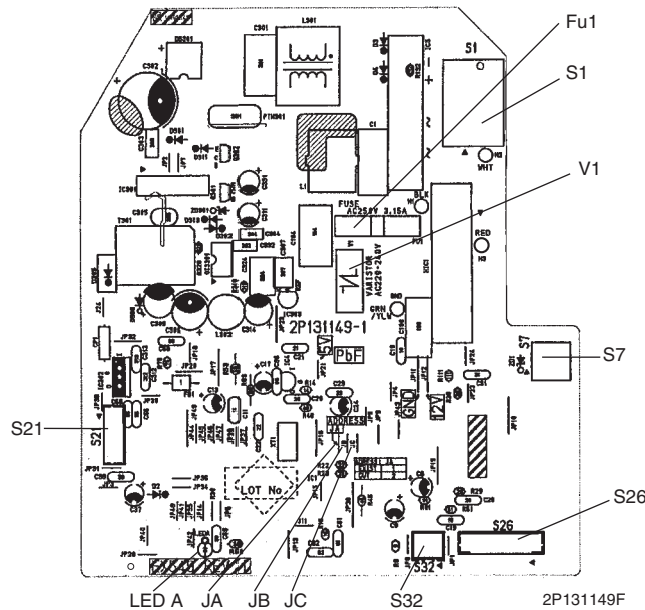

Display PCB (PCB 2) Detail

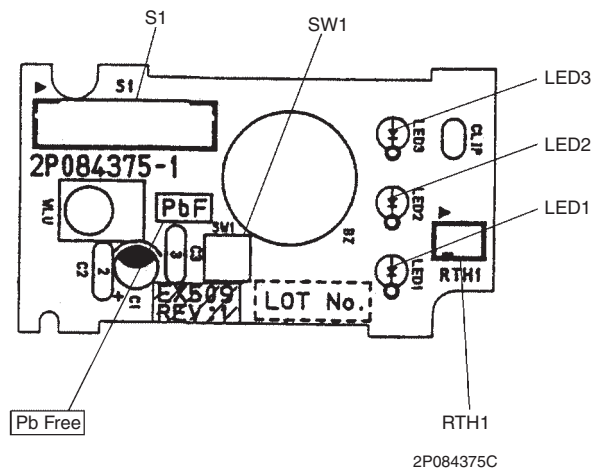

1.3 Floor / Ceiling Suspended Dual Type

Name of Connector

- 1) S6 Connector for swing motor (Horizontal Swing)
- 2) S7 Connector for fan motor
- 3) S21 Connector for centralized control
- 4) S24 Connector for display PCB
- 5) S25, S27, S36 Connector for control PCB
- 6) S26 Connector for signal receiver PCB
- 7) S31 Connector for room temp. thermistor
- 8) S32 Connector for heat exchanger thermistor
- 9) S37 Connector for power supply PCB



Note: Other designations

- 1) V1 Varistor
- 2) JA Address setting jumper
- JB Fan speed setting when compressor is OFF on thermostat.
- JC Power failure recovery function.
- 3) SW1 Forced operation ON/OFF switch
- 4) SW2 Select Switch Ceiling or Floor
- 5) LED1 LED for operation (Green)
- 6) LED2 LED for timer (Yellow)
- 7) LED3 LED for HOME LEAVE Operation (Red)
- 8) LED A LED for service monitor (green)
- 9) Fu1 Fuse (3.15A)

Control PCB (PCB1) Detail

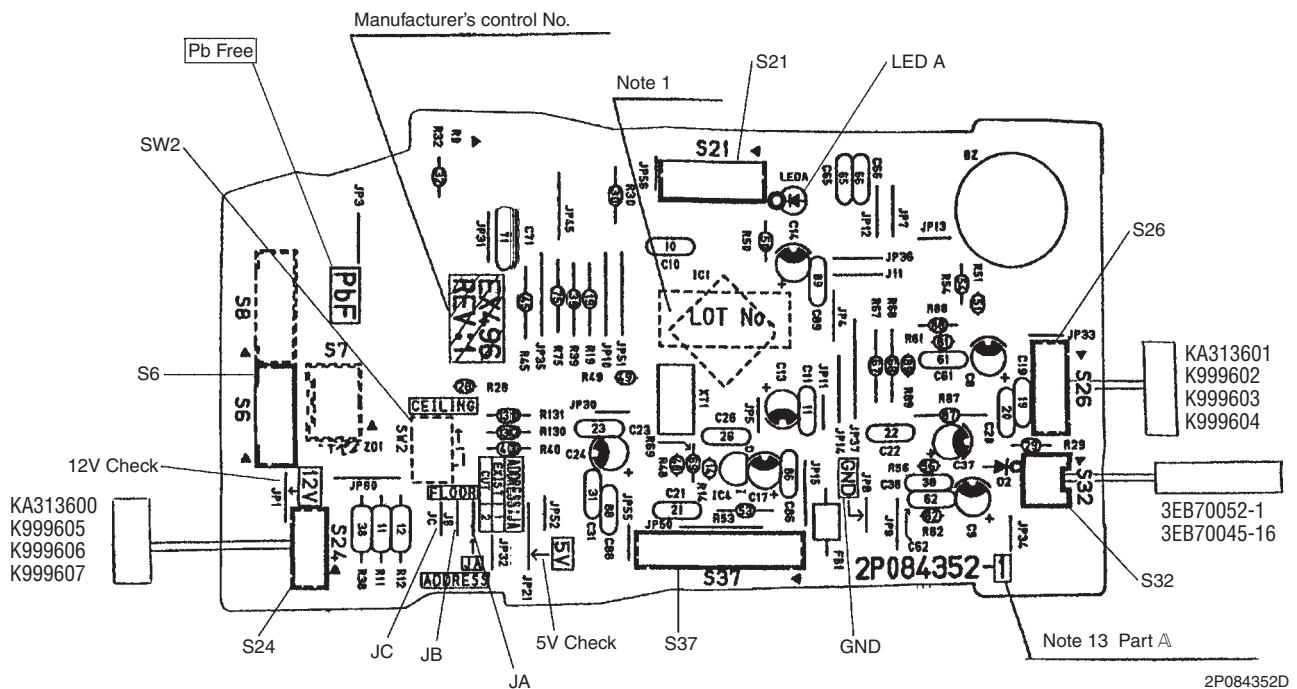

Power Supply PCB (PCB 2) Detail

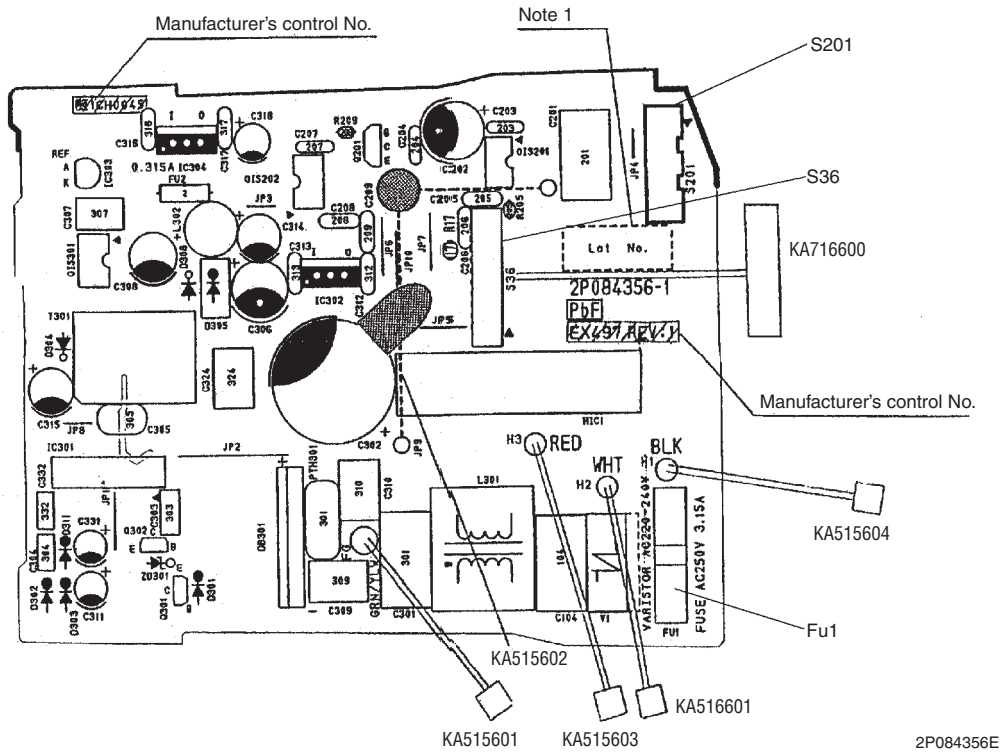

Display PCB (PCB 3) Detail

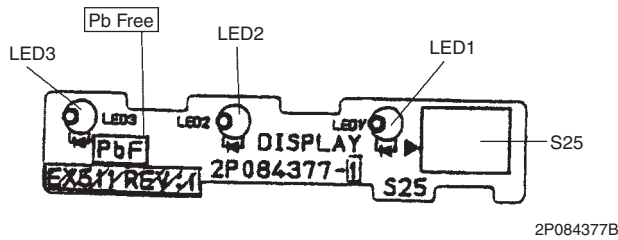

Signal Receiver PCB (PCB 4) Detail

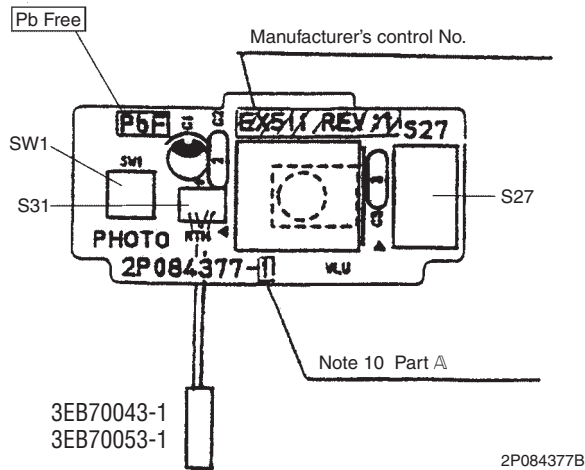

1.4 Outdoor Unit

Name of Connector

- 1) S10, S45, AC1, AC2 Connector for terminal strip
- 2) S11, HL1, HN1 Connector for control PCB
- 3) S12, HL2, HN2 Connector for filter PCB
- 4) S20 Connector for electronic expansion valve coil A port
- 5) S21 Connector for electronic expansion valve coil B port
- 6) S30 Connector for compressor
- 7) S70 Connector for fan motor
- 8) S80 Connector for four way valve coil
- 9) S90 Connector for thermistor (outdoor air, heat exchanger, and discharge pipe)
- 10)S91 Connector for thermistor (gas pipe and liquid pipe)
- 11)S93 Connector for fin thermistor
- 12)HC3, HC4 Connector for capacitor
- 13)HR3, HR4 Connector for reactor



Note: Other Designations

- 1) LED A Service Monitor LED (Green)
- 2) FU2 Fuse (3.15A/250V)
- 3) FU3 Fuse (20A/250V)
- 4) DB1 Diode bridge
- 5) J9 Jumper for maximum power input limitation (Refer to installation manual)

Filter PCB (PCB 1) Detail

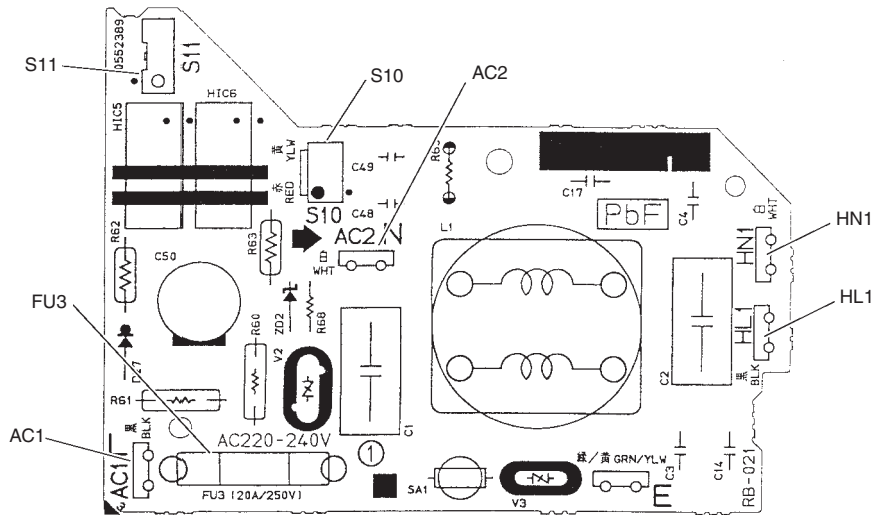

3P101648-1B

Control PCB (PCB 2) Detail

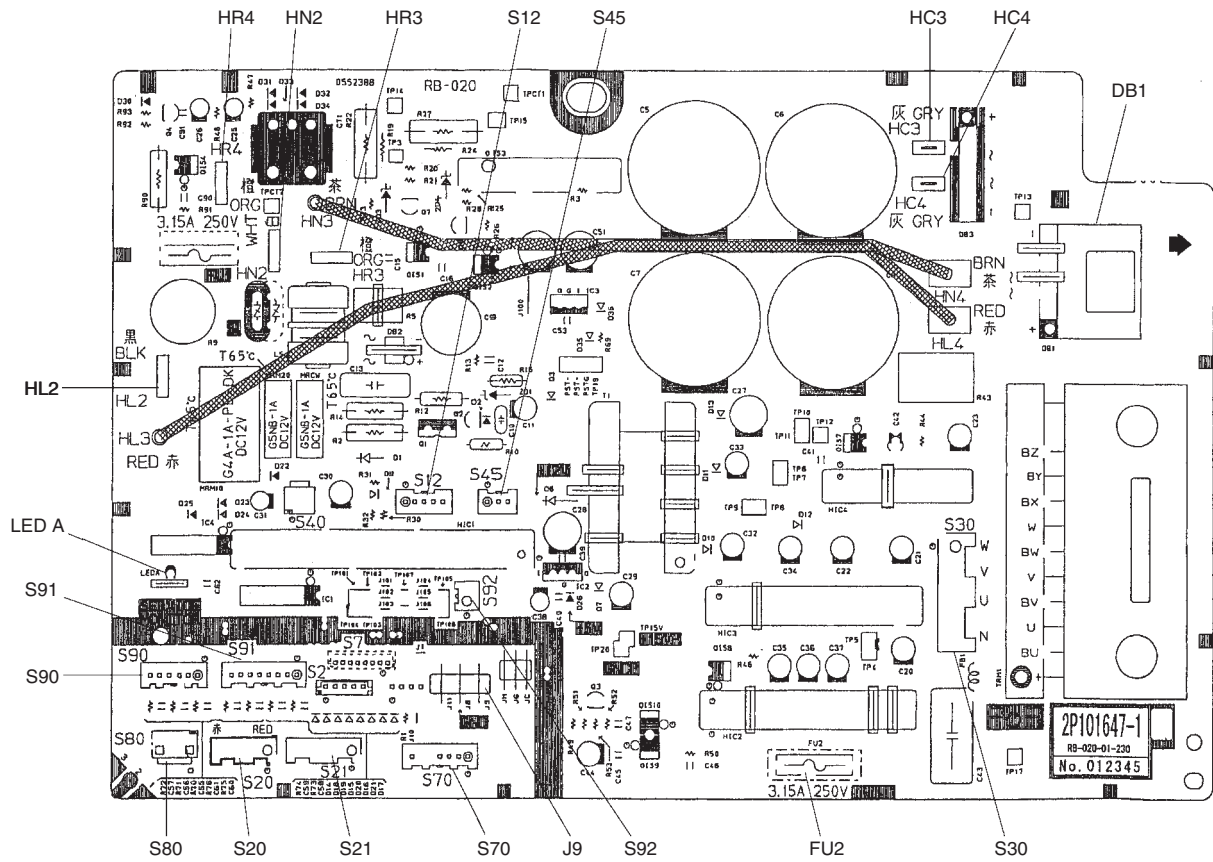

2P101647-1D

Part 4

Function and Control

1. Main Functions.....	32
1.1 Frequency Principle.....	32
1.2 Power-Airflow Dual Flaps, Wide Angle Louvers and Auto-Swing	34
1.3 Fan Speed Control for Indoor Units.....	35
1.4 Programme Dry Function	36
1.5 Automatic Operation.....	37
1.6 Night Set Mode.....	38
1.7 Intelligent Eye.....	39
1.8 Home Leave Operation	41
1.9 Inverter Powerful Operation	42
1.10 Other Functions.....	43
2. Function of Main Structural Parts.....	45
2.1 Main Structural Parts.....	45
2.2 Function of Thermistor	46
3. Control Specification	49
3.1 Mode Hierarchy.....	49
3.2 Frequency Control.....	50
3.3 Controls at Mode Changing / Start-up.....	52
3.4 Discharge Pipe Control	53
3.5 Input Current Control.....	53
3.6 Freeze-up Protection Control	54
3.7 Heating Peak-cut Control	54
3.8 Fan Control.....	55
3.9 Liquid Compression Protection Function 2.....	55
3.10 Defrost Control	56
3.11 Electronic Expansion Valve Control	57
3.12 Malfunctions	61
3.13 Preventing Indoor Freezing.....	62
3.14 Forced Operation Mode	62
3.15 Additional Function.....	62

1. Main Functions



Note: See the list of functions for the functions applicable to different models.

1.1 Frequency Principle

Main Control Parameters

The compressor is frequency-controlled during normal operation. The target frequency is set by the following 2 parameters coming from the operating indoor unit:

- The load condition of the operating indoor unit
- The difference between the room temperature and the set temperature

Additional Control Parameters

The target frequency is adapted by additional parameters in the following cases:

- Frequency restrictions
- Initial settings
- Forced cooling operation

Inverter Principle

To regulate the capacity, a frequency control is needed. The inverter makes it possible to vary the rotation speed of the compressor. The following table explains the conversion principle:

Phase	Description
1	The supplied AC power source is converted into the DC power source for the present.
2	The DC power source is reconverted into the three phase AC power source with variable frequency. <ul style="list-style-type: none"> ■ When the frequency increases, the rotation speed of the compressor increases resulting in an increased refrigerant circulation. This leads to a higher amount of the heat exchange per unit. ■ When the frequency decreases, the rotation speed of the compressor decreases resulting in a decreased refrigerant circulation. This leads to a lower amount of the heat exchange per unit.

Drawing of Inverter

The following drawing shows a schematic view of the inverter principle:

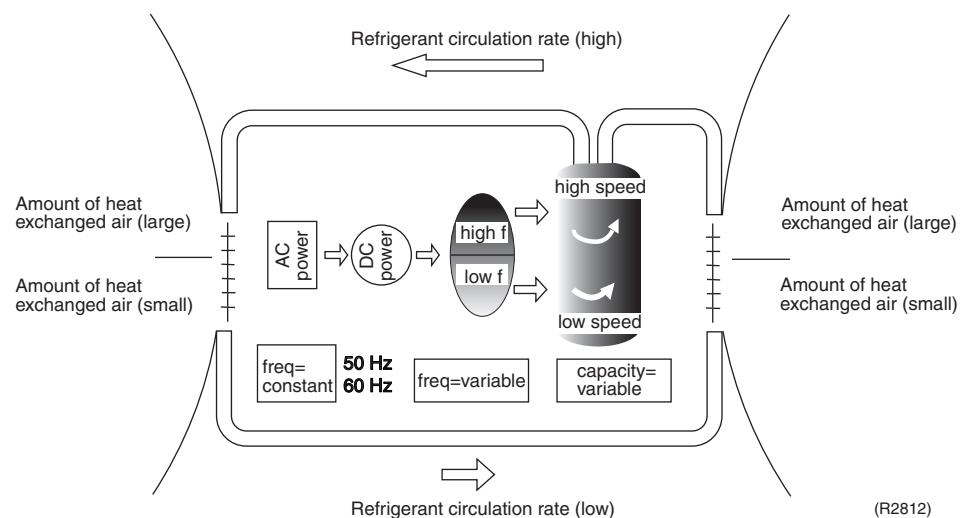

Inverter Features

The inverter provides the following features:

- The regulating capacity can be changed according to the changes in the outdoor air temperature and cooling / heating load.
- Quick heating and quick cooling
The compressor rotational speed is increased when starting the heating (or cooling). This enables a quick set temperature.

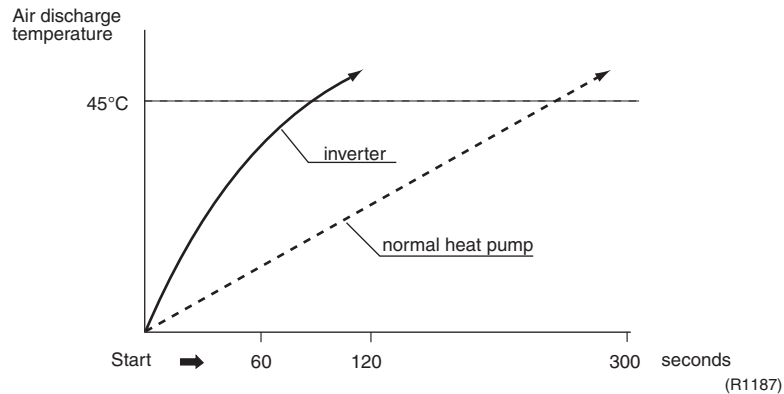

- Even during extreme cold weather, the high capacity is achieved. It is maintained even when the outdoor air temperature is 2°C.
- Comfortable air conditioning
A detailed adjustment is integrated to ensure a fixed room temperature. It is possible to air condition with a small room temperature variation.
- Energy saving heating and cooling
Once the set temperature is reached, the energy saving operation enables to maintain the room temperature at low power.

Frequency Limits

The following table shows the functions that define the minimum and maximum frequency:

Frequency limits	Limited during the activation of following functions
Low	<ul style="list-style-type: none"> ■ Four way valve operation compensation. Refer to page 52.
High	<ul style="list-style-type: none"> ■ Input current control. Refer to page 53. ■ Compressor protection function. Refer to page 52. ■ Heating peak-cut control. Refer to page 54. ■ Freeze-up protection control. Refer to page 54. ■ Defrost control. Refer to page 56.

Forced Cooling Operation

For more information, refer to "Forced operation mode" on page 62.

1.2 Power-Airflow Dual Flaps, Wide Angle Louvers and Auto-Swing

Power-Airflow Dual Flaps

The large flaps send a large volume of air downwards to the floor. The flap provides an optimum control area in cooling, heating and dry mode.

Heating Mode

During heating mode, the large flap enables direct warm air straight downwards. The flap presses the warm air above the floor to reach the entire room.

Cooling Mode

During cooling mode, the flap retracts into the indoor unit. Then, cool air can be blown far and pervaded all over the room.

Wide-Angle Louvers

The louvers, made of elastic synthetic resin, provide a wide range of airflow that guarantees a comfortable air distribution.

Auto Swing

The following table explains the auto swing process for heating, cooling, dry and fan :

Wall Mounted Type

Vertical Swing (up and down)		Horizontal Swing (right and left: manual)
Cooling / Dry / Fan	Heating	Heating, Cooling
<p>(R2946)</p>	<p>(R2947)</p>	<p>(R2817)</p>

1.3 Fan Speed Control for Indoor Units

Control Mode

The airflow rate can be automatically controlled depending on the difference between the set temperature and the room temperature. This is done through phase control and Hall IC control.



For more information about Hall IC, refer to trouble shooting for fan motor on page 106.

Phase Steps

Phase control and fan speed control contains 9 steps: LLL, LL, SL, L, ML, M, MH, H and HH.

Step	Cooling	Heating	Dry mode
LLL (Heating thermostat OFF)	 (R2818)	 (R2818)	20:25:35 kW class : 500 ~ 860 rpm (During powerful operation : 850 ~ 910 rpm)
LL (Cooling thermostat OFF)			
SL (Silent)			
L			
ML			
M			
MH			
H			
HH (Powerful)			

= Within this range the airflow rate is automatically controlled when the AIRFLOW ADJUSTING button is set to AUTOMATIC



Note:

1. During powerful operation, fan operate H tap + 50 - 90 rpm.
2. Fan stops during defrost operation.

Automatic Air Flow Control for Heating

The following drawing explains the principle for fan speed control for heating:

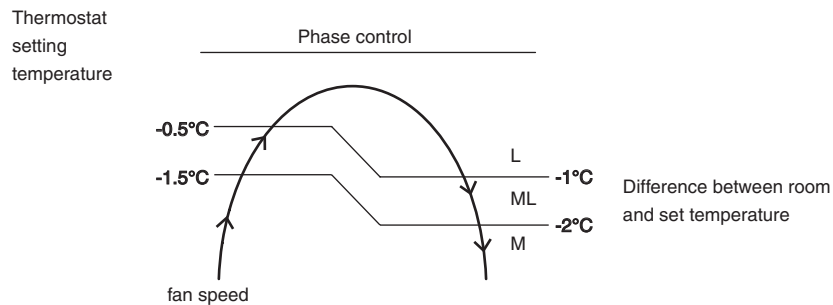

Automatic Air Flow Control for Cooling

The following drawing explains the principle of fan speed control for cooling:

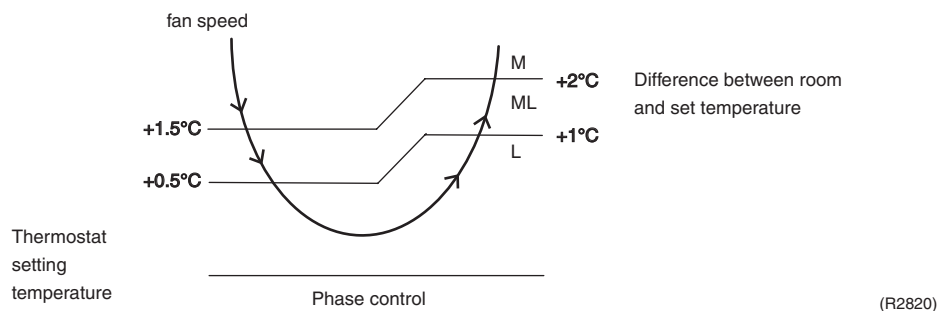

1.4 Programme Dry Function

Programme dry function removes humidity while preventing the room temperature from lowering.

Since the microcomputer controls both the temperature and air flow volume, the temperature adjustment and fan adjustment buttons are inoperable in this mode.

In Case of Inverter Units

The microcomputer automatically sets the temperature and fan settings. The difference between the room temperature at startup and the temperature set by the microcomputer is divided into two zones. Then, the unit operates in the dry mode with an appropriate capacity for each zone to maintain the temperature and humidity at a comfortable level.

Room temperature at startup	Temperature (ON point) at which operation starts	Frequency switching point	Temperature difference for operation stop
24°C	Room temperature at startup	0.5°C	1.5°C
18°C	18°C		1.0°C
17°C		—	

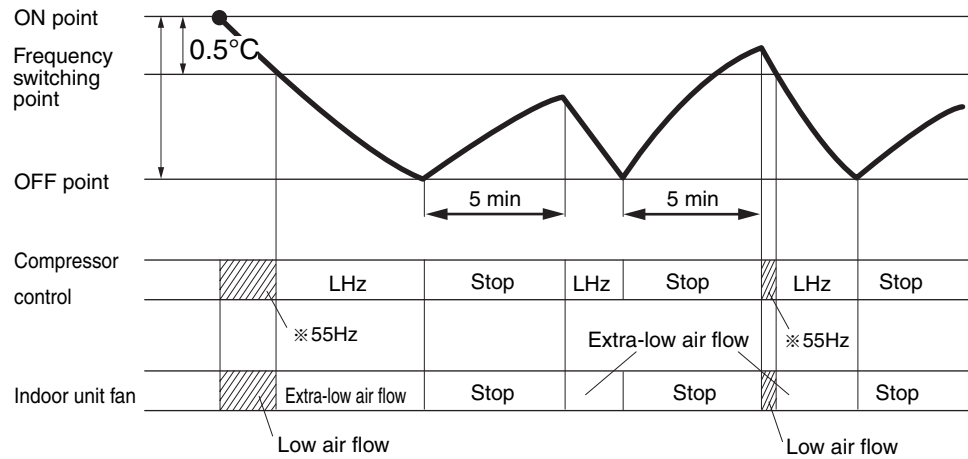

LHz indicates low frequency. Item marked with varies depending on models.

(R1359)

1.5 Automatic Operation

Automatic Cooling / Heating Function (Heat Pump Only)

When the AUTO mode is selected with the remote controller, the microcomputer automatically determines the operation mode from cooling and heating according to the room temperature and setting temperature at the time of the operation startup, and automatically operates in that mode.

The unit automatically switches the operation mode to cooling or heating to maintain the room temperature at the main unit setting temperature.

Detailed Explanation of the Function

1. Remote controller setting temperature is set as automatic cooling / heating setting temperature (18 to 30°C).
2. Main unit setting temperature equals remote controller setting temperature plus correction value (correction value / cooling: 0 deg, heating: 2 deg.).
3. Operation ON / OFF point and mode switching point are as follows.
 - ① Heating → Cooling switching point:
Room temperature \geq Main unit setting temperature +2.5 deg.
 - ② Cooling → Heating switching point:
Room temperature $<$ Main unit setting temperature -2.5 deg.
 - ③ Thermostat ON / OFF point is the same as the ON / OFF point of cooling or heating operation.
4. During initial operation
Room temperature \geq Remote controller setting temperature: Cooling operation
Room temperature $<$ Remote controller setting temperature: Heating operation

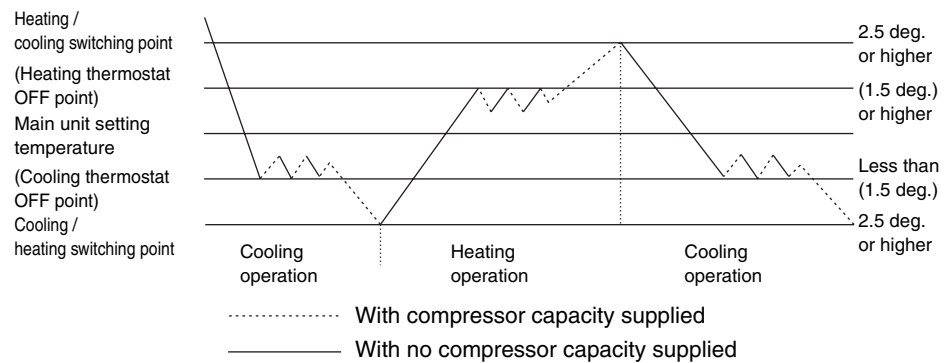

(R1360)

1.6 Night Set Mode

When the OFF timer is set, the Night Set Circuit automatically activates. The Night Set circuit maintains the airflow setting made by users.

The Night Set Circuit

The Night Set circuit continues heating or cooling the room at the set temperature for the first one hour, then automatically raises the temperature setting slightly in the case of cooling, or lowers it slightly in the case of heating, for economical operations. This prevents excessive heating in winter and excessive cooling in summer to ensure comfortable sleeping conditions, and also conserves electricity.

Cooling Operation

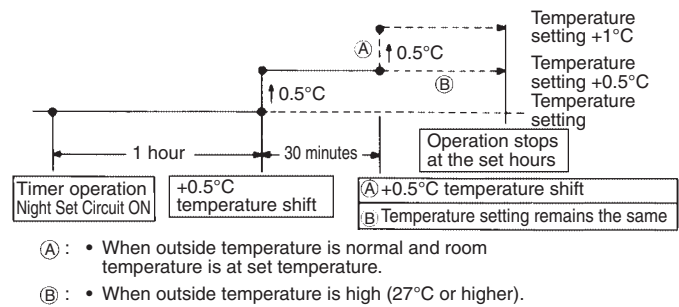

Heating Operation

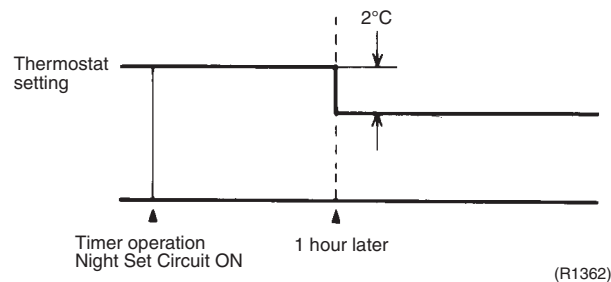

1.7 Intelligent Eye

This is the function that detects existence of humans in the room by a human motion sensor (Intelligent Eye) and reduces the capacity when there is no human in the room in order to save electricity.

Processing

1. Detection method by Intelligent Eye

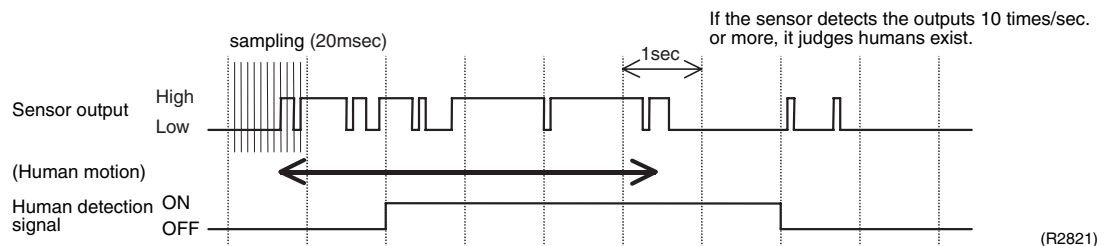

- This sensor detects human motion by receiving infrared rays and displays the pulse wave output.
- A microcomputer in an indoor unit carries out a sampling every 20 msec. and if it detects 10 cycles of the wave in one second in total (corresponding to $20\text{msec.} \times 10 = 100\text{msec.}$), it judges human is in the room as the motion signal is ON.

2. The motions (for example: in cooling)

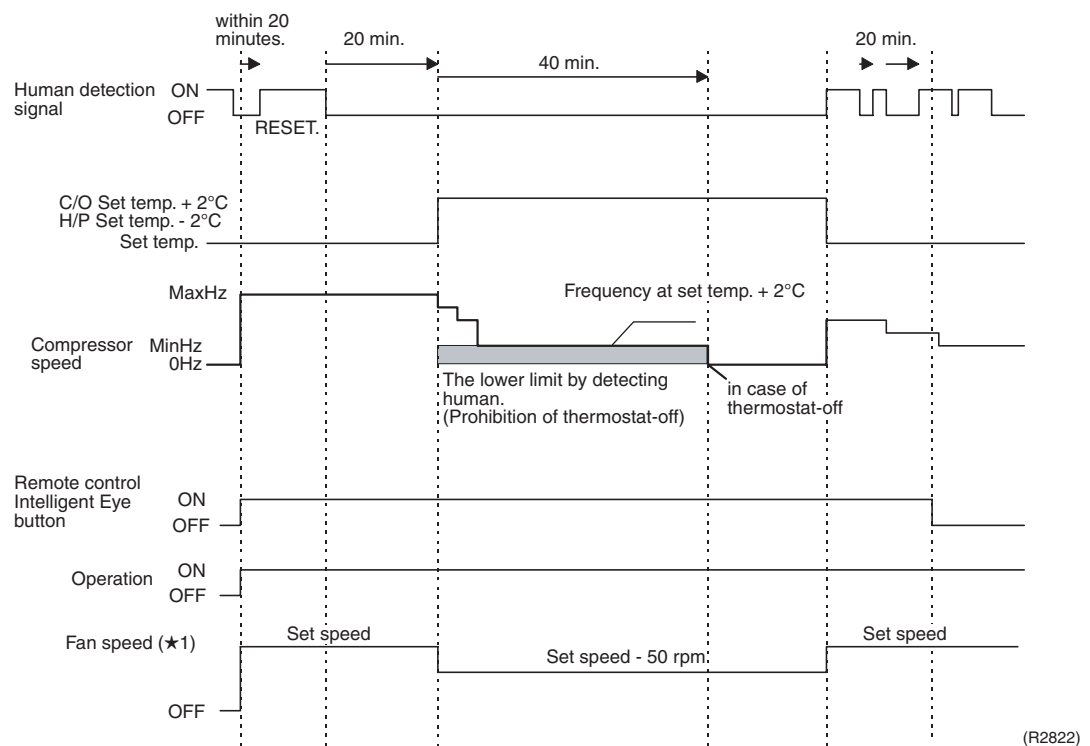

- When a microcomputer doesn't have a signal from the sensor in 20 minutes, it judges that nobody is in the room and operating the unit in temperature sifted 2°C from the set temperature. (Cooling : 2°C higher, Dry: 1°C higher and Auto : according to the operation mode at that time.)

★1 In case of Fan mode, the fan speed reduces by 50 rpm.

- Since the set temperature is shifted by 2°C higher for 40 minutes, compressor speed becomes low and can realize energy saving operation. But as thermostat is prone to be off by the fact that the set temperature has been shifted, the thermostat-off action is prohibited in 40 minutes so as to prevent this phenomena.
After this 40 minutes, the prohibition of the thermostat-off is cancelled and it can realize the conditions to conduct thermostat-off depending on the room temperature. In or after this forty minutes, if the sensor detects human motion detection signal, it let the set temperature and the fan speed return to the original set point, keeping a normal operation.

Others

- The dry operation can't command the setting temperature with a remote controller, but internally the set temperature is shifted by 1°C.

1.8 Home Leave Operation

Outline

In order to respond to the customer's need for immediate heating and cooling of the room after returning home or for house care, a measure to switch the temperature and air volume from that for normal time over to outing time by one touch is provided. (This function responds also to the need for keeping up with weak cooling or heating.)

This time, we seek for simplicity of operation by providing the special temperature and air volume control for outing to be set by the exclusive button.

Detail of the Control

1. Start of Function

The function starts when the [HOME LEAVE] button is pressed in cooling mode or heating mode (including stopping and powerful operation). If this button is pressed while the operation is stopped, the function becomes effective when the operation is started. If this button is pressed in powerful operation, the powerful operation is reset and this function becomes effective.

- The [HOME LEAVE] button is ineffective in dry mode and fan mode.

2. Details of Function

A mark representing [HOME LEAVE] is indicated on the liquid crystal display of the remote controller. The indoor unit is operated according to the set temperature and air volume for HOME LEAVE which were pre-set in the memory of the remote controller.

The LED (Red) of indoor unit representing [HOME LEAVE] lights up. (It goes out when the operation is stopped.)

3. End of Function

The function ends when the [HOME LEAVE] button is pressed again during [HOME LEAVE] operation or when the powerful operation button is pressed.

Scene <cooling>

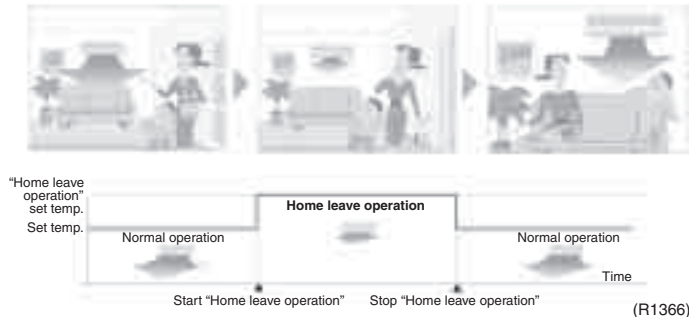

Scene <Heating>

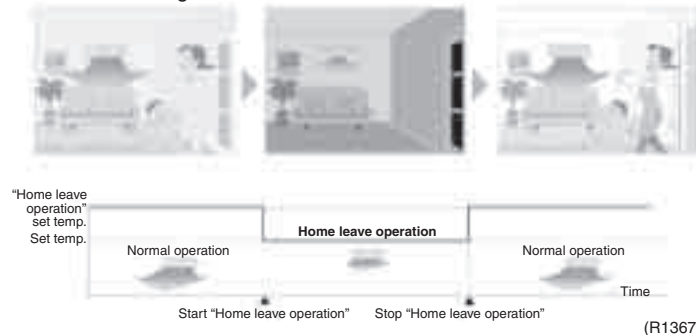

Others

The set temperature and set air volume are memorized in the remote controller. When the remote controller is reset due to replacement of battery, it is necessary to set the temperature and air volume again for [HOME LEAVE].

1.9 Inverter Powerful Operation

Outline

In order to exploit the cooling and heating capacity to full extent, operate the air conditioner by increasing the indoor fan rotating speed and the compressor frequency.

Details of the Control

When Powerful button is pushed in each operation mode, the fan speed / setting temperature will be converted to the following states in a period of twenty minutes.

Operation mode	Fan speed	Target set temperature
Cooling	H tap + 80 rpm	18°C
Dry	Dry rotating speed + 50 rpm	Normally targeted temperature in dry operation; Approx. - 2°C
Heating	H tap + 80 rpm	30°C
Fan	H tap + 80 rpm	—
Automatic	Same as cooling / heating in Powerful operation	The target is kept unchanged

Ex.) : Powerful operation in cooling mode.

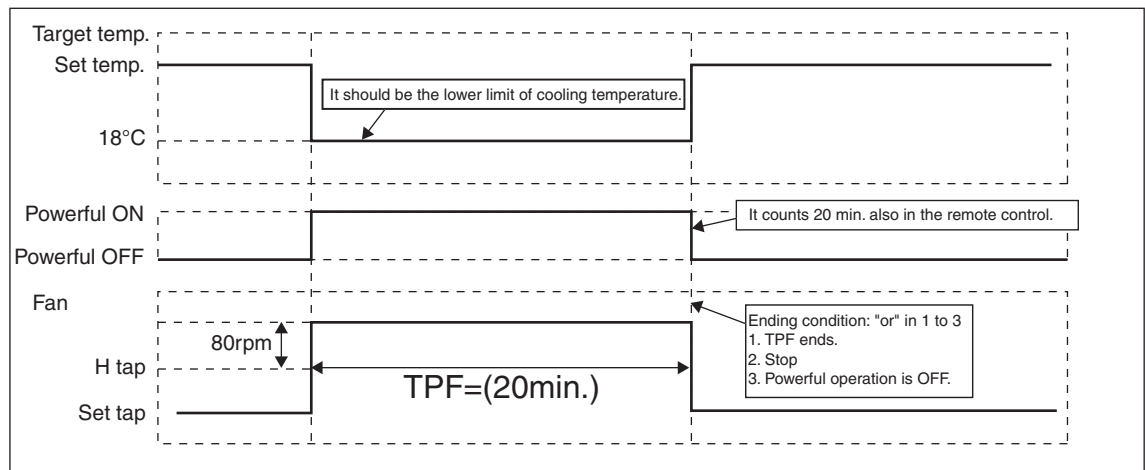

(R2823)

1.10 Other Functions

1.10.1 Hot Start Function

Heat Pump Only

In order to prevent the cold air blast that normally comes when heating is started, the temperature of the heat exchanger of the indoor unit is detected, and either the air flow is stopped or is made very weak thereby carrying out comfortable heating of the room.

*The cold air blast is also prevented using a similar control when the defrosting operation is started or when the thermostat gets turned ON.

1.10.2 Signal Receiving Sign

When the indoor unit receives a signal from the remote controller, the unit emits a signal receiving sound.

1.10.3 ON/OFF Button on Indoor Unit

An ON/OFF switch is provided on the front panel of the unit. Use this switch when the remote controller is missing or if its battery has run out.

Every press of the switch changes from Operation to Stop or from Stop to Operation

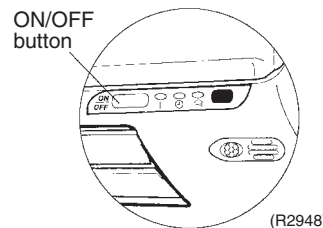

- Push this button once to start operation. Push once again to stop it.
- This button is useful when the remote controller is missing.
- The operation mode refers to the following table.

	Mode	Temperature setting	Air flow rate
Cooling Only	COOL	22°C	AUTO
Heat Pump	AUTO	25°C	AUTO

- In the case of multi system operation, there are times when the unit does not activate with this button.

1.10.4 Air Purifying Filter with Photocatalytic Deodorizing Function

This filter incorporates the benefits the Air Purifying Filter and Photocatalytic Deodorizing Filter in a single unit. Combining the two filters in this way increases the active surface area of the new filter. This larger surface area allows the filter to effectively trap microscopic particles, decompose odours and deactivate bacteria and viruses even for the high volume of air required to air-condition large living rooms. The filter can be used for approximately 3 years if periodic maintenance is performed.

1.10.5 Photocatalytic Deodorizing Filter

Photocatalytic Deodorizing Filter demonstrates powerful oxidation characteristics when subjected to harmless ultraviolet light. Photocatalytic deodorizing power is recovered simply by exposing the filter to the sun for 6 hours once every 6 months.

1.10.6 Air Purifying Filter

A double structure made up of a bacteriostatic filter and an Air-Purifying Filter traps dust, mildew, mites, tobacco smoke, and allergy-causing pollen. Replace the Air-Purifying Filter once every 3 months.

1.10.7 Mold Proof Air Filter

The filter net is treated with mold resisting agent TBZ (harmless, colorless, and odorless). Due to this treatment, the amount of mold growth is much smaller than that of normal filters.

1.10.8 Self-Diagnosis Digital Display

The microcomputer continuously monitors main operating conditions of the indoor unit, outdoor unit and the entire system. When an abnormality occurs, the LCD remote controller displays error code. These indications allow prompt maintenance operations.

1.10.9 Auto-restart Function

Even if a power failure (including one for just a moment) occurs during the operation, the operation restarts in the condition before power failure automatically when power is restored. (Note) It takes 3 minutes to restart the operation because the 3-minute standby function is activated.

2. Function of Main Structural Parts

2.1 Main Structural Parts

Heat Pump Model

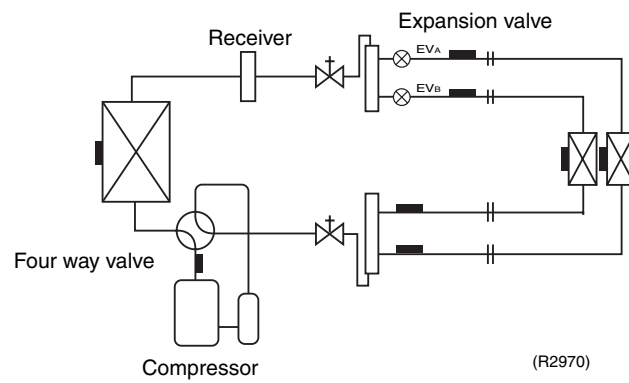

Cooling Only Model

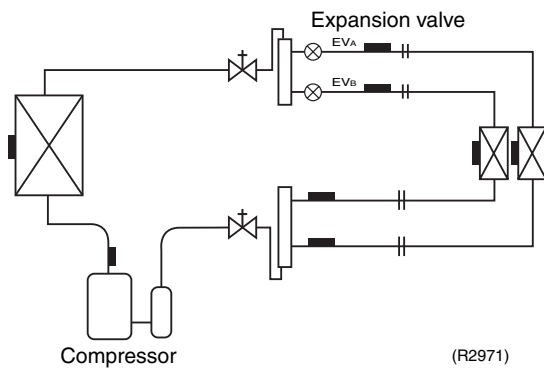

2.2 Function of Thermistor

2.2.1 Heat Pump Model

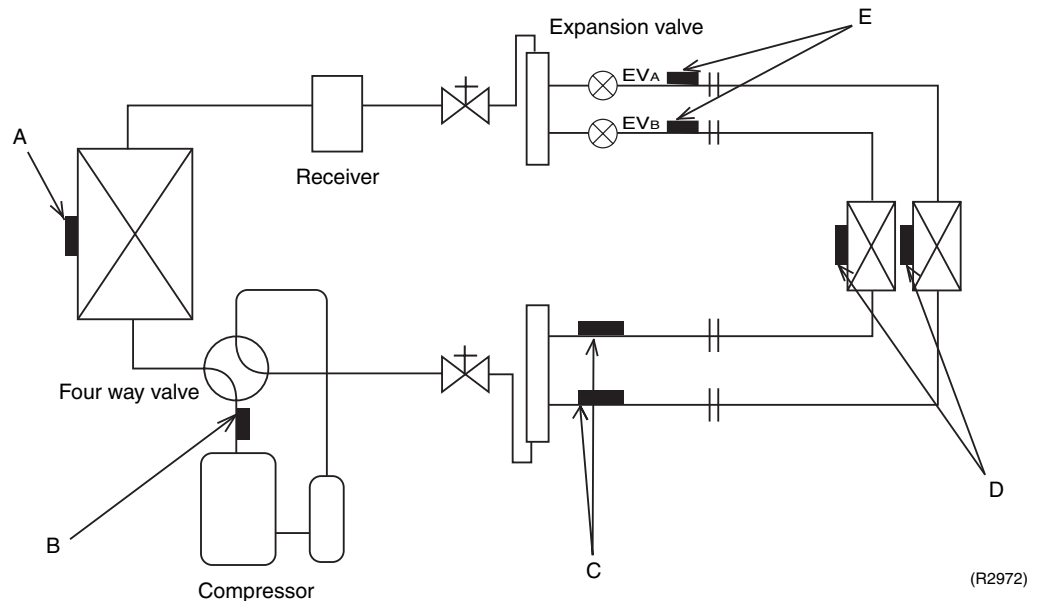

A Outdoor Heat Exchanger Thermistor (DCB)

1. The outdoor heat exchanger thermistor is used for controlling target discharge temperature. Set a target discharge temperature depending on the outdoor and indoor heat exchanger temperature.
Control the electronic expansion valve opening so that the target discharge temperature can be obtained.
2. The outdoor heat exchanger thermistor is used for detecting the discharge thermistor disconnected when cooling.
When the temperature of the discharge piping is lower than the temperature of outdoor heat exchanger, a disconnected discharge thermistor can be detected.
3. The outdoor heat exchanger thermistor is used for high pressure protection during cooling operation.

B Discharge Pipe Thermistor (DOT)

1. The discharge pipe thermistor is used to control the discharge pipe.
If the temperature of discharge pipe (used in place of the inner temperature of the compressor) rises abnormally, the operating frequency drops or the operation must be halted.
2. The discharge pipe thermistor is used for detecting the discharge thermistor disconnected.

C Gas Pipe Thermistor (DGN)

When cooling: a gas pipe thermistor is used for gas pipe isothermal control.
Control electronic expansion valve opening so that a gas pipe temperature in each room becomes equal.

D Indoor Heat Exchanger Thermistor (DCN)

1. The indoor heat exchanger thermistor is used for controlling target discharge pipe temperature.
Set a target discharge pipe temperature according to the outdoor and indoor heat exchanger temperature.
Control the electronic expansion valve so that the target discharge pipe temperature can be obtained.
2. The indoor heat exchanger thermistor is used to prevent freezing.
During the cooling operation, if the temperature drops abnormally, the operating frequency becomes lower, then the operation must be halted.
3. The indoor heat exchanger thermistor is used for anti-icing control.
During the cooling operation, if the heat exchanger temperature in the room where operation is halted becomes -1°C , or if the room temperature - heat exchanger temperature in the room where operation is halted becomes $\geq 10^{\circ}\text{C}$, it is assumed as icing.
4. During heating: the indoor heat exchanger thermistor is used for detecting the discharge pipe thermistor disconnected.
When the discharge pipe temperature become lower than an indoor heat exchanger temperature, a disconnected discharge pipe thermistor can be detected.
5. When only one indoor unit is operating, the indoor heat exchanger thermistor is used for sub-cooling control.
An actual sub-cooling must be calculated from an indoor liquid pipe temperature and a heat exchanger temperature. The indoor heat exchanger thermistor controls the electronic expansion valve opening to get a target sub-cooling.

E Indoor Liquid Pipe Thermistor (DLN)

1. When only one indoor unit is heating, the indoor liquid pipe thermistor is used for a sub-cooling control.
The system calculates an actual sub-cooling from the temperature of indoor liquid pipes and a heat exchanger temperature, controls the electronic expansion valve to make the appropriate target sub-cooling.
2. When all indoor units are heating, the indoor liquid pipe thermistor is used for liquid pipes isothermal control.
The system controls electronic expansion valves to make liquid pipe temperatures the average of present temperature of each room.

2.2.2 Cooling Only Model

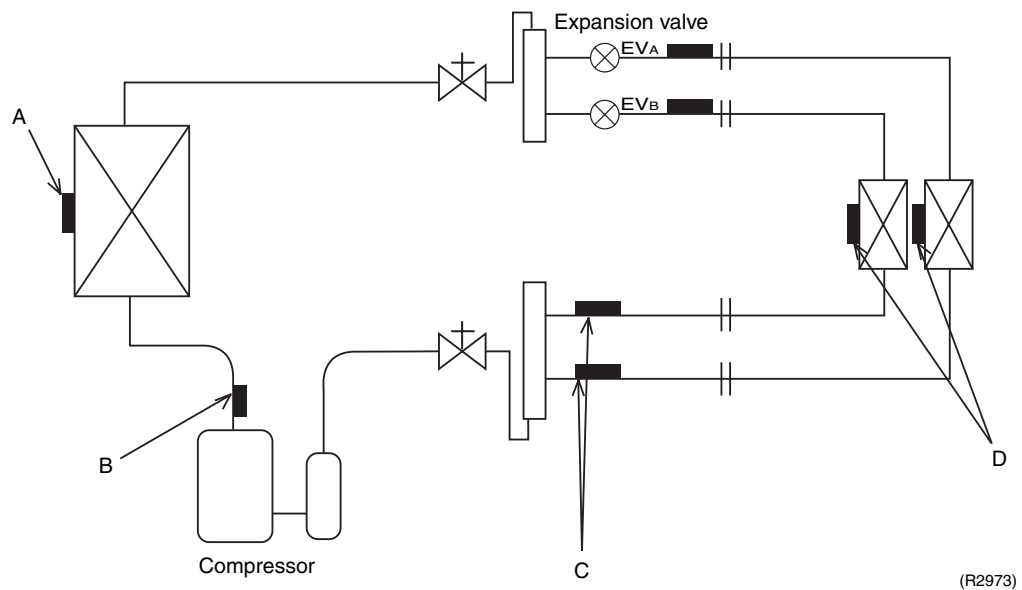

A Outdoor Heat Exchanger Thermistor (DCB)

1. The outdoor heat exchanger thermistor is used for controlling target discharge temperature. Set a target discharge temperature depending on the outdoor and indoor heat exchanger temperature. Control the electronic expansion valve opening so that the target discharge temperature can be obtained.
2. When cooling: an outdoor heat exchanger thermistor is used for detecting the discharge thermistor disconnected. When the temperature of the discharge piping is lower than the temperature of outdoor heat exchanger, a disconnected discharge thermistor can be detected.
3. The outdoor heat exchanger thermistor is used for high pressure protection during cooling operation.

B Discharge Pipe Thermistor (DOT)

1. The discharge pipe thermistor is used to control the discharge pipe. If the temperature of discharge pipe (used in place of the inner temperature of the compressor) rises abnormally, the operating frequency drops or the operation must be halted.
2. The discharge pipe thermistor is used for detecting the discharge thermistor disconnected.

C Gas Pipe Thermistor (DGN)

When cooling: a gas pipe thermistor is used for gas pipe isothermal control. Control electronic expansion valve opening so that a gas pipe temperature in each room becomes equal.

D Indoor Heat Exchanger Thermistor (DCN)

1. The indoor heat exchanger thermistor is used for controlling target discharge pipe temperature. Set a target discharge pipe temperature according to the outdoor and indoor heat exchanger temperature. Control the electronic expansion valve opening so that the target discharge pipe temperature can be obtained.
2. The indoor heat exchanger thermistor is used to prevent freezing. During the cooling operation, if the temperature drops abnormally, the operating frequency becomes lower, then the operation must be halted.
3. The indoor heat exchanger thermistor is used for anti-icing control. During the cooling operation, if the heat exchanger temperature in the room where operation is halted becomes -1°C , or if the room temperature - heat exchanger in the room where operation is halted becomes $\geq 10^{\circ}\text{C}$, it is assumed as icing.

3. Control Specification

3.1 Mode Hierarchy

Outline

There are two modes; the mode selected in user's place (normal air conditioning mode) and forced operation mode for installation and providing service.

Detail

1. For heat pump model

There are following modes; stop, cooling (includes drying), heating (include defrosting)

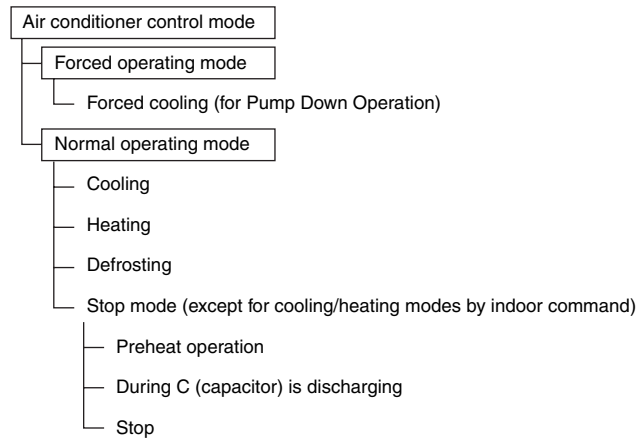

(R2829)

2. For cooling only model

There are following models; stop and cooling (including drying).

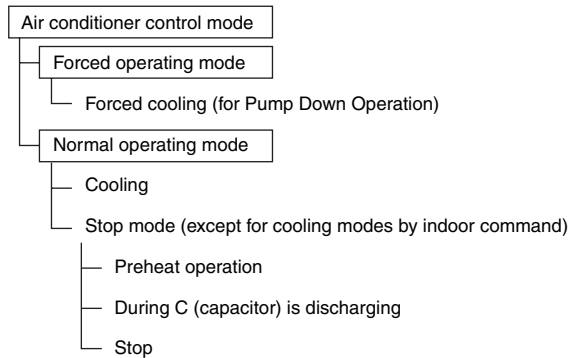

(R2830)



Note:

Unless specified otherwise, an indoor dry operation command must be regarded as cooling operation.

Determine Operating Mode

Judge the operating mode command set by each room in accordance with the instructing procedure, and determine the operating mode of the system.

The following procedure will be taken as the modes conflict with each other.

- The system will follow the mode determined first. (First-push, first-set)
- For the rooms set with different mode, select stand-by mode. (Operation lamp flashes)

Command of the first set room	Command of the second set room	Operation of the first set room	Operation of the second set room
Cooling	Heating	Cooling	Stand-by
Cooling	Fan	Cooling	Fan
Heating	Cooling	Cooling	Stand-by
Heating	Fan	Fan	Stand-by
Fan	Cooling	Cooling	Cooling
Fan	Heating	Stand-by	Heating

3.2 Frequency Control

Outline

Frequency that corresponds to each room's capacity will be determined according to the difference in the temperature of each room and the temperature that is set by the remote controller.

The function is explained as follows.

1. How to determine frequency.
2. Frequency command from an indoor unit. (The difference between a room temperature and the temperature set by the remote controller.)
3. Frequency command from an indoor unit. (The ranked capacity of the operating room).
4. Frequency initial setting.
5. PI control.

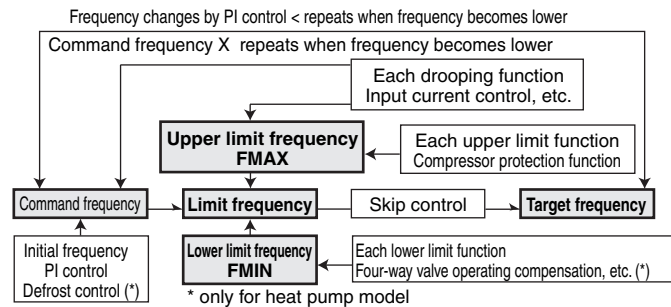

(R1375)

Detail

How to Determine Frequency

The compressor's frequency will finally be determined by taking the following steps.

For Heat Pump Model

1. Determine command frequency

- ◆ Command frequency will be determined in the following order of priority.
 - 1.1 Limiting frequency by drooping function
 - ◆ Input current, discharge pipes, low Hz high pressure limit, peak cutting, freeze prevention, dew prevention, fin thermistor temperature.
 - 1.2 Limiting defrost control time
 - 1.3 Forced cooling
 - 1.4 Indoor frequency command

2. Determine upper limit frequency

- ◆ Set a minimum value as an upper limit frequency among the frequency upper limits of the following functions:
Compressor protection, input current, discharge pipes, Low Hz high pressure, peak cutting, freeze prevention, defrost.

3. Determine lower limit frequency

- ◆ Set a maximum value as a lower limit frequency among the frequency lower limits of the following functions:
Four way valve operating compensation, draft prevention, pressure difference upkeep.

4. Determine prohibited frequency

- ◆ There is a certain prohibited frequency such as a power supply frequency.

For Cooling Only Model

1. Determine command frequency

- ◆ Command frequency will be determined in the following order of priority.
 - 1.1 Limiting frequency by drooping function
 - ◆ Input current, discharge pipes, freeze prevention, dew prevention, fin thermistor temperature.
 - 1.2 Indoor frequency command

2. Determine upper limit frequency

- ◆ Set a minimum value as an upper limit frequency among the frequency upper limits of the following functions:
Compressor protection, input current, discharge pipes, freeze prevention, dew prevention, fin thermistor temperature.

3. Determine lower limit frequency

- ◆ Set a maximum value as an lower limit frequency among the frequency lower limits of the following functions:
Pressure difference upkeep.

4. Determine prohibited frequency

- ◆ There is a certain prohibited frequency such as a power supply frequency.

Indoor Frequency Command (ΔD signal)

The difference between a room temperature and the temperature set by the remote controller will be taken as the " ΔD signal" and is used for frequency command.

Temperature difference	ΔD signal	Temperature difference	ΔD signal	Temperature difference	ΔD signal	Temperature difference	ΔD signal
0	*Th OFF	2.0	4	4.0	8	6.0	C
0.5	1	2.5	5	4.5	9	6.5	D
1.0	2	3.0	6	5.0	A	7.0	E
1.5	3	3.5	7	5.5	B	7.5	F

*Th OFF = Thermostat OFF

Indoor Unit Capacity (S value)

The capacity of the indoor unit is a "S" value and is used for frequency command.

Capacity	S value
2.5 kW	25
3.5 kW	35

Frequency Initial Setting**<Outline>**

When starting the compressor, or when conditions are varied due to the change of the operating room, the frequency must be initialized according to the total of a maximum ΔD value of each room and a total value of Q (ΣQ) of the operating room (the room in which the thermostat is set to ON).

Q value: Indoor unit output determined from indoor unit volume, air flow rate and other factors.

PI Control (Determine Frequency Up/Down by ΔD Signal)**1. P control**

Calculate a total of the ΔD value in each sampling time (20 seconds), and adjust the frequency according to its difference from the frequency previously calculated.

2. I control

If the operating frequency is not change more than a certain fixed time, adjust the frequency up and down according to the $\Sigma \Delta D$ value, obtaining the fixed $\Sigma \Delta D$ value.

When the $\Sigma \Delta D$ value is small...lower the frequency.

When the $\Sigma \Delta D$ value is large...increase the frequency.

3. Limit of frequency variation width

When the difference between input current and input current drooping value is less than 1.5 A, the frequency increase width must be limited.

4. Frequency management when other controls are functioning

- ◆ When each frequency is drooping;
Frequency management is carried out only when the frequency droops.
- ◆ For limiting lower limit
Frequency management is carried out only when the frequency rises.

5. Upper and lower limit of frequency by PI control

The frequency upper and lower limits are set depending on the total of S values of operating room. When low noise commands come from the indoor unit more than one room or when outdoor unit low noise or quiet commands come from all the rooms, the upper limit frequency must be lowered than the usual setting.

3.3 Controls at Mode Changing / Start-up

3.3.1 Preheating Operation

Outline Operate the inverter in the open phase operation with the conditions including the preheating command from the indoor, the outdoor air temperature and discharge pipe temperature.

Detail

Preheating ON Condition

- ◆ When outdoor air temperature is below 10.5°C and discharge pipe temperature is below 10.5°C, inverter in open phase operation starts.

OFF Condition

- ◆ When outdoor air temperature is higher than 12°C or discharge pipe temperature is higher than 12°C, inverter in open phase operation stops.

3.3.2 Four Way Valve Switching

Outline of Heating Operation

Heat Pump Only

During the heating operation current must be conducted and during cooling and defrosting current must not be conducted. In order to eliminate the switching sound (as the four way valve coil switches from ON to OFF) when the heating is stopped, the delay switch of the four way valve must be carried out after the operation stopped.

Detail

The OFF delay of four way valve
Energize the coil for 150 sec after unit operation is stopped.

3.3.3 Four Way Valve Operation Compensation

Outline

Heat Pump Only

At the beginning of the operation as the four way valve is switched, acquire the differential pressure required for activating the four way valve by having output the operating frequency, which is more than a certain fixed frequency, for a certain fixed time.

Detail

Starting Conditions

1. When starting compressor for heating.
2. When the operating mode changes from the previous time.
3. When starting compressor for starting defrosting or resetting.
4. When starting compressor for the first time after the reset with the power is ON.
5. When starting compressor after operation stop by the cooling / heating mode change-over malfunction.

Set the lower limit frequency to 68 (model by model) Hz for 70 seconds with the OR conditions with 1 through 5 above.

3.3.4 3 Minutes Stand-by

Prohibit to turn ON the compressor for 3 minutes after turning it off.
(Except when defrosting. (Only for Heat Pump Model).)

3.3.5 Compressor Protection Function

When turning the compressor from OFF to ON, the upper limit of frequency must be set as follows. (The function must not be used when defrosting (only for heat pump model).)

FCG 3	90
FCG 2	72
FCG 1	62
TCG 1	110
TCG 2	660
TCG 3	90

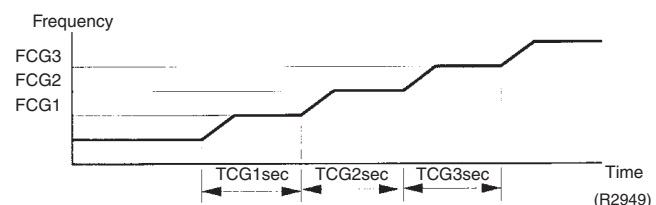

3.4 Discharge Pipe Control

Outline

The discharge pipe temperature is used as the compressor's internal temperature. If the discharge pipe temperature rises above a certain level, the operating frequency upper limit is set to keep this temperature from going up further.

Detail

Divide the Zone

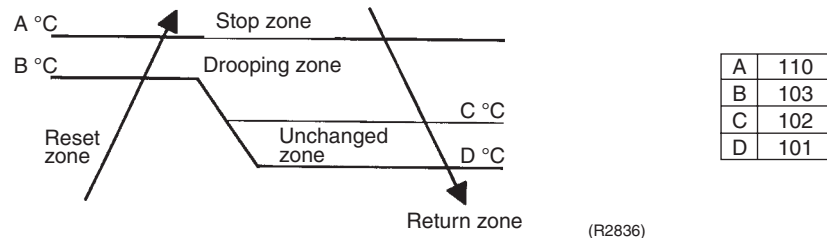

Management within the Zones

Zone	Control contents
Stop zone	When the temperature reaches the stop zone, stop the compressor and correct abnormality.
Drooping zone	Start the timer, and the frequency will be drooping.
Unchanged zone	Keep the upper limit of frequency.
Return / Reset zone	Cancel the upper limit of frequency.

3.5 Input Current Control

Outline

Detect an input current by the CT during the compressor is running, and set the frequency upper limit from such input current.

In case of heat pump model, this control is the upper limit control function of the frequency which takes priority of the lower limit of four way valve activating compensation.

Detail

The frequency control will be made within the following zones.

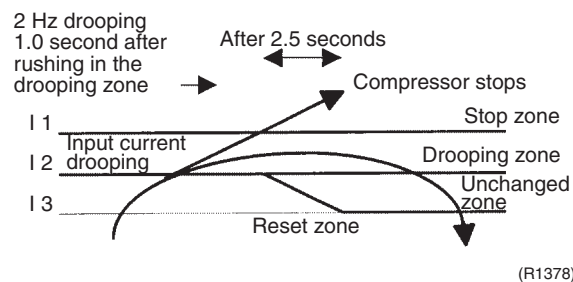

When a "stop current" continues for 2.5 seconds after rushing on the stop zone, the compressor operation stops.

If a "drooping current" is continues for 1.0 second after rushing on the drooping zone, the frequency will be 2 Hz drooping.

Repeating the above drooping continues until the current rushes on the drooping zone without change.

In the unchanged zone, the frequency limit will remain.

In the return / reset zone, the frequency limit will be cancelled.

Limitation of current drooping and stop value according to the outdoor air temperature

- In case the operation mode is cooling
 - The current droops when outdoor air temperature becomes higher than a certain level (model by model).
- In case the operation mode is heating (only for heat pump model)
 - The current droops when outdoor air temperature becomes higher than a certain level (model by model).

3.6 Freeze-up Protection Control

Outline During cooling operation, the signals being sent from the indoor unit allow the operating frequency limitation and then prevent freezing of the indoor heat exchanger. (The signal from the indoor unit must be divided into the zones as the followings.

Detail **Conditions for Start Controlling**
 Judge the controlling start with the indoor heat exchanger temperature after 2 sec from operation start and after 30 sec from changing number of operation room.
Control in Each Zone

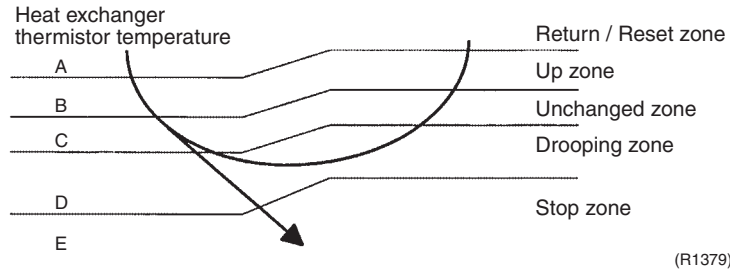

3.7 Heating Peak-cut Control

Outline **Heat Pump Only**
 During heating operation, the signals being sent from the indoor unit allow the operating frequency limitation and prevent abnormal high pressure. (The signal from the indoor unit must be divided as follows.)

Detail **Conditions for Start Controlling**
 Judge the controlling start with the indoor heat exchanger temperature after 2 min from operation start and Δ sec from changing number of operation room.
Control in Each Zone
 The maximum value of heat exchange intermediate temperature of each indoor unit controls the following (excluding stopped rooms).

	Δ
When increase	30
When decrease	2

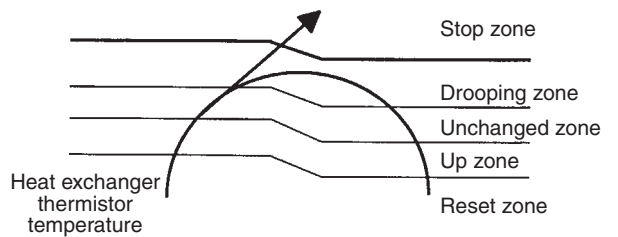

3.8 Fan Control

Outline

Fan control is carried out according to the following priority.

1. Fan ON control for electric component cooling fan
 2. Fan control when defrosting
 3. Fan OFF delay when stopped
 4. ON/OFF control when cooling operation
 5. Fan control when the number of heating rooms decreases
 6. Fan control when forced operation
 7. Fan control in indoor / outdoor unit silent operation
 8. Fan control during heating operation
 9. Fan control in the powerful mode
 10. Fan control for pressure difference upkeep
-

Detail

Fan OFF Control when Stopped

- Fan OFF delay for 60 seconds must be made when the compressor is stopped.

Tap Control in Indoor / Outdoor Unit Silent Operation

1. When Cooling Operation
When the outdoor air temperature is 18 ~ 37°C, the fan tap must be set to M.
When the outdoor air temperature is lower than 18°C, the fan tap must be set to L.
2. When Heating Operation
When the outdoor air temperature is higher than 4°C, the fan tap must be turned to L (only for heat pump model).

3.9 Liquid Compression Protection Function 2

Outline

In order to obtain the dependability of the compressor, the compressor must be stopped according to the conditions of the temperature of the outdoor air and outdoor heat exchanger.

Detail

Heat Pump Model

- Operation stop depending on the outdoor air temperature
Compressor operation turns OFF under the conditions that the system is in cooling operation and outdoor air temperature is below 10°C.

Cooling Only Model

- Operation stops depending on the outdoor air temperature.
Compressor operation turns OFF under the condition that outdoor air temperature is below 10°C.

3.10 Defrost Control

Outline

Heat Pump Only

Defrosting is carried out by the cooling cycle (reverse cycle). The defrosting time or outdoor heat exchanger temperature must be more than its fixed value when finishing.

Detail

Conditions for Starting Defrost

The starting conditions must be made with the outdoor air temperature and heat exchanger temperature. Under the conditions that the system is in heating operation, 6 minutes after the compressor is started and more than 30 minutes of accumulated fine pass since the start of the operation or ending the defrosting.

Conditions for Canceling Defrost

The judgment must be made with heat exchanger temperature. (4°C~12°C)

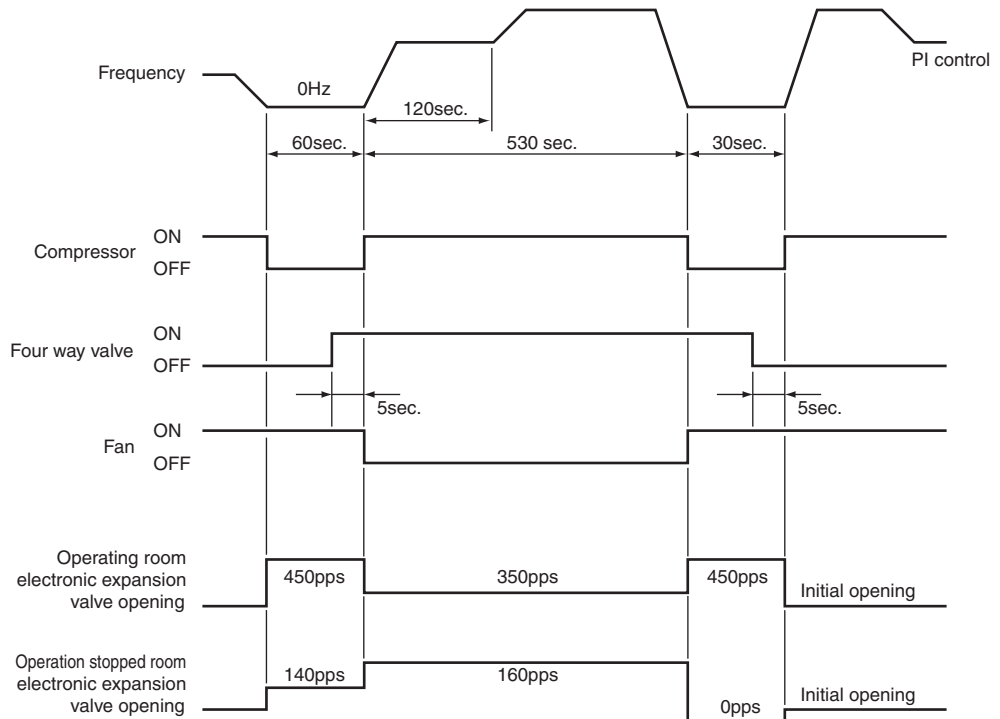

(R2962)

3.11 Electronic Expansion Valve Control

Outline

The following items are included in the electronic expansion valve control.

Electronic expansion valve is fully closed

1. Electronic expansion valve is fully closed when turning on the power.
2. Pressure equalizing control

Room Distribution Control

1. Gas pipe isothermal control
2. SC control (Only for Heat Pump Model)

Open Control

1. Electronic expansion valve control when starting operation
2. Control when frequency changed
3. Control for defrosting (only for heat pump model)
4. Oil recover control
5. Control when a discharge pipe temperature is abnormally high
6. Control when the discharge pipe thermistor is disconnected
7. Control for indoor unit freeze-up protection

Feedback Control

1. Discharge pipe temperature control

Distribution control for each room

1. Liquid pipe temperature control (with all ports connected and all rooms being air-conditioned)
2. Dew prevention function for indoor rotor

Detail

The followings are the examples of control which function in each mode by the electronic expansion valve control.

Operation pattern		Gas pipe isothermal control	SC control (only for heat pump model)	Control when frequency changed	Control for abnormally high discharge pipe temperature	Oil recovery control	Indoor freeze prevention control	Liquid pipe temperature control	Dew buildup prevention control for indoor rotor
When power is turned ON	○ : function × : not function								
↓	Fully closed when power is turned ON	×	×	×	×	×	×	×	×
↓	Cooling, 1 room operation								
↓	Open control when starting	×	×	×	○	○	○	×	×
↓	(Control of target discharge pipe temperature)	×	×	○	○	○	○	×	○
↓	Cooling, 2 rooms operation								
↓	Control when the operating room is changed	×	×	×	○	○	○	×	○
↓	(Control of target discharge pipe temperature)	○	×	○	○	○	○	×	○
↓	Stop								
↓	Pressure equalizing control	×	×	×	×	×	×	×	×
↓	Heating, 1 room operation								
↓	Open control when starting (only for heat pump model)	×	×	×	○	×	×	×	×
↓	(Control of target discharge pipe temperature)	×	○	○	○	×	×	×	×
↓	Heating, 2 rooms operation								
↓	Control when the operating room is changed (only for heat pump model)	×	×	×	○	×	×	×	×
↓	(Control of target discharge pipe temperature)	×	×	○	○	×	×	○	×
↓	(Defrost control FD=1) (only for heat pump model)	×	×	×	×	×	×	×	×
↓	Stop								
↓	Pressure equalizing control	×	×	×	×	×	×	×	×
↓	Heating, 1 room operation								
↓	Open control when starting (only for heat pump model)	×	×	×	○	×	×	×	×
↓	Control of discharge pipe thermistor disconnection	×	○	×	×	×	×	×	×
↓	Continue	×	○	×	×	×	×	×	×
↓	Stop								
↓	Pressure equalizing control	×	×	×	×	×	×	×	×

(R3036)

3.11.1 Fully Closing with Power On

Initialize the electronic expansion valve when turning on the power, set the opening position and develop pressure equalizing.

3.11.2 Pressure Equalization Control

When the compressor is stopped, open and close the electronic expansion valve and develop pressure equalization.

3.11.3 Opening Limit

Outline Limit a maximum and minimum opening of the electronic expansion valve in the operating room.

Detail

- A maximum electronic expansion valve opening in the operating room : 450 pulses
- A minimum electronic expansion valve opening in the operating room : 60 pulses

The electronic expansion valve is fully closed in the room where cooling is stopped and is opened with fixed opening during defrosting.

3.11.4 Starting Operation / Changing Operating Room Control

Control the electronic expansion valve opening when the system is starting or the operating room is changed, and prevent the system to be super heated or moistened.

3.11.5 High Temperature of the Discharge Pipe

When the compressor is operating, if the discharge pipe temperature exceeds a certain value, open the electronic expansion valve and remove the refrigerant to the low pressure side and lower discharge temperature.

3.11.6 Oil Recovery Function

Outline The electronic expansion valve opening in the cooling stopped room must be set as to open for a certain time at a specified interval so that the oil in the cooling stopped room may not be accumulated.

Detail During cooling operation, every 1 hour continuous operation, the electronic expansion valves in the operation stopped room must be opened by 80 pulses for specified time.

3.11.7 Gas Pipe Isothermal Control During Cooling

When the units are operating in multiple rooms, detect the gas piping temperature and correct the electronic expansion valve opening so that the temperature of the gas pipe in each room becomes identical.

- When the gas pipe temperature > the average gas pipe temperature → open the electronic expansion valve in that room
- When the gas pipe temperature < the average gas pipe temperature → close the electronic expansion valve in that room

3.11.8 Disconnection of the Discharge Pipe Thermistor

Outline Detect a disconnected discharge pipe thermistor by comparing the discharge pipe temperature with the condensation temperature. If any is disconnected, open the electronic expansion valve according to the outdoor air temperature and the operating frequency, and operate for a specified time, and then stop.

After 3 minutes of waiting, restart the unit and check if any is disconnected. If any is disconnected stop the system after operating for a specified time. If the disconnection is detected 4 times in succession, then the system will be down.

Detail**Detect Disconnection**

If a 780-second timer for open control becomes over, the following adjustment must be made.

1. When the operation mode is cooling
When the discharge pipe temperature is lower than the outdoor heat exchanger temperature, the discharge pipe thermistor disconnection must be ascertained.
2. When the operation mode is heating (only for heat pump model)
When the discharge pipe temperature is lower than the max temperature of operating room heat exchanger, the discharge pipe thermistor disconnection must be ascertained.

When the condition of the above 1 or 2 is decided, the system will stop after operating for continuous 9 minutes.

Adjustment when the thermistor is disconnected

When compressor stop repeats specified time, the system should be down.

3.11.9 Control when frequency is changed

When the target discharge pipe temperature control is active, if the target frequency is changed for a specified value in a certain time period, cancel the target discharge pipe temperature control and change the target opening of the electronic expansion valve according to the shift.

3.11.10 Target Discharge Pipe Temperature Control

Obtain the target discharge pipe temperature from the indoor and outdoor heat exchange temperature, and adjust the electronic expansion valve opening so that the actual discharge pipe temperature become close to that temperature. (Indirect SH control using the discharge pipe temperature)

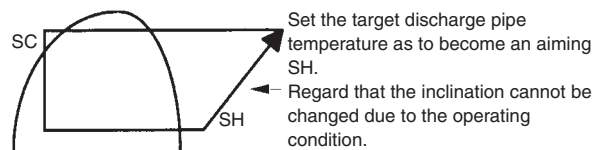

(R1389)

Determine a correction value of the electronic expansion valve compensation and drive it according to the deflection of the target discharge temperature and actual discharge temperature, and the discharge temperature variation by the 20 sec.

3.11.11 SC Control**Outline****Heat Pump Only**

Detect the temperature of liquid pipe and heat exchanger of the rooms and compensate the electronic expansion valve opening so that the SC of each room becomes the target SC.

- When the actual SC is > target SC, open the electronic expansion valve of the room.
- When the actual SC is < target SC, close the electronic expansion valve of the room.

Detail**Start Functioning Conditions**

After finishing the open control (810 seconds after the beginning of the operation), control all the electronic expansion valve in the operating room.

Determine Electronic Expansion Valve Opening

Adjust the electronic expansion valve so that the temperature difference between the maximum heat exchanger temperature of connected room and the temperature of liquid pipe thermistor becomes constant.

3.12 Malfunctions

3.12.1 Sensor Malfunction Detection

Sensor malfunction may occur either in the thermistor or current transformer (CT) system.

Relating to Thermistor Malfunction

1. Outdoor heat exchanger thermistor
2. Discharge pipe thermistor
3. Fin thermistor
4. Gas pipe thermistor
5. Outdoor air thermistor
6. Liquid pipe thermistor

Relating to CT Malfunction

When the output frequency is more than 68 Hz and the input current is less than 1.25A, carry out abnormal adjustment.

3.12.2 Detection of Overload and Over Current

Outline

In order to protect the inverter, detect an excessive output current, and for protecting compressor, monitor the OL operation.

Detail

- If the OL (compressor head) temperature exceeds 120~130°C (depending on the model), the compressor gets interrupted.
- If the inverter current exceeds 22 A, the compressor gets interrupted too.

3.12.3 Insufficient Gas Control

Outline

If a power consumption is below the specified value in which the frequency is higher than the specified frequency, it must be regarded as gas insufficient.
In addition to such conventional function, if the discharge temperature is higher than the target discharge pipe temperature, and the electronic expansion valve is fully open (450 pulses) more than the specified time, it is considered as an insufficient gas.

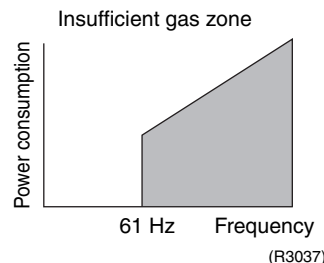

With the conventional function, a power consumption is weak comparing with that in the normal operation when gas is insufficient, and gas insufficiency is detected by checking a power consumption.

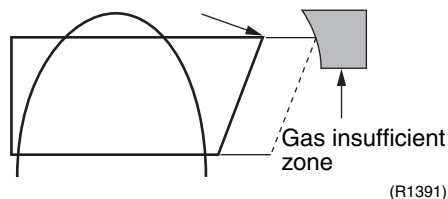

When operating with insufficient gas, although the rise of discharge pipe temperature is great and the electronic expansion valve is open, it is presumed as an insufficient gas if the discharge pipe temperature is higher than the target discharge pipe temperature.

Detail

Judgment by Input Current

When an output frequency is exceeds 61 Hz and the input current is less than specified value, the adjustment is made for insufficient gas.

Judgment by Discharge Pipe Temperature

When discharge pipe temperature is 20°C higher than target value and the electronic expansion value opening is 450 plus (max.), the adjustment is made for insufficient gas.

3.13 Preventing Indoor Freezing

During cooling, if the heat exchanger temperature in the operation stopped room becomes below the specified temperature for the specified time, open the electronic expansion valve in the operation stopped room as specified, and carry out the fully closed operation. After this, if freezing abnormality occurs more than specified time, the system shall be down as the system abnormality.

3.14 Forced Operation Mode

Outline Forced operating mode includes only forced cooling.

Detail

Forced Cooling

Item	Forced Cooling
Forced operation allowing conditions	1) The indoor unit is not abnormal, but the indoor unit which is not in the freezing prohibiting zone is present in more than 1 room.
	2) The outdoor unit is not abnormal and not in the 3-minute stand-by mode.
	The forced operation is allowed when the above "and" conditions are met.
Starting/adjustment	When the indoor unit on/off button is pressed for continuous 5 second as the above conditions are met.
1) Determine operating room	All rooms must operate.
2) Command frequency	70Hz
3) Electronic expansion valve opening	Depending on the capacity of the operating indoor unit.
4) Outdoor unit adjustment	Compressor is in operation
5) Indoor unit adjustment	Transmit the command of forced cooling operation to all indoor units.
End	1) When the indoor units on/off button (of the unit which sent the command) is pressed again.
	2) The operation is to end automatically after 15 min.
Others	The protect functions are prior to all others in the forced operation.

3.15 Additional Function

3.15.1 Powerful Operation Mode

Compressor operating frequency and outdoor unit airflow rate are increased.

3.15.2 Voltage Detection Function

Power supply voltage is detected each time equipment operation starts.

Part 5

System Configuration

1. System Configuration.....	64
2. Instruction (in case of FTK(X)S 20/25/35 CVMB)	65
2.1 Safety Precautions	65
2.2 Names of Parts.....	67
2.3 Preparation before Operation.....	70
2.4 AUTO·DRY·COOL·HEAT·FAN Operation	73
2.5 Adjusting the Air Flow Direction	75
2.6 POWERFUL Operation	77
2.7 OUTDOOR UNIT SILENT Operation	78
2.8 HOME LEAVE Operation	79
2.9 INTELLIGENT EYE Operation	81
2.10 TIMER Operation	83
2.11 Note for Multi System	85
2.12 Care and Cleaning	87
2.13 Troubleshooting.....	90

1. System Configuration

After the installation and test operation of the room air conditioner have been completed, it should be operated and handled as described below. Every user would like to know the correct method of operation of the room air conditioner, to check if it is capable of cooling (or heating) well, and to know a clever method of using it.

In order to meet this expectation of the users, giving sufficient explanations taking enough time can be said to reduce about 80% of the requests for servicing. However good the installation work is and however good the functions are, the customer may blame either the room air conditioner or its installation work because of improper handling. The installation work and handing over of the unit can only be considered to have been completed when its handling has been explained to the user without using technical terms but giving full knowledge of the equipment.

2. Instruction (in case of FTK(X)S 20/25/35 CVMB)

2.1 Safety Precautions

Safety precautions

- Keep this manual where the operator can easily find them.
- Read this manual attentively before starting up the unit.
- For safety reason the operator must read the following cautions carefully.
- This manual classifies precautions into WARNINGS and CAUTIONS. Be sure to follow all precautions below: they are all important for ensuring safety.

WARNING

If you do not follow these instructions exactly, the unit may cause property damage, personal injury or loss of life.

CAUTION

If you do not follow these instructions exactly, the unit may cause minor or moderate property damage or personal injury.



Never do.



Be sure to follow the instructions.



Be sure to earth the air conditioner.



Never cause the air conditioner (including the remote control) to get wet.



Never touch the air conditioner (including the remote control) with a wet hand.





WARNING

- In order to avoid fire, explosion or injury, do not operate the unit when harmful, among which flammable or corrosive gases, are detected near the unit. 
- It is not good for health to expose your body to the air flow for a long time.
- Do not put a finger, a rod or other objects into the air outlet or inlet. As the fan is rotating at a high speed, it will cause injury.
- Do not attempt to repair, relocate, modify or reinstall the air conditioner by yourself. Incorrect work will cause electric shocks, fire etc.
For repairs and reinstallation, consult your Daikin dealer for advice and information.

- The refrigerant used in the air conditioner is safe. Although leaks should not occur, if for some reason any refrigerant happens to leak into the room, make sure it does not come in contact with any flame as of gas heaters, kerosene heaters or gas range. 
- If the air conditioner is not cooling (heating) properly, the refrigerant may be leaking, so call your dealer. When carrying out repairs accompanying adding refrigerant, check the content of the repairs with our service staff.
- Do not attempt to install the air conditioner by your self. Incorrect work will result in water leakage, electric shocks or fire. For installation, consult the dealer or a qualified technician.
- In order to avoid electric shock, fire or injury, if you detect any abnormally such as smell of fire, stop the operation and turn off the breaker. And call your dealer for instructions.





CAUTION

- The air conditioner must be earthed. Incomplete earthing may result in electric shocks. Do not connect the earth line to a gas pipe, water pipe, lightning rod, or a telephone earth line. 
- In order to avoid any quality deterioration, do not use the unit for cooling precision instruments, food, plants, animals or works of art. 
- Never expose little children, plants or animals directly to the air flow.
- Do not place appliances which produce open fire in places exposed to the air flow from the unit or under the indoor unit. It may cause incomplete combustion or deformation of the unit due to the heat.
- Do not block air inlets nor outlets. Impaired air flow may result in insufficient performance or trouble.

- Do not stand or sit on the outdoor unit. Do not place any object on the unit to avoid injury, do not remove the fan guard.
- Do not place anything under the indoor or outdoor unit that must be kept away from moisture. In certain conditions, moisture in the air may condense and drip.
- After a long use, check the unit stand and fittings for damage.
- Do not touch the air inlet and aluminum fins of outdoor unit. It may cause injury.
- The appliance is not intended for use by young children or infirm persons without supervision.
- Young children should be supervised to ensure that they do not play with the appliance.

- To avoid oxygen deficiency, ventilate the room sufficiently if equipment with burner is used together with the air conditioner. 
- Before cleaning, be sure to stop the operation, turn the breaker off or pull out the supply cord.
- Do not connect the air conditioner to a power supply different from the one as specified. It may cause trouble or fire.
- Depending on the environment, an earth leakage breaker must be installed. Lack of an earth leakage breaker may result in electric shocks.
- Arrange the drain hose to ensure smooth drainage. Incomplete draining may cause wetting of the building, furniture etc.

- Do not operate the air conditioner with wet hands. 

- Do not wash the indoor unit with excessive water, only use a slightly wet cloth. 
- Do not place things such as vessels containing water or anything else on top of the unit. Water may penetrate into the unit and degrade electrical insulations, resulting in an electric shock.

Installation site

- To install the air conditioner in the following types of environments, consult the dealer.
 - Places with an oily ambient or where steam or soot occurs.
 - Salty environment such as coastal areas.
 - Places where sulfide gas occurs such as hot springs.
 - Places where snow may block the outdoor unit.

The drain from the outdoor unit must be discharged to a place of good drainage.

Consider nuisance to your neighbours from noises

- For installation, choose a place as described below.
 - A place solid enough to bear the weight of the unit which does not amplify the operation noise or vibration.
 - A place from where the air discharged from the outdoor unit or the operation noise will not annoy your neighbours.

Electrical work

- For power supply, be sure to use a separate power circuit dedicated to the air conditioner.

System relocation

- Relocating the air conditioner requires specialized knowledge and skills. Please consult the dealer if relocation is necessary for moving or remodeling.

2.2 Names of Parts

Names of parts

■ Indoor Unit

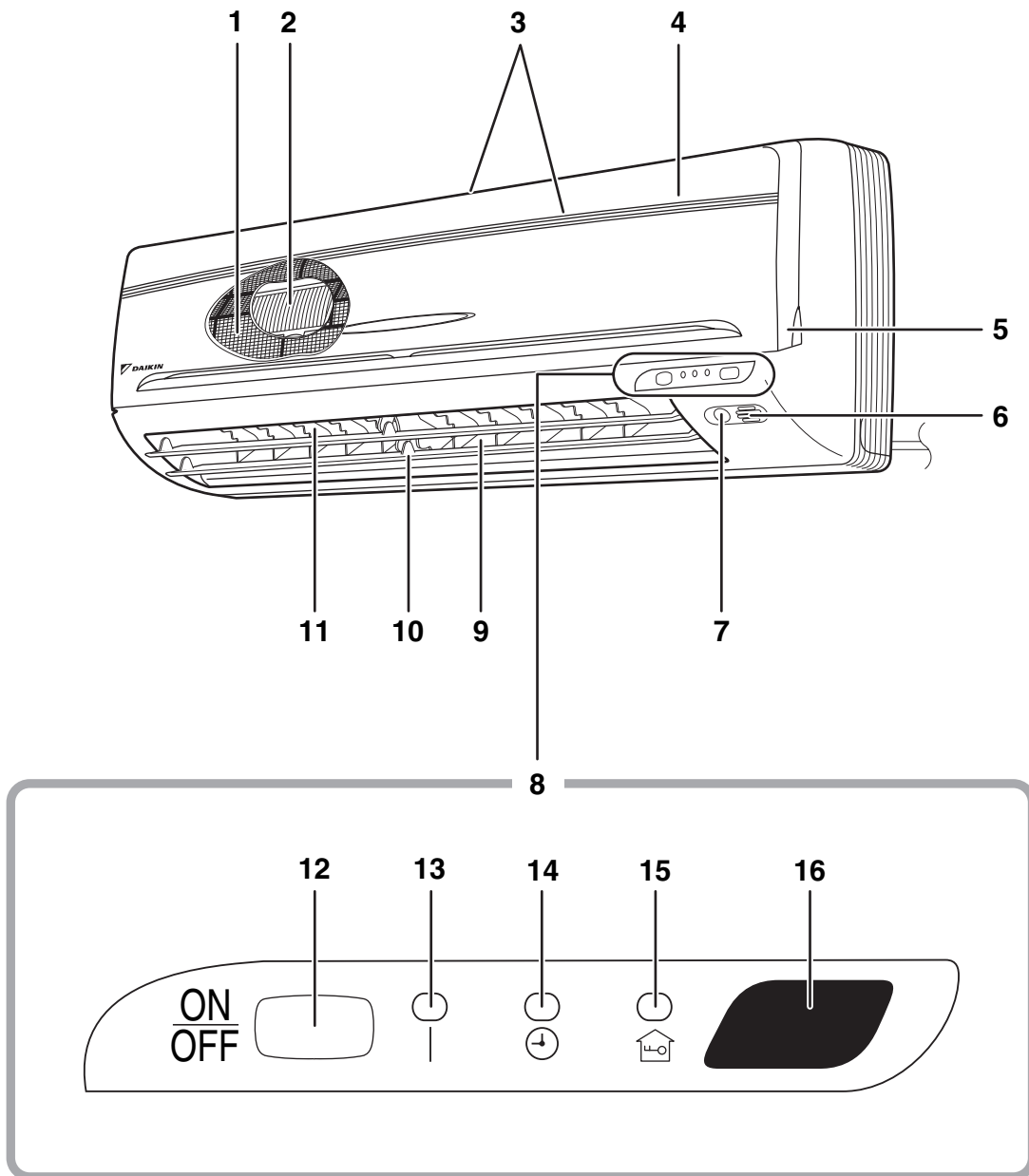

■ Outdoor Unit

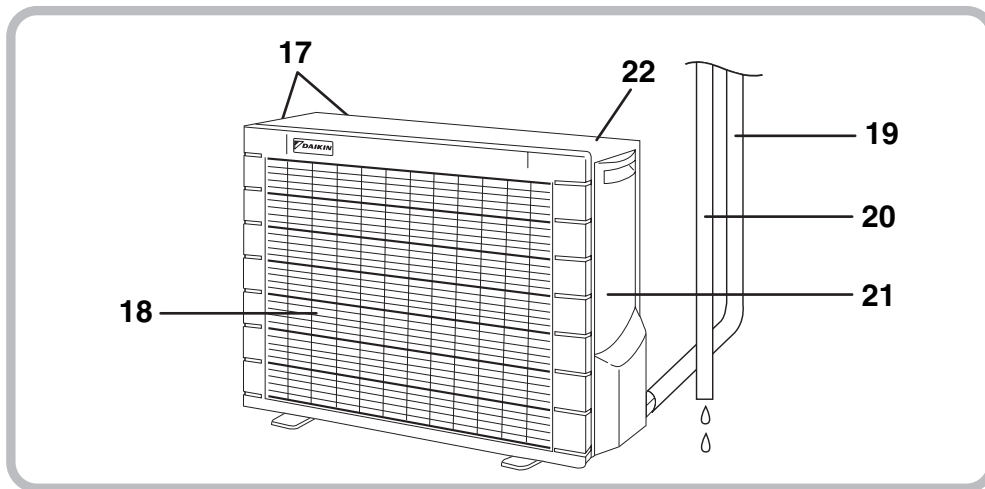

■ Indoor Unit

1. Air filter
2. Air purifying filter with photocatalytic deodorizing function:
 - These filters are attached to the inside of the air filters.
3. Air inlet
4. Front grille
5. Grille tab
6. Room temperature sensor:
 - It senses the air temperature around the unit.
7. INTELLIGENT EYE sensor:
 - It detects the movements of people and automatically switches between normal operation and energy saving operation. (page 18.)
8. Display
9. Air outlet
10. Flaps (horizontal blades): (page 12.)
11. Louvers (vertical blades):
 - The louvers are inside of the air outlet. (page 13.)

12. Indoor Unit ON/OFF switch: (page 10.)

- Push this switch once to start operation. Push once again to stop it.
- The operation mode refers to the following table.

	Mode	Temperature setting	Air flow rate
FTKS	COOL	22°C	AUTO
FTXS	AUTO	25°C	AUTO

- This switch is useful when the remote control is missing.

13. Operation lamp (green)

14. TIMER lamp (yellow): (page 20.)

15. HOME LEAVE lamp (red): (page 16.)

16. Signal receiver:

- It receives signals from the remote control.
- When the unit receives a signal, you will hear a short beep.
 - Operation start beep-beep
 - Settings changed..... beep
 - Operation stop..... beeeeeeep

■ Outdoor Unit

17. Air inlet: (Back and side)
18. Air outlet
19. Refrigerant piping and inter-unit cable
20. Drain hose
21. Earth terminal:
 - It is inside of this cover.
22. Outside air temperature sensor:
 - It senses the ambient temperature around the unit.

Appearance of the outdoor unit may differ from some models.

■ Remote Control

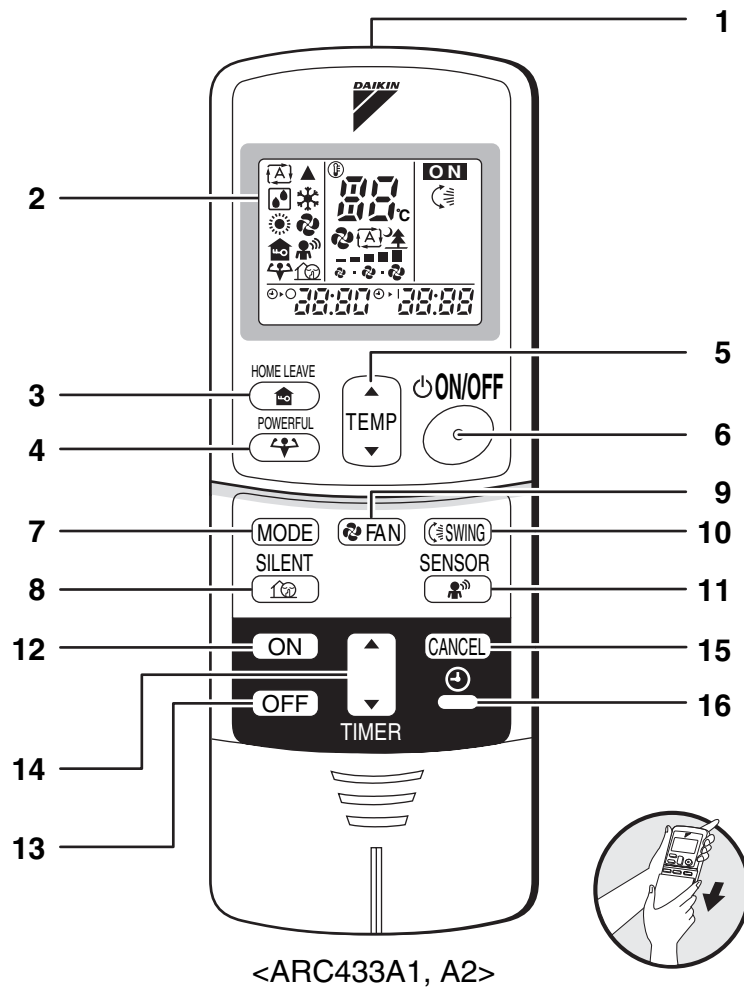

- 1. Signal transmitter:**
 - It sends signals to the indoor unit.
- 2. Display:**
 - It displays the current settings.
(In this illustration, each section is shown with all its displays ON for the purpose of explanation.)
- 3. HOME LEAVE button:**
for HOME LEAVE operation (page 16.)
- 4. POWERFUL button:**
for POWERFUL operation (page 14.)
- 5. TEMPERATURE adjustment buttons:**
 - It changes the temperature setting.
- 6. ON/OFF button:**
 - Press this button once to start operation.
Press once again to stop it.
- 7. MODE selector button:**
 - It selects the operation mode.
(AUTO/DRY/COOL/HEAT/FAN) (page 10.)
- 8. SILENT button:** for OUTDOOR UNIT SILENT operation (page 15.)
- 9. FAN setting button:**
 - It selects the air flow rate setting.
- 10. SWING button:** (page 12.)
- 11. SENSOR button:** for INTELLIGENT EYE operation (page 18.)
- 12. ON TIMER button:** (page 21.)
- 13. OFF TIMER button:** (page 20.)
- 14. TIMER Setting button:**
 - It changes the time setting.
- 15. TIMER CANCEL button:**
 - It cancels the timer setting.
- 16. CLOCK button:** (page 9.)

2.3 Preparation before Operation

Preparation Before Operation

■ To set the batteries

1. Press  with a finger and slide the front cover to take it off.
2. Set two dry batteries (AAA).
3. Set the front cover as before.

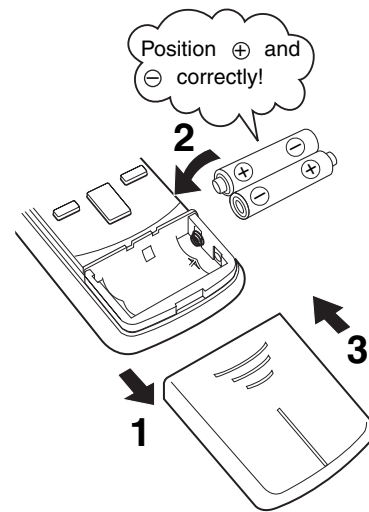

ATTENTION

■ About batteries

- When replacing the batteries, use batteries of the same type, and replace the two old batteries together.
- When the system is not used for a long time, take the batteries out.
- We recommend replacing once a year, although if the remote control display begins to fade or if reception deteriorates, please replace with new alkali batteries. Using manganese batteries reduces the lifespan.
- The attached batteries are provided for the initial use of the system.
The usable period of the batteries may be short depending on the manufactured date of the air conditioner.

Preparation Before Operation

■ To operate the remote control

- To use the remote control, aim the transmitter at the indoor unit. If there is anything to block signals between the unit and the remote control, such as a curtain, the unit will not operate.
- Do not drop the remote control. Do not get it wet.
- The maximum distance for communication is about 7 m.

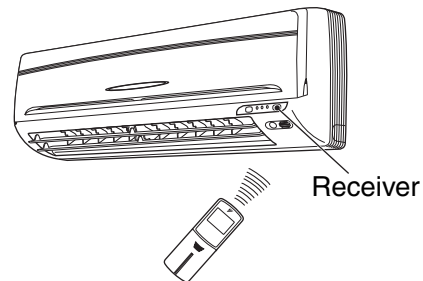

■ To fix the remote control holder on the wall

1. Choose a place from where the signals reach the unit.
2. Fix the holder to a wall, a pillar, or similar location with the screws procured locally.
3. Place the remote control in the remote control holder.

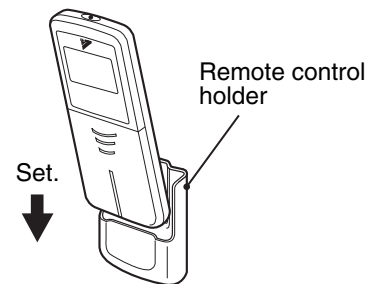

- To remove, pull it upwards.

ATTENTION

■ About remote control

- Never expose the remote control to direct sunlight.
- Dust on the signal transmitter or receiver will reduce the sensitivity. Wipe off dust with soft cloth.
- Signal communication may be disabled if an electronic-starter-type fluorescent lamp (such as inverter-type lamps) is in the room. Consult the shop if that is the case.
- If the remote control signals happen to operate another appliance, move that appliance to somewhere else, or consult the shop.

■ To set the clock

1. Press “CLOCK button”.

0:00 is displayed.

⊖ blinks.

2. Press “TIMER setting button” to set the clock to the present time.

Holding down “▲” or “▼” button rapidly increases or decreases the time display.

3. Press “CLOCK button”.

⋮ blinks.

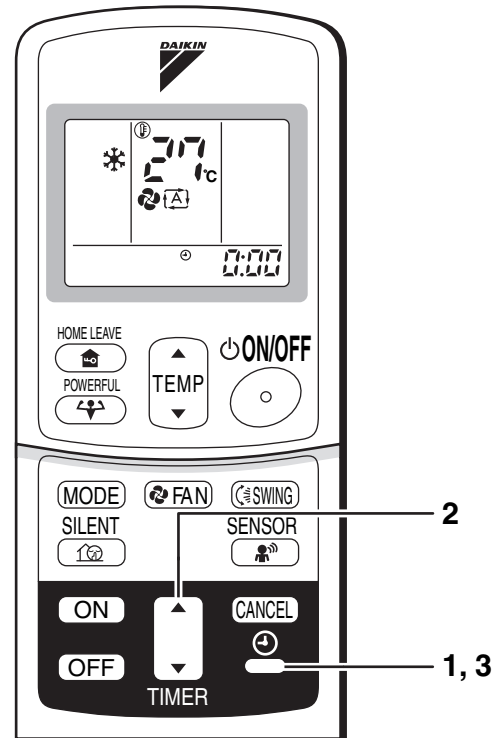

■ Turn the breaker ON

- Turning ON the breaker opens the flap, then closes it again. (This is a normal procedure.)

NOTE

■ Tips for saving energy

- Be careful not to cool (heat) the room too much. Keeping the temperature setting at a moderate level helps save energy.
- Cover windows with a blind or a curtain. Blocking sunlight and air from outdoors increases the cooling (heating) effect.
- Clogged air filters cause inefficient operation and waste energy. Clean them once in about every two weeks.

Recommended temperature setting
For cooling: 26°C – 28°C
For heating: 20°C – 24°C

■ Please note

- The air conditioner always consumes 15-35 watts of electricity even while it is not operating.
- If you are not going to use the air conditioner for a long period, for example in spring or autumn, turn the breaker OFF.
- Use the air conditioner in the following conditions.

Mode	Operating conditions	If operation is continued out of this range
COOL	Outdoor temperature: <2MK(X)S> 10 to 46 °C <3/4MK(X)S> -10 to 46 °C <RK(X)S> -10 to 46 °C <RK(X)H> 10 to 46 °C Indoor temperature: 18 to 32 °C Indoor humidity: 80% max.	<ul style="list-style-type: none"> • A safety device may work to stop the operation. (In multi system, it may work to stop the operation of the outdoor unit only.) • Condensation may occur on the indoor unit and drip.
HEAT	Outdoor temperature: <2MXS> -10 to 21 °C <3/4MXS> -15 to 21 °C <RXS> -15 to 21 °C <RXH> -10 to 21 °C Indoor temperature: 10 to 30 °C	<ul style="list-style-type: none"> • A safety device may work to stop the operation.
DRY	Outdoor temperature: <2MK(X)S> 10 to 46 °C <3/4MK(X)S> -10 to 46 °C <RK(X)S> -10 to 46 °C <RK(X)H> 10 to 46 °C Indoor temperature: 18 to 32 °C Indoor humidity: 80% max.	<ul style="list-style-type: none"> • A safety device may work to stop the operation. • Condensation may occur on the indoor unit and drip.

- Operation outside this humidity or temperature range may cause a safety device to disable the system.

2.4 AUTO·DRY·COOL·HEAT·FAN Operation

AUTO · DRY · COOL · HEAT · FAN Operation





The air conditioner operates with the operation mode of your choice.

From the next time on, the air conditioner will operate with the same operation mode.

■ To start operation

1. Press “MODE selector button” and select a operation mode.

- Each pressing of the button advances the mode setting in sequence.

-  : AUTO
 : DRY
 : COOL
 : HEAT
 : FAN

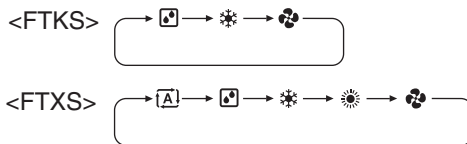

2. Press “ON/OFF button”.

- The OPERATION lamp lights up.



■ To stop operation

3. Press “ON/OFF button” again.

- Then OPERATION lamp goes off.

■ To change the temperature setting



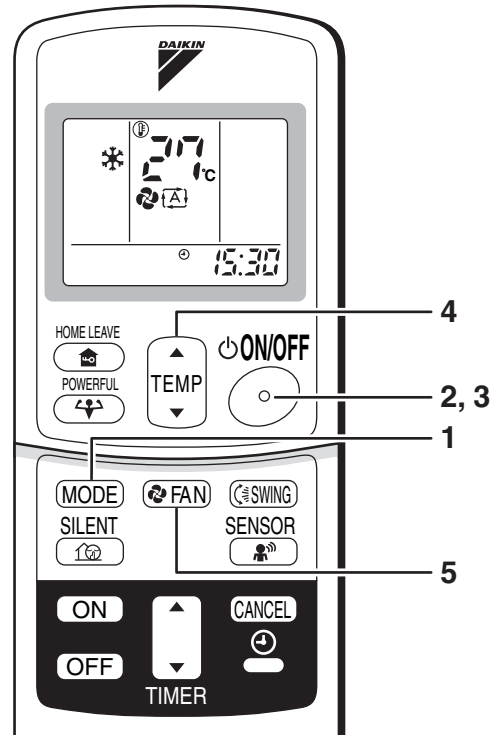

4. Press “TEMPERATURE adjustment button”

DRY or FAN mode	AUTO or COOL or HEAT mode
The temperature setting is not variable.	Press “▲” to raise the temperature and press “▼” to lower the temperature.
	Set to the temperature you like. 



■ To change the air flow rate setting

5. Press “FAN setting button”.

DRY mode	AUTO or COOL or HEAT or FAN mode
The air flow rate setting is not variable.	Five levels of air flow rate setting from “  ” to “  ” plus “  ” “  ” are available. 

- Indoor unit quiet operation

When the air flow is set to “”, the noise from the indoor unit will become quieter. Use this when making the noise quieter.

The unit might lose capacity when the air flow rate is set to a weak level.

NOTE

■ Note on HEAT operation

- Since this air conditioner heats the room by taking heat from outdoor air to indoors, the heating capacity becomes smaller in lower outdoor temperatures. If the heating effect is insufficient, it is recommended to use another heating appliance in combination with the air conditioner.
- The heat pump system heats the room by circulating hot air around all parts of the room. After the start of heating operation, it takes some time before the room gets warmer.
- In heating operation, frost may occur on the outdoor unit and lower the heating capacity. In that case, the system switches into defrosting operation to take away the frost.
- During defrosting operation, hot air does not flow out of indoor unit.

■ Note on DRY operation

- The computer chip works to rid the room of humidity while maintaining the temperature as much as possible. It automatically controls temperature and fan strength, so manual adjustment of these functions is unavailable.

■ Note on AUTO operation

- In AUTO operation, the system selects an appropriate operation mode (COOL or HEAT) based on the room temperature at the start of the operation.
- The system automatically reselects setting at a regular interval to bring the room temperature to usersetting level.
- If you do not like AUTO operation, you can manually select the operation mode and setting you like.

■ Note on air flow rate setting

- At smaller air flow rates, the cooling (heating) effect is also smaller.

2.5 Adjusting the Air Flow Direction

Adjusting the Air Flow Direction

You can adjust the air flow direction to increase your comfort.

■ To adjust the horizontal blades (flaps)

1. Press “SWING button”.

 The display will light up and the flaps will begin to swing.

2. When the flaps have reached the desired position, press “SWING button” once more.

The display will go blank.
The flaps will stop moving.

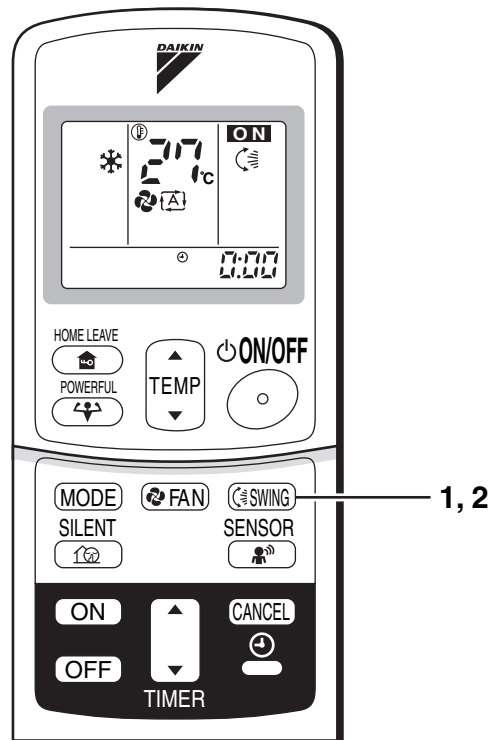

■ To adjust the vertical blades (louvers)

Hold the knob and move the louvers.
 (You will find a knob on the left-side and the right-side blades.)

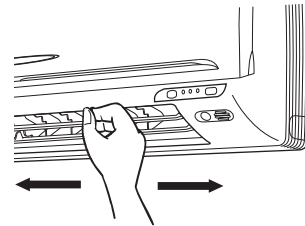

Notes on flaps and louvers angles

- When “ **SWING button** ” is selected, the flaps swinging range depends on the operation mode. (See the figure.)

■ ATTENTION

- Always use a remote control to adjust the flaps angle. If you attempt to move it forcibly with hand when it is swinging, the mechanism may be broken.
- Be careful when adjusting the louvers. Inside the air outlet, a fan is rotating at a high speed.

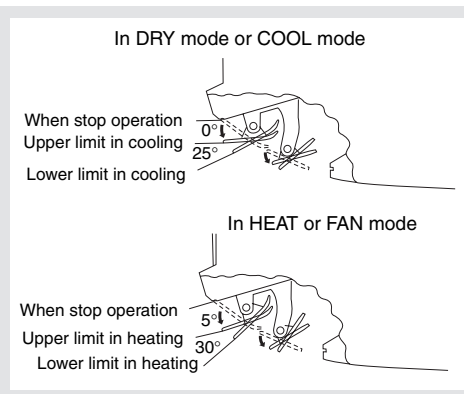

2.6 POWERFUL Operation

POWERFUL Operation

POWERFUL operation quickly maximizes the cooling (heating) effect in any operation mode. You can get the maximum capacity.

■ To start POWERFUL operation

1. Press “POWERFUL button”.

- POWERFUL operation ends in 20 minutes. Then the system automatically operates again with the settings which were used before POWERFUL operation.
- When using POWERFUL operation, there are some functions which are not available.

■ To cancel POWERFUL operation

2. Press “POWERFUL button” again.

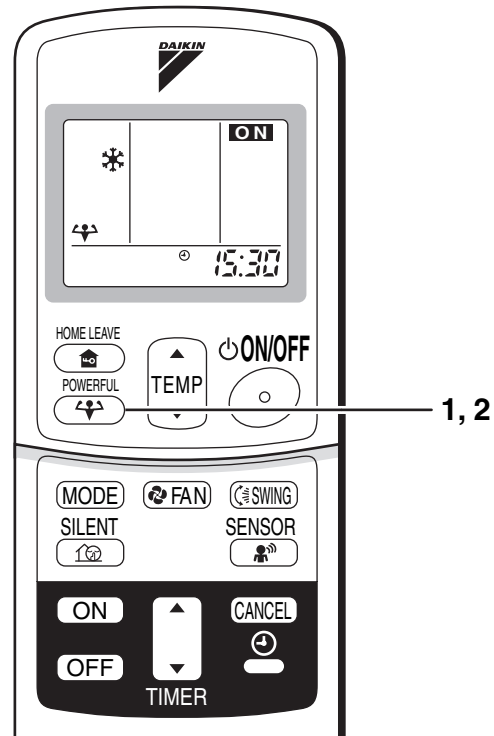

NOTE

■ Notes on POWERFUL operation

- **In COOL and HEAT mode**
To maximize the cooling (heating) effect, the capacity of outdoor unit must be increased and the air flow rate be fixed to the maximum setting. The temperature and air flow settings are not variable.
- **In DRY mode**
The temperature setting is lowered by 2.5°C and the air flow rate is slightly increased.
- **In FAN mode**
The air flow rate is fixed to the maximum setting.
- **When using priority-room setting**
See “Note for multi system” (page 22.)

2.7 OUTDOOR UNIT SILENT Operation

OUTDOOR UNIT SILENT Operation

OUTDOOR UNIT SILENT operation lowers the noise level of the outdoor unit by changing the frequency and fan speed on the outdoor unit. This function is convenient during night.

■ To start OUTDOOR UNIT SILENT operation

1. Press “SILENT button”.

■ To cancel OUTDOOR UNIT SILENT operation

2. Press “SILENT button” again.

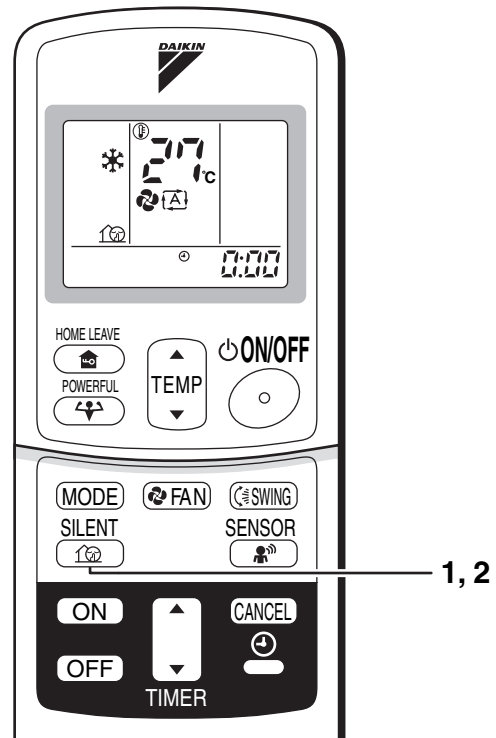

NOTE

■ Note on OUTDOOR UNIT SILENT operation

- If using a multi system, this function will work only when the OUTDOOR UNIT SILENT operation is set on all operated indoor units. However, if using priority-room setting, see “Note for multi system” (page 22.)
- This function is available in COOL, HEAT, and AUTO modes. (This is not available in FAN and DRY mode.)
- POWERFUL operation and OUTDOOR UNIT SILENT operation cannot be used at the same time. Priority is given to POWERFUL operation.
- If operation is stopped using the remote control or the main unit ON/OFF switch when using OUTDOOR UNIT SILENT operation, “” will remain on the remote control display.
- **This function does not work when connected to the RX(K)H20, 25, or 35CVMB.**

2.8 HOME LEAVE Operation

HOME LEAVE Operation

HOME LEAVE operation is a function which allows you to record your preferred temperature and air flow rate settings.

■ To start HOME LEAVE operation

1. Press “HOME LEAVE button”.

- The HOME LEAVE lamp lights up.



■ To cancel HOME LEAVE operation

2. Press “HOME LEAVE button” again.

- The HOME LEAVE lamp goes off.

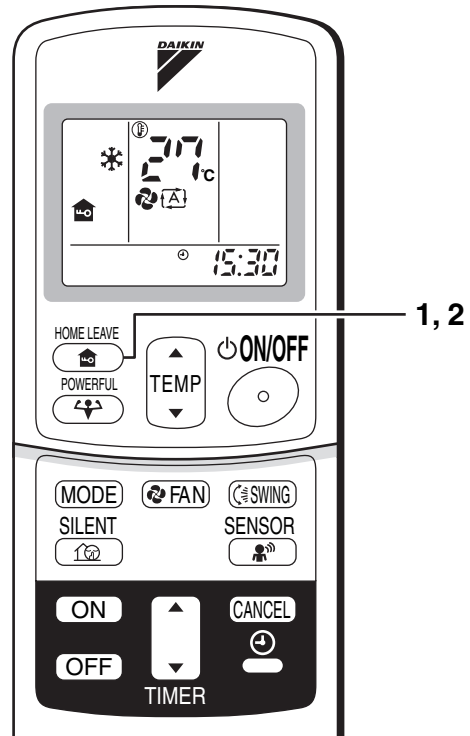

Before using HOME LEAVE operation.

■ To set the temperature and air flow rate for HOME LEAVE operation

When using HOME LEAVE operation for the first time, please set the temperature and air flow rate for HOME LEAVE operation. Record your preferred temperature and air flow rate.

	Initial setting		Selectable range	
	temperature	Air flow rate	temperature	Air flow rate
Cooling	25°C	AUTO	18-32°C	5 step, AUTO and SILENT
Heating	25°C	AUTO	10-30°C	5 step, AUTO and SILENT

1. Press “HOME LEAVE button”. Make sure “” is displayed in the remote control display.

2. Adjust the set temperature with “▲” or “▼” as you like.

3. Adjust the air flow rate with “FAN” setting button as you like.

Home leave operation will run with these settings the next time you use the unit. To change the recorded information, repeat steps 1 – 3.

■ What's the HOME LEAVE operation

Is there a set temperature and air flow rate which is most comfortable, a set temperature and air flow rate which you use the most? HOME LEAVE operation is a function that allows you to record your favorite set temperature and air flow rate. You can start your favorite operation mode simply by pressing the HOME LEAVE button on the remote control. This function is convenient in the following situations.

■ Useful in these cases.

1. Use as an energy-saving mode

Set the temperature 2-3°C higher (cooling) or lower (heating) than normal. Setting the fan strength to the lowest setting allows the unit to be used in energy-saving mode. Also convenient for use while you are out or sleeping.

- Every day before you leave the house...



When you go out, push the "HOME LEAVE Operation" button, and the air conditioner will adjust capacity to reach the preset temperature for HOME LEAVE Operation.

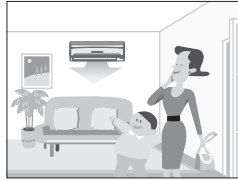

When you return, you will be welcomed by a comfortably air conditioned room.

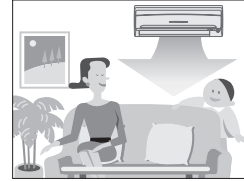

Push the "HOME LEAVE Operation" button again, and the air conditioner will adjust capacity to the set temperature for normal operation.

- Before bed...



Set the unit to HOME LEAVE Operation before leaving the living room when going to bed.



The unit will maintain the temperature in the room at a comfortable level while you sleep.

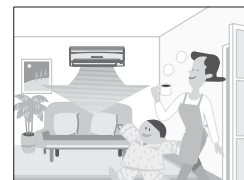

When you enter the living room in the morning, the temperature will be just right. Disengaging HOME LEAVE Operation will return the temperature to that set for normal operation. Even the coldest winters will pose no problem!

2. Use as a favorite mode

Once you record the temperature and air flow rate settings you most often use, you can retrieve them by pressing HOME LEAVE button. You do not have to go through troublesome remote control operations.

NOTE

- Once the temperature and air flow rate for HOME LEAVE operation are set, those settings will be used whenever HOME LEAVE operation is used in the future. To change these settings, please refer to the "Before using HOME LEAVE operation" section above.
- HOME LEAVE operation is only available in COOL and HEAT mode. Cannot be used in AUTO, DRY, and FAN mode.
- HOME LEAVE operation runs in accordance with the previous operation mode (COOL or HEAT) before using HOME LEAVE operation.
- HOME LEAVE operation and POWERFUL operation cannot be used at the same time. Last button that was pressed has priority.
- The operation mode cannot be changed while HOME LEAVE operation is being used.
- When operation is shut off during HOME LEAVE operation, using the remote control or the indoor unit ON/OFF switch, "🏠" will remain on the remote control display.

2.9 INTELLIGENT EYE Operation

INTELLIGENT EYE Operation

“INTELLIGENT EYE” is the infrared sensor which detects the human movement.

■ To start INTELLIGENT EYE operation

1. Press “SENSOR button”.

■ To cancel the INTELLIGENT EYE operation

2. Press “SENSOR button” again.

[EX.]

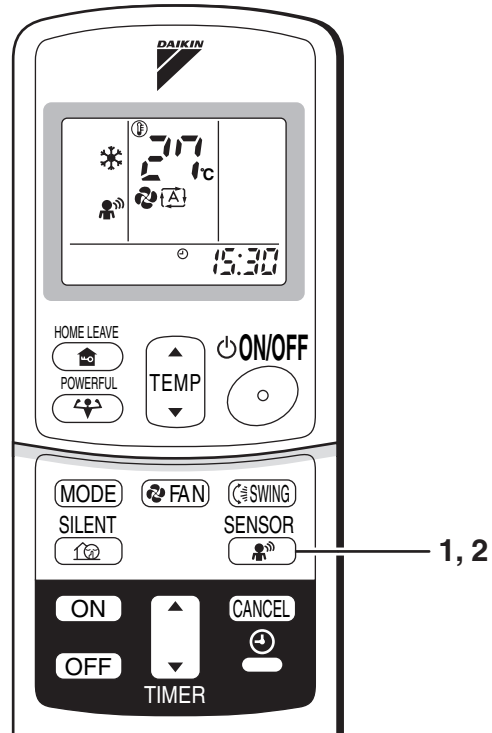
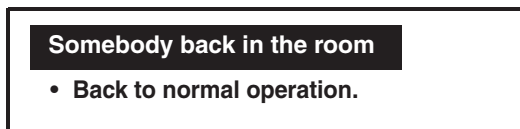
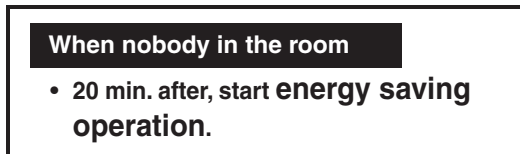

■ To adjust the angle of the INTELLIGENT EYE sensor

- You can adjust the angle of the INTELLIGENT EYE sensor to increase the detection area. (Adjustable angle: 15° to right and left of centre)

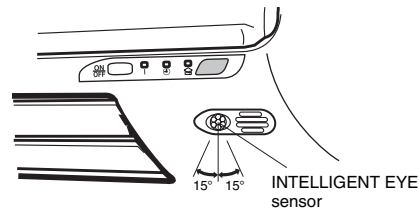

- Gently push and slide the sensor to adjust the angle.
- After adjusting the angle, wipe the sensor gently with a clean cloth, being careful not to scratch the sensor.

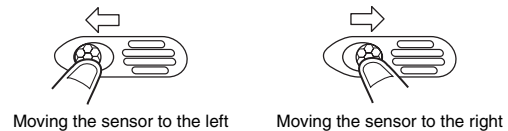

“INTELLIGENT EYE” is useful for Energy Saving

■ Energy saving operation

- Change the temperature -2°C in heating / $+2^{\circ}\text{C}$ in cooling / $+1^{\circ}\text{C}$ in dry mode from set temperature.
- Decrease the air flow rate slightly in fan operation. (In FAN mode only)

Notes on “INTELLIGENT EYE”

- Application range is as follows.

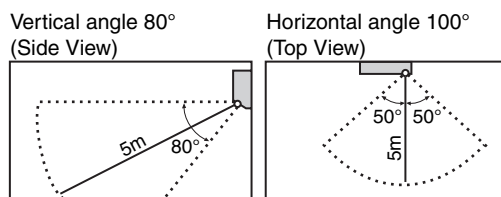

- Sensor may not detect moving objects further than 5m away. (Check the application range)
- Sensor detection sensitivity changes according to indoor unit location, the speed of passersby, temperature range, etc.
- The sensor also mistakenly detects pets, sunlight, fluttering curtains and light reflected off of mirrors as passersby.
- INTELLIGENT EYE operation will not go on during powerful operation.
- Night set mode (page 20.) will not go on during you use INTELLIGENT EYE operation.

⚠ CAUTION

- Do not place large objects near the sensor. Also keep heating units or humidifiers outside the sensor’s detection area. This sensor can detect objects it shouldn’t as well as not detect objects it should.
- Do not hit or violently push the INTELLIGENT EYE sensor. This can lead to damage and malfunction.

2.10 TIMER Operation

TIMER Operation

Timer functions are useful for automatically switching the air conditioner on or off at night or in the morning. You can also use OFF TIMER and ON TIMER in combination.

■ To use OFF TIMER operation

- Check that the clock is correct.
If not, set the clock to the present time.
(page 9.)

1. Press “OFF TIMER button”.

0:00 is displayed.

⊕-⊖ blinks.

2. Press “TIMER Setting button” until the time setting reaches the point you like.

- Every pressing of either button increases or decreases the time setting by 10 minutes.
Holding down either button changes the setting rapidly.

3. Press “OFF TIMER button” again.

- The TIMER lamp lights up.

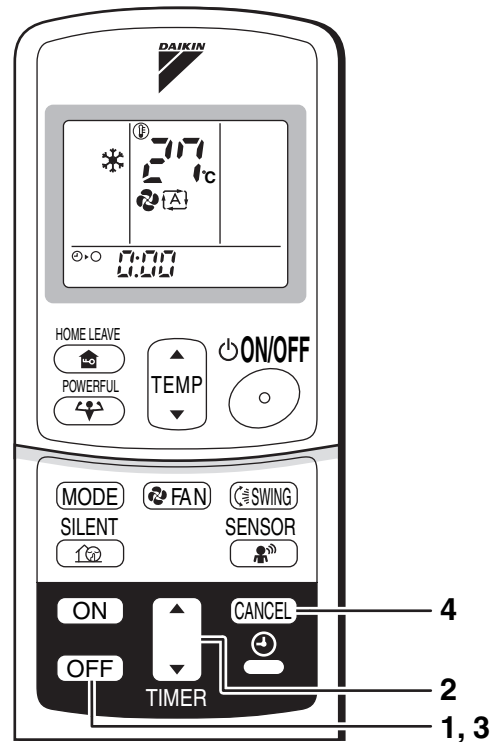

■ To cancel the OFF TIMER operation

4. Press “CANCEL button”.

- The TIMER lamp goes off.

Notes

- When TIMER is set, the present time is not displayed.
- Once you set ON, OFF TIMER, the time setting is kept in the memory. (The memory is canceled when remote control batteries are replaced.)
- When operating the unit via the ON/OFF Timer, the actual length of operation may vary from the time entered by the user.

■ NIGHT SET MODE

When the OFF TIMER is set, the air conditioner automatically adjusts the temperature setting (0.5°C up in COOL, 2.0°C down in HEAT) to prevent excessive cooling (heating) for your pleasant sleep.

■ To use ON TIMER operation

- Check that the clock is correct. If not, set the clock to the present time (page 9.).

1. Press “ON TIMER button”.

6:00 is displayed.

⊕▷| blinks.

2. Press “TIMER Setting button” until the time setting reaches the point you like.

- Every pressing of either button increases or decreases the time setting by 10 minutes. Holding down either button changes the setting rapidly.

3. Press “ON TIMER button” again.

- The TIMER lamp lights up.

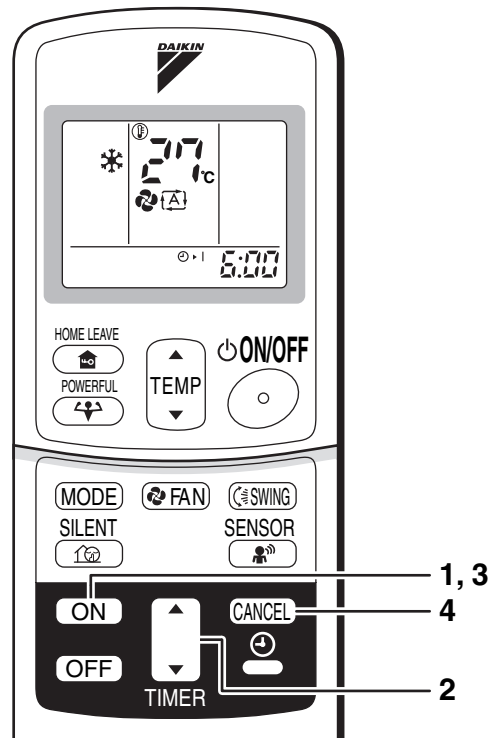

■ To cancel ON TIMER operation

4. Press “CANCEL button”.

- The TIMER lamp goes off.

■ To combine ON TIMER and OFF TIMER

- A sample setting for combining the two timers is shown below.

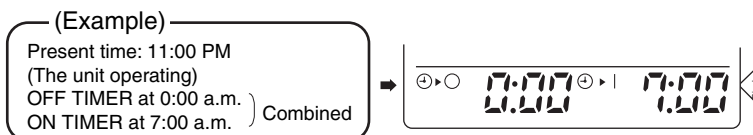

ATTENTION

- In the following cases, set the timer again.
 - After a breaker has turned OFF.
 - After a power failure.
 - After replacing batteries in the remote control.

2.11 Note for Multi System

Note for Multi System

<<What is a “Multi System”?>>

This system has one outdoor unit connected to multiple indoor units. Functions depend on the model. See the list of functions and applicable models (*2) on the next page.

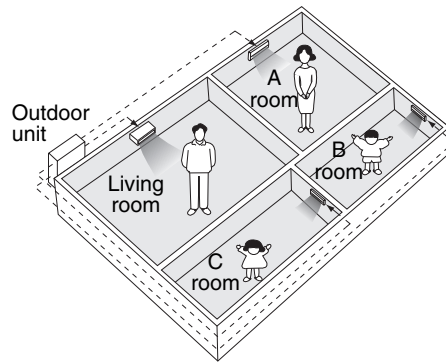

■ Selecting the Operation Mode

1. With the Priority Room Setting present but inactive or not present

When more than one indoor unit is operating, priority is given to the first unit that was turned on.

In this case, set the units that are turned on later to the same operation mode (*1) as the first unit.

Otherwise, they will enter the Standby Mode, and the operation lamp will flash; this does not indicate malfunction.

(*1)

- COOL, DRY and FAN mode may be used at the same time.
- AUTO mode automatically selects COOL mode or HEAT mode based on the room temperature. Therefore, AUTO mode is available when selecting the same operation mode as that of the room with the first unit to be turned on.

<CAUTION>

Normally, the operation mode in the room where the unit is first run is given priority, but the following situations are exceptions, so please keep this in mind.

If the operation mode of the first room is **FAN Mode**, then using **Heating Mode** in any room after this will give priority to **heating**. In this situation, the air conditioner running in FAN Mode will go on standby, and the operation lamp will flash.

2. With the Priority Room Setting active

See “Priority Room Setting” on the next page.

■ NIGHT QUIET Mode (Available only for cooling operation)

NIGHT QUIET Mode requires initial programming during installation. Please consult your retailer or dealer for assistance. NIGHT QUIET Mode reduces the operation noise of the outdoor unit during the night time hours to prevent annoyance to neighbors.

- The NIGHT QUIET Mode is activated when the temperature drops 5°C or more below the highest temperature recorded that day. Therefore, when the temperature difference is less than 5°C, this function will not be activated.
- NIGHT QUIET Mode reduces slightly the cooling efficiency of the unit.

■ OUTDOOR UNIT SILENT Operation (page 15)

1. With the Priority Room Setting present but inactive or not present

When using the OUTDOOR UNIT SILENT operation feature with the Multi system, set all indoor units to OUTDOOR UNIT SILENT operation using their remote controllers.

When clearing OUTDOOR UNIT SILENT operation, clear one of the operating indoor units using their remote controller.

However OUTDOOR UNIT SILENT operation display remains on the remote controller for other rooms.

We recommend you release all rooms using their remote controllers.

2. With the Priority Room Setting active

See “Priority Room Setting” on the next page.

■ Cooling / Heating Mode Lock (Available only for heat pump models)

The Cooling / Heating Mode Lock requires initial programming during installation. Please consult your retailer or dealer for assistance. The Cooling / Heating Mode Lock sets the unit forcibly to either Cooling or Heating Mode. This function is convenient when you wish to set all indoor units connected to the Multi system to the same operation mode.

■ Priority Room Setting

The Priority Room Setting requires initial programming during installation. Please consult your retailer or dealer for assistance.

The room designated as the Priority Room takes priority in the following situations.

1. Operation Mode Priority

As the operation mode of the Priority Room takes precedence, the user can select a different operation mode from other rooms.

<Example>

* Room A is the Priority Room in the examples.

When COOL mode is selected in Room A while operating the following modes in Room B,C and D :

Operation mode in Room B, C and D	Status of Room B, C and D when the unit in Room A is in COOL mode
COOL or DRY or FAN	Current operation mode maintained
HEAT	The unit enters Standby Mode. Operation resumes when the Room A unit stops operating.
AUTO	If the unit is set to COOL mode, operation continues. If set to HEAT mode, it enters Standby Mode. Operation resumes when the Room A unit stops operating.

2. Priority when POWERFUL operation is used

<Example>

* Room A is the Priority Room in the examples.

The indoor units in Rooms A,B,C and D are all operating. If the unit in Room A enters POWERFUL operation, operation capacity will be concentrated in Room A. In such a case, the cooling (heating) efficiency of the units in Rooms B,C and D may be slightly reduced.

3. Priority when using OUTDOOR UNIT SILENT operation

<Example>

* Room A is the Priority Room in the examples.

Just by setting the unit in Room A to SILENT operation, the air conditioner starts OUTDOOR UNIT SILENT operation.

You don't have to set all the operated indoor units to SILENT operation.

■ Maximum Power Input Limitation

- The Maximum Power Input Limitation needs to be set when the unit is installed. Contact DAIKIN dealer.
- This function limits the power input of the unit to 1700W. It is recommended for locations with low-capacity circuit breakers.

(*2) List of functions and applicable models

	2MKS / 2AMKS	2MXS / 2AMXS	3MKS	3MXS	4MKS	4MXS
Priority Room Setting	—	—	○	○	○	○
NIGHT QUIET Mode	—	—	○	○	○	○
Cooling/Heating Mode Lock	—	—	—	○	—	○
Maximum Power Input Limitation	○	—	○	—	—	—

○ Function available

— Function unavailable

NOTE

- Cooling capacity will drop if the Maximum Power Input Limitation is used.

2.12 Care and Cleaning

Care and Cleaning



CAUTION Before cleaning, be sure to stop the operation and turn the breaker OFF.

Units

■ Indoor unit, Outdoor unit and Remote control

1. Wipe them with dry soft cloth.

■ Front grille

1. Open the front grille.

- Hold the grille by the tabs on the two sides and lift it until it stops with a click.

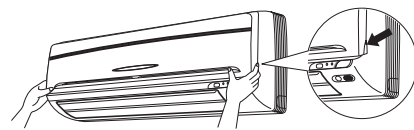

2. Remove the front grille.

- Supporting the front grille with one hand, release the lock by sliding down the knob with the other hand.
- To remove the front grille, pull it toward yourself with both hands.

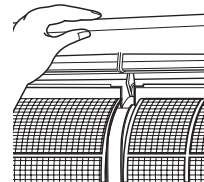

3. Clean the front grille.

- Wipe it with a soft cloth soaked in water.
- Only neutral detergent may be used.
- In case of washing the grille with water, dry it with cloth, dry it up in the shade after washing.

4. Attach the front grille.

- Set the 3 keys of the front grille into the slots and push them in all the way.
- Close the front grille slowly and push the grille at the 3 points.
(1 on each side and 1 in the middle.)
- Check to see if the rotating axis in the upper center section is moving.

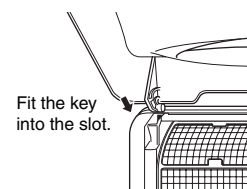

CAUTION

- Don't touch the metal parts of the indoor unit. If you touch those parts, this may cause an injury.
- When removing or attaching the front grille, use a robust and stable stool and watch your steps carefully.
- When removing or attaching the front grille, support the grille securely with hand to prevent it from falling.
- For cleaning, do not use hot water above 40 °C, benzine, gasoline, thinner, nor other volatile oils, polishing compound, scrubbing brushes, nor other hand stuff.
- After cleaning, make sure that the front grille is securely fixed.

Filters

1. Open the front grille. (page 24)

2. Pull out the air filters.

- Push a little upwards the tab at the center of each air filter, then pull it down.

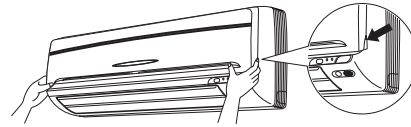

3. Take off the air purifying filter with photocatalytic deodorizing function.

- Hold the recessed parts of the frame and unhook the four claws.

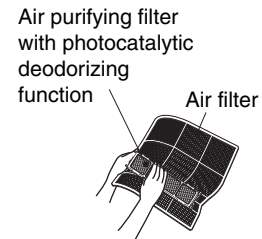
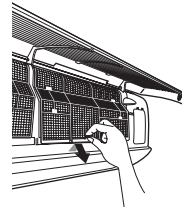

4. Clean or replace each filter.

See below.

5. Set the air filter and the air purifying filter with photocatalytic deodorizing function as they were and close the front grille.

- Insert claws of the filters into slots of the front grille. Close the front grille slowly and push the grille at the 3 points. (1 on each side and 1 in the middle.)

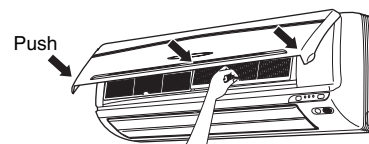

■ Air Filter

1. Wash the air filters with water or clean them with vacuum cleaner.

- If the dust does not come off easily, wash them with neutral detergent thinned with lukewarm water, then dry them up in the shade.
- It is recommended to clean the air filters every two weeks.

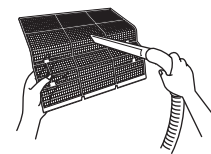

■ Air purifying filter with photocatalytic deodorizing function. (gray)

The Air purifying filter with photocatalytic deodorizing function can be renewed by washing it with water once every 6 months. We recommend replacing it once every 3 years.

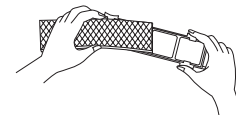

[Maintenance]

1. Remove dust with a vacuum cleaner and wash lightly with water.
2. If it is very dirty, soak it for 10 to 15 minutes in water mixed with a neutral cleaning agent.
3. Do not remove filter from frame when washing with water.
4. After washing, shake off remaining water and dry in the shade.
5. Since the material is made out of paper, do not wring out the filter when removing water from it.

[Replacement]

1. Remove the tabs on the filter frame and replace with a new filter.

- Dispose of the old filter as flammable waste.

Check

Check that the base, stand and other fittings of the outdoor unit are not decayed or corroded.
Check that nothing blocks the air inlets and the outlets of the indoor unit and the outdoor unit.
Check that the drain comes smoothly out of the drain hose during COOL or DRY operation. <ul style="list-style-type: none"> If no drain water is seen, water may be leaking from the indoor unit. Stop operation and consult the service shop if this is the case.

■ Before a long idle period

- Operate the “FAN only” for several hours on a fine day to dry out the inside.**
 - Press “MODE” button and select “FAN” operation.
 - Press “ON/OFF” button and start operation.
- After operation stops, turn off the breaker for the room air conditioner.**
- Clean the air filters and set them again.**
- Take out batteries from the remote controller.**
 - When a multi outdoor unit is connected, make sure the heating operation is not used at the other room before you use the fan operation. (page 22)

NOTE

- Operation with dirty filters:
 - (1) cannot deodorize the air. (2) cannot clean the air.
 - (3) results in poor heating or cooling. (4) may cause odour.
- To order air purifying filter with photocatalytic deodorizing function contact to the service shop there you bought the air conditioner.
- Dispose of old filters as burnable waste.

Item	Part No.
Air purifying filter with photocatalytic deodorizing function. (with frame) 1 set	KAF918A43
Air purifying filter with photocatalytic deodorizing function. (without frame) 1 set	KAF918A44

2.13 Troubleshooting

Trouble Shooting

These cases are not troubles.

The following cases are not air conditioner troubles but have some reasons. You may just continue using it.

Case	Explanation
Operation does not start soon. <ul style="list-style-type: none"> • When ON/OFF button was pressed soon after operation was stopped. • When the mode was reselected. 	<ul style="list-style-type: none"> • This is to protect the air conditioner. You should wait for about 3 minutes.
Hot air does not flow out soon after the start of heating operation.	<ul style="list-style-type: none"> • The air conditioner is warming up. You should wait for 1 to 4 minutes. (The system is designed to start discharging air only after it has reached a certain temperature.)
The heating operation stops suddenly and a flowing sound is heard.	<ul style="list-style-type: none"> • The system is taking away the frost on the outdoor unit. You should wait for about 3 to 8 minutes.
The outdoor unit emits water or steam.	<ul style="list-style-type: none"> ■ In HEAT mode <ul style="list-style-type: none"> • The frost on the outdoor unit melts into water or steam when the air conditioner is in defrost operation. ■ In COOL or DRY mode <ul style="list-style-type: none"> • Moisture in the air condenses into water on the cool surface of outdoor unit piping and drips.
Mists come out of the indoor unit.	<ul style="list-style-type: none"> ■ This happens when the air in the room is cooled into mist by the cold air flow during cooling operation.
The indoor unit gives out odour.	<ul style="list-style-type: none"> ■ This happens when smells of the room, furniture, or cigarettes are absorbed into the unit and discharged with the air flow. (If this happens, we recommend you to have the indoor unit washed by a technician. Consult the service shop where you bought the air conditioner.)
The outdoor fan rotates while the air conditioner is not in operation.	<ul style="list-style-type: none"> ■ After operation is stopped: <ul style="list-style-type: none"> • The outdoor fan continues rotating for another 60 seconds for system protection. ■ While the air conditioner is not in operation: <ul style="list-style-type: none"> • When the outdoor temperature is very high, the out door fan starts rotating for system protection.
The operation stopped suddenly. (OPERATION lamp is on)	<ul style="list-style-type: none"> ■ For system protection, the air conditioner may stop operating on a sudden large voltage fluctuation. It automatically resumes operation in about 3 minutes.

Check again.

Please check again before calling a repair person.

Case	Check
The air conditioner does not operate. (OPERATION lamp is off)	<ul style="list-style-type: none"> • Hasn't a breaker turned OFF or a fuse blown? • Isn't it a power failure? • Are batteries set in the remote control? • Is the timer setting correct?
Cooling (Heating) effect is poor.	<ul style="list-style-type: none"> • Are the air filters clean? • Is there anything to block the air inlet or the outlet of the indoor and the outdoor units? • Is the temperature setting appropriate? • Are the windows and doors closed? • Are the air flow rate and the air direction set appropriately? • Is the unit set to the INTELLIGENT EYE mode? (page 18.)
Operation stops suddenly. (OPERATION lamp flashes.)	<ul style="list-style-type: none"> • Are the air filters clean? • Is there anything to block the air inlet or the outlet of the indoor and the outdoor units? Clean the air filters or take all obstacles away and turn the breaker OFF. Then turn it ON again and try operating the air conditioner with the remote control. If the lamp still flashes, call the service shop where you bought the air conditioner. • Are operation modes all the same for indoor units connected to outdoor units in the multi system? If not, set all indoor units to the same operation mode and confirm that the lamps flash. Moreover, when the operation mode is in "AUTO", set all indoor unit operation modes to "COOL" or "HEAT" for a moment and check again that the lamps are normal. If the lamps stop flashing after the above steps, there is no malfunction. (page 22.)
An abnormal functioning happens during operation.	<ul style="list-style-type: none"> • The air conditioner may malfunction with lightning or radio waves. Turn the breaker OFF, turn it ON again and try operating the air conditioner with the remote control.

Call the service shop immediately.



WARNING

- When an abnormality (such as a burning smell) occurs, stop operation and turn the breaker OFF. Continued operation in an abnormal condition may result in troubles, electric shocks or fire. Consult the service shop where you bought the air conditioner.
- Do not attempt to repair or modify the air conditioner by yourself. Incorrect work may result in electric shocks or fire. Consult the service shop where you bought the air conditioner.

If one of the following symptoms takes place, call the service shop immediately.

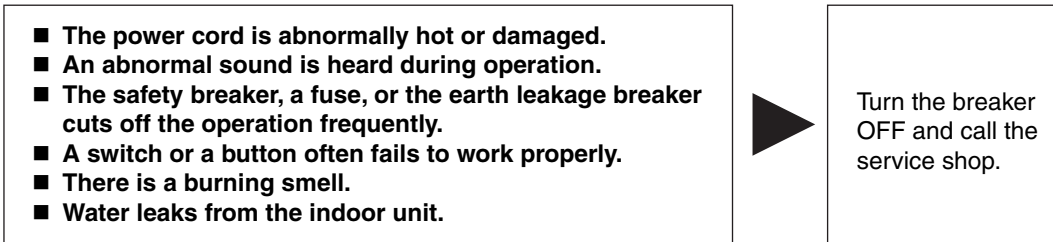

<ul style="list-style-type: none"> ■ After a power failure The air conditioner automatically resumes operation in about 3 minutes. You should just wait for a while. 	<ul style="list-style-type: none"> ■ Lightning If lightning may strike the neighbouring area, stop operation and turn the breaker OFF for system protection.
--	--

Disposal requirements

Dismantling of the unit, treatment of the refrigerant, oil and eventual other parts, should be done in accordance with the relevant local and national regulations.

We recommend periodical maintenance

In certain operating conditions, the inside of the air conditioner may get foul after several seasons of use, resulting in poor performance. It is recommended to have periodical maintenance by a specialist aside from regular cleaning by the user. For specialist maintenance, contact the service shop where you bought the air conditioner.

The maintenance cost must be born by the user.

Fault diagnosis

FAULT DIAGNOSIS BY REMOTE CONTROL

In the ARC433A series, the temperature display sections on the main unit indicate corresponding codes.

1. When the **TIMER CANCEL** button is held down for 5 seconds, a “ 00 ” indication flashes on the temperature display section.

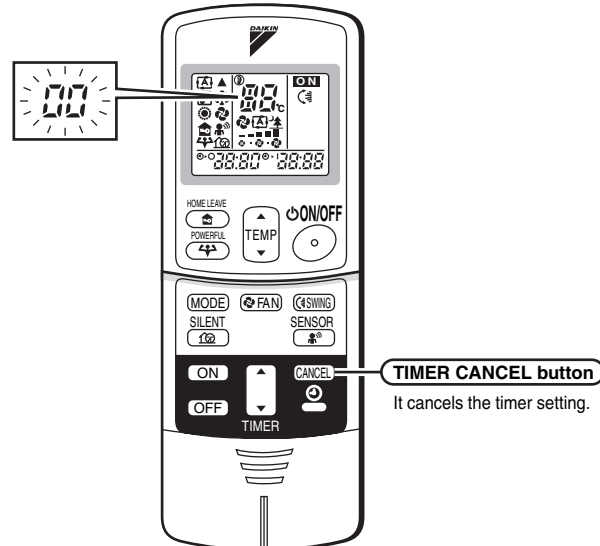

2. Press the **TIMER CANCEL** button repeatedly until a continuous beep is produced.

- The code indication changes as shown below, and notifies with a long beep.

	CODE	MEANING
SYSTEM	00	NORMAL
	U0	REFRIGERANT SHORTAGE
	U2	DROP VOLTAGE OR MAIN CIRCUIT OVERVOLTAGE
	U4	FAILURE OF TRANSMISSION (BETWEEN INDOOR UNIT AND OUTDOOR UNIT)
INDOOR UNIT	A1	INDOOR PCB DEFECTIVENESS
	A5	HIGH PRESSURE CONTROL OR FREEZE-UP PROTECTOR
	A6	FAN MOTOR FAULT
	C4	FAULTY HEAT EXCHANGER TEMPERATURE SENSOR
OUTDOOR UNIT	C9	FAULTY SUCTION AIR TEMPERATURE SENSOR
	EA	COOLING-HEATING SWITCHING ERROR
	E5	OL STARTED
	E6	FAULTY COMPRESSOR START UP
	E7	DC FAN MOTOR FAULT
	E8	OPERATION HALT DUE TO DETECTION OF INPUT OVER CURRENT
	F3	HIGH TEMPERATURE DISCHARGE PIPE CONTROL
	F6	HIGH PRESSURE CONTROL (IN COOLING)
	H6	OPERATION HALT DUE TO FAULTY POSITION DETECTION SENSOR
	H8	CT ABNORMALITY
	H9	FAULTY SUCTION AIR TEMPERATURE SENSOR
	J3	FAULTY DISCHARGE PIPE TEMPERATURE SENSOR
	J6	FAULTY HEAT EXCHANGER TEMPERATURE SENSOR
	L4	HIGH TEMPERATURE AT INVERTER CIRCUIT HEATSINK
L5	OUTPUT OVERCURRENT	
P4	FAULTY INVERTER CIRCUIT HEATSINK TEMPERATURE SENSOR	

NOTE

1. A short beep and two consecutive beeps indicate non-corresponding codes.
2. To cancel the code display, hold the **TIMER CANCEL** button down for 5 seconds. The code display also cancel itself if the button is not pressed for 1 minute.

LED ON OUTDOOR UNIT PCB 3MXS, 3MKS, 4MXS, 4MKS series

GREEN		RED				DIAGNOSIS
MICROCOMPUTER NORMAL		MALFUNCTION DETECTION				
LED-A	LED1	LED2	LED3	LED4		
⦿	●	●	●	●	NORMAL → CHECK INDOOR UNIT	
⦿	☀	●	☀	☀	HIGH PRESSURE PROTECTOR WORKED OR FREEZE-UP IN OPERATING UNIT OR STAND-BY UNIT	
⦿	☀	●	☀	●	OVERLOAD RELAY WORKED OR HIGH DISCHARGE PIPE TEMPERATURE	
⦿	●	☀	☀	●	FAULTY COMPRESSOR START	
⦿	●	☀	●	☀	INPUT OVERCURRENT	
⦿	☀	☀	●	●	THERMISTOR OR CT ABNORMALITY	
⦿	☀	☀	●	☀	HIGH TEMPERATURE SWITCHBOX	
⦿	●	●	●	☀	HIGH TEMPERATURE AT INVERTER CIRCUIT HEATSINK	
⦿	●	●	☀	●	OUTPUT OVERCURRENT	
⦿	●	●	☀	☀	REFRIGERANT SHORTAGE	
⦿	☀	●	●	☀	LOW VOLTAGE TO MAIN CIRCUIT OR MOMENTARY VOLTAGE LOSS	
⦿	☀	●	●	●	REVERSING SOLENOID VALVE SWITCHING FAILURE	
☀	–	–	–	–	FAN MOTOR FAULT	
●	–	–	–	–	[NOTE 1]	
●	–	–	–	–	POWER SUPPLY FAULT OR [NOTE 2]	

GREEN	NORMALLY FLASHING
RED	NORMALLY OFF
☀	ON
⦿	FLASHING
●	OFF
–	IRRELEVANT

LED ON OUTDOOR UNIT PCB 2MXS, 2MKS series

GREEN		DIAGNOSIS
MICROCOMPUTER NORMAL		
LED-A		
⦿	NORMAL → CHECK INDOOR UNIT	
☀	[NOTE 1]	
●	POWER SUPPLY FAULT OR [NOTE 2]	

GREEN	NORMALLY FLASHING
☀	ON
⦿	FLASHING
●	OFF

NOTES

1. Turn the power off and then on again. If the LED display recurs, the outdoor unit PCB is faulty.
2. Diagnosis marked
Do not apply to some cases. For details, refer to the service guide.

Part 6

Service Diagnosis

1. Caution for Diagnosis.....	96
2. Problem Symptoms and Measures	98
3. Service Check Function	99
4. Troubleshooting	102
4.1 Error Codes and Description	102
4.2 Indoor Unit PCB Abnormality	103
4.3 Freeze-up Protection Control or High Pressure Control.....	104
4.4 Fan Motor (AC Motor) or Related Abnormality	106
4.5 Thermistor or Related Abnormality (Indoor Unit).....	107
4.6 Anti-icing Function	108
4.7 OL Activation (Compressor Overload)	110
4.8 Compressor Lock	111
4.9 DC Fan Lock	112
4.10 Input Over Current Detection	113
4.11 Four Way Valve Abnormality	115
4.12 Discharge Pipe Temperature Control.....	117
4.13 High Pressure Control in Cooling	118
4.14 Position Sensor Abnormality	120
4.15 CT or Related Abnormality	121
4.16 Thermistor or Related Abnormality (Outdoor Unit)	123
4.17 Electrical Box Temperature Rise	125
4.18 Radiation Fin Temperature Rise	127
4.19 Output Over Current Detection.....	129
4.20 Insufficient Gas.....	131
4.21 Over-voltage Detection.....	133
4.22 Anti-icing Function in Other Rooms / Unspecified Voltage (between Indoor and Outdoor Units)	134
4.23 Outdoor Unit PCB Abnormality or Signal Transmission Circuit Abnormality	135
5. Check	136
5.1 How to Check	136

1. Caution for Diagnosis

The Operation lamp flashes when any of the following errors is detected.

1. When a protection device of the indoor or outdoor unit is activated or when the thermistor malfunctions, disabling equipment operation.
 2. When a signal transmission error occurs between the indoor and outdoor units.
- In either case, conduct the diagnostic procedure described in the following pages.

Location of Operation Lamp

In case of
 FTK(X)S 20/25/35 C Series
 ATK(X)S 20/25/35 C Series (grille type panel)
 ATK(X)S 20/25/35 D Series

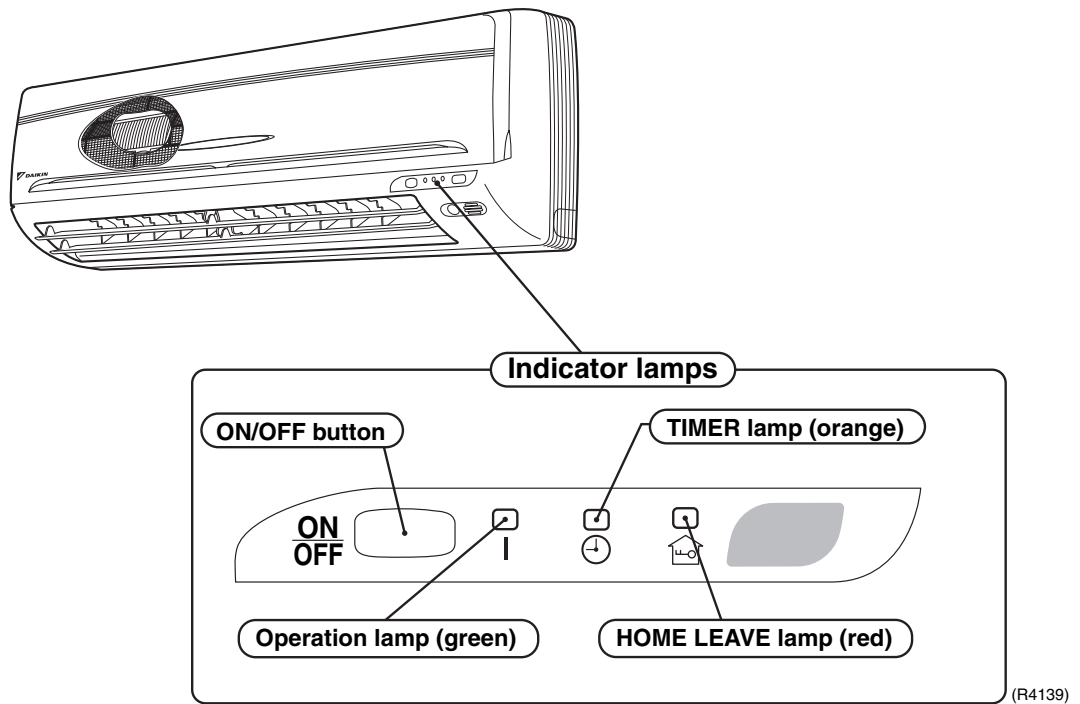

In case of
 FLK(X)S 25/35 B Series

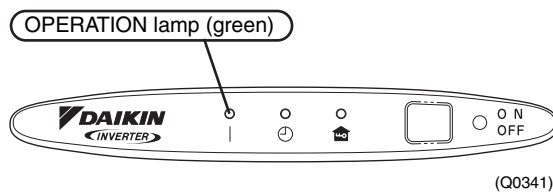

In case of
 CDK(X)S 25/35 C Series

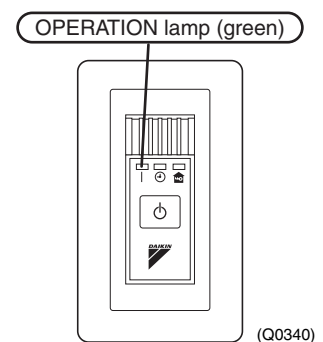

**Caution:**

Operation stops suddenly. (Operation lamp blinks.)

Cause of above trouble could be "Operation mode butting".

Check followings;

Are the operation modes all the same for indoor units connected to Multi system outdoor unit?
If not set all indoor units to the same operation mode and confirm that the operation lamp is not blinking.

Moreover, when the operation mode is in "Auto", set all indoor unit operation mode to "Cool" or "Heat" and check again if the operation lamp is normal.

If the lamp stops blinking after the above steps, there is no malfunction.

★Operation stops and operation lamp blinks only for indoor unit which the different operation mode is set later. (The first set operation mode has priority.)

Troubleshooting with the LED Indication

Outdoor Unit

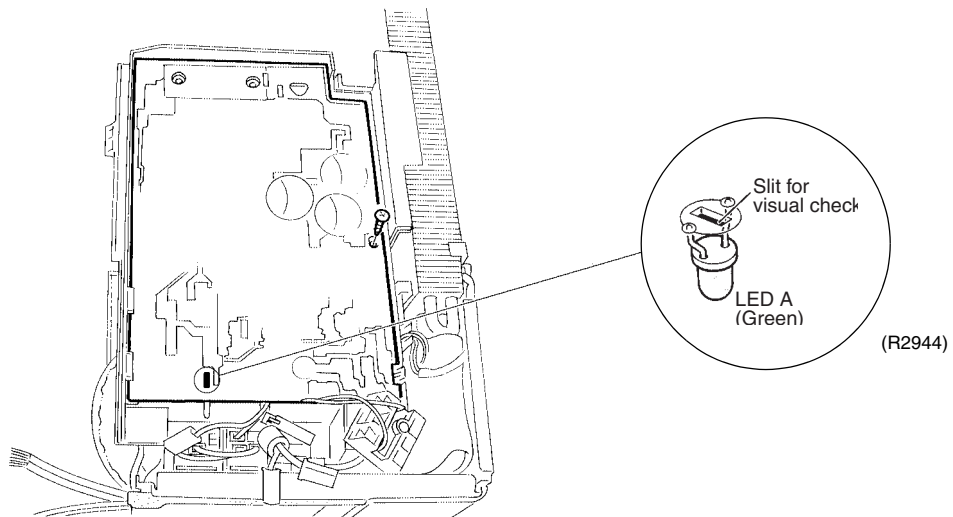

There is a green LED on the PCB. The flashing green LED indicates normal equipment condition. (Troubleshooting with the green LED)

The LED A of the outdoor unit indicate microcomputer operation condition.

Even after the error is cancelled and the equipment operates in normal condition, the LED indication remains.

2. Problem Symptoms and Measures

Symptom	Check Item	Details of Measure	Reference Page
None of the Units Operates.	Check the power supply.	Check to make sure that the rated voltage is supplied.	—
	Check the type of the indoor units.	Check to make sure that the indoor unit type is compatible with the outdoor unit.	—
	Check the outdoor air temperature.	Heating operation cannot be used when the outdoor air temperature is 21°C or higher (only for heat pump model), and cooling operation cannot be used when the outdoor air temperature is below 10°C.	—
	Diagnosis with remote controller indication	—	102
	Check the remote controller addresses.	Check to make sure that address settings for the remote controller and indoor unit are correct.	—
Operation Sometimes Stops.	Check the power supply.	A power failure of 2 to 10 cycles can stop air conditioner operation. (Operation lamp OFF)	—
	Check the outdoor air temperature.	Heating operation cannot be used when the outdoor air temperature is 21°C or higher (only for heat pump model), and cooling operation cannot be used when the outdoor air temperature is below 10°C.	—
	Diagnosis with remote controller indication	—	102
Equipment operates but does not cool, or does not heat (only for heat pump model).	Check for wiring and piping errors in the indoor and outdoor units connection wires and pipes.	Conduct the wiring/piping error check described on the product diagnosis nameplate.	—
	Check for thermistor detection errors.	Check to make sure that the main unit's thermistor has not dismantled from the pipe holder.	—
	Check for faulty operation of the electronic expansion valve.	Set the units to cooling operation, and compare the temperatures of the liquid side connection pipes of the connection section among rooms to check the opening and closing operation of the electronic expansion valves of the individual units.	—
	Diagnosis with remote controller indication	—	102
	Diagnosis by service port pressure and operating current	Check for insufficient gas.	131
Large Operating Noise and Vibrations	Check the output voltage of the power transistor.	—	142
	Check the power transistor.	—	—
	Check the installation condition.	Check to make sure that the required spaces for installation (specified in the Technical Guide, etc.) are provided.	—

3. Service Check Function

In the ARC433A series, the temperature display sections on the main unit indicate corresponding codes.

Check Method 1

1. When the timer cancel button is held down for 5 seconds, a "00" indication flashes on the temperature display section.

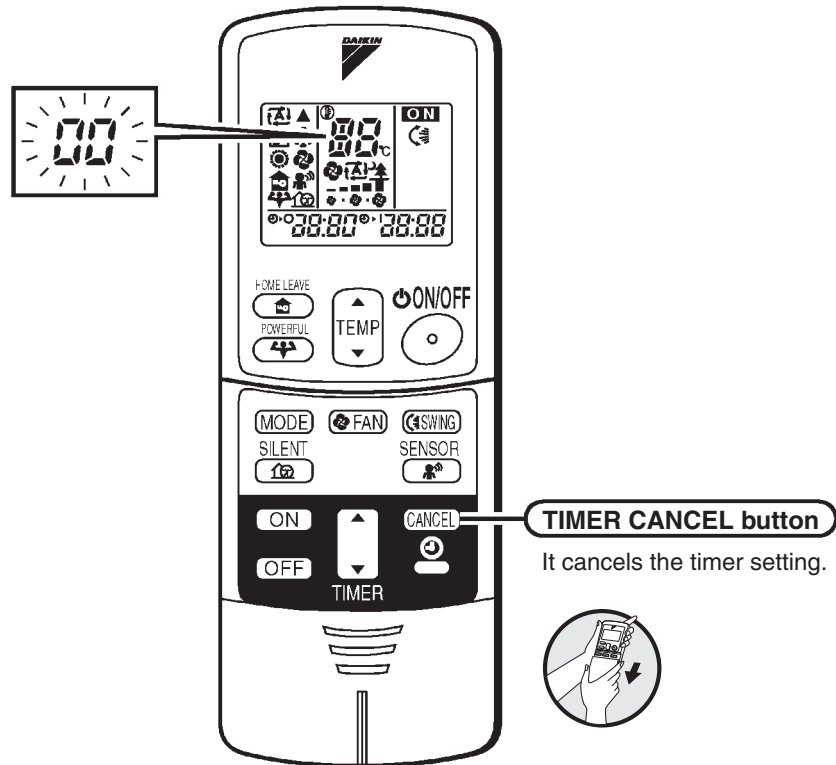

TIMER CANCEL button

It cancels the timer setting.

< ARC433A1, A2 >

(R3038)

2. Press the timer cancel button repeatedly until a continuous beep is produced.
 - The code indication changes in the sequence shown below, and notifies with a long beep.

No.	Code	No.	Code	No.	Code
1	00	12	C7	23	H0
2	U4	13	H8	24	E1
3	F3	14	J3	25	P4
4	E6	15	R3	26	L3
5	L5	16	R1	27	L4
6	R6	17	C4	28	H6
7	E5	18	C5	29	H7
8	F6	19	H9	30	U2
9	C9	20	J6	31	UH
10	U0	21	UR	32	ER
11	E7	22	R5	33	RH



Note:

1. A short beep and two consecutive beeps indicate non-corresponding codes.
2. To cancel the code display, hold the timer cancel button down for 5 seconds. The code display also cancels itself if the button is not pressed for 1 minute.

Check Method 2

1. Enter the diagnosis mode.
Press the 3 buttons (TEMP▲,TEMP▼, MODE) simultaneously.

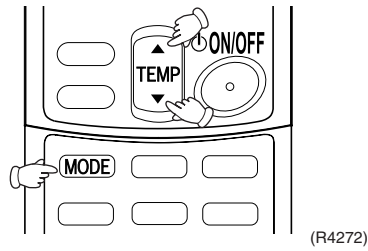

- The digit of the number of tens blinks.
- ★Try again from the start when the digit does not blink.

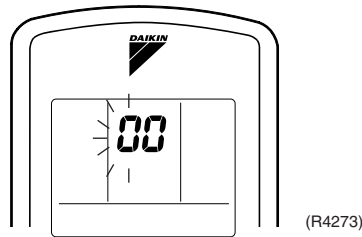

2. Press the TEMP button.
Press TEMP▲ or TEMP▼ and change the digit until you hear the sound of “beep” or “pi pi”.

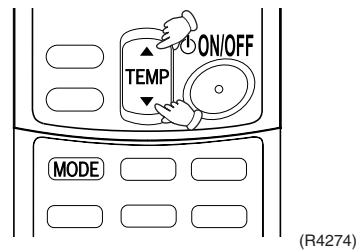

3. Diagnose by the sound.
 - ★“ pi ” : The number of tens does not accord with the error code.
 - ★“ pi pi ” : The number of tens accords with the error code.
 - ★“ beep ” : The both numbers of tens and units accord with the error code. (→See 7.)
4. Enter the diagnosis mode again.
Press the MODE button.

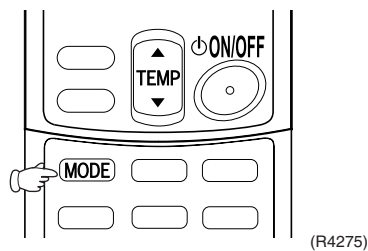

- The digit of the number of units blinks.

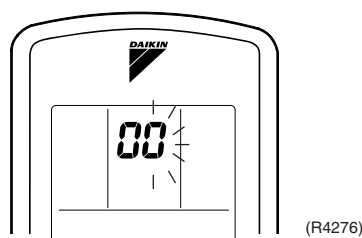

5. Press the TEMP button.
Press TEMP▲ or TEMP▼ and change the digit until you hear the sound of “beep”.

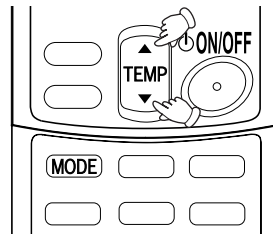

(R4277)

6. Diagnose by the sound.
- ★“ pi ” : The both numbers of tens and units do not accord with the error code.
 - ★“ pi pi ” : The number of tens accords with the error code.
 - ★“ beep ” : The both numbers of tens and units accord with the error code.
7. Determine the error code.
The digits indicated when you hear the “beep” sound are error code.
(Error codes and description → Refer to page 102.)
8. Exit from the diagnosis mode.
Press the MODE button.

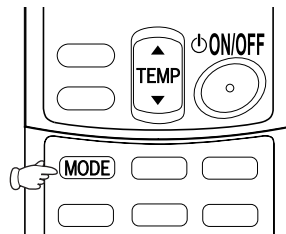

(R4278)

4. Troubleshooting

4.1 Error Codes and Description

	Code Indication	Description	Reference Page
System	<i>00</i>	Normal	—
	<i>U0</i> ★	Insufficient gas	131
	<i>U2</i>	Over-voltage detection	133
	<i>U4</i>	Outdoor unit PCB abnormality or signal transmission circuit abnormality	135
	<i>UR</i>	Unspecified voltage (between indoor and outdoor units)	134
	<i>UH</i>	Anti-icing function in other rooms	134
Indoor Unit	<i>R1</i>	Indoor unit PCB abnormality	103
	<i>R5</i>	Freeze-up protection control or high pressure control	104
	<i>R6</i>	Fan motor or related abnormality	106
	<i>C4</i>	Heat exchanger temperature thermistor abnormality	107
	<i>C9</i>	Room temperature thermistor abnormality	107
Outdoor Unit	<i>R5</i>	Anti-icing function	108
	<i>E5</i> ★	OL activation (compressor overload)	110
	<i>E6</i> ★	Compressor lock	111
	<i>E7</i>	DC fan lock	112
	<i>E8</i>	Input over current detection	113
	<i>ER</i>	Four way valve abnormality	115
	<i>F3</i>	Discharge pipe temperature control	117
	<i>F6</i>	High pressure control in cooling	118
	<i>H6</i>	Position sensor abnormality	120
	<i>H8</i>	CT or related abnormality	121
	<i>H9</i>	Outdoor air thermistor or related abnormality	123
	<i>J3</i>	Discharge pipe temperature thermistor or related abnormality	123
	<i>J6</i>	Heat exchanger temperature thermistor or related abnormality	123
	<i>J8</i>	Liquid pipe temperature thermistor or related abnormality	123
	<i>J9</i>	Gas pipe temperature thermistor or related abnormality	123
	<i>L3</i>	Electrical box temperature rise	125
	<i>L4</i>	Radiation fin temperature rise	127
	<i>L5</i>	Output over current detection	129
	<i>P4</i>	Radiation fin thermistor or related abnormality	123

★: Displayed only when system-down occurs.

4.2 Indoor Unit PCB Abnormality

Remote
Controller
Display

A1

Method of
Malfunction
Detection

Evaluation of zero-cross detection of power supply by indoor unit.

Malfunction
Decision
Conditions

When there is no zero-cross detection in approximately 10 continuous seconds.

Supposed
Causes

- Faulty indoor unit PCB
- Faulty connector connection

Troubleshooting



Caution

Be sure to turn off power switch before connect or disconnect connector, or parts damage may be occurred.

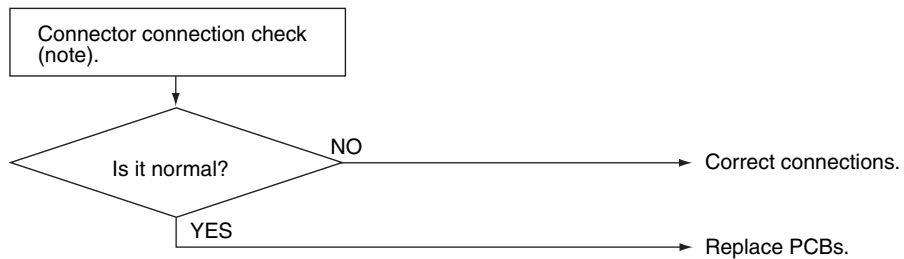

Note: Connector Nos. vary depending on models.

(R1400)

Model Type	Connector No.
Wall Mounted Type	Terminal strip~Control PCB
Duct Connected Type	Terminal strip~Control PCB
Floor / Ceiling Suspended Dual Type	S37

4.3 Freeze-up Protection Control or High Pressure Control

Remote
Controller
Display

RS

**Method of
Malfunction
Detection**

- High pressure control (heat pump model only)
During heating operations, the temperature detected by the indoor heat exchanger thermistor is used for the high pressure control (stop, outdoor fan stop, etc.)
- The freeze-up protection control (operation halt) is activated during cooling operation according to the temperature detected by the indoor unit heat exchanger thermistor.

**Malfunction
Decision
Conditions**

- High pressure control
During heating operations, the temperature detected by the indoor heat exchanger thermistor is above 65°C
- Freeze-up protection

When the indoor unit heat exchanger temperature is below 0°C during cooling operation.

**Supposed
Causes**

- Operation halt due to clogged air filter of the indoor unit.
- Operation halt due to dust accumulation on the indoor unit heat exchanger.
- Operation halt due to short-circuit.
- Detection error due to faulty indoor unit heat exchanger thermistor.
- Detection error due to faulty indoor unit PCB.

Troubleshooting



Check No.6
Refer to P.138

**Caution**

Be sure to turn off power switch before connect or disconnect connector, or parts damage may be occurred.

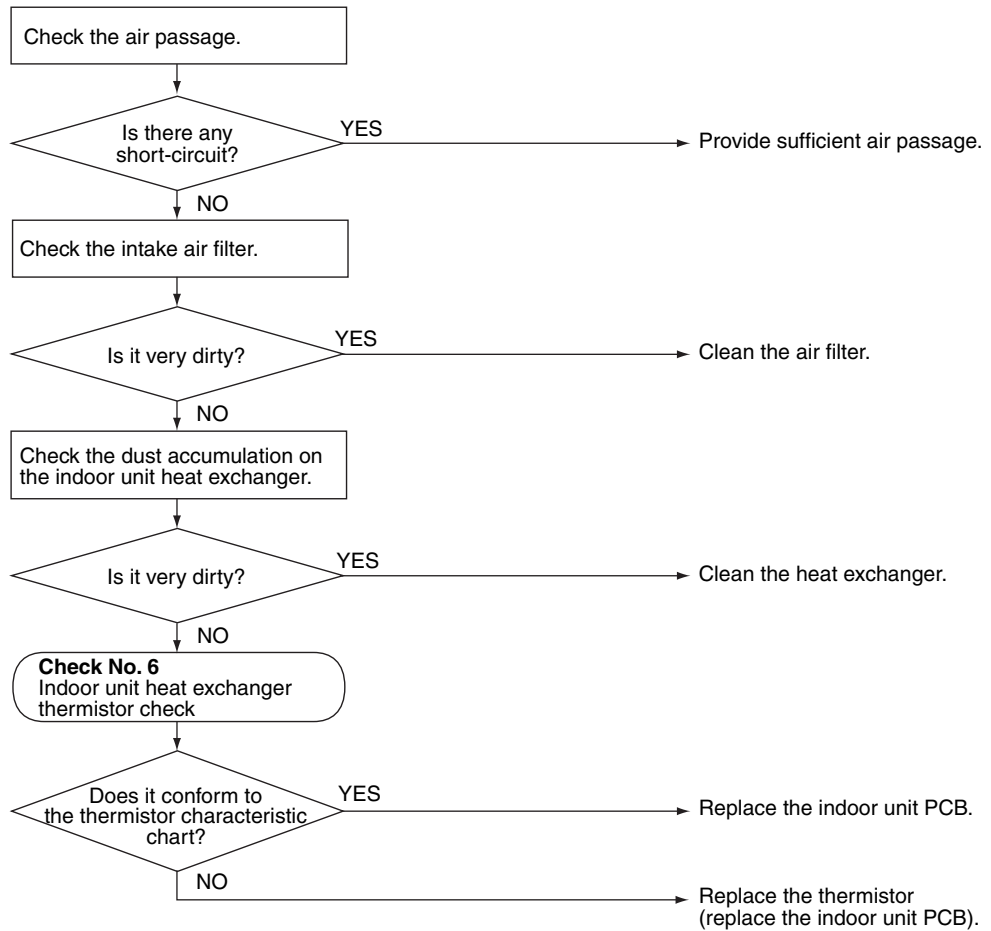

(R1401)

4.4 Fan Motor (AC Motor) or Related Abnormality

Remote
Controller
Display

AB

Method of
Malfunction
Detection

The rotation speed detected by the Hall IC during fan motor operation is used to determine abnormal fan motor operation.

Malfunction
Decision
Conditions

When the detected rotation speed is less than 50% of the HH tap under maximum fan motor rotation demand.

Supposed
Causes

- Operation halt due to short circuit inside the fan motor winding.
- Operation halt due to breaking of wire inside the fan motor.
- Operation halt due to breaking of the fan motor lead wires.
- Operation halt due to faulty capacitor of the fan motor.
- Detection error due to faulty indoor unit PCB.

Troubleshooting



Check No.16
Refer to P.143



Caution Be sure to turn off power switch before connect or disconnect connector, or parts damage may be occurred.

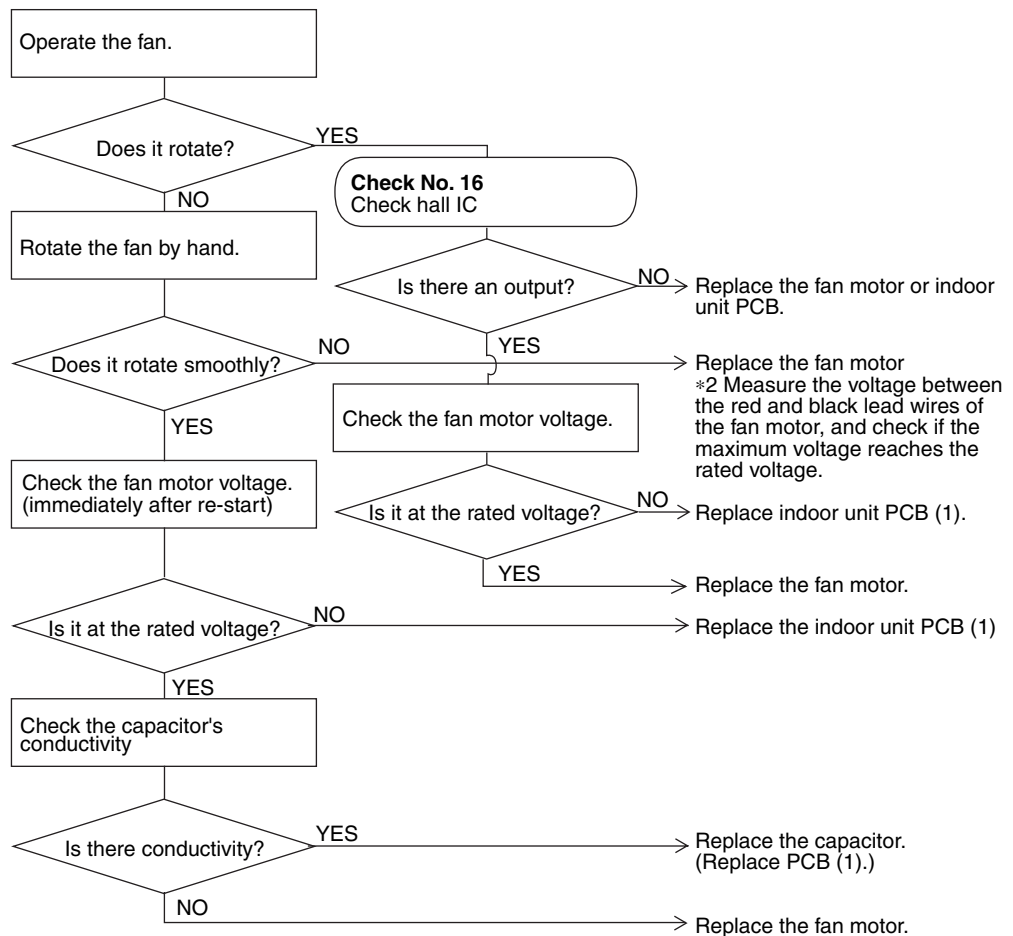

(R1946)

4.5 Thermistor or Related Abnormality (Indoor Unit)

Remote
Controller
Display

Ⓒ4, Ⓒ9

Method of
Malfunction
Detection

The temperatures detected by the thermistors are used to determine thermistor errors.

Malfunction
Decision
Conditions

When the thermistor input is more than 4.96 V or less than 0.04 V during compressor operation*.

* (reference)

When above about 212°C (less than 120 ohms) or below about -50°C (more than 1,860 kohms).



Note: The values vary slightly in some models.

Supposed
Causes

- Faulty connector connection
- Faulty thermistor
- Faulty PCB

Troubleshooting



Check No.6
Refer to P.138



Caution

Be sure to turn off power switch before connect or disconnect connector, or parts damage may be occurred.

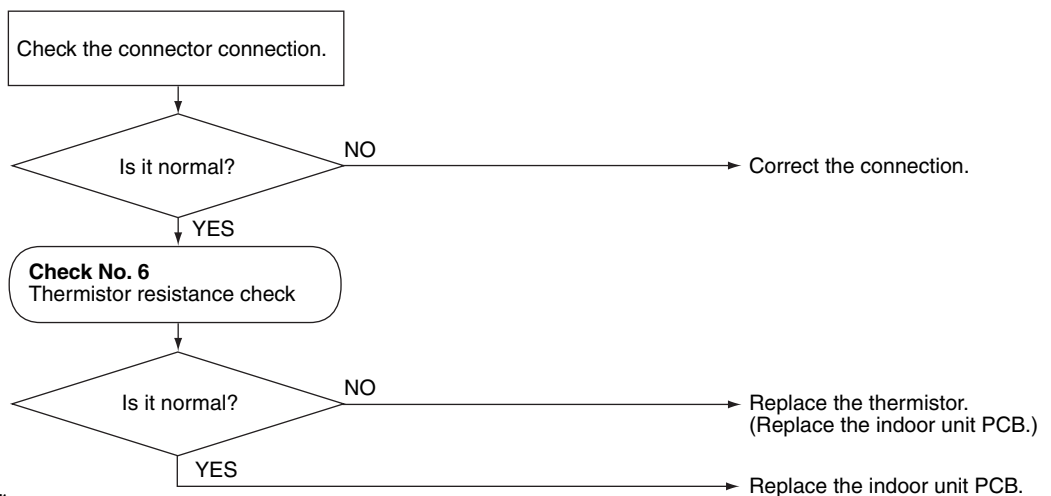

Ⓒ4

Ⓒ9 : Room temperature thermistor

(R1403)

4.6 Anti-icing Function

**Remote
Controller
Display**

RS

**Method of
Malfunction
Detection**

Indoor unit icing, during cooling operation, is detected by checking the temperatures sensed by the indoor unit heat exchanger temperature thermistor and room temperature thermistor that are located in a shut-down room.

At another room (the indoor unit is normal), "UH" is displayed on the remote controller.

**Malfunction
Decision
Conditions**

In the cooling mode, the following conditions (A) and (B) are kept together for 5 minutes.

(A) Indoor unit heat exchanger temperature $\leq -1^{\circ}\text{C}$

(B) Indoor unit heat exchanger temperature \leq Room temperature -10°C

- If the indoor unit anti-icing function is activated four times continuity, the system will be shut down.

(The 4-time counter will reset itself if any of the following errors does not occur during the compressor running time (total time): OL, radiation fin temperature rise, insufficient gas, and compressor lock.)

<Total 60 minutes>

**Supposed
Causes**

- Wrong wiring or piping
- Ev malfunctioning in each room
- Short-circuit
- Indoor unit heat exchanger temperature thermistor abnormality
- Room temperature thermistor abnormality

Troubleshooting



Check No.4
Refer to P.136



Check No.6
Refer to P.138



Caution Be sure to turn off power switch before connect or disconnect connector, or parts damage may be occurred.

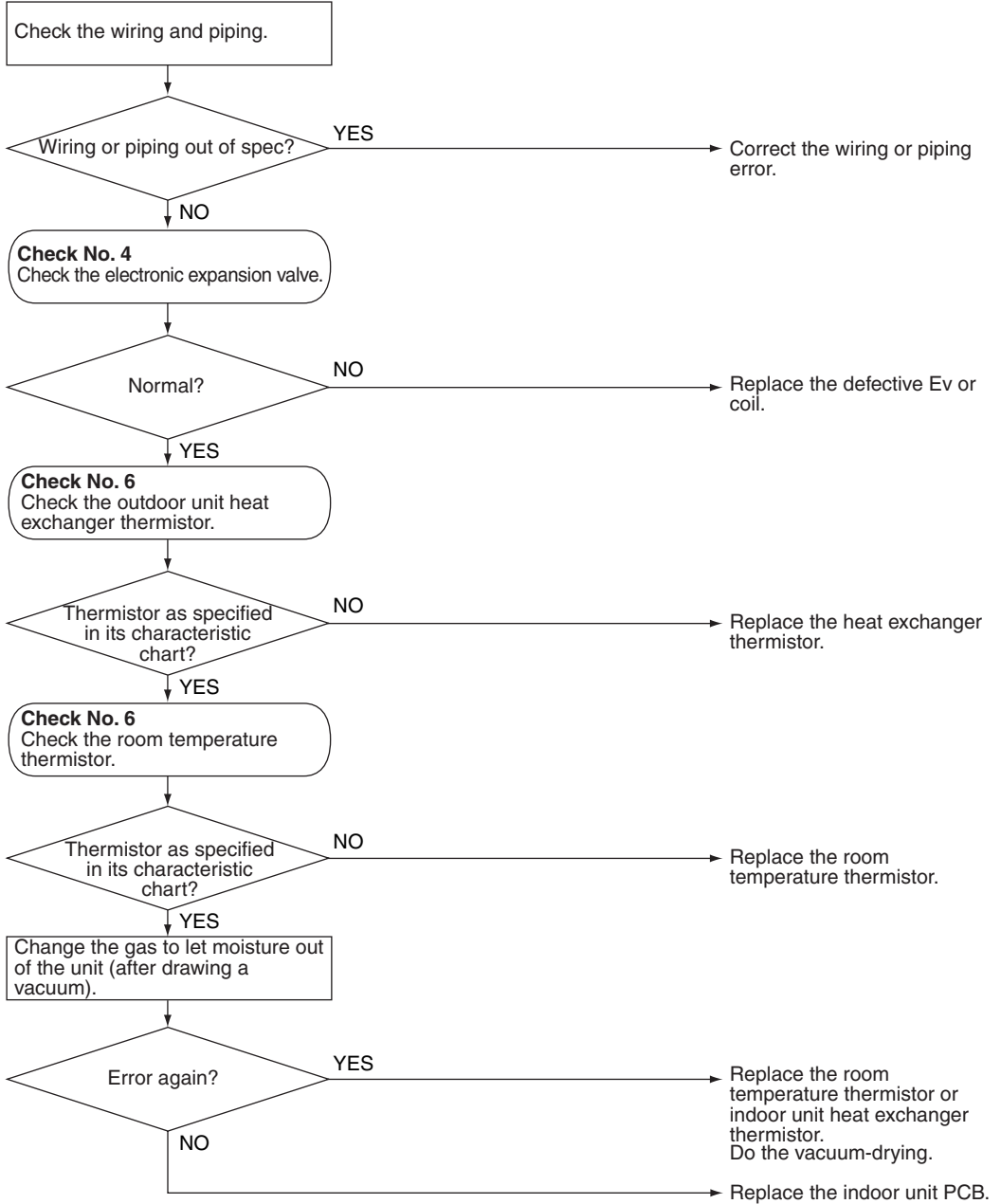

(R3039)

4.7 OL Activation (Compressor Overload)

Remote
Controller
Display

E5

Method of
Malfunction
Detection

A compressor overload is detected through compressor OL.

Malfunction
Decision
Conditions

- If the compressor OL is activated twice, the system will be shut down.
- The error counter will reset itself if this or any other error does not occur during the following 60-minute compressor running time (total time).
- * The operating temperature condition is not specified.

Supposed
Causes

- Refrigerant shortage
- Four way valve malfunctioning
- Outdoor unit PCB defective
- Water mixed in the local piping
- Electronic expansion valve defective
- Stop valve defective

Troubleshooting

Check No.4
Refer to P.136

Check No.5
Refer to P.137

Check No.6
Refer to P.138

Check No.11
Refer to P.141

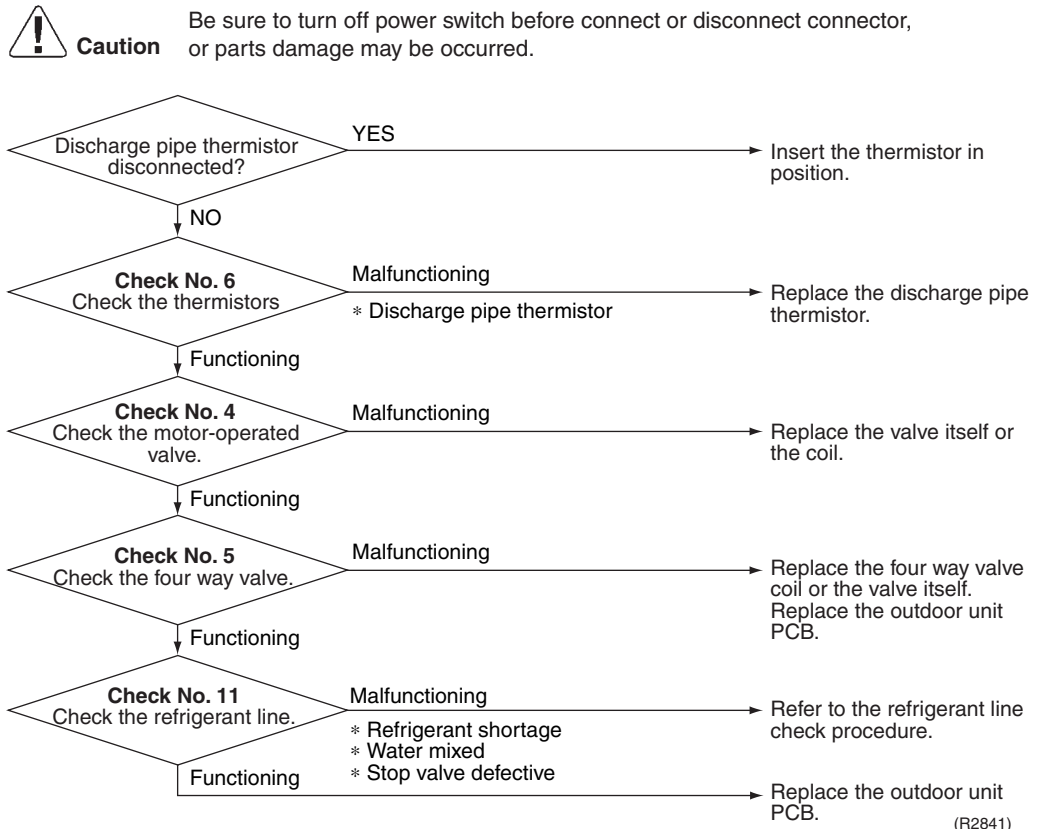

4.8 Compressor Lock

Remote
Controller
Display

EE

Method of
Malfunction
Detection

A compressor lock is detected by checking the compressor running condition through the position detection circuit.

Malfunction
Decision
Conditions

- The position detection circuit detects a compressor frequency of below 5 Hz for several tens of seconds.
- The system will be shut down if the error occurs 16 times.
- Clearing condition: Continuous run for about 5 minutes (normal)

Supposed
Causes

- Compressor locked

Troubleshooting

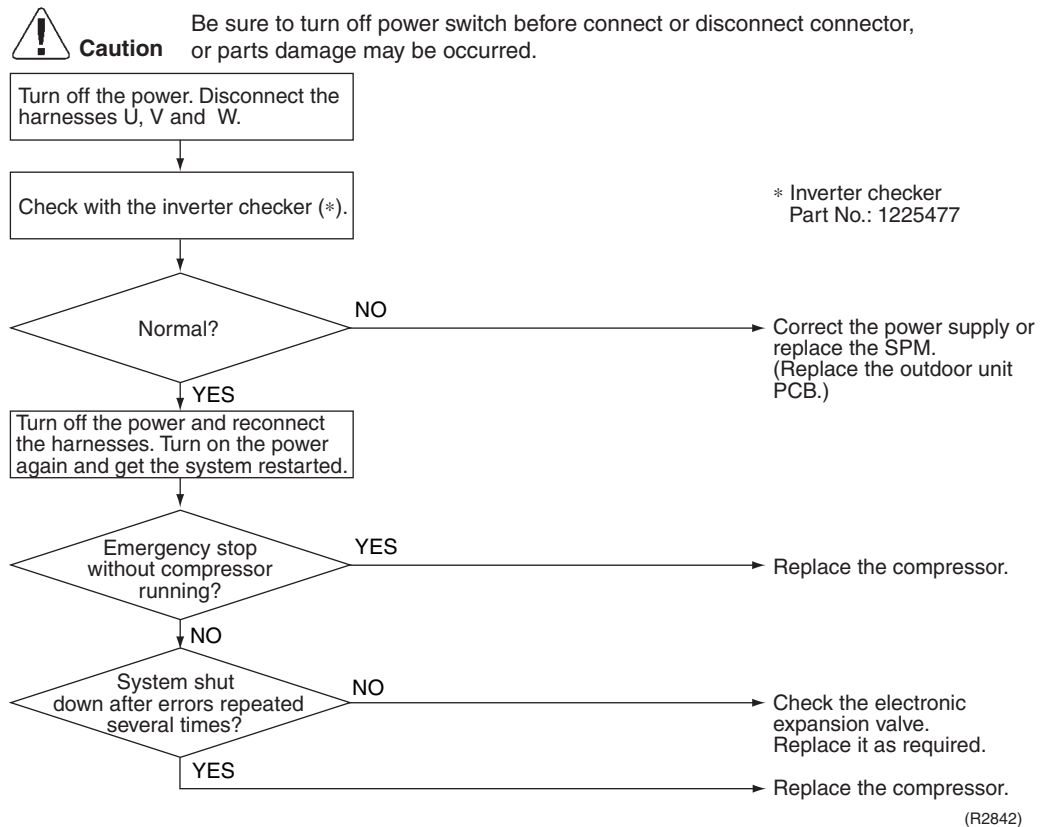

Note: If the model doesn't have SPM, replace the outdoor unit PCB.

4.9 DC Fan Lock

Remote
Controller
Display

E7

Method of
Malfunction
Detection

A fan motor or related error is detected by checking the high-voltage fan motor rpm being detected by the Hall IC.

Malfunction
Decision
Conditions

- The fan does not start in 30 seconds even when the fan motor is running.
- The system will be shut down if the error occurs 16 times.
- Clearing condition: Continuous run for about 5 minutes (normal)

Supposed
Causes

- Fan motor breakdown
- Harness or connector disconnected between fan motor and PCB or in poor contact
- Foreign matters stuck in the fan

Troubleshooting

Check No.15
Refer to P.143

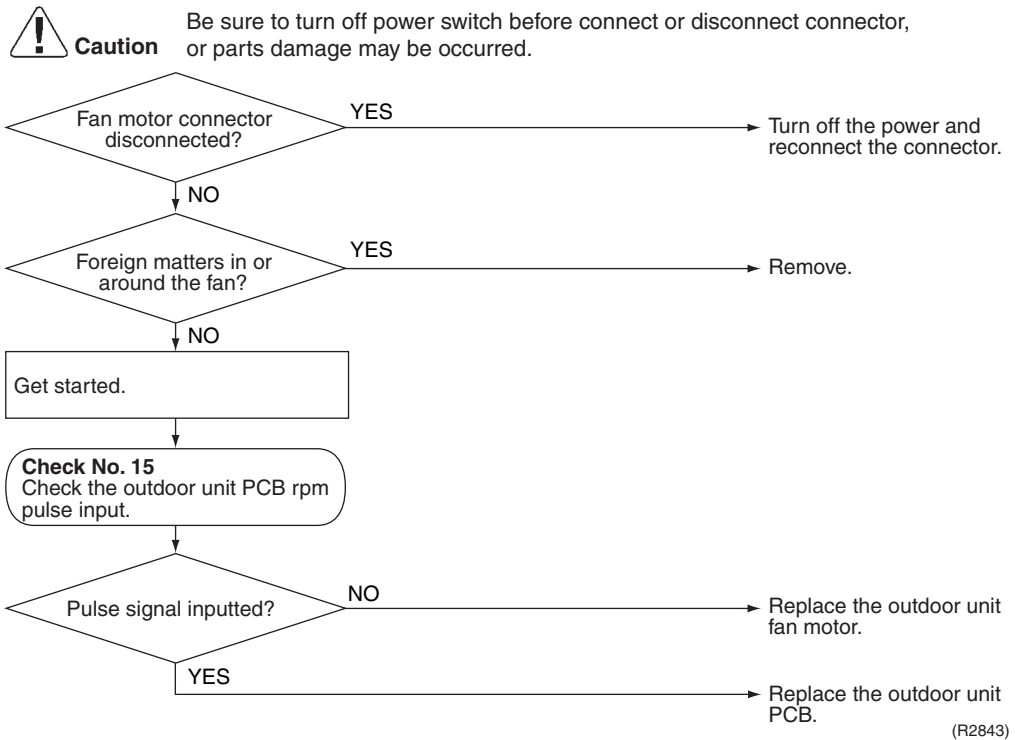

(R2843)

4.10 Input Over Current Detection

Remote
Controller
Display

EE

Method of
Malfunction
Detection

An input over-current is detected by checking the input current value being detected by CT with the compressor running.

Malfunction
Decision
Conditions

- The following CT input with the compressor running continues for 2.5 seconds.
CT input: Above 11 A
 - The system will be shut down if the error occurs 16 times.
 - Clearing condition : Continuous run for about 5 minutes (normal)
-

Supposed
Causes

- Over-current due to compressor failure
- Over-current due to defective power transistor
- Over-current due to defective inverter main circuit electrolytic capacitor
- Over-current due to defective outdoor unit PCB
- Error detection due to outdoor unit PCB
- Over-current due to short-circuit

Troubleshooting



Check No.7
Refer to P.139



Check No.8
Refer to P.140



Check No.14
Refer to P.142



Caution

Be sure to turn off power switch before connect or disconnect connector, or parts damage may be occurred.

* An input over-current may result from wrong internal wiring. If the wires have been disconnected and reconnected for part replacement, for example, and the system is interrupted by an input over-current, take the following procedure.

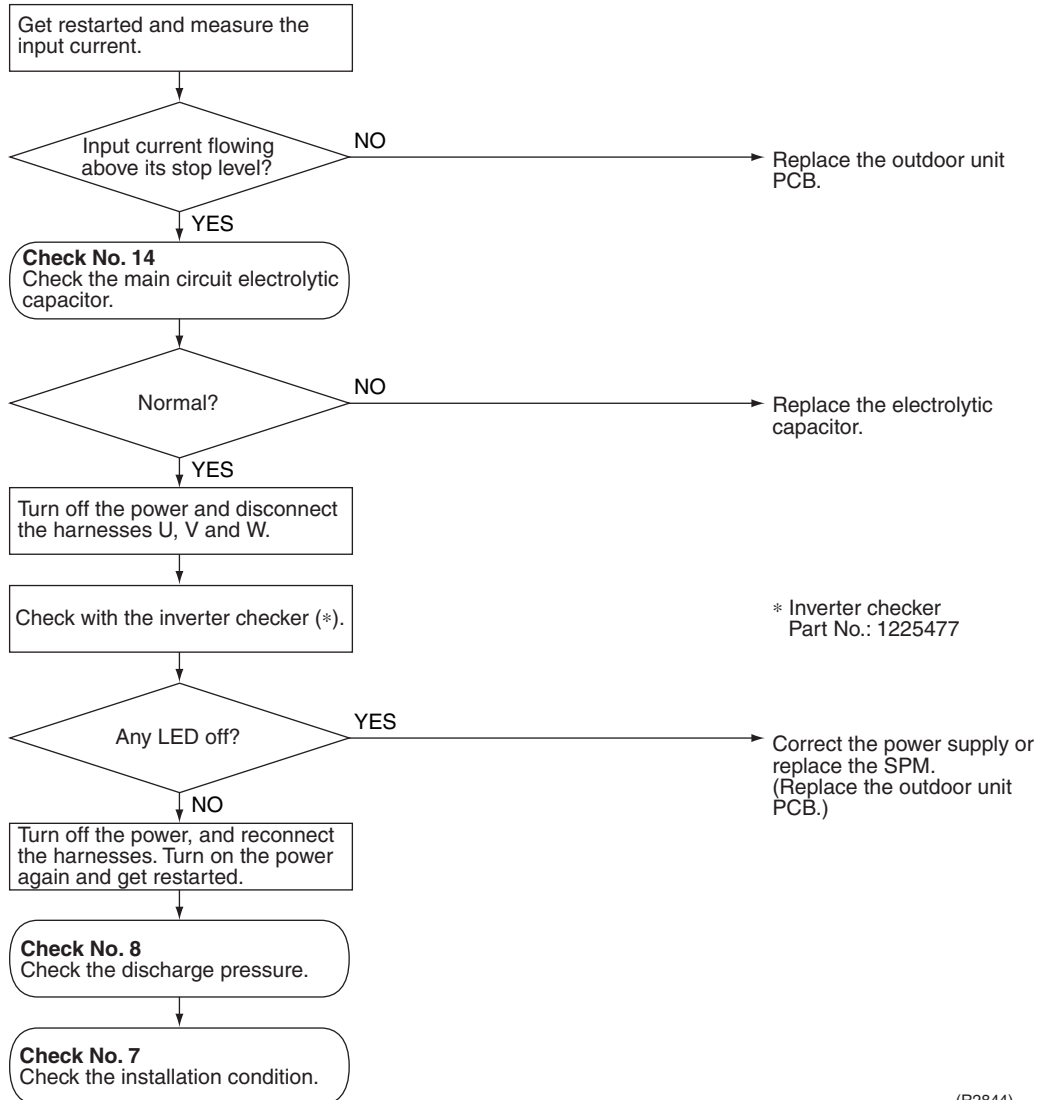

* Inverter checker
Part No.: 1225477

(R2844)



Note: If the model doesn't have SPM, replace the outdoor unit PCB.

4.11 Four Way Valve Abnormality

Remote
Controller
Display

EA

**Method of
Malfunction
Detection**

The liquid pipe temperature thermistor, the outdoor air temperature thermistor and the outdoor unit heat exchanger thermistor are checked to see if they function within their normal ranges in the operating mode.

**Malfunction
Decision
Conditions**

A following condition occurs after 3 minutes of the compressor start.

- Cooling / dry operation
(outdoor unit heat exchanger temp. – liquid pipe temp.) < -5°C
- Heating
(liquid pipe temp. – outdoor unit heat exchanger temp.) < 0°C

**Supposed
Causes**

- Connector in poor contact
- Thermistor defective
- Outdoor unit PCB defective
- Four way valve coil or harness defective
- Four way valve defective
- Foreign substance mixed in refrigerant
- Insufficient gas

Troubleshooting



Check No.5
Refer to P.137



Check No.6
Refer to P.138



Check No.11
Refer to P.141

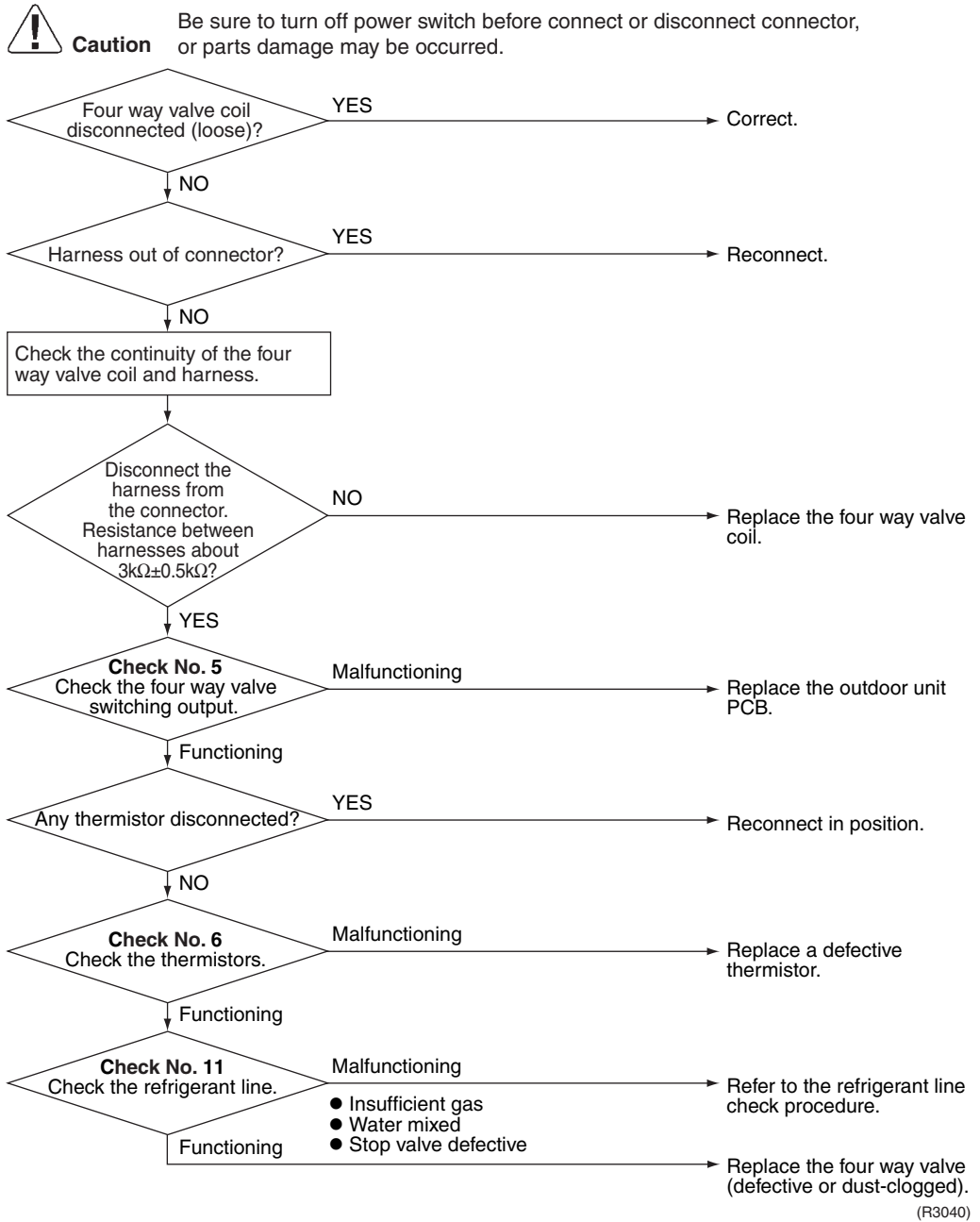

(R3040)

4.12 Discharge Pipe Temperature Control

Remote
Controller
Display

F3

Method of
Malfunction
Detection

The discharge pipe temperature control (stop, frequency drooping, etc.) is checked with the temperature being detected by the discharge pipe thermistor.



Malfunction
Decision
Conditions

- If a stop takes place 6 times successively due to abnormal discharge pipe temperature, the system will be shut down.
 - If the temperature being detected by the discharge pipe thermistor rises above 110°C, the compressor will stop. (The error is cleared when the temperature has dropped below 97°C.)
- Stop temperatures
- (1) 110°C : above 45Hz (rising), above 40Hz (dropping)
 - (2) 102°C : 30~45Hz (rising), 25~40Hz (dropping)
 - (3) 98°C : below 30Hz (rising), below 25Hz (dropping)
- The error counter will reset itself if this or any other error does not occur during the following 60-minute compressor running time (total time).

Supposed
Causes

- Refrigerant shortage
- Four way valve malfunctioning
- Discharge pipe thermistor defective
(heat exchanger or outdoor air temperature thermistor defective)
- Outdoor unit PCB defective
- Water mixed in the local piping
- Electronic expansion valve defective
- Stop valve defective

Troubleshooting

-  **Check No.4**
Refer to P.136
-  **Check No.6**
Refer to P.138
-  **Check No.11**
Refer to P.141

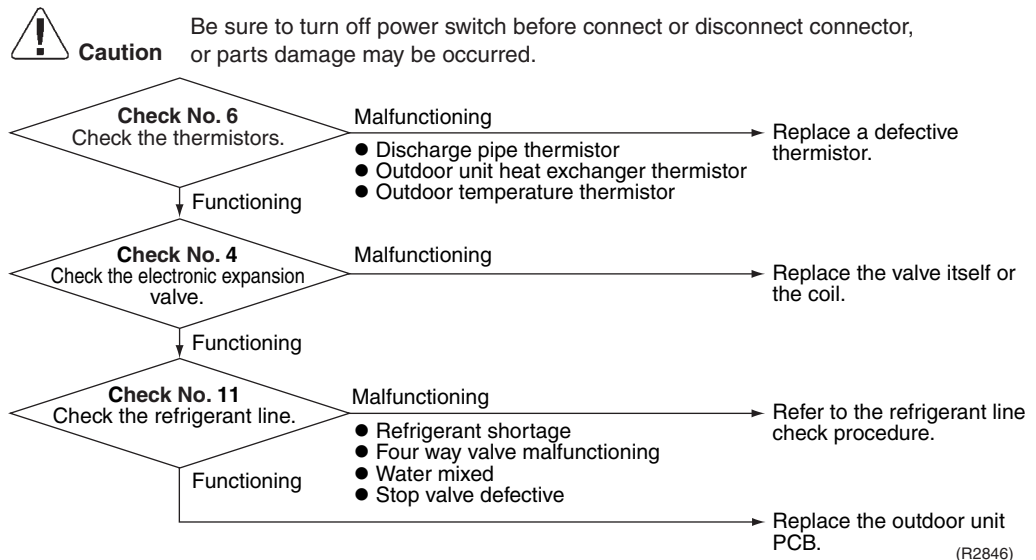

4.13 High Pressure Control in Cooling

**Remote
Controller
Display**

F6

**Method of
Malfunction
Detection**

High-pressure control (stop, frequency drop, etc.) is activated in the cooling mode if the temperature being sensed by the heat exchanger thermistor exceeds the limit.

**Malfunction
Decision
Conditions**

Activated when the temperature being sensed by the heat exchanger thermistor rises above 54°C. (Deactivated when the said temperature drops below 52°C.)

**Supposed
Causes**

- The installation space is not large enough.
- Faulty outdoor unit fan
- Faulty electronic expansion valve
- Faulty outdoor unit heat exchanger thermistor
- Faulty outdoor unit PCB
- Faulty stop valve
- Dirty heat exchanger

Troubleshooting



Check No.4
Refer to P.136



Check No.6
Refer to P.138



Check No.7
Refer to P.139



Check No.9
Refer to P.140



Caution

Be sure to turn off power switch before connect or disconnect connector, or parts damage may be occurred.

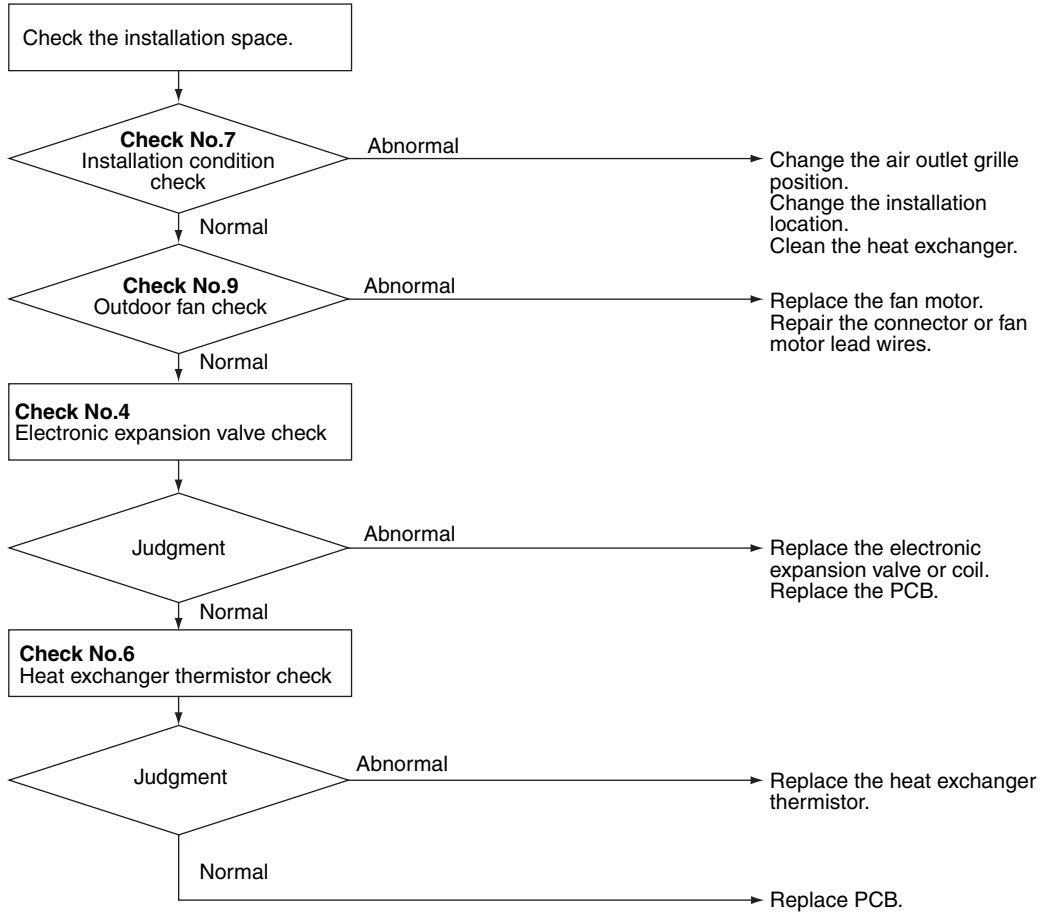

(R2855)

4.14 Position Sensor Abnormality

Remote
Controller
Display

HE

Method of
Malfunction
Detection

A compressor startup failure is detected by checking the compressor running condition through the position detection circuit.

Malfunction
Decision
Conditions

- The compressor is not running in about 15 seconds after the compressor run command signal is sent.
- Clearing condition: Continuous run for about 5 minutes (normal)
- The system will be shut down if the error occurs 8 times.

Supposed
Causes

- Compressor relay cable disconnected
- Compressor itself defective
- Outdoor unit PCB defective
- Stop valve closed
- Input voltage out of specification

Troubleshooting



Check No.13
Refer to P.142



Caution

Be sure to turn off power switch before connect or disconnect connector, or parts damage may be occurred.

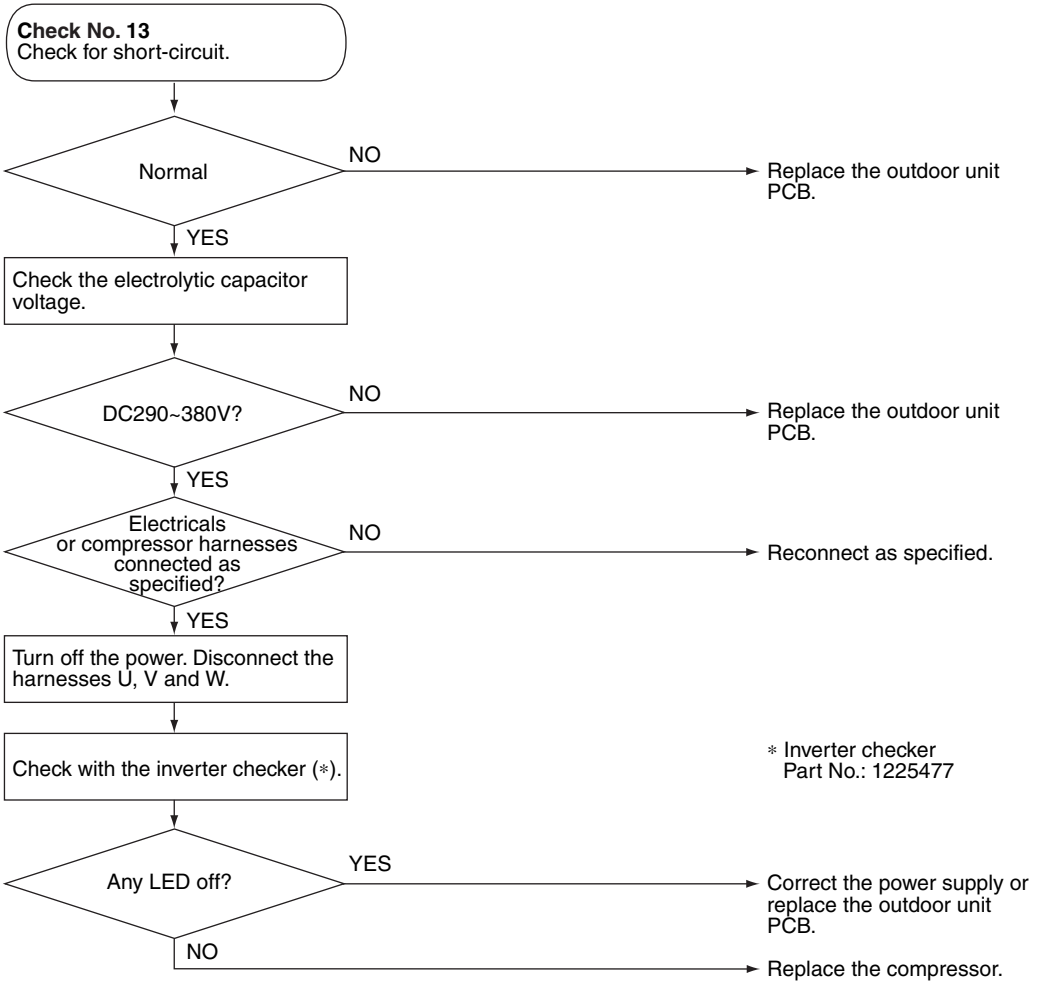

* Inverter checker
Part No.: 1225477

(R3041)

4.15 CT or Related Abnormality

Remote
Controller
Display

H8

Method of
Malfunction
Detection

A CT or related error is detected by checking the compressor running frequency and CT-detected input current.

Malfunction
Decision
Conditions

The compressor running frequency is above 68 Hz and the CT input is below 0.1 V.
(The input current is also below 1.25 A.)

- If this error repeats 4 times, the system will be shut down.
 - The error counter will reset itself if this or any other error does not occur during the following 60-minute compressor running time (total time).
-

Supposed
Causes

- Power transistor defective
- Internal wiring broken or in poor contact
- Reactor defective
- Outdoor unit PCB defective

Troubleshooting



Check No.12
Refer to P.141



Caution

Be sure to turn off power switch before connect or disconnect connector, or parts damage may be occurred.

Turn off the power and turn it on again.

Get the system started.

* Running current as shown at right with relay cable 1 or 2?

YES

Replace the outdoor unit PCB.

Check No. 12
Check the capacitor voltage.

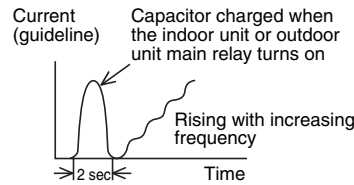

DC290~380V?

YES

Turn off the power. Disconnect the harnesses U, V and W.

* Inverter checker
Part No.: 1225477

Measure the rectifier input voltage.

Check with the inverter checker (*).

Any LED off?

YES

Correct the power supply or replace the SPM. (Replace the outdoor unit PCB.)

Turn off the power and reconnect the above harnesses. Then turn on the power again and get the system restarted.

Compressor running?

YES

Replace the outdoor unit PCB.

NO

Replace the compressor.

Voltage within the allowable range (Supply voltage $\pm 15\%$)?

YES

Replace the outdoor unit PCB.

NO

Check the supply voltage.

(R3042)



Note: If the model doesn't have SPM, replace the outdoor unit PCB.

4.16 Thermistor or Related Abnormality (Outdoor Unit)

Remote
Controller
Display

P4, J3, J6, J8, J9, H9

Method of
Malfunction
Detection

This type of error is detected by checking the thermistor input voltage to the microcomputer.
[A thermistor error is detected by checking the temperature.]

Malfunction
Decision
Conditions

The thermistor input is above 4.96 V or below 0.04 V with the power on.
Error *J3* is judged if the discharge pipe thermistor temperature is smaller than the condenser thermistor temperature.
In case of *J8* or *J9*, the system will be shut down when the error is detected at all of operating units.

Supposed
Causes

- Connector in poor contact
- Thermistor defective
- Outdoor unit PCB defective
- Indoor unit PCB defective
- Condenser thermistor defective in the case of *J3* error (outdoor unit heat exchanger thermistor in the cooling mode, or indoor unit heat exchanger thermistor in the heating mode)

Troubleshooting



Check No.6
Refer to P.138



Caution

Be sure to turn off power switch before connect or disconnect connector, or parts damage may be occurred.

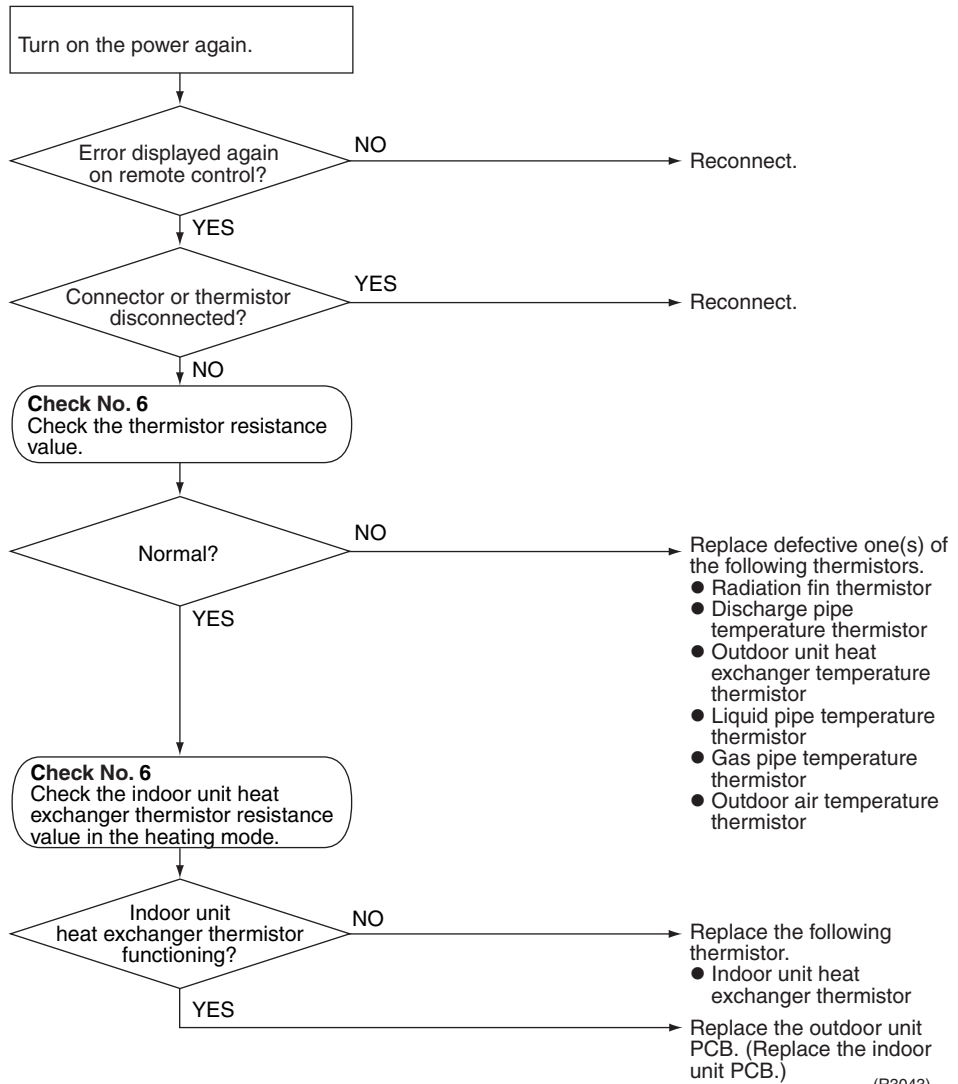

- P4 : Radiation fin thermistor
- J3 : Discharge pipe temperature thermistor
- J5 : Outdoor unit heat exchanger temperature thermistor
- J8 : Liquid pipe temperature thermistor
- J9 : Gas pipe temperature thermistor
- H9 : Outdoor air temperature thermistor

(R3043)

4.17 Electrical Box Temperature Rise

**Remote
Controller
Display**

L3

**Method of
Malfunction
Detection**

An electrical box temperature rise is detected by checking the radiation fin thermistor with the compressor off.

**Malfunction
Decision
Conditions**

With the compressor off, the radiation fin temperature is above 80°C. (Reset is made when the temperature drops below 70°C.)

**Supposed
Causes**

- Fin temperature rise due to defective outdoor unit fan
- Fin temperature rise due to short-circuit
- Fin thermistor defective
- Connector in poor contact
- Outdoor unit PCB defective

Troubleshooting



Check No.6
Refer to P.138



Check No.7
Refer to P.139



Check No.9
Refer to P.140

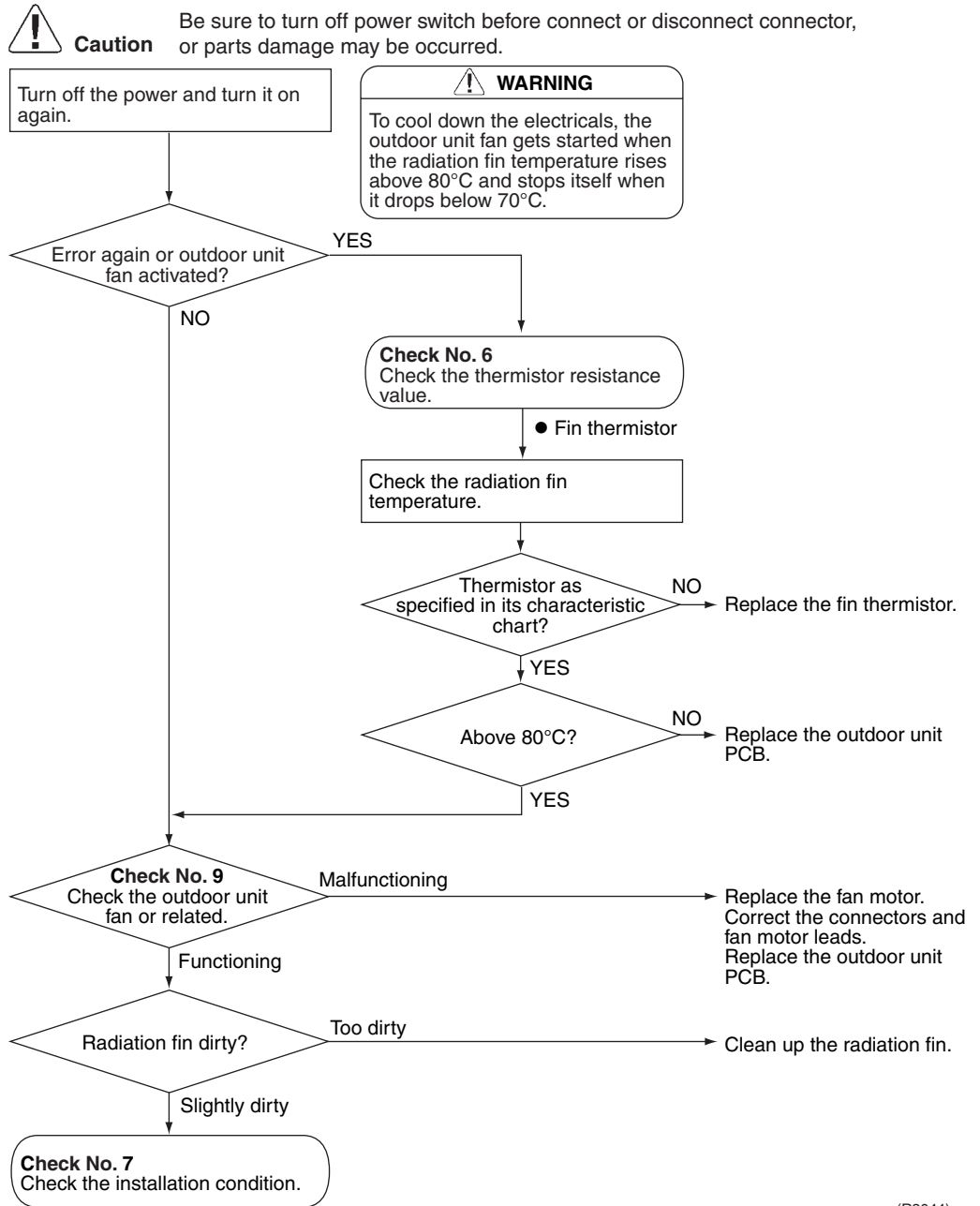

(R3044)

4.18 Radiation Fin Temperature Rise

Remote
Controller
Display

L4

Method of
Malfunction
Detection

A radiation fin temperature rise is detected by checking the radiation fin thermistor with the compressor on.

Malfunction
Decision
Conditions

If the radiation fin temperature with the compressor on is above 90°C,

- If a radiation fin temperature rise takes place 4 times successively, the system will be shut down.
- The error counter will reset itself if this or any other error does not occur during the following 60-minute compressor running time (total time).

Supposed
Causes

- Fin temperature rise due to defective outdoor unit fan
- Fin temperature rise due to short-circuit
- Fin thermistor defective
- Connector in poor contact
- Outdoor unit PCB defective

Troubleshooting



Check No.6
Refer to P.138



Check No.7
Refer to P.139



Check No.9
Refer to P.140



Caution

Be sure to turn off power switch before connect or disconnect connector, or parts damage may be occurred.

Turn off the power and turn it on again to get the system started.

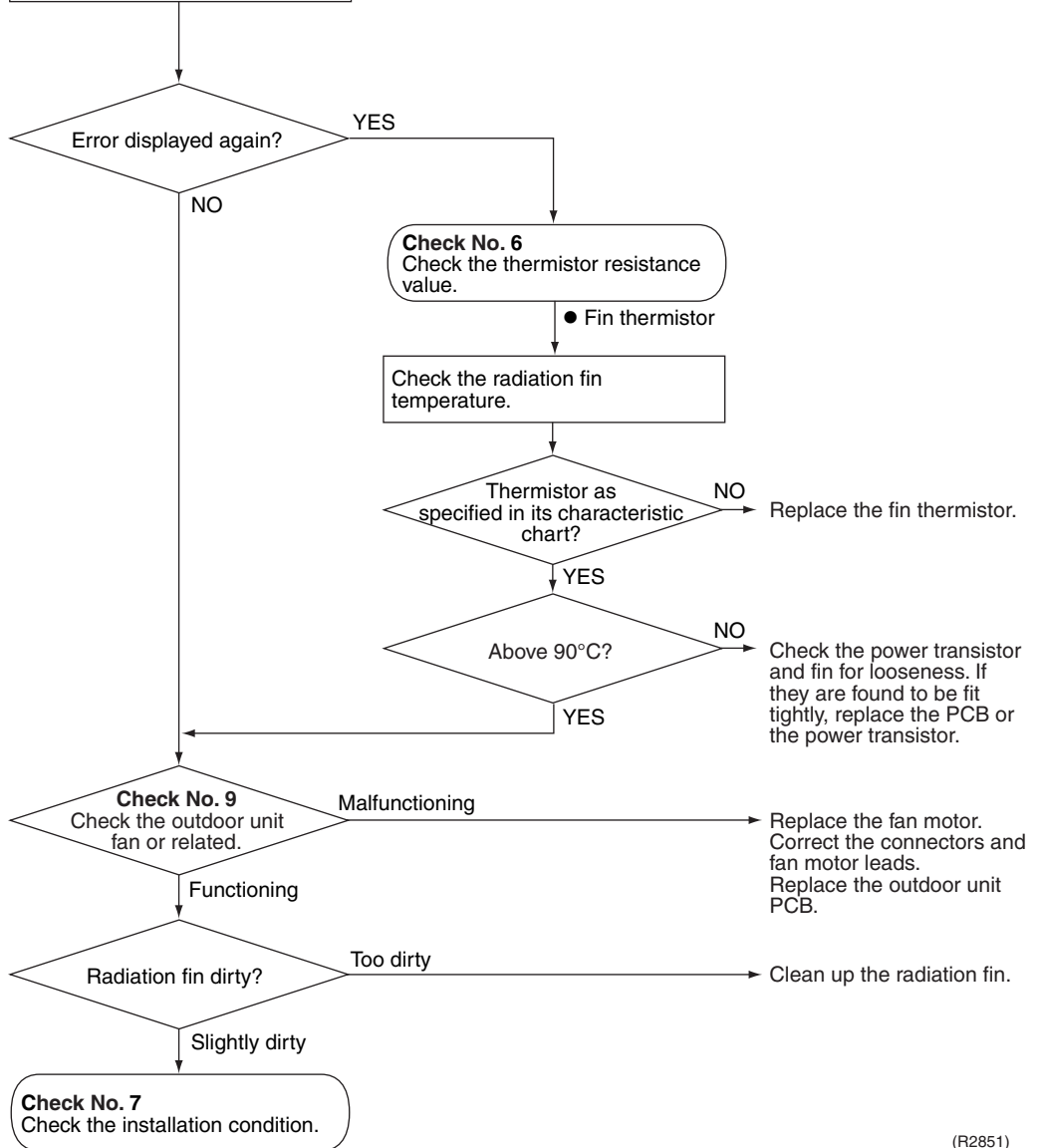

(R2851)

4.19 Output Over Current Detection

Remote
Controller
Display

L5

Method of
Malfunction
Detection

An output over-current is detected by checking the current that flows in the inverter DC section.

Malfunction
Decision
Conditions

- A position signal error occurs while the compressor is running.
- A speed error occurs while the compressor is running.
- An output over-current input is fed from the output over-current detection circuit to the microcomputer.
- The system will be shut down if the error occurs 16 times.
- Clearing condition: Continuous run for about 5 minutes (normal)

Supposed
Causes

- Over-current due to defective power transistor
- Over-current due to wrong internal wiring
- Over-current due to abnormal supply voltage
- Over-current due to defective PCB
- Error detection due to defective PCB
- Over-current due to closed stop valve
- Over-current due to compressor failure
- Over-current due to poor installation condition

Troubleshooting



Check No.7
Refer to P.139



Check No.8
Refer to P.140



Check No.13
Refer to P.142



Caution Be sure to turn off power switch before connect or disconnect connector, or parts damage may be occurred.

* An output over-current may result from wrong internal wiring. If the wires have been disconnected and reconnected for part replacement, for example, and the system is interrupted by an output over-current, take the following procedure.

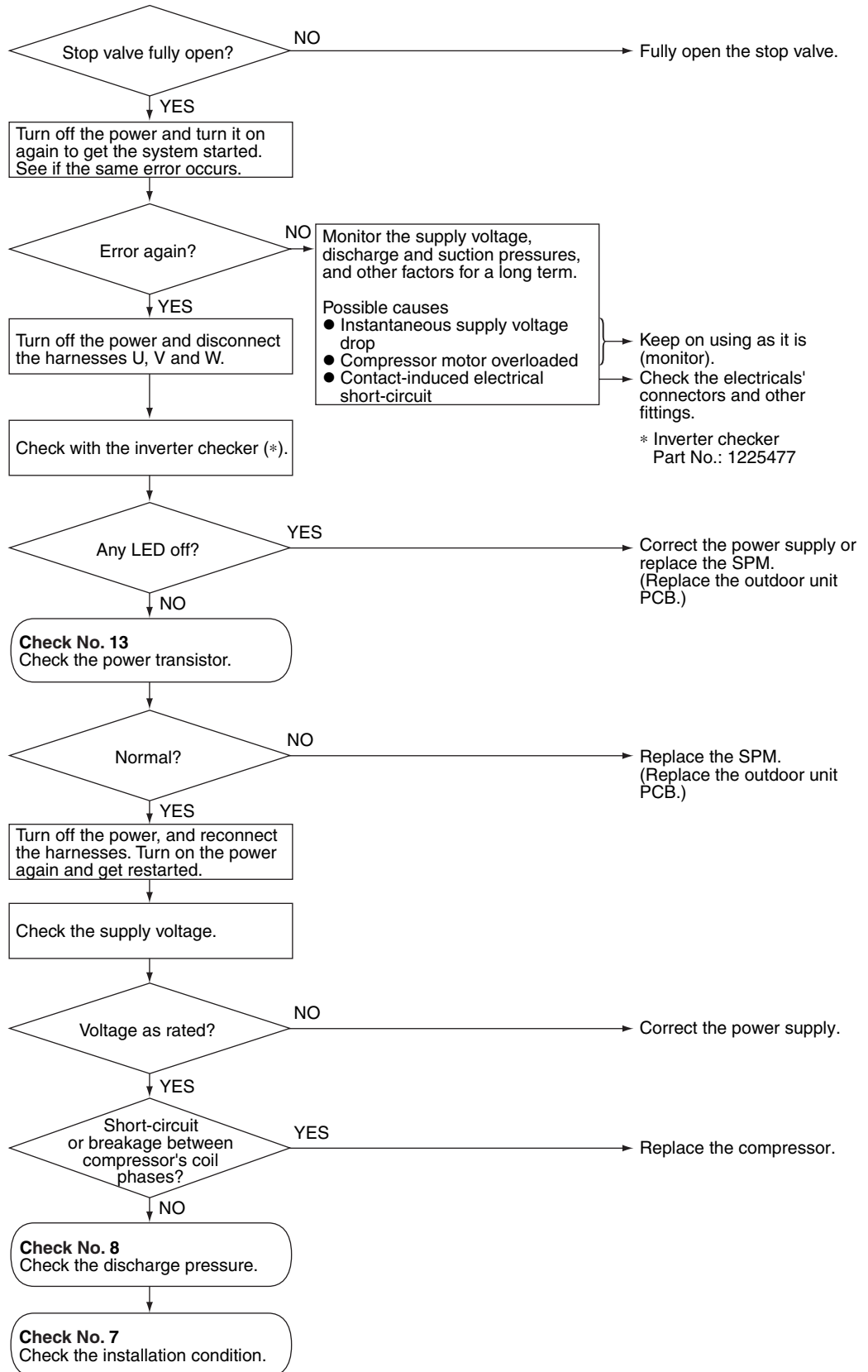

Keep on using as it is (monitor).
Check the electricals' connectors and other fittings.

* Inverter checker
Part No.: 1225477

(R2852)



Note: If the model doesn't have SPM, replace the outdoor unit PCB.

4.20 Insufficient Gas

Remote
Controller
Display

U0

Method of
Malfunction
Detection

Gas shortage detection I : A gas shortage is detected by checking the power consumption value and the compressor running frequency.

Gas shortage detection II : A gas shortage is detected by checking the difference between indoor unit heat exchanger temperature and room temperature as well as the difference between outdoor unit heat exchanger temperature and room temperature.

Malfunction
Decision
Conditions

Gas shortage detection I :

Power consumption < $1862 / 256 (A/Hz) \times$ Compressor running frequency + (-18)

However, when the status of running frequency > 61 (Hz) is kept on for a certain time.

Note : The values are different from model to model.

Gas shortage detection II :

When the condition of the following 1-3 continued for a certain time.

1. During discharge pipe temperature control
2. Discharge pipe temp. > $(255 / 256) \times$ target discharge pipe temp. +20
3. Electronic expansion valve opening (the biggest value among operating units) ≥ 450

If a gas shortage error takes place 4 times successively, the system will be shut down. The error counter will reset itself if this or any other error does not occur during the following 60-minute compressor running time (total time).

Supposed
Causes

- Refrigerant shortage (refrigerant leakage)
- Poor compression performance of compressor
- Discharge pipe thermistor disconnected, or indoor unit or outdoor unit heat exchanger thermistor disconnected, room or outdoor air temperature thermistor disconnected
- Stop valve closed
- Electronic expansion valve defective

Troubleshooting



Check No.4
Refer to P.136



Check No.6
Refer to P.138



Caution

Be sure to turn off power switch before connect or disconnect connector, or parts damage may be occurred.

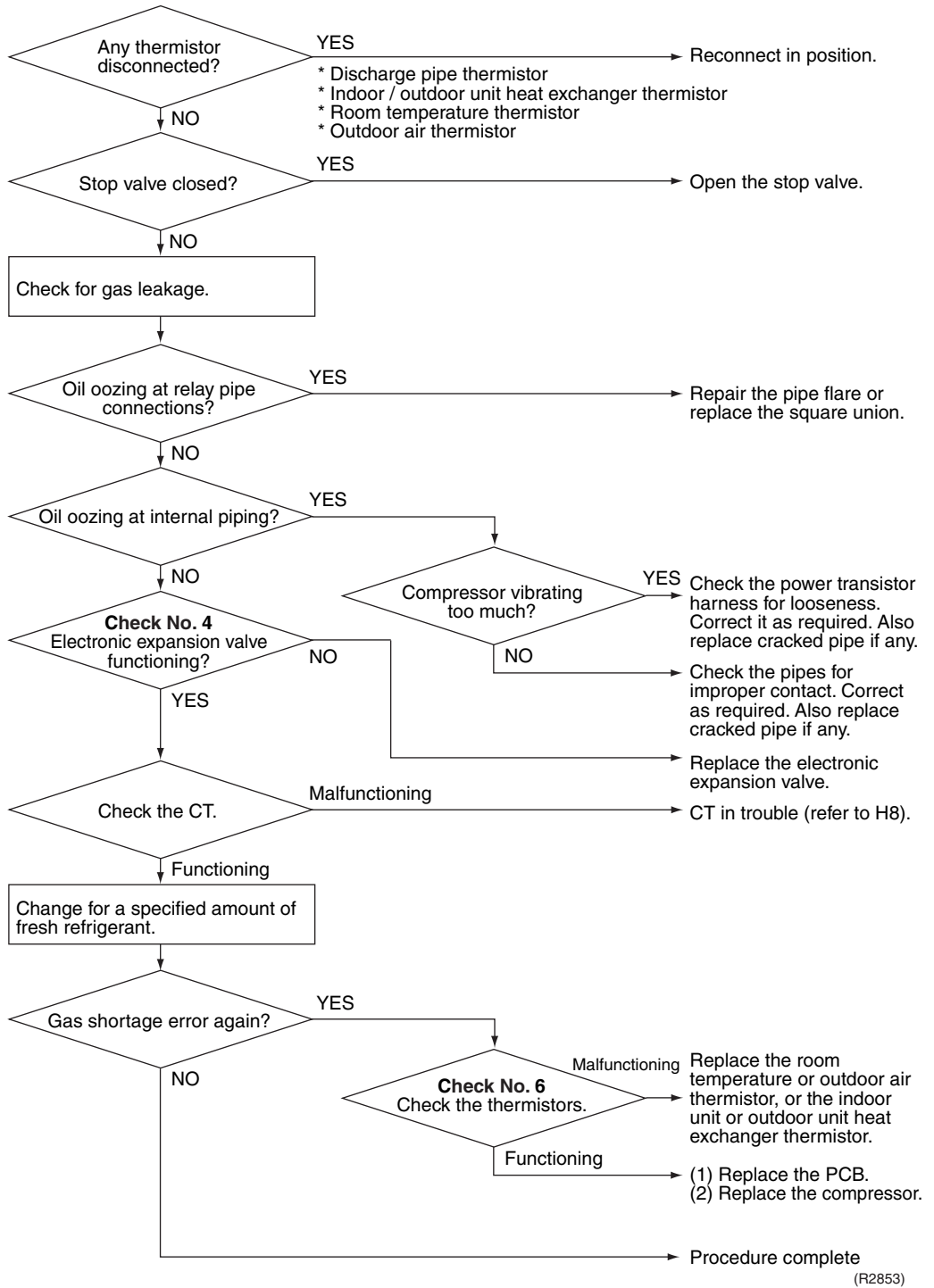

4.21 Over-voltage Detection

Remote
Controller
Display

U2

Method of
Malfunction
Detection

An abnormal voltage rise is detected by checking the detection circuit or DC voltage detection circuit.

Malfunction
Decision
Conditions

- An over-voltage signal is fed from the over-voltage detection circuit to the microcomputer, or more than 430 V occurred the voltage detected by the DC voltage detection circuit.
- The system will be shut down if the error occurs 4 times.
- Clearing condition: Continuous run for about 60 minutes (normal)

Supposed
Causes

- Supply voltage not as specified
- Over-voltage detector or DC voltage detection circuit defective
- PAM control part(s) defective

Troubleshooting

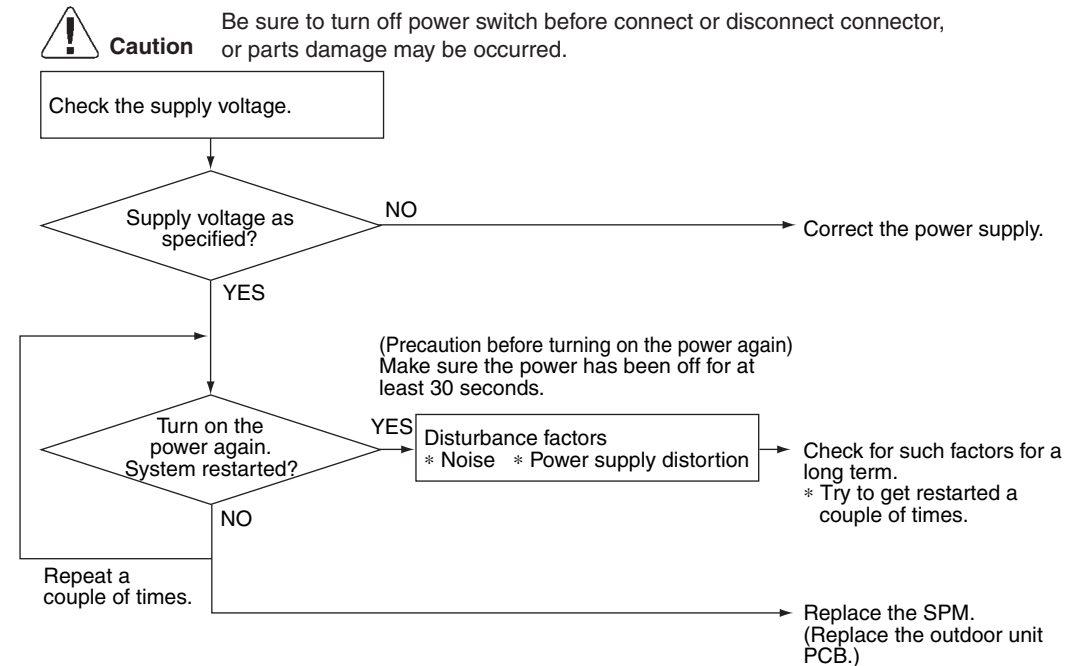

Note: If the model doesn't have SPM, replace the outdoor unit PCB.

4.22 Anti-icing Function in Other Rooms / Unspecified Voltage (between Indoor and Outdoor Units)

Remote Controller Display

UR,UH

Method of Malfunction Detection

A wrong connection is detected by checking the combination of indoor and outdoor units on the microcomputer.

Malfunction Decision Conditions

- Operation halt due to the anti-icing function in other rooms
- Operation halt due to unspecified voltage between indoor and outdoor units

Supposed Causes

- Operation halt due to the anti-icing function in other rooms
- Wrong connections at the indoor unit
- PCB wrongly connected

Troubleshooting

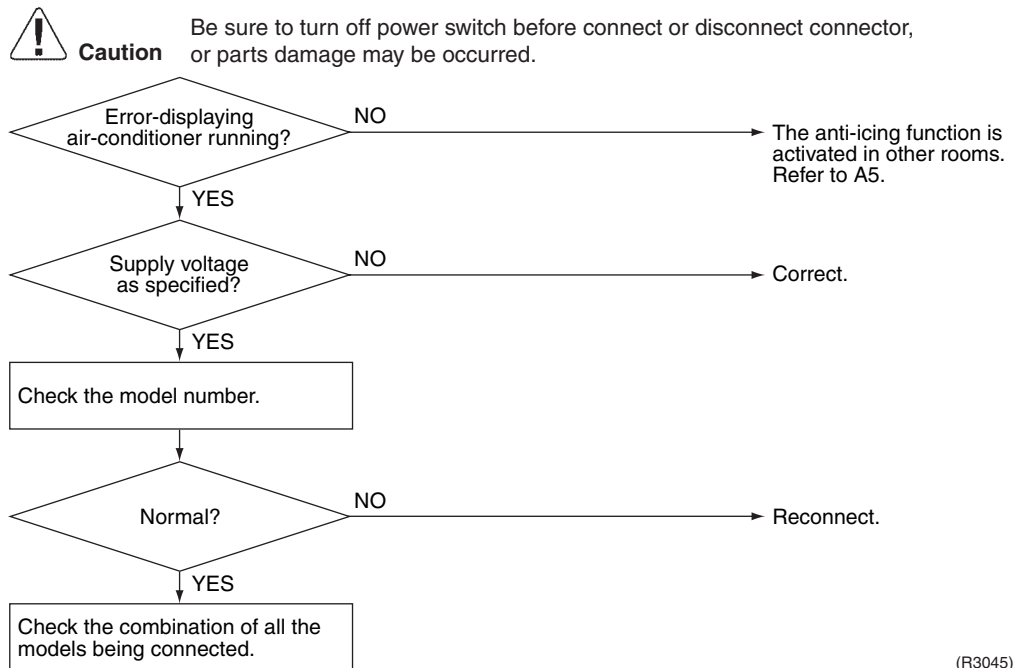

(R3045)

4.23 Outdoor Unit PCB Abnormality or Signal Transmission Circuit Abnormality

Remote
Controller
Display

U4

Method of
Malfunction
Detection

The data received from the outdoor unit in indoor unit-outdoor unit signal transmission is checked whether it is normal.

Malfunction
Decision
Conditions

When the data sent from the outdoor unit cannot be received normally, or when the content of the data is abnormal.

If the indoor unit cannot communicate with the outdoor unit for 15 seconds, the system will be shut down.

Supposed
Causes

- Faulty outdoor unit PCB.
- Faulty indoor unit PCB.
- Indoor unit-outdoor unit signal transmission error due to wiring error.
- Indoor unit-outdoor unit signal transmission error due to breaking of wire in the connection wires between the indoor and outdoor units (the transmission wire).

Troubleshooting

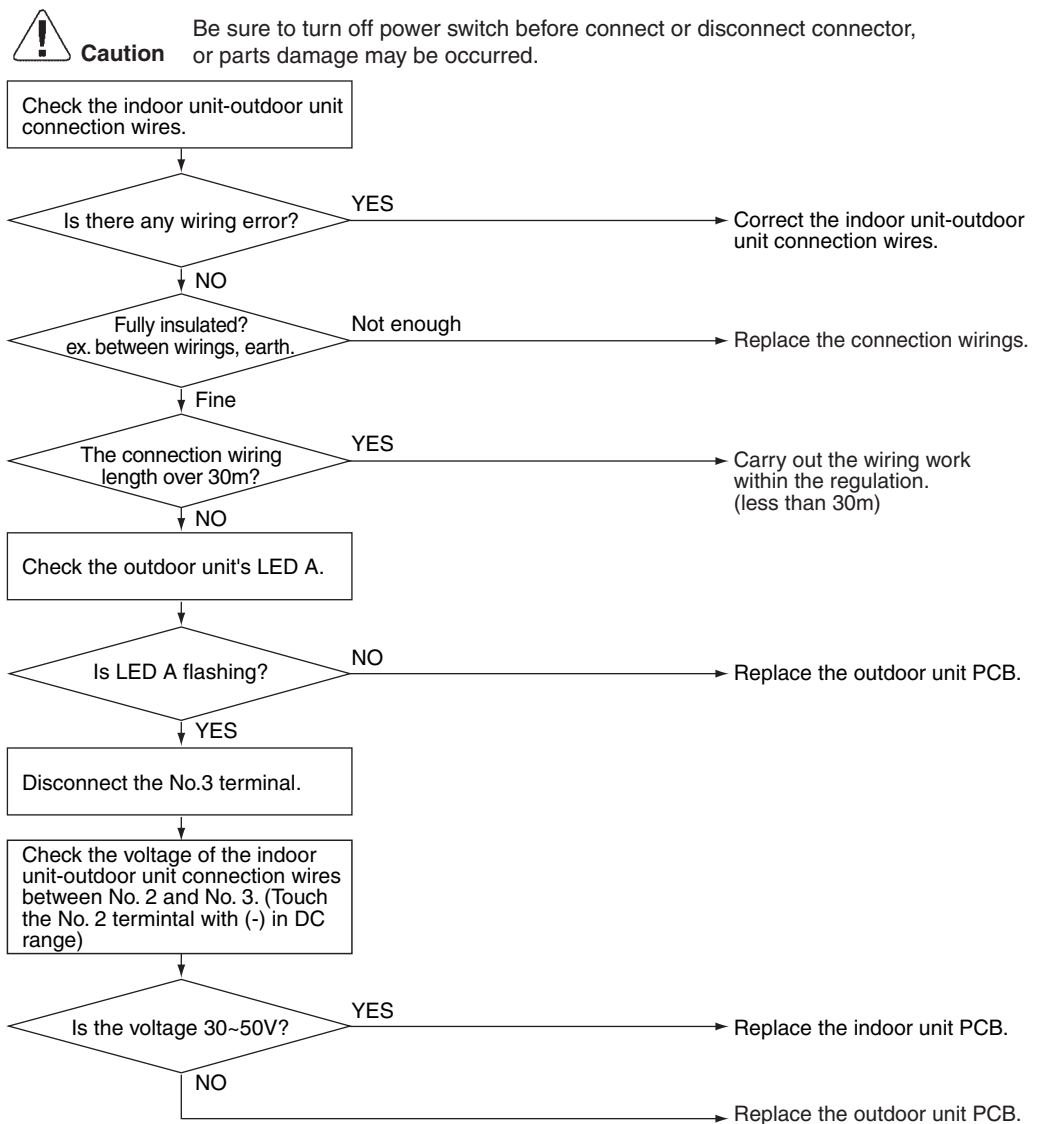

(R3046)

5. Check

5.1 How to Check

5.1.1 Electronic Expansion Valve Check

Check No.4

Conduct the followings to check the electronic expansion valve (EV).

1. Check to see if the EV connector is correctly inserted in the PCB. Compare the EV unit and the connector number.
2. Turn the power off and back on again, and check to see if all the EVs generate latching sound.
3. If any of the EVs does not generate latching noise in the above step 2, disconnect that connector and check the continuity using a tester.
Check the continuity between pins 1, 3 and 6, and between pins 2, 4 and 5. If there is no conductivity between the pins, the EV coil is faulty.
4. If no EV generates latching sound in the above step 2, the outdoor unit PCB is faulty.
5. If the continuity is confirmed in the above step 3, mount a good coil (which generated latching sound) in the EV unit that did not generate latching sound, and check to see if that EV generates latching sound.
*If latching sound is generated, the outdoor unit PCB is faulty.
*If latching sound is not generated, the EV unit is faulty.



Note: Please note that the latching sound varies depending on the valve type.

Valve Body Condition (Symptom)	Check Method / Measure
(1) Valve body catches at fully opened or half opened position. (Symptom) Cooling: ■Water leakage at the no-operation unit ■Flow noise of refrigerant in the no-operation unit ■Operation halt due to anti-icing function Heating: ■The unit does not heat ■Refrigerant flow rate vary by unit (Discharge air temperatures are different by room) ■Peak cut	Reset power supply and conduct cooling operation unit by unit.
(2) Valve body catches at complete close position. (Symptom) Cooling: ■The only unit having problem does not cool the room . ■When the only faulty unit is in operation, the unit makes pump down. (The low pressure of the unit becomes vacuum) ■IT is activated. ■Abnormal discharge pipe temperature Heating: Insufficient gas due to liquid refrigerant stagnation inside the faulty indoor unit (Only for heat pump model) ■The unit does not heat the room. ■OL is activated. ■Abnormal discharge pipe temperature	Reset power supply and conduct cooling operation unit by unit.
(3) Valve does not open fully. (Symptom) ■The unit does not cool nor heat (only for heat pump model.) ■OL is actuated. ■Abnormal discharge pipe temperature	Check the number of rotation of shaft if it is 5 and half from full open to complete close using manual coil for electronic expansion valve. When the number of rotation of shaft is less than the above value, the valve may catch anywhere of the body.

5.1.2 Four Way Valve Performance Check

Check No.5

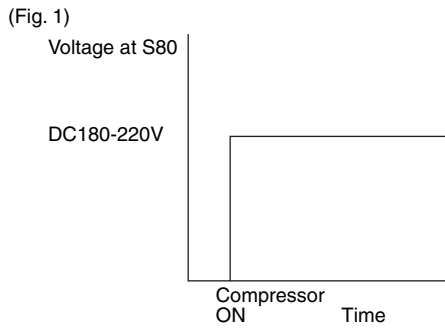
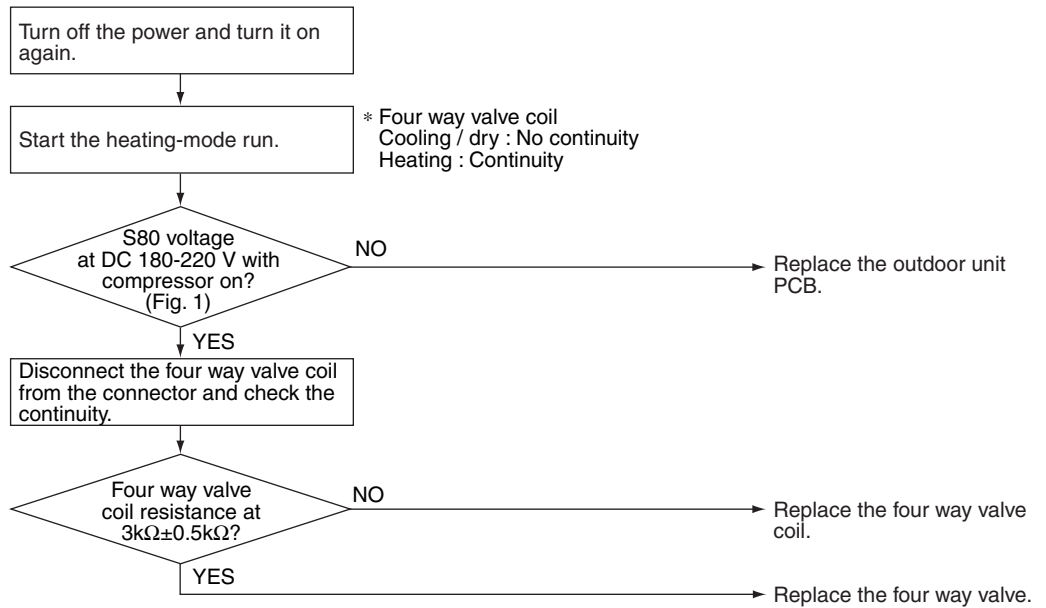

(R3047)

5.1.3 Thermistor Resistance Check

Check No.6

Remove the connectors of the thermistors on the PCB, and measure the resistance of each thermistor using tester.

The relationship between normal temperature and resistance is shown in the graph and the table below.

Temperature (°C)	Thermistor R25°C=20kΩ B=3950
-20	211.0 (kΩ)
-15	150
-10	116.5
-5	88
0	67.2
5	51.9
10	40
15	31.8
20	25
25	20
30	16
35	13
40	10.6
45	8.7
50	7.2

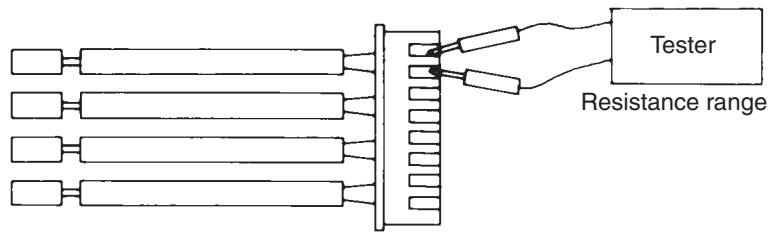

(R25 = 20kΩ, B = 3950)

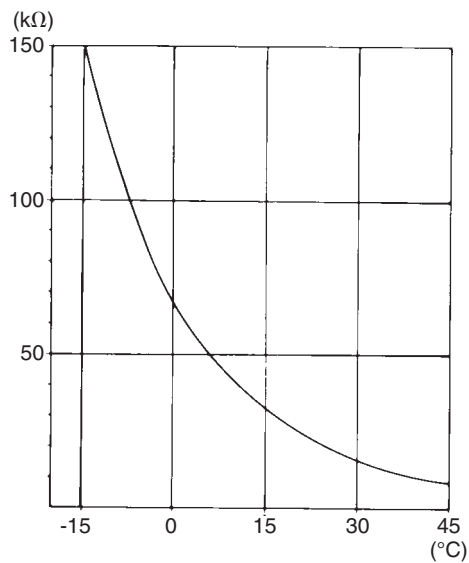

(R1437)

5.1.4 Installation Condition Check

Check No.7

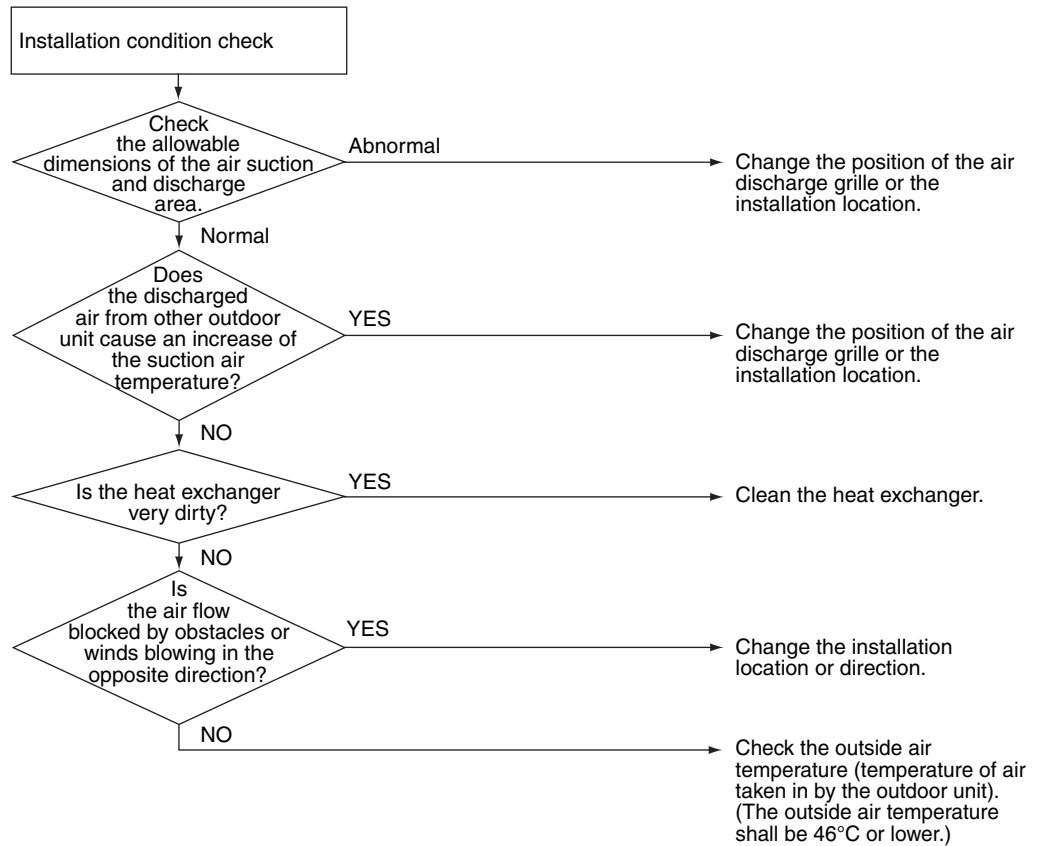

(R3048)

5.1.5 Discharge Pressure Check

Check No.8

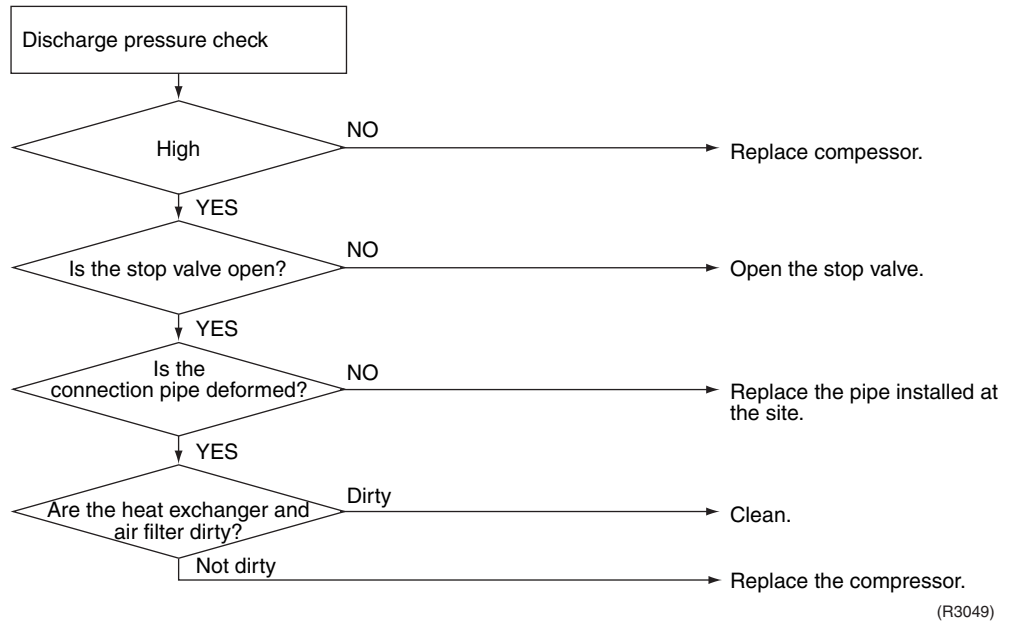

5.1.6 Outdoor Unit Fan System Check (With DC Motor)

Check No.9

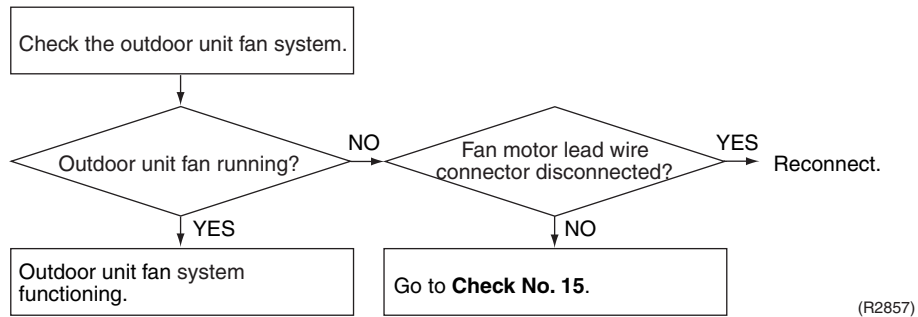

5.1.7 Inverter Units Refrigerant System Check

Check No.11

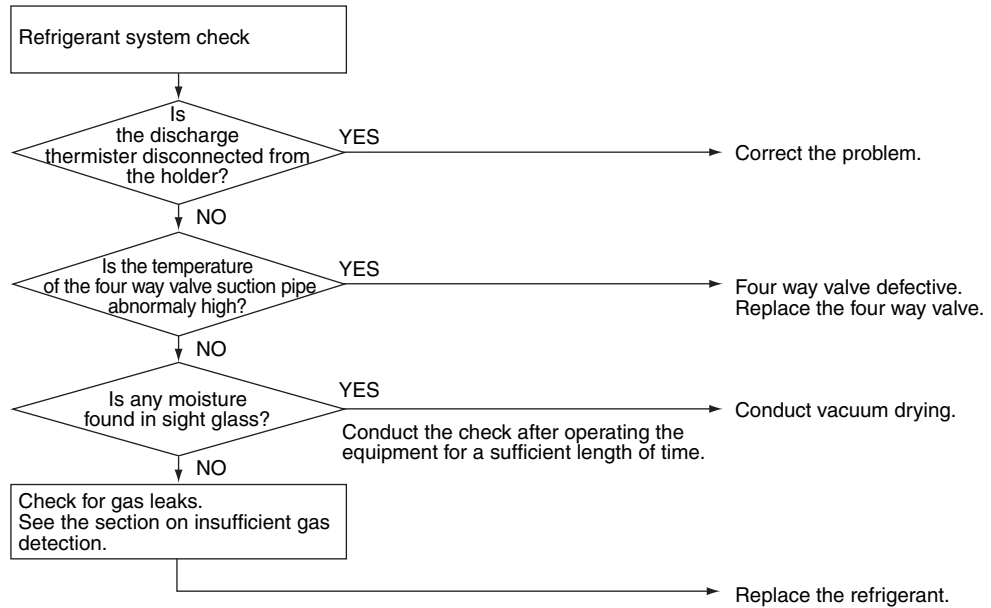

(R3050)

5.1.8 Capacitor Voltage Check

Check No.12

Before this checking, be sure to check the main circuit for short-circuit.

- Checking the capacitor voltage
- With the circuit breaker still on, measure the voltage according to the drawing. Be careful never to touch any live parts.

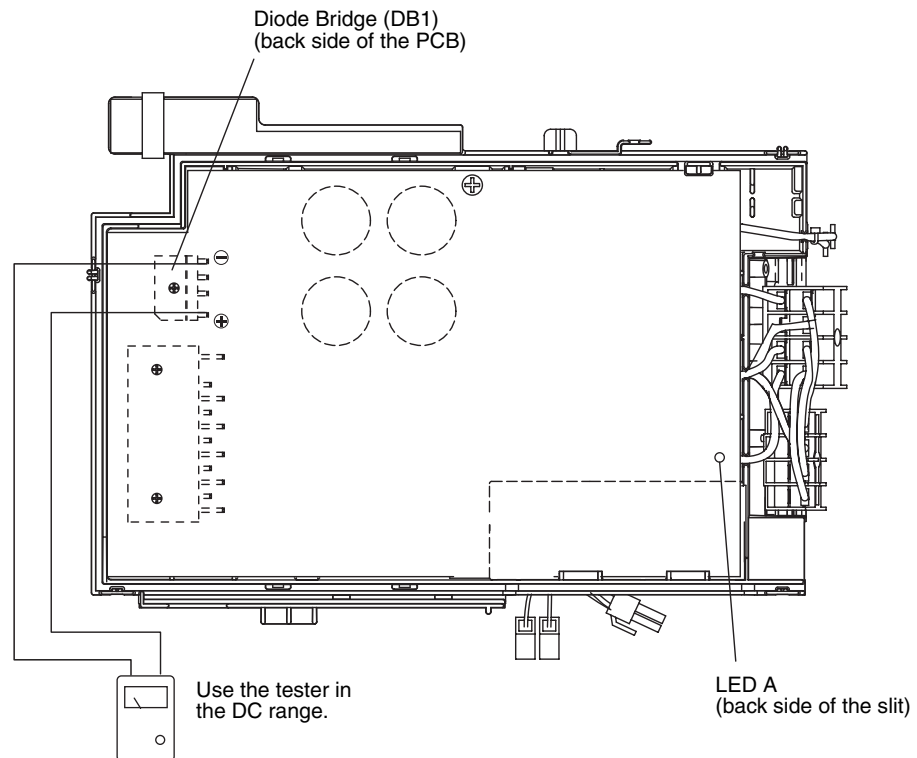

(R3051)

5.1.9 Power Transistor Check

Check No.13

- Checking the power transistor
- Never touch any live parts for at least 10 minutes after turning off the circuit breaker.
- If unavoidably necessary to touch a live part, make sure the power transistor's supply voltage is below 50 V using the tester.
- For the UVW, make measurements at the Faston terminal on the PCB or the relay connector.

Tester's negative terminal	Power transistor (+)	UVW	Power transistor (-)	UVW
Tester's positive terminal	UVW	Power transistor (+)	UVW	Power transistor (-)
Normal resistance	Several kohms to several Mohms			
Abnormal resistance	0 or ∞			

5.1.10 Main Circuit Electrolytic Capacitor Check

Check No.14

- Checking the main circuit electrolytic capacitor
- Never touch any live parts for at least 10 minutes after turning off the circuit breaker.
- If unavoidably necessary to touch a live part, make sure there is no DC voltage using the tester.
- Check the continuity with the tester. Reverse the pins and make sure there is continuity.

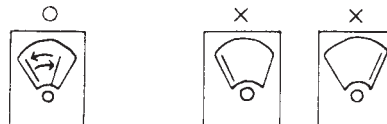
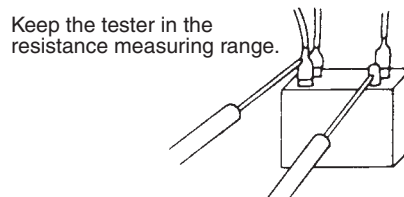

When the pointer swings, it means the capacitor functions.

If the pointer does not swing at all, or if it swings all the way but does not return, it means the capacitor malfunction.

(Q0367)

5.1.11 Turning Speed Pulse Input on the Outdoor Unit PCB Check

Check No.15

<Propeller fan motor>

Make sure the voltage of 290~380V is being applied.

- (1) Stop the operation first and then the power off, and disconnect the connector S70.
- (2) Make sure there is about DC 280 V between pins 4 and 7.
- (3) With the system and the power still off, reconnect the connector S70.
- (4) Make a turn of the fan motor with a hand, and make sure the pulse (0-15 V) appears twice at pins 1 and 4.

If the fuse is blown out, the outdoor-unit fan may also be in trouble. Check the fan too.

If the voltage in Step (2) is not applied, it means the PCB is defective. Replace the PCB.

If the pulse in Step (4) is not available, it means the Hall IC is defective. Replace the DC fan motor.

If there are both the voltage (2) and the pulse (4), replace the PCB.

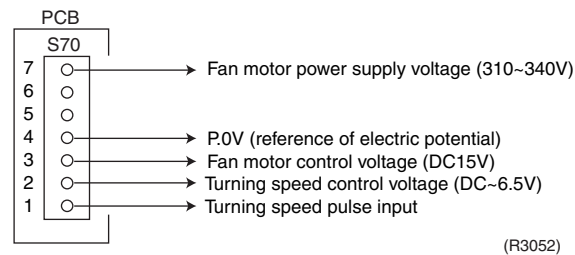

* Propeller fan motor : S70

5.1.12 Hall IC Check

Check No.16

1. Check the connector connection.
2. With the power ON, operation OFF, and the connector connected, check the following.
 - *Output voltage of about 5 V between pins 1 and 3.
 - *Generation of 3 pulses between pins 2 and 3 when the fan motor is operating.

Failure of (1) → faulty PCB → Replace the PCB.

Failure of (2) → faulty hall IC → Replace the fan motor.

Both (1) and (2) result → Replace the PCB.

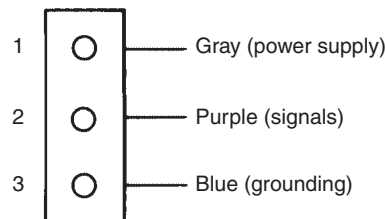

Part 7

Removal Procedure

1. Outdoor Unit.....	146
1.1 Removal of the Panels / Fan Motor.....	146
1.2 Removal of the PCB.....	151
1.3 Removal of the Electrical Box	156
1.4 Removal of the Sound Blanket.....	159
1.5 Removal of the Thermistor	162
1.6 Removal of the Four Way Valve.....	163
1.7 Removal of the Electronic Expansion Valve.....	165
1.8 Removal of the Compressor.....	166

1. Outdoor Unit

1.1 Removal of the Panels / Fan Motor

Procedure



Warning

Be sure to wait 10 minutes or more after turning off all power supplies before disassembling work.

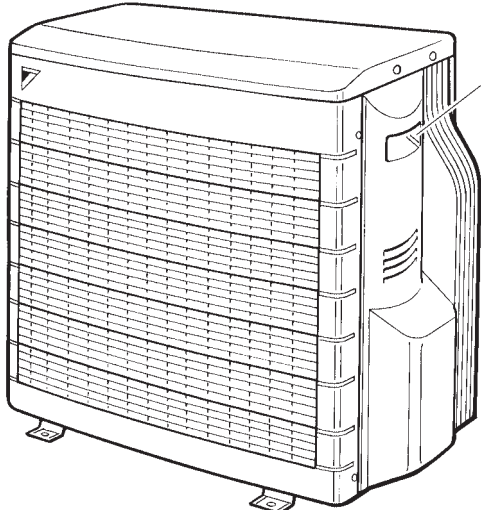
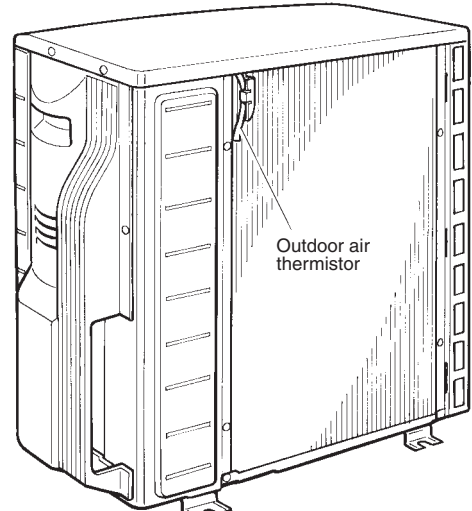
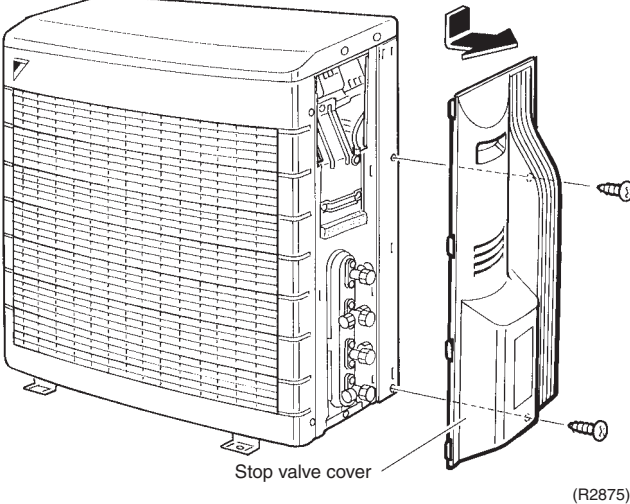
Step	Procedure	Points
1. Features	 <p>(R2873)</p>  <p>(R2874)</p>  <p>(R2875)</p>	<ul style="list-style-type: none"> Take care not to cut your finger by the fins of the heat exchanger.
1	<p>Loosen the two screws. Pull the stop valve cover down and remove it.</p>	

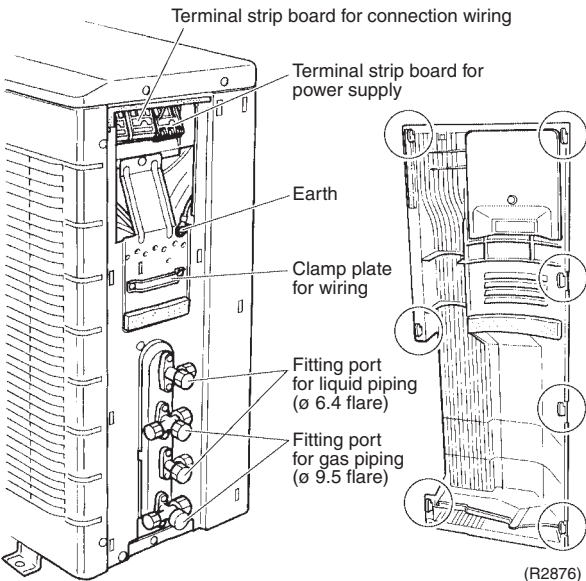
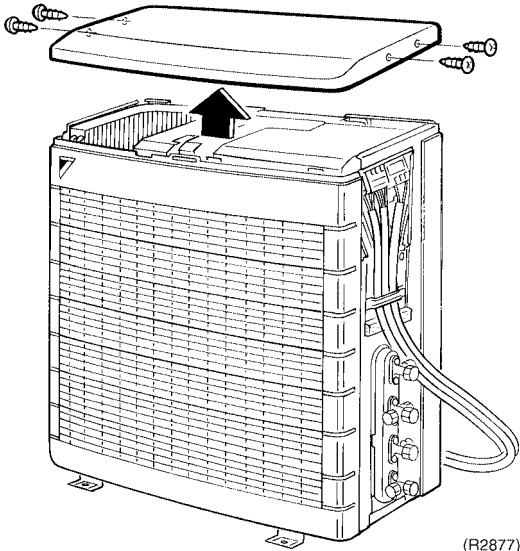
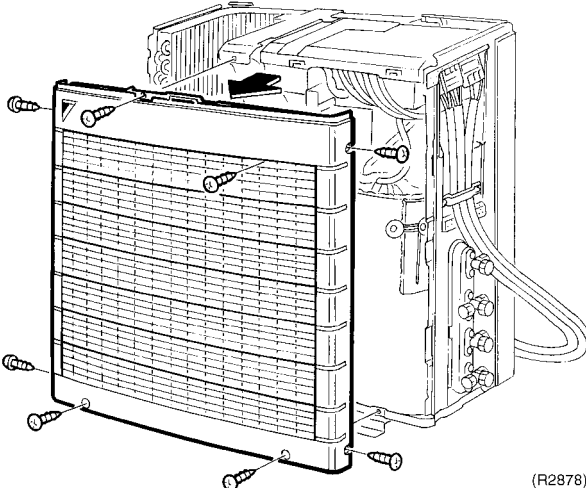
Step	Procedure	Points
		<ul style="list-style-type: none"> ■ Make sure that the seven claws are fit securely when reassembling.
<p>2. Remove the top panel.</p> <p>1 Loosen the four screws and lift the top panel.</p> <p>2 Loosen the seven screws of the front panel.</p>	 	

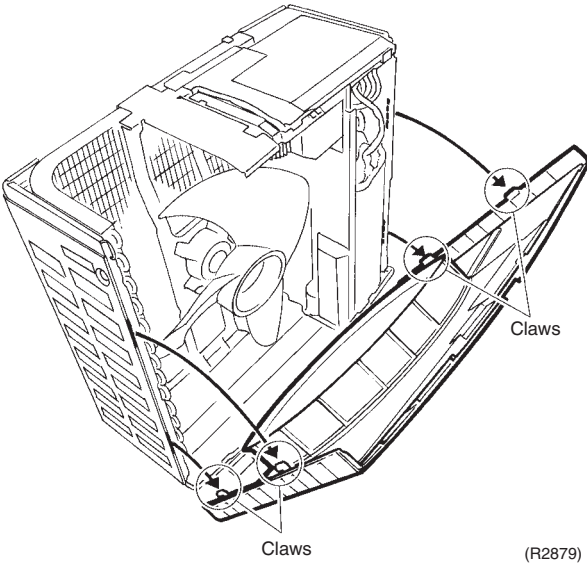
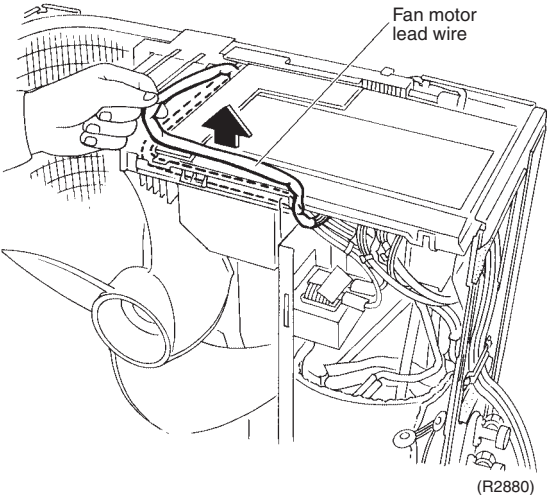
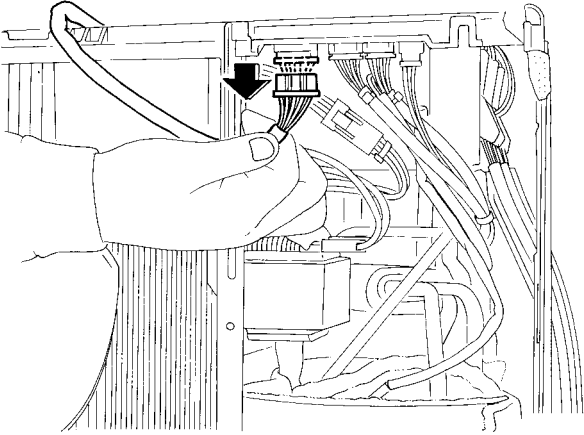
Step	Procedure	Points
3	<p>Undo the claws and pull the front panel out towards you.</p>  <p style="text-align: right;">(R2879)</p>	<ul style="list-style-type: none"> ■ The front panel has four claws. ■ It is possible to remove the bell mouth.
<p>3. Remove the propeller fan.</p> <p>1</p> <p>2</p>	<p>Release the fan motor lead wire from the ditch of the electrical box.</p>  <p style="text-align: right;">(R2880)</p> <p>Disconnect the connector for fan motor (S70).</p>  <p style="text-align: right;">(R2881)</p>	

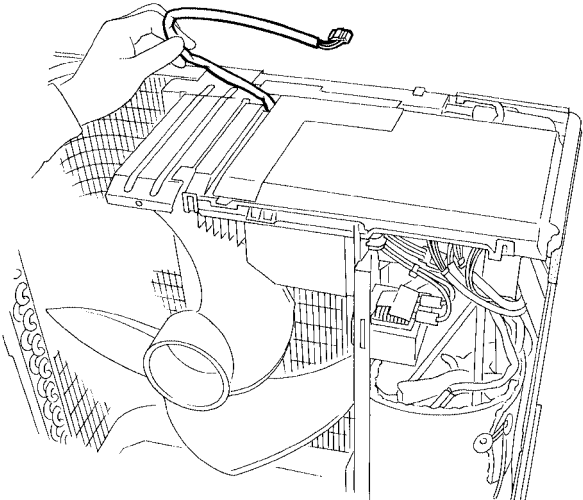
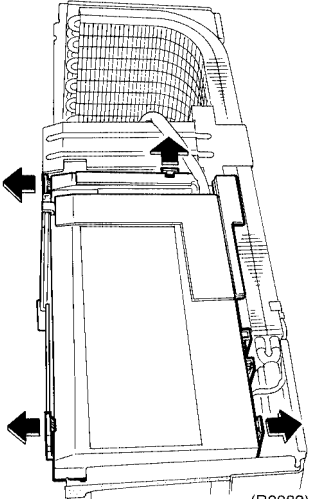
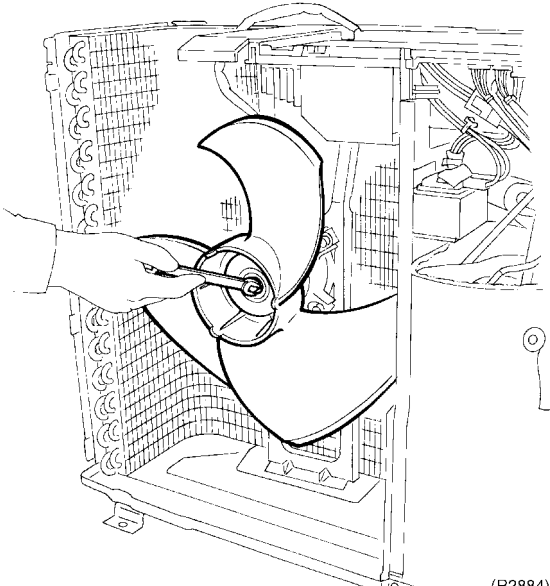
Step	Procedure	Points
3	<p>Pull the fan motor lead wire away.</p>  <p>(R2882)</p>	
4	<p>Release the four claws and remove the electrical box cover.</p>  <p>(R2883)</p>	
5	<p>Unscrew the washer-fitted nut (M10) of the propeller fan with a spanner.</p>  <p>(R2884)</p>	

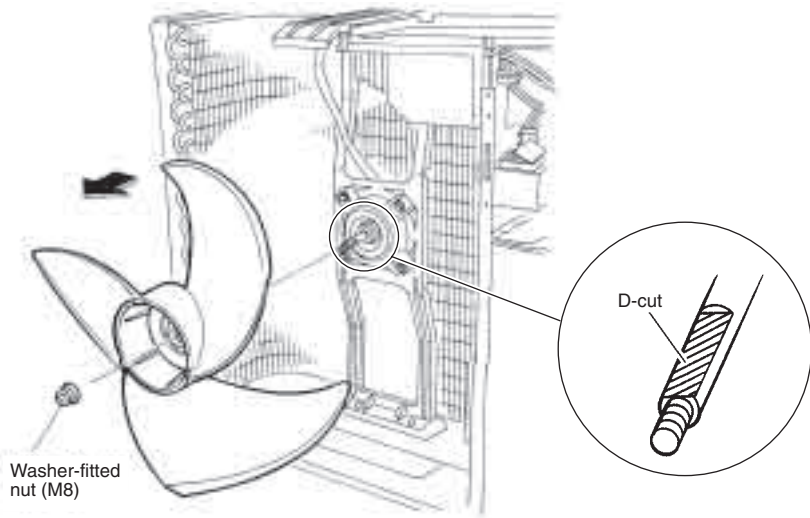
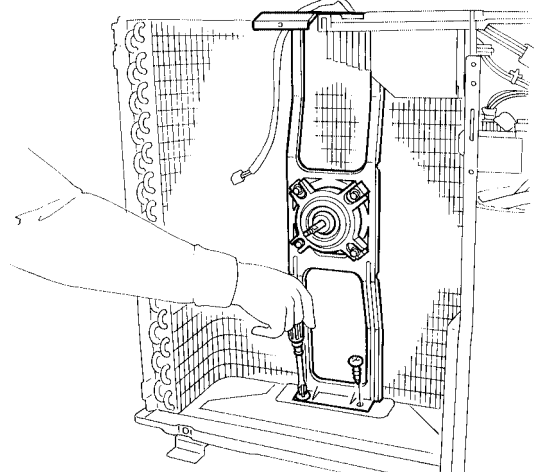
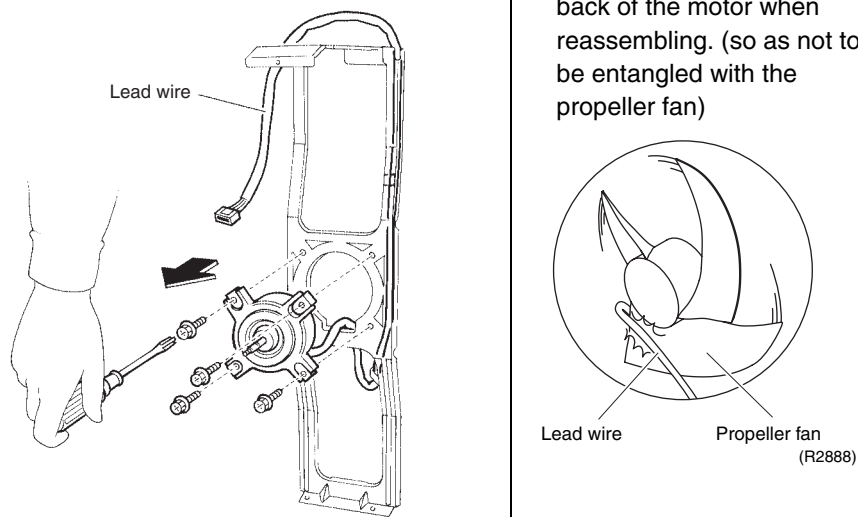
Step	Procedure	Points
6	Remove the propeller fan.	<ul style="list-style-type: none"> Align ▼ mark of the propeller fan with D-cut section of the motor shaft when reassembling.  <p>Washer-fitted nut (M8)</p> <p>D-cut</p> <p>(R2885)</p>
7	Remove the two screws from the fan motor.	 <p>(R2886)</p>
8	Unlock the fixing claws and release the lead wire.	<ul style="list-style-type: none"> Put the lead wire through the back of the motor when reassembling. (so as not to be entangled with the propeller fan)  <p>Lead wire</p> <p>Lead wire</p> <p>Propeller fan (R2888)</p> <p>(R2887)</p>

1.2 Removal of the PCB

Procedure



Warning

Be sure to wait 10 minutes or more after turning off all power supplies before disassembling work.

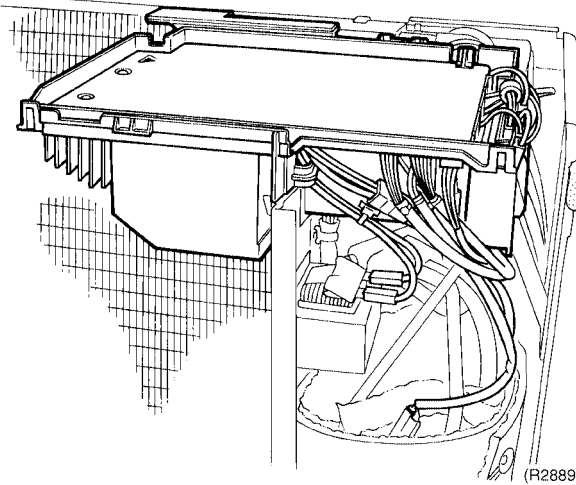
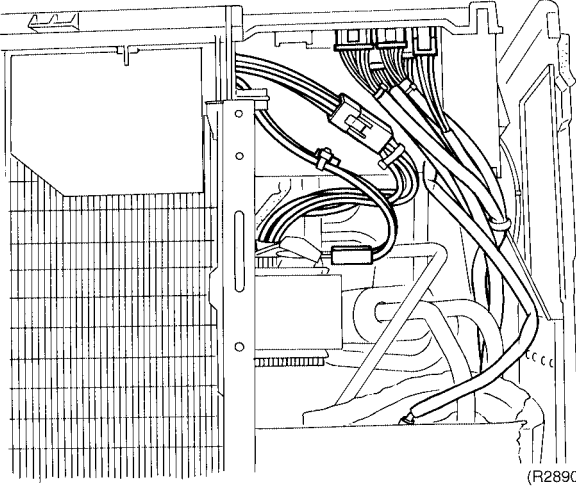
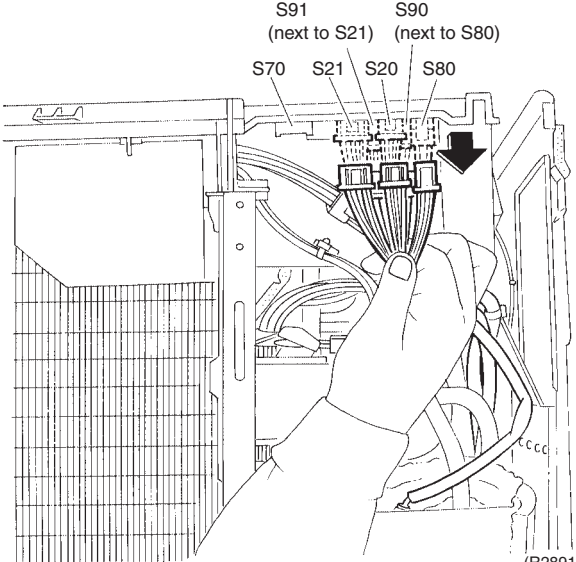
Step	Procedure	Points
<ul style="list-style-type: none"> ■ Disconnect the fan motor lead wire. 		
1. Remove the PCB.		<ul style="list-style-type: none"> ■ The PCB is upside down for the sake of quality improvement.
1 The illustration shows appearance of the PCB.	 <p style="text-align: right;">(R2889)</p>	<ul style="list-style-type: none"> ■ Lead free soldering PbF is adopted.
2 The illustration shows arrangement of the relaying connectors.	 <p style="text-align: right;">(R2890)</p>	
3 Disconnect the connectors. S20:electronic expansion valve (EVA) S21:electronic expansion valve (EVB) S70:fan motor S80:four way valve S90:thermistor (discharge pipe, outdoor air, heat exchanger) S91:thermistor (liquid pipe, gas pipe)	 <p style="text-align: right;">(R2891)</p>	

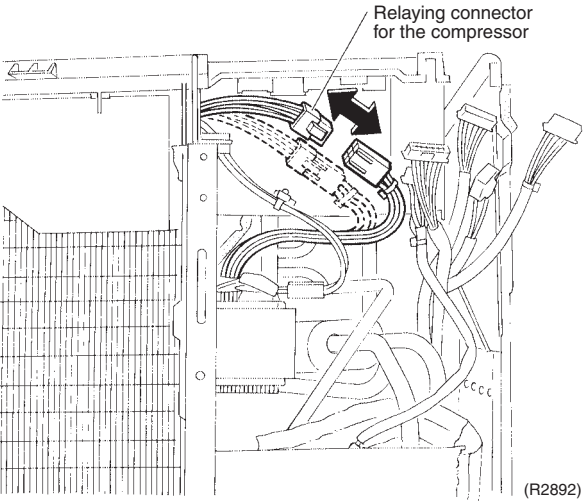
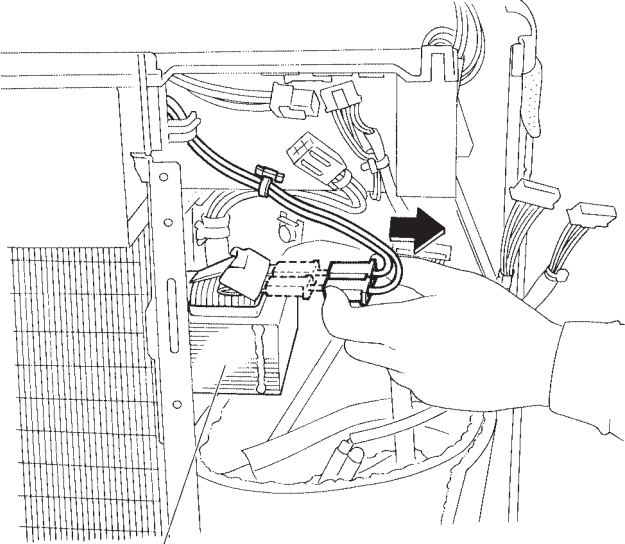
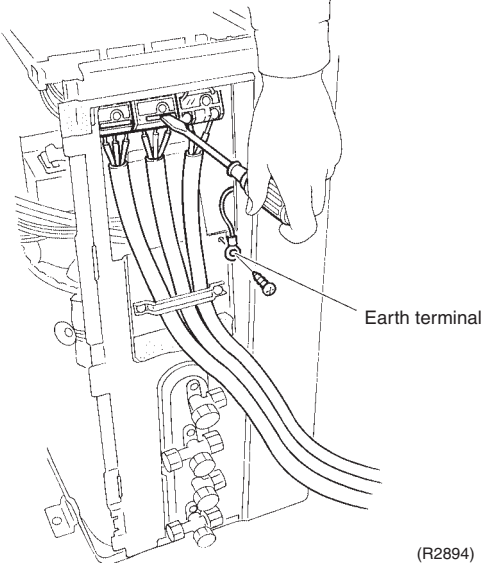
Step	Procedure	Points
4	<p>Disconnect the relaying connector for the compressor.</p>  <p style="text-align: right;">(R2892)</p>	
5	<p>Disconnect the two connectors of the reactor.</p>  <p style="text-align: center;">Reactor</p> <p style="text-align: right;">(R2893)</p>	
6 7	<p>Disconnect the earth terminal.</p> <p>Disconnect the connection wiring and the power supply wiring.</p>  <p style="text-align: right;">Earth terminal</p> <p style="text-align: right;">(R2894)</p>	

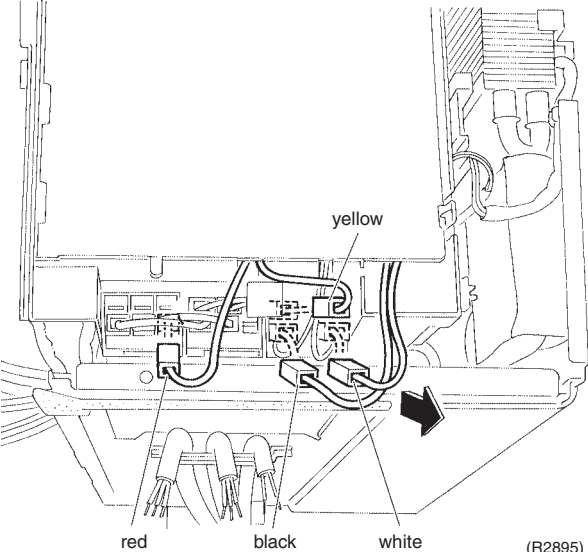
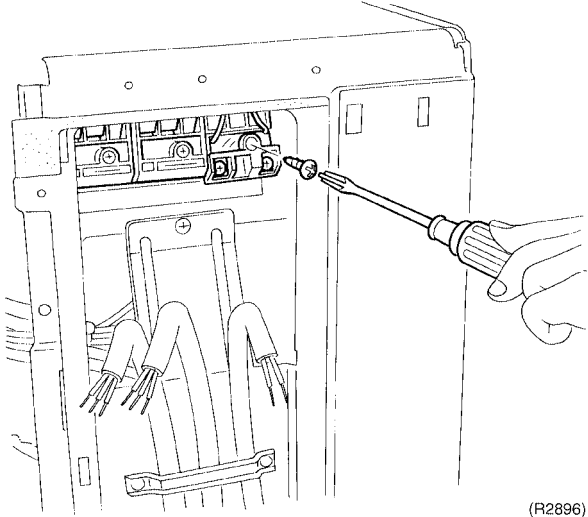
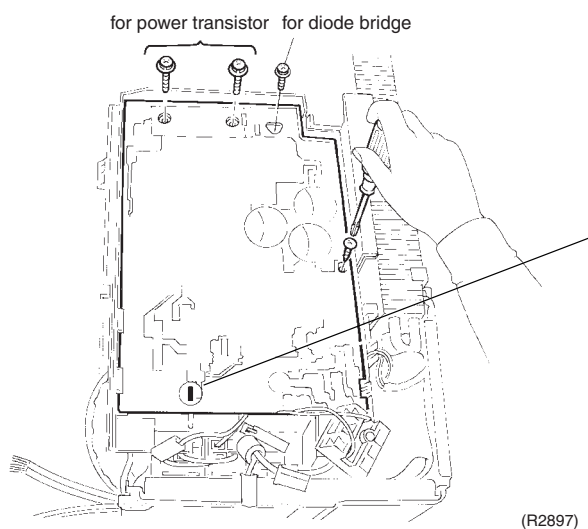
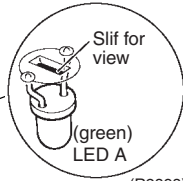
Step	Procedure	Procedure	Points
8	Disconnect the harnesses.	 <p style="text-align: center;">yellow</p> <p style="text-align: center;">red black white</p> <p style="text-align: right;">(R2895)</p>	
9	Loosen the screw of the terminal strip board.	 <p style="text-align: right;">(R2896)</p>	<ul style="list-style-type: none"> ■ A thermal fuse is united with the terminal strip board.
10	Loosen the four screws of the PCB.	 <p style="text-align: center;">for power transistor for diode bridge</p> <p style="text-align: right;">(R2897)</p>	<ul style="list-style-type: none"> ■ The PCB is upside down for the sake of quality improvement. ■ Service monitor (LED-A) <div style="text-align: center;">  <p style="text-align: center;">Slit for view (green) LED A (R2898)</p> </div> <ul style="list-style-type: none"> ■ You can see the LED through the slit.

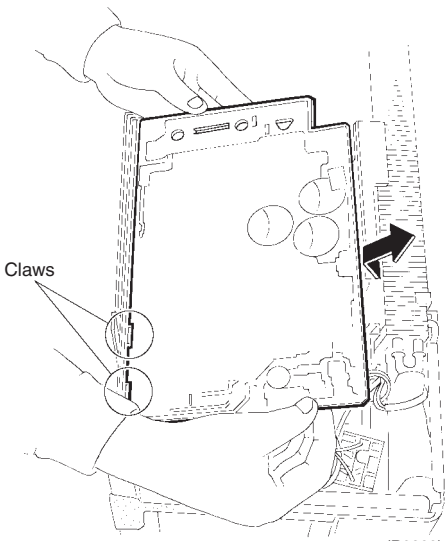
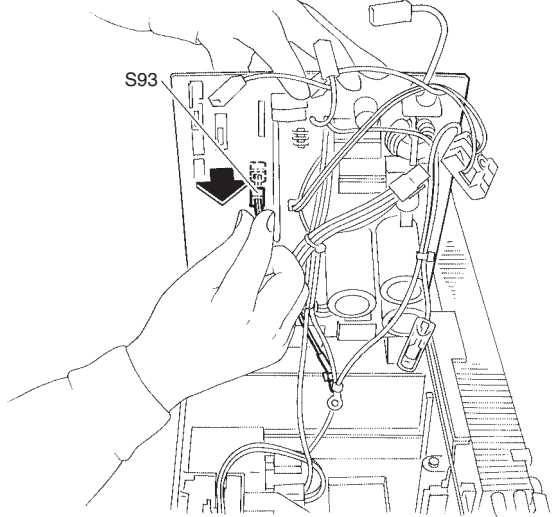
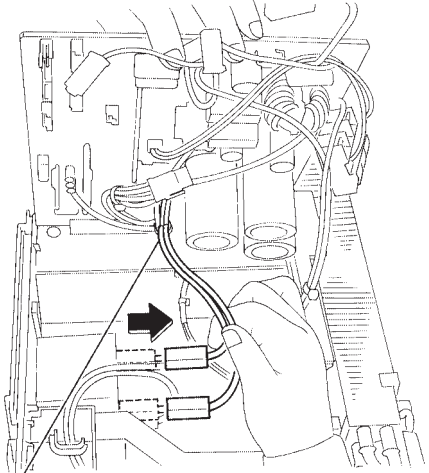
Step	Procedure	Procedure	Points
11	Lift the PCB from the heat exchanger side, and release from the two claws.	 <p style="text-align: right;">(R2899)</p>	<ul style="list-style-type: none"> ■ Mind that not to break the PCB with excessive stress because it sticks fast to the radiator fin. ■ Be sure to use silicon when reassembling. ■ Silicon: parts no.1172698
12	Disconnect the connector for fin thermistor (S93).	 <p style="text-align: right;">(R2900)</p>	
13	Disconnect the two SH condenser lead wires.	 <p style="text-align: right;">(R2901)</p>	

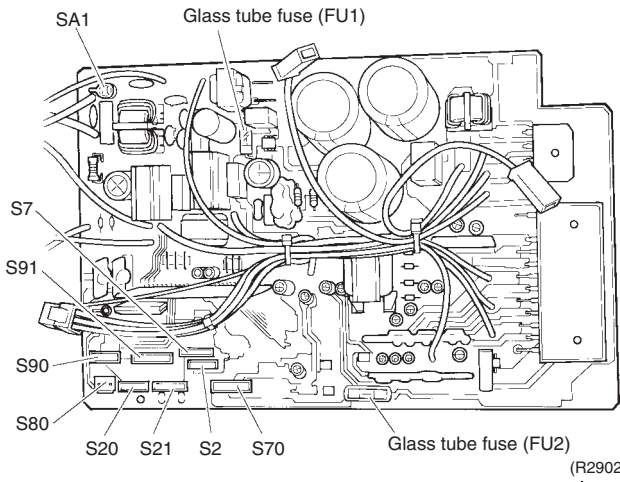
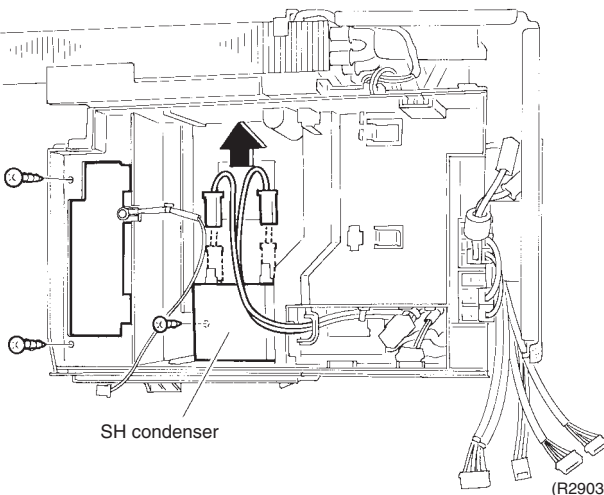
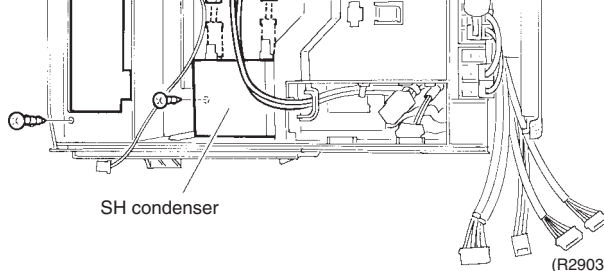
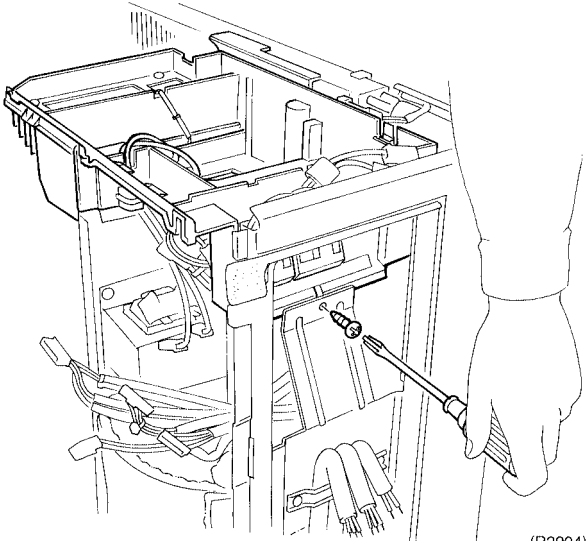
Step	Procedure	Points
14	<p>The illustration shows the layout of the PCB (parts side).</p> 	
15	<p>Loosen the two screws of the radiator fin.</p> 	
16	<p>Disconnect the reactor lead wires and remove the SH condenser.</p> 	
17	<p>Remove the screw of the electrical box.</p> 	

1.3 Removal of the Electrical Box

Procedure



Warning

Be sure to wait 10 minutes or more after turning off all power supplies before disassembling work.

Step	Procedure	Points
<p>■ Remove the top panel and the front panel.</p>	<p>(R2905)</p>	
<p>1. Remove the electrical box.</p>		
<p>1 Disconnect the connection wirings for each room.</p>		
<p>2 Release the outdoor air temperature thermistor from the holder.</p>	<p>(R2906)</p>	
<p>3 Loosen the four screws and remove the electrical box cover.</p>	<p>(R2907)</p>	<p>■ As for the fan motor lead wire, refer to the removal procedure of PCB.</p>

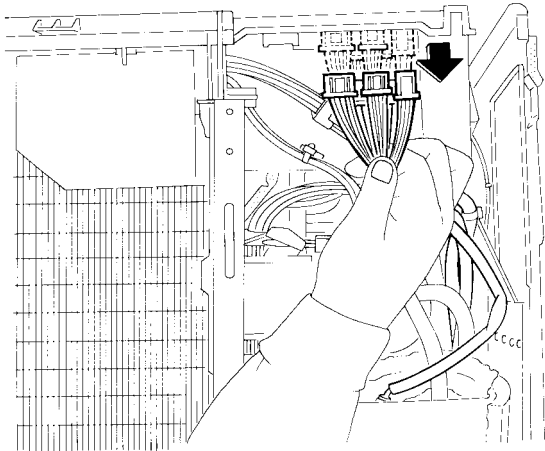
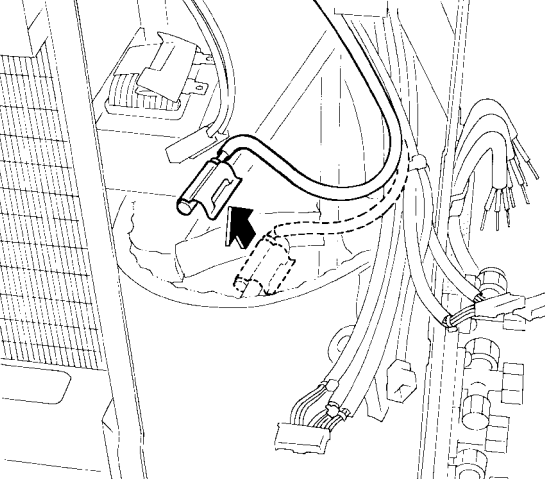
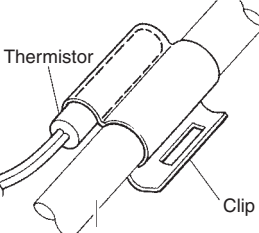
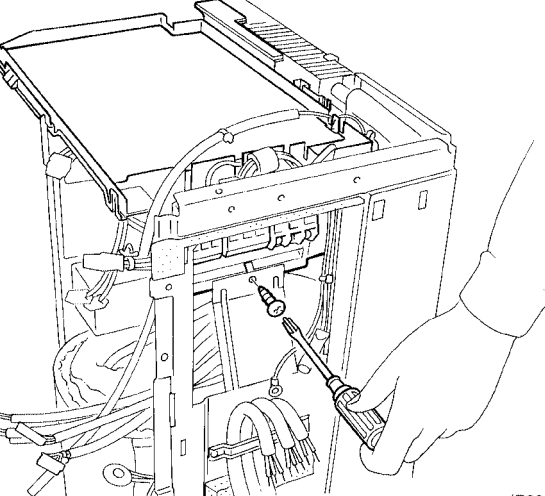
Step	Procedure	Procedure	Points
4	Disconnect all the connectors.	 <p>(R2908)</p>	<ul style="list-style-type: none"> ■ As for the connectors, refer to the removal procedure of PCB.
5	Disconnect the discharge pipe thermistor.	 <p>(R2909)</p>	<ul style="list-style-type: none"> ■ True up the tips of the thermistor and the clip. ■ Mind that not to lose the clip for the discharge pipe thermistor.  <p>(R2910)</p>
6	Loosen the screw of the electrical box.	 <p>(R2911)</p>	

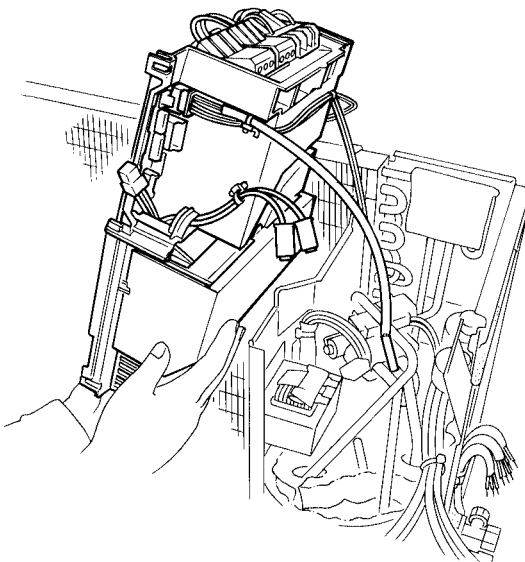
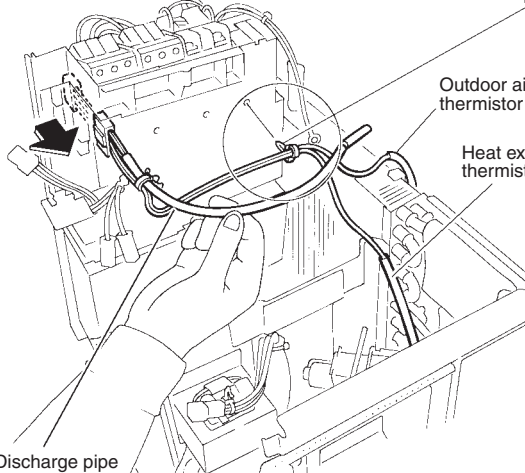
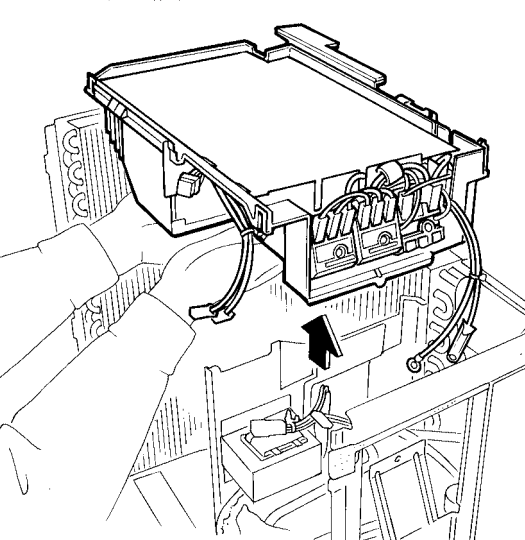
Step	Procedure	Procedure	Points
7	Lift the electrical box up.	 <p>(R2912)</p>	
8	Release the wire clamp from the back side of the electrical box.	 <p>(R2913)</p>	
9	Remove the electrical box.	 <p>(R2914)</p>	

1.4 Removal of the Sound Blanket

Procedure



Warning

Be sure to wait 10 minutes or more after turning off all power supplies before disassembling work.

Step	Procedure	Procedure	Points
1	Loosen the five screws of the right side panel.	<p>(R2915)</p>	
2	Release the clamp of the compressor lead wire from the partition plate.	<p>(R2916)</p> <p>Clamp</p> <p>(R2917)</p> <p>Clamp</p> <p>(R2918)</p>	

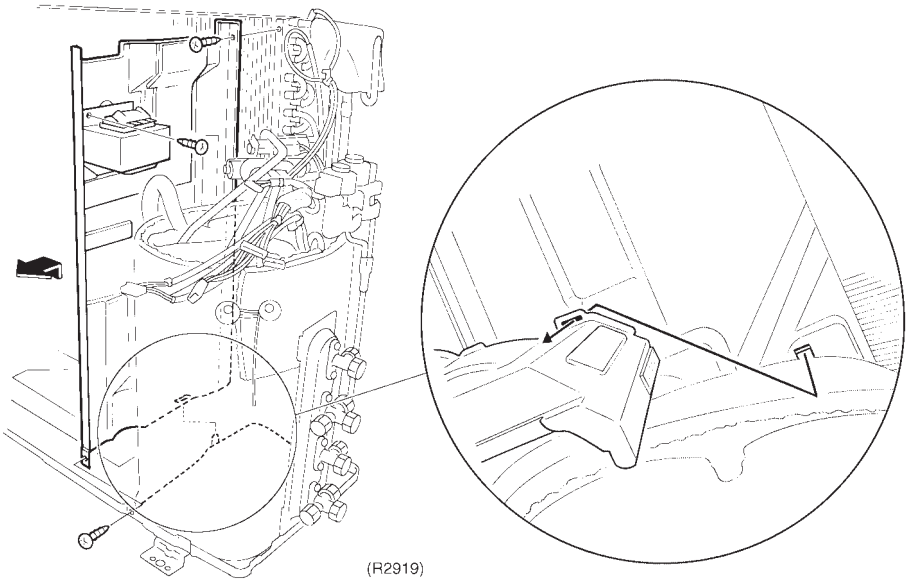
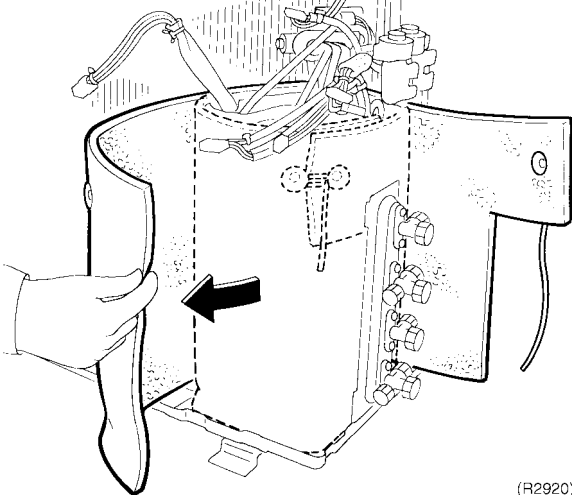
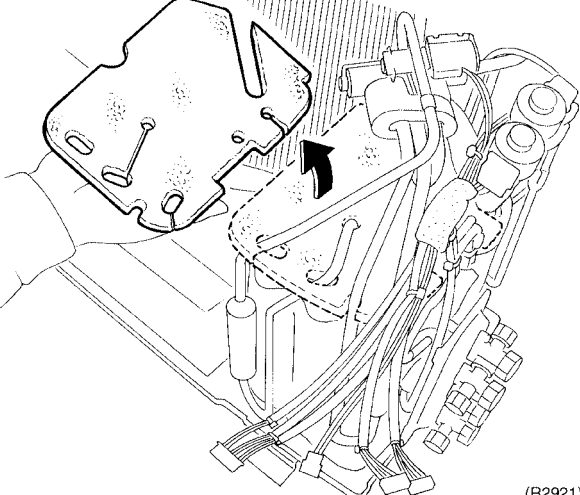
Step	Procedure	Points
<p>3 The partition plate is fixed to the bottom frame with a claw. Lift it and pull out towards you.</p> <p>4 Loosen two screws of the partition plate.</p>	 <p>(R2919)</p>	<ul style="list-style-type: none"> Fit the claw of the partition plate to the bottom frame when reassembling.
<p>5 Untie the fixing string and remove the sound blanket (side-outer).</p>	 <p>(R2920)</p>	<ul style="list-style-type: none"> Loosen the screw to remove the reactor from the partition plate.
<p>6 Remove the sound blanket (top).</p>	 <p>(R2921)</p>	<ul style="list-style-type: none"> Since the piping ports on the sound blanket are torn easily, remove the blanket carefully.

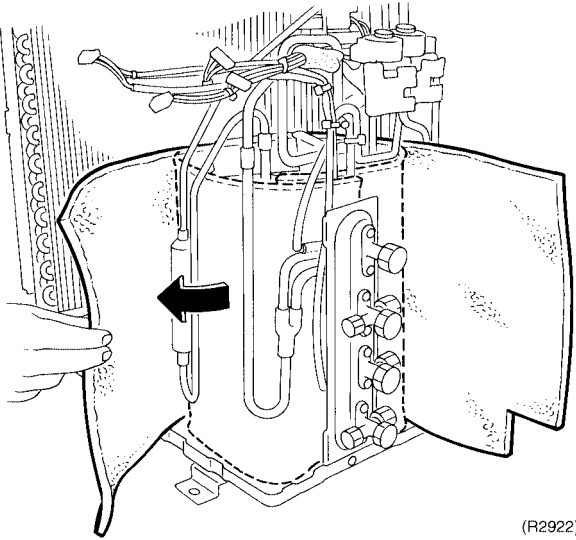
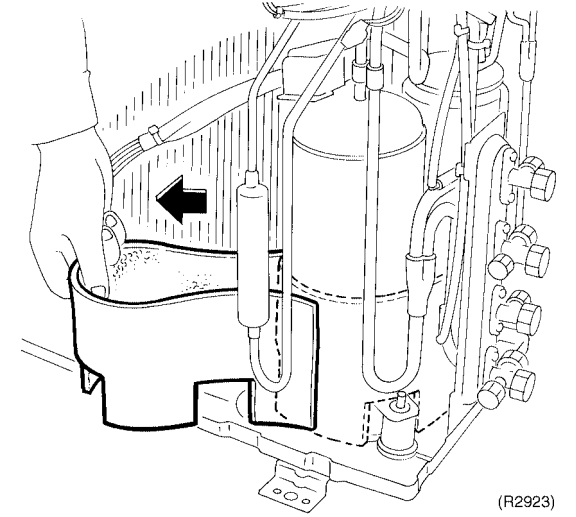
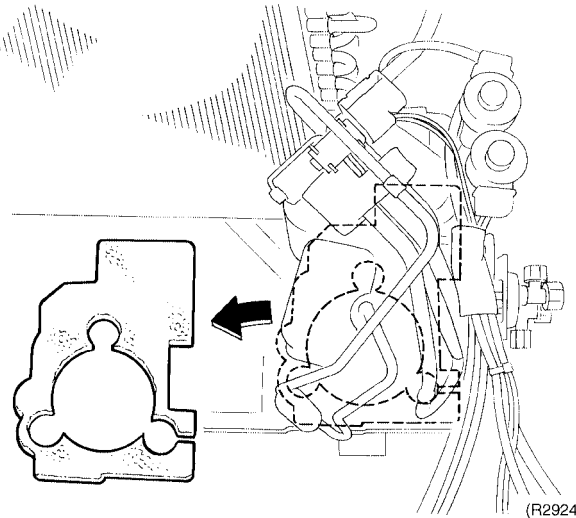
Step	Procedure	Points
7	Remove the sound blanket (side-inner A).	
	 <p>(R2922)</p>	
8	Remove the sound blanket (side-inner B).	
	 <p>(R2923)</p>	
9	Remove the sound blanket (bottom).	
	 <p>(R2924)</p>	

1.5 Removal of the Thermistor

Procedure



Warning

Be sure to wait 10 minutes or more after turning off all power supplies before disassembling work.

Step	Procedure	Points
1	Disconnect the discharge pipe thermistor.	(R2925)
2	Disconnect the gas and liquid pipe thermistor.	<ul style="list-style-type: none"> ■ Mind that not to lose the clips for thermistors.
3	Disconnect the heat exchanger thermistor.	(R2928)

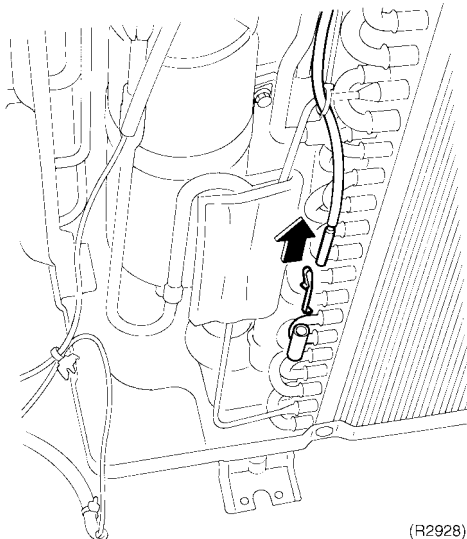
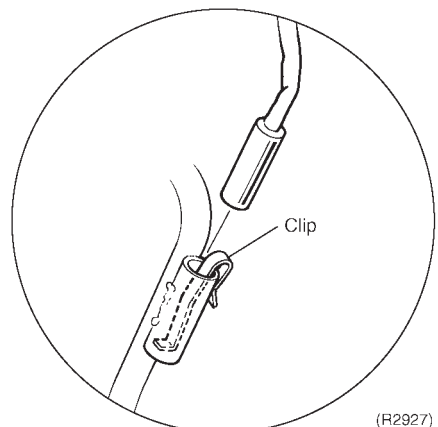
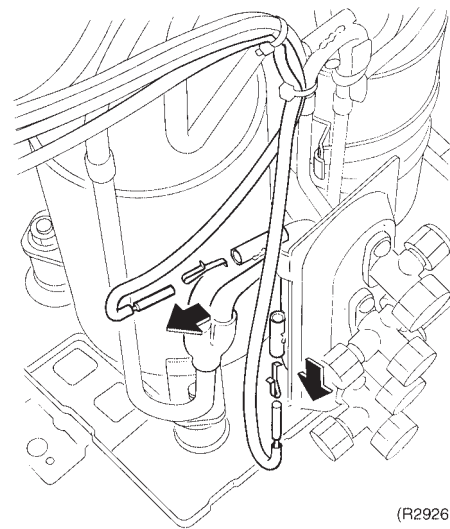
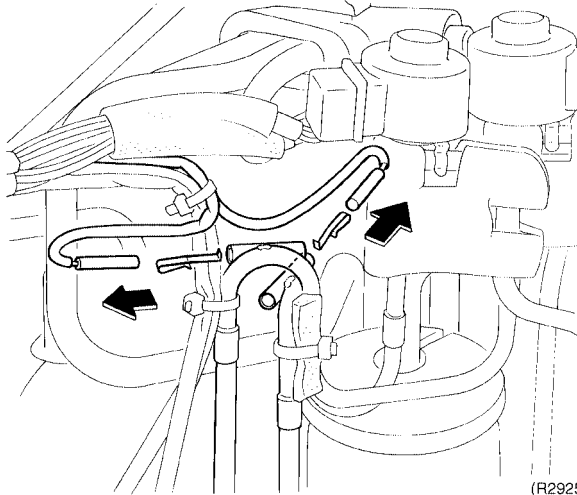

1.6 Removal of the Four Way Valve

Procedure



Warning

Be sure to wait 10 minutes or more after turning off all power supplies before disassembling work.

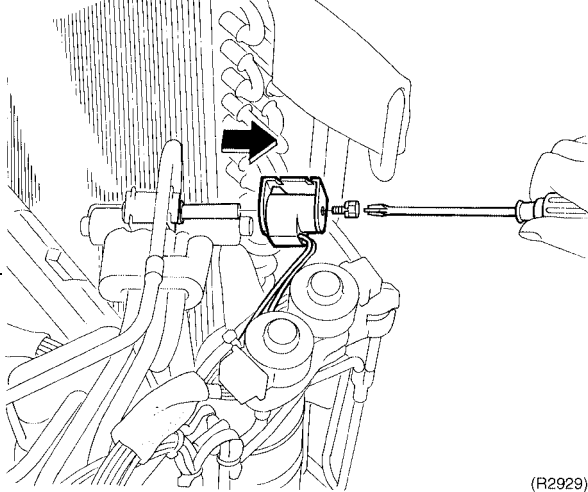
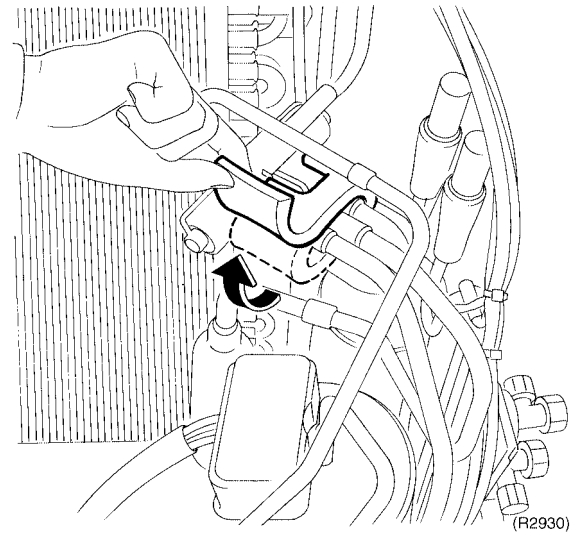
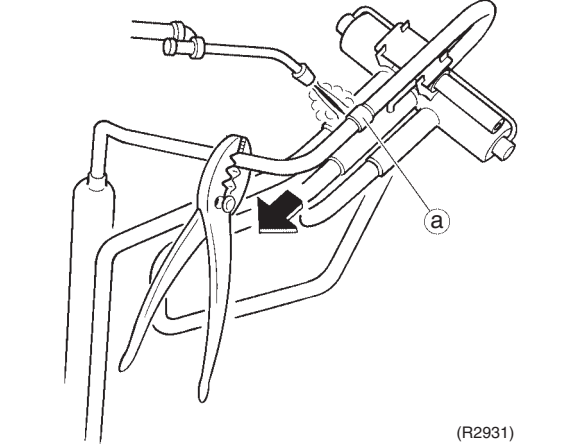
Step	Procedure	Points
1.	Remove the peripheries.	
	Remove the followings so as not to be burned by a gas brazing machine. <ul style="list-style-type: none"> ■ Four way valve coil ■ Electronic expansion valve coil ■ Putty 	
1	Loosen the screw and remove the four way valve coil.	 <p style="text-align: right;">(R2929)</p>
2	Remove the sheet of putty.	 <p style="text-align: right;">(R2930)</p>
	<ul style="list-style-type: none"> ■ Before working, make sure that the refrigerant is empty in the circuit. 	<ul style="list-style-type: none"> ■ Provide a protective sheet or a steel plate so that the brazing flame cannot influence peripheries.
3	Heat up four brazed parts of the four way valve and disconnect in (a)(b)(c)(d) order. (See the next page also.)	 <p style="text-align: right;">(R2931)</p>
4	Withdraw the piping side by pliers.	<ul style="list-style-type: none"> ■ Be careful so as not to break pipes by pressing it excessively by pliers when withdrawing it.

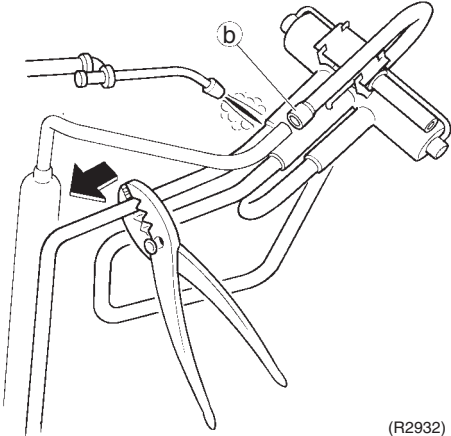
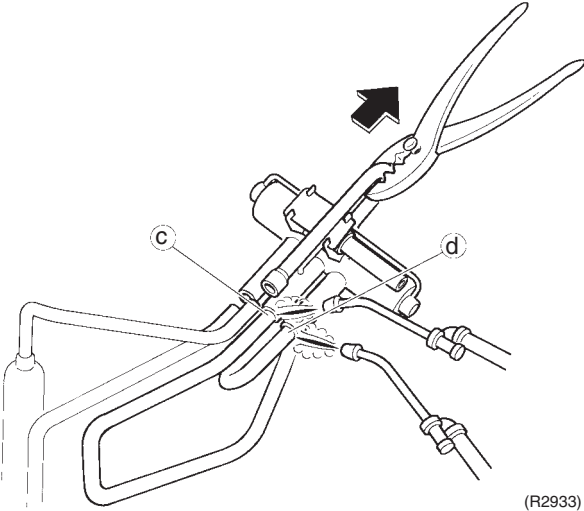
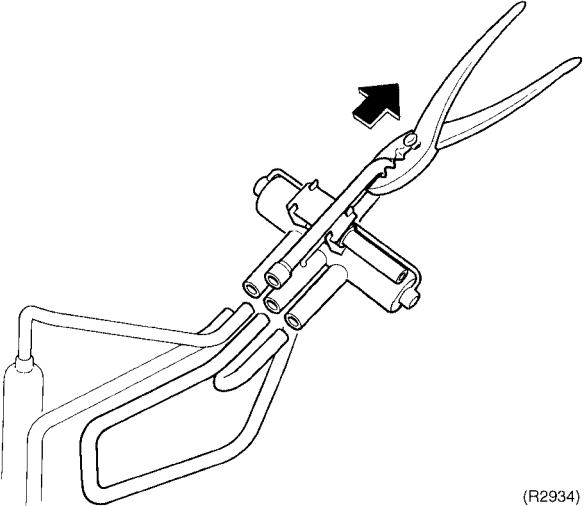
Step	Procedure	Points
	 <p>(R2932)</p>  <p>(R2933)</p>  <p>(R2934)</p>	<p>Warning ⚠️ Ventilate when refrigerant leaks during the work. (If refrigerant contacts fire, it will cause to arise toxic gas.)</p> <p>Caution ⚠️ Be careful about the four way valve, pipes and so on, which were heated up by a gas brazing machine, so as not to get burnt your hands.</p> <p>Cautions for restoration</p> <ol style="list-style-type: none"> 1. Restore the piping by non-oxidation brazing. Braze it quickly when no nitrogen gas can be used. 2. It is required to prevent the carbonization of the oil inside the four way valve and the deterioration of the gaskets affected by heat. For the sake of this, wrap the four way valve with wet cloth and provide water so that the cloth will not be dried and avoid excessive heating. (Keep below 120 °C) <p><u>In case of the difficulty with gas brazing machine</u></p> <ol style="list-style-type: none"> 1. Disconnect the brazed part where is easy to disconnect and restore. 2. Cut pipes on the main unit by a miniature copper tube cutter in order to make it easy to disconnect. <p>Note ⓘ Do not use a metal saw for cutting pipes by all means because the sawdust come into the circuit.</p>



1.7 Removal of the Electronic Expansion Valve

Procedure

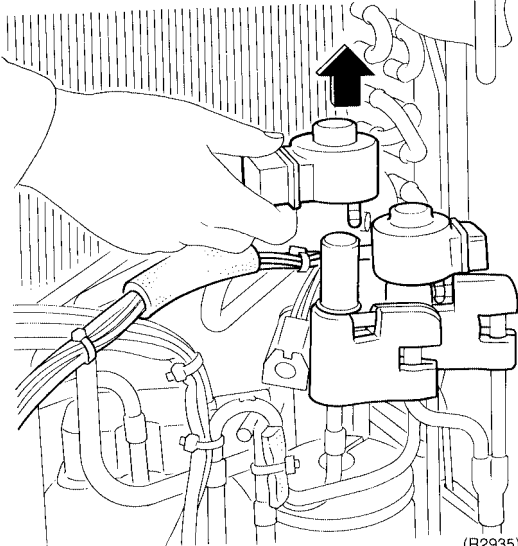

Warning

Be sure to wait 10 minutes or more after turning off all power supplies before disassembling work.

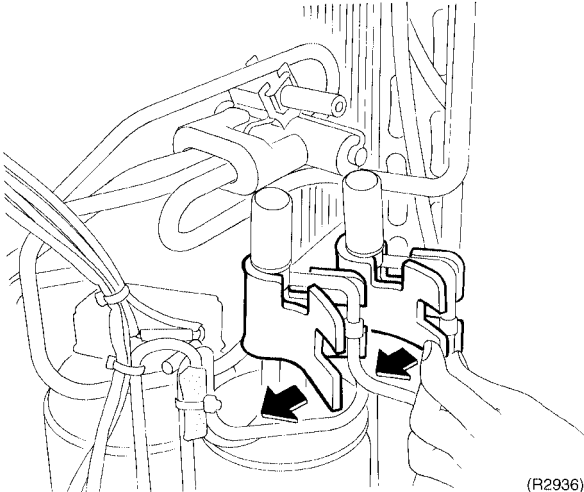
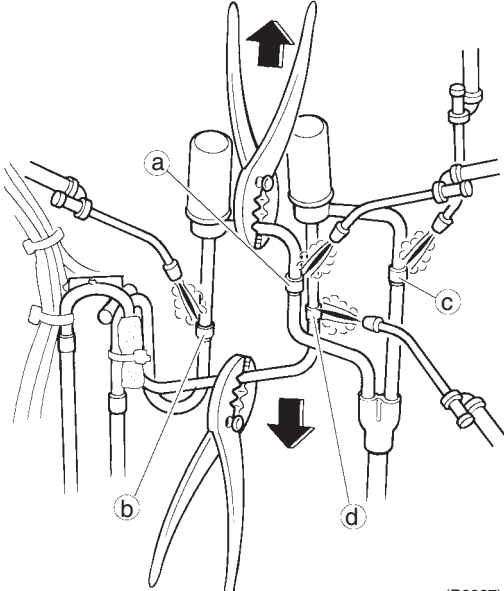
Step	Procedure	Procedure	Points
1	Remove the electronic expansion valve coil.	 <p style="text-align: right;">(R2935)</p>	<ul style="list-style-type: none"> ■ Fit the claw of the electronic expansion valve coil as it was when reassembling. <p> Warning Ventilate when refrigerant leaks during the work. (If refrigerant contacts fire, it will cause to arise toxic gas.)</p> <p> Caution Be careful about the pipes which were heated up by a gas brazing machine, so as not to get burnt your hands.</p>
2	Remove the sheets of putty.	 <p style="text-align: right;">(R2936)</p>	<ul style="list-style-type: none"> ■ Be careful so as not to burn the heat exchanger fin. ■ Remove the putty if the brazing flame burn it.
3	Heat up the four brazed parts and disconnect in (a)(b)(c)(d) order.	 <p style="text-align: right;">(R2937)</p>	<p>Caution for restoration Wrap the electronic expansion valve with wet cloth and provide water so that the cloth will not be dried and avoid excessive heating.</p>

1.8 Removal of the Compressor

Procedure



Warning

Be sure to wait 10 minutes or more after turning off all power supplies before disassembling work.

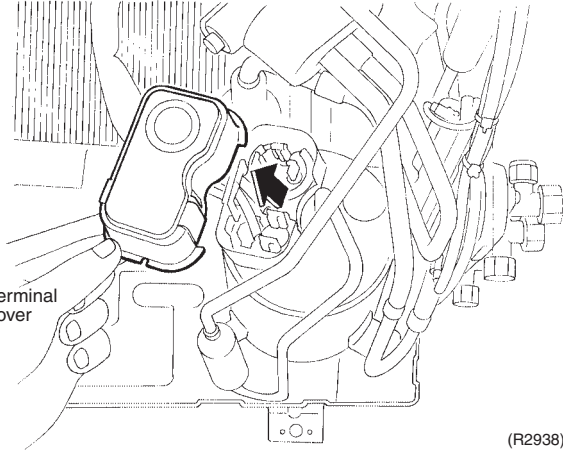
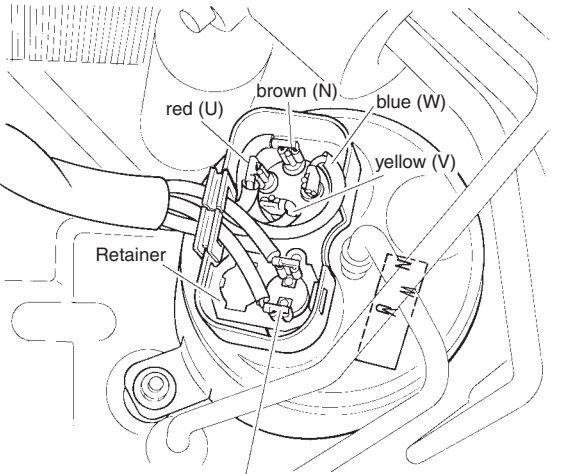
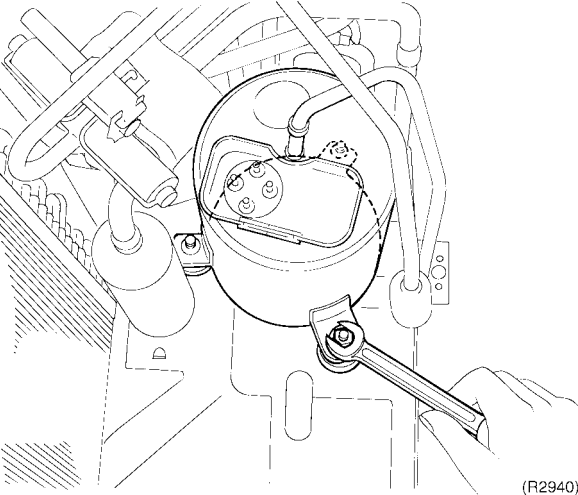
Step	Procedure	Procedure	Points
<p>1</p> <p>Remove the terminal cover.</p>		 <p>Terminal cover</p> <p>(R2938)</p>  <p>red (U) brown (N) blue (W) yellow (V)</p> <p>Retainer</p> <p>Overload protection device</p> <p>(R2939)</p>	<p>■ Be careful so as not to burn the compressor terminals or the name plate.</p> <p>Make a note.</p>
<p>2</p> <p>Unscrew the nut of the compressor.</p>		 <p>(R2940)</p>	

Step	Procedure	Points
3	<ul style="list-style-type: none"> ■ Before working, make sure that the refrigerant is empty in the circuit. ■ Be sure to apply nitrogen replacement when heating up the brazed part. <p>Heat up the brazed part of the discharge side and disconnect.</p>	<p>Warning Since it may happen that refrigeration oil in the compressor will catch fire, prepare wet cloth so as to extinguish fire immediately.</p> <p>Warning Ventilate when refrigerant leaks during the work. (If refrigerant contacts fire, it will cause to arise toxic gas.)</p> <p>Caution Be careful about the pipes which were heated up by a gas brazing machine, so as not to get burnt your hands.</p>
4	<p>Heat up the brazed part of the suction side and disconnect.</p>	
5	<p>Lift the compressor up and remove it.</p>	

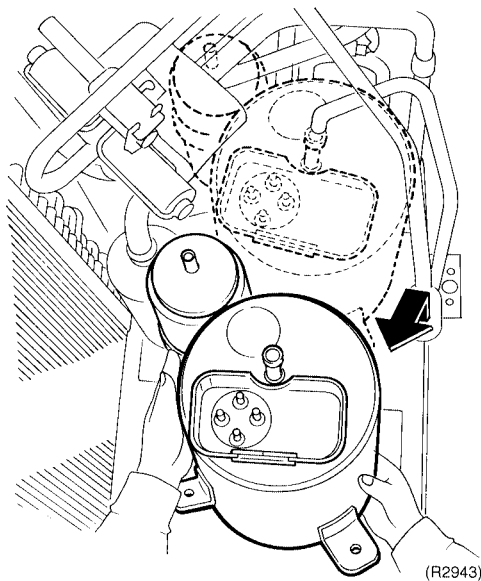
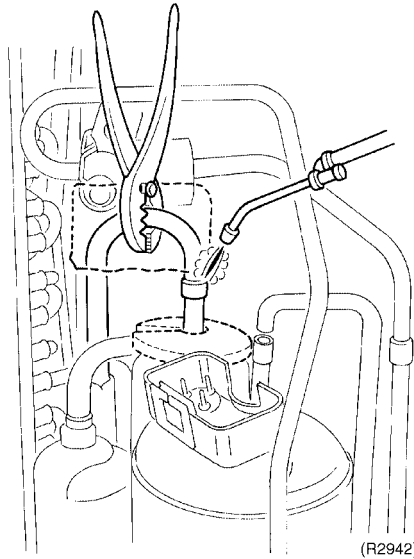
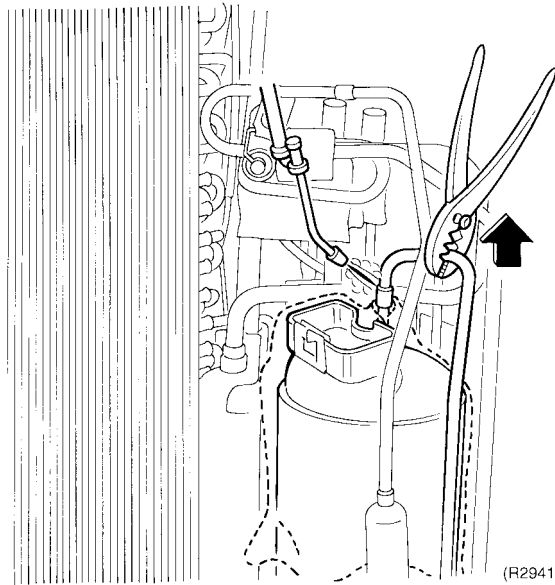

Part 8 Others

1. Others	170
1.1 Test Run from the Remote Controller	170
1.2 Jumper Settings	171

1. Others

1.1 Test Run from the Remote Controller

For Heat pump

In cooling mode, select the lowest programmable temperature; in heating mode, select the highest programmable temperature.

- Trial operation may be disabled in either mode depending on the room temperature.
- After trial operation is complete, set the temperature to a normal level.
(26°C to 28°C in cooling mode, 20°C to 24°C in heating mode)
- For protection, the system disables restart operation for 3 minutes after it is turned off.

For Cooling Only

Select the lowest programmable temperature.

- Trial operation in cooling mode may be disabled depending on the room temperature.
Use the remote control for trial operation as described below.
- After trial operation is complete, set the temperature to a normal level (26°C to 28°C).
- For protection, the machine disables restart operation for 3 minutes after it is turned off.

Trial Operation and Testing

1. Measure the supply voltage and make sure that it falls in the specified range.
 2. Trial operation should be carried out in either cooling or heating mode.
 3. Carry out the test operation in accordance with the Operation Manual to ensure that all functions and parts, such as louver movement, are working properly.
- The air conditioner requires a small amount of power in its standby mode. If the system is not to be used for some time after installation, shut off the circuit breaker to eliminate unnecessary power consumption.
 - If the circuit breaker trips to shut off the power to the air conditioner, the system will restore the original operation mode when the circuit breaker is opened again.

Trial operation from Remote Controller

- (1) Press ON/OFF button to turn on the system.
- (2) Simultaneously press center of TEMP button and MODE buttons.
- (3) Press MODE button twice.
(“T” will appear on the display to indicate that Trial Operation mode is selected.)
- (4) Trial run mode terminates in approx. 30 minutes and switches into normal mode. To quit a trial operation, press ON/OFF button.

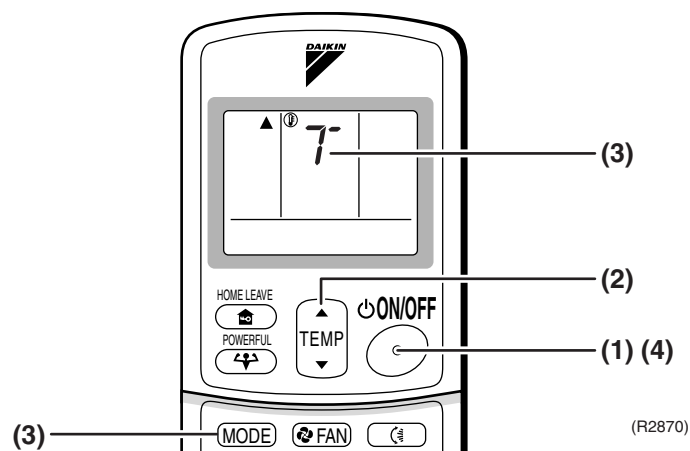

1.2 Jumper Settings

1.2.1 When Two Units are Installed in One Room

When two indoor units are installed in one room, the two wireless remote controllers can be set for different addresses.

How to set the different addresses

■ Control PCB of the indoor unit

- (1) Remove the front panel.
- (2) Remove the sensor parts cover (2-screws), then remove the electric parts box (1-screw).
- (3) Slide the metallic cover to remove it. (4-claws on the electric parts box)
- (4) Cut the jumper JA on PCB.

■ Wireless remote controller

- (1) Slide the front cover and take it off.
- (2) Cut the address jumper J4.

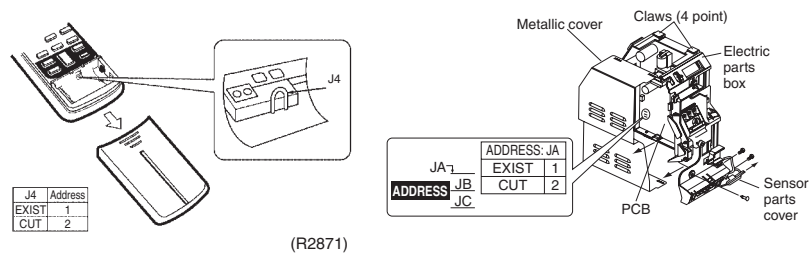

1.2.2 Jumper Setting

Jumper (On indoor control PCB)	Function	When connected (factory set)	When cut
JC	Power failure recovery function	Auto-restart	Unit does not resume operation after recovering from a power failure. Timer ON-OFF settings are cleared.
JB	Fan speed setting when compressor is OFF on thermostat.	Fan speed setting ; Remote controller setting	Fan rpm is set to "0" <Fan stop>

1.2.3 Adjusting the Angle of the Intelligent Eye Sensor

- Once installation of the indoor unit is complete, adjust the angle of the Intelligent-eye sensor to ensure the detection area properly covers the room.
(Adjustable angle : 15° to right and left of center)

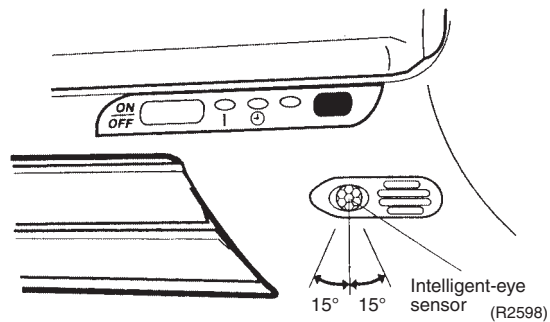

- Gently push and slide the sensor to adjust the angle. Aim so that the sensor is pointing to the center of the room, or to the part of the room that is most frequently used.

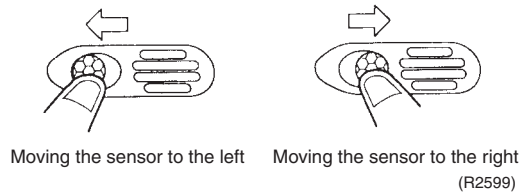

- After adjusting the angle, gently wipe the sensor with a clean cloth, being careful not to scratch the sensor.



Caution

- Do not hit or violently push the Intelligent-eye sensor. This can lead to damage and malfunction.
- Do not place large objects near the sensor. Also keep heating units or humidifiers outside the sensor's detection area.

Part 9 Appendix

1. Piping Diagrams.....	174
1.1 Indoor Units.....	174
1.2 Outdoor Units.....	176
2. Wiring Diagrams.....	177
2.1 Indoor Units.....	177
2.2 Outdoor Units.....	179

1. Piping Diagrams

1.1 Indoor Units

1.1.1 Wall Mounted Type

FTKS20CVMB(9), FTKS25/35CVMB(9)(8),
ATKS20/25/35CVMB(9), ATKS20/25/35DVMB

FTXS20CVMB(9), FTXS25/35CVMB(9)(8),
ATXS20/25/35CVMB(9), ATXS20/25/35DVMB

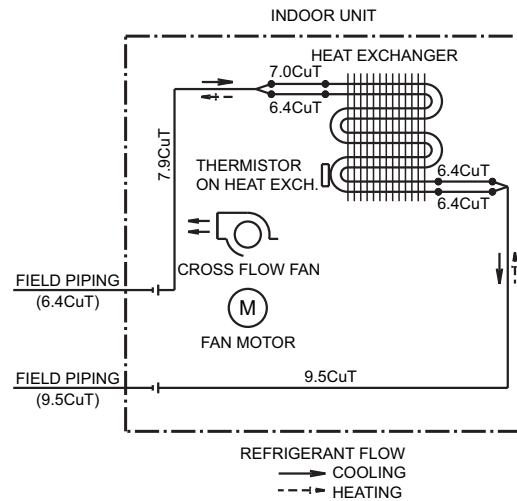
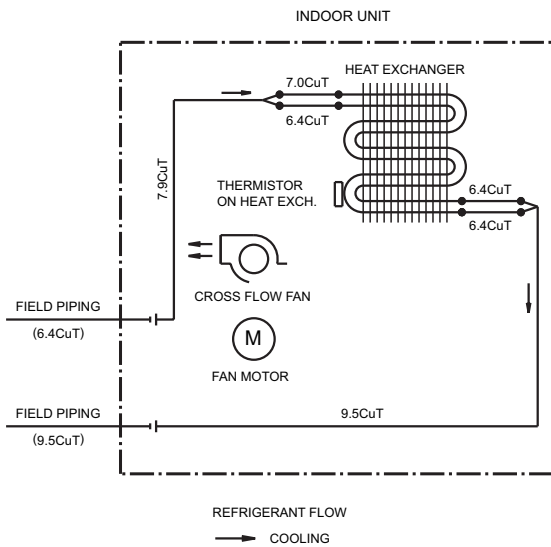

C : 4D033698D

4D049319

1.1.2 Duct Connected Type

CDKS25/35CVMB, CDXS25/35CVMB

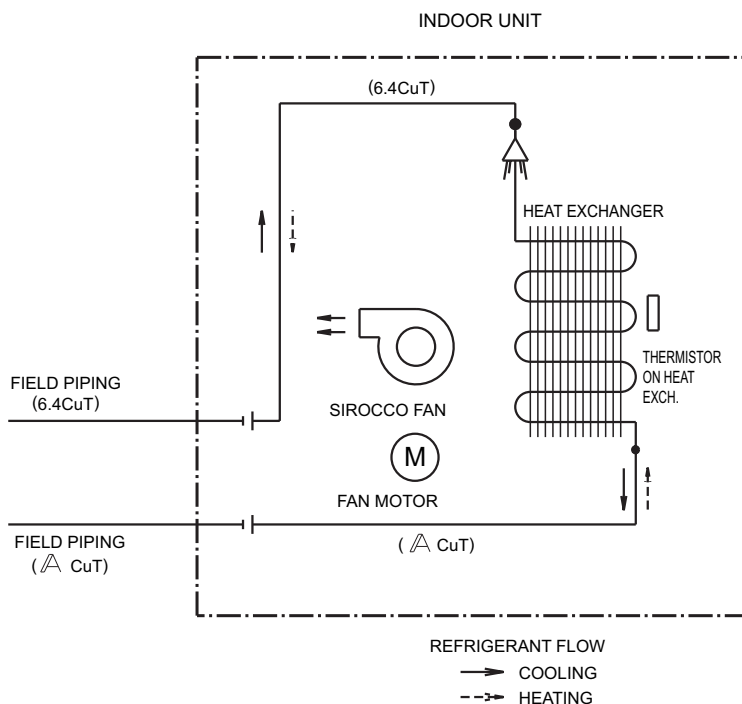

	Δ
CDXS25CVMB	9.5
CDKS25CVMB	
CDXS35CVMB	
CDKS35CVMB	
CDXS25CVMA	
CDXS35CVMA	
FDXS25CVMB	
FDXS35CVMB	
FDKS25CVMB	
FDKS35CVMB	12.7
CDXS50CVMB	
CDKS50CVMB	
CDXS60CVMB	
CDKS60CVMB	
CDXS50CVMA	
CDXS60CVMA	

4D045449B

1.1.3 Floor / Ceiling Suspended Dual Type

FLKS25/35BVMB

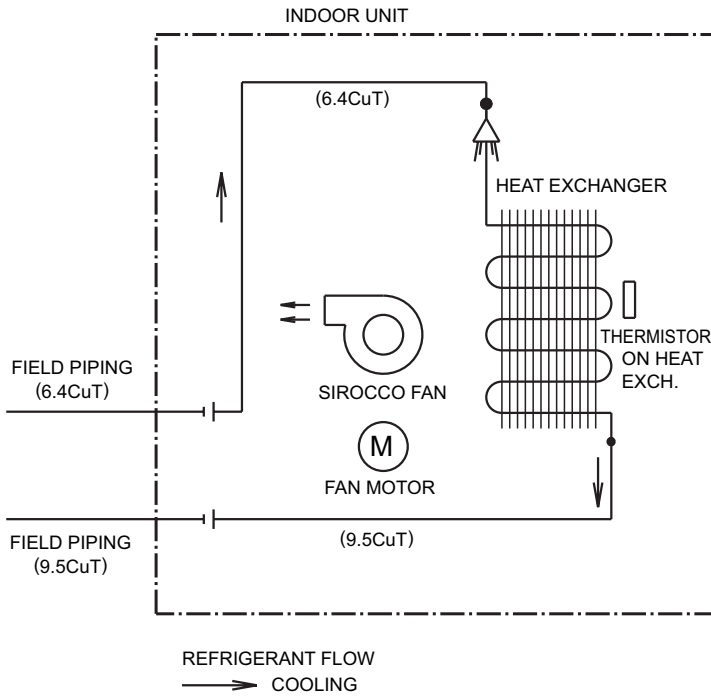

4D034012D

FLXS25/35BVMB

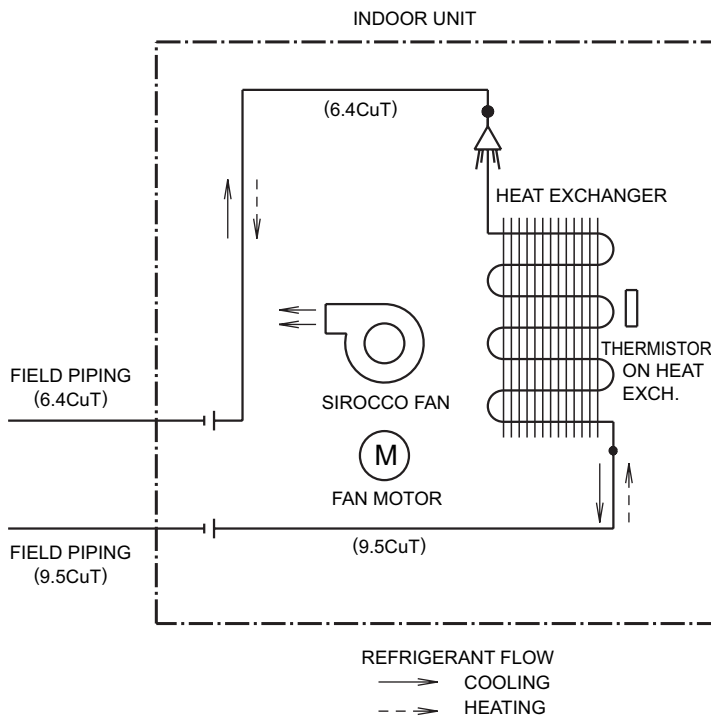

4D048722

1.2 Outdoor Units

2MKS40BVMB, 2AMKS40BVMB

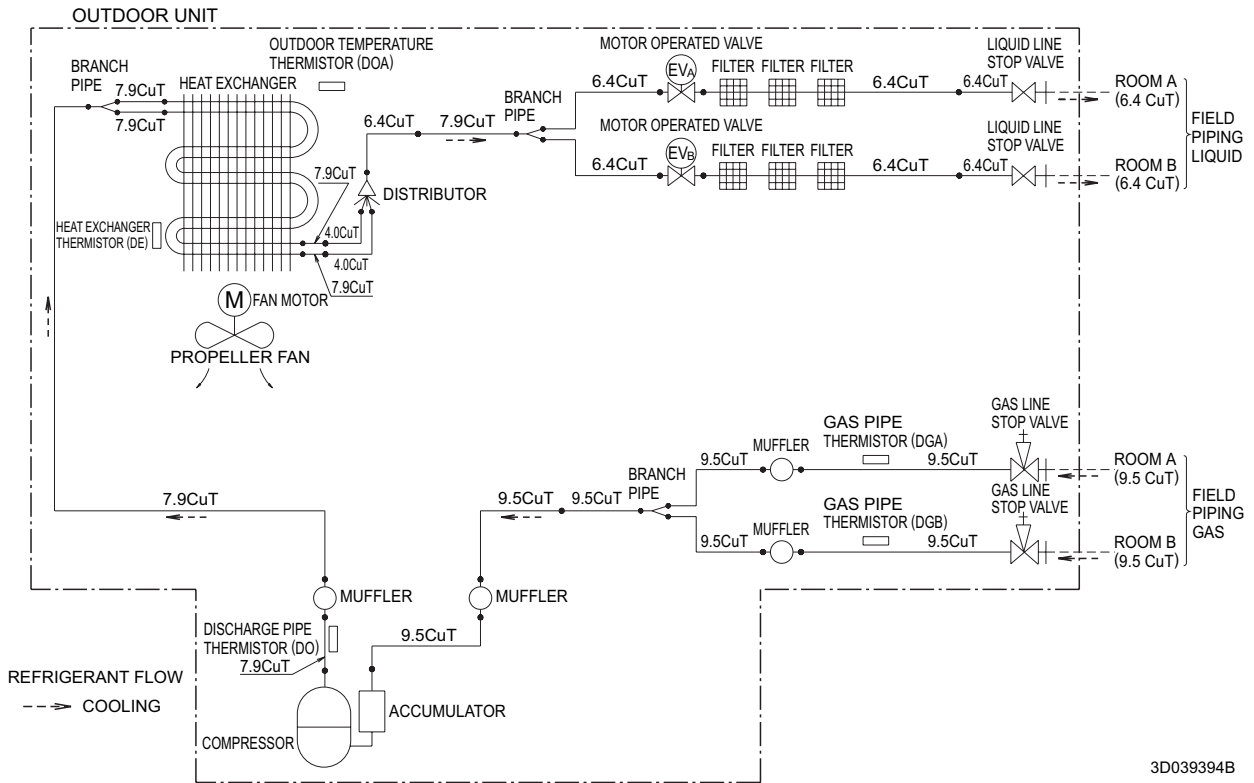

2MXS40BVMB, 2AMXS40BVMB

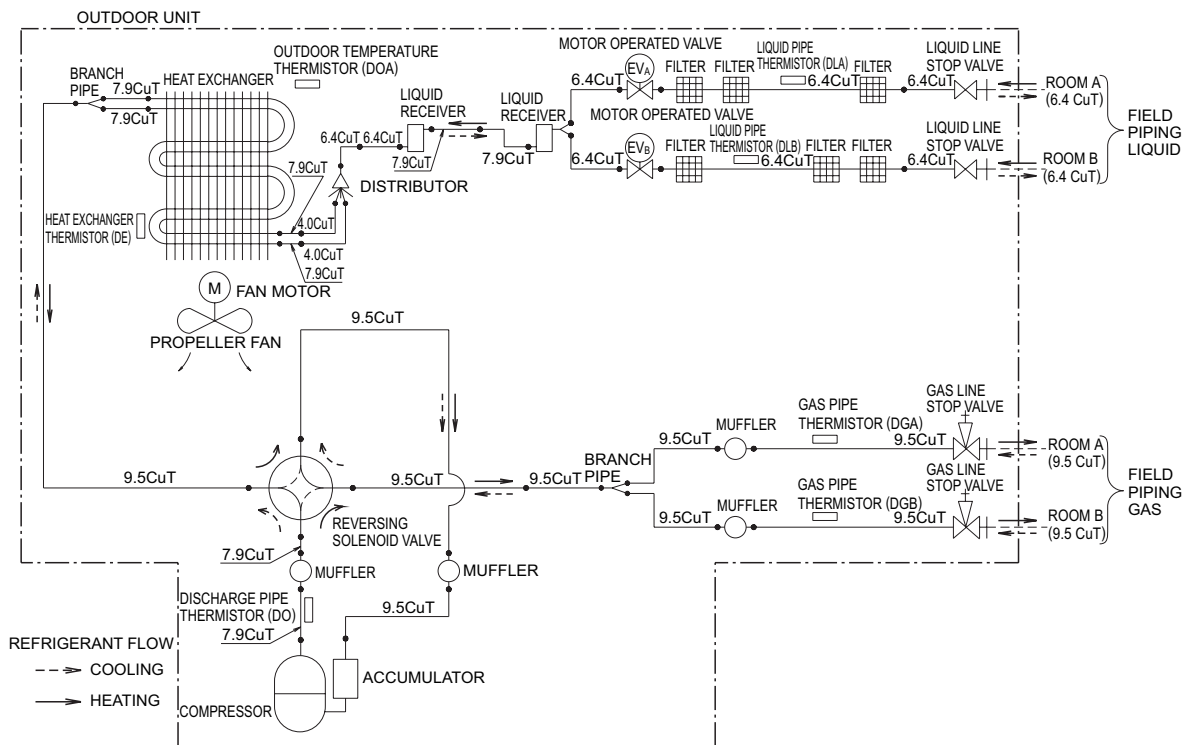

2. Wiring Diagrams

2.1 Indoor Units

2.1.1 Wall Mounted Type

FTKS20CVMB(9), FTKS25/35CVMB(9)(8), ATKS20/25/35CVMB(9), ATKS20/25/35DVMB
 FTXS20CVMB(9), FTXS25/35CVMB(9)(8), ATXS20/25/35CVMB(9), ATXS20/25/35DVMB

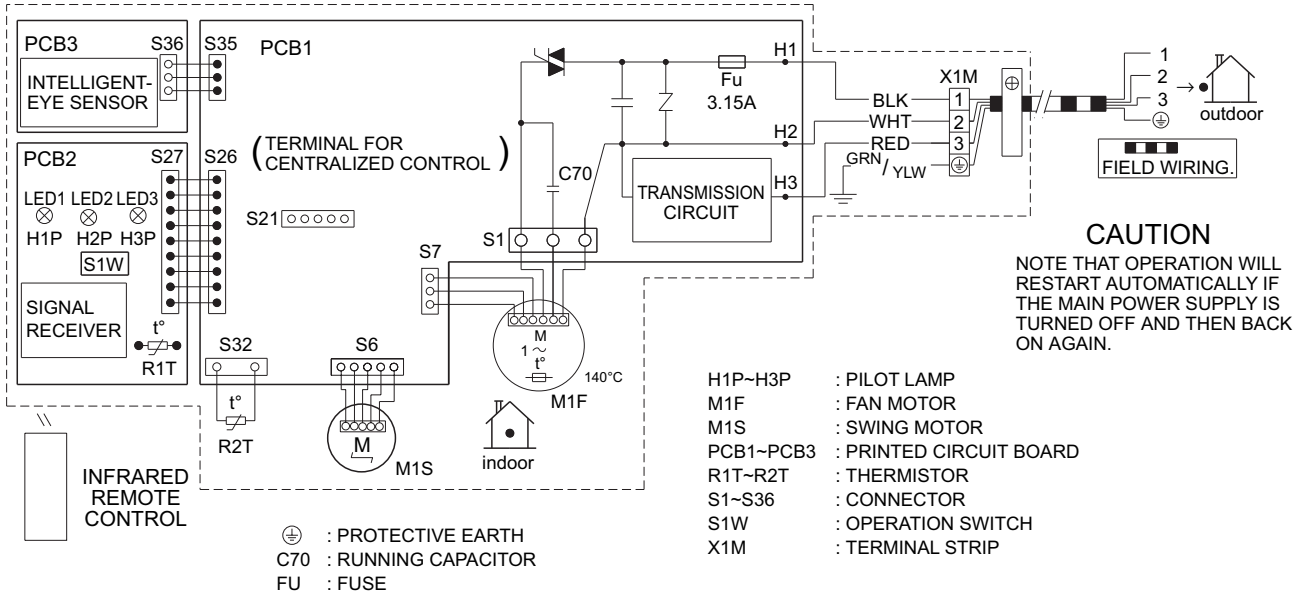

3D033599E

2.1.2 Duct Connected Type

CDKS25/35CVMB, CDXS25/35CVMB

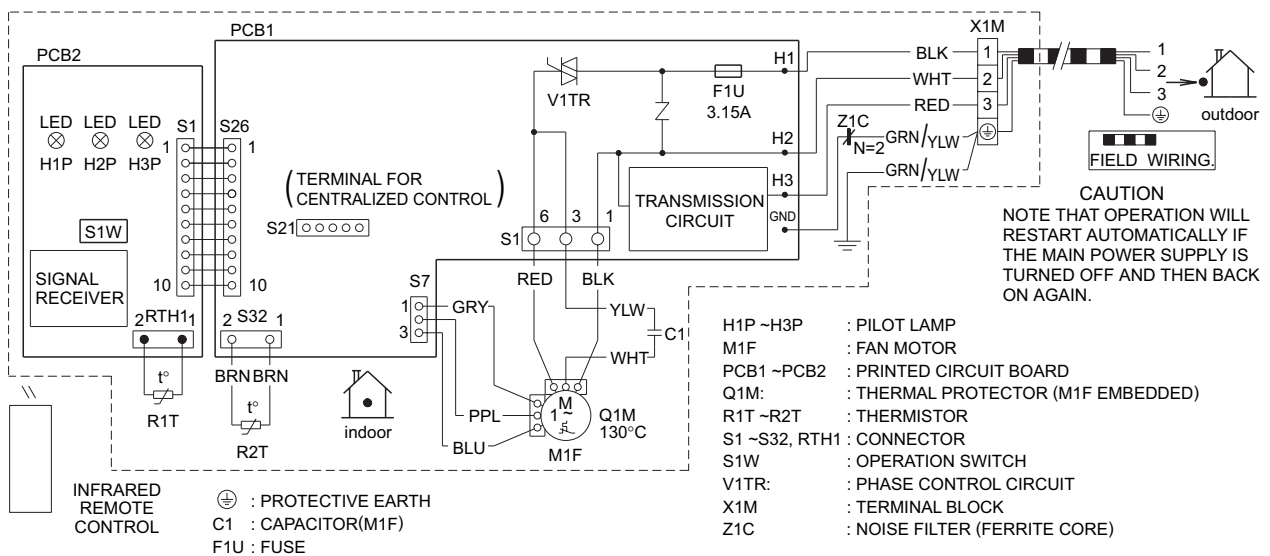

3D045012C

2.1.3 Floor / Ceiling Suspended Dual Type

FLKS25/35BVMB, FLXS25/35BVMB

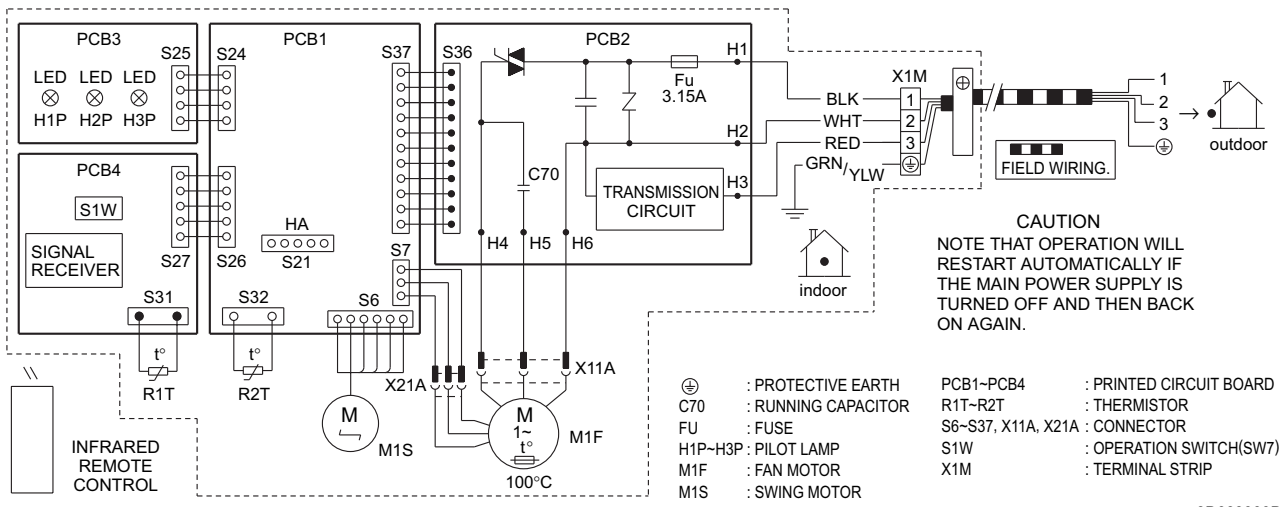

3D033909D

2.2 Outdoor Units

2MKS40BVMB, 2AMKS40BVMB

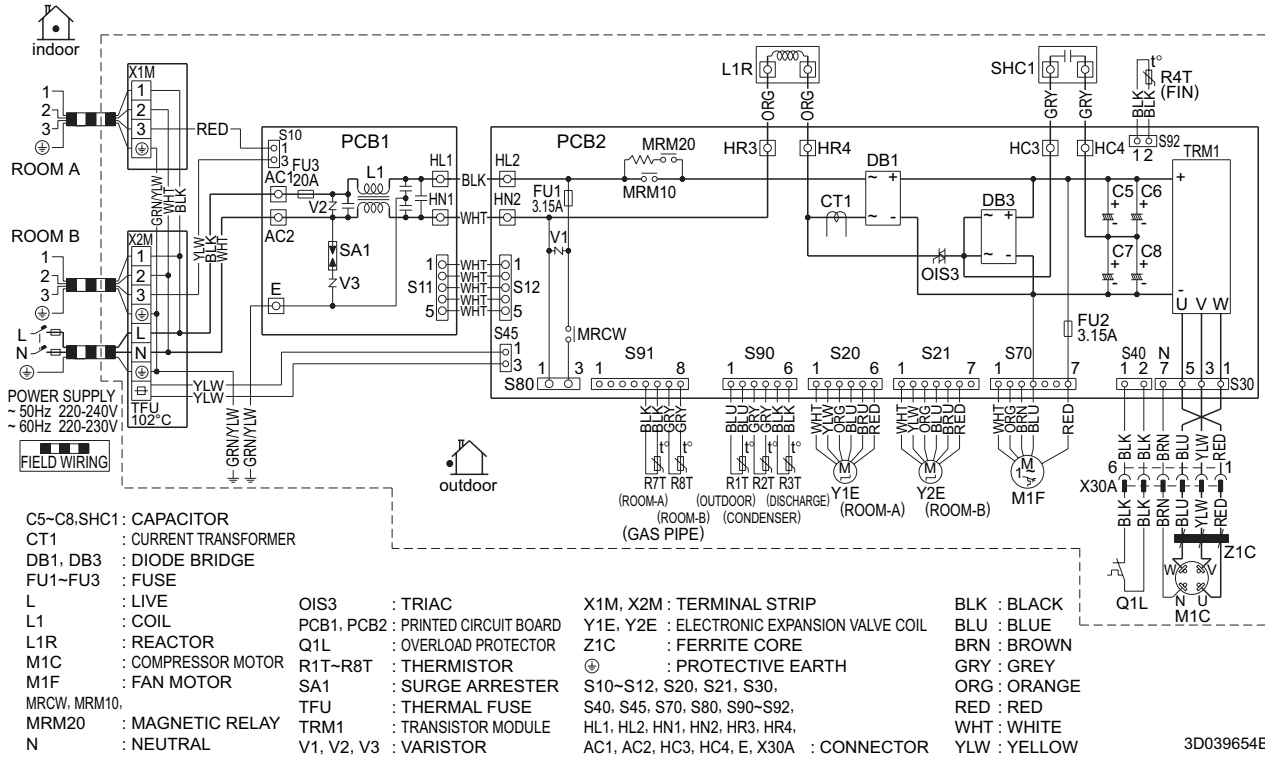

2MXS40BVMB, 2AMXS40BVMB

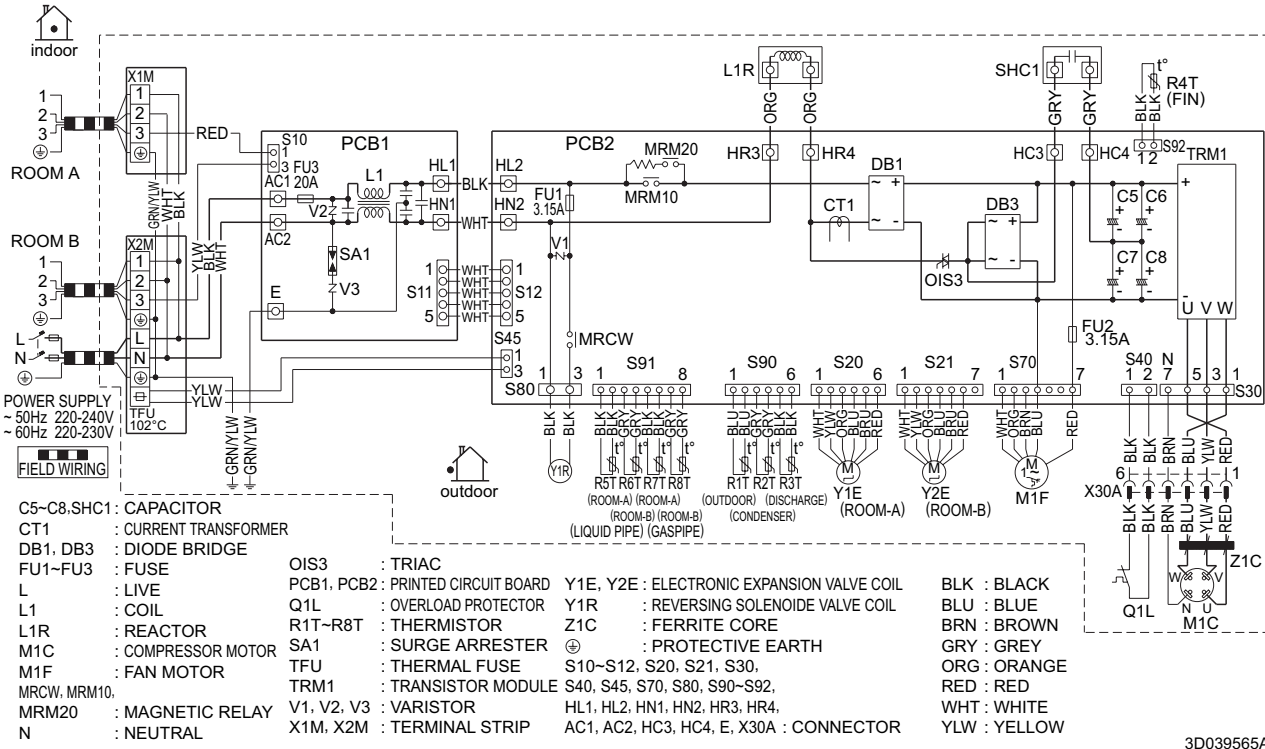

Index

Numerics

3 minutes stand-by52

A

A1103
 A5104, 108
 A6106
 AC128
 AC228
 air flow direction75
 air purifying filter43
 air purifying filter with photocatalytic
 deodorizing function43
 anti-icing function108
 anti-icing function in other rooms134
 ARC433A series99
 auto swing34
 AUTO·DRY·COOL·HEAT·FAN operation73
 automatic operation37
 auto-restart171
 auto-restart function44

C

C4107
 C9107
 capacitor voltage check141
 care and cleaning87
 check No.11141
 check No.12141
 check No.13142
 check No.14142
 check No.15143
 check No.16143
 check No.4136
 check No.5137
 check No.6138
 check No.7139
 check No.8140
 check No.9140
 compressor166
 compressor lock111
 compressor overload110
 compressor protection function52
 control PCB23, 24, 26, 29
 CT or related abnormality121

D

DB128
 DC fan lock112
 defrost control56
 diagnosis mode100
 discharge pipe59
 discharge pipe control53
 discharge pipe temperature60
 discharge pipe temperature control117

discharge pipe temperature thermistor 124
 discharge pipe thermistor 46, 48, 59, 157, 162
 discharge pressure check 140
 display PCB 23, 25, 27

E

E5 110
 E6 111
 E7 112
 E8 113
 EA 115
 electrical box 156
 electrical box temperature rise 125
 electronic expansion valve 165
 electronic expansion valve check 136
 electronic expansion valve control 57
 error codes
 A1 103
 A5 104, 108
 A6 106
 C4 107
 C9 107
 E5 110
 E6 111
 E7 112
 E8 113
 EA 115
 F3 117
 F6 118
 H6 120
 H8 121
 H9 123
 J3 123
 J6 123
 J8 123
 J9 123
 L3 125
 L4 127
 L5 129
 P4 123
 U0 131
 U2 133
 U4 135
 UA 134
 UH 108, 134
 error codes and description 102

F

F3 117
 F6 118
 fan control 55
 fan motor 146
 fan motor (AC motor) or related abnormality 106
 fan speed control for indoor units 35
 fan speed setting 171

filter PCB	28
forced operation mode	62
four way valve	163
four way valve abnormality	115
four way valve operation compensation	52
four way valve performance check	137
four way valve switching	52
freeze-up protection control	54
freeze-up protection control or high pressure control	104
frequency control	50
frequency principle	32
front panel	147
FU1	22, 24, 26
FU2	28
FU3	28
functions	1
G	
gas pipe isothermal control during cooling	59
gas pipe temperature thermistor	124
gas pipe thermistor	46, 48, 162
H	
H6	120
H8	121
H9	123
Hall IC	106, 112
Hall IC check	143
HC3	28
HC4	28
heat exchanger temperature thermistor	107
heat exchanger thermistor	162
heating peak-cut control	54
high pressure control in cooling	118
HL1	28
HL2	28
HN1	28
HN2	28
HOME LEAVE operation	41, 79
hot start function	43
HR3	28
HR4	28
I	
indoor heat exchanger thermistor	47, 48
indoor liquid pipe thermistor	47
indoor unit PCB abnormality	103
input current control	53
input over current detection	113
installation condition check	139
instruction	65
insufficient gas	131
insufficient gas control	61
INTELLIGENT EYE	39
INTELLIGENT EYE operation	81
INTELLIGENT EYE sensor	172
INTELLIGENT EYE sensor PCB	23
inverter powerful operation	42
inverter units refrigerant system check	141
J	
J3	123
J4	171
J6	123
J8	123
J9	28, 123
JA	22, 24, 26, 171
JB	22, 24, 26, 171
JC	22, 24, 26, 171
jumper settings	171
L	
L3	125
L4	127
L5	129
LED A	22, 24, 26, 28
LED1	22, 24, 26
LED2	22, 24, 26
LED3	22, 24, 26
liquid compression protection function 2	55
liquid pipe temperature thermistor	124
liquid pipe thermistor	162
M	
main circuit electrolytic capacitor check	142
main structural parts	45
mode hierarchy	49
mold proof air filter	43
N	
names of parts	67
night set mode	38
note for multi system	85
O	
OL activation	110
on/off button on indoor unit	43
operation lamp	96
outdoor air temperature thermistor	124, 156
outdoor heat exchanger thermistor	46, 48
outdoor unit fan system check (with DC motor) ..	140
outdoor unit heat exchanger temperature thermistor	124
outdoor unit PCB abnormality	135
OUTDOOR UNIT SILENT operation	78
output over current detection	129
over current	61
overload	61
over-voltage detection	133
P	
P4	123
panels	146
partition plate	159
PCB	151
photocatalytic deodorizing filter	43
PI control	51
piping diagrams	174
position sensor abnormality	120
power failure recovery function	171
power supply PCB	27

power transistor check	142
power-airflow dual flaps	34
POWERFUL operation	77
POWERFUL operation mode	62
preheating operation	52
preparation before operation	70
preventing indoor freezing	62
printed circuit board connector wiring diagram	22
problem symptoms and measures	98
programme dry function	36
propeller fan	148
R	
radiation fin temperature rise	127
radiation fin thermistor	124
room temperature thermistor	107
RTH1	22, 24
S	
S1	22, 24
S10	28
S11	28
S12	28
S20	28, 151
S21	22, 24, 26, 28, 151
S24	26
S25	26
S26	22, 24, 26
S27	22, 26
S30	28
S31	26
S32	22, 24, 26
S35	22
S36	26
S37	26
S45	28
S6	22, 26
S7	22, 24, 26
S70	28, 148, 151
S80	28, 151
S90	28, 151
S91	28, 151
S93	28, 154
SC control	60
self-diagnosis digital display	44
sensor malfunction detection	61
service check function	99
SH condenser	155
signal receiver PCB	27
signal receiving sign	43
signal transmission circuit abnormality	135
sound blanket	159
stop valve cover	146
SW1	24, 26
SW2	26
SW7	22
T	
test run	170
thermistor	46, 162
thermistor or related abnormality (indoor unit)	107
thermistor or related abnormality (outdoor unit) ..	123
thermistor resistance check	138
TIMER operation	83
top panel	147
troubleshooting	90
troubleshooting with the led indication	97
turning speed pulse input on the outdoor unit PCB check	143
U	
U0	131
U2	133
U4	135
UA	134
UH	108, 134
unspecified voltage (between indoor and outdoor units)	134
V	
V1	22, 24, 26
voltage detection function	62
W	
wide-angle louvres	34
wiring diagrams	177

Drawings & Flow Charts

A			
adjusting the angle of the intelligent eye sensor ..172			
anti-icing function108			
anti-icing function in other rooms / unspecified voltage (between indoor and outdoor units)134			
auto swing34			
automatic air flow control for cooling35			
automatic air flow control for heating35			
automatic operation37			
C			
capacitor voltage check141			
compressor lock111			
compressor protection function52			
control PCB23, 24, 26, 29			
CT or related abnormality121			
D			
DC fan lock112			
defrost control56			
diagnosis mode100			
discharge pipe control53			
discharge pipe temperature control117			
discharge pressure check140			
display PCB23, 25, 27			
E			
electrical box temperature rise125			
electronic expansion valve check136			
F			
fan motor (AC motor) or related abnormality106			
filter PCB28			
four way valve abnormality115			
four way valve performance check137			
freeze-up protection control54			
freeze-up protection control or high pressure control104			
frequency control50			
frequency principle32			
function of thermistor cooling only model48			
heat pump model46			
H			
Hall IC check143			
heating peak-cut control54			
high pressure control in cooling118			
Home Leave operation41			
I			
indoor unit PCB abnormality103			
input current control53			
input over current detection113			
installation condition check139			
insufficient gas131			
insufficient gas control61			
INTELLIGENT EYE39			
INTELLIGENT EYE sensor PCB23			
inverter features33			
inverter powerful operation42			
inverter units refrigerant system check141			
J			
jumper settings171			
M			
main circuit electrolytic capacitor check142			
main structural parts cooling only model45			
heat pump model45			
mode hierarchy49			
N			
night set mode38			
O			
OL activation (compressor overload)110			
on/off button on indoor unit43			
operation lamp96			
outdoor unit fan system check (with DC motor) ..140			
outdoor unit PCB abnormality or signal transmission circuit abnormality135			
output over current detection129			
over-voltage detection133			
P			
pipng diagrams174			
indoor units174			
outdoor units176			
position sensor abnormality120			
power supply PCB27			
power transistor check142			
programme dry function36			
R			
radiation fin temperature rise127			
S			
signal receiver PCB27			
T			
target discharge pipe temperature control60			
thermistor or related abnormality (indoor unit)107			
thermistor or related abnormality (outdoor unit) ..123			
thermistor resistance check138			
trial operation from remote controller170			
troubleshooting with the LED indication97			
turning speed pulse input on the outdoor unit PCB check143			

W

wiring diagrams177
 indoor units177
 outdoor units179



Daikin Europe N.V. is approved by LRQA for its Quality Management System in accordance with the ISO9001 standard. ISO9001 pertains to quality assurance regarding design, development, manufacturing as well as to services related to the product.



Daikin units comply with the European regulations that guarantee the safety of the product.



ISO14001 assures an effective environmental management system in order to help protect human health and the environment from the potential impact of our activities, products and services and to assist in maintaining and improving the quality of the environment.



Daikin Europe N.V. participates in the Eurovent Certification Programme for Air Conditioners (AC), Liquid Chilling Packages (LCP) and Fan Coil Units (FC); the certified data of certified models are listed in the Eurovent Directory.

Specifications are subject to change without prior notice



DAIKIN EUROPE N.V.

Zandvoordestraat 300
B-8400 Ostend - Belgium
www.daikineurope.com