

# Service Manual

## Heat Reclaim Ventilation - with DX coil -



### [Applied Models]

VKM 50GV1

VKM 80GV1

VKM 100GV1

VKM 50GMV1

VKM 80GMV1

VKM 100GMV1

# Heat Reclaim Ventilation - with DX coil -



VKM 50GV1  
 VKM 80GV1  
 VKM 100GV1  
 VKM 50GMV1  
 VKM 80GMV1  
 VKM100GMV1

1. Introduction .....	iv
1.1 Safety Cautions .....	iv
<b>Part 1 General Constructions .....</b>	<b>1</b>
1. General Information .....	2
1.1 Features .....	2
<b>Part 2 Product Specification .....</b>	<b>5</b>
1. Product Specification .....	6
1.1 With DX-coil & Humidifier .....	6
1.2 With DX-coil .....	8
1.3 Humidifier .....	10
<b>Part 3 Operation .....</b>	<b>11</b>
1. Operation .....	12
1.1 Explanation for Systems .....	12
1.2 Features of VKM-G(M) .....	15
1.3 Central Control System .....	17
1.4 Restrictions to Control System .....	18
1.5 Operation .....	20
<b>Part 4 Maintenance .....</b>	<b>35</b>
1. Maintenance .....	36
1.1 Maintenance for The Air Filter .....	36
1.2 Maintenance for The Heat Exchange Element .....	38
2. Inspection and Maintenance of the Humidifier .....	39
2.1 For VKM-GMV1 Series .....	39
2.2 Replacing the Humidifier Element .....	42

<b>Part 5 Control Functions .....</b>	<b>43</b>
1. Control Functions .....	44
1.1 Explanation of individual Functions .....	44
1.2 Layout of switches on Printed Circuit Board.....	50
<b>Part 6 Troubleshooting .....</b>	<b>51</b>
1. Troubleshooting by Remote Controller .....	52
1.1 The INSPECTION / TEST Button.....	52
1.2 Self-diagnosis by Wired Remote Controller .....	53
2. Troubleshooting .....	54
2.1 Error Code Indication .....	54
2.2 Operation of The Remote Controller's Inspection / Test Operation Button .....	55
2.3 Indoor Air Thermistor Error.....	56
2.4 Outdoor Air Thermistor Error.....	57
2.5 Damper System Error (Alarm).....	58
2.6 Damper System Error (Alarm).....	59
2.7 "R1" Indoor Unit: PC Board Defect.....	60
2.8 "R3" Indoor Unit: Malfunction of Moving Part of Electronic Expansion Valve (20E) .....	61
2.9 "C4" Indoor Unit: Malfunction of Thermistor (R4T) for Heat Exchanger ..	62
2.10 "C5" Indoor Unit: Malfunction of Thermistor (R5T) for Gas Pipes.....	63
2.11 "C3" Indoor Unit: Malfunction of Thermistor (R3T) for Suction Air.....	64
2.12 "U3" Check Operation not executed .....	65
2.13 Dedicated LCD Remote Controller.....	66
2.14 Data Transmission Error (Between LCD Remote Controller and Main Unit) .....	67
2.15 "U5" Malfunction of Transmission Between Remote Controller and Indoor Unit .....	68
2.16 "UB" Malfunction of Transmission Between Master and Slave Remote Controllers .....	69
2.17 "UR" Excessive Number of Indoor Units .....	70
2.18 "UL" Address Duplication of Central Remote Controller .....	71
2.19 "UE" Malfunction of Transmission Between Central Remote Controller and Indoor Unit .....	72
2.20 "UE" Malfunction of Transmission Between Central Remote Controller and Indoor Unit .....	74
2.21 Main Unit PCB Assembly .....	75
2.22 Thermistor .....	76
2.23 Power Transformer.....	78
2.24 Damper Motor .....	79
<b>Part 7 Field Setting .....</b>	<b>81</b>
1. Field Setting .....	82
1.1 Field Setting and Test Run.....	82

**Part 8 Appendix..... 87**

- 1. Appendix .....88
  - 1.1 Wiring Diagram.....88
  - 1.2 List of Electrical and Functional Parts .....90
- 2. Piping diagram .....91





**Index ..... i**

**Drawings & Flow Charts ..... iii**





# 1. Introduction







## 1.1 Safety Cautions

### Cautions and Warnings

- Be sure to read the following safety cautions before conducting repair work.
- The caution items are classified into “ **Warning**” and “ **Caution**”. The “ **Warning**” items are especially important since they can lead to death or serious injury if they are not followed closely. The “ **Caution**” items can also lead to serious accidents under some conditions if they are not followed. Therefore, be sure to observe all the safety caution items described below.
- About the pictograms
  - △ This symbol indicates an item for which caution must be exercised.  
The pictogram shows the item to which attention must be paid.
  - This symbol indicates a prohibited action.  
The prohibited item or action is shown inside or near the symbol.
  - This symbol indicates an action that must be taken, or an instruction.  
The instruction is shown inside or near the symbol.
- After the repair work is complete, be sure to conduct a test operation to ensure that the equipment operates normally, and explain the cautions for operating the product to the customer



### 1.1.1 Caution in Repair



 <b>Warning</b>	
Be sure to cut off the power before disassembling the equipment for a repair. Working on the equipment that is connected to a power supply can cause an electrical shock. If it is necessary to supply power to the equipment to conduct the repair or inspecting the circuits, do not touch any electrically charged sections of the equipment.	
If the refrigerant gas discharges during the repair work, do not touch the discharging refrigerant gas. The refrigerant gas can cause frostbite.	
When disconnecting the suction or discharge pipe of the compressor at the welded section, release the refrigerant gas completely at a well-ventilated place first. If there is a gas remaining inside the compressor, the refrigerant gas or refrigerating machine oil discharges when the pipe is disconnected, and it can cause injury.	
If the refrigerant gas leaks during the repair work, ventilate the area. The refrigerant gas can generate toxic gases when it contacts flames.	
The step-up capacitor supplies high-voltage electricity to the electrical components of the outdoor unit. Be sure to discharge the capacitor completely before conducting repair work. A charged capacitor can cause an electrical shock.	
Do not start or stop the air conditioner operation by plugging or unplugging the power cable plug. Plugging or unplugging the power cable plug to operate the equipment can cause an electrical shock or fire.	

 <b>Caution</b>	
Do not repair the electrical components with wet hands. Working on the equipment with wet hands can cause an electrical shock.	
Do not clean the air conditioner by splashing water. Washing the unit with water can cause an electrical shock.	
Be sure to provide the grounding when repairing the equipment in a humid or wet place, to avoid electrical shocks.	
Be sure to turn off the power switch and unplug the power cable when cleaning the equipment. The internal fan rotates at a high speed, and cause injury.	
Do not tilt the unit when removing it. The water inside the unit can spill and wet the furniture and floor.	
Be sure to check that the refrigerating cycle section has cooled down sufficiently before conducting repair work. Working on the unit when the refrigerating cycle section is hot can cause burns.	
Use the welder in a well-ventilated place. Using the welder in an enclosed room can cause oxygen deficiency.	





### 1.1.2 Cautions Regarding Products after Repair



 <b>Warning</b>	
Be sure to use parts listed in the service parts list of the applicable model and appropriate tools to conduct repair work. Never attempt to modify the equipment. The use of inappropriate parts or tools can cause an electrical shock, excessive heat generation or fire.	
When relocating the equipment, make sure that the new installation site has sufficient strength to withstand the weight of the equipment. If the installation site does not have sufficient strength and if the installation work is not conducted securely, the equipment can fall and cause injury.	
Be sure to install the product correctly by using the provided standard installation frame. Incorrect use of the installation frame and improper installation can cause the equipment to fall, resulting in injury.	For integral units only
Be sure to install the product securely in the installation frame mounted on a window frame. If the unit is not securely mounted, it can fall and cause injury.	For integral units only
Be sure to use an exclusive power circuit for the equipment, and follow the technical standards related to the electrical equipment, the internal wiring regulations and the instruction manual for installation when conducting electrical work. Insufficient power circuit capacity and improper electrical work can cause an electrical shock or fire.	

 <b>Warning</b>	
Be sure to use the specified cable to connect between the indoor and outdoor units. Make the connections securely and route the cable properly so that there is no force pulling the cable at the connection terminals. Improper connections can cause excessive heat generation or fire.	
When connecting the cable between the indoor and outdoor units, make sure that the terminal cover does not lift off or dismount because of the cable. If the cover is not mounted properly, the terminal connection section can cause an electrical shock, excessive heat generation or fire.	
Do not damage or modify the power cable. Damaged or modified power cable can cause an electrical shock or fire. Placing heavy items on the power cable, and heating or pulling the power cable can damage the cable.	
Do not mix air or gas other than the specified refrigerant (R410A) in the refrigerant system. If air enters the refrigerating system, an excessively high pressure results, causing equipment damage and injury.	
If the refrigerant gas leaks, be sure to locate the leak and repair it before charging the refrigerant. After charging refrigerant, make sure that there is no refrigerant leak. If the leak cannot be located and the repair work must be stopped, be sure to perform pump-down and close the service valve, to prevent the refrigerant gas from leaking into the room. The refrigerant gas itself is harmless, but it can generate toxic gases when it contacts flames, such as fan and other heaters, stoves and ranges.	
When replacing the coin battery in the remote controller, be sure to disposed of the old battery to prevent children from swallowing it. If a child swallows the coin battery, see a doctor immediately.	

 <b>Caution</b>	
Installation of a leakage breaker is necessary in some cases depending on the conditions of the installation site, to prevent electrical shocks.	
Do not install the equipment in a place where there is a possibility of combustible gas leaks. If a combustible gas leaks and remains around the unit, it can cause a fire.	
Be sure to install the packing and seal on the installation frame properly. If the packing and seal are not installed properly, water can enter the room and wet the furniture and floor.	For integral units only

### 1.1.3 Inspection after Repair





 <b>Warning</b>	
Check to make sure that the power cable plug is not dirty or loose, then insert the plug into a power outlet all the way. If the plug has dust or loose connection, it can cause an electrical shock or fire.	
If the power cable and lead wires have scratches or deteriorated, be sure to replace them. Damaged cable and wires can cause an electrical shock, excessive heat generation or fire.	
Do not use a joined power cable or extension cable, or share the same power outlet with other electrical appliances, since it can cause an electrical shock, excessive heat generation or fire.	

 <b>Caution</b>	
Check to see if the parts and wires are mounted and connected properly, and if the connections at the soldered or crimped terminals are secure. Improper installation and connections can cause excessive heat generation, fire or an electrical shock.	
If the installation platform or frame has corroded, replace it. Corroded installation platform or frame can cause the unit to fall, resulting in injury.	
Check the grounding, and repair it if the equipment is not properly grounded. Improper grounding can cause an electrical shock.	
Be sure to measure the insulation resistance after the repair, and make sure that the resistance is 1 Mohm or higher. Faulty insulation can cause an electrical shock.	
Be sure to check the drainage of the indoor unit after the repair. Faulty drainage can cause the water to enter the room and wet the furniture and floor.	

### 1.1.4 Using Icons

Icons are used to attract the attention of the reader to specific information. The meaning of each icon is described in the table below:

### 1.1.5 Using Icons List

Icon	Type of Information	Description
 Note:	Note	A “note” provides information that is not indispensable, but may nevertheless be valuable to the reader, such as tips and tricks.
 Caution	Caution	A “caution” is used when there is danger that the reader, through incorrect manipulation, may damage equipment, lose data, get an unexpected result or has to restart (part of) a procedure.
 Warning	Warning	A “warning” is used when there is danger of personal injury.
	Reference	A “reference” guides the reader to other places in this binder or in this manual, where he/she will find additional information on a specific topic.





# Part 1

# General Constructions

1. General Information .....	2
1.1 Features .....	2

# 1. General Information

## 1.1 Features

### 1.1.1 External Appearance

VKM50GMV1

VKM50GV1



VKM80GMV1

VKM100GMV1

VKM80GV1

VKM100GV1



### 1.1.2 Model Series

Type	500	800	1000
DX-Coil and Humidifier	VKM50GMV1	VKM80GMV1	VKM100GMV1
DX-Coil	VKM50GV1	VKM80GV1	VKM100GV1

These units are applied only for CE regulation.

### 1.1.3 Nomenclature

**V K M 50 G M V1**

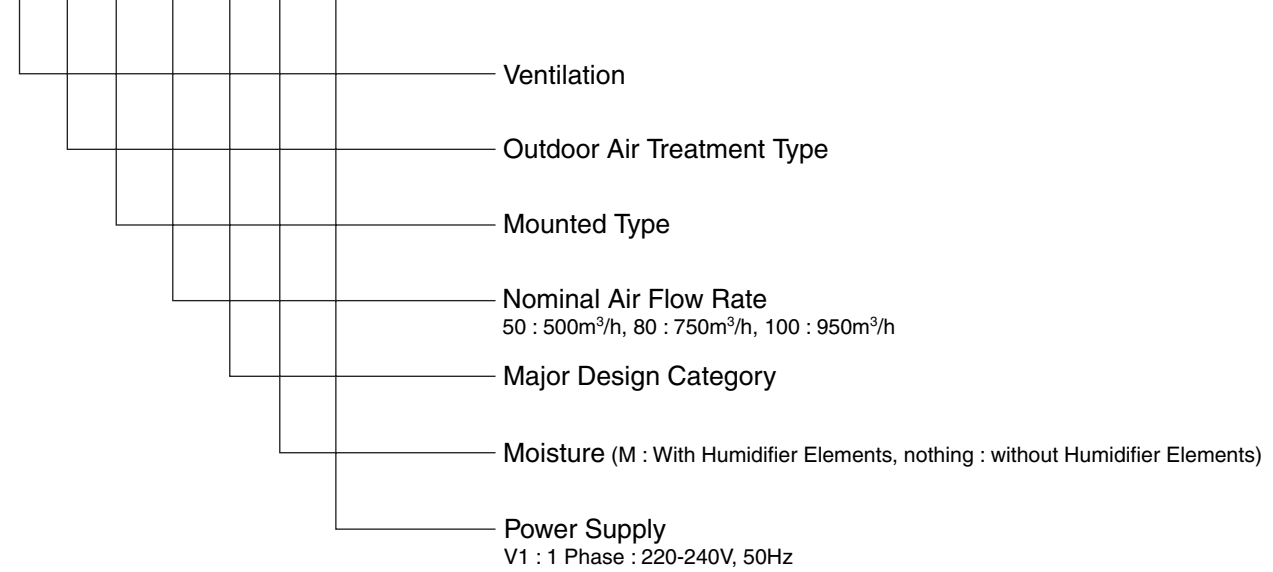

### 1.1.4 Structures

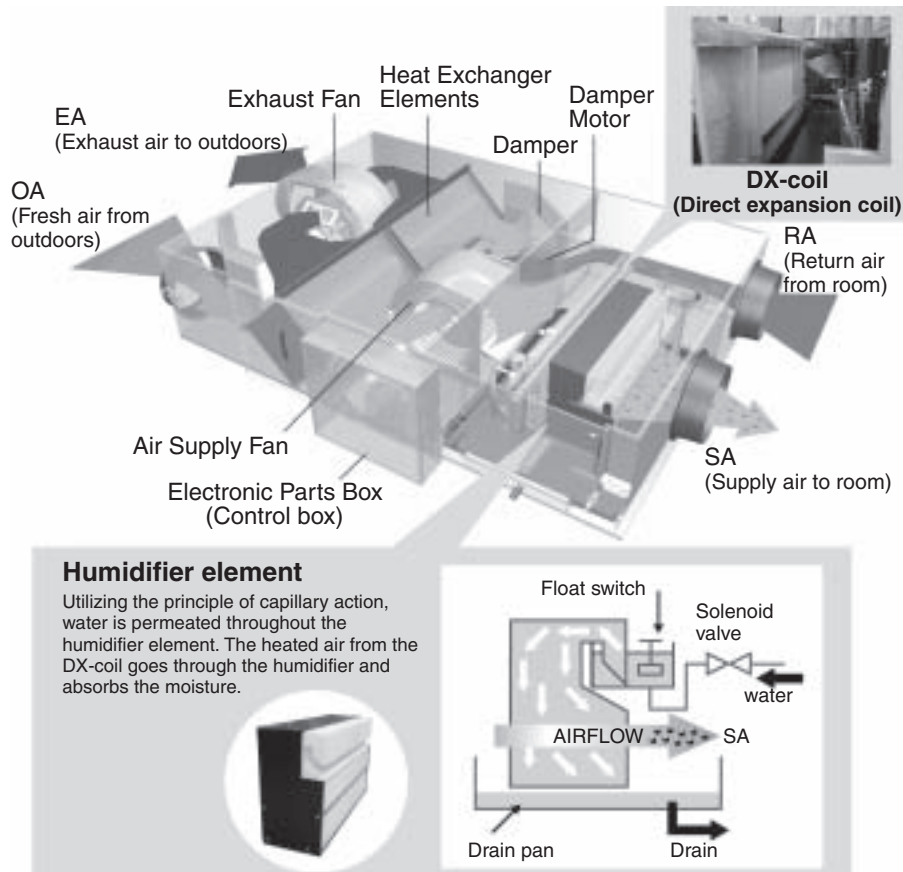

### 1.1.5 Optional Accessories

#### Installation of Optional Accessories (For VKM50G (M) V1, VKM80G (M) V1, VKM100G (M) V1)

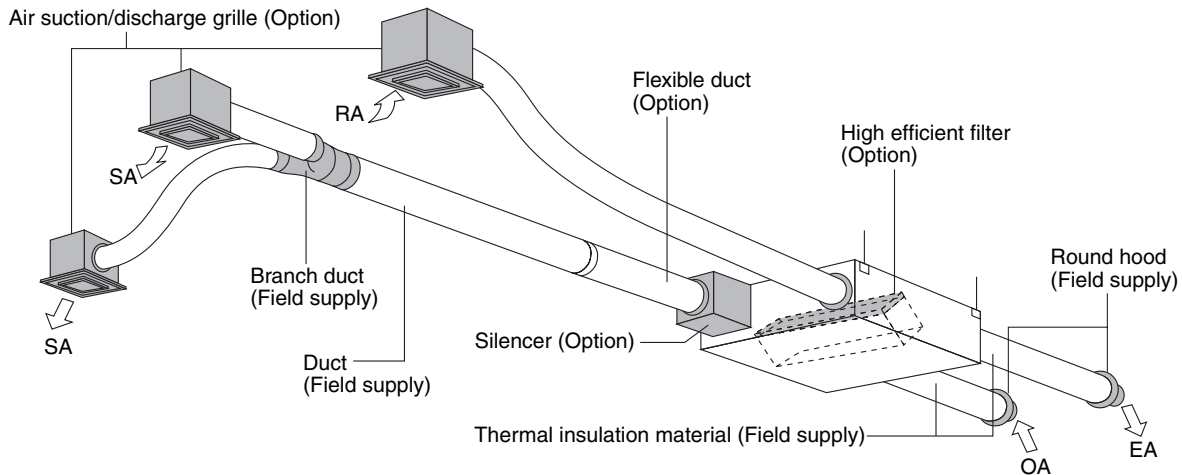

#### Optional Accessories

Member		Applicable model		VKM50/80/100G(GM)V1									
Controlling device	Remote control		BRC1A62 *1 BRC1D527 (EU only) Note. 8										
	Centralized controlling device	Central remote control	DCS302C(A)61										
		Unified ON/OFF control	DCS301B(A)61										
		Schedule timer	DST301B(A)61										
	PC Board Adaptor	Wiring adaptor for electrical appendices		KRP2A61									
		For ON signal output		KRP50-2									
		For heater control kit		BRP4A50									
		For wiring	Type (indoor unit of VRV)	FXCQ-M	FXFQ-M	FXKQ-M	FXSQ-M	FXMQ-M	FXHQ-M	FXAQ-M	FXDQ-N	FXLQ-M FXNQ-M	FXZQ-M
			KRP1B61*	KRP1B59*		KRP1B61		KRP1B3	—	KRP1B56	KRP1B61	KRP1B57	
	Installation box for adaptor PCB <sub>☆</sub>		Notes 2, 3 KRP1B96	Notes 2, 3 KRP1D98	—	Note 5 KRP4A91	—	Note 3 KRP1C93	Notes 2, 3 KRP4A93	Notes 4, 6 KRP1B101	—	Notes 4, 6 KRP1B101	

- Note: 1. Installation box ☆ is necessary for each adaptor marked \*.  
 2. Up to 2 adaptors can be fixed for each installation box.  
 3. Only one installation box can be installed for each indoor unit.  
 4. Up to 2 installation boxes can be installed for each indoor unit.  
 5. Installation box ☆ is necessary for second adaptor.  
 6. Installation box ☆ is necessary for each adaptor.  
 7. \*1 Necessary when operating HRV (VKM) independently. When operating interlocked with other air conditioners, use the remote controls of the air conditioners.  
 8. BRC1D527 is recommended in Europe. It has the substantial function from BRC1A62.

Member		Applicable model		VKM50G(GM)V1		VKM80G(GM)V1		VKM100G(GM)V1		
Additional function	Silencer			—		KDDM24B100				
		Nominal pipe diameter (mm)		—		φ 250 mm				
	Air suction/ Discharge grille	White	K-DGL200B		K-DGL250B					
		Nominal pipe diameter (mm)	φ 200		φ 250					
High efficiency filter		KAF241G80M		KAF241G100M						
Air filter for replacement *		KAF242G80M		KAF242G100M						
Flexible duct (1 m)		K-FDS201C		K-FDS251C						
Flexible duct (2 m)		K-FDS202C		K-FDS252C						
Drawing No.						3D049203				

\* Including 2 sheets per unit.

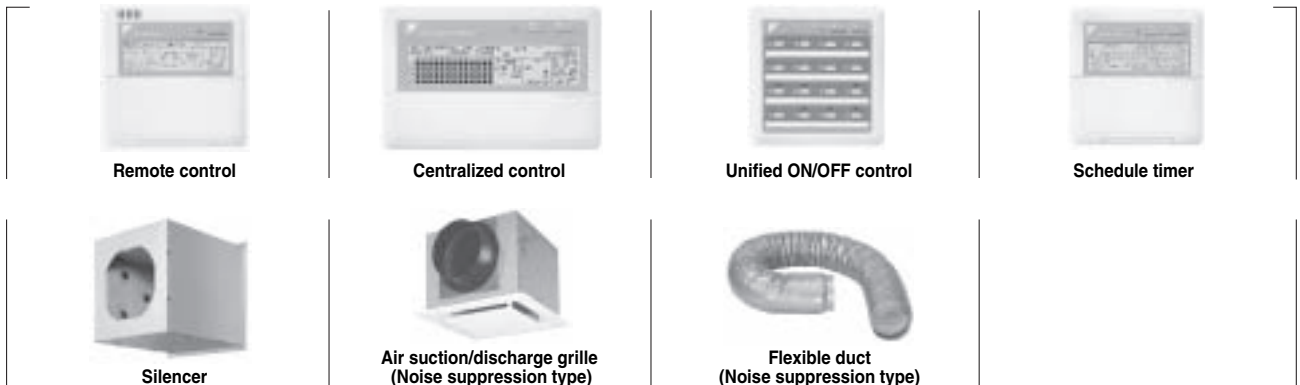

# Part 2

# Product Specification

1. Product Specification .....	6
1.1 With DX-coil & Humidifier .....	6
1.2 With DX-coil .....	8
1.3 Humidifier .....	10

# 1. Product Specification

## 1.1 With DX-coil & Humidifier

Type			VKM50GMV1	VKM80GMV1	VKM100GMV1
Refrigerant			R410A		
Power Supply			220-240V, 1ph., 50Hz		
Air Flow Rate & Static Pressure (Note 7)	Ultra-high	Air flow rate (m <sup>3</sup> /h)	500	750	950
		Static pressure (Pa)	160	140	110
	High	Air flow rate (m <sup>3</sup> /h)	500	750	950
		Static pressure (Pa)	120	90	70
	Low	Air flow rate (m <sup>3</sup> /h)	440	640	820
		Static pressure (Pa)	100	70	60
Normal Amp. (Note 8)	Ultra-high	A	3.0	3.0	3.0
	High	A	2.5	2.6	2.5
	Low	A	2.1	2.1	2.1
Normal Input	Ultra-high	W	560	620	670
	High	W	490	560	570
	Low	W	420	470	480
Fan Motor		Type	Sirroco Fan		
Motor Output		kW	0.280×2	0.280×2	0.280×2
Sound Level (Note 5) (220/230/240V)	Ultra-high	(dB)	37/37.5/38	38.5/39/40	39/39.5/40
	High	(dB)	35/35.5/36	36/37/37.5	37/37.5/38
	Low	(dB)	32/33/34	33/34/35.5	34/34.5/35.5
Humidifier	System		Natural Evaporating Type		
	Elements quantity		1		
	Amount (Note. 4) (kg/h)		2.7	4.0	5.4
	Pressure Feed Water (MPa)		0.02-0.49		
Temp. Exchange Efficiency	Ultra-high	(%)	76	78	74
	High	(%)	76	78	74
	Low	(%)	77.5	79	76.5
Enthalpy Exchange Efficiency (Cooling)	Ultra-high	(%)	64	66	62
	High	(%)	64	66	62
	Low	(%)	67	68	66
Enthalpy Exchange Efficiency (Heating)	Ultra-high	(%)	67	71	65
	High	(%)	67	71	65
	Low	(%)	69	73	69
Casing			Galvanized Steel Plate		
Insulating Material			Self-Extinguishable Urethane Foam		
Heat Exchanging System			Air to Air Cross Flow Total Heat (Sensible + Latent Heat) Exchange		
Heat Exchanger Element			Specially Processed Nonflammable Paper		
Air Filter			Multidirectional Fibrous Fleeces		
Coil (Cross Fin Coil)	Rows × Stages × Fin Pitch (mm)		2 × 12 × 2.2		
	Face Area (m <sup>2</sup> )		0.078	0.118	0.165
Cooling Capacity (Note 2) (kW)			4.71 (1.91)	7.46 (2.96)	9.12 (3.52)
Heating Capacity (Note 3) (kW)			5.58 (2.38)	8.79 (3.79)	10.69 (4.39)
Dimensions Height × Width × Depth (mm)			387 × 1,764 × 832	387 × 1,764 × 1,214	387 × 1,764 × 1,214
Connection Duct Diameter (mm)			φ200	φ250	
Piping Connection	Liquid (mm)		φ6.4 C1220T (Flare Connection)		
	Gas (mm)		φ12.7 C1220T (Flare Connection)		
	Water Supply (mm)		φ6.4 C1220T		
	Drain		PT3/4 External Thread		
Refrigerant Control			Electronic Expansion Valve		
Connectable Outdoor Unit			R410A M series		
Weight	Net (kg)		102	120	125
	Gross (Note 9) (kg)		107	129	134
Unit Ambient Condition	Around Unit		0°C~40°CDB 80%RH or Less		
	OA (Note 10)		-15°C~40°CDB 80%RH or Less		
	RA (Note 10)		0°C~40°CDB 80%RH or Less		
Operation Mode			Heat Exchange Mode, Bypass Mode, Freshup Mode		
Accessories			Operation Manual, Installation Manual, Duct Connecting Flange, M4 Tapping Screw (for Connecting Duct), Water Supply Piping with Strainer, Half-Union Joint (Copper Piping Joint), Flare Nut (Copper Piping Joint), Refrigerant Piping Insulation Cover, Water Supply Piping Insulation Cover, Sealing Material, Clamp		
Drawing Number			4D047681	4D047682	4D047683

**Note:**

1. Cooling and heating capacities are based on the following conditions. Fan is based on High and Ultra-high. The figures in the parenthesis indicate the heat reclaimed from the heat recovery ventilator. When calculating the capacity as indoor units, use the following figures : VKM50GMV1 : 3.5kW VKM80GMV1 : 5.6kW VKM100GMV1 : 7.0kW
2. Indoor temperature : 27°C DB, 19°C WB, Outdoor temperature : 35°C DB
3. Indoor temperature : 20°C DB, Outdoor temperature : 7°CDB, 6°C WB
4. Humidifying capacity is based on the following conditions :  
Indoor temperature : 20°C DB, 15°C WB, Outdoor temperature : 7°C DB, 6°C WB
5. The operating sound measured at the point 1.5 m below the center of the unit is converted to that measured at an anechoic chamber built in accordance with the JIS C 1502 conditions. The actual operating sound varies depending on the surrounding conditions (near running unit's sound, reflected sound and so on) and is normally higher than this value. For operation in a quiet room, it is required to take measures to lower the sound.
6. The noise level at the air discharge port is about 8-11 dB higher than unit's operating sound.  
For operation in a quiet room, it is required to take measures to lower the sound for example install more than 2m soft duct near the air discharge grille.
7. Air flow rate can be changed over to low mode or high mode.
8. Normal Amp., input, efficiency depend on the other above conditions.
9. In case of holding full water in humidifier.
- 10.OA : Fresh air from outdoor, RA : Return air from room
- 11.The specifications, designs and information here are subject to change without notice.
- 12.Temperature exchange efficiency is the mean value for cooling and heating. Efficiency is measured under the following condition. Ratio of rated external static pressure is kept constant as follows. Outdoor side to indoor side is equal to 7 to 1.
- 13.In heating operation, freezing of the outdoor unit's coil increases. Heating capability decreases and the system goes into defrost operation.  
During defrost operation, the fans of the unit continues driving (factory setting). The purpose of this is to maintain the amount of ventilation and humidifying.
- 14.When connecting with a VRVII system heat recovery type outdoor unit and bringing the RA (exhaust gas intake) of this unit directly in from the ceiling, connect to a BS unit identical to the VRV indoor unit (master unit), and use group-linked operation. (See the Engineering Data for details.)
- 15.When connecting the indoor unit directly to the duct, always use the same system on the indoor unit as with the outdoor unit, perform group-linked operation, and make the direct duct connection settings from the remote controller. (Mode No. "17 (27)" – First code No. "5" – Second code No. "6".) Also, do not connect to the outlet side of the indoor unit. Depending on the fan strength and static pressure, the unit might back up.



## 1.2 With DX-coil

Type			VKM50GV1	VKM80GV1	VKM100GV1
Refrigerant			R410A		
Power Supply			220-240V, 1ph., 50Hz		
Air Flow Rate & Static Pressure (Note 6)	Ultra-high	Air flow rate (m <sup>3</sup> /h)	500	750	950
		Static pressure (Pa)	180	170	150
	High	Air flow rate (m <sup>3</sup> /h)	500	750	950
		Static pressure (Pa)	150	120	100
	Low	Air flow rate (m <sup>3</sup> /h)	440	640	820
		Static pressure (Pa)	110	80	70
Normal Amp. (Note 7)	Ultra-high	A	3.0	3.0	3.0
	High	A	2.5	2.6	2.5
	Low	A	2.1	2.1	2.1
Normal Input	Ultra-high	W	560	620	670
	High	W	490	560	570
	Low	W	420	470	480
Fan Motor		Type	Sirroco Fan		
Motor Output		kW	0.280x2	0.280x2	0.280x2
Sound Level (Note 4)	Ultra-high	(dB)	38/38.5/39	40/41/41.5	40/40.5/41
	High	(dB)	36/36.5/37	37.5/38/39	38/38.5/39
	Low	(dB)	33.5/34.5/35.5	34.5/36/37	35/36/36.5
Temp. Exchange Efficiency	Ultra-high	(%)	76	78	74
	High	(%)	76	78	74
	Low	(%)	77.5	79	76.5
Enthalpy Exchange Efficiency (Cooling)	Ultra-high	(%)	64	66	62
	High	(%)	64	66	62
	Low	(%)	67	68	66
Enthalpy Exchange Efficiency (Heating)	Ultra-high	(%)	67	71	65
	High	(%)	67	71	65
	Low	(%)	69	73	69
Casing			Galvanized Steel Plate		
Insulating Material			Self-Extinguishable Urethane Foam		
Heat Exchanging System			Air to Air Cross Flow Total Heat (Sensible + Latent Heat) Exchange		
Heat Exchanger Element			Specially Processed Nonflammable Paper		
Air Filter			Multidirectional Fibrous Fleeces		
Coil (Cross Fin Coil)	Rows × Stages × Fin Pitch	(mm)	2 × 12 × 2.2		
	Face Area	(m <sup>2</sup> )	0.078	0.118	0.165
Cooling Capacity (Note 2)		(kW)	4.71 (1.91)	7.46 (2.96)	9.12 (3.52)
Heating Capacity (Note 3)		(kW)	5.58 5(2.38)	8.79 (3.79)	10.69 (4.39)
Dimensions	Height × Width × Depth	(mm)	387 × 1,764 × 832	387 × 1,764 × 1,214	387 × 1,764 × 1,214
Connection Duct Diameter		(mm)	φ200	φ250	
Piping Connection	Liquid	(mm)	φ6.4 C1220T (Flare Connection)		
	Gas	(mm)	φ12.7 C1220T (Flare Connection)		
	Drain		PT3/4 External Thread		
Refrigerant Control			Electronic Expansion Valve		
Connectable Outdoor Unit			R410A M(A) series		
Weight	Net	(kg)	96	109	114
Unit Ambient Condition	Around Unit		0°C-40°CDB 80%RH or Less		
	OA (Note 8)		-15°C-40°CDB 80%RH or Less		
	RA (Note 8)		0°C-40°CDB 80%RH or Less		
Operation Mode			Heat Exchange Mode, Bypass Mode, Fresh up Mode		
Accessories			Operation Manual, Installation Manual, Warranty, Duct Connecting Flange, M4 Tapping Screw (for Connecting Duct), Refrigerant Piping Insulation Cover, Clamp		
Drawing Number			4D048369	4D048370	4D048371

**Note:**

1. Cooling and heating capacities are based on the following conditions. Fan is based on High and Ultra-high.  
The figures in the parenthesis indicate the heat reclaimed from the heat recovery ventilator.  
When calculating the capacity as indoor units, use the following figures : VKM50GV1 : 3.5kW  
VKM80GV1 : 5.6kW VKM100GV1 : 7.0kW
2. Indoor temperature : 27°C DB, 19°C WB, Outdoor temperature : 35°C DB
3. Indoor temperature : 20°C DB, Outdoor temperature : 7°CDB, 6°C WB
4. The operating sound measured at the point 1.5 m below the center of the unit is converted to that measured at an anechoic chamber built in accordance with the JIS C 1502 conditions. The actual operating sound varies depending on the surrounding conditions (near running unit's sound, reflected sound and so on) and is normally higher than this value.  
For operation in a quiet room, it is required to take measures to lower the sound. In details, refer to engineering data.
5. The noise level at the air discharge port is about 8-11 dB higher than the unit's operating sound.  
For operation in a quiet room, it is required to take measures to lower the sound for example install more than 2m soft duct near the air discharge grille.
6. Air flow rate can be changed over to low mode or high mode.
7. Normal Amp., input, efficiency depend on the other above conditions.
8. OA : Fresh air from outdoor, RA : Return air from room
9. The specifications, designs and information here are subject to change without notice.
10. Temperature exchange efficiency is the mean value for cooling and heating. Efficiency is measured under the following condition. Ratio of rated external static pressure is kept constant as follows. Outdoor side to indoor side is equal to 7 to 1.
11. In heating operation, freezing of the outdoor unit's coil increases. Heating capability decreases and the system goes into defrost operation.  
During defrost operation, the fans of the unit continues driving (factory setting). The purpose of this is to maintain the amount of ventilation and humidifying.
12. When connecting with a VRVII system heat recovery type outdoor unit and bringing the RA (exhaust gas intake) of this unit directly in from the ceiling, connect to a BS unit identical to the VRV indoor unit (master unit), and use group-linked operation. (See the Engineering Data for details.)
13. When connecting the indoor unit directly to the duct, always use the same system on the indoor unit as with the outdoor unit, perform group-linked operation, and make the direct duct connection settings from the remote controller. (Mode No. "17 (27)" – First code No. "5" – Second code No. "6".) Also, do not connect to the outlet side of the indoor unit. Depending on the fan strength and static pressure, the unit might back up.

## 1.3 Humidifier

	VKM50GMV1	VKM80GMV1	VKM100GMV1
Humidifier type	Natural evaporating type humidifier		
Wetted element	Porosity plate 60 pcs.	Porosity plate 90 pcs.	Porosity plate 120 pcs. (60x2 pcs.)
Water inlet port	ø6.4 C1220T (Flare Connection)		
Water outlet port	PT3/4		
Supply water pressure	kg/cm <sup>2</sup>	0.2 (Min.) ~ 5.0 (Max.)	

- Note:**
1. Feed clean water (city water, tap water or equivalent) Dirty water may clog the valve or cause dirt deposits in the water container, resulting in poor humidifier performance. (Never use any cooling tower water and heating - purpose water.)  
Also, if the supply water is hard water, use a water softener because of short life.  
\*Life of humidifying element is about 3 years (4,000 hours), under the supply water conditions of hardness: 150 mg/l. (Life of humidifying element is about 1 year (1,500 hours) under the supply water conditions of hardness: 400 mg/l.)  
Annual operating hours: 10 hours / day × 26 days / month × 5 month = 1,300 hours
  2. Maintain the supply water temperature at 5 ~ 50°C and its pressure at 20 ~ 490 kPa (0.2 ~ 5.0 kg/cm<sup>2</sup>). If the water pressure is above 490 kPa (5.0 kg/cm<sup>2</sup>), add pressure reducing valve in between the kit and the supply water shut - off valve.
  3. The supply water line cannot be directly connected with a utility water tap. To unavoidably take water from such line, employ a CISTERN (gotten configuration authorization).
  4. Be sure to provide thermal insulation around the indoor piping as well as the shut - off valves.
  5. In order to prevent harmful bacteria from generating, do maintenance on humidifying unit portion at the beginning and the end of the heating season according to the operation manual.

# Part 3 Operation

1. Operation .....	12
1.1 Explanation for Systems.....	12
1.2 Features of VKM-G(M) .....	15
1.3 Central Control System .....	17
1.4 Restrictions to Control System .....	18
1.5 Operation.....	20

# 1. Operation

## 1.1 Explanation for Systems

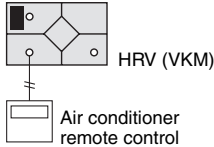
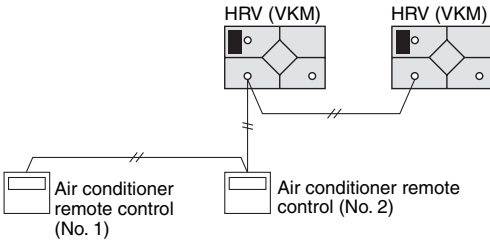
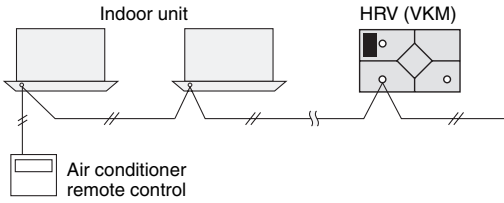
		System Construction	System Characteristics	Necessary Accessories																									
Independent Operation System	Independent Operation		<ul style="list-style-type: none"> <li>• Independent operation of HRV (VKM) is possible.</li> <li>• VRV remote control can be used.</li> </ul>	VRV remote control																									
	Simultaneous Operation of Multiple Units		<ul style="list-style-type: none"> <li>• Operation is possible using 2 remote controls.</li> <li>• Multiple HRV (VKM) units can be simultaneously controlled in batch. [Up to 8 HRV (VKM) units can be connected.]</li> </ul>	VRV remote control																									
Air Conditioning Interlocked Control (VRV, SkyAir) System	Standard System	 <p>Table 1 Connectable indoor units</p> <table border="1" data-bbox="312 1379 879 1541"> <tr> <td>HRV (VKM)</td> <td>0</td> <td>1</td> <td>2</td> <td>3</td> </tr> <tr> <td>VRV</td> <td>Up to 16</td> <td>Up to 14</td> <td>Up to 12</td> <td>Up to 10</td> </tr> <tr> <td></td> <td>4</td> <td>5</td> <td>6</td> <td>8</td> </tr> <tr> <td></td> <td>Up to 8</td> <td>Up to 6</td> <td>Up to 4</td> <td>Up to 2</td> </tr> <tr> <td></td> <td></td> <td></td> <td></td> <td>0</td> </tr> </table> <p>Note: The HRV (VKM) uses two remote control addresses per unit, and the number of units that can be group controlled are shown above.</p>	HRV (VKM)	0	1	2	3	VRV	Up to 16	Up to 14	Up to 12	Up to 10		4	5	6	8		Up to 8	Up to 6	Up to 4	Up to 2					0	<ul style="list-style-type: none"> <li>• Multiple VRV indoor units or HRV (VKM) units can be connected and controlled in batch, with interlocked operation of HRV (VKM)s and air conditioners by using the air conditioner remote control.</li> <li>• The HRV (VKM) unit can also be operated independently using the remote control for the indoor unit, even if the indoor unit is not in operation.</li> </ul>	VRV remote control
HRV (VKM)	0	1	2	3																									
VRV	Up to 16	Up to 14	Up to 12	Up to 10																									
	4	5	6	8																									
	Up to 8	Up to 6	Up to 4	Up to 2																									
				0																									

		System Construction	System Characteristics	Necessary Accessories
Air Conditioning Interlocked Centralized Control System	Batch/Individual Control System	<p>The diagram shows two identical indoor unit setups. Each setup includes an indoor unit, an HRV (VKM) unit, and an air conditioner remote control. A central control unit, labeled 'ON/OFF control or schedule timer', is connected to the HRV units of both indoor units.</p>	<p>[Unified ON/OFF control]</p> <ul style="list-style-type: none"> <li>• One control can control the “ON/OFF” operation of 16 groups of units collectively or individually.</li> <li>• Up to 8 controls can be installed in one centralized transmission line (in one system), which enables control of up to 128 groups. (16 groups x 8 = 128 groups)</li> </ul> <p>[Schedule Timer]</p> <ul style="list-style-type: none"> <li>• One schedule timer can control the weekly schedule of up to 128 units.</li> </ul>	<p>Unified ON/OFF control or schedule timer, VRV remote control</p> <p>When necessary, centralized control</p>
	Zone Control System	<p>The diagram shows two zones, Zone 1 and Zone 2, enclosed in a dashed box. Each zone contains an indoor unit, an HRV (VKM) unit, and an air conditioner remote control. A 'Centralized control' unit is connected to the HRV units of both zones. A 'Note 1' is placed near the HRV units.</p>	<p>[Centralized control]</p> <ul style="list-style-type: none"> <li>• The centralized control provides setting and monitoring functions, and can control up to 128 VRV and HRV (VKM) units collectively or individually.</li> <li>• Multiple groups can be controlled within the same zone.</li> </ul>	<p>Centralized control, VRV remote control</p> <p>When necessary, unified ON/OFF control or schedule timer</p>

Note 1: HRV remote control cannot be used.

### Recommended Systems

1. System with a remote sensor connected to each indoor unit

On the ceiling chamber system with which generated heat loads are treated in the ceiling space, the suction thermistor (body thermistor) mounted to the indoor unit alone cannot ensure the detection of room temperatures. Consequently, for the indoor unit, in order to ensure the detection of the room temperatures, it is recommended to change to the remote sensor system.

2. Connection of refrigerant piping

For the connection of refrigerant piping on the ceiling chamber system, it is recommended to provide a system preventing the cool-heat changeover while in automatic mode on the VKM through connecting a base indoor unit in the same duct system and the VKM to the same BS unit to interlock between the VKM and the indoor unit (\*).

\* In order to interlock between the VKM and the indoor unit, the group control of remote controllers should be provided.

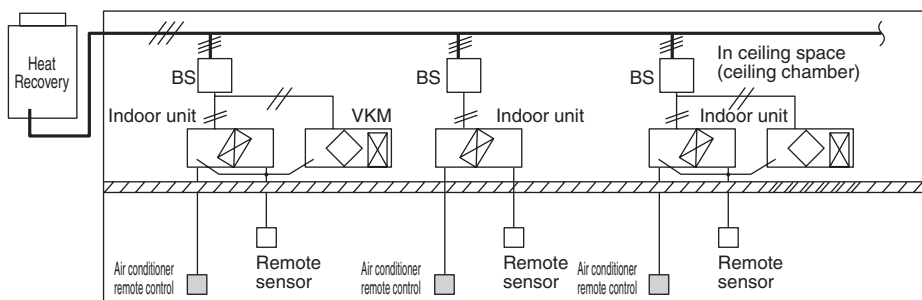

Fig. 1 When interlocking between the base indoor unit and the VKM:  
(Connect multiple indoor units and VKM to a single BS unit.)

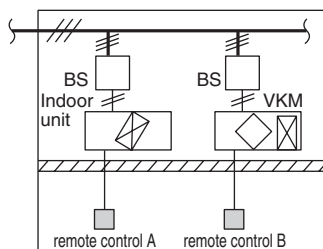

Fig. 2 When connecting a single indoor unit or a single VKM to a single BS unit:  
(If this is the case, use the VKM in fixed cooling or heating mode.)

3. Measures against inadequate humidification

When operating the system at a temperature in the ceiling space set higher than the initial setting, the heating thermostat on the VKM may turn OFF to disable humidification. In this case, according to the field setting on the remote controller, raise the heating set temperature. For details, refer to information on page 83.

## 1.2 Features of VKM-G(M)

### Basic control of VKM

VKM sucks the air after OA has subjected to total heat exchange with RA, detects the air temperature by means of the thermistor for inlet air into DX-coil (R3T) to make a judgment on operation mode, cooling or heating and exercises the control on the capacity of air heat exchanger.

### ■ Sensor position and its function

VKM consists of indoor unit + total heat exchanger portion.

Dissimilarities with normal indoor unit are :

- Position of thermostat in the normal indoor unit : Position to detect RA temperature
- Position of thermostat in VKM : Position to detect the air subjected to total heat exchange between OA and RA.

Therefore, the temperature detected by VKM gets lower than that of the indoor unit thermostat.

Doing so allows VKM to perform treatment of outside air with stability even as the indoor unit stays thermo-OFF state because of big difference between the set temperature and suction temperature even though the set temperature of VKM and indoor unit are the same.

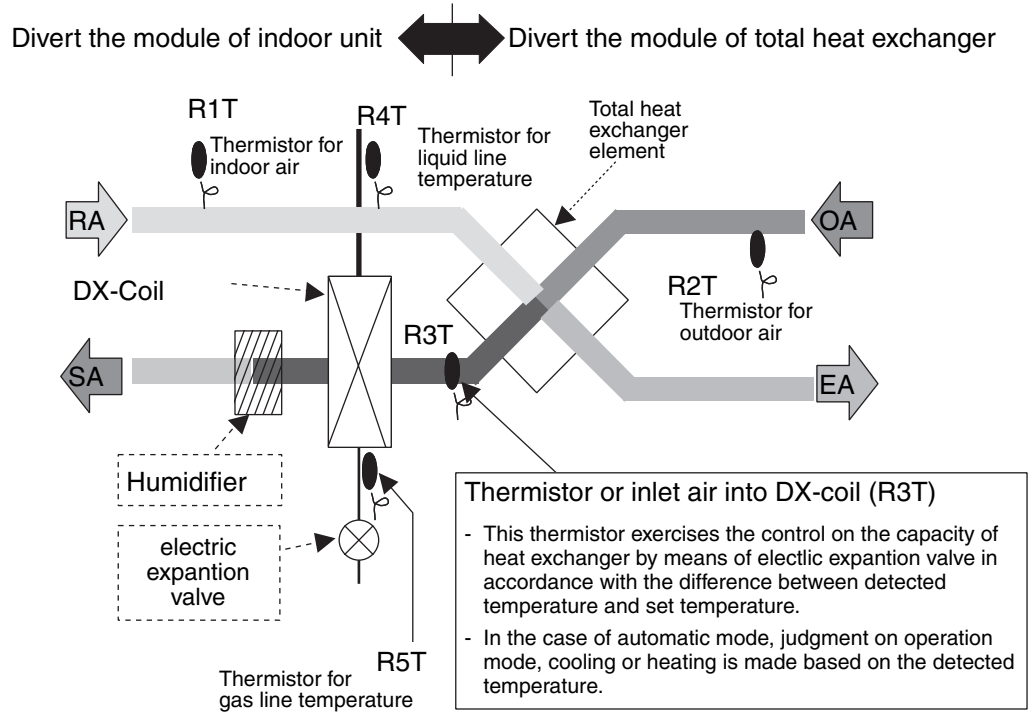

Because VKM-G(M) model is equipped with a heat exchanger unit, a PC-board (corresponding to VRV air conditioner's PC-board) for controlling the heat exchanger has been built-in in addition to a PC-board for ventilation. These two PC-boards are connected via remote controller line (P1, P2) to perform an interlocked control. Its control system provides the same condition when 1 ventilation and 1 VRV air conditioner have been remotely controlled. No air-conditioning (temperature controlling) function has been equipped. Therefore, it is necessary to prepare separately an indoor unit for air-conditioning purpose.

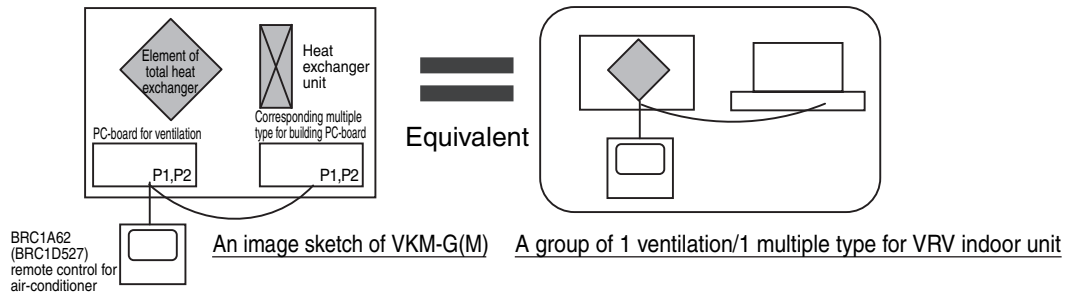



**[Points to be noted for VKM-G(M)]**

There are following restrictions with VKM-G(M) model due to its own controlling structure.

1. Stand alone system: No address setting is required because of its automatic addressing function (corresponding to VRV air conditioner PC-board : Master).  
Because it is under a group control, it is always required to connect to a remote controller. The structure does not permit if no remote controller is connected. A direct connection to a duct is also prohibited.
2. Interlock system : No address setting is required because of its automatic addressing function (Indoor unit : Master).
  - Basically, the interlocking with an air-conditioner is only made via connection to a remote controller line (P1, P2).

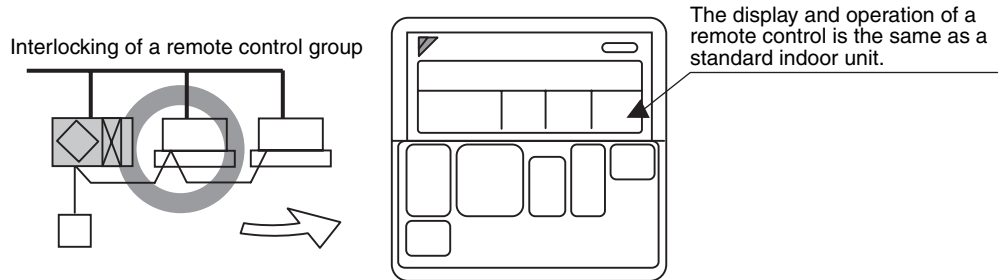

- Number of units connectable in case of a remote controller group  
Because 2 pieces of controlling PC-board have been built in a VKM-GM model, count the remote controller group as : 1 set = 2 units. The maximum number of units connectable to a remote controller group is 16.

<Example>  
 How many units of VKM-GM model can be connected within a single group?  
 In case of a group composed of (10 × indoor units + VKM-GM), the maximum number of VKM-GM is 3.  
 $10 + 3 \times 2 = 16$  units      OK  
 In case of 4 units ;  
 $10 + 4 \times 2 = 18$  units      NG (2 units are in excess)

- External contact point  
 If you want to start/stop through an external contact point, use external input terminals (T1 and T2).  
 \* If you start/stop using T1 and T2 terminals, the entire remote controller group makes a start/stop.

Note 1) JC/J2 of ventilation PC-board cannot be used. (Because only the ventilation PC-board makes a start/stop, no synchronized movement with the corresponding VRV indoor unit's PC-board is assured.)

## 1.3 Central Control System

- When carrying out a central connection, connect the central line to F1 and F2 only on the corresponding VRV indoor unit's PC-board. Do not connect to F1 and F2 on the ventilation side. (= Connect to the terminal block X3M.)

An image sketch of internal wiring on the ventilation side

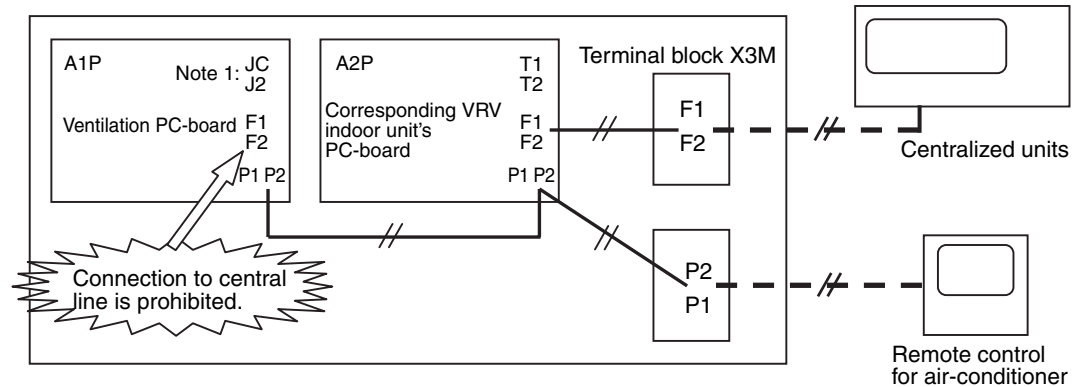

- In case of a central control, operation ON/OFF can be done separately by each zone. (In this case, zone interlocked setting must be kept as the factory setting.)
- Structure without a remote controller cannot be accepted because the remote controller group is controlled within a VKM-G(M) model. (i-Touch controller, central remote controller)

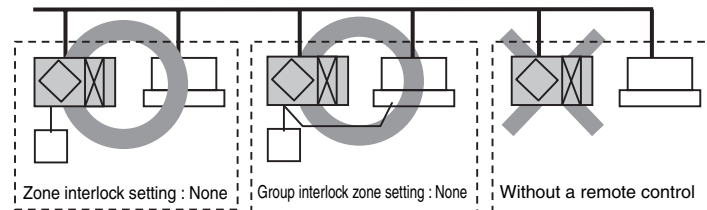

\* Alteration of set temperature and independent ventilation operation cannot be performed from a central device.

## 1.4 Restrictions to Control System

### 1.4.1 Do not Give VKM-G(M) Model a Function to Select Cooling/Heating. (This is because the operation mode switches automatically depending on the outdoor conditions regardless of the indoor temperature when set to "Automatic".)

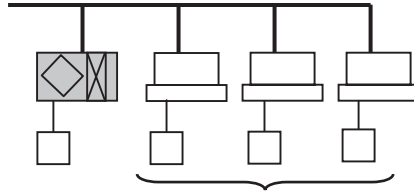

Give a function to select cooling/heating to either one of these.

### 1.4.2 Caution When Connecting with a VRVII System, Heat Recovery Type

When bringing the RA (exhaust gas intake) of this unit directly in from the ceiling, connect to a BS unit identical to the VRV indoor unit (master unit), and use group-linked operation.

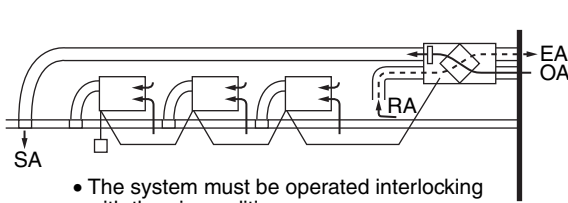

- The system must be operated interlocking with the air conditioner.

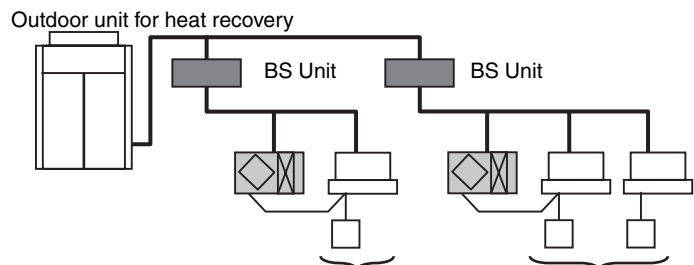

Give a function to select cooling/heating to either one of these.



**Caution**

If above setting is not made, the detection of correct temperature is not available and automatic judgment on proper cooling or heating can not be made when the temperature in the ceiling gets higher than indoor temperature. Poor heating or shortage of the amount of humidification may result.

If the indoor unit and this unit are installed with different BS system inevitably, always take following remedies (1) and (2).

- (1) RA (Exhaust and suction) of this unit is not taken directly from inside of the ceiling, connect the suction duct and suction grille to the fitting port of RA duct to suck the indoor air.

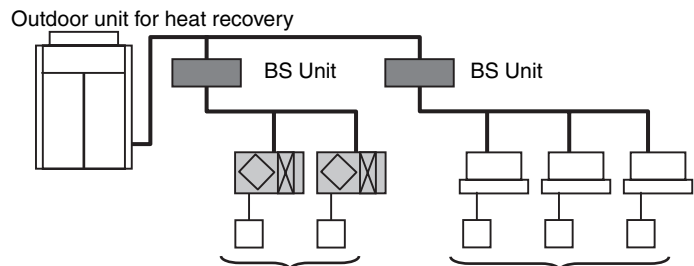
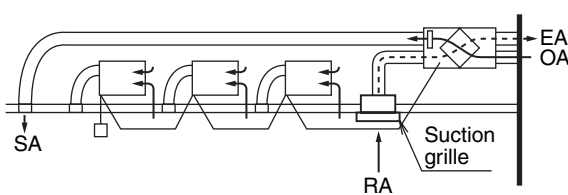

Give a function to select cooling/heating to either one of these.

- (2) Do not make the selection of heating or cooling in automatic mode and it shall be made by manual selection from remote controller or centralized controller.

### 1.4.3 Caution when Connecting the Indoor Unit Directly to the Duct

Follow the indications described below

- a) When connecting the indoor unit directly to the duct, always use the same system on the indoor unit as with the outdoor unit, perform group-linked operation, and make the direct duct connection settings from the remote controller. (Mode No. "17 (27)" – First code No. "5" – Second code No. "6".) Refer to 15.10.1 concerning setting method.

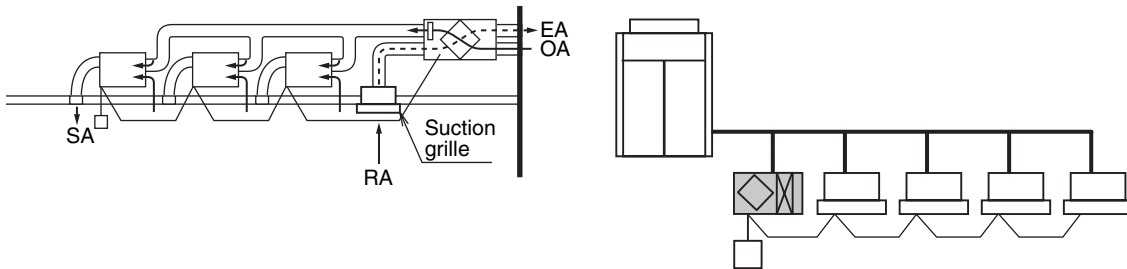

- b) Do not connect to the outlet side of the indoor unit. Depending on the fan strength and static pressure, the unit might back up.
- c) When it is connected to the suction side of indoor unit as a direct duct connection system, etc., since there is a possibility that the body thermo of the indoor unit detects erroneously SA discharge from this unit as indoor air, use the remote sensor (Optional).

# 1.5 Operation

## HRV ; Heat Reclaim Ventilation

- Carefully read this operation manual before using the total heat exchanger. It will tell you how to use the unit properly and help you if any trouble occurs. This manual explains about the indoor unit only. Use it along with the operation manual for the outdoor unit. After reading the manual, file it away for future reference.
- This unit is an option type for the VRV/II system air conditioner.  
It should normally be used in combination with the M-type VRV/II system indoor air conditioner. (RXYQ, REYQ, RXQ)  
It is also possible to use this unit as an independent system.
- This unit cannot control room temperature.  
If this is needed, do not install the HRV unit alone, but rather install another indoor unit.
- Use the remote controller of the VRV/II-system indoor air conditioner to control the unit.

### 1.5.1 What to do before Operation

This operation manual is for the following systems with standard control. Before initiating operation, contact your Daikin dealer for the operation that corresponds to your system type and mark.  
If your installation has a customized control system, ask your dealer for the operation that corresponds to your system.

#### Name of Parts

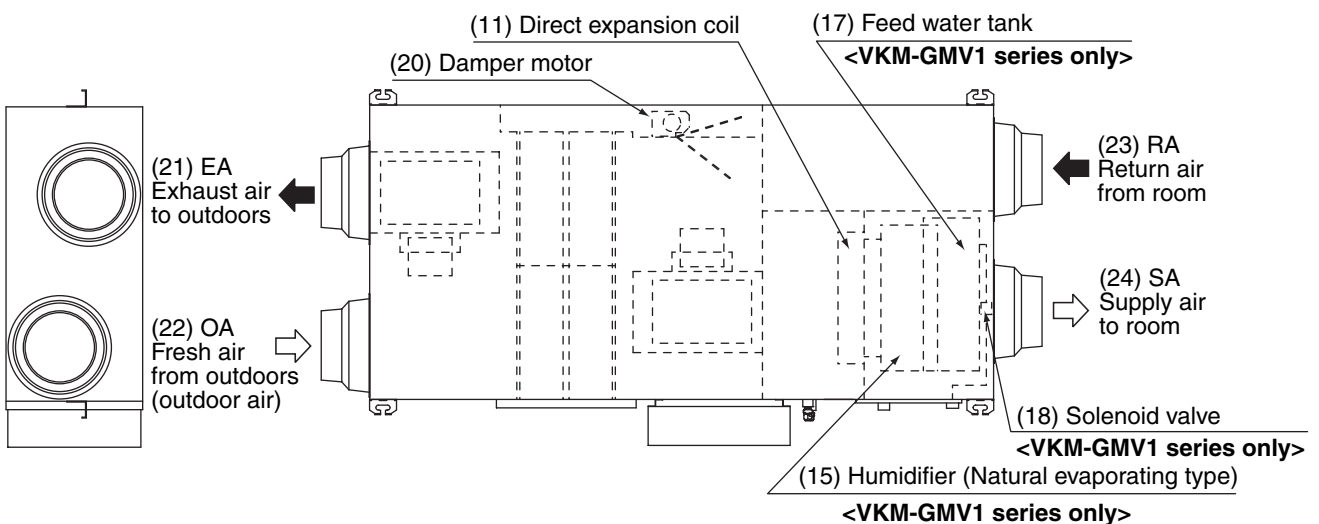
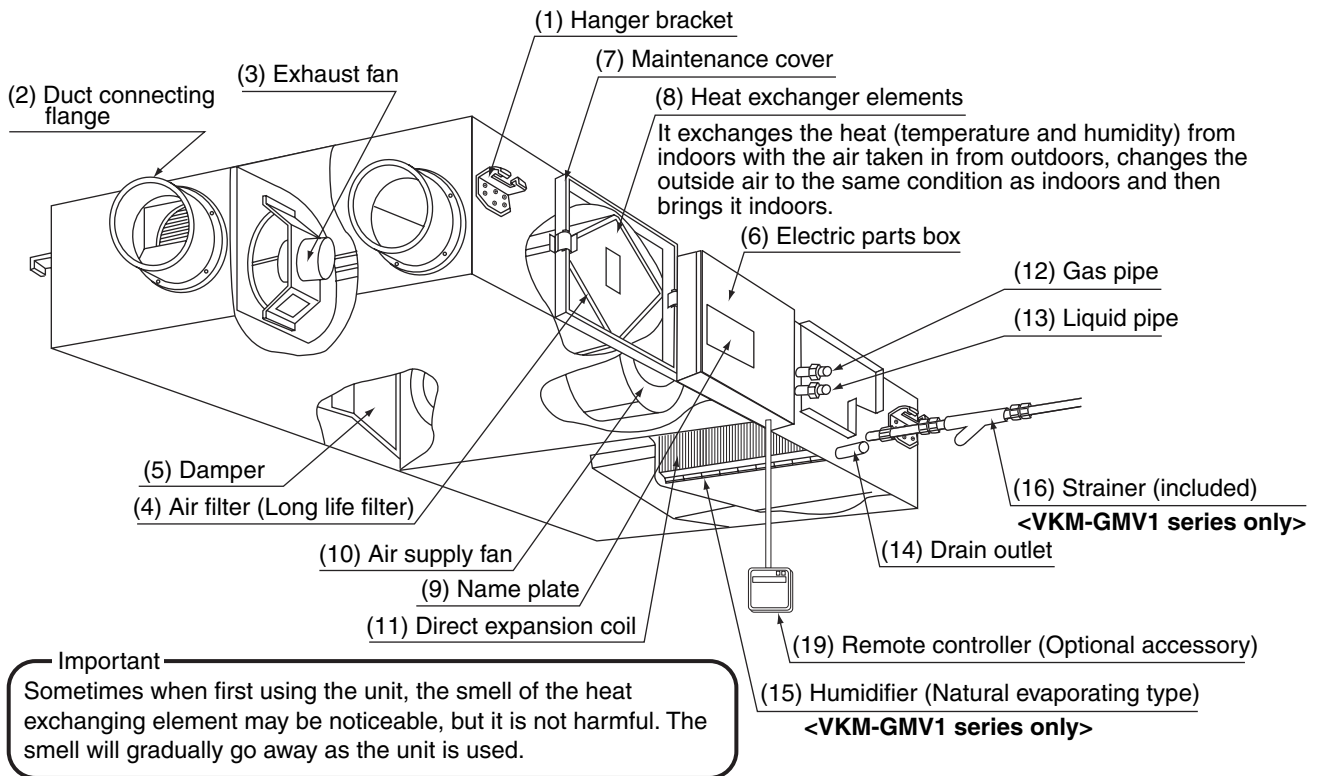

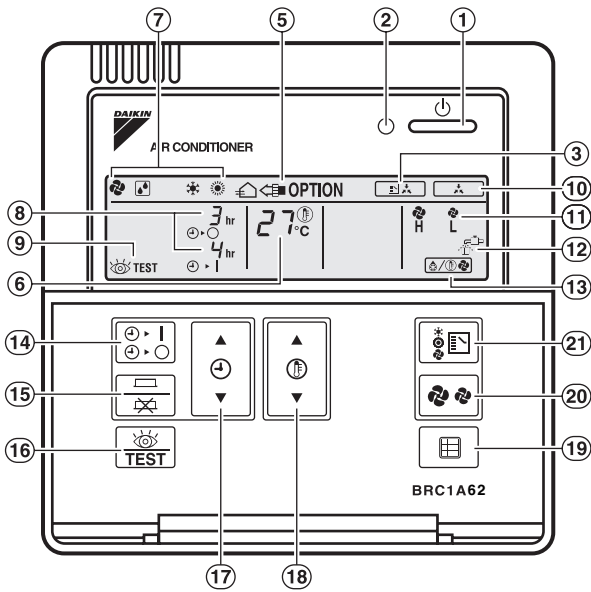

Remote Controller and Changeover Switch: Name and Function of Each Switch and Display

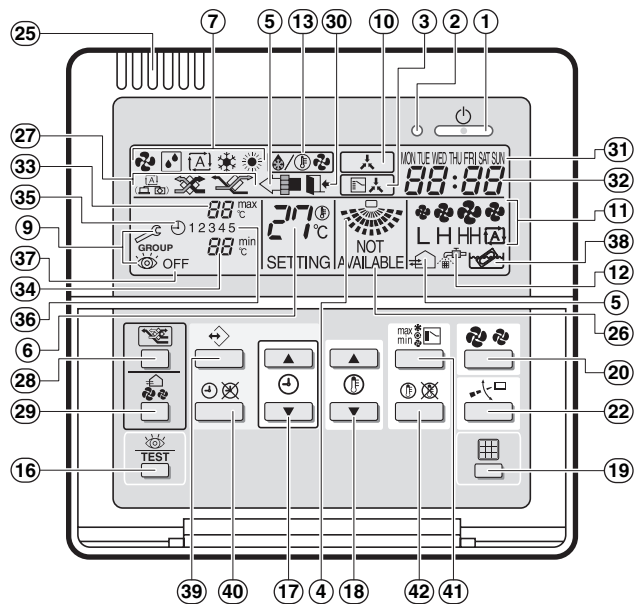
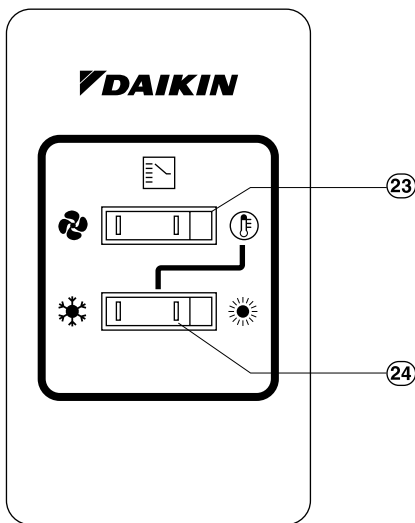

Remote control for VRV BRC1A62



Remote control for VKM BRC1D527 (EU only)





- Only the items marked with an asterisk (\* mark) are explanation relating to the functions and display of the unit. Unmarked items are functions of the combined air conditioners. When using buttons for functions which are not available (buttons which are not described in the text) will cause "NOT AVAILABLE" to be displayed. Contact your dealer for more detailed descriptions of those functions (buttons).
- 1. \*On/off button  
Press the button and the system will start. Press the button again and the system will stop.
- 2. \*Operation lamp (red)  
The lamp lights up during operation or blinks if a malfunction occurs.
- 3. \*Display "  " (changeover under control)  
May be displayed when combined with a VRV-system air conditioner. It is impossible to changeover heat/cool with the remote controller when this icon is displayed.
- 4. Display "  " (air flow flap)  
This displays the direction and mode of the air flow flap of the combined air conditioner.

**5. Display “ OPTION ” (ventilation/air cleaning)**

This display shows that the total heat exchange and the air cleaning unit are in operation. (these are optional accessories)

**6. Display “ ” (set temperature)**

This displays the set temperature of the combined air conditioner.  
It is not displayed when the unit is used as an independent system.

**7. Display “ ” “ ” “ ” “ ” “ ” (operation mode : “FAN, DRY, AUTOMATIC, COOLING, HEATING”).**

This displays the operating status of the combined air conditioner.

- There is no “heating” for the VRVII system (Cooling only type).
- “ ” is only available for systems operating in cooling and heating at the same time.

**8. \*Display “ ” (programmed time)**

This display shows the programmed time of the system start or stop.

**9. Display “ TEST ” (inspection/test operation)**

When the inspection/test operation button is pressed, the display shows the mode in which the system actually is.

- Do not use under usual use (service person/installer only).

**10. Display “ ” (under centralized control)**

When this display shows, the system is under centralized control. (This is not a standard specification.)

**11.\*Display “ ” (fan speed)**

This display shows the fan speed you have selected.

\*This is only displayed when the fan speed selection button is pressed. It normally displays the set fan strength of the combined air conditioner.

**12.\*Display “ ” (time to clean air filter)**

Refer to “1.4.3 HOW TO CLEAN THE AIR FILTER”.

**13.\*Display “ ” (defrost/hot start)**

It may be displayed when freezing of outdoor unit’s coil increases in heating mode. (Refer to page 28).

**14.\*Timer mode start/stop button**

Refer to the chapter “Operation procedure -

Programming start and stop of the system with timer.” (Refer to page 31)

**15.\*Timer on/off button**

Refer to the chapter “Operation procedure -

Programming start and stop of the system with timer.” (Refer to page 31)

**16.\*Inspection/test operation button**

Pressed during inspection or “test run.”

- Do not use under usual use. (service person/installer only)

**17.\*Programming time button**

Use this button for programming start and/or stop time.

**18. Temperature setting button**

Use this button for setting the desired temperature of air conditioner combined with this unit.

This button can’t use for this unit.

This unit can’t change temperature setting.

**19.\*Filter sign reset button**

Refer to “1.4.3 HOW TO CLEAN THE AIR FILTER”.

**20. Fan speed control button**

Press this button to select the fan speed of air conditioner combined with this unit.



**21.\*Operation mode selector button**

Press this button to select the operation mode of air conditioner combined with this unit.



**22. Air flow direction adjust button**

Press this button to select the air flow direction of air conditioner combined with this unit.

**23. Fan only/air conditioning selector switch**

Set the switch to “ ” for fan only operation or to “ ” for heating or cooling operation.

**24. Cool/heat changeover switch**

Set the switch to “ ” for cooling or to “ ” for heating operation.

**25. Remote controller thermo**

This detects the temperature around the remote controller. This is not the same as the temperature of return air from room (RA) by heat exchanger unit.

**26.\*Display “NOT AVAILABLE”**

- “NOT AVAILABLE” may be displayed for a few seconds if the function for the button pressed is not available for the unit or the air conditioner.
- “NOT AVAILABLE” is only displayed when none of the indoor units is equipped with the function in question when running several units simultaneously. It is not displayed if the function is available on even one of the units.

**27.\*Display “” “” “”**

This displays the ventilation mode. (BRC1D527 and so on.) (This is not displayed on the controller BRC1A62)

**28.\*Ventilation fan mode selector button (available only connecting the HRV unit)**

This is pressed to switch the fan mode of the HRV unit.

**29.\*Ventilation fan speed control button (available only connecting the HRV unit)**

This is pressed to control the fan speed of the HRV unit. (Refer to item 11)

**30.LEAVE HOME ICON “”**

The leave home icon shows the status of the leave home function.

ON	Leave home is enabled
FLASHING	Leave home is active
OFF	Leave home is disabled

**31.\*DAY OF THE WEEK INDICATOR “ MON TUE WED THU FRI SAT SUN ”**

The day of the week indicator shows the current week day (or the set day when reading or programming the schedule timer).

**32.\*CLOCK DISPLAY “  ”**

The clock display indicates the current time (or the action time when reading or programming the schedule timer).

**33.MAXIMUM SET TEMPERATURE “  max °C ”**

The maximum set temperature indicates the maximum set temperature when in limit operation.

**34.MINIMUM SET TEMPERATURE “  min °C ”**

The minimum set temperature indicates the minimum set temperature when in limit operation.

**35.\*SCHEDULE TIMER ICON “  ”**

This icon indicates that the schedule timer is enabled.

**36.\*ACTION ICONS “ 1 2 3 4 5 ”**

These icons indicate the actions for each day of the schedule timer.

**37.\*OFF ICON “OFF”**

This icon indicates that the OFF action is selected when programming the schedule timer.

**38.\*ELEMENT CLEANING TIME ICON “”**

This icon indicates the element must be cleaned ( “HRV” only).

**39.\*PROGRAMMING BUTTON “”**

This button is a multi-purpose button.

Depending on the previous manipulations of the user, the programming button can have various functions.

**40.\*SCHEDULE TIMER BUTTON “  ”**

This button enables or disables the schedule timer.

**41. OPERATION CHANGE/MIN-MAX BUTTON “  ”**

This button is a multi-purpose button. Depending on the previous manipulations of the user, it can have following functions:

1. select the operation mode of the installation (FAN, DRY, AUTOMATIC, COOLING, HEATING)
2. toggle between minimum temperature and maximum temperature when in limit operation

**42.SETPOINT/LIMIT BUTTON “  ”**

This button toggles between setpoint, limit operation or OFF (programming mode only).

**Note**

- In contradistinction to actual operating situations, the display on Figure 3 shows all possible indications.
- If the filter sign lamp lights up, clean the air filter as explained in the chapter “MAINTENANCE”. After cleaning and reinstalling the air filter: press the filter sign reset button on the remote controller. The filter sign lamp on the display will go out.
- Item 27~ Item 42 can be used with BRC1D527.  
In detail, refer to operation manual of the remote controller.
- Only the items marked with an asterisk (\* mark) are explanation relating to the functions and display of the unit. Unmarked items are functions of the combined air conditioners.



**Explanation for Systems**

This unit can be made a part of two different systems: as part of the combined operation system used together with VRVII SYSTEM Air Conditioners and as the independent system using only the HRV. An operating remote controller is required when using the unit as an independent system. Ask your dealer what kind of system your system is set up for before operation.

For the operation of the remote controller for indoor unit and centralized controller, refer to the instruction manual provided with each unit.

See the included operating manuals for details on how to operate each remote control.

**■ Operation for Each System**

**Sample system**

- Combined operation system with VRV systems

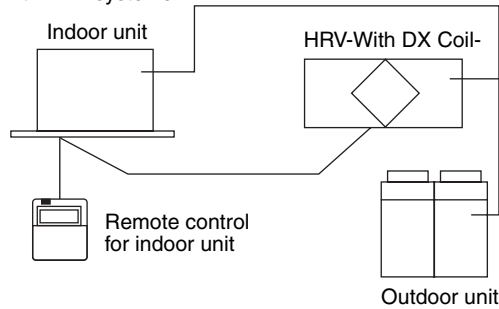

**Combined operation system with VRVII systems**

[Operation]

The air conditioner remote controller starts and stops the air conditioner and the HRV unit.

You can also select the ventilation amount and the ventilation mode.

During intermediate periods when only the HRV unit is used without the air conditioner, select “ventilation” with the operation selection button. (Refer to About Direct Duct Connection System)

**Sample system**

- Independent system

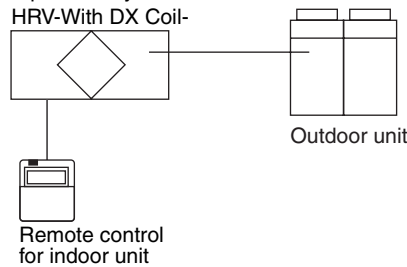

**Independent system**

[Operation]

The HRV unit can be started and stopped using the remote controller.

You can also select the ventilation amount and the ventilation mode.

**About Direct Duct Connection System**

**Installation Examples**

Direct duct connection system

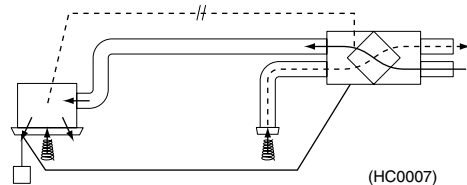

Independent duct system

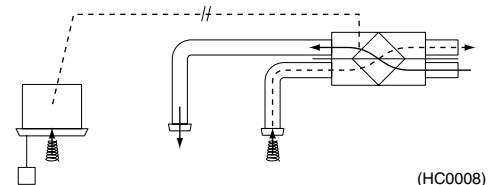

**Note**

- 1) The system must be operated interlocking with the air conditioners.
- 2) Do not connect the duct with discharge air side of indoor units.

The HRV unit cannot be operated independently when the air conditioner is connected to the HRV unit via a duct. When using the HRV unit, set the air conditioner to “fan” mode on weak fan strength.

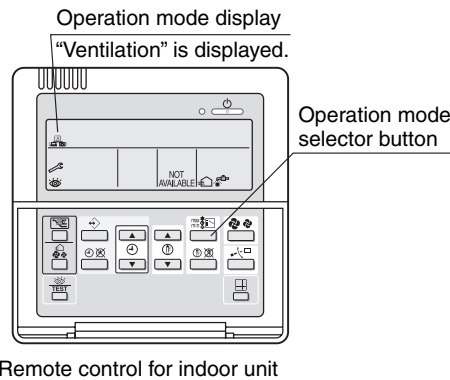

- Each time you press the operation selection button, the operation mode display will change as shown in the figure below.

**Example 1 :**

In case of the remote controller “BRC1D527” and as equivalent.  
Display changes as below.

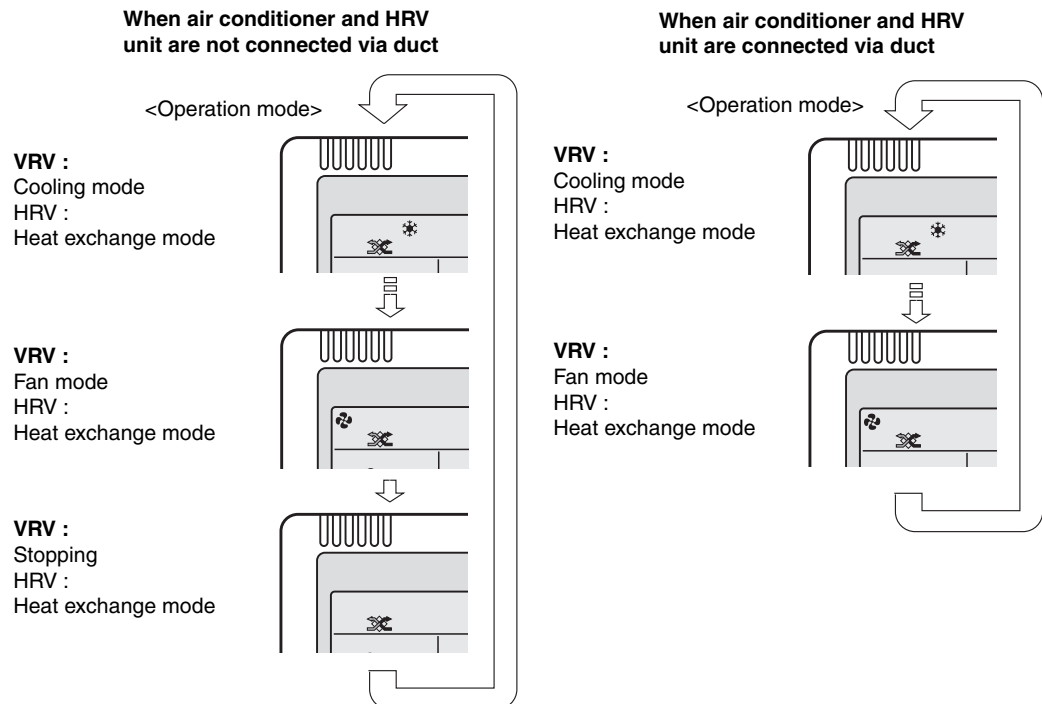

**NOTE) Current Ventilation mode can be visible and selected on the remote controller.**

**Example 2 :**  
**In case of the remote controller “BRC1A62”**  
**Display changes as below.**

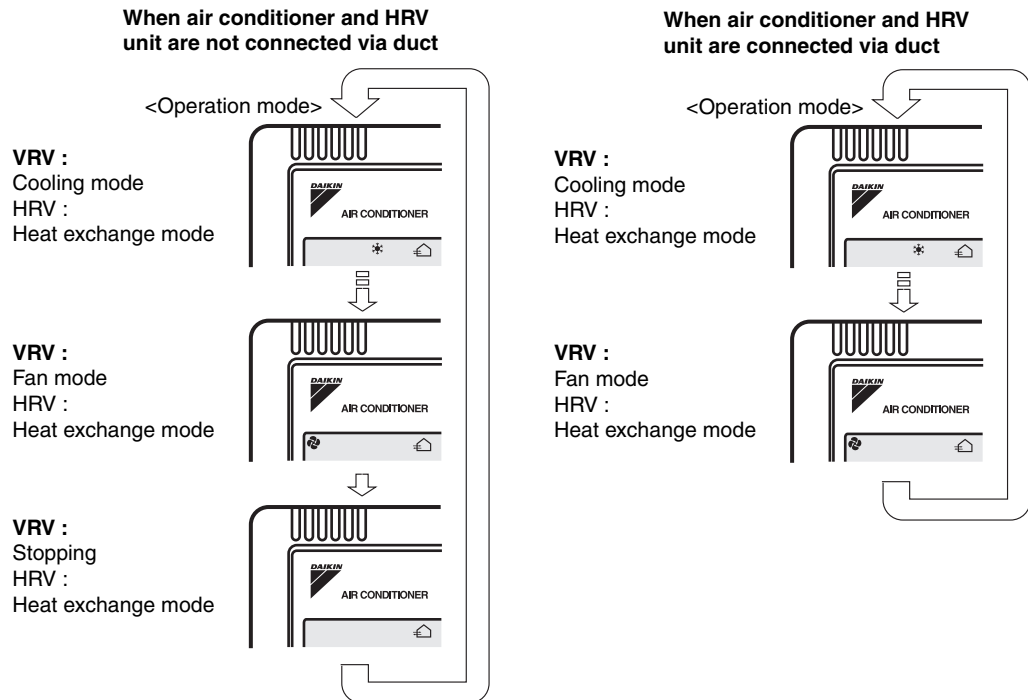

**NOTE) Current Ventilation mode doesn't be displayed.**

- When the display shows “” (time to clean air filter), ask a qualified service person to clean the filters (Refer to the chapter “MAINTENANCE”).

**Nighttime Free Cooling Operation <Automatic Heat Purge Function at Night>**

The nighttime free cooling operation is an energy-conserving function which works at night when the air conditioners is off, reducing the cooling load in the morning when the air conditioner is turned on by ventilating rooms which contain office equipment which raises the room temperature.

- Nighttime free cooling operation only works during cooling and when connected to Building Multi or VRV systems.
- Nighttime free cooling operation is set to “off” in the factory settings; so request your dealer to turn it on if you intend to use it.

**Operation image**

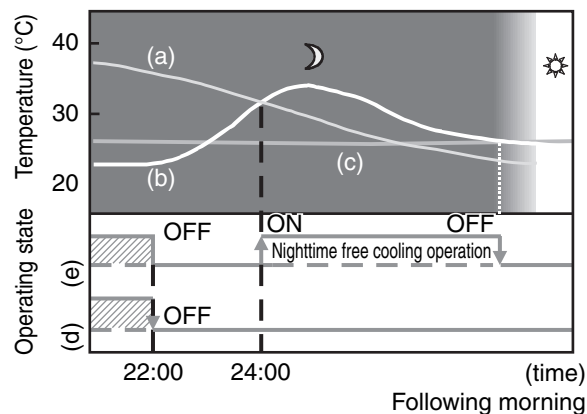

- (a) Outside temperature
- (b) Indoor temperature
- (c) Set temperature
- (d) Operating state of Air conditioner
- (e) Operating state of Total heat exchanger

**■ EXPLANATION OF NIGHTTIME FREE COOLING OPERATION IMAGE**

The unit compares the indoor and outdoor temperatures after the air conditioning operation stops for the night. If the following conditions are satisfied, the operation starts, and when the indoor temperature reaches the air conditioning setting, the operation stops.

## &lt;Conditions&gt;

1. the indoor temperature is higher than the air conditioning setting and
  2. the outdoor temperature is lower than the indoor temperature,
- If the above conditions are not satisfied, reevaluation is made every 60 minutes.

## 1.5.2 Operation Procedure

### Cooling, Heating and Fan Only Operation

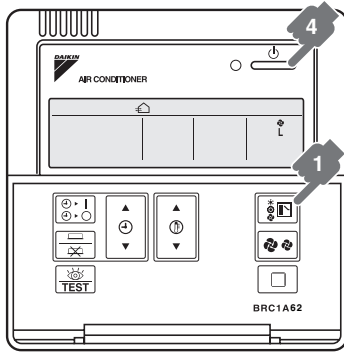

Remote control for VRV BRC1A62

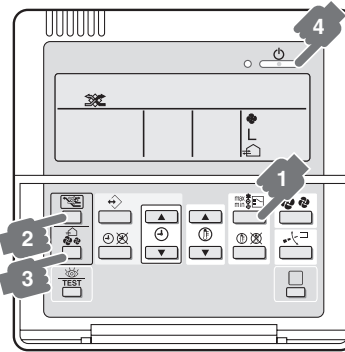

Remote control for VKM BRC1D527 (EU only)

#### [PREPARATIONS]

- To protect the unit, turn on the main power switch 6 hours before operation.  
Do not turn off the power during the heating or cooling season. This is to ensure smooth start-up.

- 1 Press the operation mode selector button several times and select the operation mode of your choice;

- “☀️” Cooling operation
- “🔥” Heating operation
- “🌀” Fan only operation

#### Note

- “A” can only be set for systems operating in cooling and heating at the same time.
- “☀️🔥” is displayed on all remote controllers when using the VRVII system cooling only type, but only “☀️” and “🌀” can be set.
- Select the operating mode on a remote controller on which “☀️🔥” is not displayed.
- “☀️” “🔥” and “A” (only for simultaneous cooling/heating systems) cannot be selected on remote controllers on which it is displayed. See page 29 if “☀️🔥” is displayed.

- 2 Press ventilation mode selector button if you wish to change the mode.  
The display rotates through the following selections every time the button is pressed.



#### Note

- Above is available only if the remote controller BRC1D527 is connected with this unit.
- It is unnecessary to change ventilation mode because the mode is already set to “automatic mode”.
- If you change this mode with BRC1A62, consult your dealer.

- 3 Press ventilation fan speed button if you wish to change the fan speed.  
The display rotates through the following selections every time the button is pressed.



After the selection, the ventilation fan speed display disappears.  
And the fan speed of the combined air conditioner regularly displays.

#### Note

- Above is available only if the remote controller BRC1D527 is connected with this unit.
- It is unnecessary to change four speed mode because the mode is already set to “Low” or “High” mode by the installer.
- If you want to know or change this mode with BRC1A62 consult your dealer.

- 4 Press the on/off button.  
The operation lamp lights up and the system starts operation.

**Stopping the system**







Press start/stop one more time. The operation lamp will go off. The unit will stop.

- After stopping operation, the fan may continue operating for up to a minute.
- The fan may stop, but this is not a malfunction.

**Note**

- Do not turn off the power immediately after operation stops. Wait at least 5 minutes.  
Not waiting may cause leaking or malfunction.
- Do not change operations suddenly.  
It can result not only in malfunction but also failure of switches or relays in the remote controller.
- Never press the button of the remote controller with a hard, pointed object.  
The remote controller may be damaged.

**EXPLANATION OF OPERATION MODE**

Cooling mode 	Heating mode 	Automatic mode 
While operating in ventilation mode, the unit adjusts the outside air to the indoor temperature and then brings it into the room.		It automatically selects “  ” or “  .
		<b>Fan mode</b>  It only operates in ventilation mode. The unit processes outside air using the heat exchanger element, but not the DX expansion coil.

**Note**



- This unit cannot control room temperature. If this is needed, do not install the HRV unit alone, but rather install another indoor unit.



**EXPLANATION OF VENTILATION MODE**

**Note**

- These icons below are displayed on the remote controller BRC1D527.

Automatic mode : When combined with a VRVII-system air conditioner

The unit automatically switches between “” and “” based on information from the VRVII system air conditioner (heating, cooling, fan, and set temperature) and information from the HRV unit (indoor and outdoor temperatures).

The unit automatically switches between “” and “” when it is combined with an air conditioner (Not produced by Daikin) and based on only the information from the HRV unit (indoor and outdoor temperatures) when the HRV unit is operating alone.

Total heat exchange mode : Outdoor air passes through the heat exchange element and heat exchanged air is sent into the room.

Bypass mode : In this mode outdoor air does not through the heat exchange element, but rather sent into the room as is.

**EXPLANATION OF HEATING OPERATION**

**Defrost operation**

- In heating operation, freezing of the outdoor unit coil increases. Heating capability decreases and the system goes into defrost operation.
- The remote controller will read “” until the hot air starts blowing.
- It returns to the heating operation again after 6 to 8 minutes (10 at the longest).
- During defrost operation, the fans of the unit continues driving (factory setting).  
The purpose of this is to maintain the amount of ventilation and humidifying.
- The change of the layout in the room should be examined when the cold draft from air supplying opening is feared.
- Though the fan can be stopped by the setting of remote controller.  
Do not stop the fan in the place where no ventilation by stopping the fan may cause the influence of diffusion of air which it is dirty and moisture into another room, or the inflow from outside the room. (outflow such as viruses from the sickroom, or smell leakage from the rest room, etc.)  
Contact your dealer for details.

**Hot start**

- The remote controller will read “” until the hot air starts blowing, e.g. at the start of heating operation.

### Setting the Master Remote Controller

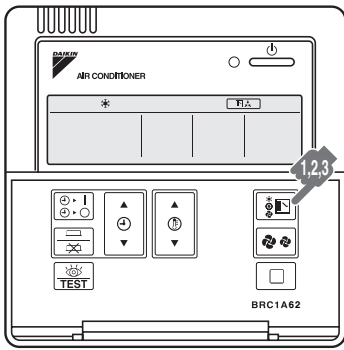

Remote control for VRV BRC1A62

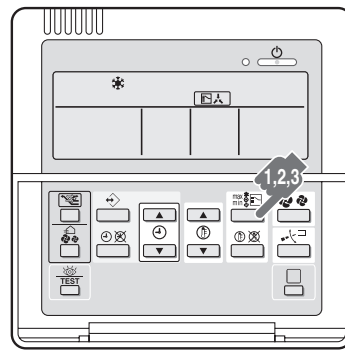

Remote control for VKM BRC1D527 (EU only)

- When the system is installed as shown below, it is necessary to designate one of the remote controllers as the master remote controller.
- Only the master remote controller can select cooling, heating, or automatic operation (the last only on VRV II system heat recovery type).
- The displays of slave remote controllers show “” (changeover under control) and they automatically follow the operation mode directed by the master remote controller.

However, it is possible to changeover to program dry with slave remote controllers if the system is in cooling operation set by the master remote controller.

(VRVII system heat pump type)

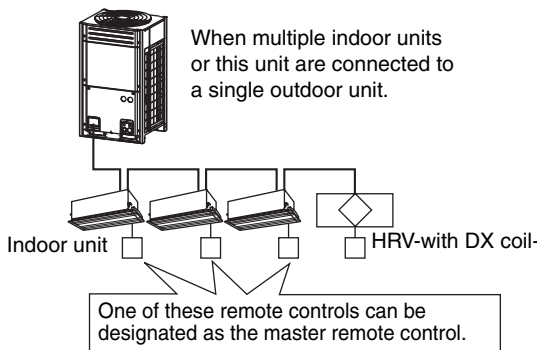

(VRVII system heat recovery type)

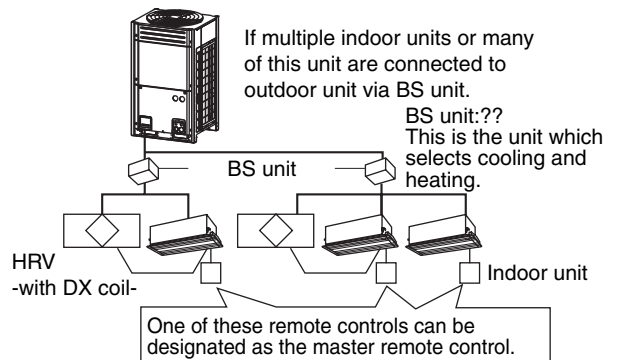

#### ■ HOW TO DESIGNATE THE MASTER REMOTE CONTROLLER





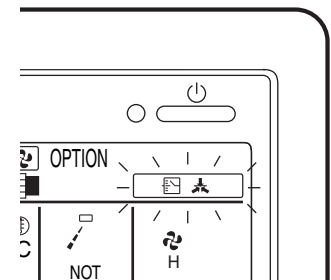

- Press the operation mode selector button of the current master remote controller for 4 seconds. The display showing “” (changeover under control) of all slave remote controllers connected to the same outdoor unit or BS unit flashes on.

  - “” flashes when the power is first turned on.
  - The ventilation mode can be changed regardless of the setting (main or slave).

**Note**

  - This unit cannot control room temperature. If the unit is connected to the same system with other indoor units, set the master remote controller on the other indoor units.



- Press the operation mode selector button of the controller that you wish to designate as the master remote controller. Then designation is completed. This remote controller is designated as the master remote controller and the display showing “” (changeover under control) vanishes. The displays of other remote controller show “” (changeover under control)
- Press the operation mode selector button on the master remote controller (i.e. a remote controller which does not display “”) to scroll through the modes. The display will scroll through “” – “” (only for simultaneous cooling/heating systems) – “” – “”.

The display on slave remote controllers will also change automatically.

**■ Details and activity of operation**

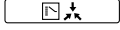
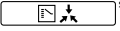
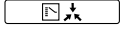
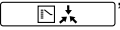
- Setting the master remote controller (without the “” display) to cooling/heating mode will make slave remote controllers (with the “” display) to follow to the mode of the master remote controller.  
Selection of fan mode is possible, however.
- Setting the master remote controller (without the “” display) to fan mode will make slave remote controllers (with the “” display) any setting other than fan mode impossible.

**Programming Start and Stop of the System with Timer**  
**How to Program and Set the Timer with the Remote Controller “BRC1A62”**

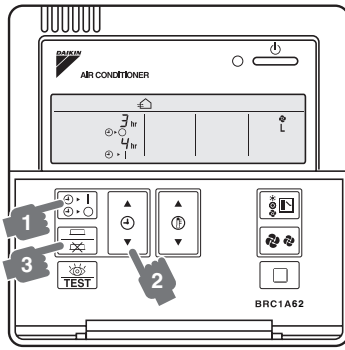

Remote control for VRV BRC1A62

- The timer is operated in the following two ways.  
 Programming the stop time “⏸▶○”. The system stops operating after the set time has elapsed.  
 Programming the start time “⏸▶|”. The system starts operating after the set time has elapsed.
- The start and the stop time can be simultaneously programmed.

- 1 Press the timer mode start/stop button “

- 2 Press the programming time button and set the time for stopping or starting the system.

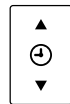

Each time this button is pressed, the time advances or goes backward by 1 hour.

- The timer can be programmed for a maximum of 72 hours.
- Each time when “▲” is pushed, the time advances one hour.  
 Each time when “▼” is pushed, the time goes back one hour.
- 3 Press the timer on/off button.
  - The timer setting procedure ends. The display “⏸▶○” or “⏸▶|” changes from flashing light to constant light.
  - After the timer is programmed, the display shows the remaining time.
  - For cancelling the timer operation, push the timer on/off button “

**Note**

- When setting the timer off and on at the same time, repeat the above procedure (from “1” to “3”) once again.

**■ DETAIL EXPLANATION**

**When you want to stop operation after a desired time,**

**Example :**

Set the time to “8”.

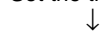

8hr  
 “⏸▶○” will display.

Stops operation 8 hours after the reservation is complete.

The program will be cleared after the operation stops.

- Set the stop time during operation.

**When you want to start operation after a desired time has elapsed**



**Example :**

Set the time to “8”.



“ 8hr ” will display.

Starts operation 8 hours after the reservation is complete.  
The reservation is cancelled after operation starts.

- Set the start time while the unit is stopped.
- The remaining time will count at the same time after reservation is complete.

See the example below if you want to reserve “off after time” and “on after time” at the same time.

**For example : (Refer to Fig. below)**

When the timer is programmed to stop the system after 3 hours and start the system after 4 hours, the system will stop after 3 hours and start 1 hour later.

**Example :**

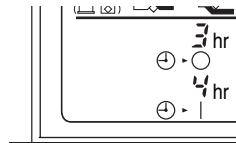

- Setting “off after 3 hours” and “on after 4 hours” will
- ↓
- Operation will stop after 3 hours.  
Operation will then start in 1 hour from the time it stopped.

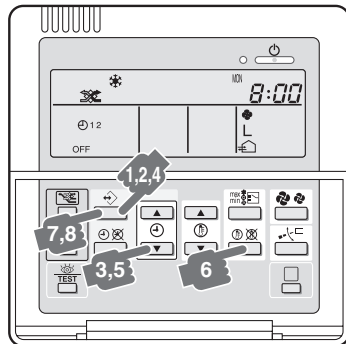

**How to Program and Set the Timer with the Remote Controller “BRC1D527”**





Remote control for VKM BRC1D527 (EU only)

- The controller is equipped with a schedule timer that enables the user to operate the installation automatically; setting the clock and day of the week is required to be able to use the schedule timer.
  - To set up clock, refer to the operation manual of the remote controller.
- 1 Browse to Monday by pressing the “ ↕ ” button.  
The “ ☉ ” icon appears, “ MON ” will blink and one of the “ 🌀🌧️🌬️☀️ ” icons, one of the “ 🏠🚿🚰 ” icons might be displayed but all other fields remain blank, indicating that no actions are programmed for Monday.
  - 2 Enter the program mode by holding down the “ ↕ ” button for 5 seconds, the “ ☉ ” icon will now blink too.
  - 3 Press the “ ↕ ” button to activate the first programmed action.  
A blinking “ 1 ” is displayed indicating that the first programmed action for Monday is being programmed ; The set temperature and clock display are blinking.
  - 3 Enter the time when the action must start using the “ ⏴⏵ ” & “ ⏴⏶ ” buttons (min. step = 10 minutes).
  - 4 Press the “ ↕ ” button to display the next programmed action. If a second action is programmed for Monday, “ MON ” will still be blinking and “ 1 2 ” will appear.  
Assuming that 5 actions were programmed for Monday, a total of 5 presses will be required to display all programmed actions.
  - 5 Enter the time when the action must stop using the “ ⏴⏵ ” & “ ⏴⏶ ” buttons (min. step = 10 minutes).
  - 6 Press the “ 🛑 ” button. “ OFF ” icon displays.  
This icon means the unit will stop at the set time.  
When all data for the schedule timer actions for Monday are entered, you must confirm the programmed actions.  
Make sure the last schedule timer action you want to keep is selected (schedule timer actions with a higher number will be deleted).



**Now you must choose between 2 options:****1. CONFIRM AND COPY TO NEXT DAY**

-  The schedule timer action programmed for the current day are also valid for the next day: use the “confirm last action and copy actions to next day” function by pressing the “” and “” buttons simultaneously for 5 seconds. “DAY OF THE WEEK INDICATOR” will change blinking from “MON” to “SUN”.

**2. CONFIRM ONLY**

-  The schedule timer action programmed for the current day are only valid for the selected day : use the “confirm last action and go to next day” function by pressing the “” button for 5 seconds. Program mode is quit and depending on the choice made, the programmed actions are saved for Monday (and possibly Tuesday).

**PROGRAMMING THE OTHER DAYS OF THE WEEK**

Programming the other days of the week is identical to programming the first day of the week. “TUE” is blinking to indicate the selected day, “” and “1” are steady if actions were copied from Monday to Tuesday, only “” is displayed if no actions were copied from Monday to Tuesday.

**Note**

The schedule timer will not :

- control fan speed,
- control air flow direction,
- control ventilation mode,
- control ventilation amount,
- change the operation mode for a scheduled setpoint.

The parameters listed above can be set manually, without interfering with the schedule timer.

**■ OPTIMUM OPERATION**

Observe the following precautions to ensure the system operates.

- **When the display shows “”, ask a qualified service person to clean the filters**
- **(Refer to MAINTENANCE).**
- **Do not operate the HRV unit in Bypass mode when the room air is under heating in winter or when the outside temperature is 30°C or higher.**  
This may cause condensation to form on the main unit or on discharge grill, or around air supply opening.
- **Keep the indoor unit and the remote controller at least 1 m away from televisions, radios, stereos, and other similar equipments.**  
This may cause distorted picture or noise.
- **Turn off the main power supply switch when it is not used for long periods of time. When the main power switch is turned on, some watts of electricity is being used even if the system is not operating.**  
Turn off the main power supply switch for saving energy. When reoperating, turn on the main power supply switch 6 hours before operation for smooth running.
- **Use city water or clean water and take steps to prevent condensation from forming. (VKM-GMV1 series only)**
- **The life of humidifier become shorter when the supply water is hard water. (VKM-GMV1 series only)**  
Use a water softener.
- **Do not install the remote controller where the indoor temperature and humidity, respectively, are out of the range of 0-35°C and RH 40-80%.**  
This may cause malfunction.
- **Do not install the remote controller where direct sunlight may fall on it.**  
This may cause discoloration or deformation.

**Note**

- When the fan motor fails, the remote controller does not display any error code.  
Usage under that status will lead to insufficient ventilation.  
The air supply and exhaust fans should be checked once every one or two months.  
You can make a simple check such as below way to check the wind flow, hold a bar of which the end has a string or other similar light weight item over the supply grille and exhaust grille.
- When the solenoid valve fails, the remote controller does not display any error code.  
Usage under that status will lead to insufficient humidification and increased tap water consumption.  
The solenoid valve should be checked at the beginning of the heating season. (VKM-GMV1 series only)



# Part 4

# Maintenance

1. Maintenance.....	36
1.1 Maintenance for The Air Filter .....	36
1.2 Maintenance for The Heat Exchange Element.....	38
2. Inspection and Maintenance of the Humidifier .....	39
2.1 For VKM-GMV1 Series.....	39
2.2 Replacing the Humidifier Element .....	42

# 1. Maintenance

## 1.1 Maintenance for The Air Filter



**Caution**

During operation, never check or clean the HRV. It may cause electrical shock and it is very dangerous to touch the rotating part. Be sure to turn off the OPERATION switch and disconnect the power.

■ **CLEANING FREQUENCY**

AT LEAST ONCE EVERY YEARS (FOR GENERAL OFFICE USE)  
(CLEAN THE ELEMENT MORE FREQUENTLY IF NECESSARY.)

1. Go into ceiling through the inspection hole, remove the hanging metals of maintenance cover and take it off.

VKM50~100G(M)

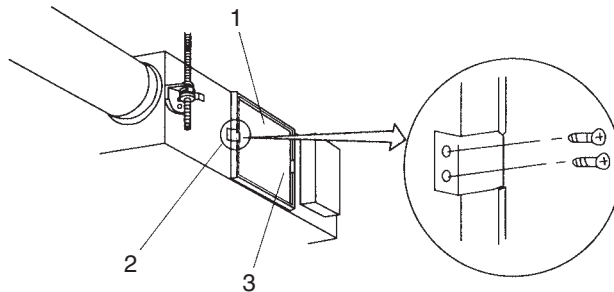

(HL003)

1	Maintenance Cover	2	Binding Metal
3	Hanging Metal		

2. Detach the air filter.  
Take out from the heat exchange elements.

VKM50~100G(M)

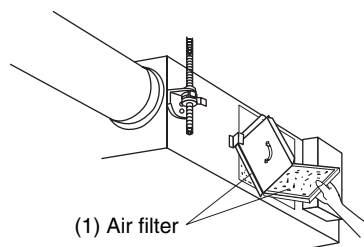

3. Clean the air filter.  
Use vacuum cleaner or wash the air filter with water.  
When the air filter is very dirty, use soft brush and neutral detergent.  
After cleaning, remove water and dry in the shade.

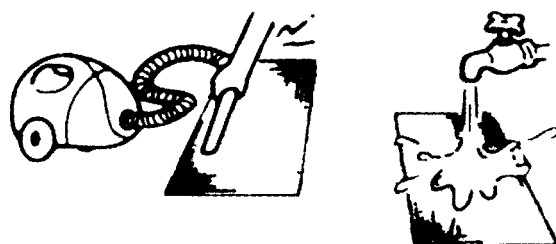

(HL015)

**Notes**

- Do not wash the air filter with hot water of more than 50°C, as doing so may result in discoloration and/or deformation.
- Do not expose the air filter to fire, as doing so may result in burning.
- Do not use gasoline, thinner, or other organic solvents.  
This may cause discoloration or deformation.

## 4. Fix the air filter.

If the air filter is washed, remove water completely and allow to dry Air filter for 20 to 30 minutes in the shade. When dried completely, install the air filter back in place.

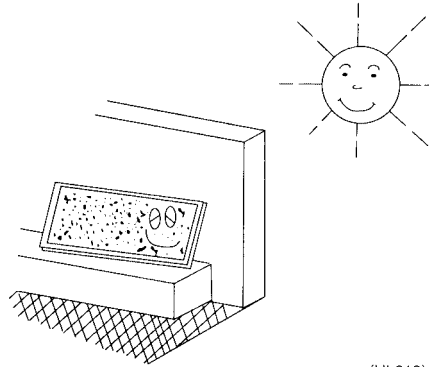

(HL018)

**Note**

- Be sure to install the air filter after servicing.  
(Missing air filter causes clogged heat exchange element.)  
The air filter is an optional item and the replacement is available.

## 5. Install the maintenance cover.

For remote controllers which display the filter sign, turn on the power after maintenance, and press the filter sign reset button.

\*See P83 if you want to change the time setting for when the filter sign “” goes on.

**Note**

- Do not remove the air filter except when cleaning.  
If the air filter is not used, heat exchange elements will be clogged, possibly causing poor performance and subsequent failure.

## 1.2 Maintenance for The Heat Exchange Element

### ■ CLEANING FREQUENCY

AT LEAST ONCE EVERY TWO YEARS (FOR GENERAL OFFICE USE)  
(CLEAN THE ELEMENT MORE FREQUENTLY IF NECESSARY.)

1. Use a vacuum cleaner to remove dust and foreign objects on the surface of the heat exchange element.
- Use the vacuum cleaner equipped with a brush on the tip of the suction nozzle.
- Lightly contact the brush on the surface of the heat exchanging element when cleaning. (Do not crush the heat exchange element while cleaning.)



### Caution

- Do not clean touching strongly with a vacuum cleaner. This may crush the mesh of the heat exchange elements.
  - Never wash the heat exchange element with water.
  - Have your dealer professionally clean the filter if it is very dirty.
2. Install the air filter securely in place.
  3. Put the heat exchange element on the rail and insert it securely in place.
  4. Install the maintenance cover securely in place.

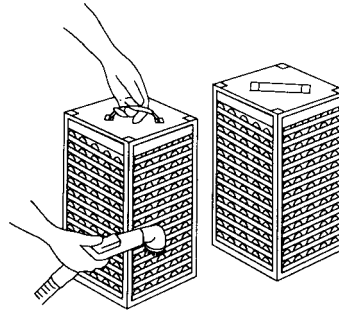

(HL060)

## 2. Inspection and Maintenance of the Humidifier

### 2.1 For VKM-GMV1 Series

In order to prevent harmful bacteria from generating, do maintenance on humidifying unit portion at the beginning or the end of the heating season.  
Following working is recommended once a year.



#### Warning

To clean the HRV, or maintenance be sure to stop operation and turn the power switch off. If may cause electrical shock and it is very dangerous to touch the rotating part

- At first make sure to close the water supply shut off valve and open the drain valve of the water supply piping.(Fig.1)
- Before all working, please cure a piping part and below product.

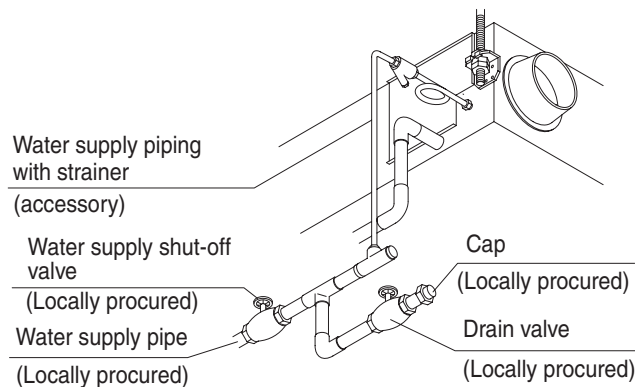

Fig.1

#### 2.1.1 Inspection of Strainer

##### Check for clogging, Check O-ring for cracks

1. Please loosen the cap of the strainer of a water supply entrance part.
2. Please take out and clean the element inside a strainer.(Fig.2)
3. Please attach an element as before after cleaning.
4. Please check whether there is any crack in O-ring.  
If there is any crack, change the O-ring to new one.

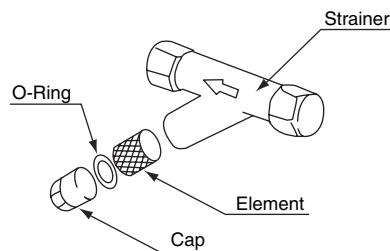

Fig.2



## 2.1.2 Inspection of the feed water tank

### Check for Dirt

1. Remove the maintenance cover.
2. Please loosen a mini valve and drain the water which has accumulated. (Fig.3)
3. Remove the cover of the feed water tank. (Fig.4)
4. Remove the hold plate. (Fig.4)
5. Pull out the Humidifier elements. (Fig.4)
6. Check inside the feed water tank
7. Please fasten a rag to the point of the long stick more than 85cm, and wipe off the contamination inside a feed water tank. (Fig.5)  
(The length to the depths of a water tank VKM50GMV1: 40cm, VKM80,100GMV1 73cm)



### Caution

Clean inside the feed water tank taking care not to pierce the float switch. It will break when strongly pushed.

### Check for Operation of Float Switch

<Please check whether there is any defect of operation by scale.>

When you raised and detach a float switch by hand, please check that a float switch falls. (Fig.6)

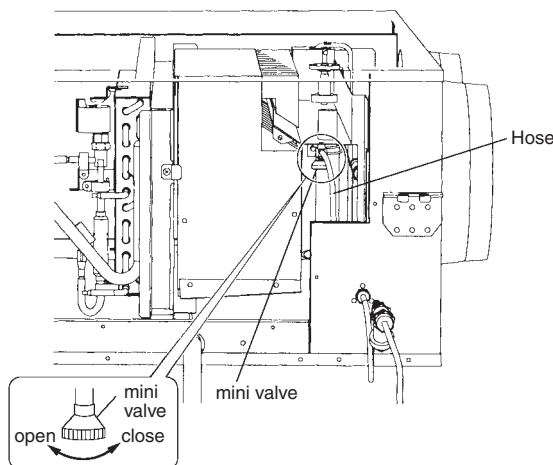

Fig. 3

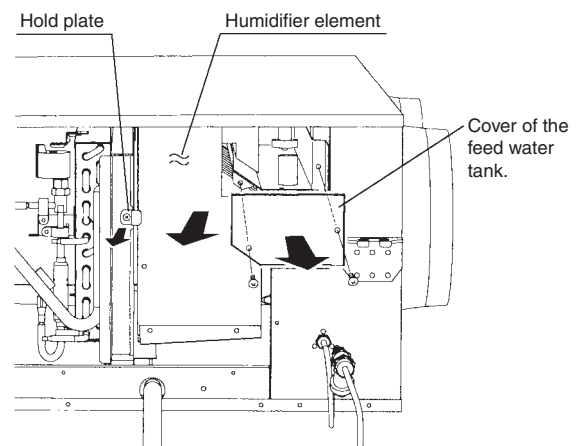

Fig. 4

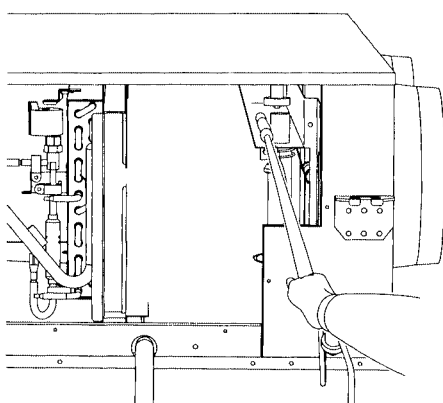

Fig. 5

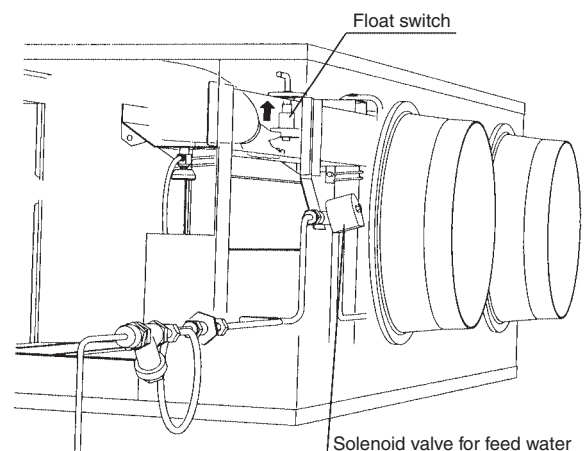

Fig. 6

### 2.1.3 Inspection of the Drain Pan

---

**Please check whether there is any foreign objects or contamination in drain pan**

1. Remove the maintenance cover.
2. Check whether there is any foreign objects or contamination in drain pan. Carefully check around the drain outlet.  
Wipe off inside of drain pan.
3. Please close a maintenance cover.

### 2.1.4 Inspection of the Solenoid Valve

When the solenoid valve fails, the remote controller does not display any error code. Usage under that status will lead to insufficient humidification and increased tap water consumption.

The solenoid valve should be checked at the beginning of heating season.

---

**Check for shutting and opening. Check in a similar fashion when checking the float switch operation.**

1. Check that the water supply piping is connected securely.
2. Open the water supply shut-off valve. (No water will be supplied at this time.)
3. Run the HRV unit in heating mode.  
(See the operating manual included with the indoor unit for details on how to run the unit in heating mode.)  
The water supply will start and the humidifier will begin operation.
4. After starting heating (humidifying), the sound of the water supply solenoid valve will be heard every 3 or 4 minutes (a clicking sound), so listening for that clicking sound let the unit run for 30 minutes to make sure that humidifying operation is normal.



**Caution**

If carpentry work is not completed when a test run is finished, tell the customer not to run the humidifier for the protection of indoor unit and HRV until it is completed. If the humidifier is run, paint, particles generated from adhesive and other materials used for carpentry work may cause HRV to get dirty, causing splash or leakage of water.

## 2.2 Replacing the Humidifier Element

---

### Replacing the Humidifier Element <VKM-GMV1 series only>

- The humidifier element needs to be replaced regularly.  
The humidifier element should in general be replaced once every three years when supply water is soft water, but outside factors (water quality, hard water, etc.) as well as operating conditions (24-hour-a-day air conditioning, etc.) may shorten its productive life.
- Contact your dealer if you have any questions.

Life of humidifying element is about 3 years (4,000 hours), under the supply water conditions of hardness : 150mg/l.

(Life of humidifying element is about 1 year (1,500 hours), under the supply water conditions of hardness : 400mg/l.)

Annual operating hours : 10 hours/day × 26 days / month × 5 month = 1,300 hours.

Contact your dealer for details.

Note : Breakage due to taking apart or cleaning inside by anyone other than our authorized dealers may not be included in the warranty.

# Part 5

# Control Functions

1. Control Functions .....	44
1.1 Explanation of individual Functions .....	44
1.2 Layout of switches on Printed Circuit Board.....	50

# 1. Control Functions

## 1.1 Explanation of individual Functions

### 1.1.1 Nighttime Free Cooling Operation

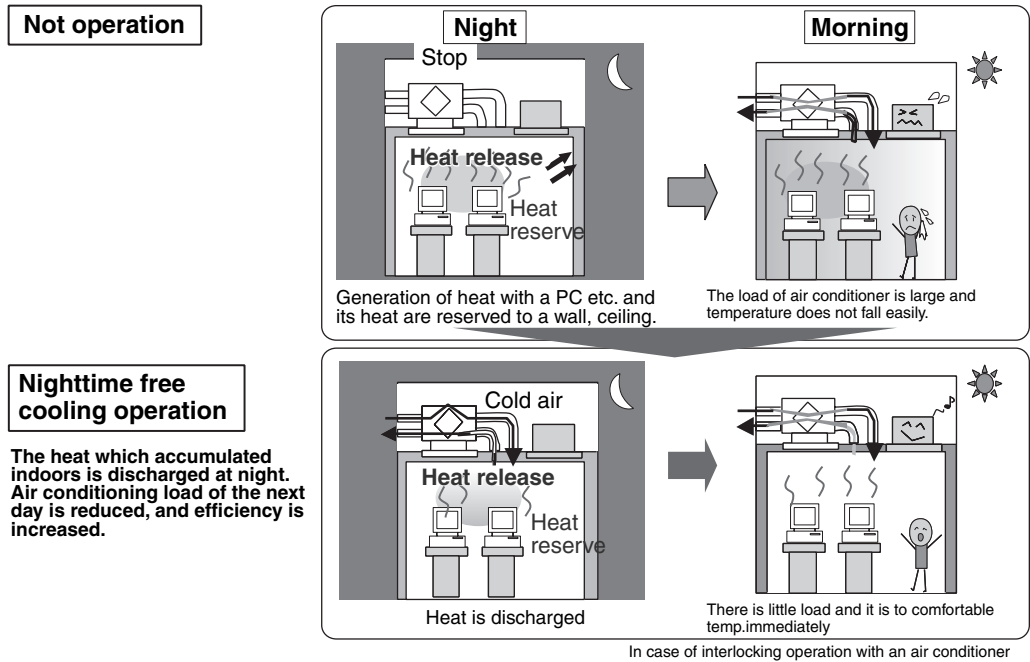

■ **Mechanism**

<Operation>

1. Interlocking operation is carried out with the air-conditioning machine, and the time of 2 hours passing after an operation stop is judged to be night. (The same judgment as the present preparatory operation)
2. After 2-hour progress, when indoor temperature is higher than the preset temperature of an air-conditioning machine and higher than outdoor temperature, operation is started.
3. Operation will be stopped if indoor temperature falls to air-conditioning machine preset temperature.

■ **Effect** (Field Setting by remote controller)

**It is reduction of about 5% of air-conditioning load at the time of cooling operation.**

Air conditioning operation carries out to April to October, and air-conditioning load is calculated only with sensible heat load.

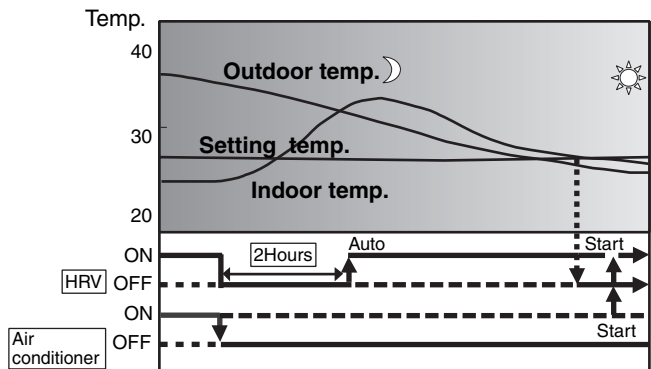

**Note:** Nighttime free cooling operation setting can be set using field setting mode remote controller. In detail, refer to page 83.

**Nighttime free cooling  
Operation <Flow chart>**

**Nighttime free cooling  
operating condition**

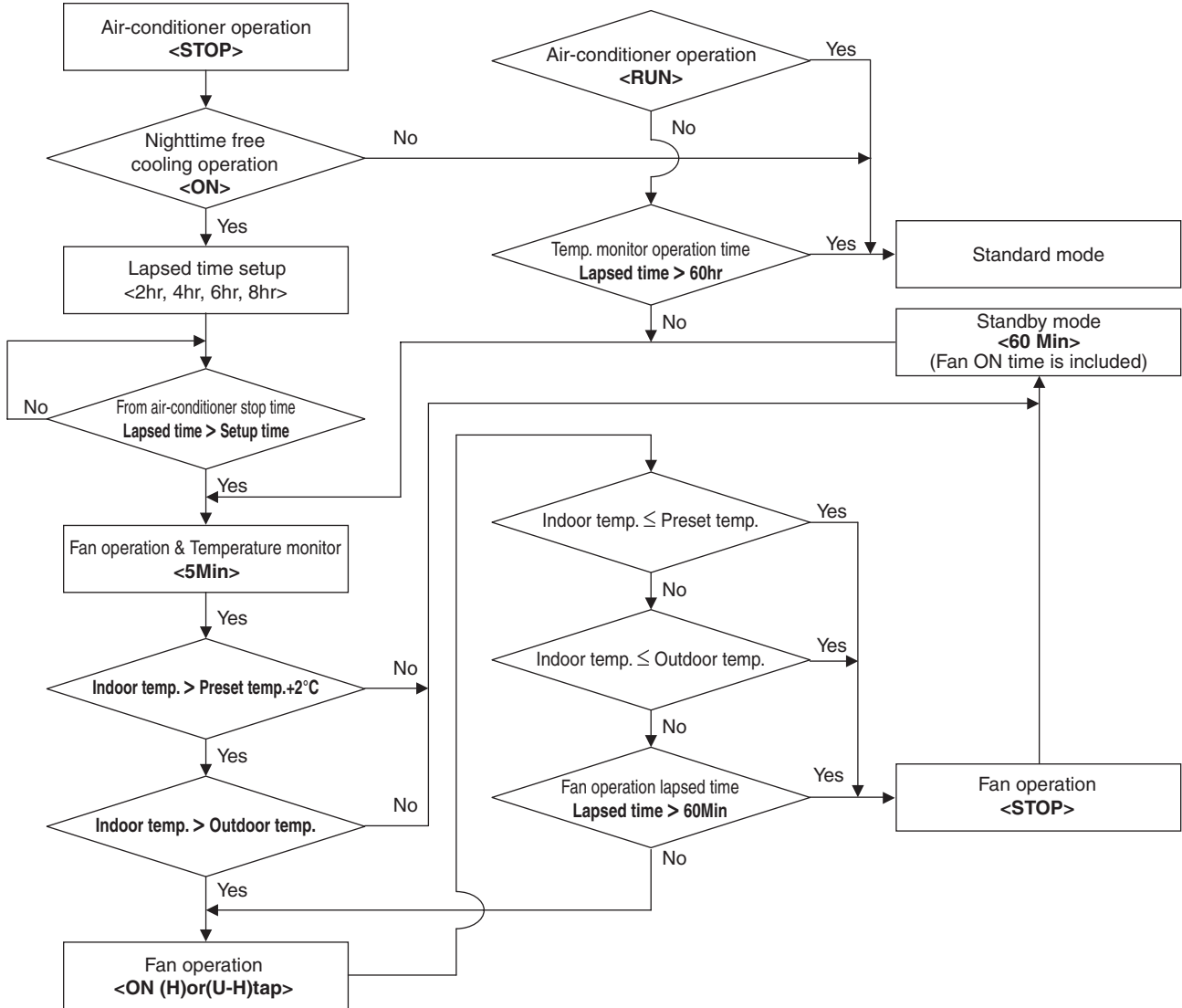

### 1.1.2 Cold Area Mode

Stops or lowers ventilation airflow during defrosting operation and compressor non-operating condition when equipment in heating mode, thus reducing heating load and cold air draft.

Operation chart (in heating operation only)

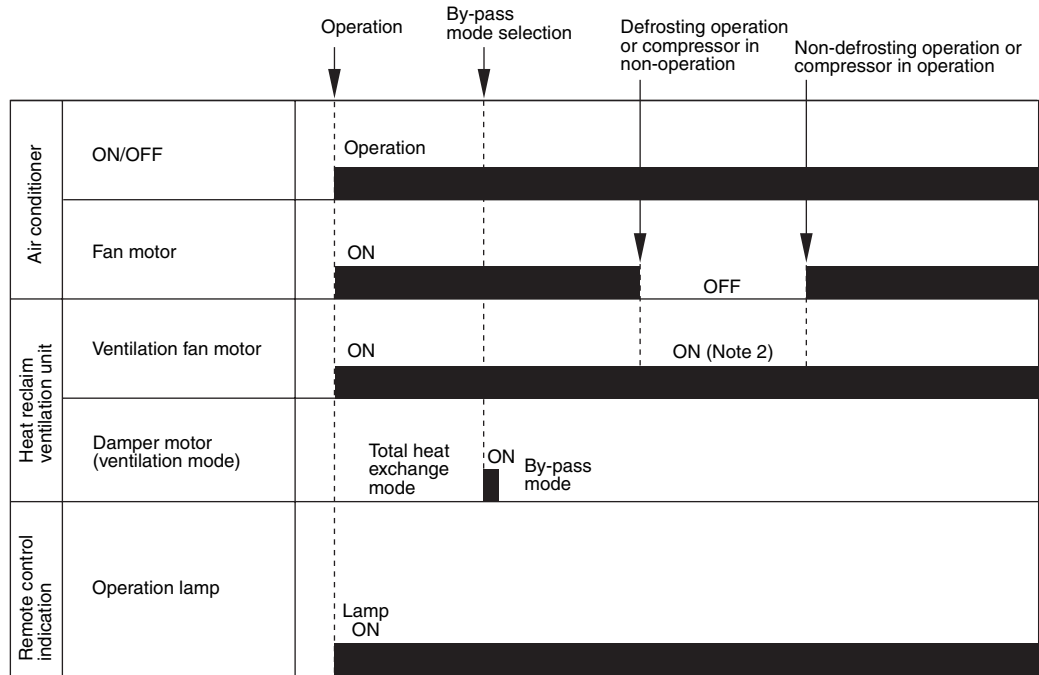

(HL023)

**i Note1:** Cold area mode can set using field setting mode of remote controller. In detail, refer to page 83.

**i Note2:** During defrost operation, the fans of the unit continues driving (factory setting). The purpose of this is to maintain the amount of ventilation and humidifying. Though the fan can be stopped by the setting of the remote controller. In detail, refer to page 83.

### 1.1.3 Automatic Selection of Ventilation Mode

Unlike the conventional total heat exchanger that only collects the heat on the exhaust air side to the air supply side, the VKM unit monitors the cooling/heating operation mode and the set temperature of air conditioners using microcomputer under the interlock control, and detects indoor and outdoor temperatures under the independent control. In other words, the VKM unit employs the automatic selection of the ventilation mode that automatically selects the total heat exchanger ventilation mode or the normal (bypass) ventilation, according to the monitoring aforementioned.

Operation automatically changes to the optimum pattern to suit conditions.

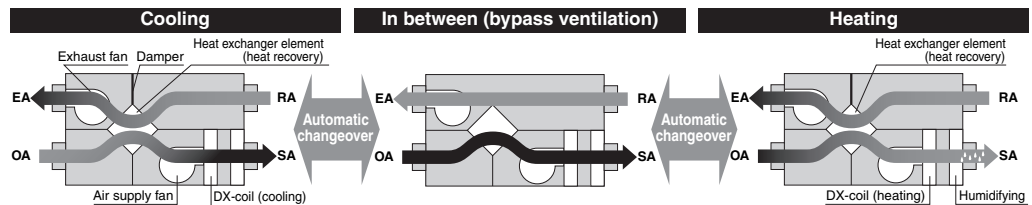

### 1.1.4 FRESH-UP Operation

Both the excessive supply mode and the excessive exhaust mode are selectable. This function creates a more comfortable air environment.

	Supply Fresh-up (Excessive outdoor air supply)	Exhaust Fresh-up (Excessive exhaust air supply)
Detail	Supply air volume can be set at a higher level than the exhaust air by the remote controller.	Exhaust air volume can be set at a higher level than the supply air by the remote controller.
Major effects	<ul style="list-style-type: none"> <li>Prevents inflow of toilet odor</li> <li>Prevents inflow of outdoor air in winter</li> </ul>	<ul style="list-style-type: none"> <li>Prevents outflow of airborne bacteria from rooms in a hospital</li> <li>Prevents outflow of odors from rooms in a nursing home</li> </ul>
Application	Offices, etc.	Hospitals, Nursing homes, etc.
Example		

#### Essential Setting Changes

- Setting changes should be made in the following way.
  - Mode No. : 18 (group tie up) or 28
  - Setting switch No.7
  - Setting position No.1~No.4
  - Refer to page 83.



## 1.1.5 Air Conditioner Link Operation

Link system enables simultaneous ON/OFF operation of heat reclaim ventilation unit and air conditioner (VRV system, Skyair).

### 1) 1 group link control

- Allows simultaneous ON/OFF from remote controller for air conditioner.
- Allows independent operation of heat reclaim ventilation unit from VRV-system remote controller during interim periods (not possible when direct duct connection is used).
- ON/OFF operation is not possible from LCD remote controller of heat reclaim ventilation unit.

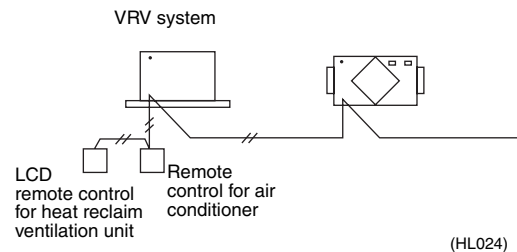

### 2) Link control of 2 or more groups (zone link)

- Heat reclaim ventilation unit can be operated when one or more air conditioners are operating.
- Allows independent operation of heat reclaim ventilation unit from VRV-system remote controller during interim periods (direct duct connection is not allowed in this system).
- ON/OFF operation is not possible from LCD remote controller of heat reclaim ventilation unit.

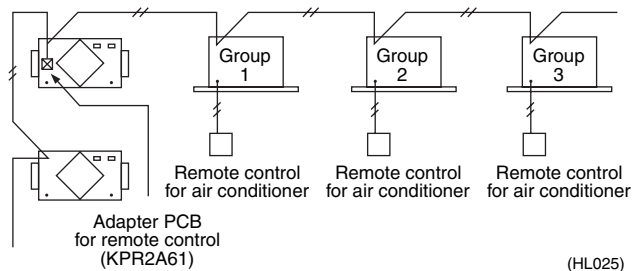

**Note:** With Super Wiring, units of different outdoor systems can be linked in operation.

## 1.1.6 External Damper Operation (FIELD SUPPLY)

### Explanation of Functions

Intake of outdoor air can be prevented when HRV is switched OFF if this damper is incorporated in the system.

1. The total heat exchanger's main unit print board supplies power for external damper.

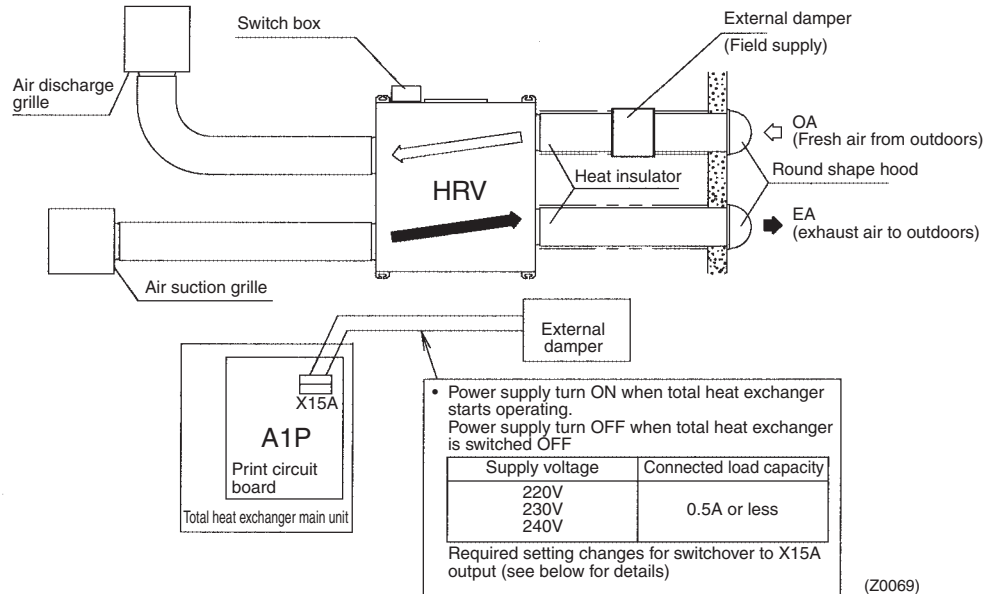

### Essential Wiring

1. Connect one end of the harness to the X15A on the print board and the other end to the harness leading to the damper via a connector such as a closed connector.  
With regard to closed connector, select one that suits wire diameter.  
Note: Location of X15A: Refer to next page.

### Essential Setting Changes

The X15A output is at the default setting and is not in operation, so the output setting should be changed at the LCD of the remote controller.

- Setting changes should be made in the following way.
  - Mode No.: 18 (group tie up) or 28 (per each unit)
  - Setting switch No.: 3
  - Setting position No.: 03
  - In detail, refer to page 83.

# 1.2 Layout of switches on Printed Circuit Board

## 1.2.1 Printed Circuit Board

[A1P~A3P]

VKM-GMV1

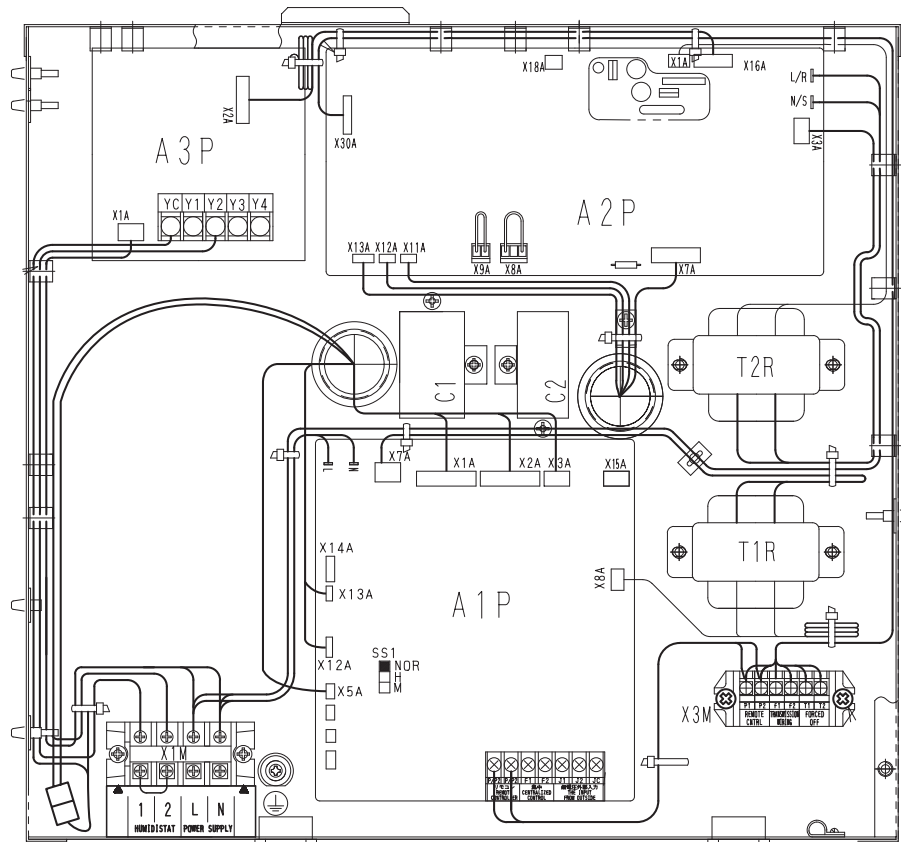

2P130159F

VKM-GV1

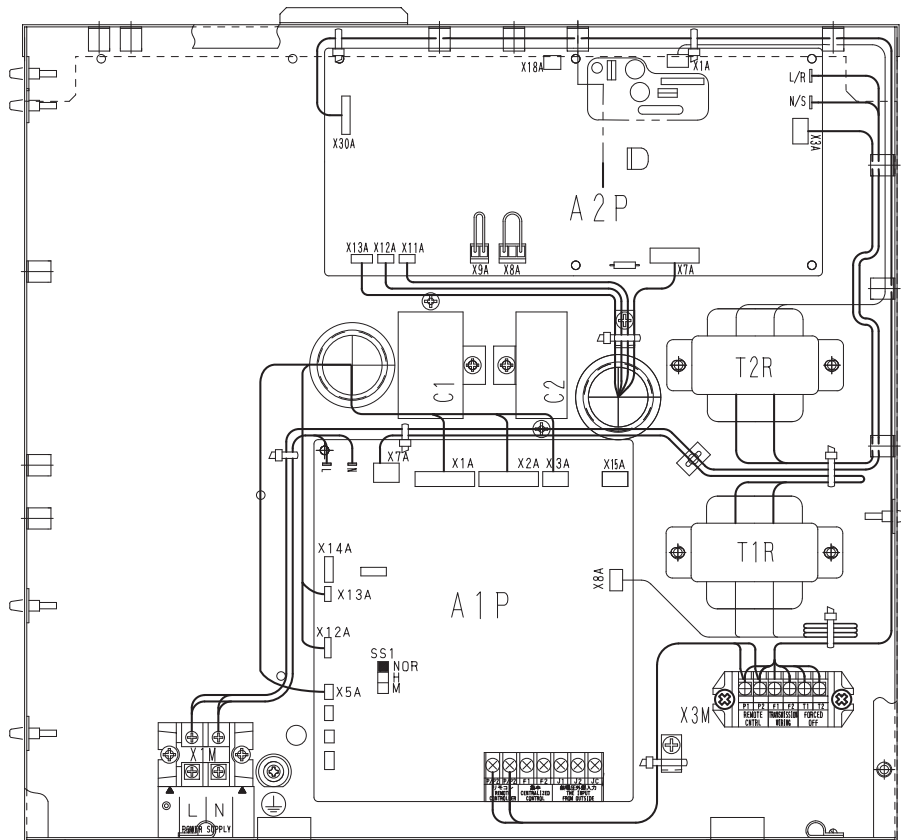

2P124140C

# Part 6

## Troubleshooting

1. Troubleshooting by Remote Controller .....	52
1.1 The INSPECTION / TEST Button.....	52
1.2 Self-diagnosis by Wired Remote Controller .....	53
2. Troubleshooting .....	54
2.1 Error Code Indication .....	54
2.2 Operation of The Remote Controller's Inspection / Test Operation Button .....	55
2.3 Indoor Air Thermistor Error.....	56
2.4 Outdoor Air Thermistor Error.....	57
2.5 Damper System Error (Alarm).....	58
2.6 Damper System Error (Alarm).....	59
2.7 "R1" Indoor Unit: PC Board Defect.....	60
2.8 "R3" Indoor Unit: Malfunction of Moving Part of Electronic Expansion Valve (20E) .....	61
2.9 "C4" Indoor Unit: Malfunction of Thermistor (R4T) for Heat Exchanger.....	62
2.10 "C5" Indoor Unit: Malfunction of Thermistor (R5T) for Gas Pipes.....	63
2.11 "C9" Indoor Unit: Malfunction of Thermistor (R3T) for Suction Air.....	64
2.12 "U3" Check Operation not executed .....	65
2.13 Dedicated LCD Remote Controller.....	66
2.14 Data Transmission Error (Between LCD Remote Controller and Main Unit) .....	67
2.15 "U5" Malfunction of Transmission Between Remote Controller and Indoor Unit .....	68
2.16 "U8" Malfunction of Transmission Between Master and Slave Remote Controllers .....	69
2.17 "UR" Excessive Number of Indoor Units .....	70
2.18 "UL" Address Duplication of Central Remote Controller .....	71
2.19 "UE" Malfunction of Transmission Between Central Remote Controller and Indoor Unit .....	72
2.20 "UE" Malfunction of Transmission Between Central Remote Controller and Indoor Unit .....	74
2.21 Main Unit PCB Assembly .....	75
2.22 Thermistor .....	76
2.23 Power Transformer.....	78
2.24 Damper Motor .....	79

# 1. Troubleshooting by Remote Controller

## 1.1 The INSPECTION / TEST Button

The following modes can be selected by using the [Inspection/Test Operation] button on the remote control.

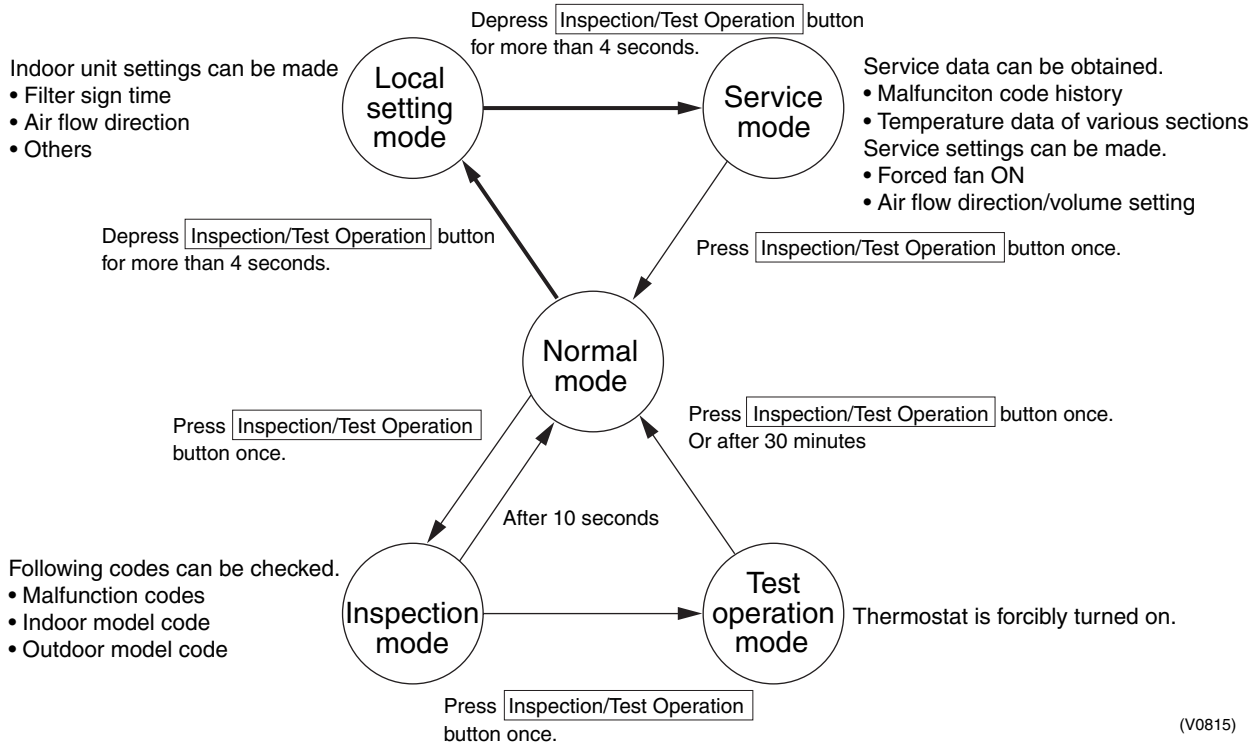

## 1.2 Self-diagnosis by Wired Remote Controller

### Explanation

If operation stops due to malfunction, the remote controller's operation LED blinks, and malfunction code is displayed. (Even if stop operation is carried out, malfunction contents are displayed when the inspection mode is entered.) The malfunction code enables you to tell what kind of malfunction caused operation to stop. See page 54 for malfunction code and malfunction contents.

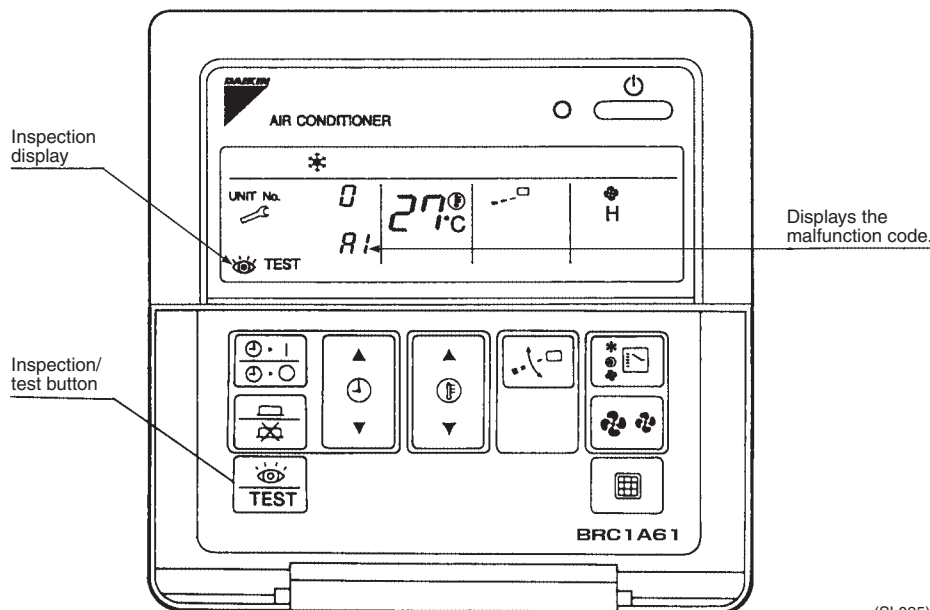

(SL025)

## 2. Troubleshooting

### 2.1 Error Code Indication

When an abnormality is generated, take necessary measures by referring to displayed error code.

After the cause of abnormality is removed, operate equipment and check proper functioning.

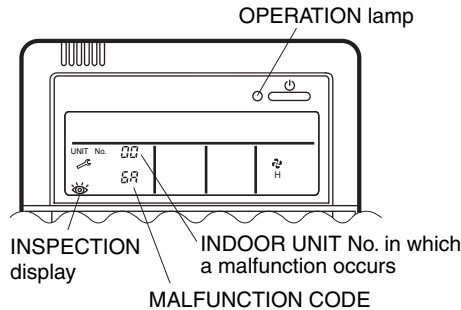

List of malfunction codes of Remote controller of the HRV-system

Operation lamp	Inspection indicator	Unit No.	Malfunction code	Description	Page
On	Off	Blinking		Indoor air thermistor malfunction	56
On	Off	Blinking		Outdoor air thermistor malfunction	57
On	Off	Blinking		Dumper-related malfunction	58
Blinking	Blinking	Blinking	6A	Dumper-related malfunction+thermistor malfunction	59
Blinking	Blinking	Blinking	A1	Printed circuit board fault	60
On	Off	Blinking		Printed circuit board fault	60
Blinking	Blinking	Blinking	A9	Electric expansion valve drive error	61
Blinking	Blinking	Blinking	C4	Liquid piping thermistor (R4T) error (faulty connection, disconnection short circuit, fault)	62
Blinking	Blinking	Blinking	C5	Gas piping thermistor (R5T) error (faulty connection, cut wire, short circuit, fault)	63
Blinking	Blinking	Blinking	C9	Intake air into coil thermistor (R3T) error (faulty connection, disconnection, short circuit, fault)	64
Blinking	Blinking	Blinking	U3	Test run not performed	65
Blinking	Blinking	Blinking	U5	Transmission error between the unit and remote controller	67
Off	Blinking	Off	U5	Setting error of remote controller	68
Off	Blinking	Off	U8	Transmission error between main remote controller and sub remote controller	69
Off	Blinking	Blinking	UA	Incorrect combination with indoor unit and remote controller.	70
On	Blinking	On		Central control address over lapping	71
Blinking	Blinking	Blinking	UE	Transmission error between the unit and centralized controller	72

In case of the malfunction with the code in white letters on the black background in the unit still operates.

However, be sure to have it inspected and repaired and as soon as possible.

If other than above error codes are displayed, there is a possibility that the problem in question has occurred with a combined air conditioner or outdoor unit. See the operation manuals included with the air conditioners or outdoor units for details.

## 2.2 Operation of The Remote Controller's Inspection / Test Operation Button

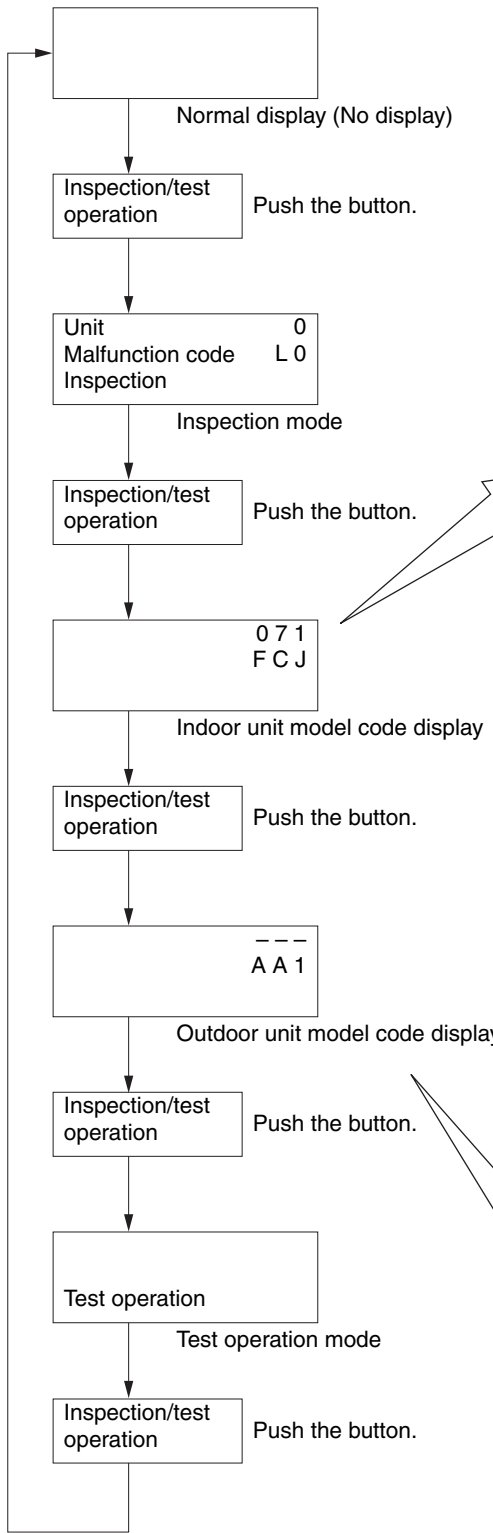

Unit 0  
Malfunction code L0  
Inspection

Malfunction code blinks when a malfunction occurs.

Example of capacity code display

Example model	Display
FXCQ25	028
FXFQ63	071
VKM50G (M) V1	028
VKM80G (M) V1	045
VKM100G (M) V1	056

0 7 1... Capacity code  
F... Indoor unit system code  
C... Indoor unit type code  
J... Progression code

Indoor unit system code

Display	Product classification	System classification
1	VRV system	(VAV indoor unit)
2	VRV system	Outdoor air processing unit HRV (VKM)
F	VRV system	Standard indoor unit
H	VRV system	New ceiling suspended cassette

Indoor unit type code

Display	Type	Model
A	Wall mounted	FXAQ
C	Double flow	FXCQ
E	Corner	FXKQ
F	Multi flow	FXFQ
H	Ceiling suspended	FXHQ
J	Built-in	FXSQ
L	Floor standing	FXLQ
P	Concealed ceiling duct	FXMQ, VKM (HRV)
L	Concealed floor standing type	FXNQ
6	Multi flow 600x600	FXZQ
3	Slim Ceiling mounted duct	FXDQ
5	New ceiling suspended cassette	FXUQ

Outdoor model code

Display	Type	Model
A A 1	VRV System Inverter K Series	RSXYYP
A A 3	R407C VRV PLUS Series	RXYYP
A 9 2	VRV Heat Recovery Series	RSEYP
A A 5	High COP type R407C L Series	RSXYYP-L
A A A	VRV II	RXYQ-M

(V2775)



## 2.3 Indoor Air Thermistor Error

<b>Remote Controller LCD Display</b>	Error Code <b>54</b> Inspection — Unit No.
<b>LED Indication</b>	Remote Controller  Main Unit
<b>Error Detection Method</b>	Temperature detected by inside air temperature sensor is used to detect errors.
<b>Error Generating Conditions</b>	When value detected by inside air temperature sensor is -40°C or below (open circuit) or 70°C or higher (short-circuit).
<b>Possible Causes</b>	<ul style="list-style-type: none"> <li>■ Faulty sensor</li> <li>■ Broken wire</li> <li>■ Faulty control PCB (A1P)</li> <li>■ Faulty contact in connector</li> </ul>

### Troubleshooting



**Caution**

Be sure to turn off power switch before connect or disconnect connector, or parts damage may be occurred.

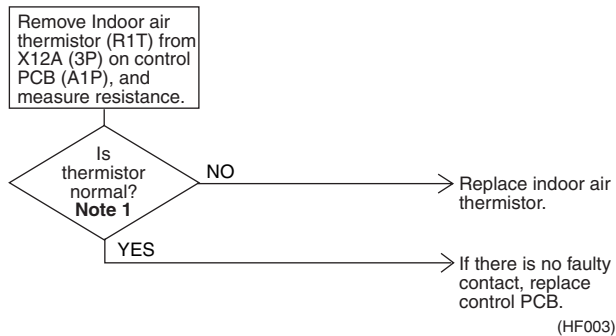

**Note:**

**Note 1:**

Refer to the thermistor temperature - resistance conversion table when measuring resistance.

Thermistor temperature - resistance conversion table

Thermistor temperature	Sensor resistance	Thermistor temperature	Sensor resistance
-10°C or less	108kΩ or more	22°C	Approx. 23kΩ
-5°C	Approx. 85kΩ	24°C	Approx. 21kΩ
0°C	Approx. 66kΩ	26°C	Approx. 19kΩ
5°C	Approx. 51kΩ	28°C	Approx. 18kΩ
10°C	Approx. 40kΩ	30°C	Approx. 16kΩ
14°C	Approx. 33kΩ	35°C	Approx. 13kΩ
16°C	Approx. 30kΩ	40°C	Approx. 11kΩ
18°C	Approx. 27kΩ	50°C or more	7kΩ or less
20°C	Approx. 25kΩ		

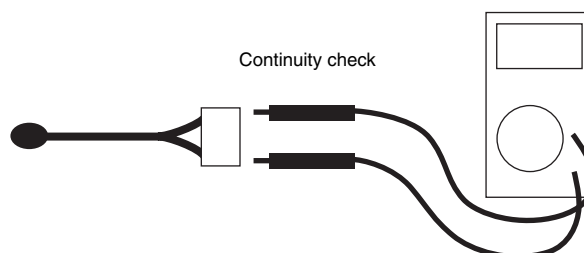

If measured value deviates significantly from above values, thermistor is faulty.

Use tester to check resistance



(HL028)

## 2.4 Outdoor Air Thermistor Error

<b>Remote Controller LCD Display</b>	Error Code <b>55</b> Inspection — Unit No. 
<b>LED Indication</b>	Remote Controller  Main Unit 
<b>Error Detection Method</b>	Temperature detected by outside air temperature sensor is used to detect errors.
<b>Error Generating Conditions</b>	When value detected by outside air temperature sensor is $-40^{\circ}\text{C}$ or below (open circuit) or $70^{\circ}\text{C}$ or higher (short-circuit).
<b>Possible Causes</b>	<ul style="list-style-type: none"> <li>■ Faulty sensor</li> <li>■ Broken wire</li> <li>■ Faulty control PCB (A1P)</li> <li>■ Faulty contact in connector</li> </ul>
<b>Troubleshooting</b>	

**Caution**

Be sure to turn off power switch before connect or disconnect connector, or parts damage may be occurred.

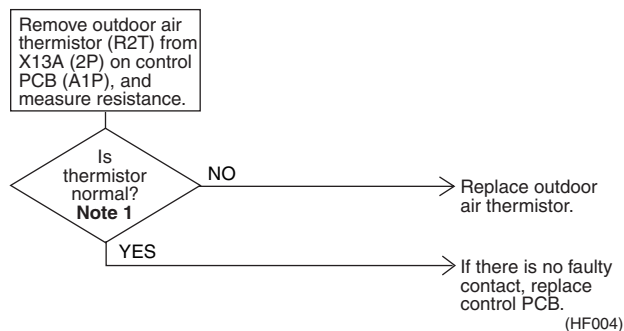
**Note:**
**Note 1:**

Refer to the thermistor temperature - resistance conversion table when measuring resistance.

Thermistor temperature - resistance conversion table

Thermistor temperature	Sensor resistance	Thermistor temperature	Sensor resistance
$-10^{\circ}\text{C}$ or less	108k $\Omega$ or more	$22^{\circ}\text{C}$	Approx. 23k $\Omega$
$-5^{\circ}\text{C}$	Approx. 85k $\Omega$	$24^{\circ}\text{C}$	Approx. 21k $\Omega$
$0^{\circ}\text{C}$	Approx. 66k $\Omega$	$26^{\circ}\text{C}$	Approx. 19k $\Omega$
$5^{\circ}\text{C}$	Approx. 51k $\Omega$	$28^{\circ}\text{C}$	Approx. 18k $\Omega$
$10^{\circ}\text{C}$	Approx. 40k $\Omega$	$30^{\circ}\text{C}$	Approx. 16k $\Omega$
$14^{\circ}\text{C}$	Approx. 33k $\Omega$	$35^{\circ}\text{C}$	Approx. 13k $\Omega$
$16^{\circ}\text{C}$	Approx. 30k $\Omega$	$40^{\circ}\text{C}$	Approx. 11k $\Omega$
$18^{\circ}\text{C}$	Approx. 27k $\Omega$	$50^{\circ}\text{C}$ or more	7k $\Omega$ or less
$20^{\circ}\text{C}$	Approx. 25k $\Omega$		

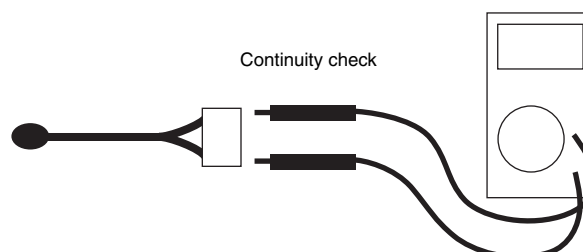

If measured value deviates significantly from above values, thermistor is faulty.

Use tester to check resistance



(HL028)

## 2.5 Damper System Error (Alarm)

<b>Remote Controller LCD Display</b>	Error Code <b>ER</b> Inspection — Unit No. 
<b>LED Indication</b>	Remote Controller  Main Unit 
<b>Error Detection Method</b>	Measurement of damper motor limit ON/OFF time.
<b>Error Generating Conditions</b>	<ul style="list-style-type: none"> <li>■ When damper motor limit switch 1 (or 2) remains ON (or OFF) for more than a certain time duration after ventilation mode is changed.</li> <li>■ When damper motor limit switch 1 (or 2) repeats ON/OFF operations after damper motor 1 (or 2) stops.</li> </ul>
<b>Possible Causes</b>	<ul style="list-style-type: none"> <li>■ Faulty damper motor or limit switch</li> <li>■ Broken wire in cable</li> <li>■ Faulty contact in connector (including relay connector)</li> <li>■ Faulty control PCB (A1P) assembly</li> </ul>

### Troubleshooting

 **Caution** Be sure to turn off power switch before connect or disconnect connector, or parts damage may be occurred.

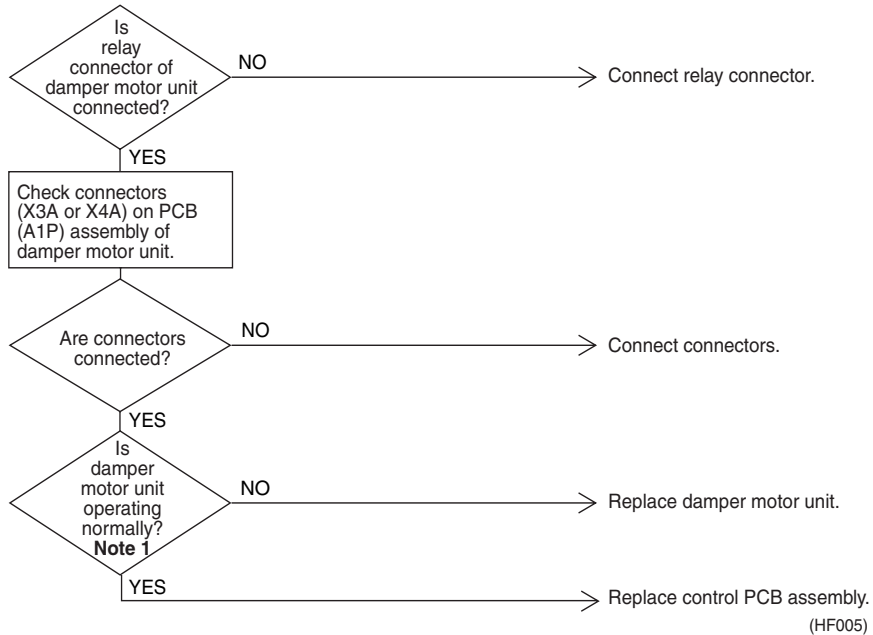

**Note:**

**Note 1:**

- Place tester probes on connectors of limit switch. Move switch by hand and check continuity. If tester indicates 0Ω when limit switch turns on, and infinity when it turns off, limit switch is normal.
- Place tester probes on connectors of damper motor and check resistance. If tester indicates approx. 17 kΩ in 200-V model, damper motor is normal.

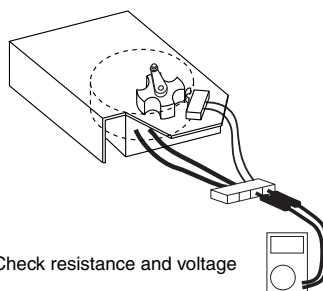

Check resistance and voltage



(HL029)

## 2.6 Damper System Error (Alarm)

### Remote Controller LCD Display

Error Code **6A** Inspection  Unit No. 

### LED Indication

Remote Controller  Main Unit 

### Error Detection Method

Measurement of damper motor limit switch ON/OFF time and temperatures detected by outdoor and indoor air thermistor.

### Error Generating Conditions

- When damper system error (alarm) and indoor (or outdoor) thermistor error are generated at the same time.
- When damper system error (alarm) occurs and values of indoor and outdoor air thermistor meet frost conditions.

### Possible Causes

- Faulty damper motor or limit switch
- Faulty indoor air thermistor
- Faulty outdoor air thermistor
- Frosting
- Broken wire in cable
- Faulty contact in connector (including relay connector)
- Faulty control PCB (A1P) assembly

### Troubleshooting



#### Caution

Be sure to turn off power switch before connect or disconnect connector, or parts damage may be occurred.

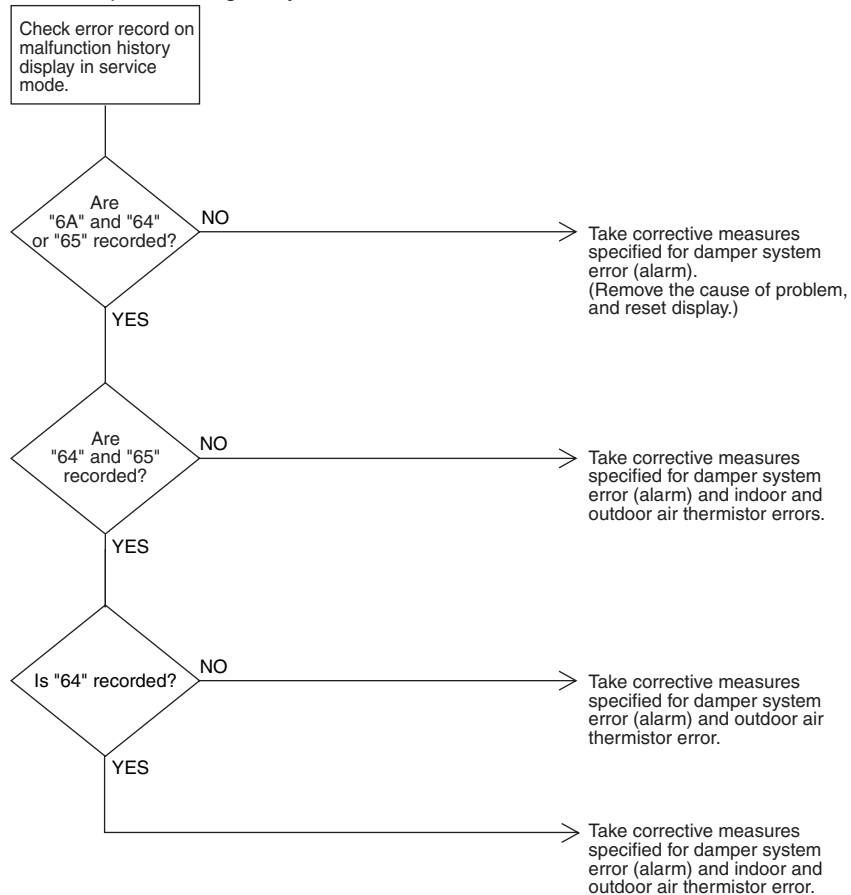

(HF006)

## 2.7 “A1” Indoor Unit: PC Board Defect

Remote  
Controller  
Display

A1

Applicable  
Models

All indoor unit models

Method of  
Malfunction  
Detection

Check data from E<sup>2</sup>PROM.

Malfunction  
Decision  
Conditions

When data could not be correctly received from the E<sup>2</sup>PROM  
E<sup>2</sup>PROM : Type of nonvolatile memory. Maintains memory contents even when the power supply is turned off.

Supposed  
Causes

- Defect of indoor unit PC board (A2P)

Troubleshooting

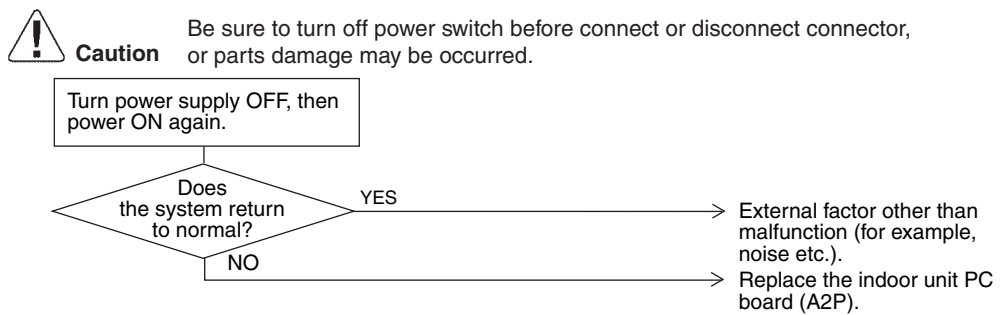

(V2777)

## 2.8 “R9” Indoor Unit: Malfunction of Moving Part of Electronic Expansion Valve (20E)

Remote  
Controller  
Display

R9

Applicable  
Models

All indoor unit models

Method of  
Malfunction  
Detection

Detection by failure of signal for detecting number of turns to come from the fan motor

Malfunction  
Decision  
Conditions

When number of turns can't be detected even when output voltage to the fan is maximum

Supposed  
Causes

- Malfunction of moving part of electronic expansion valve
- Defect of indoor unit PC board (A2P)
- Defect of connecting cable

Troubleshooting



**Caution**

Be sure to turn off power switch before connect or disconnect connector, or parts damage may be occurred.

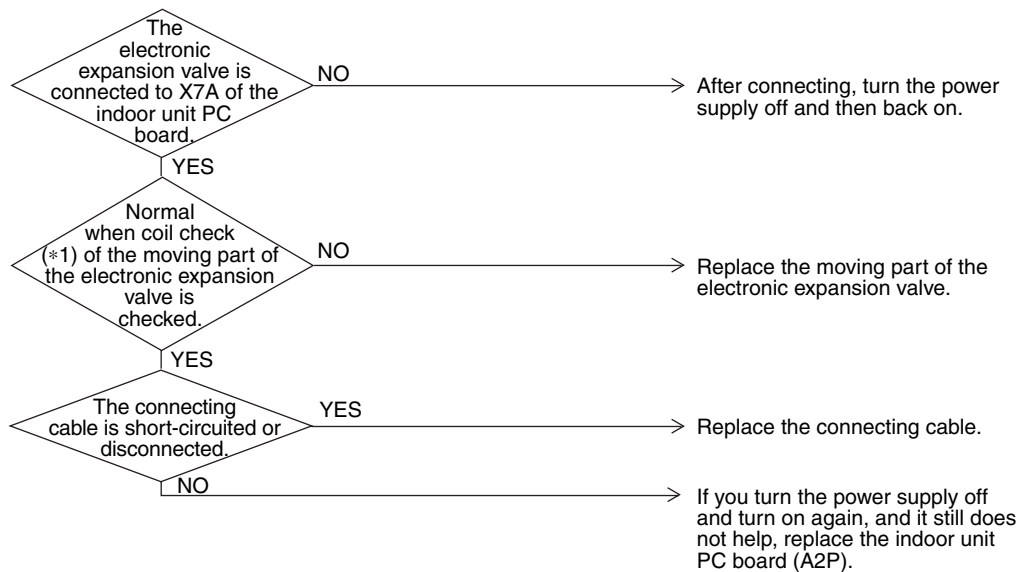

(V2781)

## 2.9 “E4” Indoor Unit: Malfunction of Thermistor (R4T) for Heat Exchanger

<b>Remote Controller Display</b>	E4
<b>Applicable Models</b>	All indoor unit models
<b>Method of Malfunction Detection</b>	Malfunction detection is carried out by temperature detected by heat exchanger thermistor.
<b>Malfunction Decision Conditions</b>	When the heat exchanger thermistor becomes disconnected or shorted while the unit is running.
<b>Supposed Causes</b>	<ul style="list-style-type: none"> <li>■ Defect of thermistor (R4T) for liquid pipe</li> <li>■ Defect of indoor unit PC board (A2P)</li> </ul>

### Troubleshooting



**Caution**

Be sure to turn off power switch before connect or disconnect connector, or parts damage may be occurred.

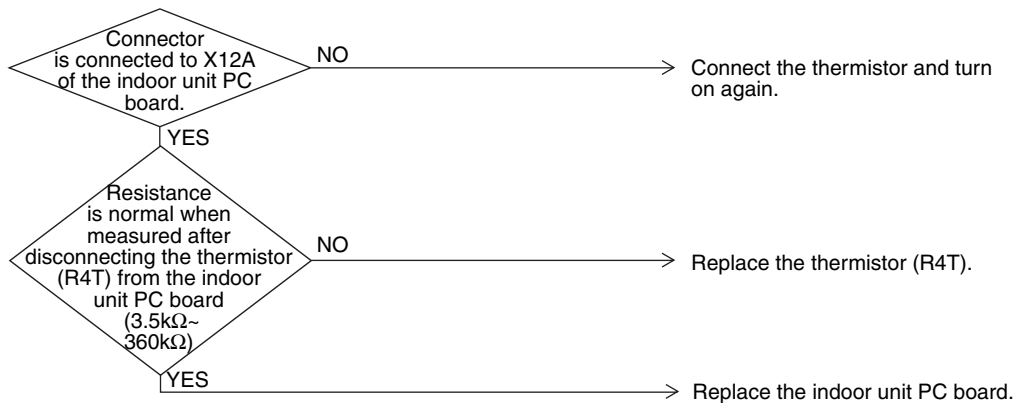

(V2784)



\*2: Refer to thermistor resistance / temperature characteristics table on P77.

## 2.10 “E5” Indoor Unit: Malfunction of Thermistor (R5T) for Gas Pipes

Remote  
Controller  
Display

E5

Applicable  
Models

All indoor unit models

Method of  
Malfunction  
Detection

Malfunction detection is carried out by temperature detected by gas pipe thermistor.

Malfunction  
Decision  
Conditions

When the gas pipe thermistor becomes disconnected or shorted while the unit is running.

Supposed  
Causes

- Defect of indoor unit thermistor (R5T) for gas pipe
- Defect of indoor unit PC board (A2P)

Troubleshooting



**Caution**

Be sure to turn off power switch before connect or disconnect connector, or parts damage may be occurred.

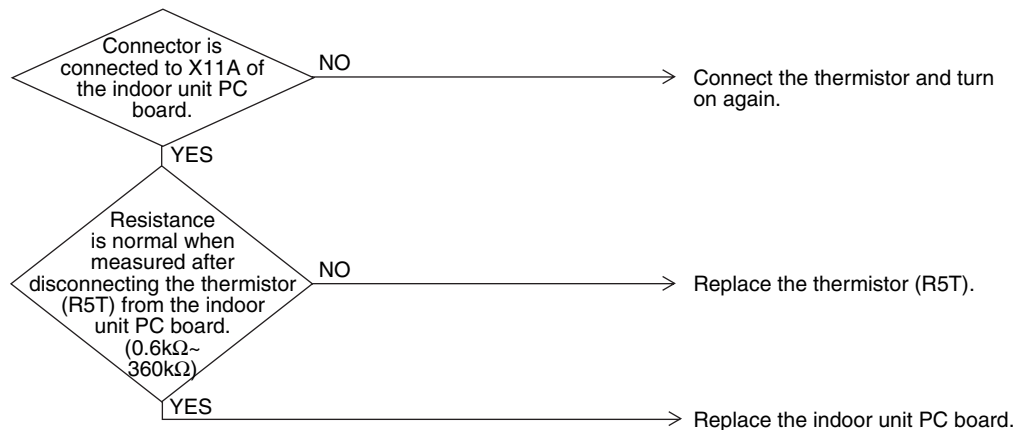

(V2785)



\*2: Refer to thermistor resistance / temperature characteristics table on P77.



## 2.11 “E9” Indoor Unit: Malfunction of Thermistor (R3T) for Suction Air

<b>Remote Controller Display</b>	E9
<b>Applicable Models</b>	All indoor unit models
<b>Method of Malfunction Detection</b>	Malfunction detection is carried out by temperature detected by suction air temperature thermistor.
<b>Malfunction Decision Conditions</b>	When the suction air temperature thermistor becomes disconnected or shorted while the unit is running.
<b>Supposed Causes</b>	<ul style="list-style-type: none"> <li>■ Defect of indoor unit thermistor (R3T) for air inlet</li> <li>■ Defect of indoor unit PC board (A2P)</li> </ul>

### Troubleshooting



**Caution**

Be sure to turn off power switch before connect or disconnect connector, or parts damage may be occurred.

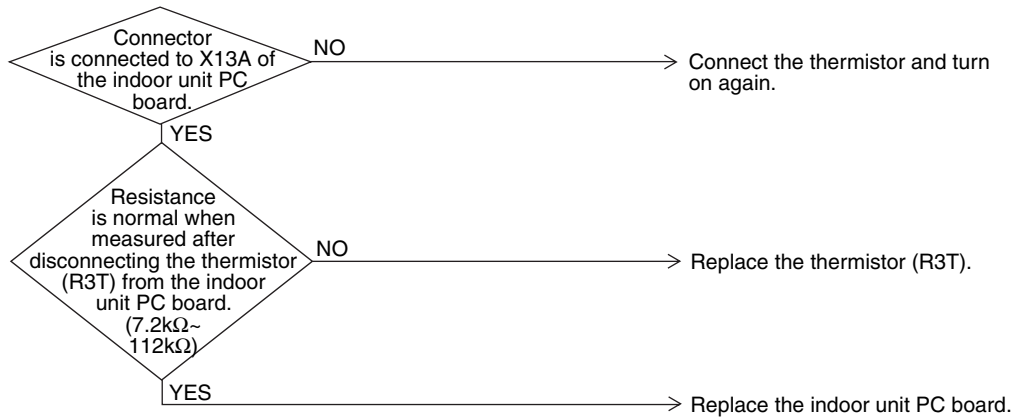

(V2786)



\*2: Refer to thermistor resistance / temperature characteristics table on P77.

## 2.12 “U3” Check Operation not executed

Remote  
Controller  
Display

U3

Applicable  
Models

Method of  
Malfunction  
Detection

Check operation is executed or not

Malfunction  
Decision  
Conditions

Malfunction is decided when the unit starts operation without check operation.

Supposed  
Causes

- Check operation is not executed.

Troubleshooting



**Caution**

Be sure to turn off power switch before connect or disconnect connector, or parts damage may be occurred.

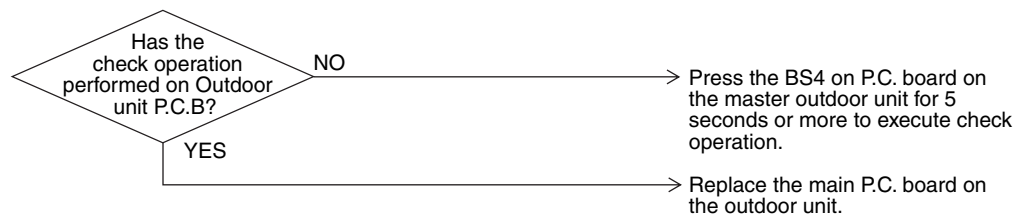

(V3052)

## 2.13 Dedicated LCD Remote Controller

When “88” remains on remote controller display.

**Error Detection Method**

When “88” remains on remote controller display.

**Error Generating Conditions**

**Possible Causes**

Master-slave setting of remote controller  
 Remote controller PCB assembly error  
 Main unit PCB assembly error

**Troubleshooting**

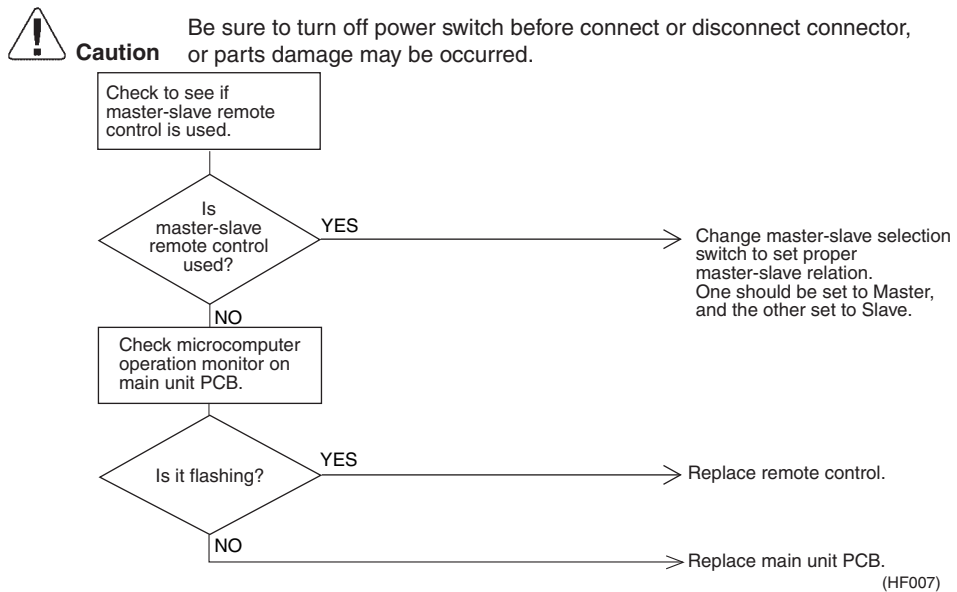



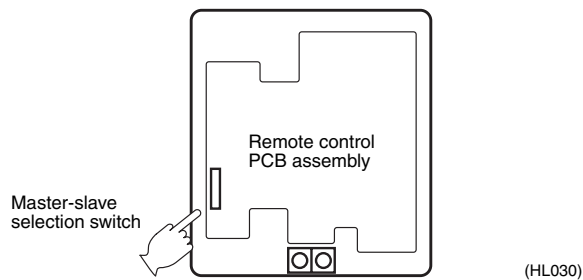

**Dedicated Remote Controller**

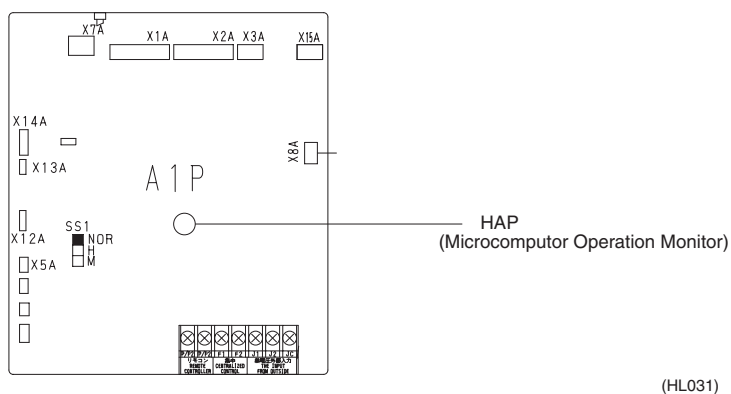

**Main Unit PCB (A1P)**



## 2.14 Data Transmission Error (Between LCD Remote Controller and Main Unit)

<b>Remote Controller LCD Display</b>	Error Code <i>U5</i> Inspection  Unit No. 
<b>LED Indication</b>	Remote Controller  Main Unit 
<b>Error Detection Method</b>	Microcomputer checks if data is transmitted properly between main unit and remote controller.
<b>Error Generating Conditions</b>	When data transmission is not performed correctly for a certain time period.
<b>Possible Causes</b>	<ul style="list-style-type: none"> <li>■ Faulty connection of remote controller cable</li> <li>■ Faulty remote controller cable</li> <li>■ External factor (noise, etc.)</li> </ul>

### Troubleshooting

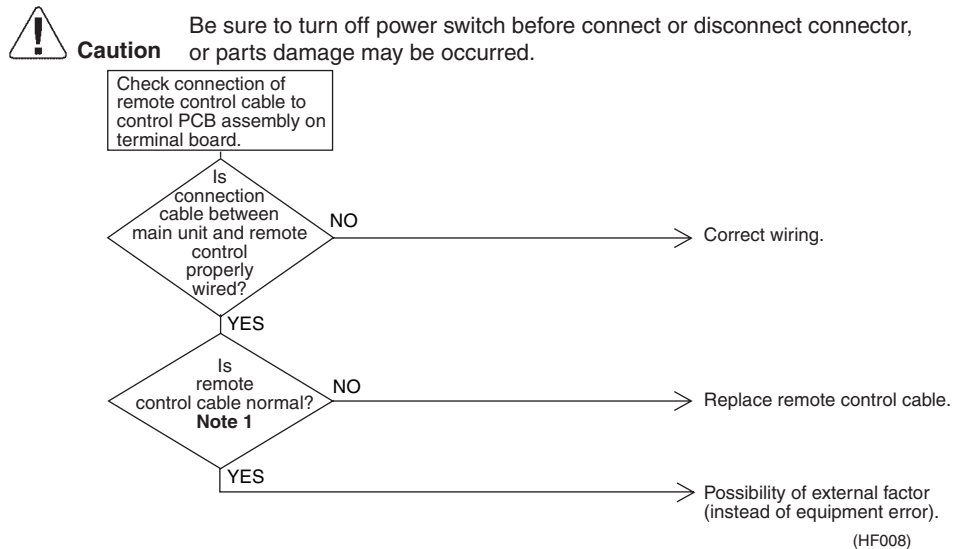

#### Note:

##### Note 1:

1. Use tester to check continuity of remote controller cable.
  - Disconnect cable from main unit terminal board and remote controller terminal board. Measure resistance between wires in cable. Resistance should be  $\infty$  M $\Omega$  (infinity).
2. Use tester to check voltage at terminal board. Check with power turned on.
  - With remote controller cable disconnected, voltage between P1 and P2 on terminal board should be approx. 16 VDC. If measured value is not approx. 16 VDC, PCB assembly is faulty.
  - Connect remote controller cable and disconnect remote controller. Voltage at the end of remote controller cable should be approx. 16 VDC. If measured value is not 16 VDC, remote controller cable is faulty.
  - Connect remote controller cable and remote controller. Voltage between P1 and P2 on remote controller terminal should be approx. 16 VDC. If measured valued is not 16 VDC, remote controller is faulty.

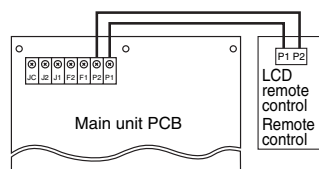

(HL032)

## 2.15 "U5" Malfunction of Transmission Between Remote Controller and Indoor Unit

Remote Controller Display

U5

Applicable Models

All models of indoor units

Method of Malfunction Detection

In case of controlling with 2-remote controller, check the system using microcomputer is signal transmission between indoor unit and remote controller (main and sub) is normal.

Malfunction Decision Conditions

Normal transmission does not continue for specified period.

Supposed Causes

- Malfunction of indoor unit remote controller transmission
- Connection of two main remote controllers (when using 2 remote controllers)
- Defect of indoor unit PC board
- Defect of remote controller PC board
- Malfunction of transmission caused by noise

### Troubleshooting



**Caution**

Be sure to turn off power switch before connect or disconnect connector, or parts damage may be occurred.

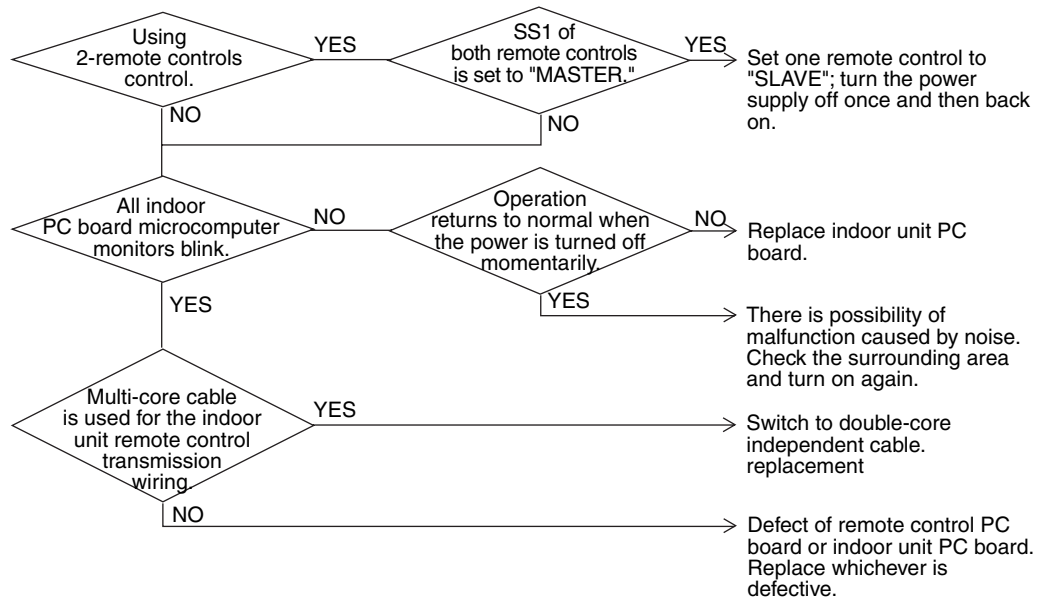

(V2823)

## 2.16 “UB” Malfunction of Transmission Between Master and Slave Remote Controllers

Remote  
Controller  
Display

UB

Applicable  
Models

All models of indoor units

Method of  
Malfunction  
Detection

In case of controlling with 2-remote controller, check the system using microcomputer if signal transmission between indoor unit and remote controller (main and sub) is normal.

Malfunction  
Decision  
Conditions

Normal transmission does not continue for specified period.

Supposed  
Causes

- Malfunction of transmission between main and sub remote controller
- Connection between sub remote controllers
- Defect of remote controller PC board

Troubleshooting



**Caution**

Be sure to turn off power switch before connect or disconnect connector, or parts damage may be occurred.

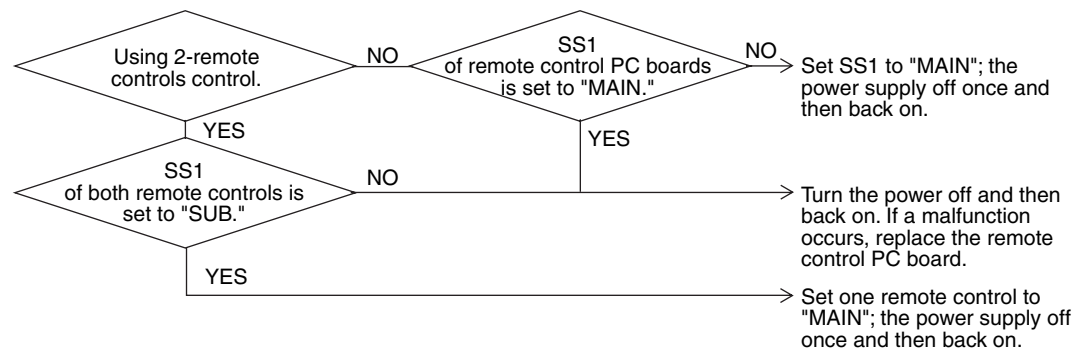

(V2825)

## 2.17 "UR" Excessive Number of Indoor Units

Remote  
Controller  
Display

UR

Applicable  
Models

All models of indoor unit

Method of  
Malfunction  
Detection

Malfunction  
Decision  
Conditions

Supposed  
Causes

- Excess of connected indoor units
- Defect of outdoor unit PC board (A1P)
- Mismatching of the refrigerant type of indoor and outdoor unit.
- Setting of outdoor P.C. board was not conducted after replacing to spare parts P.C. board.

### Troubleshooting



**Caution**

Be sure to turn off power switch before connect or disconnect connector, or parts damage may be occurred.

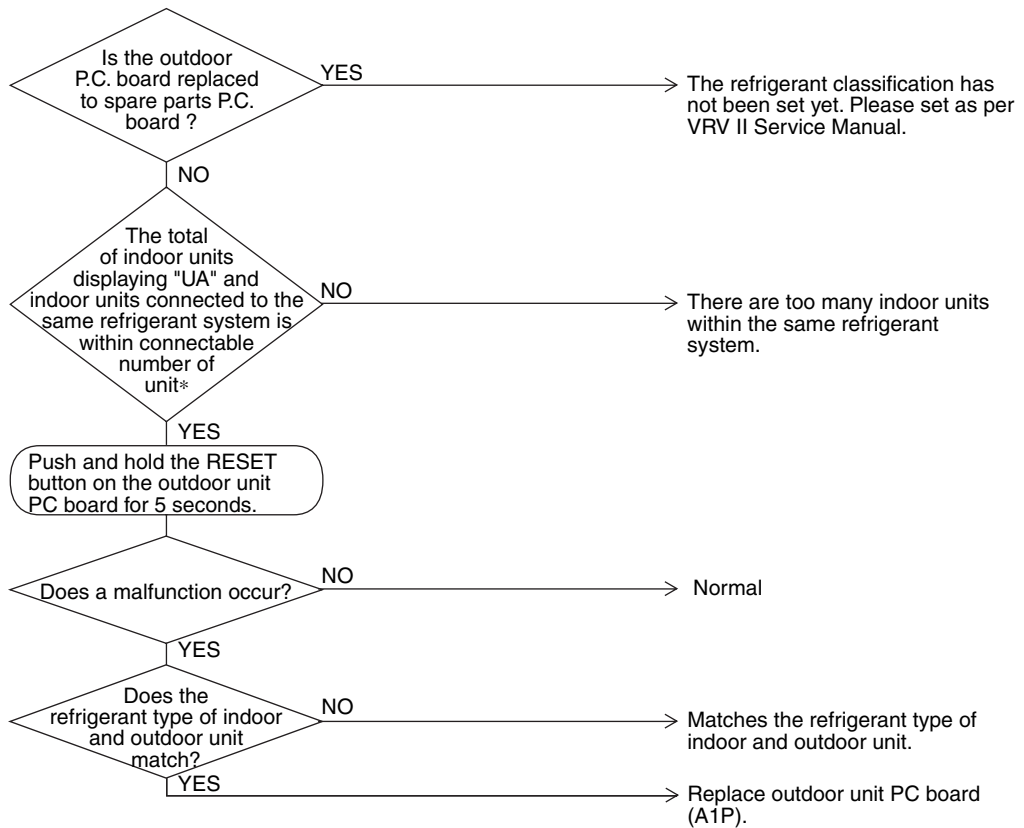

(V2827)

\* The number of indoor units that can be connected to a single outdoor unit system depends on the type of outdoor unit.

## 2.18 “UC” Address Duplication of Central Remote Controller

Remote  
Controller  
Display

UC

Applicable  
Models

All models of indoor unit  
Centralized controller

Method of  
Malfunction  
Detection

Malfunction  
Decision  
Conditions

Supposed  
Causes

- Address duplication of centralized remote controller
- Defect of indoor unit PC board

Troubleshooting



**Caution**

Be sure to turn off power switch before connect or disconnect connector, or parts damage may be occurred.

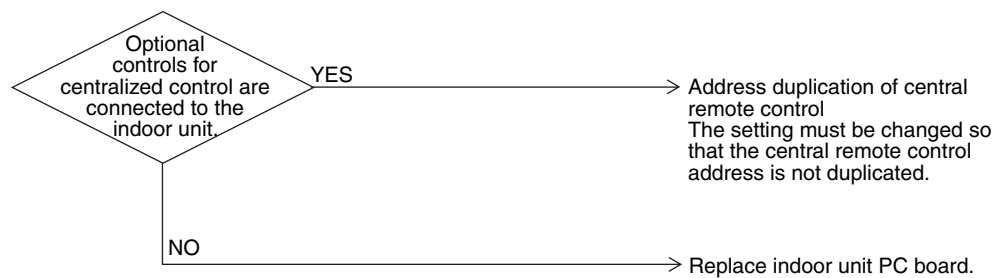

(V2828)



## 2.19 “UE” Malfunction of Transmission Between Central Remote Controller and Indoor Unit

<b>Remote Controller Display</b>	<i>UE</i>
<b>Applicable Models</b>	All models of indoor units Centralized controller
<b>Method of Malfunction Detection</b>	Microcomputer checks if transmission between indoor unit and centralized remote controller is normal.
<b>Malfunction Decision Conditions</b>	When transmission is not carried out normally for a certain amount of time
<b>Supposed Causes</b>	<ul style="list-style-type: none"> <li>■ Malfunction of transmission between optional controllers for centralized control and indoor unit</li> <li>■ Connector for setting master controller is disconnected.</li> <li>■ Failure of PC board for centralized remote controller</li> <li>■ Defect of indoor unit PC board</li> </ul>

## Troubleshooting

**Caution**

Be sure to turn off power switch before connect or disconnect connector, or parts damage may be occurred.

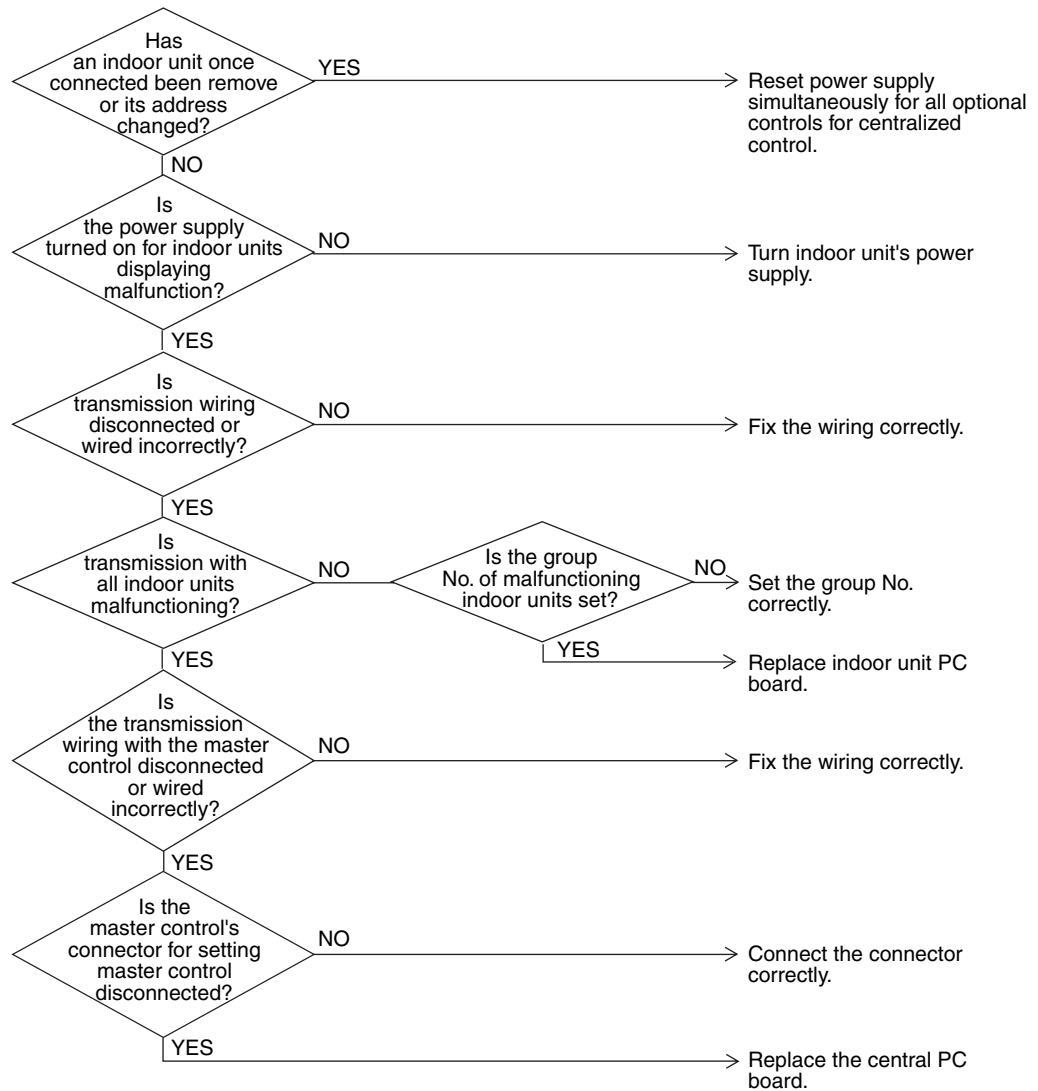

(V2829)

## 2.20 “UE” Malfunction of Transmission Between Central Remote Controller and Indoor Unit

<b>Remote Controller Display</b>	UE
<b>Applicable Models</b>	All models of indoor units
<b>Method of Malfunction Detection</b>	Microcomputer checks if transmission between indoor unit and central remote controller is normal.
<b>Malfunction Decision Conditions</b>	When transmission is not carried out normally for a certain amount of time
<b>Supposed Causes</b>	<ul style="list-style-type: none"> <li>■ Malfunction of transmission between optional controllers for centralized control and indoor unit</li> <li>■ Connector for setting master controller is disconnected.</li> <li>■ Failure of PC board for central remote controller</li> <li>■ Defect of indoor unit PC board</li> </ul>

### Troubleshooting

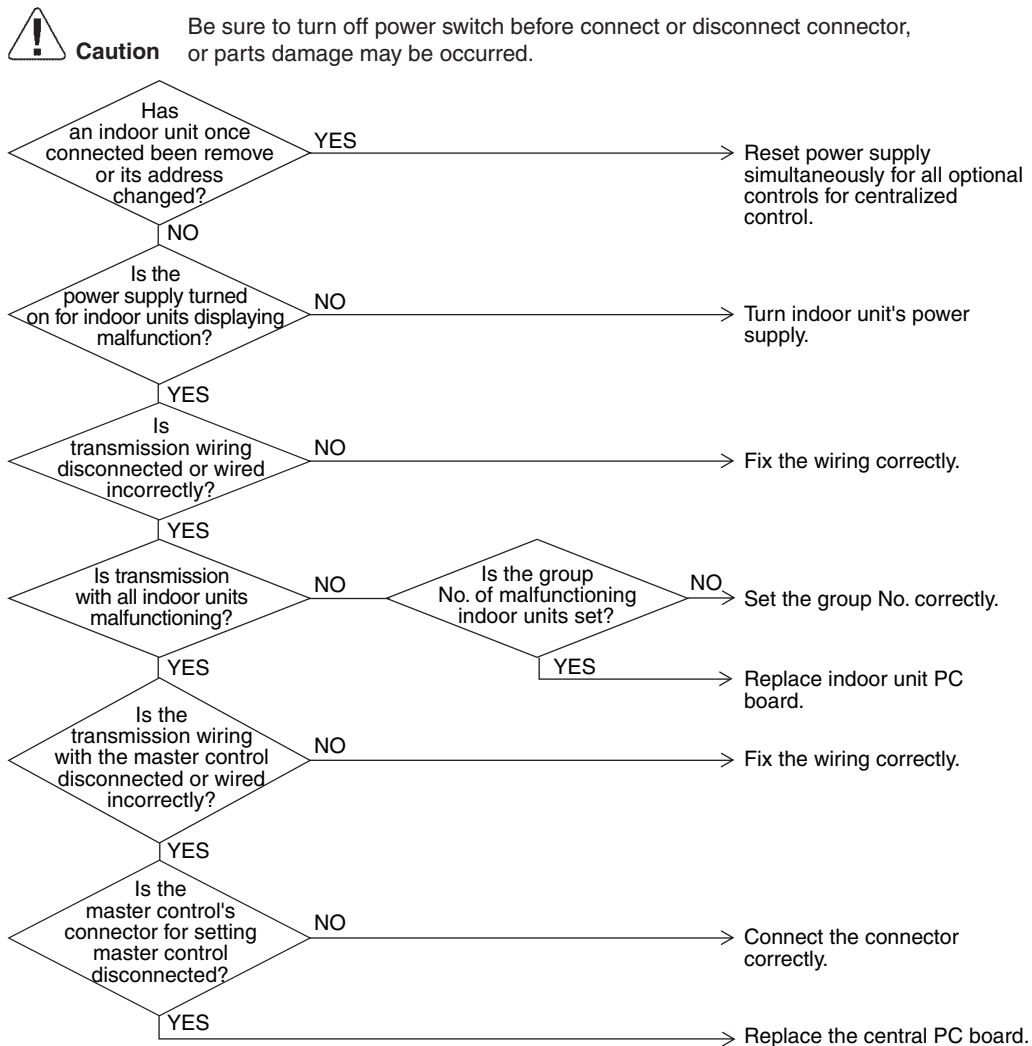

(V2832)

# 2.21 Main Unit PCB Assembly

<b>Error Detection Method</b>	Check microcomputer operation monitor.
<b>Error Generating Conditions</b>	When main unit PCB assembly does not operate. When communication circuit errors.
<b>Possible Causes</b>	Fuse (excess current) Power transformer Noise Main unit PCB

**Troubleshooting**

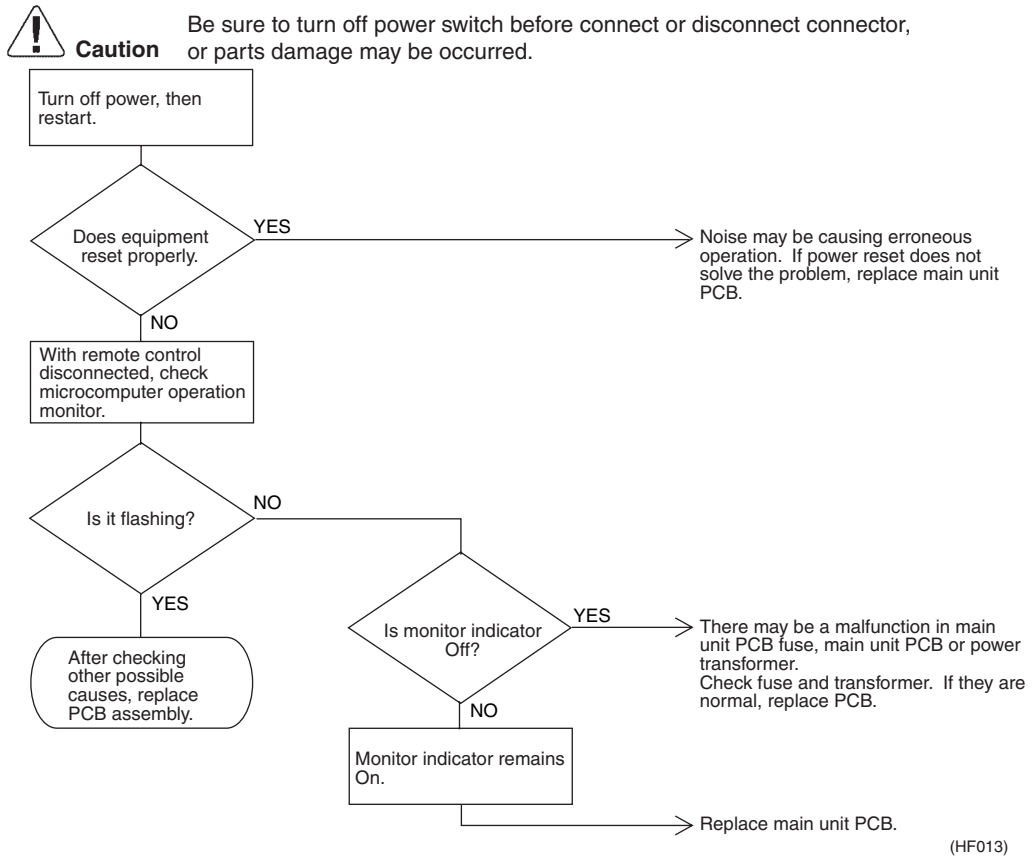

Main unit PCB (A1P)

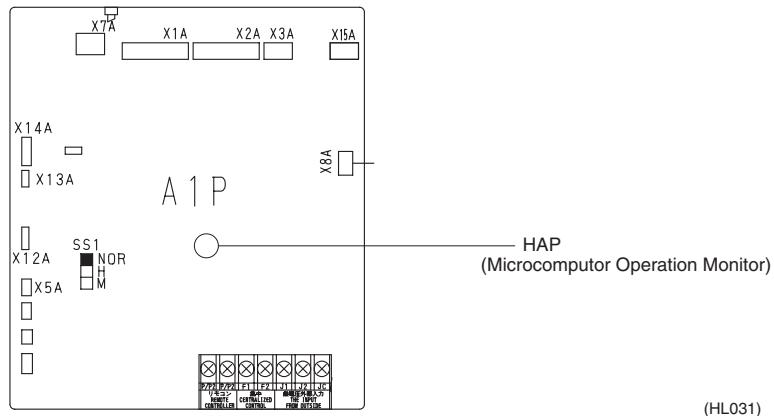

(HL031)

## 2.22 Thermistor

**Error Detection Method** Remove thermistor and check resistance with tester.

**Error Generating Conditions**

- Possible Causes**
- Faulty thermistor
  - Broken wire
  - Faulty control PCB
  - Faulty contact in connector

### Troubleshooting



**Caution**

Be sure to turn off power switch before connect or disconnect connector, or parts damage may be occurred.

Remove thermistors from main unit PCB (A1P) (X12A, X13A), and PCB (A2P) (X13A, X14A, X15A) check resistance using tester.

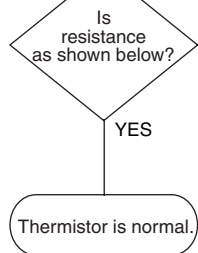

If measured value deviates significantly from values in the table, thermistor is faulty.

(HF015)



**Note:** Refer to the thermistor temperature - resistance conversion table when measuring resistance.

For Thermistor of Indoor Air R1T  
For Thermistor of Outdoor Air R2T

Indoor unit	For air suction	R3T	Outdoor unit	For outdoor air	R1T
	For liquid pipe	R4T		For coil	R2T
	For gas pipe	R5T		For suction pipe	R4T
				For Receiver gas pipe	R5T

			(kΩ)		
T°C	0.0	0.5	T°C	0.0	0.5
-20	197.81	192.08	30	16.10	15.76
-19	186.53	181.16	31	15.43	15.10
-18	175.97	170.94	32	14.79	14.48
-17	166.07	161.36	33	14.18	13.88
-16	156.80	152.38	34	13.59	13.31
-15	148.10	143.96	35	13.04	12.77
-14	139.94	136.05	36	12.51	12.25
-13	132.28	128.63	37	12.01	11.76
-12	125.09	121.66	38	11.52	11.29
-11	118.34	115.12	39	11.06	10.84
-10	111.99	108.96	40	10.63	10.41
-9	106.03	103.18	41	10.21	10.00
-8	100.41	97.73	42	9.81	9.61
-7	95.14	92.61	43	9.42	9.24
-6	90.17	87.79	44	9.06	8.88
-5	85.49	83.25	45	8.71	8.54
-4	81.08	78.97	46	8.37	8.21
-3	76.93	74.94	47	8.05	7.90
-2	73.01	71.14	48	7.75	7.60
-1	69.32	67.56	49	7.46	7.31
0	65.84	64.17	50	7.18	7.04
1	62.54	60.96	51	6.91	6.78
2	59.43	57.94	52	6.65	6.53
3	56.49	55.08	53	6.41	6.53
4	53.71	52.38	54	6.65	6.53
5	51.09	49.83	55	6.41	6.53
6	48.61	47.42	56	6.18	6.06
7	46.26	45.14	57	5.95	5.84
8	44.05	42.98	58	5.74	5.43
9	41.95	40.94	59	5.14	5.05
10	39.96	39.01	60	4.96	4.87
11	38.08	37.18	61	4.79	4.70
12	36.30	35.45	62	4.62	4.54
13	34.62	33.81	63	4.46	4.38
14	33.02	32.25	64	4.30	4.23
15	31.50	30.77	65	4.16	4.08
16	30.06	29.37	66	4.01	3.94
17	28.70	28.05	67	3.88	3.81
18	27.41	26.78	68	3.75	3.68
19	26.18	25.59	69	3.62	3.56
20	25.01	24.45	70	3.50	3.44
21	23.91	23.37	71	3.38	3.32
22	22.85	22.35	72	3.27	3.21
23	21.85	21.37	73	3.16	3.11
24	20.90	20.45	74	3.06	3.01
25	20.00	19.56	75	2.96	2.91
26	19.14	18.73	76	2.86	2.82
27	18.32	17.93	77	2.77	2.72
28	17.54	17.17	78	2.68	2.64
29	16.80	16.45	79	2.60	2.55
30	16.10	15.76	80	2.51	2.47

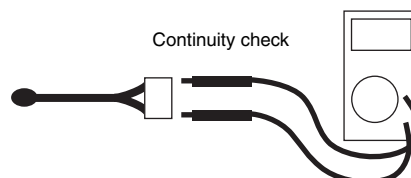

(HL028)

## 2.23 Power Transformer

**Error Detection Method** Check resistance and voltage with tester, and insulation resistance with megger.

**Error Generating Conditions**

**Possible Causes**

**Troubleshooting**



**Caution**

Be sure to turn off power switch before connect or disconnect connector, or parts damage may be occurred.

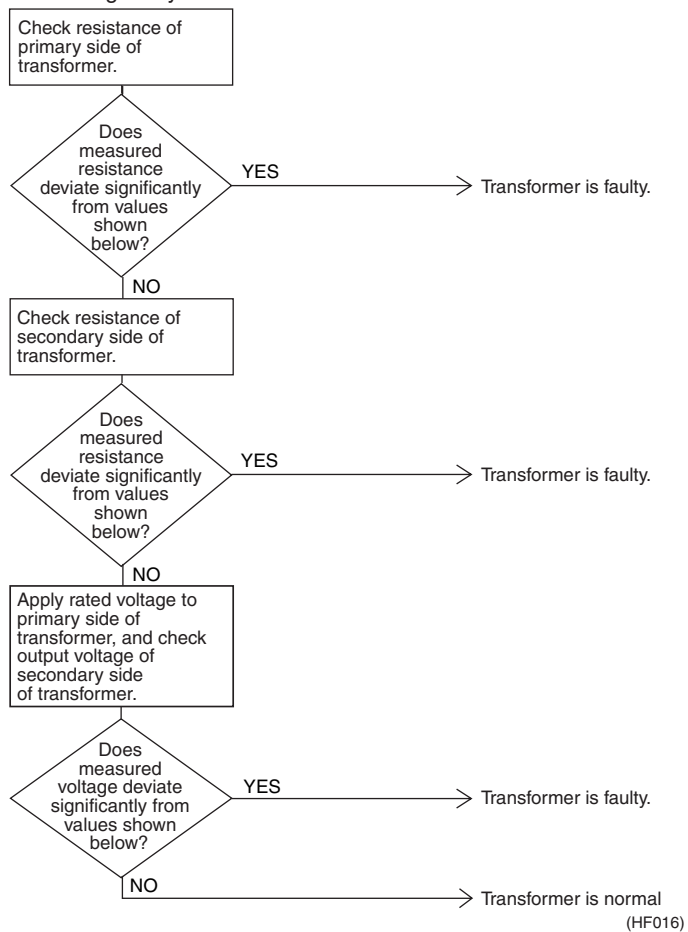

- Resistance of primary side of transformer: approx. 140Ω
- Resistance of secondary side of transformer: approx. 1.9Ω
- Voltage at secondary side of transformer when rated voltage is applied to primary side: approx. 26 VAC
- Insulation resistance between primary side of transformer and case: 100 MΩ or higher
- Insulation resistance between secondary side of transformer and case: 100 MΩ or higher
- Insulation resistance between primary side and secondary side of transformer: 100 MΩ or higher

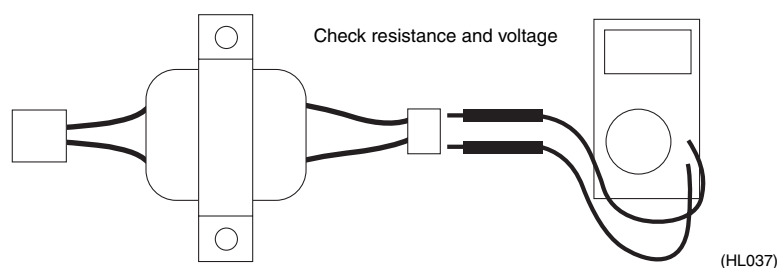

## 2.24 Damper Motor

**Error Detection Method**

Check damper motor and limit switch when damper motor does not operate.

**Error Generating Conditions**

**Possible Causes**

**Troubleshooting**

**Caution** Be sure to turn off power switch before connect or disconnect connector, or parts damage may be occurred.

Place tester probes at connectors of limit switch, and check continuity while moving switch by hand.

Is measured value  $0\ \Omega$  when limit switch turns on, and infinity when it turns off?

NO

→ Limit switch is faulty.

YES

Place tester probes on connectors of damper motor and check resistance.

Is measured value of EJ type approx.  $17\ k\Omega$ ?

NO

→ Damper motor is faulty.

YES

Damper motor is normal.

(HF017)

Check resistance and voltage — DAMPER MOTOR

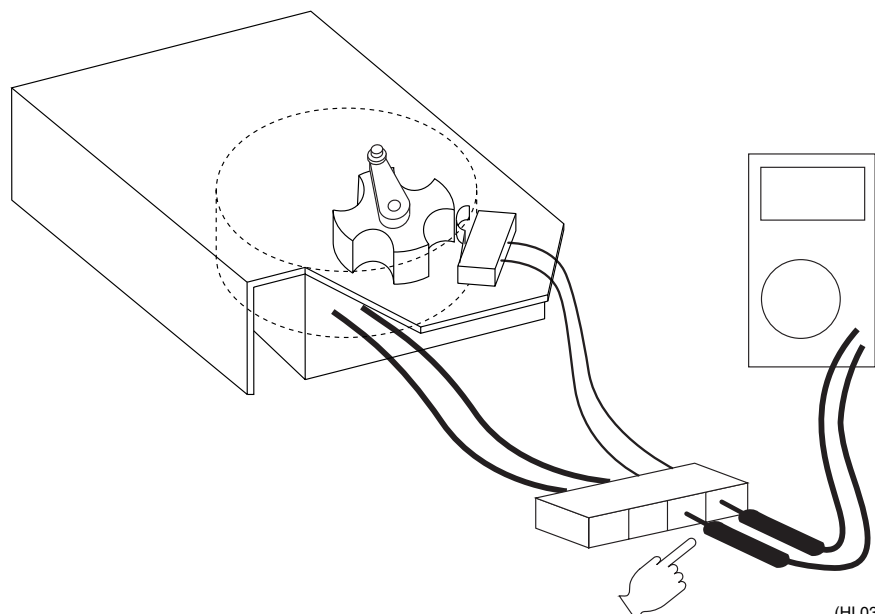

(HL038)





# Part 7

# Field Setting

1. Field Setting .....	82
1.1 Field Setting and Test Run .....	82

# 1. Field Setting

## 1.1 Field Setting and Test Run

### 1.1.1 Perform Field Settings with the Remote Controller

- (1) Make sure the Electric Parts Box Lids are closed on the Indoor and Outdoor Units.
- (2) Depending on the Type of Installation, make the Field Settings from the Remote Controller after the Power is turned on, following the “Field Settings” Manual which came with the Remote Controller.

Lastly, make sure the customer keeps the “Field Settings” manual, along with the operating manual, in a safe place.

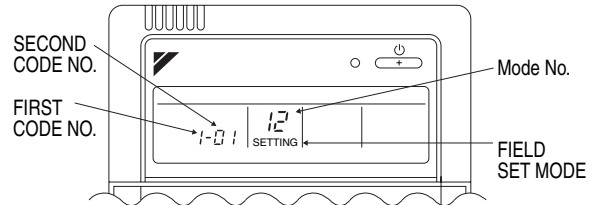

#### Local setting

Using the remote controller of the VRV-system air conditioner to make HRV unit settings

##### <Initial setting>

- Mode nos. 17,18 and 19: Group control of HRV units.
- Mode nos. 27, 28 and 29: individual control

##### <Operating procedure>

The following describes the operating procedure and settings.

- (1) Press the INSPECTION/TRIAL button for more than four seconds with the unit in the normal mode to enter the local setting mode.
- (2) Use the TEMPERATURE ADJUSTMENT button to select the desired “Mode No.” (The code display will blink.)
- (3) To make settings for individual units under group control (when mode No. 27, 28 or 29 is selected), press the TIMER SETTING ON/OFF button to select the “unit No.” for which the settings are to be made. (This process is not necessary when settings are made for the entire group.)
- (4) Press the top section of the TIMER button to select the “FIRST CODE NO.”
- (5) Press the lower section of the TIMER button to select “SECOND CODE NO.”.
- (6) Press the PROGRAM/CANCEL button once to enter the settings. (The code display will stop blinking and light up.)
- (7) Press the INSPECTION/TRIAL button to return to normal mode.

**BRC1D527 (EU only)**

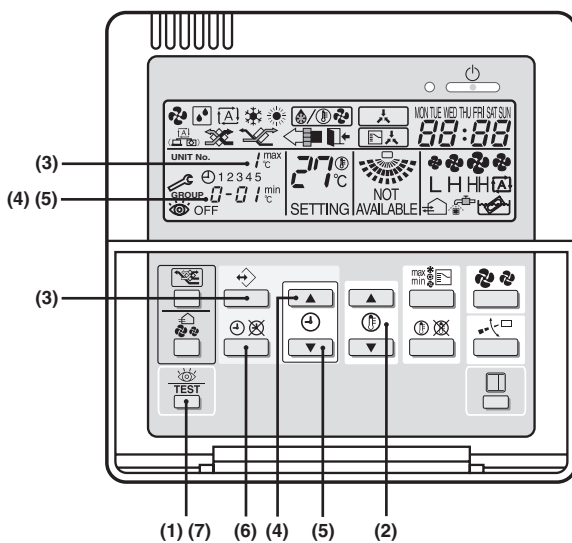

**BRC1A62**

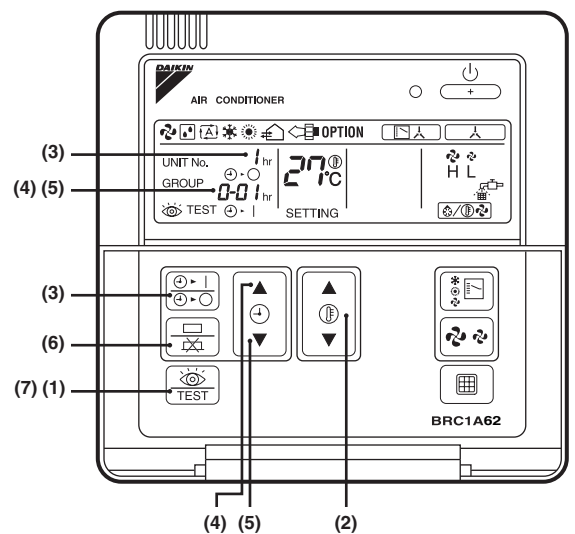

## &lt;Example&gt;

When adjusting the ventilation air flow to low setting in the group setting mode, enter the mode No., "19" FIRST CODE NO., "0" and SECOND CODE NO., "01".

## Settings and setting numbers

Description of setting	Mode No. *1	FIRST CORD NO.	SECOND CORD NO.							
			01	02	03	04	05	06	07	08
Filter cleaning time setting NOTE) 5	17 (27)	0	Approx. 2500 hours	Approx. 1250 hours	No counting	-	-	-	-	-
Nighttime free cooling operation setting (Time after air conditioning is stopped.) NOTE) 5		1	OFF	2 hours later	4 hours later	6 hours later	8 hours later	-	-	-
Fan speed initial setting		4	Normal	Ultra high	-	-	-	-	-	-
Direct duct connection with VRV setting		5	Not direct duct (Air flow setting)	With direct duct (fan off)	-	Not direct duct (Air flow setting)	-	With direct duct (fan off)	-	-
Setting for cold areas (Fan operation selection for heater thermostat OFF) NOTE) 6		5	Air flow setting	Air flow setting	-	Fan L	-	Fan L	-	-
Ventilation air flow setting when Nighttime free cooling setting	17 (27)	6	High	Ultra high	-	-	-	-	-	-
ON/OFF input from Outside (Set when ON/OFF is to be controlled from outside)	12 (22)	1	Forced off	ON/OFF control	-	-	-	-	-	-
Power failure automatic reset (Auto Restart)	12 (22)	5	No equipped	Equipped	-	-	-	-	-	-
Humidification on/off when heating thermostat is off	15 (25)	1	No	Yes	-	-	-	-	-	-
Indication of ventilation mode/Not indication	18 (28)	4	Indication	No Indication	-	-	-	-	-	-
Fresh up air supply/exhaust setting		7	No Indication	Indication		-	-	-	-	-
External input terminal function selection (between J1 and JC) NOTE) 7		8	Fresh-up	Overall alarm	-	-	-	Air flow increase	-	-
		9	Fan on/off	Abnormal	-	-	-	-	-	-
Ventilation air flow setting	19 (29)	0	Low	Low	Low	Low	High	High		
Ventilation mode setting		2	Automatic	Exchange	By-pass					
Fresh-up operation	1A		Off	On	-	-	-	-	-	-
Differential setting on VKM °C	12 (22)	4	0	1	2	3	4	5	6	7
Forced fan on	43									
Unit no. allocation	45									

Description of setting	Mode No. *1	FIRST CORD NO.	SECOND CORD NO.												
			01	02	03	04	05	06	07	08	09	10	11	12	13
Heating temperature setting on VKM °C	14 (24)	1	14	15	16	17	18	19	20	21	22	23	24	25	26

## NOTE)

- The  inside the frame indicates the second code no. set when shipped from factory.
- The settings are applied to the entire group, but if the mode no. inside the parentheses is selected, the settings can be applied to individual indoor units.  
However, it is only possible to check any changes made to the settings inside the parentheses in individual mode. (For group batch operation, the changes are made but the display remains as it was when shipped from the factory.)
- Do not set anything not shown above. If the applicable functions are not available, they will not be displayed.

4. When returning to normal mode, the remote controller is initialized, so the display might show "88."
5. When "Filter cleaning time setting" or "Night-purge operation setting" is changed, explain set contents to the customer.
6. Settings are made by group in a batch. Selecting a Mode No. in the parentheses will also enable individual settings by the indoor unit. However, setting changes can only be confirmed by the individual modes shown in the parentheses. (In the case of group setting in a batch, the remote controller always displays "01" regardless of the setting changes.)
7. See below for details on the settings for cold areas.

	Air conditioner Fan	HRV fan			
		01	02	04	06
Heating thermo off	Operation	–	–	L	L
Defrost	Stop	–	S	S	S
Oil return	Stop	–	S	S	S

In case of Independent operation

	Air conditioner fan	01	02	04	06
Heating thermo off	Operation	–	–	L	L
Defrost	Stop	–	–	Stop	Stop
Oil return	Stop	–	–	Stop	Stop

– : operate at the set fan strength  
 L : operate at the weak fan strength  
 S : Stop

#### Defrost operation

- In heating operation, freezing of the outdoor unit's coil increases. Heating capability decreases and the system goes into defrost operation.
- The remote controller will read "  "until the hot air starts blowing.
- It returns to the heating operation again after 6 to 8 minutes (10 at the longest)
- During defrost operation, the fans of the unit continues driving (factory setting). The purpose of this is to maintain the amount of ventilation and humidifying.
- The change of air discharge grill's location should be examined when the cold draft from air discharge grill is feared.
- Though the fan can be stopped by the setting of remote controller Do not stop the fan in the place where no ventilation by stopping the fan may cause the influence of diffusion of air which it is dirty and moisture into another room, or the inflow from outside the room. (outflow such as viruses from the sickroom, or smell leakage from the rest room, etc.)

8. See below for details on the external input terminal function.

SECOND CODE NO.	Input contact	Fan operation	Operation lamp	
01	a	Operation	On	Fresh-up operation
02	a	Operation	On	Malfunction code "60" is displayed
06	a	Operation	On	Fan strength up (Low to high, high to ultra-high)

9. \*SECOND CODE NO. "04" does not function when in air conditioner linked mode.

## 1.1.2 Perform a Test Run according to the Outdoor Unit's Installation Manual

1. Make sure the electric parts box of the unit is closed before turning on power.
2. Make a test run following the operation manual of the outdoor unit.
  - The operation lamp of the remote controller will flash when a malfunction occurs. Check the malfunction code on the liquid crystal display to identify the point of trouble. An explanation of malfunction codes and the corresponding trouble is provided in "CAUTION FOR SERVICING" of the outdoor unit.

If the display shows any of the following, there is a possibility that the wiring was done incorrectly or that the power is not on, so check again.

Remote control display	Content
"E3" is display	● There is a short circuit at the FORCED OFF terminals (T1, T2)
"E3" is display	● The test-run has not be performed.
"E4" is display "E4" is display	<ul style="list-style-type: none"> <li>● The power on the outdoor unit is off.</li> <li>● The outdoor unit has not been wired for power supply.</li> <li>● Incorrect wiring for the transmission wiring and the wiring (the remote controller wiring or FORCED OFF wiring.)</li> <li>● The transmission wiring is cut.</li> </ul>
"E5" is display	● "MAIN/SUB" setting of the remote controller is wrong.
No display	<ul style="list-style-type: none"> <li>● The power on the indoor unit and HRV is off.</li> <li>● The indoor unit and HRV has not been wired for power supply.</li> <li>● Incorrect wiring for the remote controller wiring and the wiring (the transmission wiring or the FORCED OFF wiring.)</li> <li>● The remote controller wiring is cut.</li> </ul>

### 1.1.3 Next, run the Humidifier

<VKM-GMV1 series only>

1. Check that the water supply piping is connected securely.
2. Open the water supply shut-off valve. (No water will be supplied at this time.)
3. Run the HRV unit in heating mode.  
(See the operating manual included with the indoor unit for details on how to run the unit in heating mode.)  
The water supply will start and the humidifier will begin operation.
4. After starting heating (humidifying), the sound of the water supply solenoid valve will be heard every 3 or 4 minutes (a clicking sound), so listening for that clicking sound let the unit run for 30 minutes to make sure that humidifying operation is normal.



#### CAUTION

If carpentry work is not completed when a test run is finished, tell the customer not to run the humidifier for the protection of indoor unit and HRV until it is completed.  
If the humidifier is run, paint, particles generated from adhesive and other materials used for carpentry work may cause HRV to get dirty, causing splash or leakage of water.

# Part 8 Appendix

1. Appendix .....	88
1.1 Wiring Diagram.....	88
1.2 List of Electrical and Functional Parts .....	90
2. Piping diagram .....	91



# 1. Appendix

## 1.1 Wiring Diagram

VKM50GMV1  
VKM80GMV1  
VKM100GMV1

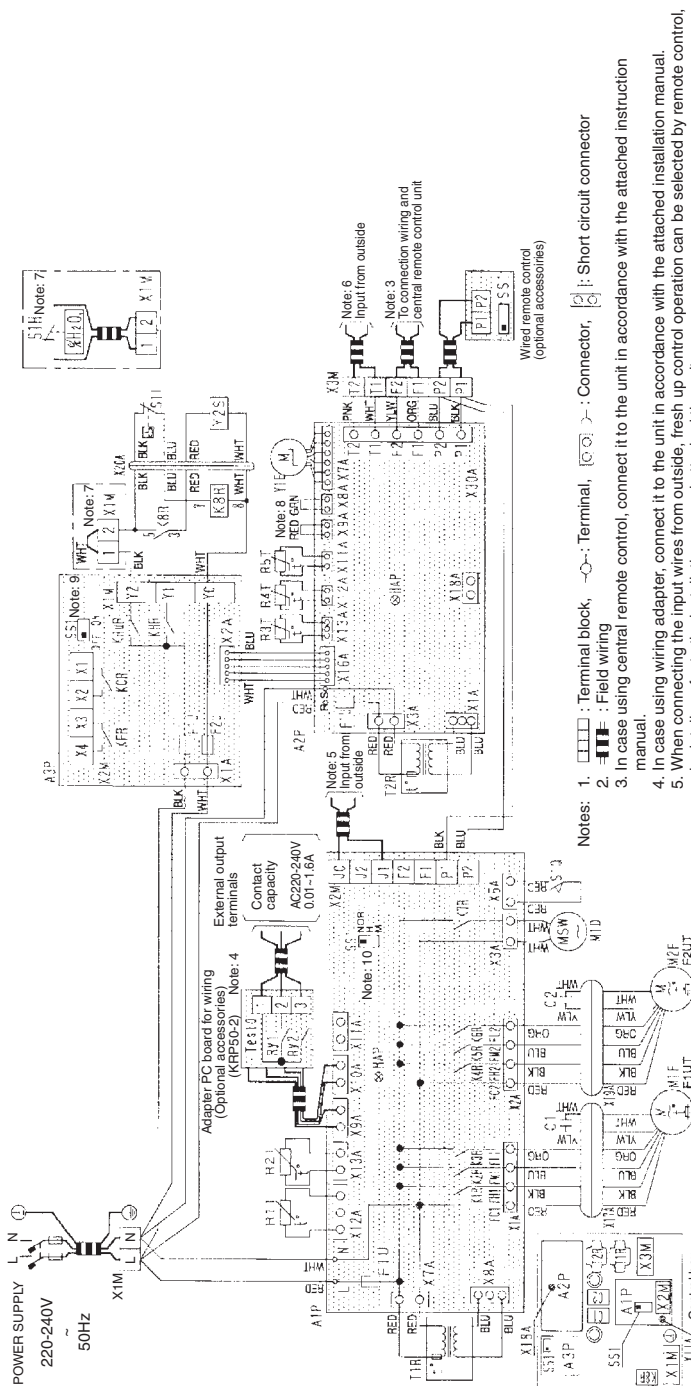

- Notes:
1. : Terminal block, : Field wiring
  2. : Short circuit connector
  3. In case using central remote control, connect it to the unit in accordance with the attached instruction manual.
  4. In case using wiring adapter, connect it to the unit in accordance with the attached installation manual.
  5. When connecting the input wires from outside, fresh up control operation can be selected by remote control, in details, refer to the installation manual attached the unit.
  6. When connecting the input wires from outside, forced off or on/off control operation can be selected by remote control, in details, refer to the installation manual attached the unit.
  7. In case installing a humidistat S1H (locally procured). Remove the short circuit wiring between (1) and (2) as shown in the figure right.
  8. Do not remove the short circuit connectors of X8A and X9A. The unit will not run if they are removed.
  9. SS1 (A3P) has already been set to "NOR". at factory set, the unit will not run if the setting are changed.
  10. SS1 (A1P) has already been set to "NOR". at factory set, the unit will not run if the setting are changed.
  11. Symbols show as follows. (PNK: pink, WHT: white, YLW: yellow, ORG: orange, BLU: blue, BLK: black, RED: red, GRN: green).
  12. Use copper conductors only.

A1P	Printed circuit board	K7R	Magnetic relay (M1D) (A1P)	SS1	Selector switch (humidistat input) (A3P)
A2P	Printed circuit board	K8R	Magnetic relay (S1L)	T1R	Transformer (220-240V/22V)
A3P	Printed circuit board (adapter for wiring)	K9R, KFR	Magnetic relay (A3P)	T2R	Transformer (220-240V/22V)
C1 - C2	Capacitor (M1F, M2F)	KHR, KHUR	Magnetic relay (A3P)	X1M	Terminal block (power supply)
F1U	Fuse (@. 10A, 250V) (A1P)	M1D	Motor (damper motor)	X1M, X2M	Terminal block (control) (A3P)
F1U, F2U	Fuse (@. 5A, 250V) (A2P)	M1F	Motor (supply air fan)	X2M	Terminal block (control) (A1P)
F1U, F2U	Fuse (@. 5A, 250V) (A3P)	M2F	Motor (exhaust air fan)	X3M	Terminal block (control)
F1UT - F2UT	Thermo switch (152°C) (M1F, M2F built-in)	R1T	Thermistor (indoor air)	X17A, X19A	Connector (relaying wire)
HAP	Light emitting diode (service monitor-green) (A1P)	R2T	Thermistor (outdoor air)	X20A	Connector (relaying wire)
HAP	Light emitting diode (service monitor-green) (A2P)	R4T, R5T	Thermistor (liquid / gas pipe of coil)	Y1E	Electronic expansion valve
K1R-K3R	Magnetic relay (M1F) (A1P)	S1L	Float switch (humidifier)	Y2S	Feed water solenoid valve
K4R-K6R	Magnetic relay (M2F) (A1P)	S1Q	Limit switch (damper motor)	Optional accessories	
		SS1	Selector switch (for especially use) (A1P)	Wired remote control	
				SS1	Selector switch (main/sub)
				Ry1	Magnetic relay (operation/stop)
				Ry2	Magnetic relay (for humidifier operation)
				Test0	Terminal Block (for external output)
				X11A	Connector (adapter power supply) (A1P)
				X18A	Connector (wiring adapter for electrical appendices) (A2P)
					Local supplied parts
					Humidistat

3D047684



## 1.2 List of Electrical and Functional Parts

Parts Name		Symbol	Model						Remark
			VKM 50GMV1	VKM 80GMV1	VKM 100GMV1	VKM 50GV1	VKM 80GV1	VKM 100GV1	
Remote Controller	Wired Remote Controller		BRC1A61, BRC1D527						Option
Motors	Fan Motor	M1F M2F	AC220V 280W 4P						
	Damper Motor	M1D	MG8(3P145772-2) AC220~240V						
Thermistors	Thermistor (Indoor Air)	R1T	ST8601-15C $\phi$ 4 L1000 20k $\Omega$ (25°C)						
	Thermistor (Outdoor Air)	R2T	3SH40049-3 $\phi$ 4 L2500 20k $\Omega$ (25°C)						
	Thermistor (Inlet Air Into Coil)	R3T	ST8601-6C $\phi$ 4 L1000 20k $\Omega$ (25°C)						
	Thermistor (Liquid Pipe of Coil)	R4T	ST8602A-5 $\phi$ 6 L1000 20k $\Omega$ (25°C)						
	Thermistor (Gas Pipe of Coil)	R5T	ST8605-5C $\phi$ 8 L1000 20k $\Omega$ (25°C)						
Others	Float Switch	S1L	FS-08304A						
	Fuse	F1U	250V 10A $\phi$ 5.2 (A1P)						
		F1U	250V 5A $\phi$ 5.2 (A2P)						
		F1U, F2U	250V 5A $\phi$ 5.2 (A3P)			—			
	Transformer	T1R	TR22H21R8						

## 2. Piping diagram

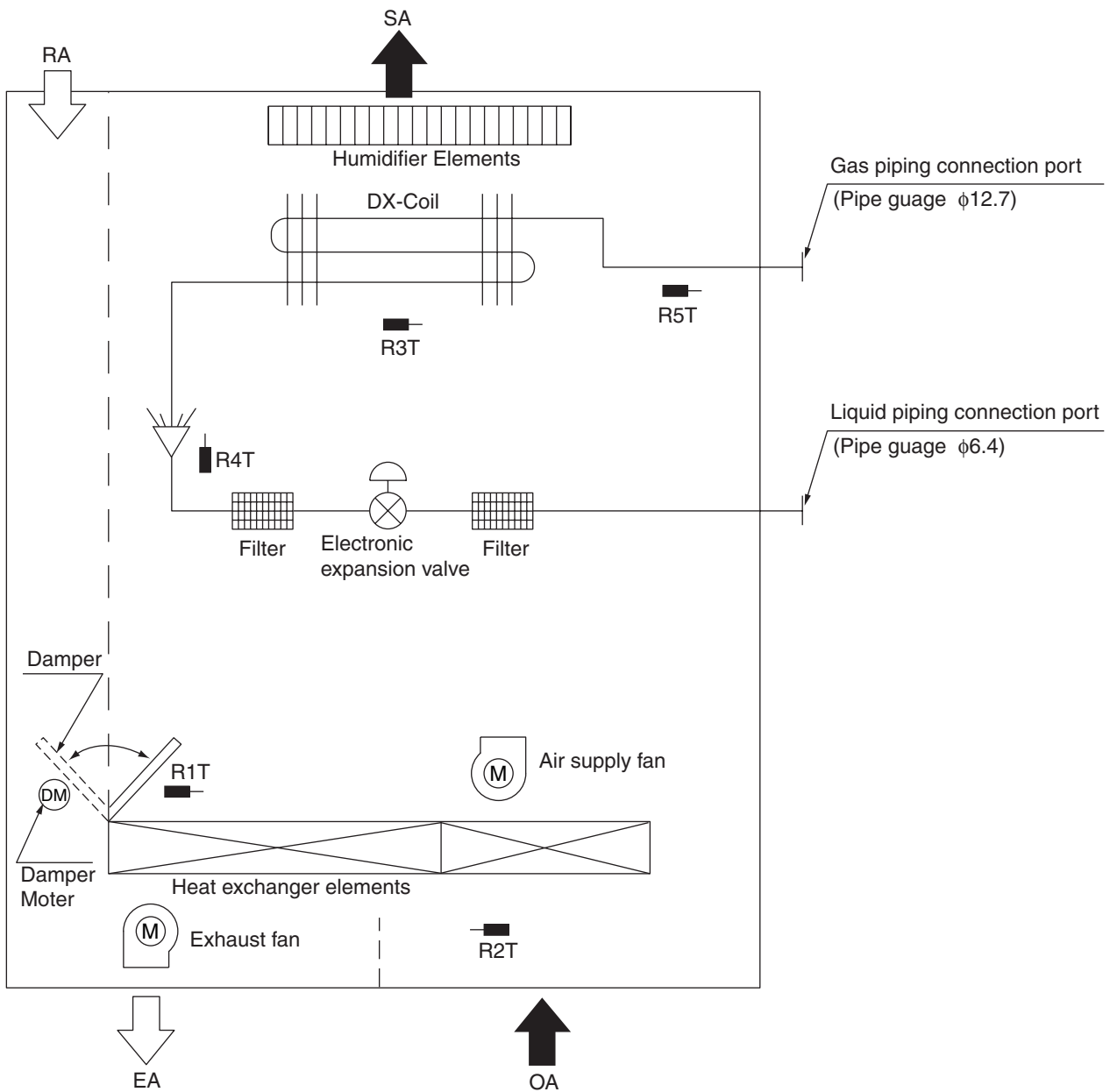

- R1T: Thermistor for indoor air
- R2T: Thermistor for outdoor air
- R3T: Thermistor for inlet air into DX-coil
- R4T: Thermistor for liquid line temperature
- R5T: Thermistor for gas line temperature



# Index

## Symbols

"A1" Indoor Unit PC Board Defect .....	60
"A9" Indoor Unit Malfunction of Moving Part of Electronic Expansion Valve (20E) .....	61
"C4" Indoor Unit Malfunction of Thermistor (R4T) for Heat Exchanger .....	62
"C5" Indoor Unit Malfunction of Thermistor (R5T) for Gas Pipes .....	63
"C9" Indoor Unit Malfunction of Thermistor (R3T) for Suction Air .....	64
"U3" Check Operation not executed .....	65
"U5" Malfunction of Transmission Between Remote Controller and Indoor Unit .....	68
"U8" Malfunction of Transmission Between Master and Slave Remote Controllers .....	69
"UA" Excessive Number of Indoor Units .....	70
"UC" Address Duplication of Central Remote Controller .....	71
"UE" Malfunction of Transmission Between Central Remote Controller and Indoor Unit .....	72, 74
<b>A</b>	
Air Conditioner Link Operation .....	48
Automatic Selection of Ventilation Mode .....	47
<b>B</b>	
Basic control of VKM .....	15
<b>C</b>	
Central Control System .....	17
Cold Area Mode .....	46
<b>D</b>	
Damper Motor .....	79
Damper System Error (Alarm) .....	58, 59
Data Transmission Error (Between LCD Remote Controller and Main Unit) .....	67
Dedicated LCD Remote Controller .....	66
<b>E</b>	
Error Code Indication .....	54
Explanation for Systems .....	12
External Damper Operation (FIELD SUPPLY) .....	49
<b>F</b>	
Features of VKM-G(M) .....	15
Field Setting .....	82
FRESH-UP Operation .....	47

## H

Heat Exchange Element .....	38
-----------------------------	----

## I

Indoor Air Thermistor Error .....	56
Inspection and Maintenance of the Humidifier .....	39
Inspection of Strainer .....	39
Inspection of the Drain Pan .....	41
Inspection of the feed water tank .....	40
Inspection of the Solenoid Valve .....	41

## L

List of Electrical and Functional Parts .....	90
---	----

## M

Main Unit PCB Assembly .....	75
Maintenance .....	36
Maintenance for The Air Filter .....	36

## N

Nighttime Free Cooling Operation .....	26, 44
Nomenclature .....	3

## O

Operation .....	20
Operation of The Remote Controller's Inspection / Test Operation Button .....	55
Operation Procedure .....	27
Outdoor Air Thermistor Error .....	57

## P

Power Transformer .....	78
Printed Circuit Board .....	50
Product Specification .....	6
Programming Start and Stop of the System with Timer .....	31

## R

Replacing the Humidifier Element .....	42
Restrictions to Control System .....	18

## T

The INSPECTION / TEST Button .....	52
Thermistor .....	76



# Drawings & Flow Charts

<b>A</b>		<b>P</b>	
A1 .....	60	Piping diagram .....	91
A9 .....	61	Power Transformer .....	78
About Direct Duct Connection System .....	24	Printed Circuit Board .....	50
Automatic Heat Purge Function at Night .....	26	VKM-GMV1 .....	50
Automatic Selection of Ventilation Mode .....	47	VKM-GV1 .....	50
<b>B</b>		<b>R</b>	
BRC1A62 .....	21, 27, 31, 82	Remote Controller and Changeover Switch .....	21
BRC1D527 .....	21, 25, 27, 32, 82	<b>S</b>	
<b>C</b>		Settings and setting numbers .....	83
C4 .....	62	<b>T</b>	
C5 .....	63	the water supply piping .....	39
C9 .....	64	Thermistor .....	76
Cold Area Mode .....	46	<b>U</b>	
<b>D</b>		U3 .....	65
Damper Motor .....	79	U5 .....	68
<b>E</b>		U8 .....	69
Error Code 64 .....	56	UA .....	70
Error Code 65 .....	57	UC .....	71
Error Code 6A .....	58, 59	UE .....	72, 74
Error Code U5 .....	67	<b>V</b>	
Explanation for Systems .....	12, 24	VKM100GMV1 .....	2
Batch/Individual Control System .....	13	VKM100GV1 .....	2
Independent Operation .....	12	VKM50GMV1 .....	2
Recommended Systems .....	14	VKM50GV1 .....	2
Simultaneous Operation of Multiple Units .....	12	VKM80GMV1 .....	2
Standard System .....	12	VKM80GV1 .....	2
Zone Control System .....	13	<b>W</b>	
<b>F</b>		When "88" remains on	
Field Setting .....	82	remote controller display .....	66
Float Switch .....	40	Wiring Diagram .....	88
<b>I</b>		VKM100GMV1 .....	88
Inspection of Strainer .....	39	VKM100GV1 .....	89
<b>M</b>		VKM50GMV1 .....	88
Main Unit PCB Assembly .....	75	VKM50GV1 .....	89
Master Remote Controller .....	29	VKM80GMV1 .....	88
<b>N</b>		VKM80GV1 .....	89
Name of Parts .....	20	<b>O</b>	
Nighttime Free Cooling Operation .....	26, 45	Operation chart (in heating operation only) .....	46
<b>O</b>			





"The present publication is drawn up by way of information only and does not constitute an offer binding upon Daikin Europe N.V. Daikin Europe N.V. has compiled the content of this publication to the best of its knowledge. No express or implied warranty is given for the completeness, accuracy, reliability or fitness for particular purpose of its content and the products and services presented therein. Specifications are subject to change without prior notice. Daikin Europe N.V. explicitly rejects any liability for any direct or indirect damage, in the broadest sense, arising from or related to the use and/or interpretation of this publication. All content is copyrighted by Daikin Europe N.V."



Daikin Europe N.V. is approved by LRQA for its Quality Management System in accordance with the ISO9001 standard. ISO9001 pertains to quality assurance regarding design, development, manufacturing as well as to services related to the product.



ISO14001 assures an effective environmental management system in order to help protect human health and the environment from the potential impact of our activities, products and services and to assist in maintaining and improving the quality of the environment.



Daikin units comply with the European regulations that guarantee the safety of the product.

VRV products are not within the scope of the Eurovent certification programme.

**DAIKIN EUROPE N.V.**

Zandvoordestraat 300  
B-8400 Ostend - Belgium  
www.daikineurope.com

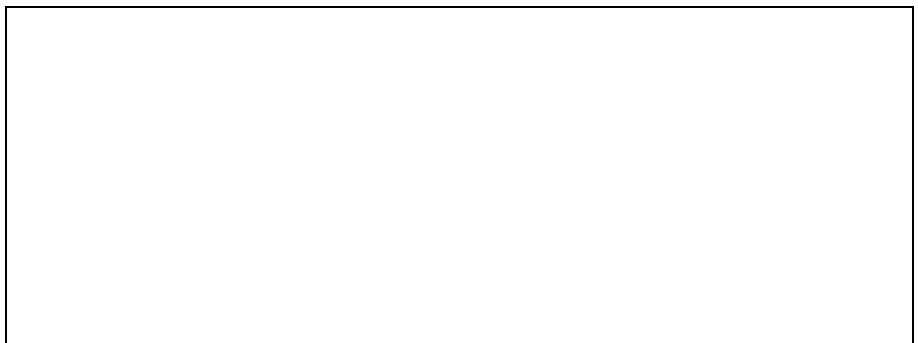

S i E 7 1 - 5 0 1 a