

# WIRED REMOTE CONTROLLER

## OPERATION MANUAL

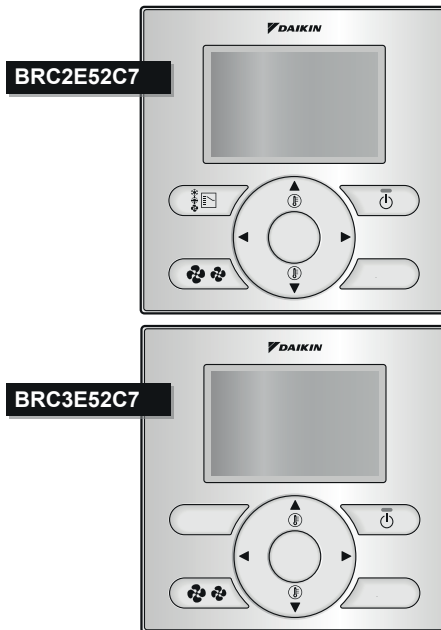

- Thank you for purchasing the wired remote controller.
- This manual describes safety precautions required for the use of the product.

**Read this manual carefully and be sure you understand the information provided before attempting to use the product.**

Keep this manual where it is readily accessible after reading it through. If another user operates the product in the future, be sure to hand over this manual to the new user.

# Contents

---

## Notices

Safety Precautions .....	2
Items to be Strictly Observed .....	3
Names and Functions.....	7
Liquid Crystal Display .....	9

## Basic Operation Method

Enable/disable the Menu/Enter and Cancel button.....	12
Cool/Heat/Auto/Fan Operation .....	13
Program Dry Operation .....	16
Setback.....	17
Ventilation Operation .....	18
Setting the Cooling/Heating Selection Eligibility .....	19
Key Lock.....	22

## Quick Reference of Main Menu Items

The Main Menu Items Overview .....	23
------------------------------------	----

## Menu Manipulation

Main Menu.....	27
Airflow Direction.....	28
Individual Air Direction .....	29
Quick Start.....	32
Ventilation.....	33
Energy Saving Options.....	36
Schedule.....	44
Filter Auto Clean .....	49
Maintenance Information .....	50
Configuration .....	51
Current Settings.....	54
Clock & Calendar.....	55
Language.....	57

## Maintenance

Reset Filter Indication .....	58
Maintenance of Unit and the LCD display .....	59

## Reference Information

Error Code Display .....	60
After-sale Service .....	61



# Safety Precautions

The original instructions are written in English. All other languages are translations of the original instructions.





This appliance is not intended to be used by persons, including children, with reduced physical, sensory or mental capabilities or lack of experience and knowledge, unless they are supervised or have been given instructions on how to use the appliance by a person responsible for their safety. Children should be supervised to ensure that they do not play with the appliance.

**Please read these Safety Precautions carefully before installing the remote controller.**





- This manual classifies the precautions into WARNING and CAUTION. They both contain important information regarding safety. Be sure to follow all the precautions below.

 <b>WARNING</b>	Failure to follow these instructions properly may result in personal injury or loss of life.
 <b>CAUTION</b>	Failure to observe these instructions properly may result in property damage or personal injury, which may be serious depending on the circumstances.







- The following pictograms are used in this manual.

	Never do.		Always follow the instructions given.
	Be sure to ground the unit.		Absolutely keep wet hands away.
	Absolutely keep water and moisture away.		







## ■ About Remote Controller

 <b>WARNING</b>	
	<ul style="list-style-type: none"> <li>• <b>Do not install the remote controller by yourself.</b> Improper installation may result in electric shocks or fire. Consult your Daikin dealer.</li> </ul>
	<ul style="list-style-type: none"> <li>• <b>Do not modify or repair the remote controller.</b> This may result in electric shocks or fire. Consult your Daikin dealer.</li> </ul>
	<ul style="list-style-type: none"> <li>• <b>Do not relocate or reinstall the remote controller by yourself.</b> Improper installation may result in electric shocks or fire. Consult your Daikin dealer.</li> </ul>
	<ul style="list-style-type: none"> <li>• <b>Do not use flammable materials (e.g., hairspray or insecticide) near the product.</b> Do not clean the product with organic solvents such as paint thinner. The use of organic solvents may cause crack damage to the product, electric shocks or fire.</li> </ul>

# Items to be Strictly Observed









 <b>CAUTION</b>	
	<ul style="list-style-type: none"> <li>• <b>Do not play with the unit or its remote controller.</b> Accidental operation by a child may result in impairment of bodily functions and harm health.</li> </ul>
	<ul style="list-style-type: none"> <li>• <b>Never disassemble the remote controller.</b> Touching the interior parts may result in electric shocks or fire. Consult your Daikin dealer or authorized contractor for internal inspections and adjustments.</li> </ul>
	<ul style="list-style-type: none"> <li>• <b>To avoid electric shocks, do not operate with wet hands.</b></li> </ul>
	<ul style="list-style-type: none"> <li>• <b>Do not wash the remote controller.</b> Doing so may cause electric leakage and result in electric shocks or fire.</li> </ul>
	<ul style="list-style-type: none"> <li>• <b>Do not leave the remote controller wherever there is a risk of wetting.</b> If water gets into the remote controller there is a risk of electrical leakage and damage to electronic components.</li> </ul>















## ■ Indoor Unit and Outdoor Unit

 <b>WARNING</b>	
	<ul style="list-style-type: none"> <li>• <b>Be aware that prolonged, direct exposure to cool or warm air from the air conditioner or to air that is too cold or too warm can be harmful to your physical condition and health.</b></li> </ul>
	<ul style="list-style-type: none"> <li>• <b>Do not place objects, including rods, your fingers, etc. in the air inlet or outlet.</b> Injury may result due to contact with the air conditioner's highspeed fan blades.</li> </ul>
	<ul style="list-style-type: none"> <li>• <b>Contact professional personnel about attachment of accessories and be sure to use only accessories specified by the manufacturer.</b> If a defect results from your own workmanship, it may result in water leaks, electric shock or fire.</li> </ul>
	<ul style="list-style-type: none"> <li>• <b>Do not use the product in atmospheres contaminated with oil vapor, such as cooking oil or machine oil vapor.</b> Oil vapor may cause crack damage, electric shocks or fire.</li> </ul>
	<ul style="list-style-type: none"> <li>• <b>Do not use the product in places with excessive oily smoke, such as cooking rooms or in places with flammable gas, corrosive gas or metal dust.</b> Using the product in such places may cause fire or product failures.</li> </ul>
	<ul style="list-style-type: none"> <li>• <b>Beware of fire in case of refrigerant leakage.</b> If the air conditioner is not operating correctly, i.e. not generating cool or warm air, refrigerant leakage could be the cause. Consult your dealer for assistance. The refrigerant within the air conditioner is safe and normally does not leak. However, in the event of a leakage, contact with a naked burner, heater or cooker may result in generation of noxious gas. Do not longer use the air conditioner until a qualified service person confirms that the leakage has been repaired.</li> </ul>













**WARNING**

	<ul style="list-style-type: none"> <li>• <b>In the case of using a load breaker provided with a fuse, make sure that the capacity of the fuse is correct.</b> Use of an ordinary conductive wire may cause malfunctions or fire.</li> </ul>
	<ul style="list-style-type: none"> <li>• <b>Do not use the power supply breaker to start or stop the air conditioner.</b> Otherwise, fire or water leakage may result. Furthermore, the fan will rotate abruptly if power failure compensation is enabled, which may result in injury.</li> </ul>
	<ul style="list-style-type: none"> <li>• <b>Be sure to earth the unit.</b> Do not earth the unit to a utility pipe, lightning conductor or telephone earth lead. Imperfect earthing may result in electric shocks or fire. A high surge current from lightning or other sources may cause damage to the air conditioner.</li> </ul>
	<ul style="list-style-type: none"> <li>• <b>When the air conditioner is malfunctioning (giving off a burning odour, etc), turn off the power and contact your local dealer.</b> Continued operation under such circumstances may result in a failure, electric shocks or fire hazards.</li> </ul>
	<ul style="list-style-type: none"> <li>• <b>Consult your local dealer regarding what to do in case of refrigerant leakage.</b> When the air conditioner is to be installed in a small room, it is necessary to take proper measures so that the amount of any leaked refrigerant does not exceed the concentration limit in the event of a leakage. Otherwise, this may lead to an accident due to oxygen depletion.</li> </ul>
	<ul style="list-style-type: none"> <li>• <b>Be sure to install an earth leakage breaker.</b> Failure to install an earth leakage breaker may result in electric shocks or fire.</li> </ul>
	<ul style="list-style-type: none"> <li>• <b>Consult the dealer if the air conditioner submerges owing to a natural disaster such as a flood or typhoon.</b> Do not operate the air conditioner in that case or otherwise a malfunction, electric shock or fire may result.</li> </ul>
	<ul style="list-style-type: none"> <li>• <b>Be sure to use a dedicated power supply for the air conditioner.</b> The use of any other power supply may cause heat generation, fire or product failures.</li> </ul>

 <b>CAUTION</b>	
	<ul style="list-style-type: none"> <li>• <b>After prolonged use, check the unit stand and its mounts for damage.</b> If left in a damaged condition, the unit may fall and cause injury.</li> </ul>
	<ul style="list-style-type: none"> <li>• <b>Do not allow a child to mount on the outdoor unit or avoid placing any object on it.</b> Falling or tumbling may result in injury.</li> </ul>
	<ul style="list-style-type: none"> <li>• <b>Do not block air inlets nor outlets.</b> Impaired airflow may result in insufficient performance or trouble.</li> </ul>
	<ul style="list-style-type: none"> <li>• <b>To avoid injury, do not touch the air inlet or aluminium fins of the unit.</b></li> </ul>
	<ul style="list-style-type: none"> <li>• <b>Do not remove the outdoor unit's fan guard.</b> The guard protects against the unit's high speed fan, which may cause injury.</li> </ul>
	<ul style="list-style-type: none"> <li>• <b>Do not place objects that are susceptible to moisture directly beneath the indoor or outdoor units.</b> Under certain conditions, condensation on the main unit or refrigerant pipes, air filter dirt or drain blockage may cause dripping, resulting in fouling or failure of the object concerned.</li> </ul>
	<ul style="list-style-type: none"> <li>• <b>Do not place water containers (flower vases, etc). on the unit, as this may result in electric shocks or fire.</b></li> </ul>
	<ul style="list-style-type: none"> <li>• <b>Do not use the air conditioner for purposes other than those for which it is intended.</b> Do not use the air conditioner for cooling precision instruments, food, plants, animals or works of art as this may adversely affect the performance, quality and/or longevity of the object concerned.</li> </ul>
	<ul style="list-style-type: none"> <li>• <b>Do not place appliances that produce naked flames in places exposed to the airflow from the unit as this may impair combustion of the burner.</b></li> </ul>
	<ul style="list-style-type: none"> <li>• <b>Do not place heaters directly below the unit as resulting heat can cause deformation.</b></li> </ul>
	<ul style="list-style-type: none"> <li>• <b>Be sure that children, plants or animals are not exposed directly to airflow from the unit as adverse effects may ensue.</b></li> </ul>
	<ul style="list-style-type: none"> <li>• <b>Do not put flammable containers, such as spray cans, within 1m from the blow-off mouth.</b> The containers may explode because the warm air output of the indoor or outdoor unit will affect them.</li> </ul>
	<ul style="list-style-type: none"> <li>• <b>Do not install the air conditioner at any place where there is a danger of flammable gas leakage.</b> In the event of a gas leakage, build-up of gas near the air conditioner may result in fire hazards.</li> </ul>

**CAUTION**

	<ul style="list-style-type: none"> <li>• <b>Do not sit or stand on any unstable base at the time of operating or maintaining the air conditioner.</b> The base may topple down and injury may occur.</li> </ul>
	<ul style="list-style-type: none"> <li>• <b>Do not touch the motor when replacing the filter.</b> The motor can be very hot which may result in burns.</li> </ul>
	<ul style="list-style-type: none"> <li>• <b>Do not wash the air conditioner with water as this may result in electric shocks or fire.</b></li> </ul>
	<ul style="list-style-type: none"> <li>• <b>Perform ventilation from time to time.</b> Be careful when using the air conditioner with other heating equipment. Insufficient ventilation may result in oxygen deficiency.</li> </ul>
	<ul style="list-style-type: none"> <li>• <b>Always stop the operation of the air conditioner and turn OFF the power supply breaker when cleaning.</b> Failure to do so may result in an electric shock or injury.</li> </ul>
	<ul style="list-style-type: none"> <li>• <b>Do not wash the interior of the indoor and outdoor units by yourself. Always consult your Daikin dealer.</b> The use of an incorrect washing method or incorrect detergent may damage the resin parts of the indoor unit or cause water leakage. Moreover, malfunctions, smoke generation or ignition may result if the electric parts or the motor in the indoor unit come in contact with a detergent or water.</li> </ul>
	<ul style="list-style-type: none"> <li>• <b>Do not place objects in direct proximity of the outdoor unit and do not let leaves and other debris accumulate around the unit.</b> Leaves are a hotbed for small animals which can enter the unit. Once in the unit, such animals can cause malfunctions, smoke or fire when making contact with electrical parts.</li> </ul>
	<ul style="list-style-type: none"> <li>• <b>Fix the units securely.</b> If the units are not mounted securely, the units may fall or topple and result in personal injury.</li> </ul>
	<ul style="list-style-type: none"> <li>• <b>Arrange the drain to ensure complete drainage.</b> If proper drainage from the outdoor drain pipe does not occur during air conditioner operation, there could be a blockage due to dirt and debris build-up in the pipe. This may result in water leakage from the indoor unit. Under these circumstances, stop the air conditioner operation and consult your dealer for assistance.</li> </ul>

# Names and Functions

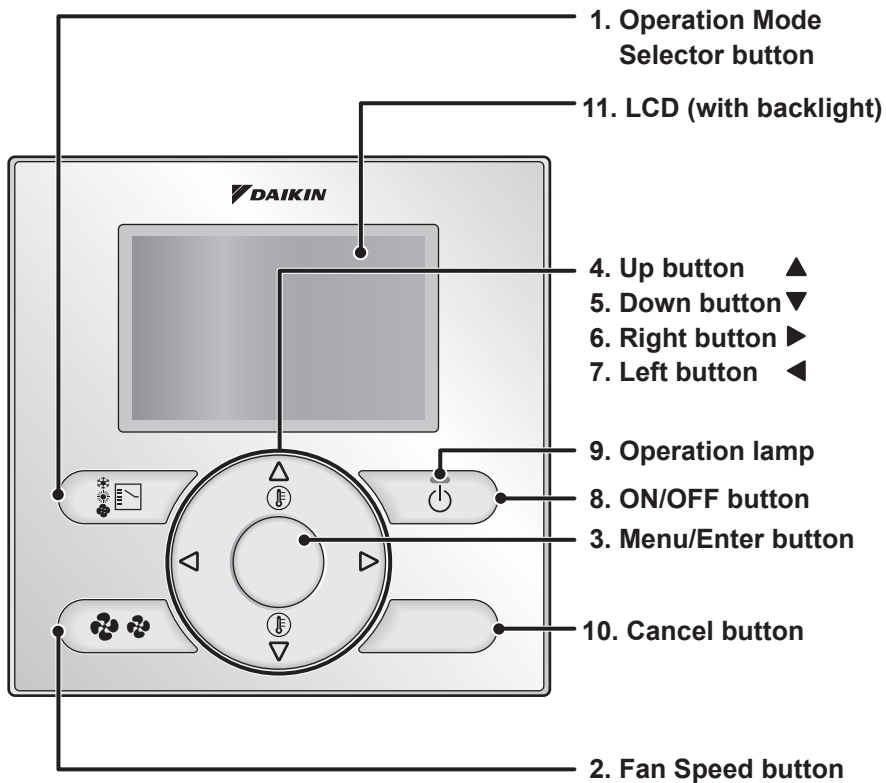

Functions other than the basic operation items (i.e., ON/OFF, operation mode selection, fan speed and temperature settings) are set from the menu screen.

## NOTE

- Do not install the remote controller in places exposed to direct sunlight. Otherwise, the LCD may become discolored and nothing may be displayed.
- Do not pull or twist the remote controller cord. Otherwise, the remote controller may malfunction.
- Do not press the buttons on the remote controller with objects with sharp ends. Otherwise, the remote controller may be damaged or malfunction.

## 1. Operation Mode Selector button

- Only available on the BRC2E
- Press this button to select the operation mode of your preference. (See "[Cool/Heat/Auto/Fan Operation](#)" on page 13)
- Available modes may vary with the connected model.

## 2. Fan Speed button

- Used to change the fan speed. (See "[Cool/Heat/Auto/Fan Operation](#)" on page 13)
- Available fan speeds may vary with the connected model.

## 3. Menu/Enter button

- This button is disabled by default. To enable, refer to "[Enable/disable the Menu/Enter and Cancel button](#)" on page 12.
- Used to display the Main Menu or enter the selected item (See "[The Main Menu Items Overview.](#)" on page 23).

## 4. Up button ▲

- Used to raise the set temperature.
- The next item on the upper side will be highlighted.  
(Keep pressing the button to cycle through the values or items).
- Used to change the selected item.

## 5. Down button ▼

- Used to lower the set temperature.
- The next item on the lower side will be highlighted.  
(Keep pressing the button to cycle through the values or items).
- Used to change the selected item.

## 6. Right button ►

- Used to highlight the next items on the right-hand side.
- The display contents are changed to the next screen.

## 7. Left button ◀

- Used to highlight the next items on the left-hand side.
- The display contents are changed to the previous screen.

## 8. ON/OFF button

- Press to start or stop the air conditioner.

## 9. Operation lamp (Green)

- This lamp lights up during operation.
- This lamp is not lit when the unit operation is OFF.
- This lamp blinks if an error occurs.

## 10. Cancel button

- This button is disabled by default. To enable, refer to "[Enable/disable the Menu/Enter and Cancel button](#)" on page 12.
- Used to return to the previous screen.

## 11. LCD (with backlight)

- The backlight will be lit for approximately 30 seconds when one of the buttons is pressed.
- The actions linked to the buttons, except for the ON/OFF button, are not carried out when the backlight is not lit.
- When two remote controllers are used to control a single indoor unit, the backlight of the remote controller which is operated first will be lit.

# Liquid Crystal Display

- There are two display methods for the liquid crystal display (LCD) available. The Standard display, which is used by default, and the Detailed display.
- To change the active display method, select the desired display method in the Display Method screen (See "Display" on page 52).
- The displayed contents on the screen may vary with the operation mode of the connected models. (E.g.: The following display will appear when the air conditioner is in automatic heating operation).

## Standard display

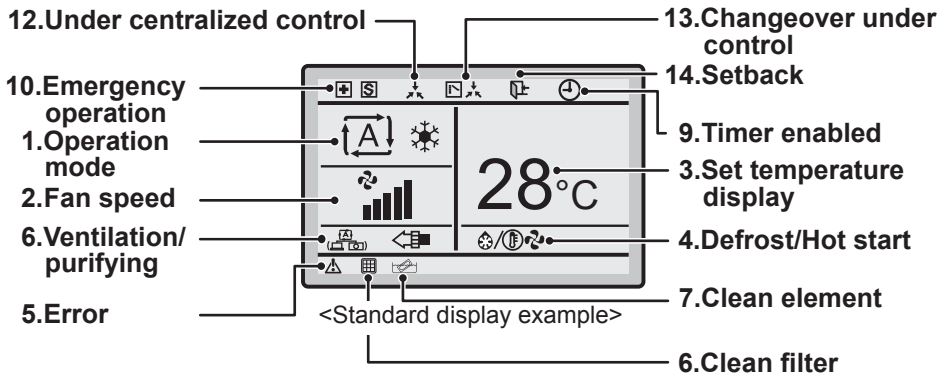

## Detailed display

■ The clock and Detailed selection items appear on the Detailed display in addition to the items appearing on the Standard display.

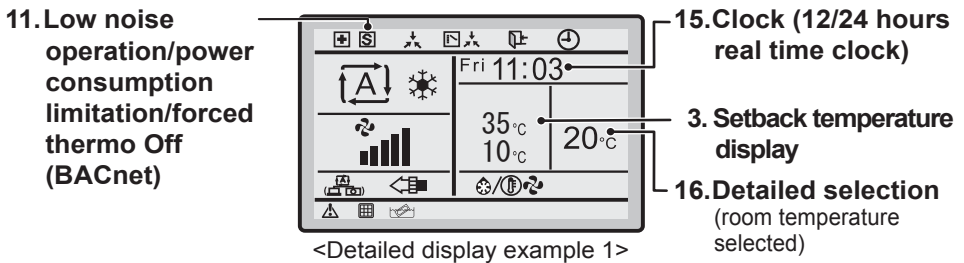

## 2. Fan speed

(with no fan speed control function)

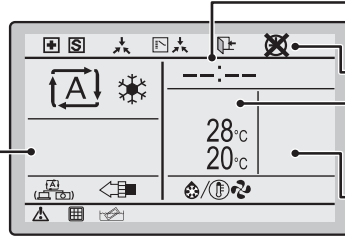

<Detailed display example 2>

15. **Clock display**  
(with no clock settings)
17. **Timer problem**
3. **Set temperature display**  
(Dual setpoint mode)
16. **Detailed selection**  
(with no detailed items selected)

## 1. Operation mode

- Indicates the current operation mode.

Operation Mode			
Cool	Heat	Vent	Air Clean
Fan	Dry	Auto (Cool)	Auto (Heat)

## 2. Fan speed

(See ["Cool/Heat/Auto/Fan Operation" on page 13](#))

- Indicates the fan speed that is set for the air conditioner.
- The fan speed will not be displayed if the air conditioner does not have the fan speed control function.

## 3. Set/Setback temperature display

(See ["Setback" on page 17](#))

- When the unit is turned ON, the temperature that is set for the air conditioner is displayed.
- When the unit is turned OFF and Setback is disabled, the temperature that is set for the air conditioner is displayed.
- When the unit is turned OFF and Setback is enabled, the temperature that is set for the setback function is displayed.
- By default, the display method is Single Setpoint mode. To enable Dual Setpoint mode, refer to the Installation manual.

## 4. Defrost/Hot start ""

(See ["Hot start \(VRV only\)" on page 15](#))

- Indicates that Defrost/Hot start operation is active.
- The Defrost/Hot start operation is only possible when a Heat Reclaim Ventilation (HRV) unit is connected. For details, refer to the Operation Manual of the Heat Reclaim Ventilation unit.

## 5. Error ""

(See ["Error Code Display" on page 60](#))

- Indicates a unit error or warning.

## 6. "Clean filter ""

(See ["Reset Filter Indication" on page 58](#))

- Indicates that the time to clean the filter has come.



## 7. "Clean element ""

(See ["Reset Filter Indication" on page 58](#))

- Indicates that the time to clean the element has come.

## 8. Ventilation/Purifying

(See "[Ventilation Operation](#)" on page 18 and "[Ventilation](#)" on page 33)

- The Ventilation mode icon. ""  
Indicate the current ventilation mode (HRV only) (AUTOMATIC, ENERGY RECLAIM VENTILATION, BYPASS).
- **The Air Purifying ICON** ""  
This icon indicates that the air cleaning option kit is operational.

## 9. Timer enabled "

(See "[OFF Timer](#)" on page 42 and "[Schedule](#)" on page 44)

- Indicates that the schedule timer or the OFF timer is enabled.

## 10. Emergency operation "

- If there is a problem with an outdoor compressor, the unit is in emergency operation. Refer to the service manual of the outdoor unit or contact your local dealer.

## 11. Low noise operation/power consumption limitation/forced thermo off (BACnet) "

- Indicates that the system is running under low noise operation, under power consumption limitation conditions or receive a forced thermo off command from a BACnet interface. Refer to the service manual of the outdoor unit or contact your local dealer.

## 12. Under Centralized control "

- Indicates that the air conditioner is under the management of central control equipment (optional accessories) and the operation of the system through the remote controller is prohibited.

## 13. Changeover under control "

(VRV only) (See "[Setting the Cooling/Heating Selection Eligibility](#)" on page 19)

- Indicates that the changeover of the cooling/heating eligibility is assigned to another indoor unit or to the master remote controller.

## 14. Setback "

(See "[Setback](#)" on page 17)

- The setback icon flashes when the unit is turned on under the setback control.

## 15. Clock (12/24 hours real time clock)

(See "[Clock & Calendar](#)" on page 55)

- Indicates that the clock is set.
- If the clock is not set, "-- : --" will be displayed.

## 16. Detailed selection

(See "[Display Mode](#)" on page 52)

- Is displayed when the detailed display mode is selected.
- No detailed items are selected by default.

## 17. Timer problem "

- Indicates that the clock needs to be set again.
- The schedule timer function will not work unless the clock is set again.



# Basic Operation Method

## Remote Controller Functions

## Operation procedure

## Button display

Operate the buttons according to the procedure.

Displays the positions of the buttons to be operated.

### Operation Method

## Screen display 1

Screens that will be displayed on the remote controller.

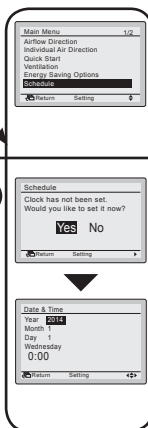

- Display the Main Menu. (See "[Manipulating the Main Menu](#)" on page 27).
- Press the **▼▲** (Up/Down) buttons to select **Schedule** and press the Menu/Enter button.

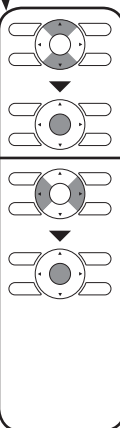

- Press the **◀▶** (Left/Right) buttons to select **Yes** and press the Menu/Enter button.
- The Date & Time screen will appear.
- Set the current year, month, day, and time. (See "[Clock & Calendar](#)" on page 55).

### Note

- Before setting the schedule, the clock must be set.
- If the clock has not been set, a screen like the one on the left will appear.

## Preparation

- For mechanical protection purposes, turn ON the system at least 6 hours before starting the operation of the system.
- Do not turn OFF the system in season in order to ensure the smooth starting of the system.

## Enable/disable the Menu/Enter and Cancel button

### Operation Method

By default, the Menu/Enter and Cancel button are disabled.

# 1

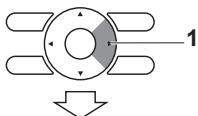

- To enable/disable the Menu/Enter and Cancel button, keep the **▶** (Right) button pressed in the Basic Screen.

# 2



- Press the 3 keys simultaneously while keeping the **▶** (Right) button pressed.

### Note

Don't forget to disable the buttons again after installation or maintenance is done.

# Cool/Heat/Auto/Fan Operation

## Operation Method

1

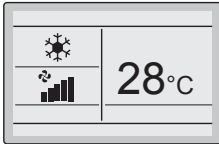

- Press the Operation Mode Selector button several times until the desired mode (Cooling, Heating, Fan Only, Dry or Auto) is selected.



**Note**

- Unavailable operation modes are not displayed.
- Only Cooling, Dry or Fan Only mode can be selected if the air conditioner is a cooling-only model.
- Before making a mode change, make sure that Changeover under control is not displayed on the remote controller. The cooling or heating mode cannot be selected if the above is displayed on the remote controller. See "[Setting the Cooling/Heating Selection Eligibility](#)" on page 19 if the Changeover under control icon blinks.

2



- Press the ON/OFF button. The Operation lamp (green) will be lit and the air conditioner will start operating.



3

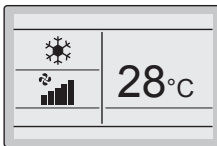

- The set temperature will increase by 1°C when the ▲ (Up) button is pressed and decrease by 1°C when the ▼ (Down) button is pressed.



**Note**

Temperature settings are not possible while in Dry or Fan Only mode.

4

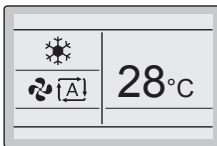

- To change the fan speed, press the Fan Speed button.

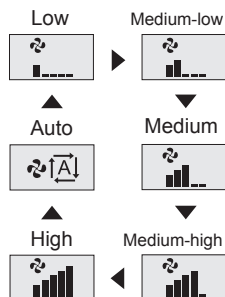

**Note**

- The air conditioner may be in automatic fan speed control for mechanical protection purposes.
- The air conditioner may be in automatic fan speed control according to the room temperature.
- The fan may stop operating, which is not a failure.
- It may take time until fan speed changes are actually carried out.
- In Auto mode, the fan speed is adjusted automatically according to the setpoint and indoor temperature
- In case of Fan Only mode the fan speed is high.
- Depending on the type of indoor unit, there are two fan speeds (low and high), three fan speeds (low, medium and high) or five fan speeds available (low, medium-low, medium, medium-high, high). Some indoor units also support automatic fan speed.

5



- When the ON/OFF button is pressed again, the air conditioner will stop operating and the Operation lamp will turn OFF.

**Note**

- When the system is stopped while in heating operation, the fan will continue to operate for approximately 1 minute in order to eliminate the residual heat in the indoor unit.
- To prevent water leakage or system failure, do not turn OFF the power soon after the air conditioner stops operating. Be sure to wait at least 5 minutes so that the drain pump finishes discharging the residual water from the indoor unit.

## Characteristics of Cooling Operation

- If the cooling operation is used when the room temperature is too low, frost forms on the heat exchanger of the indoor unit which can decrease the cooling capacity. In this case, the air conditioner automatically switches to defrost operation for a while. During defrost operation, a low airflow rate or a gentle wind is used to prevent the discharge of melt water. (The remote controller displays the fan speed that is set).
- When the outdoor air temperature is high, it takes some time until the room temperature reaches the set temperature.

## Characteristics of Heating Operation

- Starting operation**
- Heating operation generally requires a longer time to attain the set temperature compared with cooling operation.  
It is recommended to start operating the air conditioner in advance by using the timer.

### Perform the following operation in order to prevent the degradation of the heating capability or cold drafts.

- Defrost operation**
- The air conditioner will automatically go into defrost operation to prevent frost accumulation at the outdoor unit which results in loss of the heating capacity.
  - The indoor unit fan will stop, and "❄️/🔄" (Defrost/Hot start) will be displayed on the remote controller.
  - The air conditioner will return to normal operation after approximately 6 to 8 minutes (Max 10 minutes).

- Hot start (VRV only)**
- When the air conditioner goes into heating operation or defrost operation, the indoor unit fan will stop in order to prevent a cold draft. (In that case, "❄️/🔄" (Defrost/Hot start) will be displayed on the remote controller).

- Outdoor temperature and heating capability**
- The heating capacity of the air conditioner will drop when the outdoor temperature decreases.  
If the heating effect is insufficient, it is recommended to use another heating appliance in combination with the air conditioner. (When a combustion appliance is used, ventilate the room regularly).  
Do not use the heating appliance in places where the heating appliance is exposed to the airflow of the air conditioner.
  - The air conditioner is a hot air circulation type. Therefore, it takes some time to warm up the room after the air conditioner starts operating.  
The indoor fan will automatically operate until the indoor temperature of the system rises to a certain level.
  - If hot air stays around the ceiling and your feet feel cold, a circulator is recommended.  
For details, consult your Daikin dealer.

# Program Dry Operation

## Preparation

- For mechanical protection purposes, turn ON the air conditioner at least 6 hours before starting the operation of the air conditioner.
- Do not turn OFF the air conditioner in season in order to ensure the smooth starting of the air conditioner.
- The dry mode may not be selected if the remote controller has no eligibility to select cooling/heating mode (See "[Setting the Cooling/Heating Selection Eligibility](#)" on page 19 for details).

## Operation Method

1

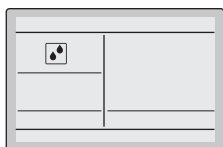

- Press the Operation Mode Selector button several times until Dry mode is selected.



### Note

Dry mode may not be available depending on the type of indoor unit.

2



- Press the ON/OFF button.  
The Operation lamp will be lit and the air conditioner will start operating.



### Note

The air conditioner is in automatic temperature and fan speed control. Therefore, the temperature or fan speed cannot be changed while the air conditioner is in operation.

3

- To set the airflow direction, see "[Airflow Direction](#)" on page 28.

4



- When the ON/OFF button is pressed again, the air conditioner will stop operating and the Operation lamp will turn OFF.



### Note

To prevent water leakage or system failure, do not turn OFF the power soon after the air conditioner stops operating. Be sure to wait at least 5 minutes so that the drain pump finishes discharging the residual water from the indoor unit.

## Characteristics of Dry Operation

In Dry operation, the air humidity will be lowered by intermittently turning the air conditioner ON in cooling and OFF again to minimize the temperature decrease.

### Note

- The temperature and fan speed are controlled automatically and cannot be controlled by the remote controller.
- Dry operation will not function if the room temperature is too low.

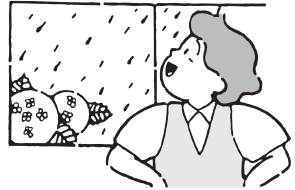

## Setback

The Setback function will maintain the room temperature in a specific range when the remote controller is turned OFF. This is done by temporarily starting the air conditioner that was previously turned OFF by the user, the schedule function or the OFF timer.



For example:

[ Setback setpoint temperature: cool 35°C, heat 10°C ]

[ Recovery differential: cool -2°C, heat +2°C ]

- If the room temperature drops below 10°C, heating is started automatically. If after half an hour the temperature increases to 12°C or above, the controller returns to its original state.
- If the room temperature goes above 35°C, cooling is started automatically. If after half an hour the temperature drops to 33°C or below, the controller returns to its original state.

### Note

- This function is enabled by default. This function can only be enabled/disabled in the Energy Saving List (See ["Energy Saving Options" on page 36](#)).
- The differential can be adjusted in the Setback Condition menu (See ["Setback Condition" on page 38](#)).
- The setback temperature can be set while the unit is turned off on the Basic Screen or set in the schedule.
- Setback will turn the unit ON for at least 30 minutes unless the setback temperature setpoint is changed or the unit is turned ON with the ON/OFF button.
- When setback turns the air conditioner ON while in Auto mode, the remote controller switches to Cooling or Heating only, depending on what is appropriate, and only the respective setback temperature setpoint is shown.

**Operation Method** Setback should not be enabled when a centralized controller is connected.

1

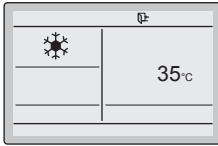

The setback icon "☐+" flashes when the unit is turned ON under the setback control.

The fan speed cannot be changed when setback is active and as a result, the fan speed is not visible.

## Ventilation Operation (HRV only)

### Preparation

- For mechanical protection purposes, turn ON the air conditioner at least 6 hours before starting the operation of the system.
- Do not turn OFF the air conditioner in season in order to ensure the smooth starting of the air conditioner.
- Press the Operation Mode Selector button several times until the ventilation mode is selected.

### Operation Method

1

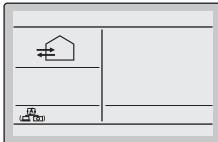

- The Ventilation mode is used on Heat Reclaim Ventilation (HRV) units for when cooling or heating is unnecessary.



2

- The Ventilation mode can be changed in the Main Menu (See "[Ventilation Mode](#)" on page 34).

#### Note

Ventilation modes: Auto, Energy Reclaim Ventilation and Bypass

3

- The Ventilation rate can be changed in the Main Menu (See "[Ventilation Rate](#)" on page 33).

#### Note

Ventilation rates: Low or High

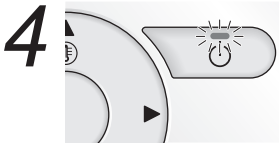

- Press the ON/OFF button.  
The Operation lamp will be lit and the Heat Reclaim Ventilation unit will start operating.



- When the ON/OFF button is pressed again the Heat Reclaim Ventilation will stop operating and the Operation lamp will turn OFF.



## Setting the Cooling/Heating Selection Eligibility

(VRV only)

See "[Cool/Heat Selection Eligibility](#)" on page 21 for an explanation of the cooling/heating selection eligibility.

### Setting Changes

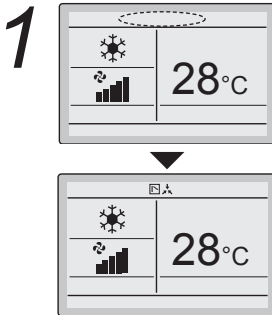

- Press the Operation Mode Selector button on the remote controller for at least 4 seconds (during backlight lit).  
The remote controller will not display "☀️" (Changeover under control) if a cooling/heating selection eligibility is granted to the remote controller.

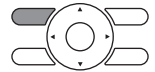

- The icon "☀️" (Changeover under control) on each remote controller of indoor units connected to the same outdoor unit or BS (Branch Selection) box will start blinking.
- Set a cooling/heating selection eligibility as explained below.

#### Note

- Ventilation mode changes are possible regardless of the cooling/heating selection eligibility.
- If a cooling/heating selection eligibility is set in the "cooling/heating selection remote controller" (★), the other remote controllers will display "☀️" (Changeover under control). In this case, the operation mode cannot be changed to respectively cooling or heating when heating or cooling is set on the "cooling or heating selection remote controller".

★Refer to the Operation Manual provided to the outdoor unit for the details on the "cooling/heating selection remote controller".



The display "☒ ⚡" (changeover under control) will blink when the power is turned ON for the first time.

## Selection Settings

# 2

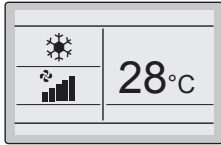
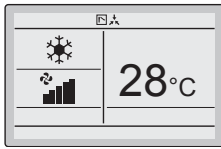

- Press the Operation Mode Selector button of the remote controller for which the selection eligibility needs to be set.  
The cooling/heating selection eligibility will be set and the icon "☒ ⚡" (Changeover under control) will disappear.  
The icon "☒ ⚡" (Changeover under control) will appear on the other remote controllers.



## Operation Method

# 3

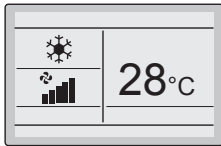

- Press the Operation Mode Selector button on the remote controller that has the cooling/heating selection eligibility (or the remote controller without the icon "☒ ⚡" (Changeover under control)) several times until the desired mode is selected. The display will change to the "Fan", "Dry", "Auto", "Cool" or "Heat" icon each time the button is pressed.
- Simultaneously, the other remote controllers with no selection right will follow and change the display automatically.

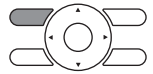

## Cool/Heat Selection Eligibility

- "Cool", "Heat" or "Auto" mode can only be set by the remote controller for which the cooling/heating selection eligibility is set.

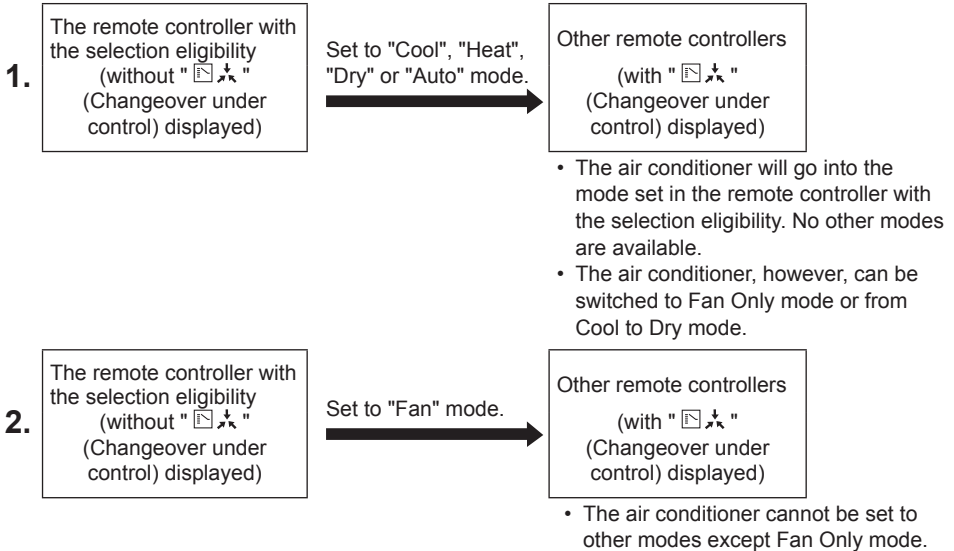

## Precautions for Setting Cooling/Heating Selection Eligibility

- The cooling/heating selection eligibility needs to be set for a single remote controller in the following case.

### (Heat pump system)

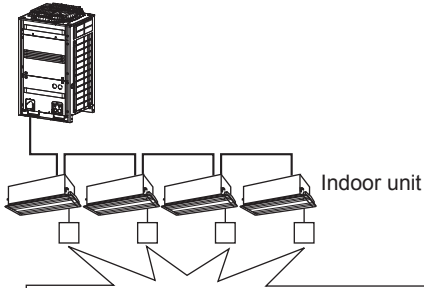

**A number of indoor units are connected to a single outdoor unit.**

Set the cooling/heating/fan selection eligibility in one of the remote controllers.

### (Heat Recovery system)

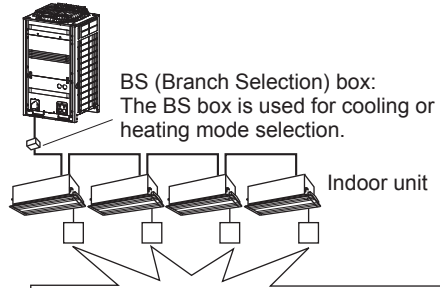

**A single BS box is connected to a number of indoor units.**

Set the cooling/heating/auto/fan selection eligibility in one of the remote controllers.

## Key Lock

### Operation Method

Disable the use of all buttons.

# 1

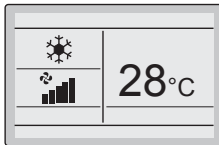

- Press the Menu/Enter button for at least 4 seconds. (During backlight lit)



# 2

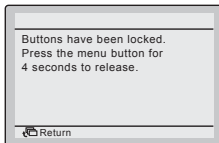

- All buttons are disabled when the keys are locked.
- When one of the buttons is pressed, the message on the left is displayed.

# 3

- To cancel the key lock, continue pressing the Menu/Enter button for at least 4 seconds. (During backlight lit)



# Quick Reference of Main Menu Items

## ■ The Main Menu Items Overview.

### Note

- The available items may vary with the connected model.
- Only the available items will appear in the menu.

Setting and display items		Description	Reference page
<b>Airflow Direction</b>		Change the airflow direction. <ul style="list-style-type: none"> <li>• The airflow direction blades can be automatically operated up and down and left and right.</li> <li>• There are five possible fixed airflow directions.</li> <li>• This function is not available on all models.</li> </ul>	<a href="#">28</a>
<b>Individual Air Direction<sup>(1)</sup></b> (only if the individual airflow function is installed)	<b>Individual Setting</b>	Set the airflow direction for each of the flaps individually. <ul style="list-style-type: none"> <li>• In case of SkyAir, maximum 4 units (unit A, B, C, D).</li> <li>• In case of VRV, maximum 16 units (unit 0 till 15).</li> </ul>	<a href="#">29</a>
	<b>Individual Setting List</b>	A table for each unit with the settings for each of the 4 flaps.	<a href="#">30</a>
	<b>Reset All Indivi Setting</b>	Clear all the individual settings.	<a href="#">30</a>
	<b>Airflow Direction Range</b>	The auto swing direction is selectable from three patterns to suit the layout of the room. <b>Standard , Right blow or Left blow</b>	
<b>Quick Start<sup>(1)</sup></b> (SkyAir only)		<b>Quickly brings the room to a comfortable temperature (unless the system is in dry or fan operation).</b> <ul style="list-style-type: none"> <li>• The maximum quick start operation period is 30 minutes.</li> </ul>	<a href="#">32</a>
<b>Ventilation</b> (HRV only)	<b>Ventilation rate</b>	Set the ventilation rate to "Low" or "High".	<a href="#">33</a>
	<b>Ventilation mode</b>	Set the ventilation mode to "Auto", "Energy Reclaim Ventilation", and "Bypass".	<a href="#">34</a>

1) Not supported when SkyAir RR+RQ outdoor units are connected

Setting and display items		Description	Reference page
<b>Energy Saving Options<sup>(1)</sup></b>	<b>Energy Saving List</b>	<b>Enable</b> or <b>disable</b> the "Energy Saving Options".	<a href="#">36</a>
	<b>Setpoint Range</b>	The setpoint temperature range can be restricted for the Cooling and Heating Mode.	<a href="#">37</a>
	<b>Setback Condition</b>	Set the setback differential temperature after which the unit will turn back OFF.	<a href="#">38</a>
	<b>Sensing Sensor(Low)<sup>(2)(3)</sup></b> (only if the sensing sensor is installed)	When no people are detected during a set time, this function will automatically change the air conditioning target temperature. If people are detected, it will return to the normal setpoint temperature.	<a href="#">39</a>
	<b>Sensing Sensor(Stop)<sup>(2)(3)</sup></b> (only if the sensing sensor is installed)	When no people are detected during a set time, this function will automatically stop the air conditioner.	<a href="#">40</a>
	<b>Setpoint Auto Reset</b>	Change the temperature setpoint to a preset temperature setpoint after running for a set period of time, even if the temperature setpoint has been changed. <ul style="list-style-type: none"> <li>• Possible to set from 30 to 120 minutes in 30 minute increments.</li> </ul>	<a href="#">41</a>
	<b>Off Timer</b>	The system is turned off automatically after the selected time each time the system is activated. <ul style="list-style-type: none"> <li>• Possible to set in 10 minute increments from 30 to 180 minutes.</li> </ul>	<a href="#">42</a>
	<b>Energy consumption<sup>(2)</sup></b> (only on SkyAir models FCQG-F and FCQHG-F)	An indicative energy consumption until now is displayed. This enables the customer to evaluate the trend of the energy consumption. <p><b>Note</b></p> <ul style="list-style-type: none"> <li>• This function is not available when more than 1 indoor unit is connected to the remote controller.</li> <li>• The displayed energy consumption is not the result of a kWh measurement, but results from a calculation with running data of the unit.</li> <li>• Some factors in this calculation are absolute values, but other factors merely result from interpolations with tolerance. This explains why the readout may deviate from the actual energy consumption.</li> </ul>	<a href="#">43</a>

1) Setback, Setpoint Range, Setback Condition and Setpoint Auto Reset should not be used when a centralised controller is connected.

2) Not supported when SkyAir RR+RQ outdoor units are connected.

3) This function cannot be used when group control is active.

In case of a simultaneous operation system, the system is controlled by the sensing sensor mounted in the master indoor unit.

Setting and display items		Description	Reference page
<b>Schedule<sup>(1)</sup></b>	<b>Enable/Disable</b>	<b>Enable or disable</b> schedule function.	<a href="#">44</a>
	<b>Schedule Number Settings</b>	Select the active schedule number (schedule nr 1, 2 or 3).	<a href="#">45</a>
	<b>Holidays</b>	Select the days of the week for which the schedule will be disabled. This function is used for when the schedule doesn't need to be active, e.g. like when you are on holiday.	<a href="#">46</a>
	<b>Settings</b>	Select when the operation modes start and/or stop for each day of the week. Up to 5 actions can be set for each day.	<a href="#">47</a>
<b>Filter Auto Clean</b>		Set the time when the filter needs to be automatically cleaned. For detailed operation refer to the Operation Manual of the self cleaning decoration panel.	<a href="#">49</a>
<b>Maintenance Information</b>		Display the service contact and model information.	<a href="#">50</a>
<b>Configuration</b>	<b>Draft prevention<sup>(2)</sup></b> (only if the sensing sensor is installed)	The draft prevention function can be <b>enabled</b> or <b>disabled</b> .	<a href="#">51</a>
	<b>Display</b>	<ul style="list-style-type: none"> <li>• Display: Switch between Standard or Detailed display.</li> <li>• Detailed display settings: Select if room temperature, outdoor temperature, system or nothing is displayed.</li> </ul>	<a href="#">52</a>
	<b>Contrast Adjustment</b>	Adjust the LCD contrast.	<a href="#">54</a>
<b>Current Settings</b>		Display a list of the current settings of the available items.	<a href="#">54</a>
<b>Clock &amp; Calendar</b>	<b>Date &amp; Time</b>	Configure the date and time settings. <ul style="list-style-type: none"> <li>• The default time display is 24H.</li> <li>• The clock will maintain accurate within <math>\pm 30</math> seconds per month.</li> <li>• If there is a power failure for a period not exceeding 48 hours, the clock will continue working with the built-in backup power supply.</li> </ul>	<a href="#">55</a>
	<b>12H/24H Clock</b>	The time can be displayed in either a 12 hour or 24 hour time format.	<a href="#">56</a>
<b>Language</b>		Choose the language depending on the language pack installed.	<a href="#">57</a>

1) The Schedule will not be available when a centralised controller or the BRP7A51 Digital Input Adapter is connected.

2) Not supported when SkyAir RR+RQ outdoor units are connected.

3) This function cannot be used when group control is active.

In case of a simultaneous operation system, the system is controlled by the sensing sensor mounted in the master indoor unit.

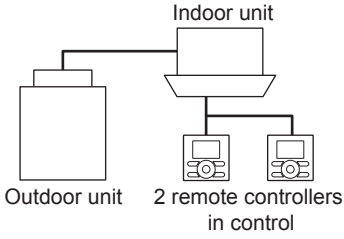
<b>Menu Items of the Sub Remote Controller</b>	 <p>The diagram illustrates a system configuration. On the left is a rectangular 'Outdoor unit'. A line connects it to a trapezoidal 'Indoor unit' on the right. From the bottom of the indoor unit, two lines branch out to two identical remote controller icons. Below the remote controllers is the text '2 remote controllers in control'.</p>
If 2 remote controllers are in control of a single indoor unit, the following menu items are not set in the sub remote controller. Set them in the main remote controller.	
<ul style="list-style-type: none"><li>• Individual Air Direction</li><li>• Energy Saving Options</li><li>• Schedule</li><li>• Filter Auto Clean</li><li>• Setback Temperature Setpoints</li></ul>	

# Menu Manipulation

## Main Menu

### ■ Manipulating the Main Menu

#### Operation Method

1

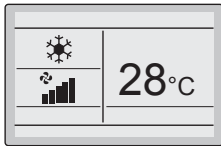

Basic Screen

- Press the Menu/Enter button.

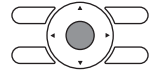

2

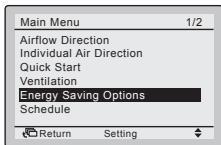

Main Menu

- The Main Menu will appear.

← Instructions for manipulating the buttons will appear.

3

- Selecting items from the Main Menu.
  1. Press the ▼▲ (Up/Down) buttons to select the desired item.
  2. Press the Menu/Enter button to display the selected settings screen.

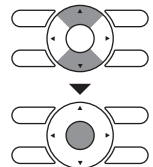

4

- To go back to the Basic Screen from the Main Menu, press the Cancel button.



### Caution

- When the Main Menu is visible and a button is not pressed for 5 minutes, the screen will automatically go back to the Basic Screen.
- Disable the Menu/Enter and Cancel button again after all changes are made.
- To disable the Menu/Enter and Cancel button, see "[Enable/disable the Menu/Enter and Cancel button](#)" on page 12.



# Airflow Direction

## Change the Airflow direction

### Operation Method

1

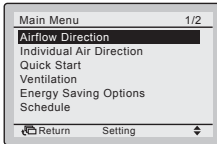

- Display the Main Menu (See "Manipulating the Main Menu" on page 27)
- Press the ▲▼ (Up/Down) buttons to select **Airflow Direction** and press the Menu/Enter button.

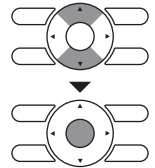

2

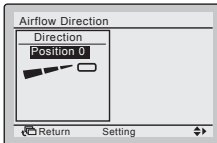

- Select the desired airflow direction from **No Ind Set**, **Position 0**, **Position 1**, **Position 2**, **Position 3**, **Position 4**, **Swing** or **Auto** using the ▲▼ (Up/Down) buttons.
- Press the Menu/Enter button to confirm the settings and to return to the Basic Screen

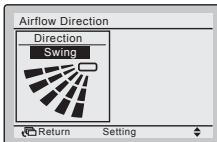
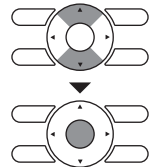

Airflow direction  
setting (up/down)

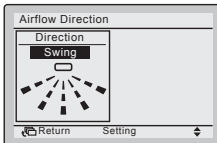

Airflow direction  
setting (left/right)

#### Note

- The airflow directions appear on the screen as follows:



Up/down direction

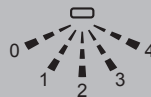

Left/right direction

0 : Position 0

1 : Position 1

2 : Position 2

3 : Position 3

4 : Position 4

- Selecting **Swing** will cause the airflow direction blades to swing back and forth. When **Swing** is selected, all airflow directions will be visible at the same time.
- When you select one of the positions 0 to 4, the airflow direction blades stay in a fixed position.

## Movement of the airflow direction blades

When the following operation conditions are active, the airflow direction is controlled automatically. Actual operation may thus be different than what is displayed on the remote controller.

#### Operation condition

- Room temperature is higher than the remote controller's set temperature (in heating mode).
- When Defrost is active (in heating mode).  
(The airflow is blowing horizontally so that people in the room are not in direct line of the cold air).
- Under continuous operation with the airflow blowing horizontally.

#### Note

Heating mode includes automatic operation.

# Individual Air Direction (Only if the individual airflow function is installed)

## ■ Individual Setting

### Operation Method

1

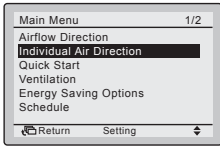

- Display the Main Menu (See "Manipulating the Main Menu" on page 27).
- Select **Individual Air Direction** and press the Menu/Enter button.

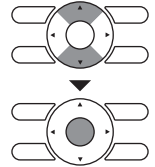

2

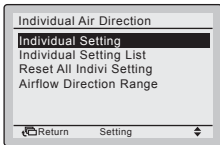

- Select **Individual Setting** and press the Menu/Enter button.

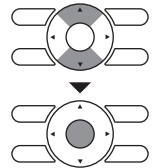

3

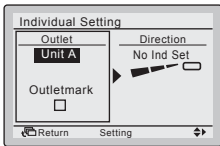

- Use the ▲▼ (Up/Down) buttons to select the unit and outlet mark.
- In case of SkyAir, maximum 4 units (unit A, B, C, D) can be selected.  
 In case of VRV, maximum 16 units for each group (unit 0 till 15) can be selected.

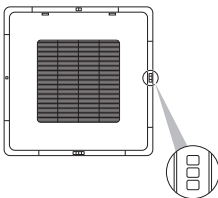
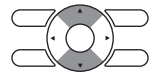

#### Note

In case of four outlets (cassette type), you can control each one of the four flaps individually (the following marks are beside each air outlet: □, □□, □□□, □□□□).

4

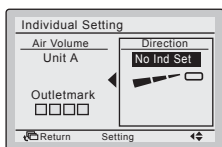

- Press the ► (Right) button to select the airflow direction.
- Use the ▲▼ (Up/Down) buttons to change the airflow direction to the following:  
**No Ind Set**, **Position 0**, **Position 1**,  
**Position 2**, **Position 3**, **Position 4**, **Swing** or  
**Blocked**.  
**No Ind Set**: No Individual Setting.  
**Blocked**: Individual airflow is blocked.
- Press the Menu/Enter button to confirm the settings and to return to the Basic Screen.

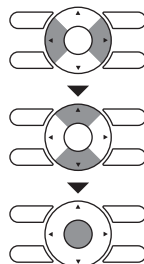

## ■ Individual Setting List

### Operation Method

1

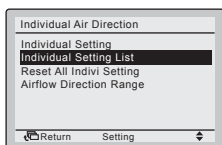

- Display the Individual Air Direction menu (See "[Individual Setting](#)" on page 29).
- Press the ▲▼ (Up/Down) buttons to select **Individual Setting List** and press the Menu/Enter button.

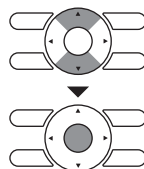

2

Individual Setting List		
Unit A	Air direc.	Indiv.
<input type="checkbox"/>	Position 0	OFF
<input type="checkbox"/>	Position 0	OFF
<input type="checkbox"/>	Position 0	OFF
<input type="checkbox"/>	Position 0	OFF

- A table shows the current settings. Press the ▲▼ (Up/Down) buttons to go to the next unit.
- Press the Cancel button to return to the previous menu.

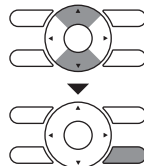

## ■ Reset All Individual Settings

### Operation Method

1

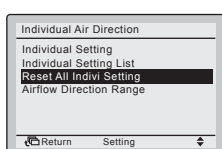

- Display the Individual Air Direction menu (See "[Individual Setting](#)" on page 29).
- Press the ▲▼ (Up/Down) buttons to select **Reset All Indivi Setting** and press the Menu/Enter button.

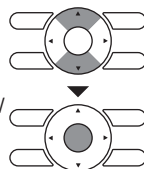

2

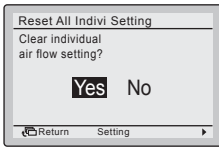

- Press the ◀▶ (Left/Right) buttons to select **Yes**.
- Press the Menu/Enter button to confirm the reset and to return to the Basic Screen.

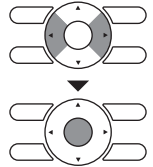

## ■ Airflow Direction Range (Floor standing type indoor unit only)

- The Airflow Direction Range can be selected by the remote controller depending on the installed location of the air conditioner.

The Airflow Direction Range has the following 3 patterns:

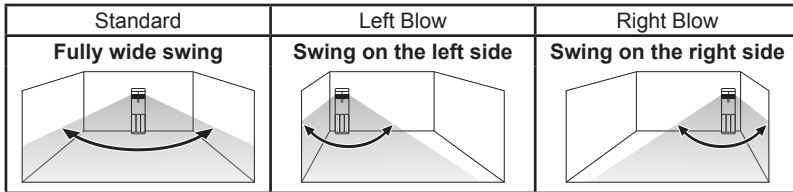

- These patterns correspond with the situations as shown below:

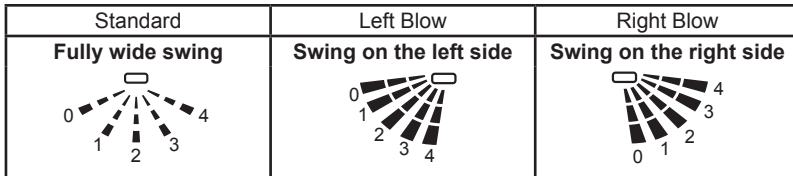

## Operation Method

1

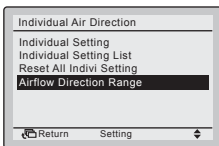

- Display the Individual Air Direction menu (See "[Individual Setting](#)" on page 29).
- Press the ▲▼ (Up/Down) buttons to select **Airflow Direction Range** and press the Menu/Enter button.

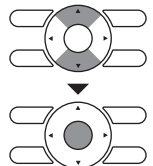

2

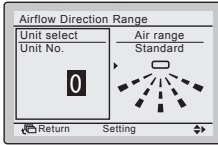

- Press the ▼▲ (Up/Down) buttons to select the unit number.

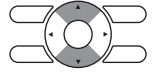
**Note**

- For a simultaneous operation system, individual setup for each indoor unit is possible by connecting the remote controller to each unit when installing.
- For remote controllers connected in group, a maximum of 16 units (unit number 0-15) are configurable.

3

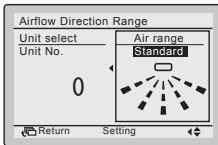

- Press the ► (Right) button to select the Air range setting.
- Select the desired air range from **Standard**, **Right blow** or **Left blow** by using the ▼▲ (Up/Down) buttons.
- Press the Menu/Enter button to confirm the settings and to return to the Basic Screen.

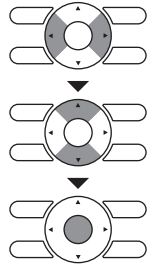

## Quick Start (SkyAir only)

### ■ Quick Start ON

#### Operation Method

1

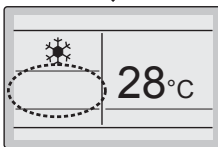
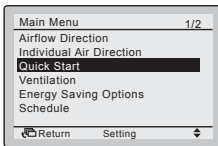

- While operating in Cooling, Heating or Auto mode, display the Main Menu (See ["Manipulating the Main Menu" on page 27](#)).
- Press the ▼▲ (Up/Down) buttons to select **Quick Start** and press the Menu/Enter button to return to the Basic Screen.
- Quick Start is now ON.
- When Quick Start is active, it is not possible to change the fan speed. The fan speed icons will not be displayed.

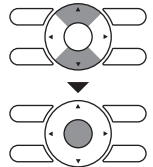

## ■ Quick Start OFF

2

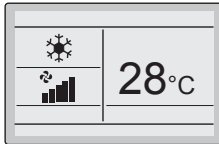
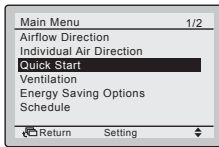

- While Quick Start is active, display the Main Menu (See "[Manipulating the Main Menu](#)" on [page 27](#)).
- Press the ▼▲ (Up/Down) buttons to select **Quick Start** and press the Menu/Enter button to return to the Basic Screen.
- Quick Start is now OFF.
- The fan speed can be changed again and the fan speed icons are visible again.

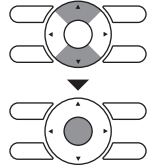

## Quick Start

### Quick Start

The airflow rate of the indoor unit is automatically controlled, increasing the capacity of the outdoor unit and quickly bringing the room to a comfortable temperature.

- The fan speed icons disappear and the fan speed cannot be changed.
- Cannot be set when in Fan Only and Dry mode.
- Quick Start will run for a maximum of 30 minutes before the unit automatically returns to normal operation.
- Using the Operation Mode Selector button will return the air conditioner to normal operation.
- In heating mode, the fan speed may increase and the temperature may decrease. Adjust the operation as desired.

## Ventilation (HRV only)

## ■ Ventilation Rate

### Operation Method

1

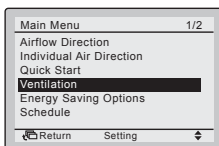

- Display the Main Menu. (See "[Manipulating the Main Menu](#)" on [page 27](#)).
- Press the ▼▲ (Up/Down) buttons to select **Ventilation** and press the Menu/Enter button (For models with no ventilation function, **Ventilation** will not be displayed in the Main Menu).

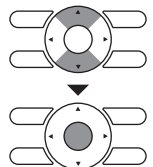

2

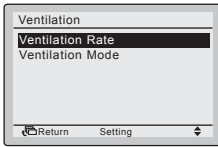

- Press the ▼▲ (Up/Down) buttons to select **Ventilation Rate** and press the Menu/Enter button.

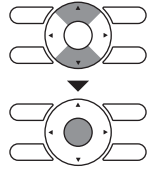

3

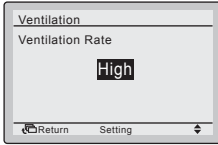

- Press the ▼▲ (Up/Down) buttons to change the setting to **Low** or **High**.
- Press the Menu/Enter button to confirm the settings and to return to the Basic Screen.

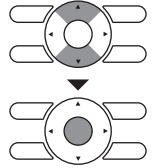

\* Only modes that can be set are displayed.

## ■ Ventilation Mode

### Operation Method

1

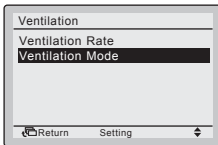

- Display the Ventilation menu. (See "Ventilation Rate" on page 33).
- Press the ▼▲ (Up/Down) buttons to select **Ventilation Mode** and press the Menu/Enter button.

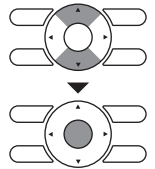

2

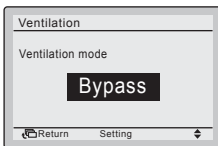

- Press the ▼▲ (Up/Down) buttons to change the settings as shown below.



\* Only modes that can be set are displayed.

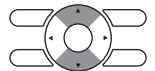

3

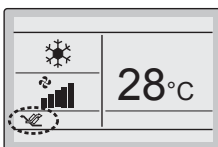

- Select the desired ventilation mode.
- Press the Menu/Enter button to confirm the settings and to return to the Basic Screen.
- The corresponding mode is shown.



## Ventilation Mode

### Auto mode " "

Using information from the air conditioner (cooling, heating, fan, and set temperature) and the Heat Reclaim Ventilation unit (indoor and outdoor temperatures), the mode is automatically changed between Energy Reclaim Ventilation and Bypass.

### Energy reclaim ventilation mode " "

The outdoor air is supplied to the room after passing through a heat exchanger.

### Bypass mode " "

The outdoor air is supplied to the room without passing through a heat exchanger.



# Energy Saving Options

## ■ Energy Saving List

Some functions should not be enabled when a centralised controller is connected.

### Operation Method

# 1

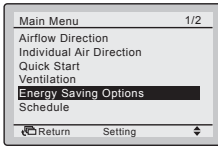

- Display the Main Menu.  
(See ["Manipulating the Main Menu" on page 27](#)).
- Press the ▼▲ (Up/Down) buttons to select **Energy Saving Options** and press the Menu/Enter button.

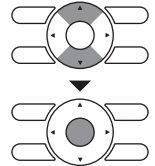

# 2

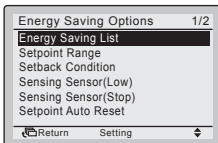

- Press the ▼▲ (Up/Down) buttons to select **Energy Saving List** and press the Menu/Enter button.

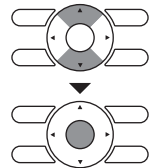

# 3

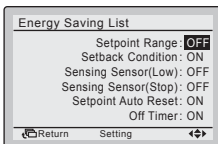

- Press the ▼▲ (Up/Down) buttons to change the setting to **ON** or **OFF**.
- Move the cursor using the ◀▶ (Left/Right) buttons.
- Press the Menu/Enter button when all changes are made. The confirmation screen will appear.

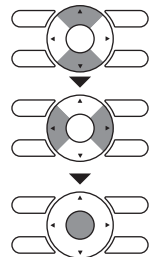

# 4

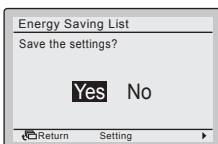

- Press the ◀▶ (Left/Right) buttons to select **Yes**.
- Press the Menu/Enter button to confirm the settings and to return to the Basic Screen.

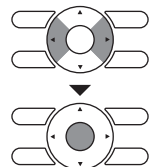

# ■ Setpoint Range Setting

**Operation Method** This function should not be used when a centralised controller is connected.

1

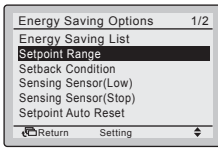

- Display the Energy Saving Options (See "Energy Saving List" on page 36).
- Press the ▼▲ (Up/Down) buttons to select **Setpoint Range** and press the Menu/Enter button.

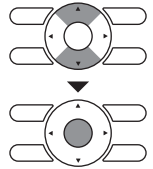

2

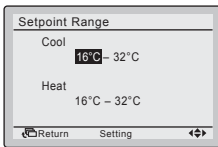

- Press the ▼▲ (Up/Down) buttons to change the cooling or heating temperature setpoint range.
- Move the cursor using the ◀▶ (Left/Right) buttons.
- Press the Menu/Enter button when all changes are made. The confirmation screen will appear.

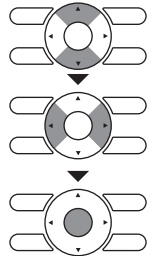

## Note

- The default setpoint range restriction is [16°C→32°C]. This setpoint range is the general setpoint range and is as a result always active regardless of whether Setpoint Range is enabled or disabled.
- The default setpoint range for setback operation is [33°C→37°C] for cooling and [10°C→15°C] for heating. This setpoint range cannot be changed.

3

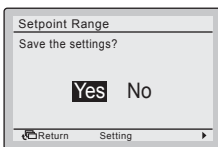

- Press the ◀▶ (Left/Right) buttons to select **Yes**.
- Press the Menu/Enter button to confirm the settings and to return to the Basic Screen.

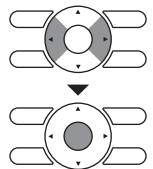

## ■ Setback Condition

**Operation Method** This function should not be used when a centralised controller is connected.

# 1

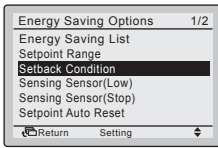

- Display the Energy Saving Options (See "Energy Saving List" on page 36).
- Press the ▼▲ (Up/Down) buttons to select **Setback Condition** and press the Menu/Enter button.

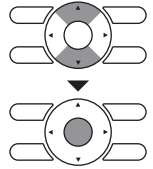

# 2

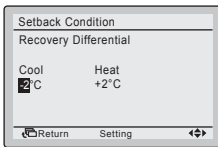

- Press the ▼▲ (Up/Down) buttons to change the differential for setback operation.
- Move the cursor using the ◀▶ (Left/Right) buttons.
- Press the Menu/Enter button when all changes are made. The confirmation screen will appear.

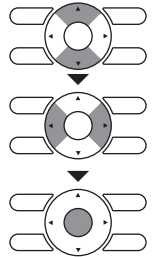

# 3

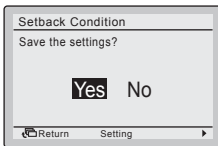

- Press the ◀▶ (Left/Right) buttons to select **Yes**.
- Press the Menu/Enter button to confirm the settings and to return to the Basic Screen.

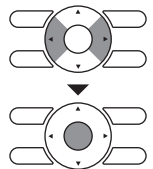

### Note

- The default setpoint range restriction is [16°C→32°C]. This setpoint range is the general setpoint range and is as a result always active regardless of whether Setpoint Range is enabled or disabled.
- The default setpoint range for setback operation is [33°C→37°C] for cooling and [10°C→15°C] for heating. This setpoint range cannot be changed.

# ■ Sensing Sensor(Low)

This function cannot be used when group control is active.

In case of a simultaneous operation system, the system is controlled by the sensing sensor mounted in the master indoor unit.

## Operation Method

1

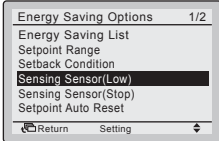

- Display the Energy Saving Options (See "Energy Saving List" on page 36).
- Press the ▼▲ (Up/Down) buttons to select **Sensing Sensor(Low)** and press the Menu/Enter button.

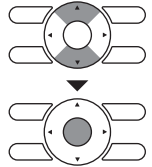

2

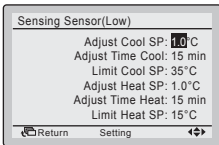

- Press the ▼▲ (Up/Down) buttons to set the energy saving operation when the sensor detects an absence.
- Move the cursor using the ◀▶ (Left/Right) buttons.
- Press the Menu/Enter button when all changes are made. The confirmation screen will appear.
- Example (settings on the left apply):  
If the sensor determines that there is no person in the room during cooling operation, the cooling setpoint temperature will automatically increase by 1°C every 15 minutes until the cooling setpoint temperature is 35°C. On the Basic Screen, the cooling setpoint temperature will not change.

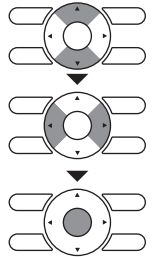

3

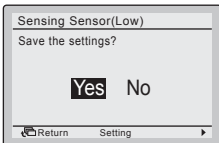

- Press the ◀▶ (Left/Right) buttons to select **Yes**.
- Press the Menu/Enter button to confirm the settings and to return to the Basic Screen.

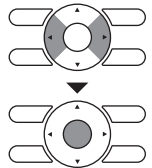

## ■ Sensing Sensor(Stop)

This function cannot be used when group control is active.

In case of a simultaneous operation system, the system is controlled by the sensing sensor mounted in the master indoor unit.

### Operation Method

# 1

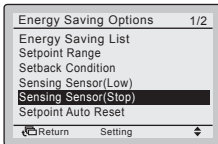

- Display the Energy Saving Options (See "Energy Saving List" on page 36).
- Press the ▼▲ (Up/Down) buttons to select **Sensing Sensor(Stop)** and press the Menu/Enter button.

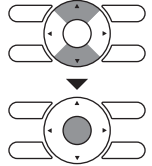

# 2

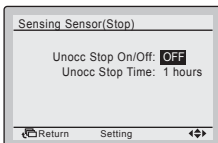

- Press the ▼▲ (Up/Down) buttons to set the energy saving operation when the sensor detects the absence.
- Move the cursor using the ◀▶ (Left/Right) buttons.
- Press the Menu/Enter button when all changes are made. The confirmation screen will appear.

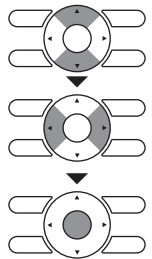

# 3

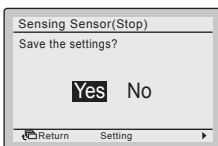

- Press the ◀▶ (Left/Right) buttons to select **Yes**.
- Press the Menu/Enter button to confirm the settings and to return to the Basic Screen.

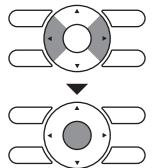

# ■ Setpoint Auto Reset

**Operation Method** This function should not be used when a centralised controller is connected.

1

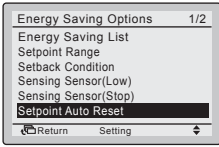

- Display the Energy Saving Options (See "Energy Saving List" on page 36).
- Press the ▼▲ (Up/Down) buttons to select **Setpoint Auto Reset** and press the Menu/Enter button.

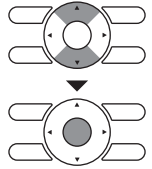

2

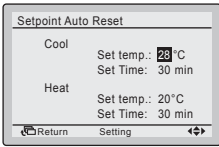

- Press the ▼▲ (Up/Down) buttons to set the preset temperature and timing for the auto reset of the setpoint.
- Move the cursor using the ◀▶ (Left/Right) buttons.
- Press the Menu/Enter button when all the changes are made. The confirmation screen will appear.

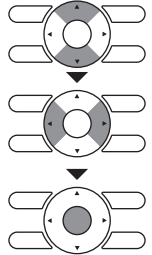

3

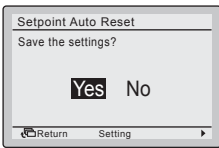

- Press the ◀▶ (Left/Right) buttons to select **Yes**.
- Press the Menu/Enter button to confirm the settings and to return to the Basic Screen.

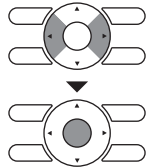

# ■ OFF Timer

## Operation Method

1

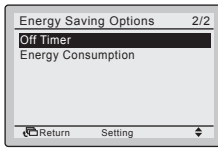

- Display the Energy Saving Options (See "[Energy Saving List](#)" on page 36).
- Press the ▼▲ (Up/Down) buttons to select **Off Timer** and press the Menu/Enter button.

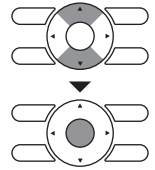

2

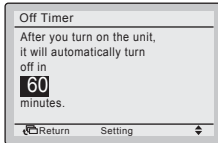

- Use the ▼▲ (Up/Down) buttons to set the time after which the unit automatically turns off again. Selections can be made in increments of 10 minutes from 30 to 180 minutes. Holding down the button causes the number to change continuously. The settings confirmation screen will appear when the Menu/Enter button is pressed.

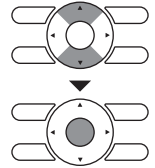

3

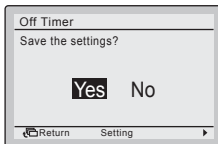

- Press the ◀▶ (Left/Right) button to select **Yes**.
- Press the Menu/Enter button to confirm the settings and to return to the Basic Screen.

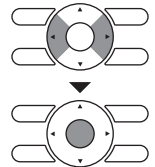

# Energy Consumption

## Operation Method

1

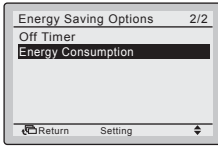

- Display the Energy Saving Options (See "Energy Saving List" on page 36).
- Press the ▼▲ (Up/Down) buttons to select **Energy Consumption** and press the Menu/Enter button.

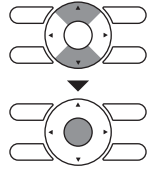

2

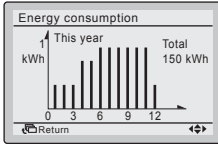
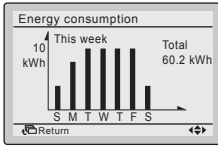
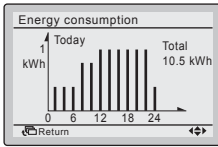

- Switch screens using the ◀▶ (Left/Right) buttons: Today > Yesterday > This week (1 week) > Last week (1 week) > This year (1 year) > Last year.
- Change the range shown in the upper right of the screen using the ▼▲ (Up/Down) buttons.
- Press the Cancel button to return to the previous screen.

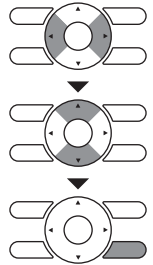



# Schedule

## ■ Enable/Disable

The schedule is not visible and disabled when a centralized controller or the BRP7A51 Digital Input Adapter is connected.

### Operation Method

# 1

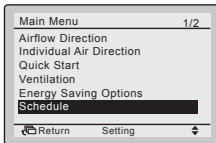

- Display the Main Menu.  
(See ["Manipulating the Main Menu" on page 27](#)).
- Press the ▼▲ (Up/Down) buttons to select **Schedule** and press the Menu/Enter button.

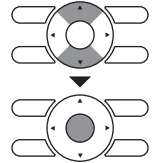

# 2

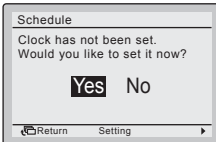

#### Note

- Before setting the schedule, the clock must be set.
- If the clock has not been set, a screen like the one on the left will appear.

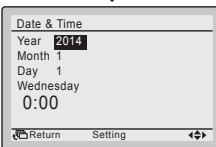

- Press the ◀▶ (Left/Right) buttons to select **Yes** and press the Menu/Enter button.
- The Date & Time screen will appear.
- Set the current year, month, day and time. (See ["Clock & Calendar" on page 55](#)).

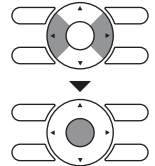

# 3

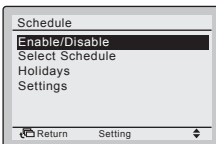

- Press the ▼▲ (Up/Down) buttons to select **Enable/Disable** and press the Menu/Enter button.

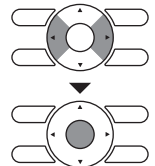

# 4

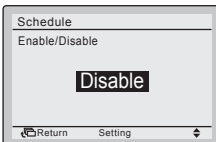

- Press the ▼▲ (Up/Down) buttons to select **Enable** or **Disable**.
- The confirmation screen will appear when the Menu/Enter button is pressed.

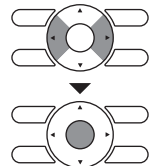

#### Note

The Schedule is enabled. To modify the Selected schedule number see ["Select Schedule" on page 45](#).

5

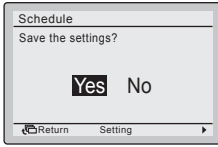

- Press the ◀▶ (Left/Right) buttons to select **Yes**.
- Press the Menu/Enter button to confirm the settings and to return to the Basic Screen.

## ■ Select Schedule

### Operation Method

It is possible to program up to three different schedules.

1

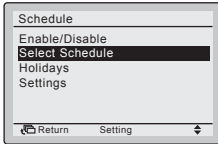

- Display the Schedule menu. (See "[Enable/Disable](#)" on page 44).
- Press the ▼▲ (Up/Down) buttons to select **Select Schedule** and press the Menu/Enter button.

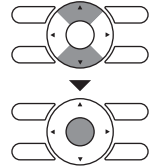

2

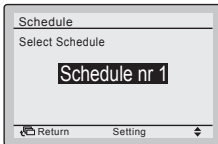

- Press the ▼▲ (Up/Down) buttons to select **Schedule nr 1**, **Schedule nr 2** or **Schedule nr 3**.
- The confirmation screen will appear when the Menu/Enter button is pressed.

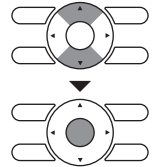

3

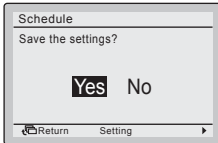

- Press the ◀▶ (Left/Right) buttons to select **Yes**.
- Press the Menu/Enter button to confirm the settings and to return to the Basic Screen.

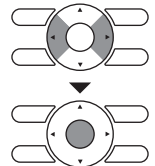

# ■ Holidays

**Operation Method** The schedule timer will be disabled for days that have been set as a holiday.

## 1

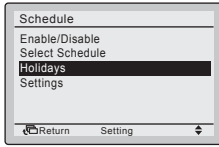

- Display the Schedule menu. (See "Enable/Disable" on page 44).
- Press the ▼▲ (Up/Down) buttons to select **Holidays** and press the Menu/Enter button.

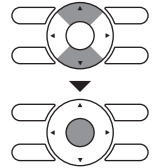

## 2

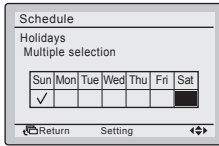

- Press the ◀▶ (Left/Right) buttons to select the desired day.
- Press the ▼▲ (Up/Down) buttons to display "✓" to set this day as a holiday.

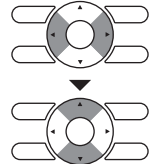

### Note

- Multiple days can be selected as holidays.
- To re-enable the schedule timer for the day selected as a holiday, the holiday setting must be released.

## 3

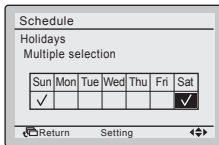

- Press the Menu/Enter button when all changes are made. The settings confirmation screen will appear.

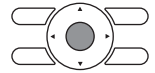

## 4

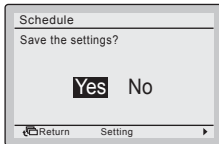

- Press the ◀▶ (Left/Right) button to select **Yes**.
- Press the Menu/Enter button to confirm the settings and to return to the Basic Screen.

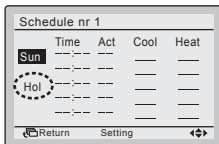
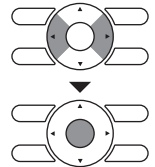

### Note

"Hol" will be displayed on the schedule settings screen for days that have been set as a holiday.

# ■ Schedule Settings

**Operation Method** After saving a schedule, the schedule is automatically enabled.

1

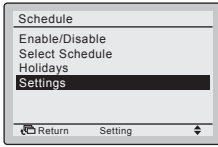

- Display the Schedule menu. (See "Enable/Disable" on page 44).
- Press the ▼▲ (Up/Down) buttons to select **Settings** and press the Menu/Enter button.

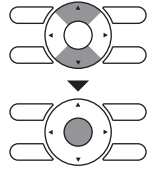

**Note**

The Schedule Settings of the selected schedule can be modified. To modify the selected schedule see "Select Schedule" on page 45.

2

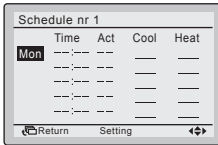

- Press the ▼▲ (Up/Down) buttons to select the day to be set.



3

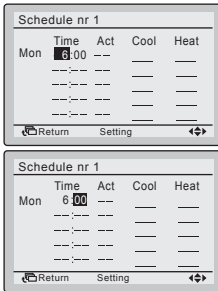

- Set the time for the selected day.
- Press the ◀▶ (Left/Right) buttons to move the highlighted item and press the ▼▲ (Up/Down) buttons to input the desired operation start time. Each press of the ▼▲ (Up/Down) buttons moves the numbers by 1 hour or 1 minute.

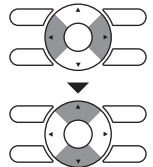

4

Schedule nr 1				
	Time	Act	Cool	Heat
Mon	6:00	■	---	---
	---	---	---	---
	---	---	---	---
	---	---	---	---
	---	---	---	---
		Return	Setting	↔

Schedule nr 1				
	Time	Act	Cool	Heat
Mon	6:00	ON	32°C	16°C
	---	---	---	---
	---	---	---	---
	---	---	---	---
	---	---	---	---
		Return	Setting	↔

Schedule nr 1				
	Time	Act	Cool	Heat
Mon	6:00	ON	24°C	21°C
	8:00	OFF	■ C	---
	---	---	---	---
	---	---	---	---
	---	---	---	---
		Return	Setting	↔

- Press the ◀▶ (Left/Right) buttons to move the highlighted item and press the ▼▲ (Up/Down) buttons to configure ON/OFF/-- settings.

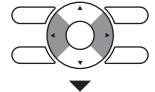

#### "Act"-column:

ON : The temperature setpoints can be configured.

OFF : The setback temperature setpoints can be configured.

-- : The temperature and setback temperature setpoints will be disabled.



- Press the ◀▶ (Left/Right) buttons to move the highlighted item and press the ▼▲ (Up/Down) buttons to input the cooling and heating temperature setpoints for both ON and OFF (Setback) operation.

#### "Cool" and "Heat" column:

"—": Indicates that the temperature and setback temperature setpoint for this time period is not specified. The last active setpoint will be utilized.

"--": Indicates that the setback function is disabled for this time period.

5

Schedule nr 1				
	Time	Act	Cool	Heat
Mon	6:00	ON	24°C	21°C
	8:00	OFF	29°C	10°C
	17:30	ON	24°C	21°C
	22:00	---	---	---
	---	---	---	---
		Return	Setting	↔

Schedule nr 1				
	Time	Act	Cool	Heat
Mon	6:00	ON	24°C	21°C
	8:00	OFF	29°C	10°C
	17:30	ON	24°C	21°C
	22:00	OFF	28°C	17°C
	---	---	---	---
		Return	Setting	↔

Schedule nr 1				
	Time	Act	Cool	Heat
Tue	6:00	ON	24°C	21°C
	8:00	OFF	29°C	10°C
	17:30	ON	24°C	21°C
	22:00	OFF	28°C	17°C
	---	---	---	---
		Return	Setting	↔

#### Note

A maximum of 5 actions per day can be set.

- Press the Menu/Enter button when all changes are made. The confirmation screen will appear.



#### Note

To copy the settings from the previous day, press the Operation Mode Selector button.

Example: To copy the contents of Monday to Tuesday, select Tuesday and press the Operation Mode Selector button.



6

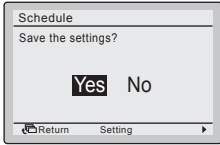

- Press the ◀▶ (Left/Right) buttons to select **Yes**.
- Press the Menu/Enter button to confirm the settings and to return to the Basic Screen.

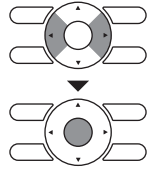

## Filter Auto Clean (Only when the self cleaning decoration panel is installed)

- For detailed operation refer to the Operation Manual of the self cleaning decoration panel.

### ■ Filter Auto Clean Time

#### Operation Method

1

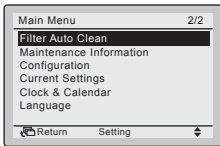

- Display the Main Menu. (See "[Manipulating the Main Menu](#)" on page 27).
- Press the ▼▲ (Up/Down) buttons to select **Filter Auto Clean** and press the Menu/Enter button.

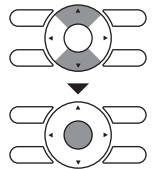

**Note**  
When filter Auto Clean has been disabled, the message "Auto Filter Clean is disabled" is shown.

2

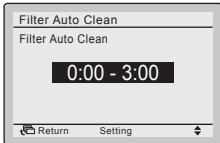

- Use the ▼▲ (Up/Down) buttons to set the time when the auto cleaning function of the filter needs to be executed.
- The confirmation screen will appear when the Menu/Enter button is pressed.

3

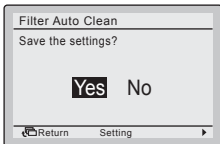

- Press the ◀▶ (Left/Right) buttons to select **Yes**.
- Press the Menu/Enter button to confirm the settings and to return to the Basic Screen.

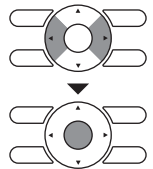

# Maintenance Information

## ■ Display the Maintenance Information

### Operation Method

# 1

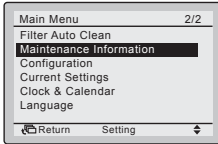

- Display the Main Menu. (See "[Manipulating the Main Menu](#)" on page 27).
- Press the ▼▲ (Up/Down) buttons to select **Maintenance Information** and press the Menu/Enter button.

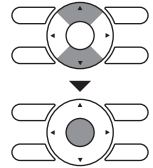

# 2

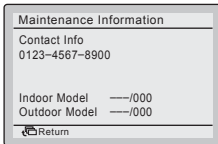

- The phone number for the contact address will appear at the top of the screen. (If you have not yet registered your product, it will not appear).
- The model information of the indoor and outdoor units of your product will appear on the bottom of the screen. (For some models the product code may appear).
- Press the Cancel button to return to the previous screen.



#### Note

- The model name will not appear if you have had the circuit board replaced.
- The error code may also appear. If the operation lamp is not blinking, the unit is working properly.
- The error code record will disappear if you press the ON/OFF button for more than 4 seconds.



# Configuration

## ■ Draft Prevention

### Operation Method

# 1

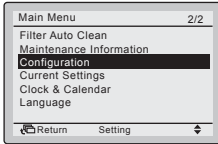

- Display the Main Menu. (See page 27).
- Press the ▼▲ (Up/Down) buttons to select **Configuration** and press the Menu/Enter button.

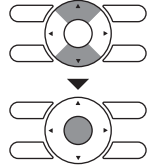

# 2

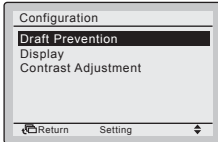

- Press the ▼▲ (Up/Down) buttons to select **Draft Prevention** and press the Menu/Enter button.

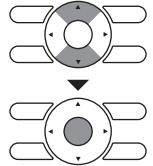

# 3

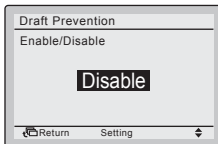

- Press the ▼▲ (Up/Down) buttons to select **Enable** or **Disable**.
- The confirmation screen will appear when the Menu/Enter button is pressed.

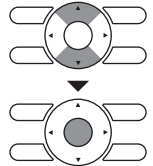

# 4

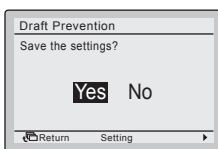

- Press the ◀▶ (Left/Right) buttons to select **Yes**.
- Press the Menu/Enter button to confirm the settings and to return to the Basic Screen.

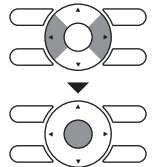



## ■ Display

### Display Mode

#### Operation Method

# 1

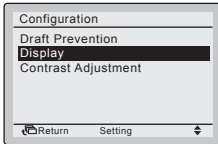

- Display the Configuration menu. (See "[Draft Prevention](#)" on page 51).
- Press the ▼▲ (Up/Down) buttons to select **Display** and press the Menu/Enter button.

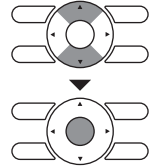

# 2

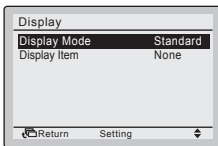

- Press the ▼▲ (Up/Down) buttons to select **Display Mode** and press the Menu/Enter button.

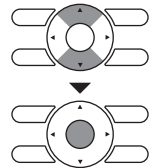

# 3



- Press the ▼▲ (Up/Down) buttons to select **Standard** or **Detailed**.
- Press the Menu/Enter button to confirm the settings and to return to the Basic Screen.

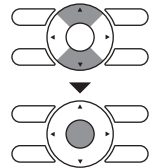

#### Note

To select which item is displayed in the detailed display selection area, refer to "[Detailed Item](#)" on page 53.

# Detailed Item

## Operation Method

1

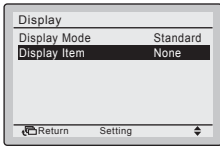

- Display the Display menu. (See "Display Mode" on page 52).
- Press the ▼▲ (Up/Down) buttons to select **Display Item** and press the Menu/Enter button.

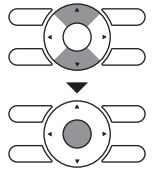

2

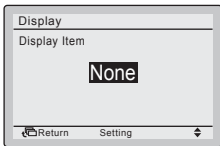

- Press the ▼▲ (Up/Down) buttons to display the following.

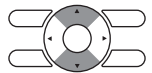

\* Some models may not display these items even if they are selected.

- Be sure to read the following regarding the display of the room and outdoor temperature.

### Room Temp

- The temperature near the remote controller.
- The temperature that is detected may be affected by the location of the unit.
- It is possible to switch between the remote controller or the indoor unit for the used temperature sensor. For detailed information, refer to the Field Settings in the Installation Manual.

### Outside Air Temp

- The temperature detected near the outdoor unit.
- The temperature that is detected may be affected by factors such as the location of the unit (e.g if it is in direct sunlight) and unit operation during defrosting.

- Press the Menu/Enter button to confirm the settings and to return to the Basic Screen.



## ■ Contrast Adjustment

### Operation Method

1

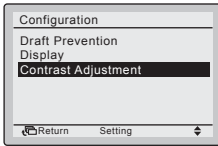

- Display the Configuration menu. (See "[Draft Prevention](#)" on page 51).
- Press the ▼▲ (Up/Down) buttons to select **Contrast adjustment** and press the Menu/Enter button.

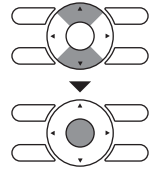

2

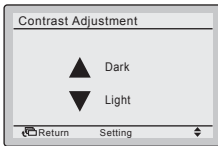

- Press the ▼▲ (Up/Down) buttons until you reach the desired contrast.
- Press the Menu/Enter button to confirm the setting and to return to the Basic Screen.

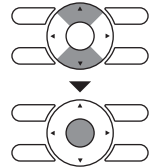

## Current Settings

### ■ Overview of the Current Settings

#### Operation Method

1

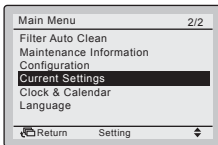

- Display the Main Menu. (See "[Manipulating the Main Menu](#)" on page 27).
- Press the ▼▲ (Up/Down) buttons to select **Current Settings** and press the Menu/Enter button.

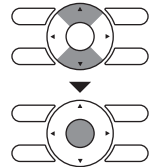

2

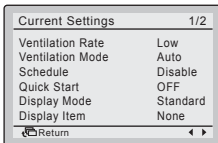

- A list showing the status of the current settings will appear.
- Press the ◀▶ (Left/Right) buttons to go to the next screen.
- Press the Cancel button to return to the Main Menu.

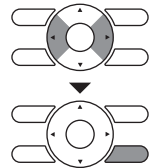

Display items

Ventilation Rate  
Ventilation Mode

Schedule  
Quick Start

Display Mode  
Display Item

Filter Auto Clean

\* Display items may differ depending on the model. Only the items that can be set are displayed.

# Clock & Calendar

## ■ Date & Time

### Operation Method

1

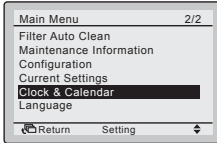

- Display the Main Menu. (See "Manipulating the Main Menu" on page 27).
- Press the ▼▲ (Up/Down) buttons to select **Clock & Calendar** and press the Menu/Enter button.

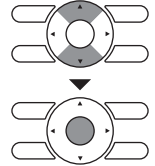

2

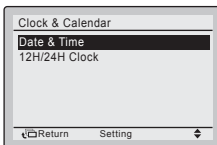

- Press the ▼▲ (Up/Down) buttons to select **Date & Time** and press the Menu/Enter button.

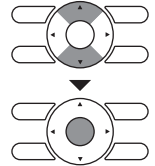

3

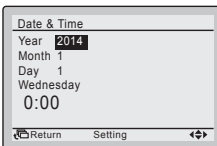

- Use the ▼▲ (Up/Down) buttons to change the date and time.
- Move the cursor using the ◀▶ (Left/Right) buttons.
- Press the Menu/Enter button when all changes are made. The confirmation screen will appear.

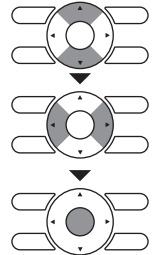

### Caution

- By default the Daylight Saving Time (DST) is active. The following rules apply:
  - Start: Last Sunday of March 02:00
  - End: Last Sunday of October 03:00
- Please consult your Daikin dealer if the DST settings needs to be changed.

### Note

The day of the week is set automatically.

4

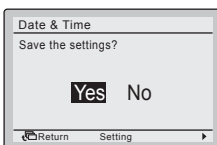

- Press the ◀▶ (Left/Right) button to select **Yes**.
- Press the Menu/Enter button to confirm the settings and to return to the Basic Screen.

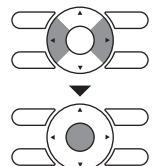

## ■ 12H/24H CLOCK

### Operation Method

# 1

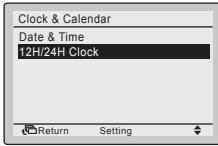

- Display the Clock & Calendar menu. (See ["Date & Time"](#) on page 55).
- Press the ▼▲ (Up/Down) buttons to select **12H/24H Clock** and press the Menu/Enter button.

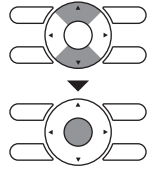

# 2

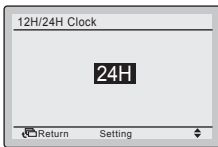

- Press the ▼▲ (Up/Down) buttons to select **12H** or **24H**.
- The confirmation screen will appear when the Menu/Enter button is pressed.

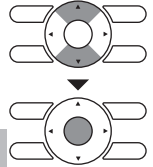

#### Note

By default, the time display is set to the 24H format.

# 3

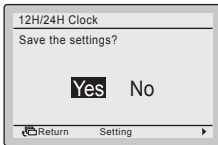

- Press the ◀▶ (Left/Right) buttons to select **Yes**.
- Press the Menu/Enter button to confirm the setting and to return to the Main Menu.

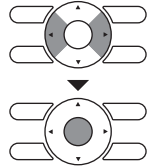

# Language

## ■ Select the Language

### Operation Method

# 1

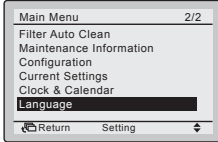

- Display the Main Menu. (See "[Manipulating the Main Menu](#)" on page 27).
- Press the ▼▲ (Up/Down) buttons to select **Language** and press the Menu/Enter button.

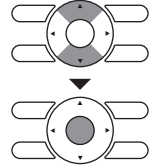

# 2

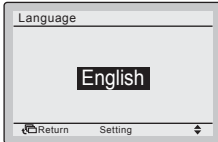

- Press the ▼▲ (Up/Down) buttons to select the preferred language.
- Press the Menu/Enter button to confirm the settings and to return to the Basic Screen.

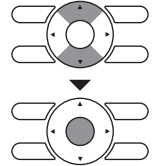

### Note

The visible languages are depending on the installed language pack.

For detailed information on the available languages and on how to change the language pack, refer to the Installation Manual.

## Reset Filter Indication

### Operation Method

1

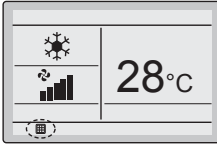

- When the time to clean the filter or element has come, one of the following icons will appear on the bottom of the Basic Screen: "☀️" and/or "📊".
- Wash, clean or replace the filter or element.  
For details, refer to the Operation Manual of the indoor unit.

2

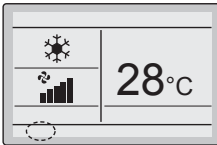
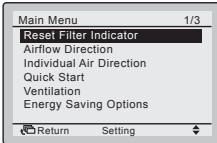

- To reset the filter sign when the filter or element is washed, cleaned or replaced, display the Main Menu (See "[Manipulating the Main Menu](#)" on [page 27](#) ).
- Press the ▼▲ (Up/Down) buttons to select **Reset Filter Indicator**.
- Press the Menu/Enter button to reset the filter indicator and to return to the Basic Screen.
- The icon(s) shown in Step 1 will disappear from the Basic Screen when the filter sign is reset.

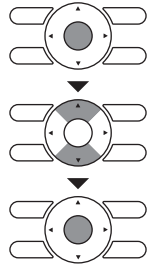

3

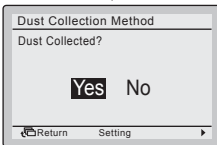
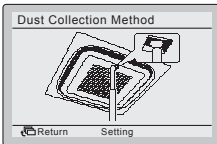

- When an indoor unit with a self cleaning cassette is installed, there will first be prompted to collect the dust from the dustbin in the unit.
- Press the Menu/Enter button to confirm and the confirmation screen will appear.
- Press the ◀▶ (Left/Right) buttons to select **Yes**. Press the Menu/Enter button to confirm and to return to the Basic Screen.
- Continue the normal procedure to reset the filter indicator.

## **Caution**

- **Do not wash the remote controller.**

Doing so may cause electric leakage and result in electric shocks or fire.



- **Be sure to stop the operation of the air conditioner and turn off the power supply breaker when performing maintenance activities.**

Failure to do so may result in electric shocks or injury.



## **Maintenance of Unit and the LCD display**

### **Note:**

- Wipe the LCD display and the rest of the surface of the remote controller with a dry cloth when they become dirty.
- If the dirt on the surface cannot be removed, soak the cloth in neutral detergent diluted with water, squeeze the cloth tightly, and clean the surface. Wipe the surface with a dry cloth afterwards.
- Do not use any paint thinner, organic solvent or strong acid.

## **Warning**

**Do not use flammable materials (e.g., hairspray or insecticide) near the air conditioner.**

**Do not clean the product with organic solvents such as benzine or paint thinner.**

The use of organic solvents may cause crack damage to the product, electric shocks or fire.





# Reference Information

## Error Code Display

### Contact your Daikin dealer in the following cases

#### Warning

When the air conditioner is malfunctioning (e.g., giving off a burning odor), stop the air conditioner and turn off the power.

Continued operation under such circumstances may result in failure, electric shocks or fire. Contact your Daikin dealer.



### Operation Method

1

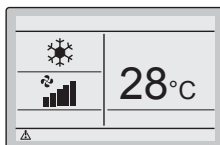

- If an error occurs, the error icon in the Basic Screen and the operation lamp will blink.
- If a warning occurs, only the error icon will blink and the operation lamp will not blink.
- To display the error code and contact information, the Menu/Enter button needs to be enabled (See ["Manipulating the Main Menu" on page 27](#) ).
- Press the Menu/Enter button.

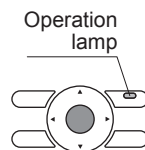

2

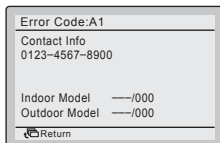

- The error code blinks and the contact address and model name will appear.
- Notify your Daikin dealer of the Error code and Model name.

## After-sale Service

### **Warning**

- **Do not disassemble, modify or repair the unit.**

Doing so may result in electric shocks or fire.  
Consult your Daikin dealer.



- **Do not relocate or reinstall the remote controller by yourself.**

Improper installation may result in electric shocks or fire.  
Consult your Daikin dealer.



### ■ Advise the repairer of the following items

- Model name
- Date of installation
- Failure conditions: As precise as possible.
- Your address, name and telephone number

### ■ Relocation

The relocation of the remote controller requires special equipment. Consult your Daikin dealer. Actual expenses required for the relocation of the remote controller will be charged.

### ■ Repairs after Warranty Period

Consult your Daikin dealer.  
Fair-paying services may be possible at the request of the customer.

### ■ Inquiry about After-sale Service

Contact your Daikin dealer.

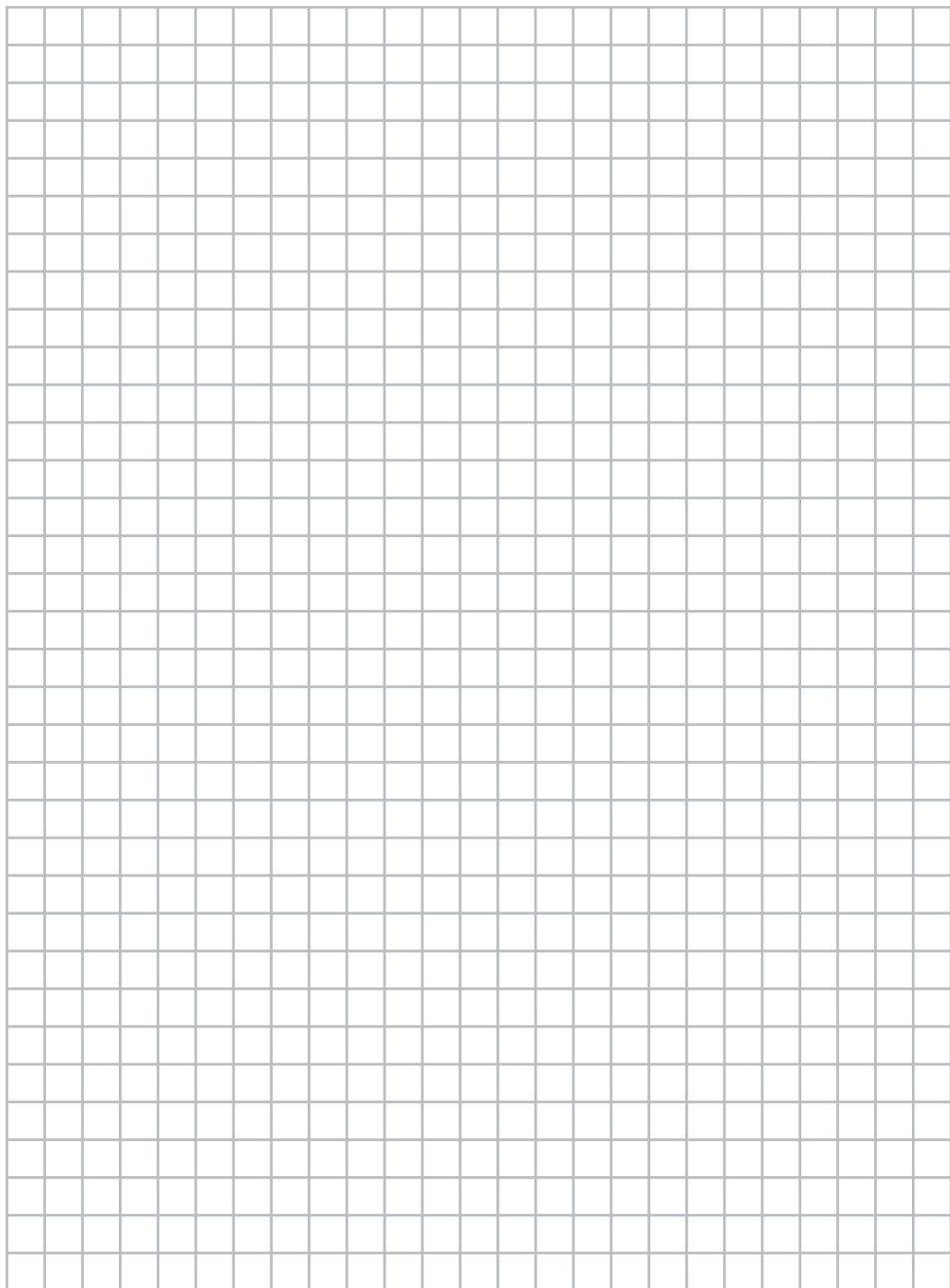

**DAIKIN EUROPE N.V.**

Zandvoordestraat 300, B-8400 Oostende, Belgium

4P368042-1 2014.02

Copyright 2014 Daikin