

INSTALLATION BOX FOR ADAPTER PCB

Installation manual

KRP1B938

Read these instructions carefully before performing work.
Perform work as explained herein.



4PW26422-1

CAUTION

- This kit can only be installed on the ceiling suspended type.
- This kit is required for each adapter PCB.

CONTENTS OF KIT

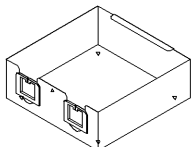
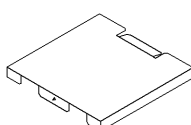
Prior to installation check whether you have the complete kit of parts as shown below including the installation manual.

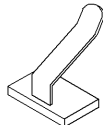
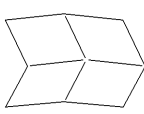
Name	Installation box	Box cover	Screws for fixing box	Hexagon screws for fixing box cover	Cable clamp	Installation manual
Shape			 M4×8	 M4×8		
Quantity	1 piece	1 piece	1 piece	1 piece	2 pieces	1 piece

APPLICABLE PCB

Name of PCB	Kit name
Wiring adapter for electrical appendices	KRP4AA52

1 INSTALLATION OF ADAPTER PCB

<Refer to the installation manual of adapter PCB as well.>

- Fix the adapter support (4 pieces) to the installation box.
The adapter supports are included in the adapter PCB kit.
- Fix the adapter PCB to the adapter supports.

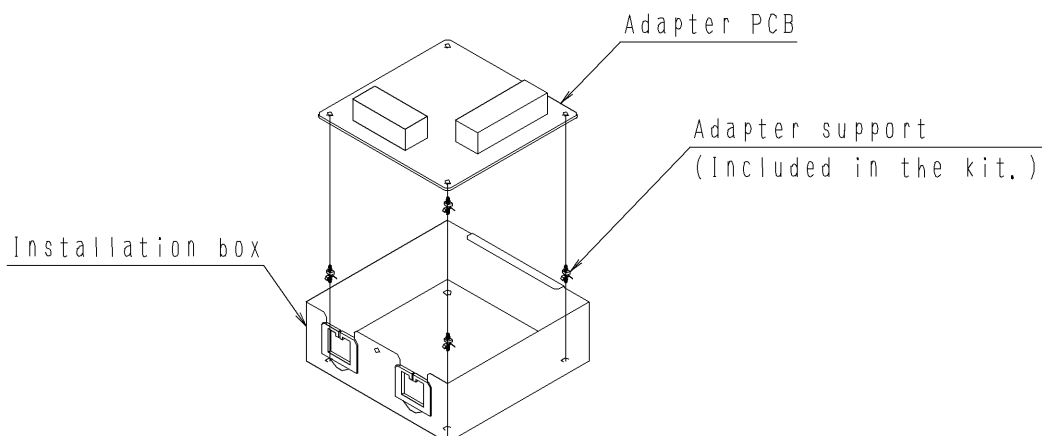

2 INSTALLATION TO THE INDOOR UNIT

- Fix the installation box to the indoor unit with screw included in the kit. (Be sure to fix installation box after setting the adapter PCB.)

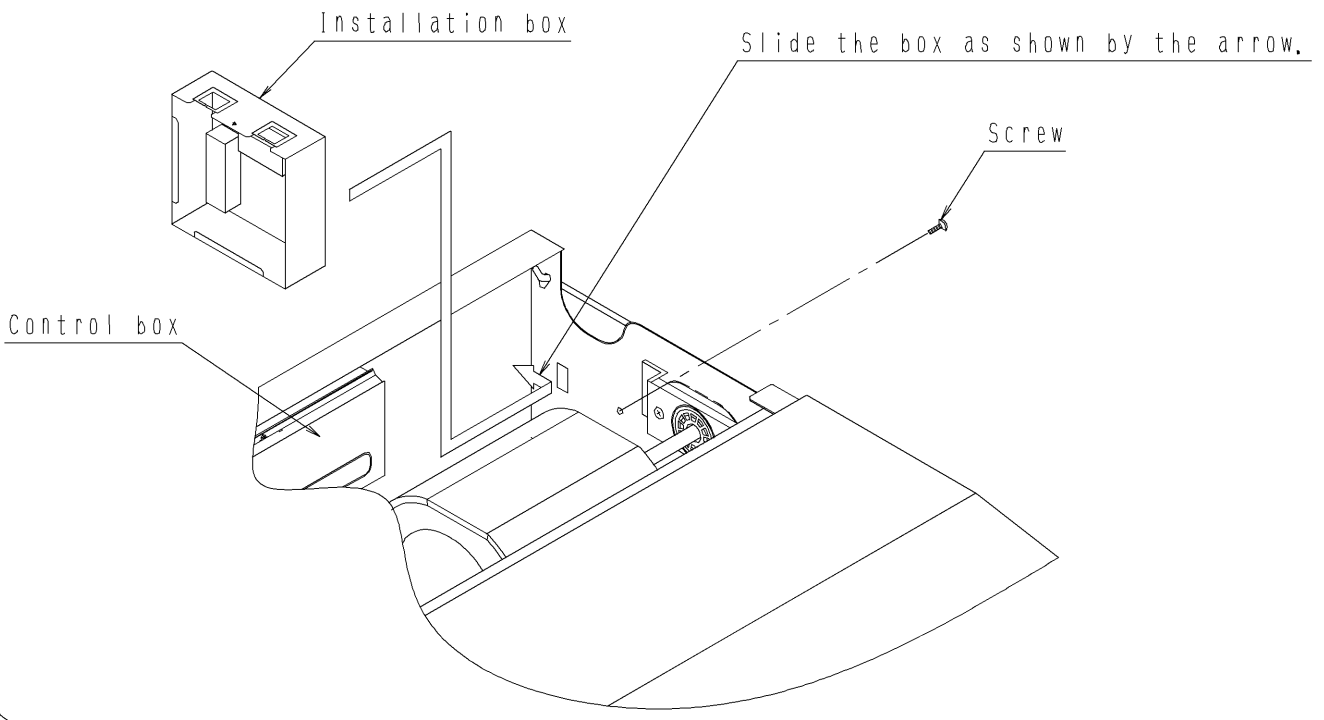

3 ELECTRICAL WIRING

- Refer to the installation manual of the adapter PCB for its electrical connection.
- After completing the electrical wiring, clamp the electrical cable with cable clamp included in the kit. Be sure the wiring is not bent.
- After checking the wiring connection, fix the box cover with the screws included in the kit.

